

## The SMARTCOCO design guide for hybrid concrete-steel structures

H. Somja<sup>a\*</sup>, M. Hjjaj<sup>a</sup>, Q.H. Nguyen<sup>a</sup>, A. Plumier<sup>b</sup> and H. Degee<sup>c</sup>

<sup>a</sup> National institute of applied sciences, Department of Civil Engineering, Rennes, France

<sup>b</sup> Department ARGENCO, University of Liege, Liège, Belgium

<sup>c</sup> Hasselt University, Hasselt, Belgium

\*corresponding author, e-mail address: [hugues.somja@insa-rennes.fr](mailto:hugues.somja@insa-rennes.fr)

---

### Abstract

Standard buildings in steel and in reinforced concrete are constructed by two different industrial sectors with little interaction. Even steel-concrete composite buildings remain designed as steel structures, with a limited benefit of the presence of concrete slabs. For some years however, a more integrated design between both materials is used, merely in high rise and heavy loaded structures. This new trend is not supported by actual standards that give little guidance for the specific arrangements that come from this new practice. The RFCS SMARTCOCO research project is intended to fill these gaps in knowledge and provide design guidance for some composite elements covered neither by Eurocode 2 nor by Eurocode 4 : composite columns or walls reinforced by several fully encased steel sections, reinforced concrete columns reinforced by one steel section over the height of one storey and concrete flat slabs or beams connected to columns or walls by means of steel shear keys. Gaps in knowledge are mostly related to force transmission between concrete and embedded steel profiles. A generic design approach has been developed and then used to design test specimens. The results have been used to calibrate the design proposals. The output is a design guide which complements Eurocode 2 and 4.

**Keywords:** *Hybrid concrete-steel structures; walls; connections; shear keys.*

---

### 1. Introduction

Steel concrete composite buildings can be designed with Eurocode 4 [1] only if there is a continuous steel framing, and if there is a single steel element mixed with concrete in each member considered in the structural analysis. As a consequence, concrete structures strengthened locally by steel profiles, or involving members reinforced by several embedded steel profiles are out of the scope of this standard. As they are also not in the scope of Eurocode 2, there is no guidance for their design, at least in European standard's corpus, even if they are already used in practice, as in the Hong Kong international finance center, see Fig. 1.

The objective of the RFCS SMARTCOCO project was to provide a design guide covering such concrete-steel elements qualified as hybrids. A generic design approach has been developed based on the state of the art, and then used to design test specimens. Results have then

been used to calibrate or correct the design proposals. The final output is a design guide which complements Eurocode 2 and 4.



Fig. 1. Hong Kong International Finance Centre – hybrid columns.

The paper summarizes the different investigations that have been done, and the design rules that have been proposed subsequently.

## 2. Longitudinal shear force transmission

Gaps in knowledge are mostly related to the force transmission from concrete to embedded steel profiles. The first experimental series was intended to study the longitudinal shear force transmission from concrete to H steel profiles embedded in a wall by means of 10 different push-out tests. Different configurations have been considered: orientation of the profile, state of surface (rusted or painted), with or without connectors (studs, transverse plates welded on the webs and the flanges, mix of connectors), see Fig. 2.

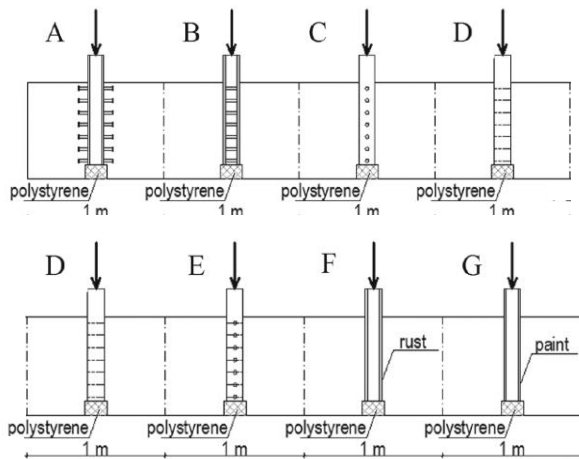

Fig. 2. Push-out test specimens.

The design bond resistance  $\tau_{Rd}$  deduced from the tests was 2 times greater than the proposed Eurocode 4 values for rusted specimens. Even for painted specimens, a bond resistance of 0.3 N/mm<sup>2</sup> was found while Eurocode does not allow to consider it.

For stud connectors, the design formulae proposed in Eurocode 4 were found accurate. For transverse stiffeners, the design method proposed allows to verify both the local resistance of concrete in compression, and the steel plate resistance, based on a yield line model. In this case, a complementary transverse reinforcement by hoops is required for H profiles oriented with the web parallel with the wall face, and for profiles situated in the edge regions of the wall. Finally, tests have shown that it is possible to add the contribution of bond and connectors.

## 3. Walls with several embedded steel profiles

13 tests on wall specimens with several embedded steel profiles were realized in two different labs, at University of Liège and INSA Rennes. Several different points were investigated:

- Validate the models for longitudinal shear force transmission deduced from push out tests when considered in bended members;
- Define a design model for the resistance to transversal shear given the possible contribution of both the concrete members and the embedded steel profiles;
- Verify if usual models for resistance in bending and compression are still applicable;
- Determine the ductility associated with the different possibilities for the connection.

The concrete section 900x250 mm was the same for all the specimens. In all cases also, 3 HEB 100 steel profiles were embedded in the concrete, again with different orientation, surface states, and connections, see Fig. 3.

At INSA Rennes, 7 specimens were tested in three point flexure configuration with a span of 3.75 m, see Fig. 4. At ULg, 6 cantilever specimens were tested, out of which 4 in bending, and 2 in bending and compression, see Fig. 5.

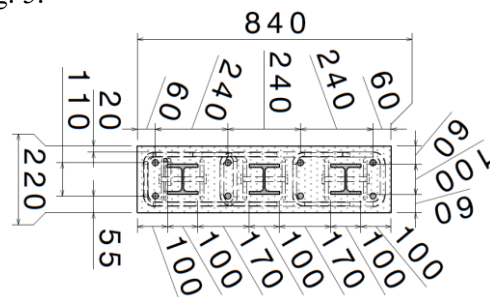

Fig. 3. Typical section of tested members.

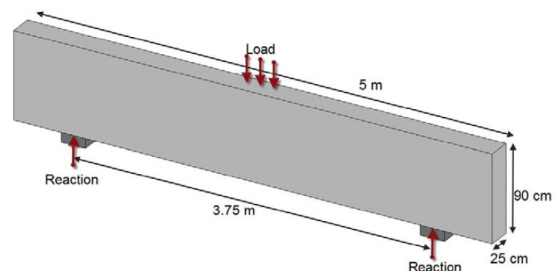

Fig. 4. Test setup at INSA Rennes.

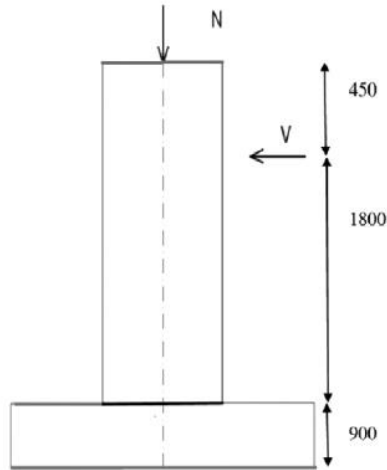

Fig. 5. Test setup at University of Liège.

The comparison of numerical calculations and experimental results at the two sites provided a set of conclusions [3].

First of all the resistance to shear is given by the summation of the contributions of concrete and steel profiles, following a design process presented in detail in the design guide.

A similar load bearing capacity was reached for all specimens equipped with connectors. Ductility varies following the detailing. In all specimens with the web perpendicular to the wall faces, the ductility is high, around 5. It is less when profiles are rotated by 90°, as struts starting from connectors develop more difficultly, especially in the case of transverse stiffeners. Specimens without connectors reached a maximum strength around 10 % lower than those with connectors and the failure mode was not ductile. The resistance in combined bending and compression could be properly estimated by standard methods used for RC walls.

#### 4. Stability of slender hybrid walls and columns with several embedded steel profiles

A last step was necessary in order to provide a general guidance for RC members with embedded steel profiles: to handle the stability analysis.

At first a specific plane finite element was developed, in order to perform a large parametrical study on concrete-steel hybrid walls and columns. Geometrical imperfections and residual stresses were taken into account [4].

The ultimate load of 2960 different columns was determined, with different section shapes, numbers and orientations of the steel profiles, heights of the columns, M/N ratios, and creep strains. They were compared to the results obtained from the moment magnification methods proposed in Eurocode 2 and Eurocode 4. None of them gave satisfactory results, as they are not calibrated for the intermediate steel ratio specific to hybrid columns. The mean prediction of both codes was correct, but the scatter was very large, with a standard deviation above 10 %. As a consequence, an adaptation of the effective stiffness method of the Eurocode 2 has been proposed, considering the possible yielding of the steel before reaching the ultimate load in the computation of the amplification factor. This reduces the contribution of the steel to the stiffness when computing the nonlinear amplification of the bending moment. The new design method reduces the standard deviation of the prediction of the ultimate load to 5 %.

The simplified method has been implemented in a specific software, HBCOL, which also allows to realize a full nonlinear numerical simulation, see Fig. 6. This software is available for free on the site: <https://hybridcolumnstruc.weebly.com/>

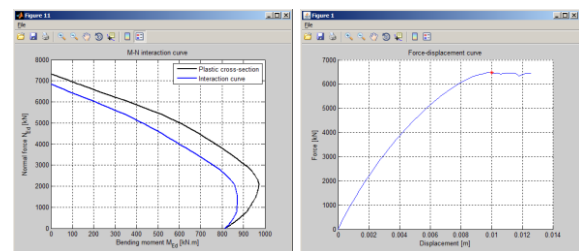
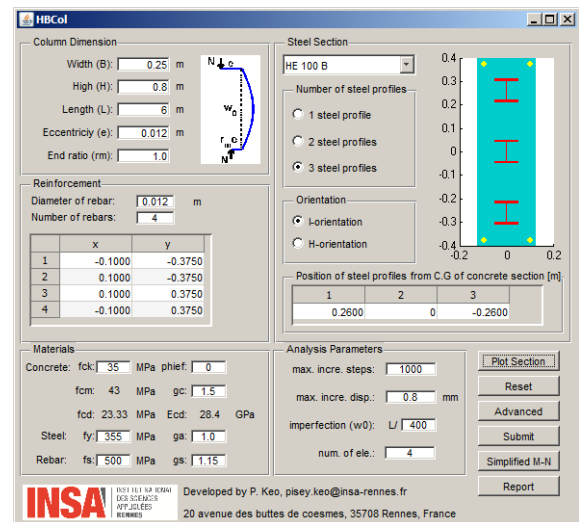

Fig. 6. HBCOL: data interface and results.

## 5. Reinforced concrete buildings in which steel or composite steel-concrete components are used to achieve locally higher performance

In reinforced concrete buildings, when large spans have to be reached, recourse is usually made to pre or post stressing. But these techniques lead to some difficulties, for the cladding to the rest of the structure in the first case, for the detailing of the introduction of the tension in the second case. Moreover they induce larger costs. As a consequence, a local strengthening by steel or composite members may be an efficient alternative that can even be used for overloaded columns. But there is a lack of design rules for the detailing of the transition zones between the concrete members and the steel members.

The SMARTCOCO project has investigated different solutions:

- The connection of a steel beam to a RC column by embedment of a vertical shear key in the column, see Fig. 7. Four specimens have been tested. A HEM 450 has been connected to a 400 x 600 reinforced concrete column by a short embedded HEM 200. The concrete class and the length of the HEM 200 have been changed in the different tests : C40 and C60, and 1m and 1.5 m respectively ;
- The reinforcement of a RC column by a steel profile, and its connection to a RC frame, see Fig. 8. Four tests have been made. A 350x360 RC column has been reinforced on a part of its length by a HEB140 profile. The general configuration (column isolated or in a frame), the anchorage length, the density of transverses reinforcements, and the compression force in the column, have been varied.

Numerical models have been verified by comparison to the experimental results (Fig. 9) in order to perform a sensitivity study on the distribution of the stresses when the design parameters are changed.

These results have been used to calibrate the design method that is proposed in the design guide.

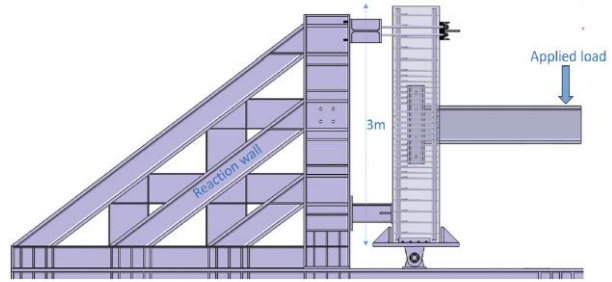

Fig. 7. Connection of a steel beam to a RC column : test setup

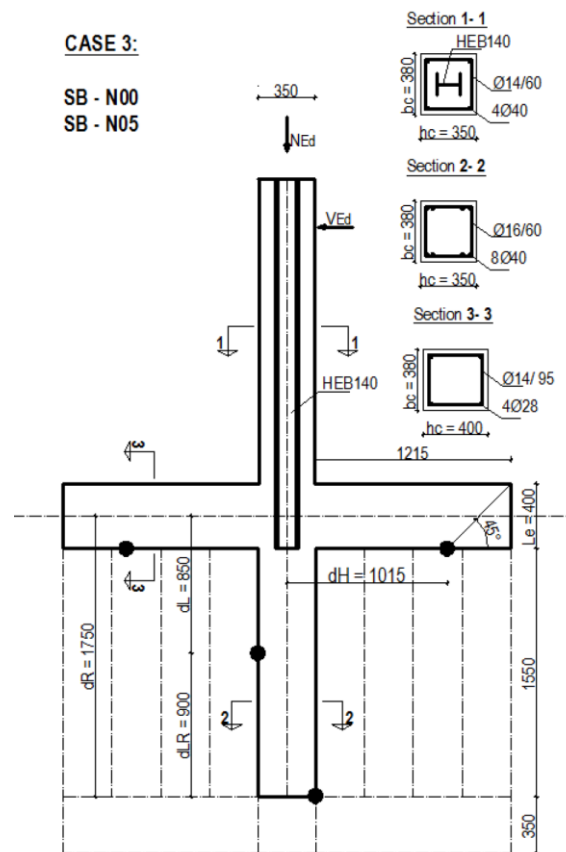

Fig. 8. Connection of a composite column to a RC Frame : test set up

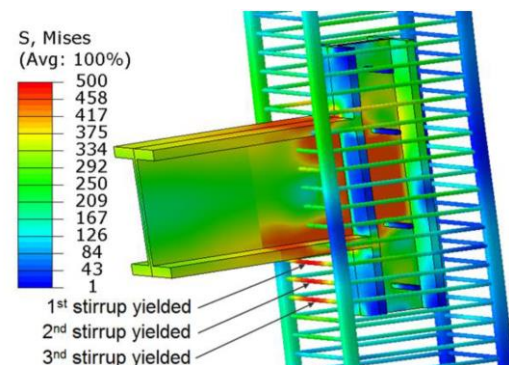

Fig. 9. Numerical model of the steel beam – concrete column connection

## 6. Connection of concrete slabs and concrete beams to steel columns by shear keys

There is little scientific support and no specific design recommendation for the use of H steel sections as shear key connections of reinforced concrete beams or slabs to steel columns. Rules on punching shear of RC slab exist, but indications on the critical perimeter with 2 or 4 shear keys in a flat slab and on the needed transverse reinforcement required are scarce. The test program comprises 12 tests on joints of RC beam to steel column (see Fig. 10) and 6 tests on joints of RC flat slabs to steel columns (see Fig. 11). A design method was developed in parallel.

The parameters in tests on beams are the embedded length of the shear key, the presence of transverse reinforcement, the flexural reinforcement ratio and the stiffness ratio between the member and the shear key [5]. The joint region is made of steel columns crossing one way reinforced concrete beams supported by HEB200 shear keys and consists in a steel column stub and two hybrid RC-composite cantilevers of 1.85 m span each. RC beam sections are 360 x 450 mm. The predicted results show good agreement with those obtained from tests.

Short embedment lengths of the shear-key seem more effective as a ratio of shear key depth to length equal to 1 appears sufficient to ensure a smooth transfer of forces between RC beam and steel column and a stiff response of the shear-key.

The parameters in tests on flat slabs are the top and bottom reinforcement ratio, the presence of shear reinforcement in the slab and of continuity plates [6]. The tests confirmed the validity of the equations developed for design.

A conclusion is that the increase in longitudinal reinforcement can lead to a five times enhancement in stiffness and strength while increases in shear head sizes has a very low influence. The use of a high conventional reinforcement ratio with small shear head sizes is more effective than low reinforcement ratios combined with larger shear-heads. Shear heads with depth less than half the slab depth could develop plastic deformations, which should be avoided. An increase in shear head embedment length produces stiffness enhancement of the

slab due to the increase in radial moment capacity, but an insignificant increase in flexural strength. For fully integrated shear heads, the reinforcement typically yields first and governs the behavior. Deformation response and flexural strength indicate that short-to-intermediate shear heads are more effective than long shear heads.

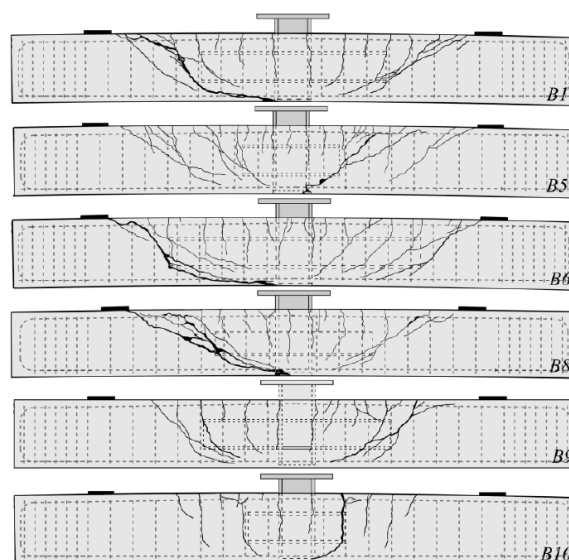

Fig. 10. Shear keys: beam tests

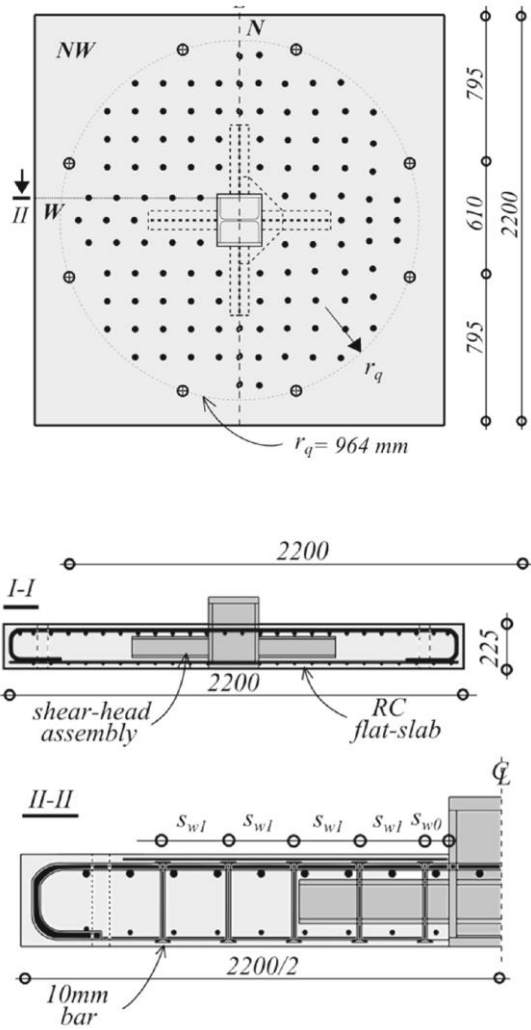

Fig. 11. Shear keys : flat slab tests

## 7. Support of steel beams by RC beams

The last concrete-steel transition zone studied within SMARTCOCO consisted in a secondary steel beam crossing transversally a primary concrete beam, see Fig. 12. This case is handled in Eurocode 2 under the name “indirect support” when the two beams are made of concrete.

The transmission of the forces from the steel to the concrete is made by the contact of the flanges on the concrete and of the supplementary plates welded transversally on the web. The behavior of the concrete can then be modelled by a strut and tie model, with diagonal struts linking the steel flanges and stiffeners to the feet of the stirrups, see Fig.13. The objective of the test was to clarify whether all these struts and stirrups could develop their maximal resistance simultaneously. Four different tests have been made, with or without web plates, and with a

different compression force in the concrete beam.

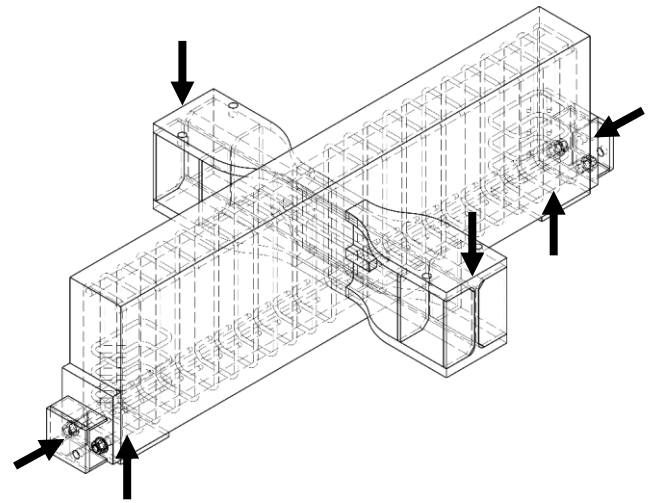

Fig. 12. Indirect support : test setup

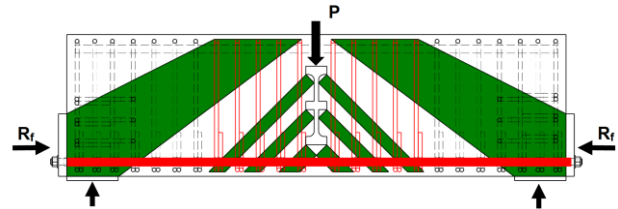

Fig. 13. Expected strut and tie model

Tests have shown an uneven distribution of the forces in the stirrups at collapse. Only the stirrups near the profile were yielded. A new strut and tie model based on the elastic stress trajectories, with different angles of inclination of the struts, has demonstrated a good correlation with the experimental results, see Fig.14 and 15. This points out the importance of the height of the application of the force in the beam on the angle of diffusion in concrete.

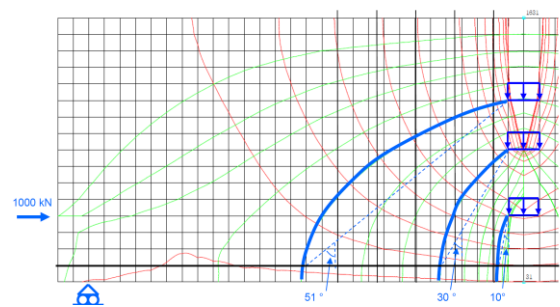

Fig. 14. Elastic stress trajectories

As a consequence, a generic strut and tie model has been proposed in the design guide, with a limited angle of diffusion and a reduction in the yielding resistance of the stirrups. If inverted, this case can give indications for shear keys with multiple horizontal surfaces.

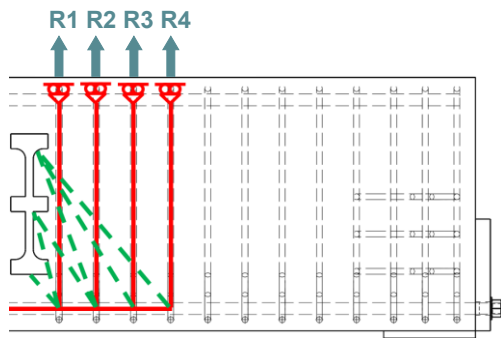

Fig. 15. New strut and tie model

## 8. Conclusion and acknowledgements

Based on the research work summarized here, design rules have been organized into a “Design Guide”. Guidance is given for the global analysis of hybrid structures and different design tools are provided for the design of:

- slender hybrid columns ;
- walls with several embedded profiles ;
- moment connection of steel or composite beams to concrete columns ;
- shear keys supporting beams or slabs and connecting them to steel or composite columns

## Acknowledgements

This paper was developed in the frame of the SMARTCOCO project funded by RFCS, the Research Fund for Coal and Steel of the

European Commission, Research grant agreement RFSR-CT-2012-00031 Smartcoco. The companies BESIX and ArcelorMittal are also acknowledged for their involvement in the project.

## References

- [1] CEN2004. Eurocode 4: EN 1994-1-1 Design of composite steel and concrete structures, Part 1.1– General Rules for buildings. European Committee for Standardizations; Brussels 2004.
- [2] CEN2004. Eurocode 2: EN 1992-1-1 Design of concrete structures, Part 1.1 – General Rules for buildings. European Committee for Standardizations, Brussels; 2004
- [3] Plumier A, Dragan D, Nguyen QH, Degée H. An Analytical Design Method for Steel-Concrete Hybrid Walls. Structures 2017; 9:185–199
- [4] Keo P, Somja H, Nguyen QH and Hjiat M. Simplified design method for slender hybrid columns. Journal of Constructional Steel Research 2015; 110:101-120
- [5] Bompa DV, Elghazouli AY. Ultimate shear behaviour of hybrid reinforced concrete beam-to-steel column assemblages. Engineering Structures 2015; 101:318–336
- [6] Bompa DV, Onet T. Punching shear strength of RC flat slabs at interior connections to columns. Magazine of Concrete Research 2016; 68:24–42