

Applying ANFIS Model in Decision-making of Vertical Handover between Macrocell and Femtocell Integrated Network

Wafa Benaatou¹, Adnane Latif¹, Vicent Pla²

¹ENSA, Cadi Ayyad University, Marrakesh, Morocco

²ITTACA, Universitat Politècnica de Valencia Camino de Vera s/n, 46022, Valencia, Spain.

wafa.benaatou@ced.uca.ma

Abstract— One of the most challenging tasks in communication networks is to maintain seamless mobility and service continuity during a vertical handover. This paper provides the case of handover decision making between femtocell and macrocell integrated network considering several input parameters, namely SINR, bandwidth and energy consumption. We have simulated and proposed a vertical handover based on adaptive neuro-fuzzy inference system (ANFIS) to achieve a goal of having an intelligent handover and to predict the best destination network. The simulation results show that the approach based on ANFIS leads to a reduction of unnecessary handovers and a minimization of the energy consumption as compared to the existing approaches.

Index Terms— Macrocell; Femtocell; ANFIS; Vertical Handover; Handover Decision.

I. INTRODUCTION

The most important challenge is maintaining a seamless connectivity and service continuity during a movement of MS. The four different handover types in HetNets are illustrated in the Figure 1 [5, 8]:

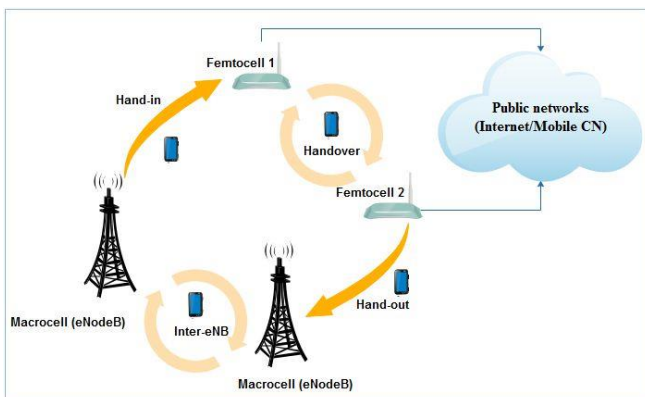

Figure 1: Handover types in HetNets

- Inter-eNB: it represents the handover between two Macrocells.
- Hand-in: it refers to the handover procedure from a Macrocell to Femtocell.
- Hand-out: it represents the handover procedure from Femtocell to Macrocell.
- Handover: it depicts the handover between two Femtocells.

In this paper, we focus on the process with the Hand-in

handover type.

Our major contribution is the proposal of a new vertical handover decision based on hybrid neuro-fuzzy system for optimal network selection between macrocell and femtocell integrated network that is mainly designed to reduce the number of handover and the energy consumption in the network and maintain the required connectivity.

The advantages of our approach can be concluded as the followings [13]:

- Multiple parameters are used to analyze the networks and make the handover decision, which ensures more accuracy and reliability based on a variety of the acquired input information.
- As an intelligent model, the ANFIS has the ability to respond to changes that might happen on the networks and modify the parameters accordingly to maintain the required connectivity and QoS.
- In the ANFIS model, we combine two technologies fuzzy logic and neural network to have a better result.

The rest of this paper is organized as follows. In Section II, we presented the related work. In Section III, we briefly describe the methodology of our proposed system. The proposed approach based on adaptive neuro-fuzzy inference system is presented in Section IV. We carried out a comparative study and the results are shown in Section V. We conclude this paper and discuss future work in Section VI.

II. RELATED WORK

Many approaches have been proposed by researchers in the context of future wireless communication networks and seamless connectivity: Tajul Islam et al. proposed two vertical handover scheme based on fuzzy interference system and subtracting clustering method in a heterogeneous networks. Thanachai et al. applied fuzzy logic to enhance the intelligence of the handover decision. Kwong et al. have proposed a newer approach using Adaptive Neuro Fuzzy Inference System (ANFIS). Semenova and Semenov have developed architecture of the neuro-fuzzy controller using a neuro-fuzzy controller in mobile networks for improving the handover process. Takaaki Inaba et al. proposed a fuzzy logic approach for handover in wireless cellular networks by taking into account the security parameter. Zineb et al.

proposed an approach based on Fuzzy TOPSIS, which is a combination of fuzzy logic and TOPSIS method to reduce the number of executed handoffs and the decision delays. Bchini et al. have studied fuzzy logic based scheme for fast selection of best base station and of handover technique at the handover time in order to minimize the delay during handover for sensitive multimedia traffic.

From the existing work, we can conclude that the most important issue in this field of study is to ensure the Quality of Service (QoS) when the mobile station moves away from one base station to another. Thus, a big problem in relation to this issue is a large number of handovers, deficiency of maintaining a seamless connectivity and service continuity and high-energy consumption in the network. For this reason, we proposed a vertical handover decision scheme based on adaptive neuro-fuzzy inference system to provide seamless mobility and choose the best candidate network that minimizes the handover failure and the energy consumption in the network.

III. PROPOSED SYSTEM

In this paper, we proposed a handover decision algorithm between macrocell to femtocell network based ANFIS. Our network simulation model is presented in the Figure 2, where the MS moves away from the eNB of macrocell towards the eNB of femtocell network.

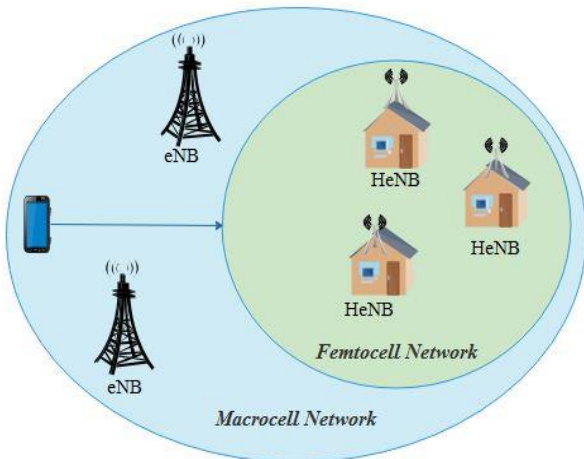

Figure 2: Handover scenario for macrocell/femtocell integrated network

The handover decision making is based on the signal to interference noise ratio from serving eNB to target eNB [1].

The SINR is determined by using formula [1], given below [2, 3]:

$$SINR_u = \frac{P_S G_{u,S}}{\sum_N P_N G_{u,N} + \sum_F P_F G_{u,F} + N_0 \Delta_f} \quad (1)$$

where P_S and P_N are respectively the transmit powers of servant macrocell (S) and neighboring macrocell (N).

$G_{u,S}$, $G_{u,N}$ and $G_{u,F}$ respectively correspond to the channel gains between macro cell user (u) and servant macrocell (S), neighboring macro cell (N), and neighboring femtocell (F).

$P_{f,k}$ is the transmit power of neighboring femtocell (F).

N_0 corresponds to the white noise power spectral density.

Δ_f is subcarrier spacing.

Our handover algorithm is based on the Eq. (1), determined as follow:

Handover Algorithm.

BEGIN

Input: SINR value of serving cell

Input: B Bandwidth of serving cell

Input: E Energy Consumption in the network

Step 1: MS connected to serving eNB

Step 2: MS measures SINR of serving eNB

Step 3: If SINR is low go to **step 3.1**

Else go to step 4

Step 3.1: If bandwidth is low go to **step 3.2**

Else go to step 4

Step 3.2: If energy consumption is high then measure SINR of target base stations go to **step 3.3**

Else go to step 4

Step 3.3: If (SINR Serving-eNB < SINR Target-eNB) then perform handover

Else go to step 4

Step 4: No need of handover

Step 5: MS connects to Target eNB

END

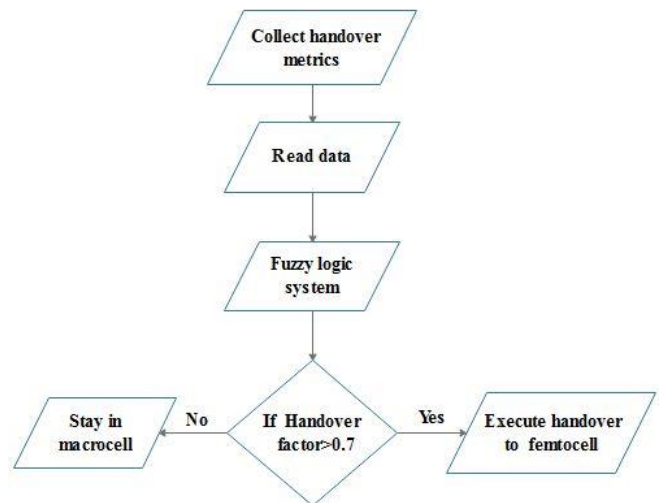

Figure 3: System model for handover decision

Figure 3 shows the system model for the handover decision.

In our proposed approach, we have considered two networks: one of which is the femtocell and the other is the macrocell. All inputs (SINR, bandwidth and energy consumption) are combined for processing the mechanism of handover factor as well the MS measures SINR of the macro base station. If the handover factor is greater than 0.7, then MS initiates a handover from a macrocell to femtocell network; otherwise MS stays in the current macrocell network.

Table 1
Parameter of Simulation

Metrics	Low	High	Unit
SINR	-25	10	dB
Bandwidth	0	100	MHz
Energy Consumption	0	5	Watt

The setup of decision Parameters are:

- SINR: It is directly related to the satisfaction of the user and easy to measure.
- Bandwidth: It is the major deciding factor when terminal selects handover network.
- Energy consumption: As wireless devices operate on limited battery power, energy consumption may be a significant factor for handover. For example, when the battery level decreases, handing off to a network with lower power requirements would be a better decision.

IV. APPLYING ADAPTIVE NEURO-FUZZY INFERENCE SYSTEM IN DECISION-MAKING

In this section, the adaptive neuro-fuzzy inference system and the results of decision between femtocell and macrocell networks are presented.

A. Architecture of the ANFIS Model

Hybrid neuro-fuzzy system is a combination between two technologies neural network and fuzzy system, known also as ANFIS (Adaptive Neuro-Fuzzy Inference System), ANFIS supports the Takagi–Sugeno based systems [7]. The structure of the adaptive network is composed of five network layers i.e. layer 1 to layer 5, namely the fuzzy layer, product layer, normalized layer, de-fuzzy layer, and total output layer respectively (with nodes and connections), as shown in Figure 4 [14].

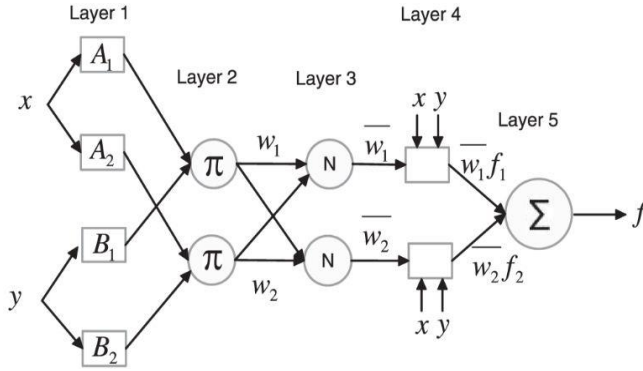

Figure 4: Training structure of ANFIS

In the adaptive neural-fuzzy system, we have two inputs x and y , one output f and fuzzy set A_1, A_2, B_1, B_2 ; and for a first order Takagi–Sugeno fuzzy model, we have two IF-THEN rules, as explained in the following Equation [14]. (2) and (3).

$$\text{Rule1: IF } x \text{ is } A_1 \text{ and } y \text{ is } B_1 \text{ then } f_1 = p_1x + q_1y + t_1 \quad (1)$$

$$\text{Rule2: IF } x \text{ is } A_2 \text{ and } y \text{ is } B_2 \text{ then } f_2 = p_2x + q_2y + t_2 \quad (2)$$

where A_i and B_i are the fuzzy sets, f_i is the outputs within the fuzzy region specified by the fuzzy rule, and p_i, q_i , and t_i are the design parameters that are determined during the training process and each layer in the neuro-fuzzy system is associated with a particular step in the fuzzy inference process [14, 19].

Layer 1: In this layer, each neuron transmits external crisp signals directly to the next layer.

$O_{1,i(x)}$ determines the membership level of the given input. The output of each node is calculated using [19]:

$$\theta_{1,i} = \mu_{A_i}(x) \quad \text{for } i = 1,2 \quad (4)$$

$$\theta_{1,i} = \mu_{B_i} - 2(y) \quad \text{for } i = 3,4 \quad (5)$$

Layer 2: After receiving a crisp input, the fuzzification neuron determines the degree to which this input belongs to the neuron fuzzy set and the neurons in this layer represent fuzzy sets used in the antecedents of fuzzy rules.

$$\theta_{2,i} = \omega_i = \mu_{A_i}(x) \times \mu_{B_i} - 2(y) \quad \text{for } i = 1,2 \quad (6)$$

The output signal w_i of each node means the firing strengths of a rule.

Layer 3: In this layer, the normalized weights are calculated by each node. The output signal can be thought of as the normalized firing strength of a given rule as in the Eq. (7).

$$\theta_{3,i} = \bar{\omega} = \frac{\omega_i}{\omega_1 + \omega_2}, \quad \text{for } i = 1,2 \quad (7)$$

Layer 4: In this layer, we have calculated the individual output values y from the inferring of rules from the rule base. Individual nodes of this layer are connected to the respective normalization node in layer 3 and also receive the input signal [4, 9]. Each node of this layer is adaptive with the node function given by the Eq.(8) where p_i, q_i , and t_i is a set of consequent parameters of rule i .

$$\theta_{4,i} = \bar{\omega}if_i = \bar{\omega}i(p_i + q_i + t_i), \text{ for } i = 1,2 \quad (8)$$

Layer 5: In this layer, we have calculated the sum of all the outputs coming from the nodes of the defuzzification layer to produce the overall ANFIS output. It has only one node and this layer is known as the output layer. Eq.(9) [20].

$$\theta_{5,i} = \sum_{i=1}^4 \bar{\omega}if = \frac{\sum_{i=1}^4 \omega if}{\sum_{i=1}^4 \omega i} \quad (9)$$

We have used this architecture of the adaptive network to develop the ANFIS model for the prediction of handover between heterogeneous networks.

B. ANFIS Procedure

The ANFIS procedure used in the paper is shown in Figure 5 [10]. In the first step, we have initialized the fuzzy system by using the `genfis1` or `genfis2` command. After the initialization of the parameters with the training data matrix, the system associates the membership function for each input. In the second step, we have given the parameters for learning mainly the number of iterations and tolerance. In the third step, we have started the learning process by using the `anfis` command for learning. When the tolerance is achieved, we have validated the independent data by the system in the last step [22].

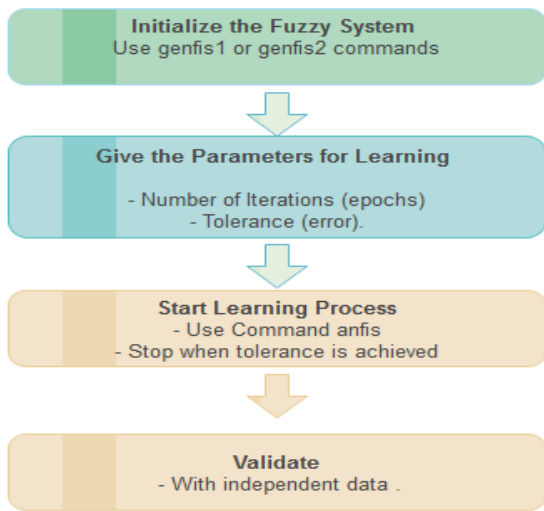

Figure 5: ANFIS Procedure

C. Results with ANFIS model

In order to analyze the performance of the ANFIS model, we have used the MATLAB’s Fuzzy Logic Toolbox and the GUI editor [16]. Our proposed ANFIS structure model is shown in Figure 6.

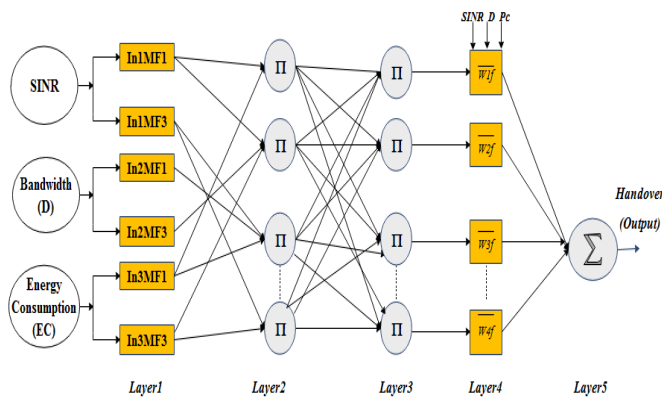

Figure 6: ANFIS Structure Model

The specifications of the ANFIS model are illustrated in Table 2:

Table 2
The used ANFIS information

Characteristics	Value
Nodes	78
Linear parameters	27
Nonlinear parameters	18
Total parameters	45
Training data pairs	11
Checking data pairs	11
Fuzzy rules	27

The ANFIS model structure consists of three layers: input, hidden and output. Figure 7 shows the ANFIS

approach for a three inputs and single output.

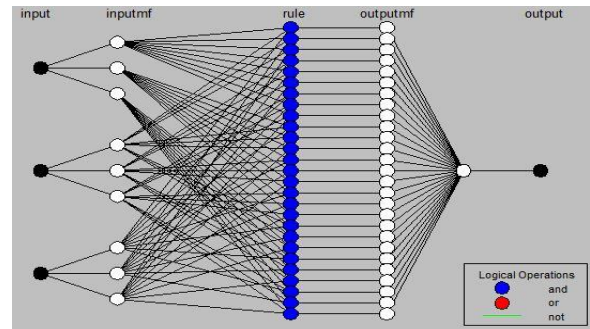

Figure 7: ANFIS for a three input single output

To optimize the parameters and the membership functions, the hybrid method has been used, which is a combination of Backpropagation and the least square method. For generating the initial fuzzy inference system (FIS) structure, the grid partition method has been used. The number of error tolerances and training epochs were set to 0 and 10 respectively.

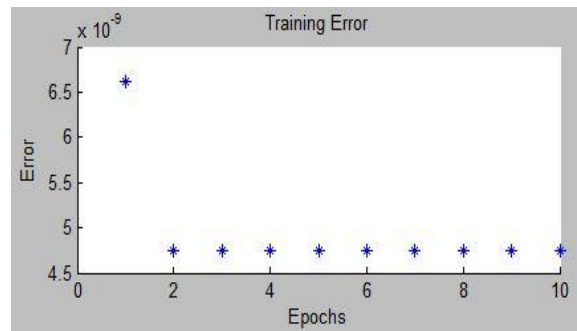

Figure 8: Error plot with Gaussian Membership Function

After the FIS is trained, we validated the model using a testing and checking data. Figure 9 and Figure 10 show the results of applying the ANFIS methodology with the training data and with the checking data.



Figure 9: FIS output after testing with Training Data

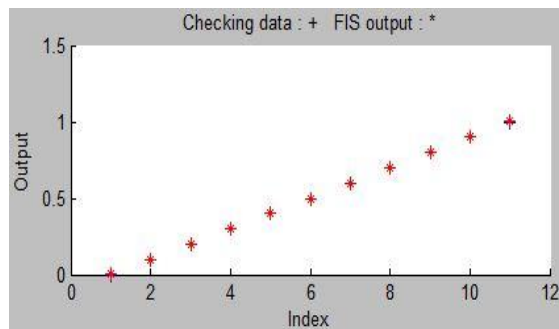

Figure 10: FIS output after checking with Checking Data

We collected input/output data for training then we used ANFIS to emulate the training data. The data were presented by modifying the membership function parameters according to a chosen error criterion. Figure 11, 12 and 13 show the surface plot of handover decision generated by the ANFIS method.

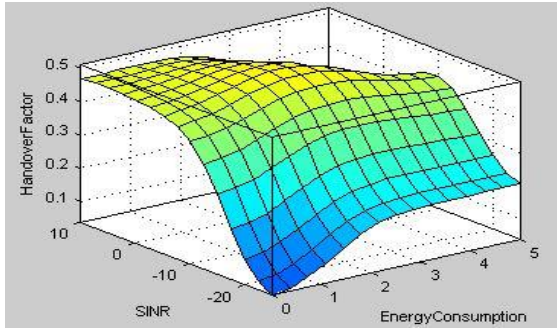

Figure 11: Surface plot of Handover with SINR and energy consumption

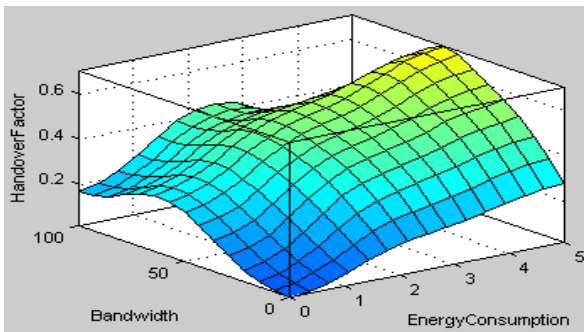

Figure 12: Surface plot of Handover with bandwidth and energy consumption

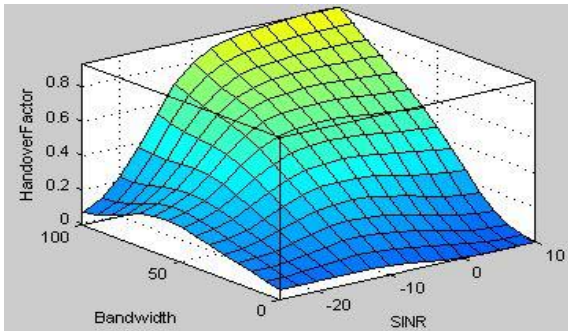

Figure 13: Surface plot of Handover with bandwidth and SINR

It was observed that the prediction of handover with the ANFIS model agrees well with the target data. In Figure 11, when we have a good SINR and high bandwidth, a system choose to not performing a handover: It is similar in Figure 12, when we have a low energy consumption and low bandwidth. On the other side, a system performs a handover when we have a low SINR and low bandwidth, as can be seen in Figure 12.

V. COMPARATIVE STUDIES

Based on our simulation mentioned in the previous section and the comparison analysis as presented in Figure 13 and Figure 14, we can see that the vertical handover based on adaptive neuro-fuzzy inference system (ANFIS) reduces the number of handovers and the energy consumption in the network, in comparison to the fuzzy logic [3], RSS [3], SNR [23] and traditional approach [1, 18]. Indeed, this paper is a

continuation of our previous work in [3] which considered the vertical handover based on RSS and on fuzzy logic.

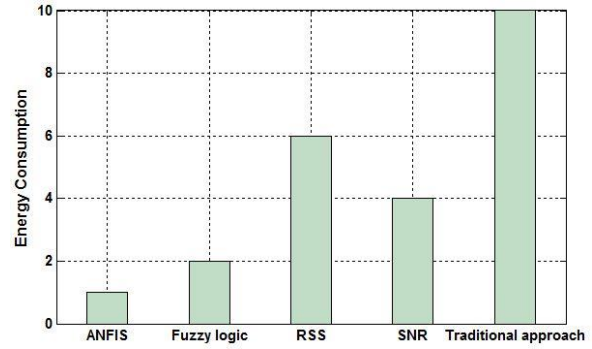

Figure 13: Comparison of energy consumption for different algorithms

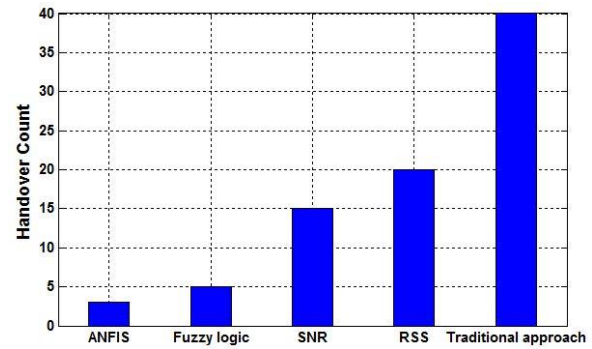

Figure 14: Comparison of handover counts for different algorithms

Our proposed technique based on ANFIS is more superior to those four strategies: In the traditional approach and RSS algorithm, the big problem is the unnecessary number of handover generated by the loss of propagation (Path Loss) and the fading of the signal caused by obstacles (shadow fading) as well as multipath (Multipath). In the SNR algorithm, the largest disadvantage is in the maximization of peak data rate. However, this issue is not optimal since the SNR does not allow to have the true values of the received data rate [21]. In fuzzy logic, the optimization of the membership functions does not exist. For this reason, we have used ANFIS for enhancing the accurate evaluation of the best handover decision by optimizing the membership function of the inputs used and minimizing the unnecessary handover and the energy consumption in the network.

Therefore, our algorithm is very efficient and achieves good results and better performance than the other vertical handover algorithms.

VI. CONCLUSION

The decision of the vertical handover is one of the most challenging issues in heterogeneous wireless networks.

This paper proposes a handover algorithm which utilizes an adaptive neuro-fuzzy inference system (ANFIS) between macrocell and femtocell network in order to select the best access network. Performance evaluation results show that the proposed approach based on ANFIS reduces the number of handovers and the energy consumption in the network. We also compare our results with the other algorithms, which depend only on received signal strength, SNR, to

measure how much the hybrid fuzzy approach could improve the performance. The results show that the model-based on ANFIS is the best in comparison to the other approaches. Otherwise, when we combine two technologies (fuzzy logic and neural network), we have better results than using fuzzy logic alone. In our future works, we are going to implement an optimal method for handover decision making process.

REFERENCES

- [1] Kustiawan, I. and Chi, K.H. (2015) 'Handoff decision using a kalman filter and fuzzy logic in heterogeneous wireless networks'. IEEE Commun. Lett. 19(12), 2258-2261.
- [2] Hou, J. and O'Brien, D.C. (2006) 'Vertical handover decision making algorithm using fuzzy logic for the integrated Radio-and-OW system', IEEE Trans. Wireless Commun. 5 (1) 176-185.
- [3] Benaatou, W., Latif, A. and Pla, V. (2017) 'Vertical handover decision algorithm in heterogeneous wireless networks', Int. J. Internet Protocol Technology, Vol. 10, No. 4, pp.197-213.
- [4] Chinnappan, A. and Balasubramanian, R. (2016) 'Complexity consistency trade-off in multi-attribute decision making for vertical handover in heterogeneous wireless networks', IET Journals & Magazines, Vol.5, No.1,
- [5] T.Bchini, N. Tabbane, S. Tabbane, E. Chaput and Andr-Luc Beylot, (2010) 'Fuzzy logic based layers 2 and 3 handovers in IEEE 802.16e network', Computer Communications, 2224-2245.
- [6] Kwong, C.F., Chuah, T.C. and Tan, S.W. (2014) 'The ANFIS handover trigger scheme: The Long Term Evolution (LTE) perspective', IEEE International Conference on Fuzzy Systems (FUZZ-IEEE).
- [7] Calhan, A. and Ceken, C. (2010) 'An adaptive neuro-fuzzy based vertical handoff decision algorithm for wireless heterogeneous networks'. In: 21st Annual IEEE International Symposium on Personal, Indoor and Mobile Radio Communications, pp. 2271-2276.
- [8] Boujelben, M., Ben Rejeb, S. and Tabbane, S. (2015) 'A novel mobility-based COMP handover algorithm for LTE-A / 5G HetNets', 23rd International Conference on Software, Telecommunications and Computer Networks (SoftCOM).
- [9] Kassar, M., Kervella, B. and Pujolle, G. (2008) 'An overview of vertical handover decision strategies in heterogeneous wireless networks', Computer Communications, 2607-2620
- [10] Bin, M., Xiaofeng, L. and Xianzhong, X. (2013) 'Vertical Handoff Algorithm Based on Type-2 Fuzzy Logic in Heterogeneous Networks', JOURNAL OF SOFTWARE, Vol. 8, No. 11.
- [11] Farnaz, F., Seyed, S. and Chun, R. (2014) 'A Fuzzy Logic Approach for Quality of Service Quantification in Wireless and Mobile Networks', 10th IEEE International Workshop on Performance and Management of Wireless and Mobile Networks.
- [12] Semenova, O. and Semenov, A. (2017) 'The neuro-fuzzy controller for handover operation in mobile networks', IEEE First Ukraine Conference on Electrical and Computer Engineering (UKRCON).
- [13] Singhrova, A. Prakash, N. (2009) 'Adaptive Vertical Handoff Decision Algorithm for Wireless Heterogeneous Networks', 11th IEEE International Conference on High-Performance Computing and Communications.
- [14] Alhan, A. and Eken, C. (2012) 'An optimum vertical handoff decision algorithm based on adaptive fuzzy logic and genetic algorithm'. Wireless Pers. Commun. 64(4), 647-664.
- [15] Israt, P., Chakma, N. and Hashem, M.M.A. (2009) 'A Fuzzy Logic Based Adaptive Handoff Management Protocol for Next Generation Wireless Systems', Journal of Networks, Vol. 4, No.10.
- [16] Ben-Mubarak, M.A., Mohd. Ali, B., Noordin, N.K., Ismail, A. and Ng, C.K. (2013) 'Fuzzy logic based self-adaptive handover algorithm for mobile wimax'. Wireless Pers. Commun. 71(2), 1421
- [17] Devia, R., Kumar Jhaa, R., Gupta, A., Jainb, S. and Kumar, P. (2017) 'Implementation of Intrusion Detection System using Adaptive Neuro-Fuzzy Inference System for 5G wireless communication network', AEU - International Journal of Electronics and Communications, Vol.74, Pages 94-106
- [18] Sharma, M. and Khola, R.K. (2012) 'Fuzzy logic based handover decision system', International Journal of Ad hoc Sensor & Ubiquitous Computing, vol. 3, no. 4, pp. 21-29.
- [19] A. A. Atayero, M. K. Luka, (2012) 'Applications of Soft Computing in Mobile and Wireless Communications', International Journal of Computer Applications, Vol. 45, No. 22, pp. 48-54.
- [20] Jang, J.S.R. (1993) 'ANFIS: adaptive-network-based fuzzy inference system', IEEE Trans. Syst. Man Cybern., Vol. 23, No. 3, pp. 665-685.
- [21] Kemeng Yang, Bi n Qiu; Laurence S. Dooley, (2007) USING SINR AS VERTICAL HANDOFF CRITERIA IN MULTIMEDIA WIRELESS NETWORKS » IEEE International Conference on Multimedia and Expo, p. 967-970.
- [22] Kwong, C., Chuah, T. and Lee, S. (2009) 'Adaptive Network Fuzzy Inference System (ANFIS) Handoff Algorithm', International Conference on Future Computer and Communication, pp. 195-198.
- [23] Abdel Fadeel, G., Khalaf, M. and Hesham Zariief, B. (2013) 'A comprehensive approach to vertical handoff in heterogeneous wireless networks', Journal of King Saud University - Computer and Information Sciences, Vol. 25, Issue 2, p.p.197-205.