

Document downloaded from:

<http://hdl.handle.net/10251/62740>

This paper must be cited as:

Moragues Pons, ME.; Montes Robles, R.; Ros-Lis, JV.; Alcañiz Fillol, M.; Ibáñez Civera, FJ.; Pardo Vicente, MT.; Martínez Mañez, R. (2014). An optoelectronic sensing device for CO detection in air based on a binuclear rhodium complex. *Sensors and Actuators B: Chemical*. 191:257-263. doi:10.1016/j.snb.2013.09.107.



The final publication is available at

<http://dx.doi.org/10.1016/j.snb.2013.09.107>

Copyright Elsevier

Additional Information

# An optoelectronic sensing device for CO detection in air based on a binuclear rhodium complex.

María E. Moragues<sup>1,2</sup>, Roberto Montes-Robles<sup>1</sup>, José Vicente Ros-Lis<sup>1</sup>, Miguel Alcañiz<sup>1</sup>, Javier Ibañez<sup>1</sup>, Teresa Pardo<sup>1,2</sup>, Ramón Martínez-Mañez<sup>1,2\*</sup>

<sup>1</sup>*Centro de Reconocimiento Molecular y Desarrollo Tecnológico (IDM). Unidad Mixta Universitat Politècnica de València – Universitat de València. Camino de Vera, s/n. +34 963877343, 46022 Valencia, Spain.*

<sup>2</sup>*CIBER de Bioingeniería, Biomateriales y Nanomedicina (CIBER-BNN).*

Corresponding author: rmaez@qim.upv.es, Universitat Politècnica de Valencia, Camino de Vera s/n, 46021, Valencia, Spain. Tel: +34 963879347, Fax: +34 963879349

## Abstract.

The design, fabrication and validation of an optoelectronic sensor implemented in an easy-to-use portable device for the selective and sensitive detection of CO in air is reported herein. The system is based on the colour changes observed in the binuclear rhodium complex of formula  $[\text{Rh}_2[(\text{C}_6\text{H}_4)\text{P}(\text{C}_6\text{H}_5)_2]_2(\text{O}_2\text{CCF}_3)_2] \cdot (\text{CF}_3\text{CO}_2\text{H})_2$  (**1**) upon coordinating CO molecules in axial positions. Complex **1** is used supported on cellulose chromatography paper. In this support, colour changes to the naked eye are observed for CO concentrations above 50 ppm. The probe is also implemented in a simple portable optoelectronic device. The cellulose support containing probe **1** in this device is placed inside a small dark chamber, is illuminated with a tricolour LED emitting at 624, 525 and 470 nm, respectively corresponding to red (R), green (G) and blue (B) light, and reflected light is detected by a photodiode. With a transimpedance amplifier, the current generated by the photodiode is transformed into a voltage compatible with the 10-bit analogue-to-digital converter (ADC) port. Colour changes are measured as the distance  $d$  between the R, G and B data of the blank (probe without CO) and that for a certain CO concentration. Typical calibration curves are fitted using a bi-exponential equation. This system offers a typical response time of a few minutes (ca. 7 min) and a limit of detection of 11 ppm. The probe in the cellulose supports is also highly reversible. The optoelectronic device is portable (dimensions 14 x 8.5 x 3.5; weighs approximately 270

g) and is powered by AA batteries. Additionally, no variations in experimental parameter  $d$  upon exposure to CO<sub>2</sub>, N<sub>2</sub>, O<sub>2</sub>, Ar, water-saturated air and vapours of chloroform, hexane, ethanol, acetone, methane, toluene or formaldehyde are observed. Besides, colour changes are found for acetonitrile vapour, NO and NO<sub>2</sub>, but only at high concentrations. For validation purposes, the device was used to determine the CO present in the 4-shed accumulated smoke of two cigarette types after passing smokers' lungs.

**Keywords:** Carbon monoxide, optical device, gas sensor, chromogenic, rhodium.

## 1. Introduction.

Carbon monoxide is a potentially deadly common substance which has no colour, odour or taste. This hazardous gas is invisible, toxic and notoriously difficult to detect, and is colloquially known as the silent killer [1]. The effects of CO exposure can vary greatly from person to person depending on age, overall health, and the concentration and length of exposure [2]. At low levels, CO causes mild flu-like symptoms, including headaches, dizziness, disorientation, nausea and fatigue. Moreover, high levels of CO or constant exposure can cause angina, impaired vision, reduced brain function, and eventually death. Although there is an increasing awareness of the effects and dangers of carbon monoxide poisoning, still thousands of people die worldwide each year and many people remain blissfully unaware that they are constantly exposed to a source of this deadly gas.

In general, carbon monoxide exposure is produced as a result of the incomplete burning of natural gas or carbon-based fuels (i.e., propane, gasoline, kerosene, wood, coal, charcoal, etc.) in combination with improperly vented heaters and furnaces. In fact, in some of those places with systems that function improperly, the amount of carbon monoxide can reach dangerous levels. Moreover, small concentrations of carbon monoxide can be found, among others, in auto exhausts, tobacco smoke, kitchens, chimneys, fireplaces or central heating systems. Apart from these general sources, carbon monoxide poisoning is also an occupational hazard [3]. In particular, welders, mechanics, engine operators, forklift operators, fire fighters, marine workers, toll-booth attendants, customs inspectors, police officers, taxi drivers, and carbon-black makers are at constant risk of carbon monoxide poisoning. It is therefore vital to periodically check

that all appliances and ventilation systems in both the home and workplace function properly, and it is also important to be able to detect carbon monoxide leaks.

Traditionally, electrochemical cells, solid-state sensors and thermocouples have been used to measure CO with varying degrees of success. Some portable CO sensors are commercially available which can detect low CO concentrations in air at low temperature. They are mainly electrochemical sensors based on technologies of metal oxide semiconductors. These instruments consist of a set of three electrodes (working, auxiliary and reference electrodes) covered by a gas permeable membrane. Carbon monoxide is quantified through the semi-reactions that take place in the anode and cathode of an electrochemical cell, where the oxidation of CO to CO<sub>2</sub> and the reduction of O<sub>2</sub> to H<sub>2</sub>O occur [4]. With these electrochemical devices, good resolutions and measuring ranges (i.e., 0-2000 ± 5-10 ppm) are obtained. However, these technologies need periodical validations, are very sensitive to temperature (working temperatures between 5 and +45°C with signal drifts induced by variations of only ±0.1°C) and pressure (with signal drifts due to pressure variations lower than 10<sup>-5</sup> bar). Furthermore, these systems do not withstand pressures above 1 atmosphere and cannot be used under vacuum conditions. Improved electrochemical CO sensors use very a low concentration of alkaline electrolyte, integrate an extremely small amount of noble metal catalyst into the catalyst layer and use a dry battery structure, thus avoiding the risk of electrolyte leakage [5]. Despite improvements, these portable devices for CO detection are likely to generate false alarms in the presence of other chemicals or interfering gases.

Among solid-state CO gas sensors, ZnO and SnO<sub>2</sub> [6,7] are two of the most studied materials given their chemical stability and high electron mobility. However, SnO<sub>2</sub> is often operated at high temperatures, typically above 400°C, to achieve a catalytic oxidation of the gas with high sensitivity. Some authors have reported that ZnO [8] and SnO<sub>2</sub> [9-11], doped with Pt or Au nanoparticles, nanorods or nanowires, display catalytic CO spillover oxidation, thus improving gas sensitivity in semiconductors and requiring low practical temperatures. In recent years, other materials have been developed to improve CO sensing; such as, nanostructured BiOCl ribbons doped with Au nanoparticles [12] or nanostructured WO<sub>3</sub> films doped with Fe [13]. With BiOCl/Au nanoparticles, the quantitative detection of CO has been demonstrated in the 100 to 400 ppm range to work at temperatures of ca. 200-300°C, while WO<sub>3</sub>/Fe films have responded to CO from 10 to 1000 ppm at a minimum temperature of 150°C. These

working temperature ranges and the consequent high energy consumption required for these solid-state sensors restrict their use to certain applications.

One alternative to these electrochemical systems is the design of optical CO sensors. Reported CO sensors are mainly based on two technologies: the use of spectrally narrowband lasers [14] (primarily diode electrodes) and the use of non-dispersive infrared (broadband) systems. The non-dispersive infrared method (NDIR) is among the most reliable and accurate methods to measure carbon monoxide concentrations in urban air [15]. NDIR systems are commercially available with limits of detection of approximately 0.02 ppm. These optical CO measuring techniques are sensitive, but relatively low concentrations of other common gases, such as CO<sub>2</sub>, NO<sub>x</sub>, hydrocarbons or water vapour, may interfere.

An alternative to these systems is the use of molecular-based probes for the design of opto-chemical devices for CO sensing, including fluorescent probes in living cells based in palladium [16] and iron compounds [17]. However, most existing CO-sensing probes based on the use of chromogenic probes, such as oxoacetatobridged triruthenium cluster complexes [18], rhodium complexes [19], polypyrrole functionalised with iron porphyrin derivatives [20], hybrid materials incorporating a cobalt(III) corrole complex [21], and iron compounds of diisopropylphosphinodiaminopyridine [22], either behave as CO probes only in solution or offer very limited colour changes, which hinder their application. In this field, we have recently reported a family of binuclear rhodium(II) compounds of the general formula  $[\text{Rh}_2\{(\text{XC}_6\text{H}_3)\text{P}(\text{XC}_6\text{H}_4)\}_n(\text{O}_2\text{CR})_{4-n}] \cdot \text{L}_2$  containing one or two metallated phosphines (in a head-to-tail arrangement) and different axial ligands as CO-sensing probes. Chloroform solutions of these complexes undergo rapid colour change, from purple to yellow, when air samples containing CO are bubbled through them. Moreover, the binuclear rhodium complexes were also adsorbed on silica and used as colorimetric probes for “naked eye” CO detection in the gas phase. [23,24]

Based on these previous findings, we report herein the development and validation of an easy-to-use, robust and portable optoelectronic CO device capable of displaying a selective and sensitive optical response to carbon monoxide in air, which is based on the use of a binuclear rhodium(II) derivative.

## **2. Experimental**

### **2.1. Chemicals and materials**

The commercially available reagents  $[\text{Rh}_2(\text{O}_2\text{CCH}_3)_4]$ ,  $\text{P}(\text{C}_6\text{H}_5)_3$  and  $\text{CF}_3\text{CO}_2\text{H}$  carboxylic acid were used as purchased. All the solvents were of analytical grade.

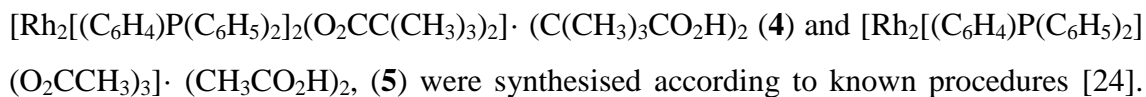
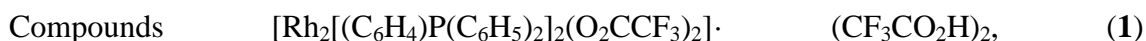

were synthesised according to known procedures [24]. Cellulose paper (Whatman Grade No. 3MM Chromatography Paper) was purchased from VWR. Carbon monoxide was provided by the Abelló Linde Company. Dry air was obtained from a compressor (ATLAS COPCO, SF 4FF). The rest of the gases used in this work were generated *in situ*: carbon dioxide by adding chloride acid to sodium carbonate; nitrogen monoxide and nitrogen dioxide by oxidation of copper with nitric acid and sulphur dioxide by copper oxidation with sulphuric acid.

## 2.2. Preparation of the probe.

The probe was supported on cellulose paper for chromatographic use (Whatman Grade No. 3MM Chromatography Paper). Probes were prepared easily by dropping 0.2 mL of a solution of the corresponding binuclear rhodium(II) complex in dichloromethane (40 mg/mL) on a piece of paper of 1 cm<sup>2</sup> and further drying at air under ambient conditions.

## 2.3. Characterisation of the probe response.

Gas mixtures were prepared at 25°C by a computer-driven gas mixing system composed of two mass flow controllers (model F-201CV, Bronkhorst High-Tech). Additionally, CO concentrations were validated with a Testo analyzer (315\_2 model 0632 0317), which was previously calibrated and certified by the Spanish Certification Agency (ENAC). The colorimetric response of the strips was studied by UV-Vis spectra in a Jasco V-650 spectrophotometer equipped with a diffuse reflectance sphere (model ISV-722, Sphere). Measurements were taken at room temperature over a wavelength range of 350-700 nm with a wavelength step of 1 nm.

## 2.4. Electronic system.

Figure 1 shows the block diagram of the optical sensing device for CO detection. The system is controlled by a microcontroller ( $\mu\text{C}$ ) Microchip PIC18F2550. It handles all the device's functions, such as: sensor reading, communication with the computer, data storage control in the memory and real-time date and time monitoring. Data can be downloaded to a PC through the serial port using the UART protocol. A USB2.0 port can also be used, including an UART to USB2.0 converter. The LCD display is directly connected to the microcontroller, while the temperature sensor (MCP9803 of Microchip), real-time clock (RTC DS1307 of Maxim) and the EEPROM are included in the microcontroller through an I2C module.

The equipment allows two inward airflow options: naturally or forced by a pump. All the experiments reported herein were carried out without using the intern pump. Hence the uptake of gas mixtures was not directly forced to pass through the probe. The equipment is also equipped with a buzzer to set alarms, if required. The device is portable (dimensions 14 x 8.5 x 3.5 and weighs approximately 270 g) and power is provided by two AA batteries that offers a battery duration of up to 72 h under continuous monitoring conditions (with the pump switched on). Battery duration can be prolonged substantially by reducing the measuring frequency and by switching off the air pump. Sampling times are configurable with ranks ranging from a few seconds to 30 min. Apart from sporadic measurements, the system is equipped with a clock, and an internal memory that stores colour measurements and times. Finally, the device is completed with an alphanumeric LCD display for the configurations and readings of the CO concentrations and there are two front buttons to set the configuration options (i.e., alarm on/off, motor on/off, sampling time, intensity of each light emission in the triple-LED sensor, internal memory used or removing internal memory).

## **2.5. Optical system**

The optical detection of CO is achieved using a CO sensitive layer (a cellulose strip), a tricolour LED as the light source and a photodiode as the detector. The emissive part of the optical system is composed of a tricolour LED (PLCC6 Full-Colour SMD LED FCL-P5RR from Forge Europa) [25] which emits at 624, 525 and 470 nm, corresponding to red (R), green (G) and blue (B) light, respectively. A photodiode (BPX65 from Osram) was used for the detection of colour changes. Through illumination, the probe reflects the LED light that energises the photodiode. This signal

is adapted and captured by the analogue-to-digital converter (ADC) port available on the microcontroller. The intensities collected by the R, G and B LED wavelengths are stored in RAM as R, G and B values, respectively, which are subsequently processed for noise removal [26]. The resulting RGB data, along with the temperature, date and time of the experiment, are stored in the EEPROM. By taking the values obtained in the absence of CO ( $R_0$ ,  $G_0$  and  $B_0$ ) as a reference, the Euclidean distance  $d$  for a certain sample  $i$  ( $R_i$ ,  $G_i$  and  $B_i$ ) is calculated by Equation (1). This Euclidean distance is related to the concentration level of CO present in air.

$$d = \sqrt{(R_0 - R_i)^2 + (G_0 - G_i)^2 + (B_0 - B_i)^2} \quad (1)$$

Colorimetric performance and the stability of the equipment over time were evaluated using a collection of strips of diverse colours, which were measured several times. In all cases, reproducible RGB values were obtained.

### 3. Results and discussion.

#### 3.1. Optoelectronic sensor

As mentioned above, we have recently reported that some cyclometallated binuclear rhodium complexes are capable of reacting reversibly with CO in air to result in colour changes that are visible to the naked eye [24]. Specifically for this work, five rhodium complexes of the formulas  $[\text{Rh}_2[(\text{C}_6\text{H}_4)\text{P}(\text{C}_6\text{H}_5)_2]_2(\text{O}_2\text{CCF}_3)_2] \cdot (\text{CF}_3\text{CO}_2\text{H})_2$  (**1**),  $[\text{Rh}_2[(\text{C}_6\text{H}_3\text{CH}_3)\text{P}(\text{C}_6\text{H}_4\text{CH}_3)_2]_2(\text{O}_2\text{CCH}_3)_2] \cdot (\text{CH}_3\text{CO}_2\text{H})_2$  (**2**),  $[\text{Rh}_2[(\text{C}_6\text{H}_4)\text{P}(\text{C}_6\text{H}_5)_2]_2(\text{O}_2\text{CCH}_3)_2] \cdot (\text{CH}_3\text{CO}_2\text{H})_2$  (**3**),  $[\text{Rh}_2[(\text{C}_6\text{H}_4)\text{P}(\text{C}_6\text{H}_5)_2]_2(\text{O}_2\text{CC}(\text{CH}_3)_3)_2] \cdot (\text{C}(\text{CH}_3)_3\text{CO}_2\text{H})_2$  (**4**) and  $[\text{Rh}_2[(\text{C}_6\text{H}_4)\text{P}(\text{C}_6\text{H}_5)_2]_2(\text{O}_2\text{CCH}_3)_3] \cdot (\text{CH}_3\text{CO}_2\text{H})_2$ , (**5**) were synthesised according to known procedures [24]. These complexes have been reported to offer significant colour changes supported on silica, from purple to orange-salmon and yellow, in seconds when exposed to air containing carbon monoxide given the consecutive axial coordination of two CO molecules and the formation of the corresponding derivatives  $\mathbf{n} \cdot \text{CO}$  and  $\mathbf{n} \cdot (\text{CO})_2$ , respectively. Figure 2 shows a representation of the CO reaction with binuclear rhodium(II) complex **1**.

Despite the good colorimetric response recently observed by us for the **1-5** complexes on silica in the presence of CO [24], we found that this support was not easy to handle and it was difficult to integrate it into the optoelectronic device. Therefore in a



first step, different supports were tested to incorporate binuclear rhodium(II) probes. Attempts were made with a number of organic (e.g., polymers) and inorganic supports. However most of them proved unsuitable because, in most cases, the probes displayed a considerable loss of sensing properties or loss of reversibility. The rhodium complexes retained clear and reversible naked-eye colour changes in only two supports: in silica gel plates for thin layer chromatography; in a cellulose paper for chromatographic use. Silica gel plates proved fragile and were also ruled out as supports. Conversely, chromatographic paper was flexible and it was easy to prepare reproducible homogeneous sensing systems by dropping 0.2 mL of a solution of the corresponding binuclear rhodium(II) complex in dichloromethane (40 mg/mL) on a piece of paper (1 cm<sup>2</sup>) with further drying.

As described in the Experimental Section, the chromatographic paper containing the rhodium probe was placed inside a small dark chamber, illuminated with a tricolour LED emitting at 624, 525 and 470 nm and reflected light was detected by a photodiode. Colour changes were then measured as the distance  $d$  between the RGB data of the blank (probe without CO) and that of the probe at a certain CO concentration (see Equation 1).

### **3.2. Optical response of the probe and calibration of the optoelectronic device.**

By way of example of the response observed for the binuclear rhodium(II) complexes in the presence of CO, Figure 3 shows the evolution of the UV-Vis diffuse reflectance of the cellulose paper containing probe **1** in the presence of air containing 50 and 500 ppm of CO. Apart from probe **1**, the remaining binuclear rhodium(II) complexes **2-5** were also tested in the cellulose support. However the latter displayed a less sensitive colour change and poorer reversibility. Therefore, the remaining studies were carried out only with the films containing probe **1**.

It is worth mentioning that although the CO sensitivity of complex **1** decreased in the cellulose strip as compared to silica, the cellulose support proved suitable to detect carbon monoxide in a wide range of concentrations (*vide infra*). For instance, Figure 4 shows the colour changes observed on the cellulose substrates of **1** for different CO concentrations in air. Clear changes can be seen by the naked eye at concentrations as low as 50 ppm. Moreover, Figure 4 suggests that these cellulose strips can be implemented as a suitable colour scale for CO sensing to the naked eye. In relation to the colour changes observed in the figure, it is interesting to note that the CO

concentrations of ca. 50 ppm are the concentration at which CO becomes toxic for healthy adults who are submitted to continuous exposure. Moreover, CO concentrations of ca. 300-400 ppm are the limit at which carbon monoxide starts to become highly toxic for adults over short exposure periods [27].

Figure 5 shows a typical calibration curve of the colour differences ( $d$  values, see Equation 1) measured using the optoelectronic above-described equipment when employing probe **1** on a cellulose support upon the addition of increasing concentrations of CO in air (0–7000 ppm). An almost linear dependence on the CO concentration of between 2 and 80 ppm was observed. However,  $d$  loses linearity when the concentration is increased and approaches saturation when the carbon monoxide concentration is of ca. 7000 ppm. An important issue relating to implementing the calibration curve in the optoelectronic sensing device is fitting the obtained  $d$  values in accordance with the CO concentration. In the first attempt made, the response was empirically fitted to a single exponential to obtain Equation 2 with a regression coefficient of 0.9759. Regardless of this relatively low regression coefficient, it was not possible to properly fit the resulting equation to the experimental data (see Figure 5a), especially at low CO concentrations.

$$y = 62.92 - 58.00 \cdot e^{-0.001x} \quad (2)$$

In the equation,  $y$  is the value of  $d$  and  $x$  is the CO concentration in ppm. At this point it should be noted that, as expressed in Figure 1, the CO coordination to the binuclear rhodium compound, and therefore the colour change, is a two-step process given the presence of two consecutive CO molecules which coordinate at the axial positions of the probe. Thus by bearing this concept in mind, the optical response in Figure 5 was fitted to a bi-exponential equation (see Equation 3).

$$y = 62.65 - 50.07 \cdot e^{-0.0006x} - 13.24 \cdot e^{-0.0184x} \quad (3)$$

A regression coefficient of 0.9983 was calculated for the bi-exponential model in agreement with the excellent fit to the experimental values within the whole concentration range (see Figure 5b). Having programmed the bi-exponential equation, the opto-chemical device herein reported was able to determine CO concentrations from 0 to 7000 ppm with an error of  $\pm 4$  ppm. Some additional information can be obtained from the fit parameters of the bi-exponential equation. By bearing into mind the

characteristic  $a \cdot e^{-bx}$  structure for the exponential equations, values of 50.07 and 13.24 were obtained for the “ $a$ ” terms of the equation. These values correlated directly with the contribution of each term to the global  $d$  change. Conversely, “ $b$ ” reflects the strength of the CO-ligand interaction, that is: the higher the value, the greater the strength and the lower the concentration needed to induce spectroscopic changes. Thus the exponential equation with the highest “ $b$ ” value (0.0184) responds to low CO concentrations and is responsible for most colour variation ( $d$ ) up to 500 ppm. We believe that this can be tentatively assigned to the coordination of the first CO molecule to probe **1** in agreement with the CO response range.

### 3.3. Sensitivity, selectivity and reversibility studies.

From the calibration curve, a limit of detection (LOD) as low as 11 ppm of CO in air was obtained using the experimental data ( $d$ ) registered by the optoelectronic device with the cellulose strip containing probe **1**. In comparison with the LOD of 0.8 ppm CO for complex **1** when adsorbed on silica gel, sensitivity was clearly affected when the probe was on the cellulose strip. Nevertheless, this did not hamper device performance since it was still lower than 50 ppm, which is the concentration at which CO becomes toxic for healthy adults who are continuously exposed beyond an 8-hour period. Moreover, typical response times of ca. 7 min were determined.

The cellulose strips of **1** exhibited very high selectivity towards CO. No variations in experimental parameter  $d$  upon exposure to CO<sub>2</sub>, N<sub>2</sub>, O<sub>2</sub>, Ar or water-saturated air were observed. Furthermore, no colour change was registered by the optoelectronic device in the presence of vapours of volatile organic compounds (VOCs), such as chloroform, hexane, ethanol, acetone, methane, toluene or formaldehyde. Reversible colour changes to yellow were observed in the presence of acetonitrile vapour, but only at concentrations of 4900 ppm. Studies with coordinating species, such as SO<sub>2</sub>, NO, and NO<sub>2</sub>, were also carried out. In these cases, no reaction between SO<sub>2</sub> and the strips of probe **1** was observed. The presence of nitrogen oxides NO and NO<sub>2</sub> induced a reversible orange-brown colour modulation of the binuclear rhodium(II) complex, which slightly differed from that observed in the presence of CO, but only when very high concentrations of NO or NO<sub>2</sub> were being used (8900 ppm and 3162 ppm, respectively). All these results are consistent with the behaviour observed for the binuclear rhodium(II) complexes adsorbed on silica [24]. However, the interfering

concentrations of acetonitrile, NO and NO<sub>2</sub> were even higher for probe **1** on cellulose strips since in silica, interfering concentrations for acetonitrile, NO and NO<sub>2</sub> were 4600, 4070 and 2700 ppm, respectively.

Reversibility was also extensively evaluated for the cellulose strips contained in complex **1**. The optoelectronic device was exposed to air containing 30 ppm of CO at room temperature for 7 min and then parameter *d* was determined. After measurements were taken, the device was placed in CO-free air for 7 min and the *d* value was determined again. This process was repeated several times and the results are shown in Figure 6. A basically reversible sensing process was clearly observed.

### 3.4. Tests in real environments and samples.

The response effectiveness of the opto-electronic device was tested in a chemistry laboratory environment, which was assumedly CO-free. As expected, the device registered concentrations of CO of ca. 0 ppm for days, thus the typical solvent vapours in a laboratory did not affect the optoelectronic device response. Finally the device was used to determine the CO present in the 4-shed accumulated smoke of two cigarette types after passing smokers' lungs. In accordance with the values reported in previous studies, 9 and 25 ppm of CO were measured for normal and fine-cut tobacco cigarettes, respectively [28].

## 4. Conclusions

An optoelectronic device for CO monitoring in air has been developed. It is based on the reversible reaction of CO with binuclear rhodium(II) complex [Rh<sub>2</sub>[(C<sub>6</sub>H<sub>4</sub>)P(C<sub>6</sub>H<sub>5</sub>)<sub>2</sub>]<sub>2</sub>(O<sub>2</sub>CCF<sub>3</sub>)<sub>2</sub>]·(CF<sub>3</sub>CO<sub>2</sub>H)<sub>2</sub> (**1**) which is coupled with colour changes. Probe **1** is incorporated into a cellulose paper for chromatography and this simple system has proven to be suitable for the naked eye detection of CO in air at concentrations as low as 50 ppm. Moreover the cellulose strips containing probe **1** were used as the sensing part of an optoelectronic device for CO monitoring. The device illuminated the probe with a tricolour LED, which emits at 624, 525 and 470 nm, and the reflected light was detected by a photodiode. The electronic system is portable (dimensions 14 x 8.5 x 3.5, weighing approximately 270 g) and is powered by AA batteries, which offer good battery duration. Colour variations in this device were measured as the distance *d* between the RGB values of the blank (probe without CO)

and that of the probe with a certain CO concentration. A typical response time of 7 min and a limit of detection of 11 ppm were obtained using the optoelectronic device. Moreover, the system proved highly selective to the presence of CO and no changes were found in the presence of other common gases (CO<sub>2</sub>, N<sub>2</sub>, O<sub>2</sub>, Ar) and saturated vapour of common solvents (chloroform, hexane, ethanol, acetone, methane, toluene or formaldehyde). Only acetonitrile vapour, NO and NO<sub>2</sub> were found to be interferents, but only at very high concentrations.

### **Acknowledgments**

We thank the Spanish Government (Project MAT2012-38429-C04-01), Generalitat Valenciana (Projects PROMETEO2009/016 and ISIC/2012/005) and the UPV (Project INNOVA-04-10) for support. M.E.M thanks the Spanish Ministry of Education for a Doctoral FPU Fellowship.

### **References**

- [1] L.J. Wilkinson, R.H. Waring, G.B. Steventon, S.C. Mitchell, *Molecules of death. Carbon monoxide-the silent killer*, 2nd ed., Imperial College Press (2007) London.
- [2] K. Rajiah<sup>1</sup>, E.M. Mathew, Clinical manifestation, effects, diagnosis, monitoring of carbon monoxide poisoning and toxicity, *Afr. J. Pharm. Pharmacol.* 5 (2011) 259-264.
- [3] J-C. Normand, C. Durand, B. Delafosse, Acute carbon monoxide poisoning: a persistent occupational risk, *Archives des Maladies Professionnelles et de l'Environnement* 72 (2011) 240-245.
- [4] [www.testo.com](http://www.testo.com)
- [5] [www.figarosensor.com](http://www.figarosensor.com)
- [6] G. Korotcenkov, V. Brynzari, S. Dmitriev, SnO<sub>2</sub> films for thin film gas sensor design, *Mater. Sci. Eng. B* 63 (1999) 195-204.
- [7] N. Yamazoe, Y. Kurokawa, T. Seiyama, Effects of additives on semiconductor gas sensors, *Sens. Actuators* 4 (1983) 283-289.
- [8] P. Rai, Y-S. Kim, H-M. Song, M-K. Song, Y-T. Yu, The role of gold catalyst on the sensing behavior of ZnO nanorods for CO and NO<sub>2</sub> gases, *Sensors and Actuators B* 165 (2012) 133-142.
- [9] N. Yamazoe, New approaches for improving semiconductor gas sensors, *Sensors and Actuators B* 5 (1991) 7-19.

- [10] N. Barsan, M. Schweizer-Berberich, W. Göpel, Fundamental and practical aspects in the design of nanoscaled SnO<sub>2</sub> gas sensors: a status report, *Fresenius Journal of Analytical Chemistry* 365 (1999) 287-304.
- [11] T. Yanagimoto, Y-T. Yu, K. Kaneko, Microstructure and CO gas sensing property of Au/SnO<sub>2</sub> core-shell structure nanoparticles synthesized by precipitation method and microwave-assisted hydrothermal synthesis method, *Sensors and Actuators B* 166-167 (2012) 31-35.
- [12] C.R. Michel, N.L.López, A.H. Martínez-Preciado, CO<sub>2</sub> and CO gas sensing properties of nanostructures BiOCl ribbons doped with gold nanoparticles, *Sensors and Actuators B* 173 (2012) 100-105.
- [13] M. Ahsan, T. Tesfamichael, M. Ionescu, J. Bell, N. Motta, Low temperatura CO sensitive nanostructures WO<sub>3</sub> thin films doped with Fe, *Sensors and Actuators B* 162 (2012) 14-21.
- [14] J. Wolfrum, *Lasers in Combustion: From Basic Theory to Practical Devices*, *Proc. Combust. Inst.* 27, 1 (1998) 1-41.
- [15] K-H. Cho, S-W. Lee, J-H. Lee, K-S. Choi, Development and properties of carbon monoxide detector for ambient air monitoring, *Analytical Science & Technology* 13 (2000) 222-228.
- [16] B. W. Michel, A. R. Lippert, C. J. Chang, A Reaction-Based Fluorescent Probe for Selective Imaging of Carbon Monoxide in Living Cells Using a Palladium-Mediated Carbonylation, *J. Am. Chem. Soc.* 134 (2012) 15668-15671.
- [17] J. Wang, J. Karpus, B. S. Zhao, Z. Luo, P.R. Chen, C. He, A Selective Fluorescent Probe for Carbon Monoxide Imaging in Living Cells, *Angew. Chem. Int. Ed.*, 51 (2012) 9652-9656.
- [18] M. Itou, Y. Araki, O. Ito, H. Kido, Carbon Monoxide Ligand-Exchange Reaction of Triruthenium Cluster Complexes Induced by Photosensitized Electron Transfer: A New Type of Photoactive CO Color Sensor, *Inorg. Chem.* 45 (2006) 6114-6116.
- [19] A. Gulino, T. Gupta, M. Altman, S. Lo Schiavo, P. G. Mineo, I. L. Fragal, G. Evmenenko, P. Dutta, M. E. Van der Boom, *Chem. Commun.* (2008) 2900-2902.
- [20] S. Paul, F. Amalraj, S. Radhakrishnan, CO sensor based on polypyrrole functionalized with iron porphyrin, *Synthetic Metals* 159 (2009) 1019-1023.
- [21] J. M. Barbe, G. Canard, S. Brandès, R. Guillard, Selective chemisorptions of carbon monoxide by organic-inorganic hybrid materials incorporating cobalt(III) corroles as sensing components, *Chem. Eur. J.* 13 (2007) 2118-2129.
- [22] D. Benito-Garagorri, M. Puchberger, K. Mereiter, K. Kirchner, Stereospecific and Reversible CO Binding at Iron Pincer Complexes, *Angew. Chem.* 120 (2008) 9282-9285; *Angew. Chem. Int. Ed.* 47 (2008) 9142-9145.

- [23] J. Esteban, J.V. Ros-Lis, R. Martínez-Máñez, M.D. Marcos, M.E. Moragues, J. Soto, F. Sancenón, Sensitive and Selective Chromogenic Sensing of Carbon Monoxide by Using Binuclear Rhodium Complexes, *Angew. Chem. Int. Ed.* 49 (2010) 4934–4937.
- [24] M.E. Moragues, J. Esteban, J.V. Ros-Lis, R. Martínez-Máñez, M.D. Marcos, M. Martínez, J. Soto, F. Sancenón, Sensitive and Selective Chromogenic Sensing of Carbon Monoxide via Reversible Axial CO Coordination in Binuclear Rhodium Complexes, *J. Am. Chem. Soc.* 133 (2011) 15762–15772.
- [25] S.W. Brown, C. Santana, G.P. Eppeldauer, Development of a Tunable LED-Based Colorimetric Source, *Res. Natl. Inst. Stand. Technol.* 107 (2002) 363-371.
- [26] M.T. Fairchild, *Color Appearance Models* (2005), Wiley, Chichester, UK.
- [27] UNE 23301:1988 Detection equipments of carbon monoxide concentration in the garages and parkings; UNE 23300:1984/1M:2005 Detection and measuring equipments of carbon monoxide concentration.
- [28] T. Castaño, C. Hebert, M.T. Campo, M. Ysa, A. Pons, Fine-cut tobacco: a priority for public health and consumer advocacy, *Gac. Sanit.* 26 (2012) 267-269.

## Biographies

**María Esperanza Moragues** graduated in Chemistry at the University of Valencia (UV) in 2008. She is a PhD-Student at the Polytechnic University of Valencia (UPV). Her main areas of interest are the development of chemical chemosensors and probes, especially those centred on CO detection.

**Roberto Montes-Robles** graduated in Industrial Engineering in Automation and Electronics in 2012 at the Polytechnic University of Valencia (UPV). He is working in the Electronic Engineering Department of the UPV in association with the Centre of Molecular Recognition and Technological Development (IDM). His collaboration involves the development of electronic sensors.

**José Vicente Ros-Lis** obtained a degree in Chemistry in 2000 at the University of Valencia and a PhD in 2005 at the Polytechnic University of Valencia. Currently, he is a member of the Centre of Molecular Recognition and Technological Development (IDM). His research interests include the development of chemical sensors and technology transfer.

**Miguel Alcañiz** received his MS degree in Physics from the University of Valencia, Spain, in 1991. He is an assistant professor in the Electronic Engineering Department of the UPV. He is a member of the Centre of Molecular Recognition and Technological Development

(IDM) of UPV. His research interest includes digital systems, electrochemical impedance spectroscopy and multivariable analysis.

**Javier Ibañez** is a Maîtrise in Power Electronic and Control at the Université Pierre et Marie Curie (Paris VI) in 1994 and he received his Ph.D. in 2009 at the Polytechnic University of Valencia (UPV). He is an assistant professor of Electronic Technology in the Electronic Engineering Department of the UPV. He is a member of the Institute of Molecular Recognition and Technological Development (IDM). His main areas of interest are optical devices for water and air contamination detection.

**Teresa Pardo** obtained a degree in Chemistry and joined the Polytechnical University of Valencia in 1982. After her PhD entitled “phenolic composition of grapes and red wines from the Valencia region” she joined the Center of Molecular Recognition and Technological Development in the area of chemical sensors.

**Ramón Martínez-Mañez** graduated in Chemistry at the University of Valencia in 1986, and he received his Ph.D in 1990 at the same university. After a postdoctoral period at Cambridge (UK), he joined the Department of Chemistry at the UPV. He became a full professor in 2002. His main areas of interest fall in the field of chromo-fluorogenic and electrochemical sensors and molecular probes for anions, cations and neutral chemical species.



## Figure captions

**Figure 1.-** Block diagram of the CO optoelectronic equipment.

**Figure 2.-** Complex of the general formula  $[\text{Rh}_2[(\text{C}_6\text{H}_4)\text{P}(\text{C}_6\text{H}_5)_2]_2(\text{O}_2\text{CCF}_3)_2] \cdot (\text{CF}_3\text{CO}_2\text{H})_2$  (**1**) and the corresponding **1**·CO and **1**·(CO)<sub>2</sub> products obtained upon the coordination of carbon monoxide at axial positions.

**Figure 3.-** Diffuse reflectance UV-Vis spectra of the cellulose paper probe containing **1** (solid black line) and the changes observed in the presence of air containing 50 and 500 ppm of CO (dashed line and grey line, respectively).

**Figure 4.-** Colour scale for the semi-quantification of CO (from 0 to 900 ppm) using complex **1** on cellulose strips.

**Figure 5.-** a) Simple exponential regression and b) double exponential regression of the *d* values of cellulose strips of **1** upon the addition of CO (0–8000 ppm). The inset shows a magnification in the 0–100 ppm range. Square dots are experimental data, whereas the line depicts exponential fitting.

**Figure 6.-** Colorimetric response of the cellulose strips of **1** upon four cyclic exposures to 30 ppm of CO and CO-free air.

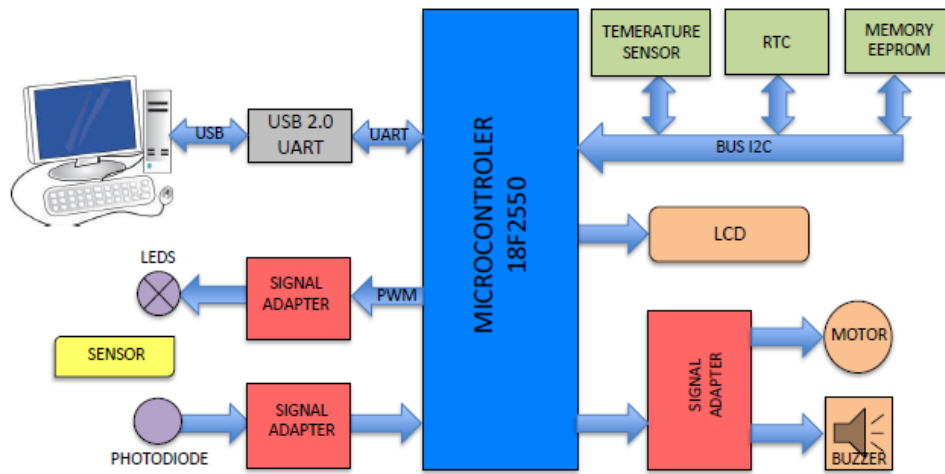

**Figure 1**

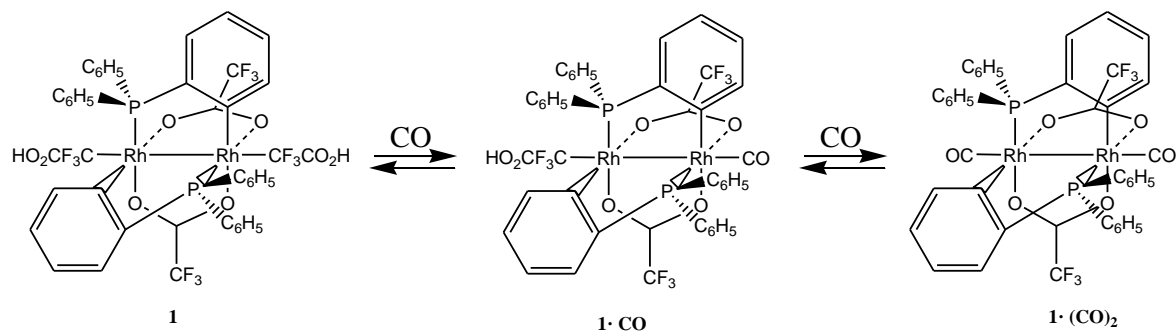

**Figure 2**

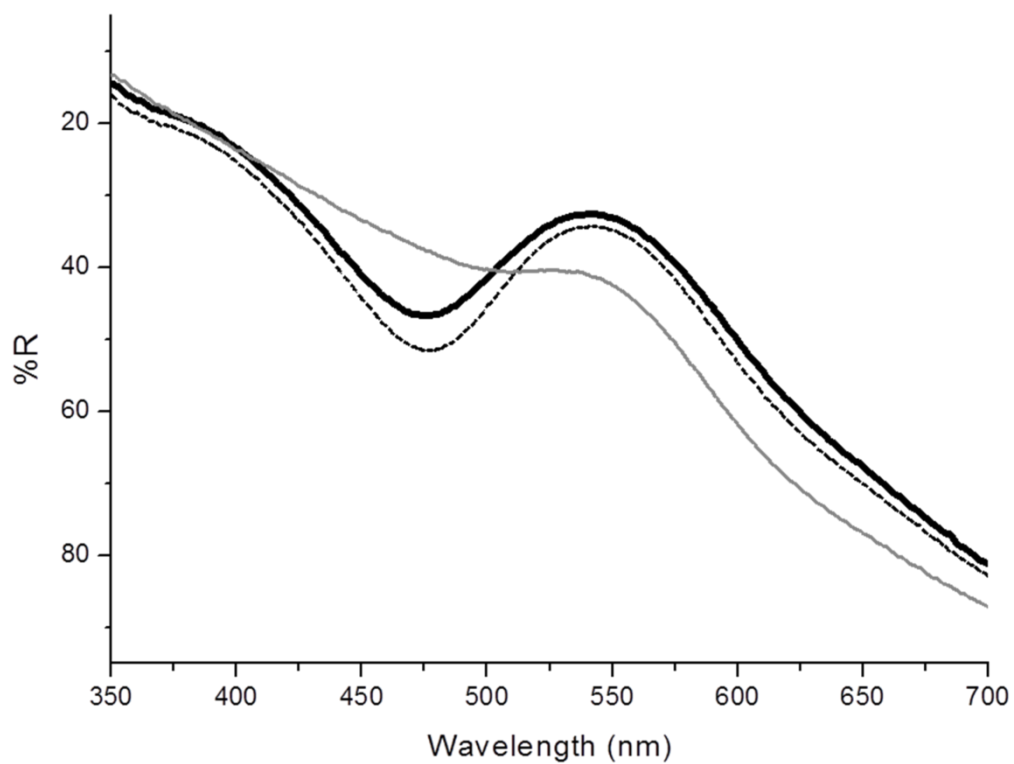

**Figure 3**

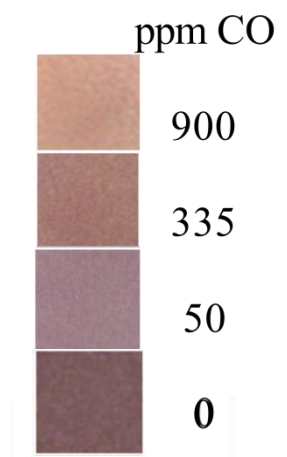

**Figure 4**

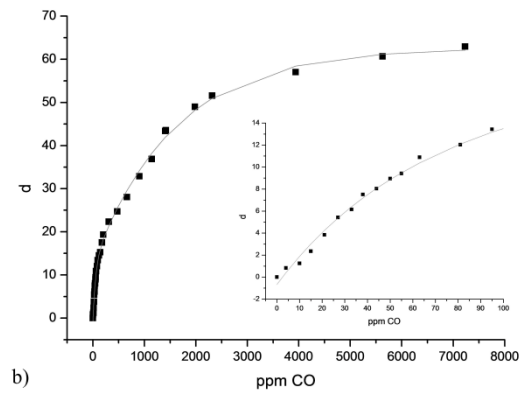
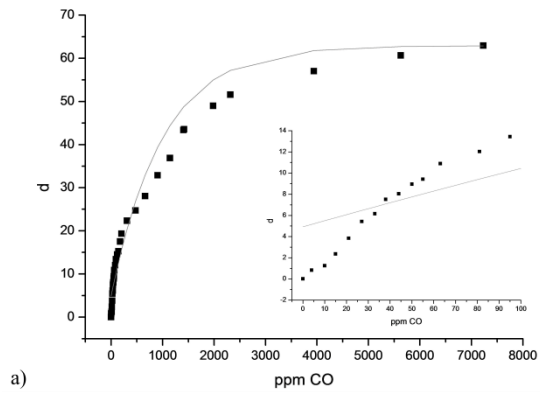

**Figure 5**

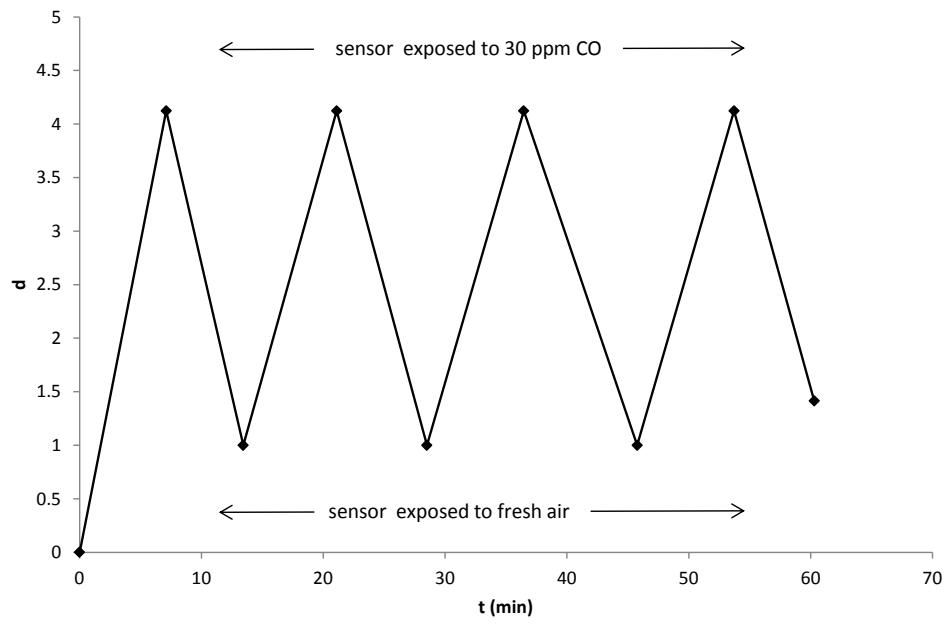

**Figure 6**

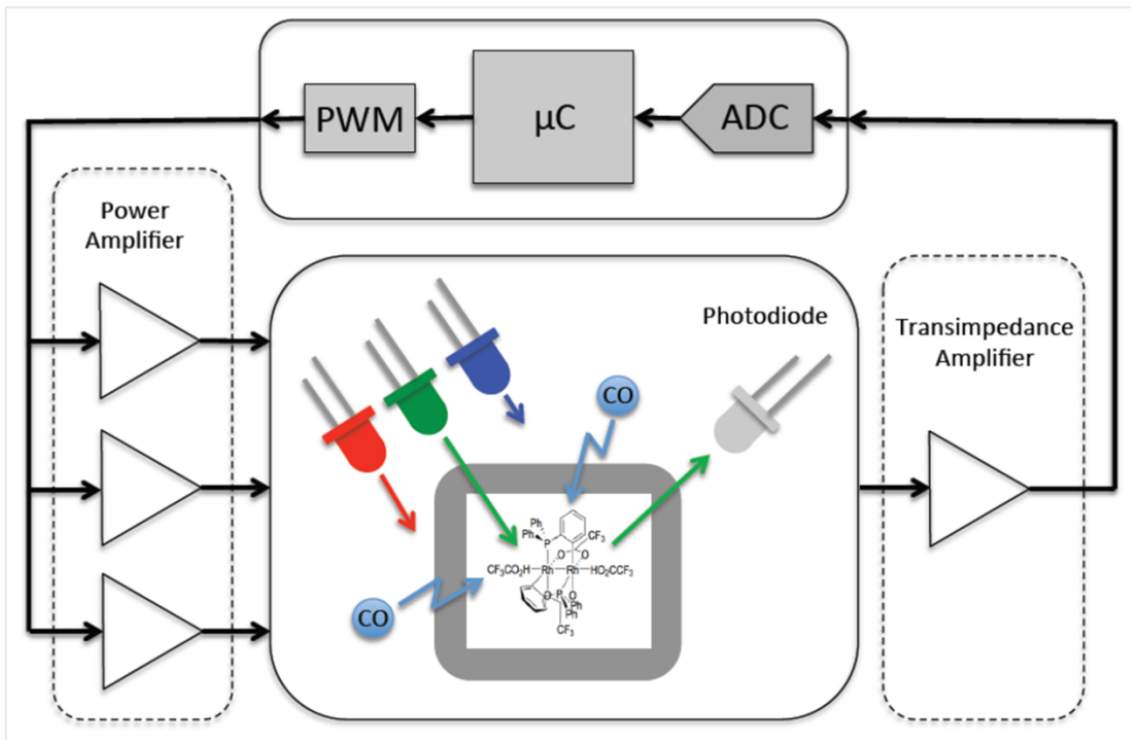

**Graphical abstract**