



Research Article

Antonio Poveda-Lerma, Guillermo Serrano-Callergues, Martin Riera-Guasp, Manuel Pineda-Sanchez, Ruben Puche-Panadero *, and Juan Perez-Cruz

Lamination effects on a 3D model of the magnetic core of power transformers

<https://doi.org/10.1515/phys-2017-0124>

Received Nov 08, 2017; accepted Nov 12, 2017

Abstract: In this paper the lamination effect on the model of a power transformer's core with stacked E-I structure is analyzed. The distribution of the magnetic flux in the laminations depends on the stacking method. In this work it is shown, using a 3D FEM model and an experimental prototype, that the non-uniform distribution of the flux in a laminated E-I core with alternate-lap joint stack increases substantially the average value of the magnetic flux density in the core, compared with a butt joint stack. Both the simulated model and the experimental tests show that the presence of constructive air-gaps in the E-I junctions gives rise to a zig-zag flux in the depth direction. This inter-lamination flux reduces the magnetic flux density in the I-pieces and increases substantially the magnetic flux density in the E-pieces, with highly saturated points that traditional 2D analysis cannot reproduce. The relation between the number of laminations included in the model, and the computational resources needed to build it, is also evaluated in this work.

Keywords: 3D simulation, laminated E-I core, alternate-lap joint stack, butt joint stack, magnetic flux, eddy currents

PACS: 41.20.Cv, 07.05.Tp

***Corresponding Author: Ruben Puche-Panadero** : Institute for Energy Engineering, Universitat Politècnica de València, Valencia, Spain; Email: rupucpa@die.upv.es

Antonio Poveda-Lerma: Power Electronics España, S.L., Valencia, Spain; Email: apoveda@power-electronics.com

Guillermo Serrano-Callergues: Power Electronics España, S.L., Valencia, Spain; Email: guiserc1@etsii.upv.es

Martin Riera-Guasp: Institute for Energy Engineering, Universitat Politècnica de València, Valencia, Spain; Email: mriera@die.upv.es

Manuel Pineda-Sanchez: Institute for Energy Engineering, Universitat Politècnica de València, Valencia, Spain; Email: mpineda@die.upv.es

Juan Perez-Cruz: Institute for Energy Engineering, Universitat Politècnica de València, Valencia, Spain; Email: juperez@die.upv.es

1 Introduction

The magnetic core is a key component of electrical machines such as power transformers [1–4], rotating electrical machines [5, 6], LCL filters for inverters and variable speed drives [7], peak current limiters [8], switching converters [9], variable inductors [10], etc. The time varying magnetic fields induce eddy currents in the core, and consequently some energy is converted into heat [11]. So, the design of magnetic cores is fundamental in order to reduce the losses in electrical machines, and this field has attracted a great interest in the technical literature [3, 12, 13]. Traditionally, to reduce the effects of eddy currents and hysteresis losses in electrical machines, the magnetic cores are assembled with laminations of magnetic steel alloyed with silicon [14]. The use of efficient mathematical tools such as the finite element method (FEM) has allowed the improvement of the design and simulation of magnetic cores [1]. However, the computational resources needed to implement a FEM model of the core increase exponentially with the number of degrees of freedom (DOF). If the lamination effect is included in a 3D FEM model by individually modeling each one of the laminations, with their corresponding insulation layers, the number of DOFs scales exponentially with the number of laminations, which makes impractical the use of such a model with modern software and computers. Besides, the huge differences between the spatial scales in the depth dimension (sub-millimeters) and the other dimensions (meters), give rise to heavily distorted meshes. Therefore, in most cases the FEM model of the laminated E-I core has been limited to simulation in two-dimensions (2D) [2, 4], adding the effect of the lamination through stacking coefficients and direction-dependent magnetic permeabilities. This approach is valid if the flux is uniformly distributed, as in the case of a laminated E-I core using a butt joint lapping method [15], but it is not valid for analyzing the non-uniform distribution of flux if an alternate-lap joint lapping method is used. What is presented in this paper is the simulation of the laminated E-I core of a power transformer [16] using a full 3D FEM model [17], which is able to



take into account the lamination effects, even in the case of alternate-lap joint stacks. This model can provide an accurate representation of the magnetic flux distribution in the laminations and spot possible areas with high saturations and losses [18], which can be avoided with an optimized design of the core. Besides, in this work, a prototype of a laminated E-I core with alternate-lap joint stack has been built and tested, to confirm the simulation results. This paper is structured as follows: in Section 2, the effect of the alternate-lap joint stacking of laminated E-I cores is presented, and a comparison is made with butt joint stacks. In Section 3, a sensitive analysis is performed, which evaluates the effects of the number of laminations included in the 3D model on the precision and the computer resources needed to run the model. In Section 4, the zig-zag inter-lamination fluxes generated in the z-direction in case of alternate-lap joint stacks are measured experimentally with a prototype. Finally, in Section 5 the conclusions of this work are presented.

2 3D model of a laminated E-I core

Laminated E-I cores are widely used in electrical machines, especially in power transformers and inductors. They are built using E and I pieces, such as those of Figure 1. There are two different lapping methods used for assembling the E-I cores:

- The alternate-lap joint method, with the E and I pieces inter-laminated alternatively (Figure 2, right).
- The butt joint method, in which the E and I pieces have the same position at each layer of the lamination (Figure 2, left).

The use of alternate-lap joint stacking in a laminated E-I core helps to increase the mechanical strength and to reduce energy losses. Figure 3 shows a simplified model, used in this work, with two laminations, using the



Figure 1: Example of E - I pieces used for assembling the laminated core

alternate-lap joint lamination method. The core of Figure 3 has been excited with a 200 turns coil surrounding the central column of the E stack, fed with a current 2 A (Figure 4).

The type of stacking shown in Figure 3 determines the distribution of the magnetic flux in the core. If all the E-I laminations have the same configuration, using a butt joint stack where all the z-cross sections are equal, the distribution of the magnetic flux in each one of these laminations, neglecting the end effects, is the same.

If the butt joint lapping method is used, a 2D analytical model based on lumped reluctances, shown in Figure

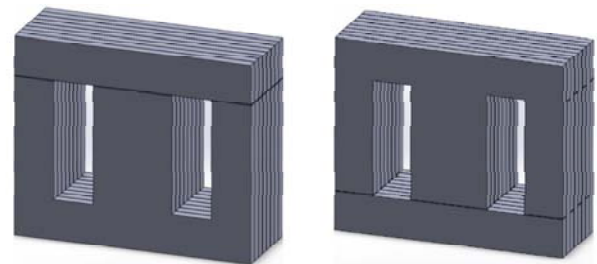

Figure 2: Lapping method of E-I laminated core using butt joint (left) and alternate-lap (right)

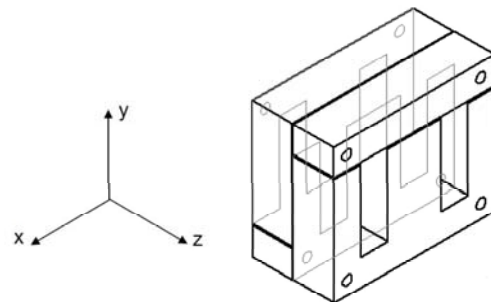

Figure 3: Simplified model of a laminated E-I core, with 2 laminations, using the alternate-lap joint lapping method

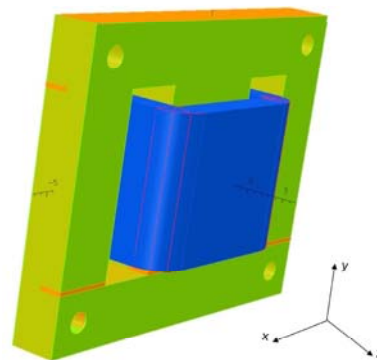

Figure 4: 3D model of the core of Figure 3

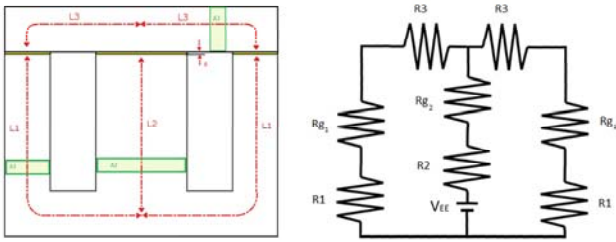

Figure 5: 2D reluctance model of the core of Figure 3

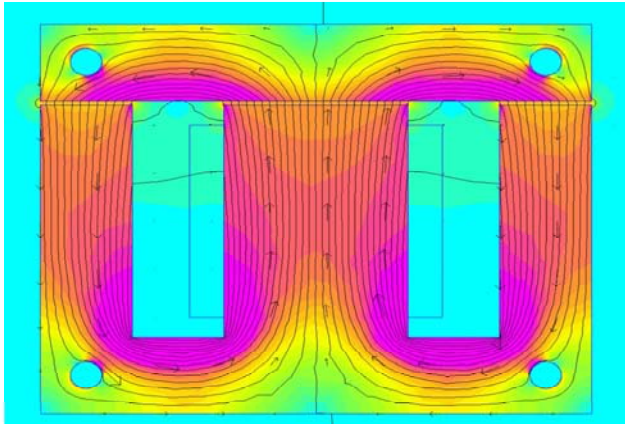

Figure 6: 2D FEM model of the core of Figure 3

5, or a 2D FEM model, shown in Figure 6, can be used to analyze the magnetic flux distribution in the laminated E-I core. In the analytical model, the constructive air-gaps in the joints between the E and I pieces are introduced as added reluctances, R_g

$$R_g = \frac{1}{\mu_0} \frac{g}{S_g} \tag{1}$$

where g is airgap length, S_g is the total cross section of the columns of the E pieces, and μ_0 is the permeability of the vacuum. In the FEM model, these airgaps are directly introduced as a layer of air between the E and I pieces.

Both models assume that the E-I configuration is constant in the z -direction, that is, they assume that the laminated E-I core is a butt joint stack. In fact, it is not possible to simulate the 3D inter-laminations fluxes of the alternate-lap joint method using a 2D model. In this case, the flux has an alternative path of lower reluctance in parallel with each joint between an I piece and an E piece. So, instead of crossing the E-I junction airgap, the magnetic field lines jump to adjacent laminations through the insulation layer, in the z -direction, which implies that a 3D model is necessary to capture this non-uniform distribution of the magnetic flux. This alternative path has a reluctance given by

$$R_g = \frac{1}{\mu_0} \frac{\delta_s}{S_A} \tag{2}$$

where δ_s is the separation between two adjacent laminations, and S_A is the surface of contact between them (see Figure 7).

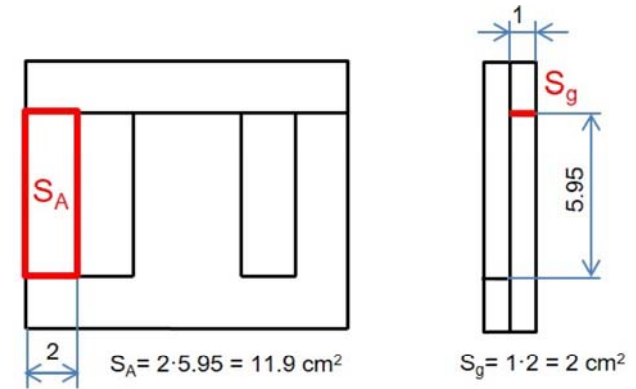

Figure 7: Surface of the contact area between adjacent laminations (S_A), and surface of the contact area at the E-I junction airgap (S_g)

It can be seen in Figure 7 that the reluctance of the path that crosses the insulation between adjacent laminations is much lower than the path that crosses the E-I junction, because the area of this alternative path is much greater than the area of the E-I junction airgap. In fact, the flux preferably flows through the adjacent laminations, which have the largest contact surface, and does not flow through the air gap existing between the E and I pieces. This fact is illustrated in Figure 8, using a 3D reluctance model of the core of Figure 3, and in Figure 9, using a 3D FEM model of the same core.

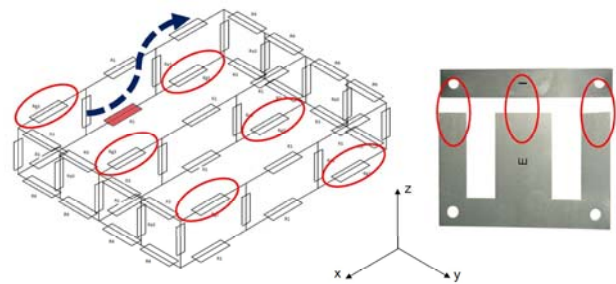

Figure 8: 3D reluctance model of the core of Figure 3

From Figure 8 and Figure 9 it can be concluded that the assumption of uniformity of the flux distribution in the z -direction is no longer valid when using an alternate-lap joint stack, which interchanges the relative positions of the E-I pieces in consecutive laminations. In this case the magnetic flux is not uniformly distributed, as assumed in 2D simulations. Indeed, there is a inter-lamination flux in the

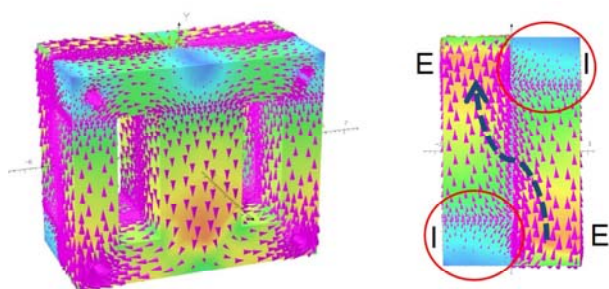

Figure 9: 3D FEM model of of the core of Figure 3

z axis nearby the E-I joints, which highly reduces the magnetic flux density in the I pieces, as can be seen clearly in Figure 9. This results in the I pieces being practically unloaded, and the presence in the E pieces of highly saturated points.

2.1 Comparison of a 3D FEM model of the laminated E-I core using butt joint and alternate-lap joint lapping methods

To evaluate numerically the effect of the lapping method on the average value of the magnetic flux density in the laminated E-I core, a 3D FEM simulation has been made using the two cores displayed in 2, one with a butt joint stack (Figure 2, right), and the other one with an alternate-lap joint stack (Figure 2, left). From these simulations, the average value of the magnetic flux density in each core has been computed, and the results are presented in Table 1.

Table 1: Average value of the magnetic flux density in the laminated E-I core as a function of the lapping method.

Laminated E-I core lapping method	Average value of the magnetic flux density in the core (Tesla)
Butt joint	0.6 T
Alternate-lap joint	1.361 T

That is, the change of the lapping method of the laminated E-I core from a butt joint to an alternate-lap joint method produces a reduction of the effective section of the magnetic core of about 44%, for the core used in this work. In Figure 10 the inter-lamination fluxes in the z-direction are clearly visible for the alternate-lap joint stack, and also their main effect: the unloading of the I piece in each lamination due to the jump of the main flux from one E-piece to the adjacent E-pieces, avoiding the crossing of the high reluctance E-I junction airgap.

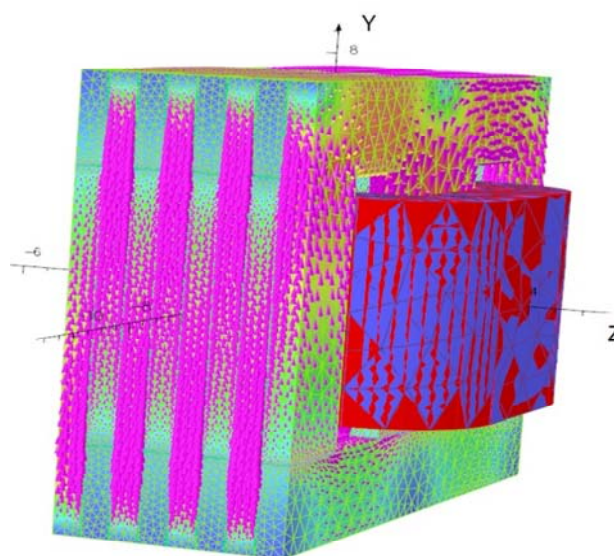

Figure 10: 3D FEM model of the laminated E-I core of Figure 3 with 8 laminations, using an alternate-lap joint lapping method, showing the inter-lamination zig-zag fluxes in the z-direction

3 Sensitivity analysis

Building a 3D model of the laminated E-I core with an alternate-lap joint is a demanding task, both in terms of computing power and time of simulation. Laminated E-I cores can have a great number of laminations (500 in the prototype used in this work), separated by thin insulation layers, so that the number of DOFs of a full 3D FEM model scales exponentially with the number of laminations, and makes the problem nearly intractable with modern software and computer resources.

To evaluate the computational costs required in terms of total number of DOFs and computation time, five different laminated E-I cores have been simulated, with 4, 8, 12, 16 and 20 laminations, as shown in Figure 11, using the computer and software whose main features appear in the Appendix.

The computational resources needed for each model (number of DOFs and simulation time) are presented in Table 2. It can be concluded from the results presented in Table 2 that building a model of a laminated E-I core with a large number of laminations is not viable, because it takes large simulation times without improving the precision.

Some of the simulations whose results have been collected in Table 2 are presented in Figure 12 (model with 4 laminations), in Figure 13 (model with 8 laminations), and in Figure 14 (model with 20 laminations).

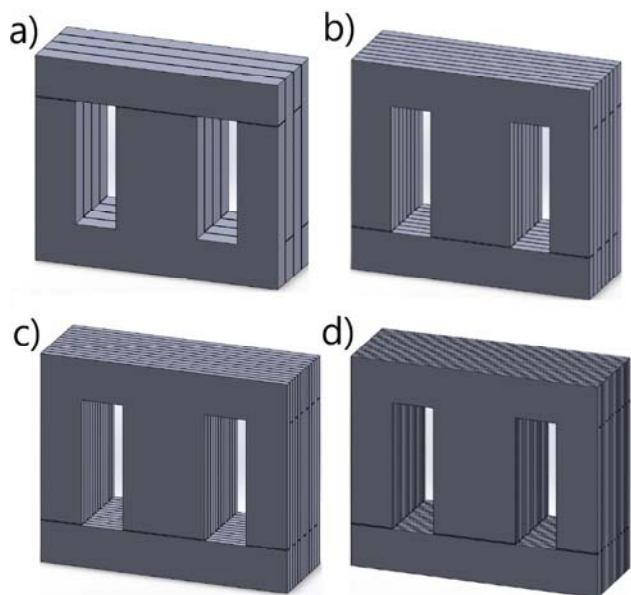

Figure 11: Laminated E-I cores simulated with 4 (a), 8 (b), 12 (c) and 16 (d) laminations, with alternate-lap joint stacking

Table 2: Computational resources needed as a function of the number of laminations included in the model.

Number of Laminations	DOFs	Simulation Time	Average Induction
4	80746	25m	1.41T
8	346802	1h 30m	1.361T
12	812256	10h	1.357T
16	1029067	16h	1.355T
20	1252067	>30h	1.355T

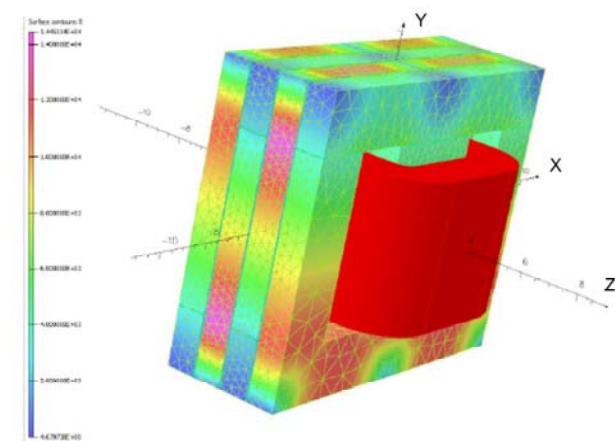

Figure 12: Results of the simulation of the model with 4 laminations

Another factor which makes it necessary to increase the number of laminations in the simulation are the border effects. The distribution of the flux in the outer laminations

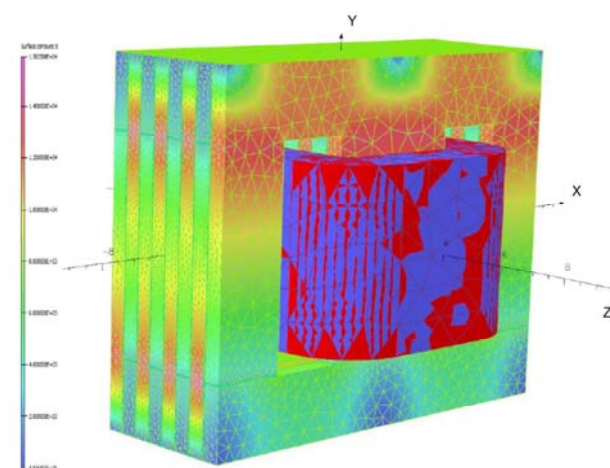

Figure 13: Results of the simulation of the model with 8 laminations

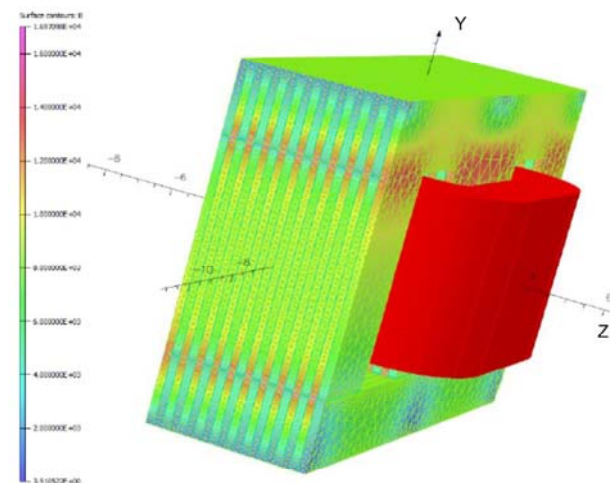

Figure 14: Results of the simulation of the model with 20 laminations

is different than in the inner ones, because the outer laminations have only one adjacent sheet, contrary to the inner laminations, which have two adjacent ones. The influence of this asymmetry on the average value of the induction decreases as the number of iron sheets increases. Figure 15 shows the differences between the outer and the inner E-pieces in the case of a laminated E-I core with 4 laminations and with 20 laminations, respectively.

4 Experimental validation

A prototype, shown in Figure 16, has been built and tested in the laboratory, using a laminated E-I core with an alternate-lap joint stack. Three search coils have been

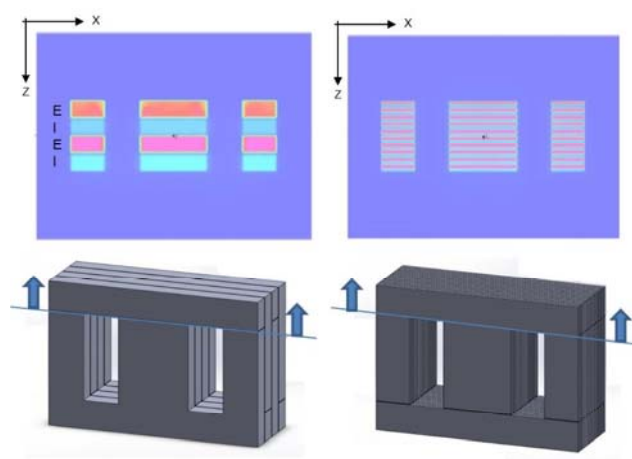

Figure 15: Border effects in the 3D model: the outer E-pieces have a different flux distribution than the inner E-pieces. This effect is more intense in a core simulated with 4 laminations (left) than in a core simulated with 20 laminations (right)

placed in the core, as shown in Figure 16. Two of the search coils have been wound around one column of the E-pieces (E sup coil and E inf coil), and the other one around the I-pieces (I coil). The voltages induced by the magnetic flux in these three search coils has been recorded. These voltages are represented in Figure 17, in order to assess the presence of the inter-lamination fluxes in the z-direction observed in the 3D FEM simulations of Section 2 and Section 3.

The voltages measured at the three search coils of Figure 16, displayed in Figure 17, show clearly the reduced value of the voltage in the I-pieces, compared with the E-pieces, due to the flux crossing between adjacent E pieces to avoid the E-I junction airgap. These results corroborate the results obtained with the 3D simulations presented in previous sections, indicating that in laminated E-I cores with alternate-lap joint stack, the I-pieces are practically unloaded from a magnetic point of view, which represents a reduction of the effective core section.

5 Conclusions

In this paper the effect of the lamination in E-I cores with alternate-lap joint stack is analyzed using 3D FEM simulations and experimental validations. As it is shown in this paper, this particular configuration gives rise to inter-lamination magnetic fluxes crossing the space between adjacent E-pieces, instead of crossing the E-I junction airgap. The consequences of these fluxes is that the I-pieces are magnetically unloaded, and that the average value of

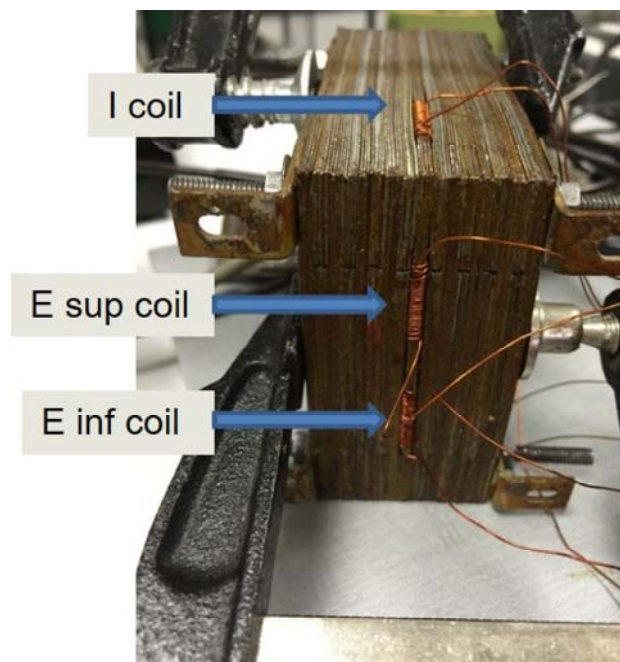

Figure 16: Prototype with laminated E-I core, alternate-lap joint stack, 20 laminations, used for the verification of the experimental results, with the corresponding search coils

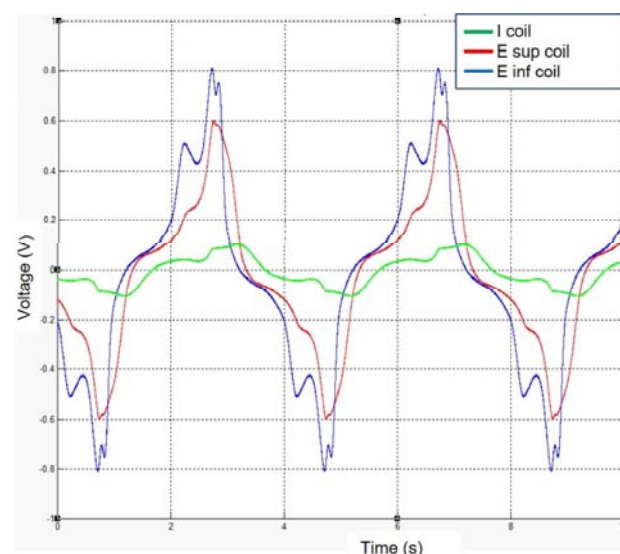

Figure 17: Voltages measured at the three search coils of the prototype. The low voltage measured in the coil wound around the stack of I-pieces shows that it is magnetically unloaded

the magnetic flux density in the core increases. This effect must be taken into account in the design of the laminated E-I cores to reduce the losses and the saturations in particular regions of the core, and also to optimize the amount of magnetic material used to build it.

Computer features: CPU: Intel Core i7-2600K CPU 3.07Ghz, RAM memory: 8 GB, OS 64 bits, SSD 850 EVO 250 GB Disk, Graphics Card: NVIDIA GeForce 210, 3D FEA software: Opera 18R2 x64, 2D FEA software: FEMM 4.3.

Acknowledgement: This work was supported by the Spanish "Ministerio de Economía y Competitividad" in the framework of the "Programa Estatal de Investigación, Desarrollo e Innovación Orientada a los Retos de la Sociedad" (project reference DPI2014-60881-R).

References

- [1] Liu X., Yang Y., Yang F., Jadoon A., Numerical research on the losses characteristic and hot-spot temperature of laminated core joints in transformer, *Appl. Therm. Eng.*, 2017, 110(Supplement C), 49 – 61.
- [2] Du Y., Cheng Z., Zhao Z., Fan Y., Liu L, Zhang J. et al., Magnetic Flux and Iron Loss Modeling at Laminated Core Joints in Power Transformers, *IEEE T. Appl. Supercon.*, 2010, 20(3), 1878–1882 .
- [3] Loizos G., Kefalas T. D., Kladas A. G., Souflaris A. T., Flux Distribution Analysis in Three-Phase Si-Fe Wound Transformer Cores, *IEEE T. Magn.*, 2010, 46(2), 594–597.
- [4] Maizana D., Ahmad M., Evaluation of the localised loss transformer core lamination, *Journal of Applied Sciences*, 2010, 10(22), 2917–2922.
- [5] Sakamoto Y., Natsusaka M., Murakami K., A laminated core type parametric induction motor, *IEEE T. Magn.*, 1997, 33(5), 4185–4187.
- [6] Lee K., Hong J., Lee K. W., Lee S. B., Wiedenbrug E. J., A Stator-Core Quality-Assessment Technique for Inverter-Fed Induction Machines, *IEEE T. Ind. Appl.*, 2010, 46(1), 213–221.
- [7] Pan D., Ruan X., Bao C., Li W., Wang X., Magnetic Integration of the LCL Filter in Grid-Connected Inverters, *IEEE T. Power Electr.*, 2014, 29(4), 1573–1578.
- [8] Lim S. H., Kim Y. P., Ko S. C., Effect of Peak Current Limiting in Series-Connection SFCL With Two Magnetically Coupled Circuits Using E-I Core. *IEEE T. Appl. Supercon.*, 2016, 26(3), 1–4.
- [9] De Nardo A., Di Capua G., Femia N., Transformer Design for Isolated Switching Converters Based on Geometric Form Factors of Magnetic Cores, *IEEE T. Ind. Electron.*, 2013, 60(6), 2158–2166.
- [10] Perdigão M. S., Menke M. F., Seidel A. R., Pinto R. A., Alonso J. M., A Review on Variable Inductors and Variable Transformers: Applications to Lighting Drivers, *IEEE T. Ind. Appl.*, 2016, 52(1), 531–547.
- [11] Mohammed A. M., Cox T., Galea M., Gerada C., A New Method for Determining the Magnetic Properties of Solid Materials Employed in Unconventional Magnetic Circuits, *IEEE T. Ind. Electron.*, 2017, 64(3), 2468–2475.
- [12] Hernandez I., Olivares-Galvan J. C., Georgilakis P. S., Cañedo J. M., Core loss and excitation current model for wound core distribution transformers, *Int. T. Electr. Energy*, 2014, 24(1), 30–42.
- [13] Amoiralis E. I., Tsili M. A., Kladas A. G., Transformer Design and Optimization: A Literature Survey, *IEEE T. Power Deliver.*, 2009, 24(4), 1999–2024.
- [14] Avila-Rosales J., Semlyen A., Iron Core Modeling For Electrical Transients, *IEEE T. Power Ap. Syst.*, 1985, PAS-104(11), 3189–3194.
- [15] Giacoletto L., Proposal for metric standardized scrapless E-I laminations, *IEEE T. Magn.*, 1978, 14(5), 1059–1061.
- [16] Hayakawa Y., Imamura T., Hirashima K., Newly Developed Grain-Oriented Electrical Steel with Good Punchability Suitable for EI Cores, *Kawasaki Steel Giho*, 2003, 35(1), 11–15.
- [17] Poveda-Lerma A., Serrano-Callergues G., Riera-Guasp M., Pineda-Sanchez M., Puche-Panadero R., Perez-Cruz J., 3D simulation of a power transformer considering lamination effects, In: *Proceedings of 18th International Symposium on Electromagnetic Fields in Mechatronics, Electrical and Electronic Engineering (ISEF)* (14-16 Sept. 2017, Lodz, Poland), 2017, 1–2.
- [18] Charap S., Judd F., A core loss model for laminated transformers, *IEEE T. Magn.*, 1974, 10(3), 678–681.