



**STUDY OF THE INTERFERENCE OF NATURAL  
ORGANIC MATTER IN THE REMOVAL OF STEROID  
HORMONES BY ULTRAFILTRATION-NANOPARTICLE  
COMPOSITE MEMBRANES (UF-SWCNT<sub>s</sub>)**

Master Thesis

by

B. Sc. Rubén Hervás

Membrane Technology Department – Institute of Functional Interfaces  
(IFG-MT)

Department of Chemical and Process Engineering (CIW)  
Karlsruhe Institute of Technology (KIT)

Supervisor: Prof. Dr.-Ing. Andrea Iris Schäfer

Co-supervisor: M.Sc. Minh Nhat Nguyen



**Period of work: from 1 February 2019 to 31 July 2019**

Supervisor: Prof. Dr.-Ing Andrea Iris Schäfer

Co-Supervisor: M.Sc. Minh Nhat Nguyen

Declaration:

Herewith I declare that this thesis is the result of my independent work. All sources and auxiliary materials used by me in this thesis are cited completely. This work is part of a PhD thesis.

Karlsruhe, 31 July 2019:



## **Acknowledgments**

First of all, I would like to thank Prof. Dr.-Ing. Andrea Iris Schäfer not only for giving me the opportunity to work in a highly interesting topic within a top research group equipped with extraordinary facilities and technical resources, but also for the dedication, supervision and the knowledge she has kindly taught me.

Secondly, I would like to thank M. Sc. Minh Nhat Nguyen for his invaluable help these 6 months of intense work and his continued effort of supervision. Thank you for guiding me through the experimental methods, for the extensive discussions about my project, for helping me to solve the problems and for your advice and extensive support.

I would also like to thank all the group members of the membrane technology department for teaching me valuable knowledge needed in the research environment as well as for sharing their experiences with me in these 6 months period. Special thanks to M. Sc. Prantik Samanta for his advices, his help and for making me enjoy this period. Thanks to M. Sc. Phuong Bich Trinh for introducing and helping me with the filtration system and to M. Sc. Matteo Tagliavini for preparing to me the hormones solutions and introducing me to the LSC operation.

Thanks to my family who have made it possible for me to get so far, always supporting me in my life, my studies and in the new challenges that arise, despite the distance and the difficulties.

Nerea, thank you for always being there for me, thank you for your support, your trust and for making me extraordinarily happy.

Finally, I want to thank Adrian for sharing this experience with me. These 6 months would not have been the same without his support. Thank you for being an excellent roommate and a great friend.



## **ABSTRACT**

Carbon nanoparticles (CNPs) can efficiently adsorb Endocrine Disrupting Compounds (EDCs), such as steroid hormones (above 60% removal efficiencies). However, Natural Organic Matter (NOM), one of the most common compounds in natural water and one of the main sources of pollution, can interact with CNPs, reducing the adsorption efficiency of CNPs for EDCs. This is one of the main challenges in the use of CNPs in the removal of water micropollutants (MP). In order to remove steroid hormones and avoid the interaction of NOM with CNPs, novel UF-SWCNTs composite membranes have been evaluated in this study. These composite membranes can alleviate NOM interactions with carbon nanoparticles, shielding CNPs from NOM. To evaluate the effective shielding of UF-SWCNTs membranes, different NOM surrogate compounds have been investigated. It has been demonstrated that tannic acid, due to its chemical properties, has a high interference in the adsorption of steroid hormones in CNPs (reducing it by more than 30%). Different UF-SWCNTs membranes were used, showing the capacity of shielding CNPs from NOM. In this case, the interference of tannic acid was prevented, reducing its interference with CNPs until obtaining an Estradiol (E2) removal of 50% in the presence of tannic acid. Finally, the characterization of NOM surrogate compounds as well as the evaluation of the adsorption of different hormones by CNPs have been also examined in detail.

### **Graphical Abstract:**

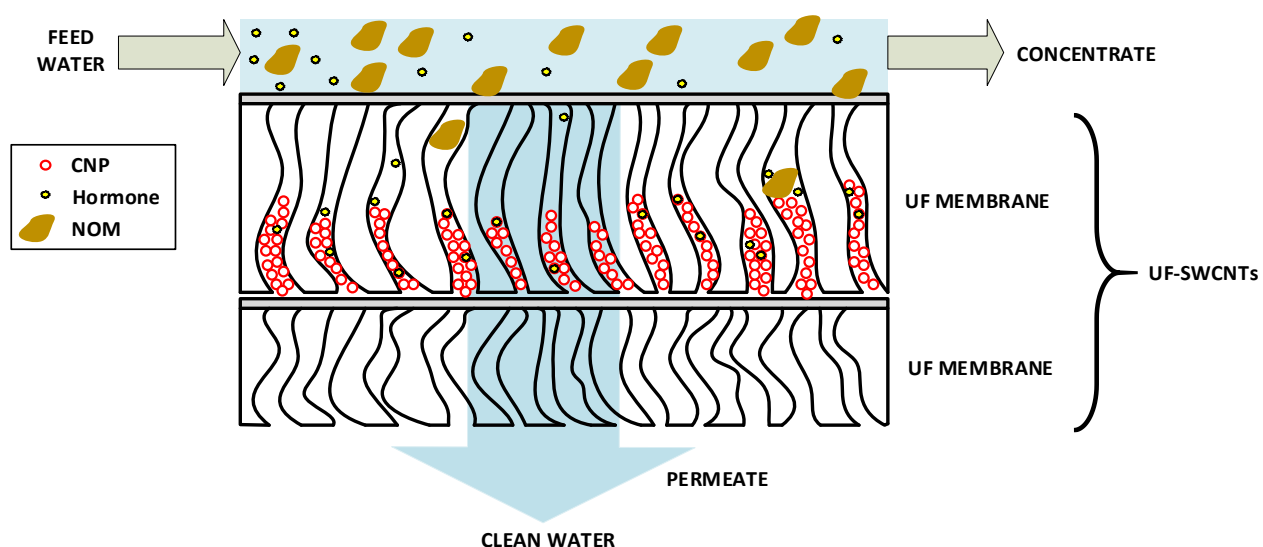





## Index of Contents

Acknowledgments.....	ii
ABSTRACT.....	iv
Graphical Abstract:.....	iv
I. LIST OF ABBREVIATIONS.....	xvi
II. LIST OF SYMBOLS.....	xviii
CHAPTER 1. INTRODUCTION .....	2
1.1    Motivation.....	2
1.2    Research aims.....	3
1.3    Thesis organization.....	3
CHAPTER 2. THEORETICAL BACKGROUND .....	4
2.1    Endocrine disrupting compounds (EDCs).....	4
2.1.1. <i>Definition, classification, origin and effects.</i> .....	4
2.1.2. <i>Steroid hormones</i> .....	7
2.1.3. <i>Removal of EDCs in water</i> .....	9
2.2    Carbon nanoparticles (CNPs).....	11
2.2.1. <i>Single-walled carbon nanotubes (SWCNTs): Definition and properties</i> .....	11
2.2.2. <i>CNPs in water treatment</i> .....	12
2.3    Natural organic matter (NOM).....	13
2.2.3. <i>Definition and classification</i> .....	13
2.2.4. <i>NOM characterization methods</i> .....	14
2.2.5. <i>Surrogate of NOMs</i> .....	16
2.2.6. <i>Adsorption of NOM by CNPs</i> .....	18
2.2.7. <i>Interactions between NOM and steroid hormones</i> .....	19
2.4    Ultrafiltration (UF).....	20
2.2.8. <i>Basic principles of Ultrafiltration</i> .....	20
2.2.9. <i>UF operation parameters</i> .....	21
CHAPTER 3. OBJECTIVES.....	24
CHAPTER 4. MATERIALS AND METHODS .....	26
4.1    Chemicals .....	26
4.1.1. <i>Carbon nanoparticles (CNPs)</i> .....	26
4.1.2. <i>Natural organic matter (NOM)</i> .....	26
4.1.3. <i>Hormones</i> .....	27
4.1.4. <i>Other chemicals</i> .....	27
4.1.5. <i>Solution Chemistry</i> .....	28

4.2	Membranes .....	29
4.2.1.	<i>Ultrafiltration membranes</i> .....	29
4.2.2.	<i>Membrane preparation</i> .....	30
4.2.3.	<i>UF-SWCNTs membrane fabrication</i> .....	31
4.3	Filtration system.....	33
4.3.1.	<i>Filtration system overview</i> .....	33
4.3.2.	<i>Filtration protocol</i> .....	35
4.3.3.	<i>Monitored and calculated parameters</i> .....	36
4.4	Analytical methods.....	37
4.4.1.	<i>Liquid chromatography – Organic carbon detector (LC-OCD)</i> .....	39
4.4.2.	<i>Ultraviolet Visible Spectrophotometer (UV)</i> .....	42
4.4.3.	<i>Total organic carbon analyser (TOC)</i> .....	42
4.4.4.	<i>Liquid scintillation counter (LSC)</i> .....	43
4.4.5.	<i>Asymmetric flow field flow fractionation (AF4)</i> .....	44
4.5	Cleaning procedures.....	45
CHAPTER 5. EXPERIMENTAL RESULTS AND DISCUSSION .....		46
5.1	Characterization of Natural Organic Matter (NOM) .....	46
5.1.1.	<i>LC-OCD</i> .....	46
5.1.2.	<i>UV spectrophotometer</i> .....	48
5.1.3.	<i>SUVA (Specific absorption at 254nm)</i> .....	50
5.1.4.	<i>Humidification diagram</i> .....	51
5.2	Hormone removal by UF-SWCNTs membranes .....	53
5.3	Interference of natural organic matter in E2 removal by CNPs .....	54
5.4	Interference of tannic acid in hormone removal by CNPs .....	55
5.5	Effect of flux on E2 removal by UF-SWCNTs .....	57
5.6	Shielding effect of tannic acid by different MWCOs of UF-SWCNTs membranes. ....	59
5.7	Suggested interference mechanism.....	63
CHAPTER 6. CONCLUSIONS AND OUTLOOK .....		64
CHAPTER 7. REFERENCES .....		66
APPENDIX .....		78
A.1	Filtration tests mass balance.....	78
A.2	Filtration tests parameters: Flux and residence time .....	80
A.3	Calibration Curves .....	81
I.	<i>TOC calibration curve</i> .....	81
II.	<i>UV calibration curve</i> .....	81

III.	<i>LSC calibration curve</i> .....	82
IV.	<i>LSC quenching curve</i> .....	82
A.4	LC-OCD results .....	83
A.5	LC-UVD signal .....	85
A.6	FFFF organics signals data .....	85
A.7	Filtration tests data .....	87
▪	<i>Hormone removal tests (E1, E2, P &amp; T)</i> .....	87
▪	<i>E2 removal tests in presence of different NOM</i> .....	89
▪	<i>Hormone removal tests in presence of tannic acid (TA)</i> .....	91
▪	<i>E2 removal tests with different MWCO membranes</i> .....	93
▪	<i>E2 removal tests with 10kDa membrane at different pressures</i> .....	96
A.8	Tannic acid removal at different pressures.....	98
A.9	Additional test .....	99



## Index of figures

Figure 1. Human health effects of EDCs. (Adapted from [13]) .....	5
Figure 2. Hierarchy of EDCs (Adapted from [13]) .....	5
Figure 3. Environmental releases of EDCs. (Adapted from [16]) .....	6
Figure 4. Factors influencing micropollutants rejection. (Adapted from [77]).....	9
Figure 5. A) Idealized representation of defect-free SWNTs with open ends, B) an idealized bundle of nanotubes. In such bundles individual tubes are held together with van der Waals interactions [85]. ....	11
Figure 6. Fractions and chemical groups of NOM. (Adapted from: [132-136]) .....	13
Figure 7. NOM fraction in surface water. (Adapted from: [130]).....	13
Figure 8. Schematic model for the interaction between carbon nanotube (CNT) and tannic acid (TA). 1: TA molecule anchored onto the tube wall with benzene rings binding to the surface carbon rings via $\pi$ - $\pi$ interactions to form a monolayer. 2: The adsorbed TA monolayer sorbed more dissolved TA molecules (multilayer). (From [170]).....	18
Figure 9. Membrane processes (pressure driven membrane) and their separation characteristics. (Adapted from [178]).....	20
Figure 10. Membrane process mode: Dead-end and cross-flow (Adapted from [179]) .....	21
Figure 11. NOM stock solutions (Left to right: Alginate, tannic acid, humic acid, Australian NOM and tea extract) .....	28
Figure 12. Left: Membrane dimensions used for loading CNPs (75 mm). Right: Dimensions of membrane used in the filtration cell (25 mm). .....	30
Figure 13. Membrane cutting tools (From left to right, cutting diameters 75, 25 and 13 mm) .....	30
Figure 14. Assembly schematic used for loading CNPs into UF membranes (10-100 kDa). .....	31
Figure 15. Assembly schematic used for loading CNPs into UF membranes (5 kDa).....	32
Figure 16. Left: 100 kDa UF membrane loaded with 2 g/m <sup>2</sup> CNPs. Right: 100 kDa UF membrane before loading.....	33
Figure 17. Scheme of the filtration system. ....	34
Figure 18. Picture of filtration cell with 100kDa UF-SWCNTs composed membrane. ....	34
Figure 19. Example of the parameters collected in a filtration test. (Data: test with 100 kDa UF-SWCNT, feed E1 100 ng/L and TA 10 mgC/L) .....	36
Figure 20. Scheme of LC-OCD system. (Adapted from [159]) .....	39
Figure 21. Theoretical chromatograph with the different fractions of organic matter detected with LC-OCD. (Adapted from [187]).....	40
Figure 22. LC-OCD chrom and 5 distinctive points (A, B, C, D and E) use by ChromCALC software to calculate characteristics parameters of organics [186].....	41
Figure 23. Different areas of an HS chromatogram calculated by ChromCALC software [186]. ....	41
Figure 24. UV-vis spectrophotometer Lambda 25 (Perkin Elmer) [188]. ....	42
Figure 25. Picture of TOC analyser, Sievers M9 Portable (GE Analytical Instruments).....	43
Figure 26. Picture of LSC, 2550 TR/AB (Packard).....	44
Figure 27. Picture of AF4, AF2000 MultiFlow FFF (Postnova).....	45
Figure 28. Characteristics peaks of humic acid, glucose, tannic acid, alginate, Australian NOM, tea extract and ethanol in LC-OCD, signal response from organic carbon detector (OCD). ....	47
Figure 29. Different response signals for different concentrations for humic acid and glucose in LC-OCD. ....	48
Figure 30. Ultraviolet light absorbance of humic acid, glucose, tannic acid, alginate, Australian NOM, tea extract and ethanol in a wavelength range of 200 to 600 nm. Samples of 20 mgC/L concentration. ....	49
Figure 31. Absorbance of tannic acid at different concentrations (5, 10 and 20 mgC/L) for a wavelength of 190 to 400 nm measured with the UV spectrometer. ....	50
Figure 32. Humidification diagram (SUVA measured with LC-OCD). [133] <sup>1</sup> [166] <sup>2</sup> [159] <sup>3</sup> .....	52
Figure 33. Left: Hormone (E1, E2, T and P) permeate concentration vs permeate volume (feed concentration ~95 ng/L), Right: Hormone (E1, E2, T and P) removal. Filtration test with 100 kDa UF-SWCNTs (2 g/m <sup>2</sup> CNPs, 1 bar).....	53

Figure 34. Left: E2 permeate concentration vs permeate volume (E2 feed concentration ~95 ng/L), Right: E2 removal. Filtration test with 100 kDa UF-SWCNTs (2 g/m<sup>2</sup> CNPs, 1 bar) with different NOM surrogates: HA, TA, Glu, Alg, Aus and Tea (feed concentration 10 mgC/L) and one without NOM (hollow points). .....54

Figure 35. Variation of NOM concentration in E2 filtration test with 100 kDa UF-SWCNTs (2 g/m<sup>2</sup> CNPs, 1 bar). NOM concentration measured with LC-OCD and UV spectrophotometer. ....55

Figure 36. Left: Hormone (E1, E2, T and P) permeate concentration vs permeate volume (feed concentration ~95 ng/L), Right: Hormone (E1, E2, T and P) removal. Filtration test with 100 kDa UF-SWCNTs (2 g/m<sup>2</sup> CNPs, 1 bar) with and without tannic acid (feed concentration 10 mgC/L). .....56

Figure 37. Variation of TA concentration in E1, E2, P & T filtration tests with 100 kDa UF-SWCNTs (2 g/m<sup>2</sup> CNPs, 1 bar). TA concentration measured with UV spectrophotometer. ....57

Figure 38. Left: Permeate concentration of E2 (initial concentration 100 ng/L, with tannic acid (10 mgC/L) and without) in UF-SWCNTs filtration (CNPs 2 g/m<sup>2</sup>, UF Ultracel 10 kDa) at several pressures (0.5, 1, 2, 3 & 4 bar). Right: Fluxes associated with different pressures vs. E2 removal. ....58

Figure 39. E2 permeate concentration and mass adsorbed in UF-SWCNTs filtration (CNPs 2 g/m<sup>2</sup>, UF Ultracel 10 kDa) at several pressures (0.5, 1, 2, 3 & 4 bar) versus the residence time.....58

Figure 40. Left: E2 removal in UF-SWCNTs filtration tests (CNPs 2 g/m<sup>2</sup>, UF Ultracel 5, 10, 30 and 100 kDa) with and without tannic acid (10 mgC/L). Right: Residence time of filtration tests with different MWCO membranes (5, 10, 30 and 100 kDa) with and without tannic acid (10 mgC/L). ....59

Figure 41. Left: Permeate concentration of E2 (initial concentration 100 ng/L, with tannic acid (10 mgC/L) and without) in UF-SWCNTs filtration (CNPs 2g/m<sup>2</sup>, UF Ultracel 5, 10, 30 and 100 kDa). Right: Permeate concentration of TA for membranes of 5, 10, 30 and 100 kDa.....61

Figure 42. 1) Expected adsorption of steroid hormones in SWCNTs. 2) In the presence of interfering NOM two suggested mechanisms: Hormone-NOM reducing adsorption in SWCNTs and NOM-SWCNTs blocking adsorption sites. 3) Effect of UF membranes shielding, blocking NOM.....63

Figure 43. TOC calibration curve with TOC standards (0.25, 0.5, 1, 2 & 5 mgC/L) .....81

Figure 44. UV calibration curve for tannic acid (At fix wavelength of 213 nm).....81

Figure 45. LSC calibration curve for different hormone (E1, E2, P and T).....82

Figure 46. LSC quenching curve in presence of tannic acid (5mgC/L).....82

Figure 47. Samples of E2 filtration test with sodium alginate (feed concentration: 10 mgC/L) with 100 kDa UF-SWCNTs (2 g/m<sup>2</sup> CNPs, 1 bar) analysed with LC-OCD.....83

Figure 48. Samples of E2 filtration test with glucose (feed concentration: 10 mgC/L) with 100 kDa UF-SWCNTs (2 g/m<sup>2</sup> CNPs, 1 bar) analysed with LC-OCD.....83

Figure 49. Samples of E2 filtration test with Australian NOM (feed concentration: 10 mgC/L) with 100 kDa UF-SWCNTs (2 g/m<sup>2</sup> CNPs, 1 bar) analysed with LC-OCD.....84

Figure 50. Samples of E2 filtration test with Tea extract (feed concentration: 10 mgC/L) with 100 kDa UF-SWCNTs (2 g/m<sup>2</sup> CNPs, 1 bar) analysed with LC-OCD.....84

Figure 51. Samples of E2 filtration test with Tea extract (feed concentration: 10 mgC/L) with 100 kDa UF-SWCNTs (2 g/m<sup>2</sup> CNPs, 1 bar) analysed with LC-OCD.....85

Figure 52. Signal response of different NOMs measured by Ultraviolet detector (LC-UVD) at 254 nm wavelength. ....85

Figure 53. Signal response and elution time of humic acid measured by FFFF.....86

Figure 54. Signal response and elution time of Australian NOM measured by FFFF.....86

Figure 55. Signal response and elution time of tea extract measured by FFFF. ....87

Figure 56. Data: E1 filtration test with 100kDa UF-SWCNT, feed 100 ng/L.....87

Figure 57. Data: E2 filtration test with 100kDa UF-SWCNT, feed 100 ng/L.....88

Figure 58. Data: Progesterone filtration test with 100kDa UF-SWCNT, feed 100 ng/L.....88

Figure 59. Data: Testosterone filtration test with 100kDa UF-SWCNT, feed 100 ng/L.....89

Figure 60. Data: E2 filtration test with 100kDa UF-SWCNT, feed 100 ng/L and glucose 10 mgC/L. ....89

Figure 61. Data: E2 filtration test with 100kDa UF-SWCNT, feed 100 ng/L and alginate 10 mgC/L. ....90

Figure 62. Data: E2 filtration test with 100kDa UF-SWCNT, feed 100 ng/L and tea extract 10 mgC/L.....90

Figure 63. Data: E2 filtration test with 100kDa UF-SWCNT, feed 100 ng/L and humic acid 10 mgC/L.....91

Figure 64. Data: E2 filtration test with 100kDa UF-SWCNT, feed 100 ng/L and tannic acid 10 mgC/L.....91

*Study of the interference of natural organic matter in the removal of steroid hormones by ultrafiltration-nanoparticle composite membranes (UF-SWCNTs)*

Figure 65. Data: E1 filtration test with 100kDa UF-SWCNT, feed 100 ng/L and TA 10 mgC/L. ....92

Figure 66. Data: Testosterone filtration test with 100kDa UF-SWCNT, feed 100 ng/L and TA 10 mgC/L. .92

Figure 67. Data: Progesterone filtration test with 100kDa UF-SWCNT, feed 100 ng/L and TA 10 mgC/L..93

Figure 68. Data: E2 filtration test with 30kDa UF-SWCNT, feed 100 ng/L.....93

Figure 69. Data: E2 filtration test with 30kDa UF-SWCNT, feed 100 ng/L with TA 10 mg/L. ....94

Figure 70. Data: E2 filtration test with 10kDa UF-SWCNT, feed 100 ng/L.....94

Figure 71. Data: E2 filtration test with 10kDa UF-SWCNT, feed 100 ng/L with TA 10 mg/L. ....95

Figure 72. Data: E2 filtration test with 5kDa UF-SWCNT, feed 100 ng/L.....95

Figure 73. Data: E2 filtration test with 5kDa UF-SWCNT, feed 100 ng/L with TA 10 mg/L. ....96

Figure 74. Data: E2 filtration test with 10kDa UF-SWCNT at 0.5 bar, feed 100 ng/L with TA 10 mg/L.....96

Figure 75. Data: E2 filtration test with 10kDa UF-SWCNT at 1 bar, feed 100 ng/L with TA 10 mg/L.....97

Figure 76. Data: E2 filtration test with 10kDa UF-SWCNT at 2 bar, feed 100 ng/L with TA 10 mg/L.....97

Figure 77. Data: E2 filtration test with 10kDa UF-SWCNT at 3 bar, feed 100 ng/L with TA 10 mg/L.....98

Figure 78. Data: E2 filtration test with 10kDa UF-SWCNT at 4 bar, feed 100 ng/L with TA 10 mg/L.....98

Figure 79. Tannic acid removal (initial concentration 10 mgC/L) UF-SWCNTs filtration (E2 100 g/L, CNPs 2g/m<sup>2</sup>, UF Ultracel 10 kDa) at different pressures (0.5, 1, 2, 3 and 4 bar). ....99

Figure 80. Permeate concentration of E2 (initial concentration 100 ng/L) with and without humic acid (10 mgC/L) in UF-SWCNTs filtration (CNPs 2g/m<sup>2</sup>, UF Ultracel 10 kDa). ....99





## Index of tables

Table 1. Characteristics of steroid hormones used in this study (Adapted from [40]).....	8
Table 2. Overview of different treatment processes for micropollutants removal. (Adapted from [29])...	10
Table 3. Main features of the techniques selected in this study. (Adapted from [151]).....	16
Table 4. Characteristics of natural organics surrogates compounds selected in this study. ....	17
Table 5. Nanoparticle properties .....	26
Table 6. Compounds used as surrogate natural organic matter .....	27
Table 7. Other chemicals used.....	27
Table 8. Membrane characteristics .....	29
Table 9. Parameters measured after filtration experiments. ....	36
Table 10. Summary of analytical methods used (Purpose, results, advantages and disadvantages are only applied for this study). ....	38
Table 11. NOM chromatographic analysis results (LC-OCD) .....	46
Table 12. SUVA values obtained by two different UV/TOC and LC-OCD methods.....	51
Table 13. Hormone concentration in feed and retentate samples (LSC analysis) and mass balance of filtration test with different hormones, with and without tannic acid (10 mgC/L). ....	78
Table 14. Hormone concentration in feed and retentate samples (LSC analysis) and mass balance of E2 filtration test with different NOMs (10 mgC/L). ....	78
Table 15. Hormone concentration in feed and retentate samples (LSC analysis) and mass balance of E2 filtration test with different MWCO membranes, with and without tannic acid (10 mgC/L). ....	79
Table 16. Hormone concentration in feed and retentate samples (LSC analysis) and mass balance of E2 filtration test at different pressures in presence of tannic acid (10 mgC/L). ....	79
Table 17. Flux and residence time of E2 filtration experiments with different MWCO membranes (100, 30, 10 and 5kDa, Ultracel).....	80
Table 18. Flux and residence time of E2 filtration experiments in presence of tannic acid (10 mgC/L) with different MWCO membranes (100, 30, 10 and 5kDa, Ultracel).....	80
Table 19. Flux and residence time of E2 filtration experiments in presence of tannic acid (10 mgC/L) with 10kDa membrane (Ultracel) at different operation pressures (0.5, 1, 2, 3 and 4 bar).....	80



## **I. LIST OF ABBREVIATIONS**

ALG	Alginate
AUS	Australian NOM
AOPs	Advanced oxidation processes
CNT	Carbon nanotube
CNP	Carbon-based nanoparticle
DOC	Dissolved organic carbon
E1	Estrone
E2	17 $\beta$ -Estradiol
EtOH	Ethanol
GLU	Glucose
HA	Humic acid
HMW	High molecular weight
HS	Humic substances
IC	Inorganic carbon
kDa	Kilo Dalton (1 Da = 1 g/mol)
LC-OCD	Liquid chromatography – organic carbon detector
LMW	Low molecular weight
LPS	Lipopolysaccharides
LSC	Liquid scintillation counter
Milli-Q	Ultrapure water of Type 1 (ISO 3696)
MP	Micropollutants
MW	Molecular weight
MWD	Molecular weight distribution
MWCNT	Multi-walled carbon nanotubes
MWCO	Molecular weight cut-off
NOM	Natural organic matter
OM	Organic matter
OCD	Organic Carbon Detector
OND	Organic nitrogen Detector
P	Progesterone
PWF	Pure water flux
PPCPs	Pharmaceuticals and personal care products
SUVA	Specific ultraviolet absorbance
SWCNT	Single-walled carbon nanotubes
T	Testosterone
TA	Tannic acid
TMP	Transmembrane pressure
TOC	Total organic carbon
UF	Ultrafiltration
UF-SWCNTs	Combination of UF membrane and CNP
UV	Ultraviolet
UVD	Ultraviolet Detector
UV-Vis	Ultraviolet visible spectroscopy



## **II. LIST OF SYMBOLS**

<b>Symbol</b>	<b>Meaning</b>	<b>Unit</b>
$A$	Area	$m^2$
$d$	Diameter	m
$E\%n$	Relative error	%
$f$	Feed	-
$J$	Flux	$L/hm^2$
$L_p$	Permeability	$L/h \cdot m^2 \cdot bar$
$m_i$	Mass of component i	mg; ng
$pKa$	Acid dissociation constant	-
$t$	Time	s; min; h
$T$	Temperature	$^{\circ}C$
$UV_{254}$	Ultraviolet absorbance at wavelenght 254 nm	-
$V$	Volume	L
$\Delta m$	Adsorbed mass	ng
$\zeta$	Zeta potential	mV



## **CHAPTER 1. INTRODUCTION**

### **1.1 Motivation**

The studies on endocrine disrupting compounds (EDCs) and their effects on the environment emerged decades ago [1, 2]. However, the diversity number of compounds, the difficulty in detection and characterization, as well as in demonstrating the impacts of EDCs on human life, had prevented these micropollutants from being in the spotlight until about 15 years ago [3]. With the advancement of analytical techniques, numerous studies have been able to confirm the risk that these compounds pose to animals and human health [4-9]. Within last years, the development in this field have been enormous. Research has been successful in highlighting the health problems associated with these compounds, estimating the origin and sources of contamination, detailing the extensive list of compounds, understanding their most important characteristics, seeking increasingly effective detection methods [10, 11] and focusing research on the control and elimination of these contaminants [12-15].

In 2012, the World Health Organization (WHO) together with the United Nations Environmental Program (UNEP) published an extensive document on the state of the art of endocrine disrupting compounds [16]. This document, which is an update of the first document published in 2002 (IPCS, 2002) [17], brings together all current knowledge about these compounds, the progress made to date and the challenges that need to be achieved. In recent years, governments have begun to take action. Some EDCs have been updated in the US drinking water contaminant list for monitoring [18], and the European Union is identifying the measures needed to reduce their risk [19].

Unfortunately, there is still a long way to go in this field. The most important challenges remain the detection and elimination of these compounds. [20-25]. The elimination of these compounds in conventional wastewater treatment plants (WWTPs) is ineffective because the associated technologies are suitable for removing dirts, microorganisms and natural organic matter from water but not micropollutants [26-29]. Advanced treatment technologies such as nanofiltration (NF), reverse osmosis (RO), advanced oxidation process (AOPs), photocatalysis, adsorption by activated carbon (AC) and novel nanoadsorbents such as carbon nanoparticles (CNPs) or the combination of several technologies are still under evaluation [28, 30-37].

Many factors come into play in the identification of the best technologies to removal emerging pollutants. Factors such as removal efficiency, removal versatility, ease of implementation, environmental impact and economic viability must be taken into account. For all these reasons, clean, robust and affordable membrane are considered a state-of-the-art, which have received increasing scientific attention in recent years. At Membrane Technology Department (IFG-MT) in Karlsruhe Institute of Technology (KIT), one can research on further enhancing the membranes for application in more challenging areas such as micropollutant removal [38-40].

Carbon nanoparticles (CNPs) have been shown to have very promising adsorbent capacities and very high EDCs removal efficiency [41-46]. This technology has advantages such as it does not require large amounts of energy or chemicals. On the other hand, CNPs can affect animals and human health [47, 48], and their release into the environment should be avoided. Another drawback is that as they are strongly adsorbent materials, they have the ability to adsorb other

water components, such as Natural Organic Matter (NOM), which can compete with the adsorption of micropollutants, reducing EDCs removal efficiencies [49-55].

Low energy demand ultrafiltration (UF) membranes have played an important role in conventional and advanced water treatment plants. Apart from the proven benefits of treating water with UF membranes (removal of macropollutants, biological contaminants such as bacteria, viruses etc. [56, 57]). UF membranes can be combined with adsorbents such as activated carbon to remove micropollutants from water [58, 59]. At IFG-MT, ultrafiltration can be combined with single-walled carbon nanotubes (UF-SWCNTs), and in this UF-SWCNT tandem, the membranes protect nanoparticles from interfering water component, and therefore maintaining high micropollutants removal efficiencies by CNPs [60].

In summary, nowadays the importance of research on new methods of removing EDCs in water is a necessity. In this regard, this work serves as a contribution to the knowledge on the removal of hormonal steroids (a class of EDCs) by combining membranes and adsorbents. In addition, it should be pointed out that the materials evaluated in this work (UF-SWCNTs membranes) could be a promising way in this important quest in the water treatment field, which is to obtain high micropollutant removal maintaining a low energy demand.

## **1.2 Research aims**

The main objective of this work is to study the removal of steroid hormones by of the use of novel UF-SWCNTs composite membranes. The goal is to study how natural organic matter can interferes in this removal and how this interference could be avoided with the UF membranes.

## **1.3 Thesis organization**

After this introductory chapter, the second chapter puts the reader into context, compiling the published information four central topics: EDCs, CNPs, NOM and UF. Chapter 3 sets out in more detail the purpose of this work, outlining the research questions and the points that have been followed to answer them. In Chapter 4, the materials used, the equipment, the analytical methods and the most relevant experimental procedures are extensively detailed. The fifth chapter gathers all the results and the discussions derived from them. Chapter 6 contains the most noteworthy conclusions drawn from this thesis and some directions for possible further research. Lastly, after chapter seven, where all the references cited in this thesis can be found, there is an appendix with supplementary information that may be useful for the reader.



## **CHAPTER 2. THEORETICAL BACKGROUND**

*This chapter provides a brief description of endocrine disrupting compounds (EDCs) as micropollutants (MP), followed by a broader description of the steroid hormones used in this study. This section also describes some treatments for the removal of MP, and finally focuses on membrane processes. Subsequently, information is given about carbon nanoparticles (CNPs) and their use in water treatments. The third block comprises natural organic matter (NOM), its main characteristics and some analytical methods, as well as the surrogate compounds of NOM and the interactions that NOM presents with MPs and CNPs. Finally, the last section covers the UF process, providing to the reader some background information on the fundamentals of this process and the most relevant parameters.*

### **2.1 Endocrine disrupting compounds (EDCs)**

#### *2.1.1. Definition, classification, origin and effects.*

Endocrine disrupting compounds are substances that interfere with metabolism, synthesis of hormones and hormone functions, affecting the homeostatic control and reproductive capacities of organisms [4, 61]. The U.S. Environmental Protection Agency (EPA) has defined them as “an agents that interferes with the synthesis, secretion, transport, binding, or elimination of natural hormones in the body that are responsible for the maintenance of homeostasis, reproduction, development and/or behaviour” [25]. In short, endocrine disrupting compounds are substances that interfere in the correct hormonal functioning of organisms.

Because EDCs interact directly with the endocrine system, they can cause suppression or excessive amounts of hormones, resulting in the appearance of [62]:

- i. Infertility;
- ii. Sexual underdevelopment;
- iii. Altered or reduced sexual behaviour;
- iv. Attention deficit or hyperactivity;
- v. Altered thyroid or adrenal cortical function;
- vi. Increased incidents of certain cancers;
- vii. Birth defects, etc.

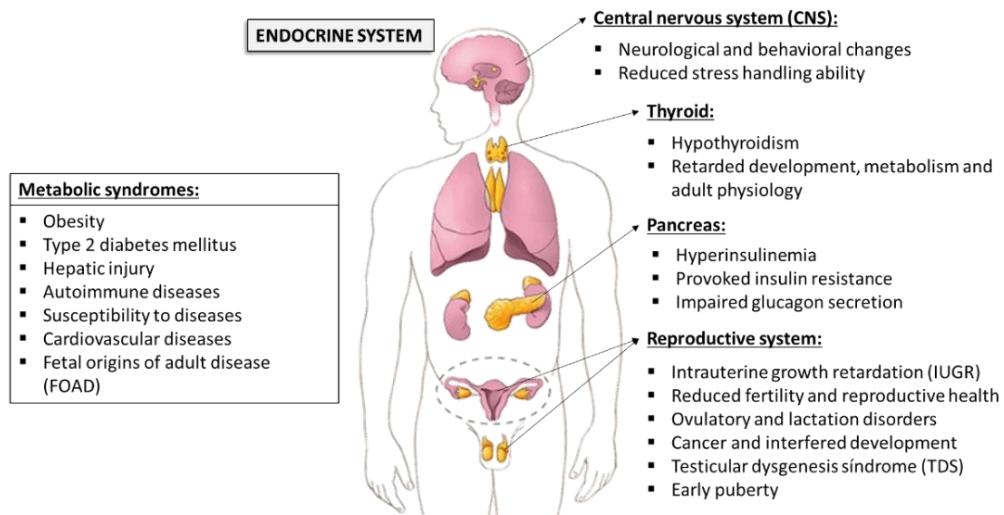

Figure 1. Human health effects of EDCs. (Adapted from [13])

On the other hand, EDCs are found in various materials such as personal care products, additives or contaminants in food, metals and pesticides [61]. They can be classified in 4 groups according to their origins [12]:

- I. **Natural and artificial hormones.**
- II. Drugs with hormonal side effects.
- III. Industrial and household chemicals.
- IV. Side products of industrial and household processes.

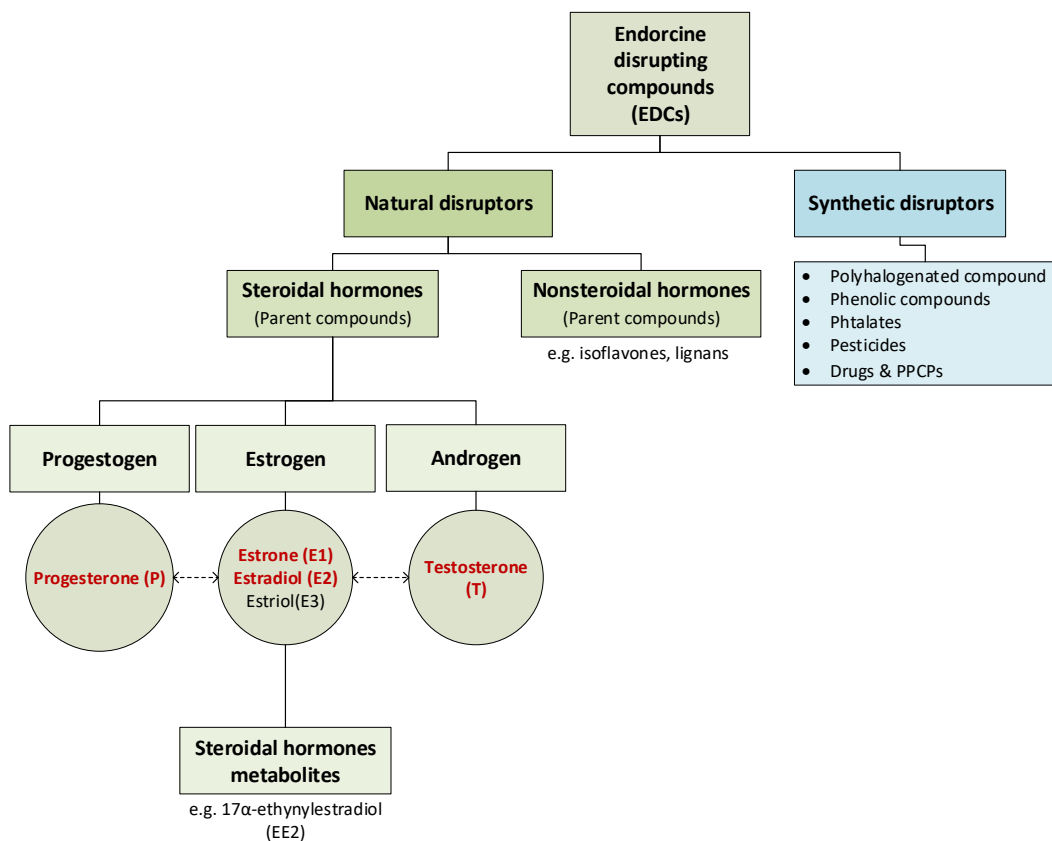
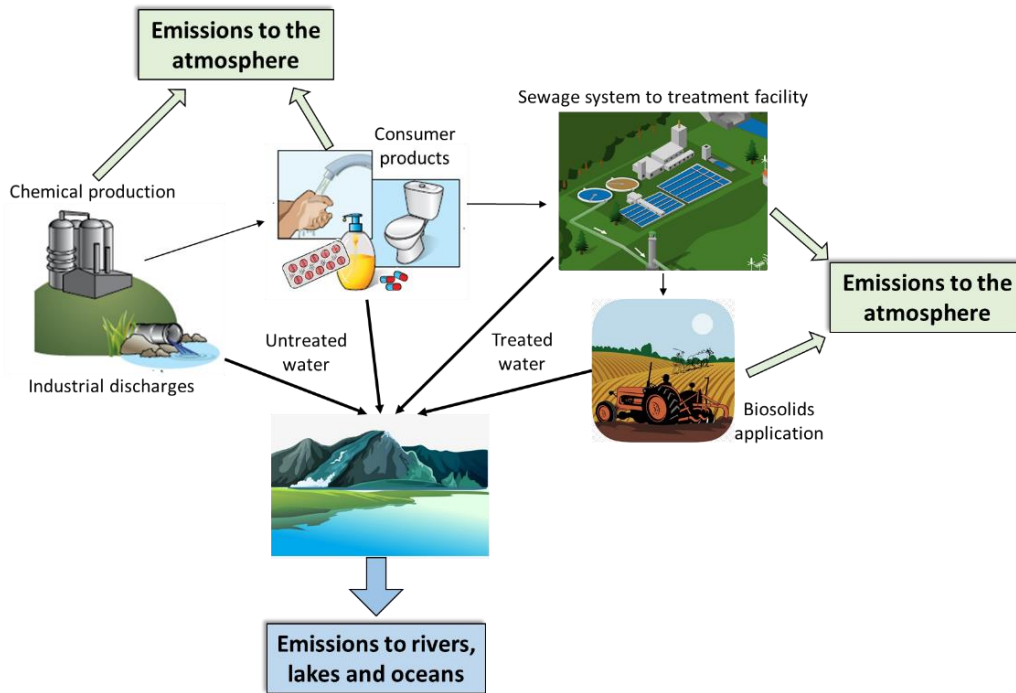

Figure 2. Hierarchy of EDCs (Adapted from [13])

Steroid hormones, which are natural hormones that control the processes of sexual development and reproduction, include estrone (E1), estradiol (E2), estriol (E3), progesterone (P) and testosterone (T) [12]. E1, E2 and E3 are natural estrogens derived from cholesterol and commonly found in excreta of humans and animals. T and P also are steroid hormones manufactured by mammal bodies [40] but with less estrogenic effect [63].

These substances are released into the environment through different routes [64]:

- a. Human, livestock, and other animal excretion at remarkable amounts;
- b. WWTP and STP effluent;
- c. Agricultural runoff from manure and sewage that have been used as fertilize.



*Figure 3. Environmental releases of EDCs. (Adapted from [16])*

This release to the environment causes them to accumulate in aquatic environments, directly affecting aquatic animals and being present in the hydrological cycle of water [65, 66]. Therefore, the detection as well as the removal of these substances are essential for their control and thus, to avoid their effects on living organisms [12].

### 2.1.2. Steroid hormones

This study is based on natural disruptors such as steroidal hormones: estrone (E1), 17 $\beta$ -Estradiol (E2), progesterone (P) and testosterone (T). Since these steroids are naturally produced by the body, they have relatively high potencies to target the endocrine receptors compared with other less specific EDCs [16]. All humans, as well as animals, excrete steroid hormones in different amounts, depending on their age, state of health, diet, or pregnancy [67]. These hormones end up in the environment through sewage discharge and animal waste disposal, being able to find them commonly in wastewater [26]. In addition, it should be noted that steroid hormones have a high potential for bioaccumulation in the environment, so that the effects they cause can be enhanced if not removed effectively [65, 66]. In 2015, European Union has promulgated Decision 2015/495 [68], which restricts the concentration of steroid hormones such as E1 and E2 in waters to 0.4 ng/L, which signifies the importance of complete removal of these steroids.

Steroid hormones, as micropollutants, have chemical and structural characteristics that present a challenge for their removal in aquatic environments [69]. A major difficulty in removing such micropollutants from water is not only the small concentration in which they occur and are physiologically active, but also their small size or molecular weight (MW). The MW of these hormones are very similar, varying between 268 and 315 g/mol [40], impossible to remove by UF membranes by size exclusion. Other parameters to consider are *pKa*, which shows the acid dissociation constant in which hormones lose an H<sup>+</sup> ion and charge negatively, and *log K<sub>ow</sub>*, which measures the hydrophobicity of hormones by partitioning in octanol and water. Generally, compounds with *log K<sub>ow</sub>* > 2.5 are expected to accumulate in solid phases rather than being soluble in the aqueous phase [40]. For steroid hormones, *log K<sub>ow</sub>* values range between 2.8 and 5.1, so these molecules are expected to adsorb easily to hydrophobic materials [70].

Finally, other interesting parameter in this study is the characteristics of the proton and electron donor and acceptor, which can affect the interaction with other molecules or materials. Due to its phenolic structure, these substances are able to form hydrogen bonds (H bonds). H-binding has been attributed to playing a predominant factor in the transport of estrogens in biological systems [40]. In addition, to having aromatic ring in the molecular structure induce the possibility of forming  $\pi - \pi$  intermolecular bonds with other phenyl groups in the adsorbent [40, 71, 72]. This is interesting when studying interactions with other substances, such as natural organic matter, or other adsorbent materials, such as CNPs.

A summary of the most important properties of these substances is shown in Table 1.

Table 1. Characteristics of steroid hormones used in this study (Adapted from [40])

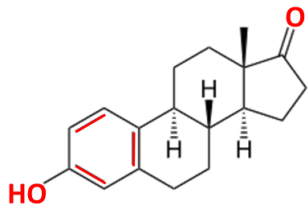
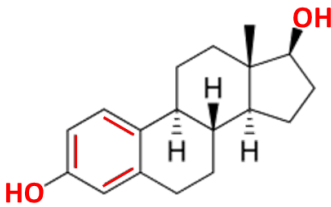
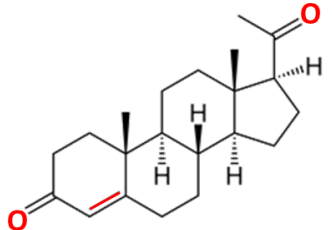
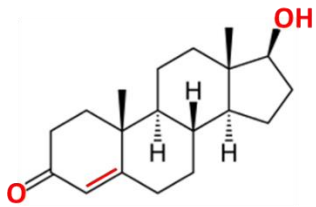
Compound	Estrone (E1)	Estradiol (E2)	Progesterone (P)	Testosterone (T)
Molecular formula	C <sub>18</sub> H <sub>22</sub> O <sub>2</sub>	C <sub>18</sub> H <sub>24</sub> O <sub>2</sub>	C <sub>21</sub> H <sub>30</sub> O <sub>2</sub>	C <sub>19</sub> H <sub>28</sub> O <sub>2</sub>
CAS no.	53-16-7	50-28-2	57-83-0	58-22-0
Structure <sup>1</sup>				
MW (g/mol)	270	272	315	288
Solubility in water (mg/L)	13, 147	3.6, 82	5, 8.8	24, 68
pKa	10.34 [73], 10.77 [74], 10.3 [75]	10.23 [73], 10.71 [74], 10.4 [75]	NA	17.4 [75, 76]
Log Kow	3.13	4.01	3.87	3.32
Dipole moment (debye)	2.1, 3.36	2.2	3.50, 4.58	3.53
H-bond capacity	Strong OH donor and acceptor; Strong O acceptor; π weak acceptor (benzene)	Strong OH donor and acceptor; π weak acceptor (benzene)	Strong O acceptor; π weak acceptor (benzene)	Strong OH donor and acceptor; Strong O acceptor; π weak acceptor (benzene)

<sup>1</sup>Highlighted in red the structural differences between estrogenic hormones.

### 2.1.3. Removal of EDCs in water

Advanced treatment technologies are currently being studied for the removal of EDCs in water. A huge range of publications is available in the literature researching different techniques for the removal of EDCs [3]. In addition, interesting reviews can be found where all these publications are collected, gathering the available techniques and the removal efficiencies obtained for a large number of different EDCs [12, 13, 28-30, 32, 67, 69, 77]. This section briefly mentions the techniques being studied, and some of their most interesting characteristics. Hence, Table 2 provides an assessment of different treatment processes for the removal of micropollutants.

Focusing on membrane technology, several studies can be found in which the study of the elimination of steroid hormones through membranes is examined in depth [35, 36, 40, 71, 78-81]. In MP removal by means of membranes, different mechanisms have been described: size/steric exclusion, charged interaction and adsorption [35, 40]. In addition, hormone retention depends on several factors such as membrane fabrication methods, membrane characteristics, operating conditions, specific estrogen characteristics and membrane fouling [40].

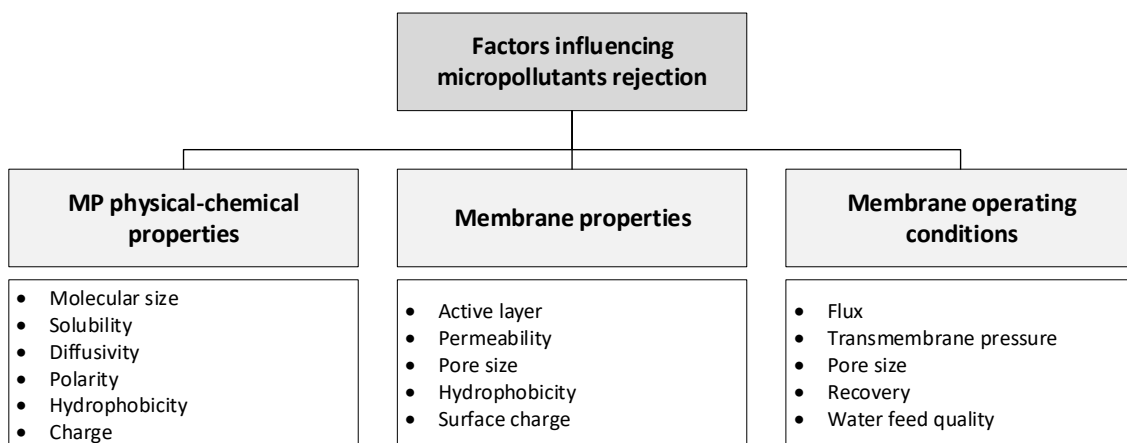

Figure 4. Factors influencing micropollutants rejection. (Adapted from [77])

For low permeability membranes (such as NF membranes), estrogen hormones removal range is 80 - 95% [36, 80]. For UF membranes, hormone retention is ineffective due to the molecular size of the hormones, as it is smaller than the molecular weight cut off (MWCO) of the ultrafiltration membranes (1-1000 kDa) [35, 78]. However, the properties of ultrafiltration membranes (lower cost and higher permeability) are very interesting. Thus, to improve the removal of MP through UF membranes, hybrid processes such as activated carbon combined with UF [38] are being studied. In this thesis, a combined process using ultrafiltration membranes and carbon nanoparticles (CNPs) is studied. The characteristics of elimination of steroid hormones by CNPs are explained in the following section.

Table 2. Overview of different treatment processes for micropollutants removal. (Adapted from [29])

Treatment	Removal efficiency <sup>1</sup> <i>Steroid hormone</i>	Characteristics		Disadvantages
		<i>Process-specific</i>	<i>MP related</i>	
<b>Coagulation-flocculation</b>	Low	<ul style="list-style-type: none"> <li>· Dosage</li> <li>· pH</li> <li>· Wastewater composition</li> </ul>	<ul style="list-style-type: none"> <li>· Hydrophobicity</li> <li>· Molecular size</li> </ul>	<ul style="list-style-type: none"> <li>· Ineffective MP removal</li> <li>· Large amount of sludge</li> <li>· Introduction of coagulants salts in the aqueous phase</li> </ul>
<b>Activated carbon adsorption (AC)</b>	High	<ul style="list-style-type: none"> <li>· Adsorbent properties</li> <li>· Dosage</li> <li>· Contact time</li> <li>· pH</li> </ul>	<ul style="list-style-type: none"> <li>· Hydrophobicity</li> <li>· Molecular size</li> <li>· Structure</li> <li>· Functional group</li> </ul>	<ul style="list-style-type: none"> <li>· Relatively high financial costs</li> <li>· Lower efficiency in the presence of NOMs</li> <li>· Need for regeneration</li> <li>· Disposal of used carbon</li> </ul>
<b>Ozonation and AOPs</b>	High	<ul style="list-style-type: none"> <li>· Dosage</li> <li>· pH</li> <li>· Interfering ions</li> <li>· Wastewater composition</li> </ul>	<ul style="list-style-type: none"> <li>· Compound structure</li> </ul>	<ul style="list-style-type: none"> <li>· High energy consumption</li> <li>· Formation of byproducts</li> <li>· Interference of radical scavengers</li> </ul>
<b>Nanofiltration (NF)</b>	Medium - High	<ul style="list-style-type: none"> <li>· Membrane properties</li> <li>· pH</li> <li>· Transmembrane pressure</li> <li>· Feed quality</li> </ul>	<ul style="list-style-type: none"> <li>· Hydrophobicity</li> <li>· Molecular size</li> </ul>	<ul style="list-style-type: none"> <li>· High energy demand</li> <li>· Membrane fouling</li> <li>· Disposal of concentrate</li> <li>· Desorption of sorbed chemicals from membrane</li> </ul>
<b>Reverse osmosis (RD)</b>	High	<ul style="list-style-type: none"> <li>· Membrane properties</li> <li>· pH</li> <li>· Transmembrane pressure</li> <li>· Feed quality</li> </ul>	<ul style="list-style-type: none"> <li>· Hydrophobicity</li> <li>· Molecular size</li> </ul>	<ul style="list-style-type: none"> <li>· High energy consumption</li> <li>· Disposal of concentrate</li> <li>· Corrosive nature of the finished water</li> </ul>
<b>Biological treatments</b>	Medium - High	<ul style="list-style-type: none"> <li>· Sludge retention time</li> <li>· Hydraulic retention time</li> <li>· Organic loading</li> <li>· Redox conditions</li> </ul>	<ul style="list-style-type: none"> <li>· Hydrophobicity</li> <li>· Biodegradability</li> </ul>	<ul style="list-style-type: none"> <li>· Inconsistent removal of polar and resistant compounds</li> <li>· Increase of environmental risk due to the disposal of sludge containing micropollutants</li> </ul>
<b>Membrane bioreactor (MBR)</b>	High	<ul style="list-style-type: none"> <li>· Sludge retention time</li> <li>· Hydraulic retention time</li> <li>· Organic load</li> <li>· Redox conditions</li> </ul>	<ul style="list-style-type: none"> <li>· Hydrophobicity</li> <li>· Biodegradability</li> </ul>	<ul style="list-style-type: none"> <li>· Moderately high energy consumption</li> <li>· Inconsistent removal of polar and resistant compounds</li> <li>· Membrane fouling</li> <li>· Less sorption of micropollutants on the aged MBR sludge</li> </ul>

<sup>1</sup>High (>70%); Medium (40-70%); Low (<40%)

## **2.2 Carbon nanoparticles (CNPs)**

Carbon nanotube (CNT) is one form of carbon, with nanometer-sized diameter and micrometer-sized length. Their atoms have the same disposition as in the graphite arranged in hexagons. The structure of the CNT is composed of an enrolled cylindrical graphitic sheet (graphene) rolled up into a cylinder with a diameter of the order of one nanometer [82-84].

The properties of nanotubes depend on atomic arrangement (how the sheets of graphite are 'rolled'), diameter and length of the tubes, and the morphology, or nanostructure. Nanotubes exist as either single-walled or multi-walled structures, although multi-walled carbon nanotubes (MWCNTs) are simply composed of concentric single-walled carbon nanotubes (SWCNTs) [83].

### *2.2.1. Single-walled carbon nanotubes (SWCNTs): Definition and properties*

Single-walled carbon nanotubes (SWCNT) are formed by the lamination of a single layer of graphite (called a graphene layer) into a seamless cylinder (long wrapped graphene sheets). Most SWCNTs have a diameter of close to 1 nm. SWCNTs consists of two separate regions with different physical and chemical properties: The first is the sidewall of the tube and the second is the end cap of the tube [82].

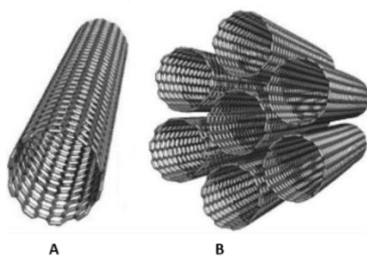

*Figure 5. A) Idealized representation of defect-free SWCNTs with open ends, B) an idealized bundle of nanotubes. In such bundles individual tubes are held together with van der Waals interactions [85].*

SWCNTs provide chemically inert surfaces for physical adsorption and have high specific surfaces (comparable to activated carbon (AC)). Unlike ACs, the atomic scale structure is well defined and uniform. In addition, in SWCNTs, it can be directly dealt with several well-defined adsorption sites available to the adsorbed molecules [86]. Its structure is highly porous and hollow, which makes it have a large specific surface area and therefore a strong interaction between CNTs and pollutant molecules [44].

The adsorption interactions between SWCNTs and organic pollutants are affected by the following factors: properties of the CNTs (size, shape, surface areas, large average pore diameter and volume, morphology, functional groups and impurities) and properties of pollutants (hydrophobicity, electron polarity, polarity, size and functional groups) [87]. Several interaction mechanisms can act simultaneously, such as hydrophobic interactions,  $\pi$ - $\pi$  bonds, electrostatic interactions and hydrogen bonds. The dominant adsorption mechanism is different for different types of organic chemicals (such as polar and non-polar), so the prediction of organic chemical absorption in CNTs is not straightforward [88]. In general,  $\pi$ - $\pi$  interactions can be important depending on the size and shape of the aromatic system and the molecule substitution unit [44].

These interactions will be taken into account in the analysis of the results in Chapter 5.



### 2.2.2. CNPs in water treatment

CNPs are being extensively studied for water pollutant removal applications and It has been demonstrated that the CNTs possess exceptional water treatment capacities, with high efficiency in the removal of both chemical and biological contaminants [46]:

- Heavy metal such as  $\text{Cr}^{3+}$  [89],  $\text{Pb}^{+2}$  [90] and  $\text{Zn}^{+2}$  [91].
- Metalloids such as arsenic compounds [92].
- Organics such as polycyclic aromatic organic compounds (PAH) [93-95], atrazine [96] and endocrine disrupting compounds (EDCs) [41, 97-101].
- Biological contaminants: bacteria [102-107]; viruses [108, 109]; natural organic matter (NOM) [55, 110-112] and cyanobacterial toxins [113-115].

Focusing on the adsorption of endocrine disrupting compounds, carbon nanotubes are demonstrated to be efficient adsorbents towards micropollutants [42, 44]. CNTs have shown high potential adsorption capacities in the removal of a diverse range of EDCs and PPCPs, presumably due to their fibrous shape with high aspect ratio, providing a large external surface area that can be accessed readily by EDCs and PPCPs [41]. Several researchers have been studied the adsorption capacities of CNTs [45, 46], suggesting that CNTs have better adsorbent capacities than powered activated carbon (PAC) due to shorter equilibrium times and higher adsorption capacities [116]. However, because the unique properties of EDCs in terms of size, shape, pKa, functional group and hydrophobicity affect their removal by CNTs, more extensive research is needed to remove EDCs by CNTs with various properties (size, shape, average surface area, pore diameter and volume, morphology and functional group) [41].

Furthermore, despite its very promising adsorbent capabilities, research with CNTs has yet to provide effective solutions to the challenges presented by nanomaterials, the potential release of nanoparticles into the environment, which could have consequences for the human body as well as the environment [117-120]. The quest for solutions to these challenges has led to research into combined membrane and CNT applications [98, 121, 122]. The deposition of CNTs on the surface of several membranes has been investigated to improve removal by adsorption-filtration [99, 123-125]. Moreover, in recent years UF membranes with SWCNTs have been studied for the elimination of EDCs [100].

CNTs-based composite membranes have remarkably improved performances in terms of separation and purification capabilities for various water treatments, however, it is necessary to extensively continue research of CNTs-based composite membranes regarding characterizations and fabrication processes [126]. In addition, applications of CNTs-based composite membranes should be considered not only from the viewpoint of water treatment performances, but also from that of potential toxicity effects when CNTs are released to the environment in some cases. Therefore, studies on how to sufficiently improve adhesion between the CNT and the substrate (matrix) possibly deserve more attention [126].

Finally, emphasizing this last point, the composite membranes (UF-SWCNTs) presented in this study incorporate the CNTs in the membrane support layer and are held up by a second membrane, showing a negligible leakage of nanoparticles during filtration tests. This suggests that the method of fabrication of UF-SWCNTs membranes may be a promising method to use in removing contaminants from water.

## 2.3 Natural organic matter (NOM)

### 2.2.3. Definition and classification

Natural organic matter (NOM) could be describe as a complex matrix of heterogeneous mixture of organic compounds such as humic substances, polysaccharides, amino sugars, proteins, peptides, lipids, small hydrophilic acids and others [127]. NOM is found in water resources of drinking water as a result of interactions between the hydrologic cycle and the biosphere and geosphere [127]. The amount and the characteristics of NOM in surface water are strongly affected by climate, geology and topography of the soil [128, 129].

Components of NOM in water can be classified into two groups: hydrophobic and hydrophilic components. On the one hand, aromatic carbon with phenolic structures and conjugated double bonds form the hydrophobic part, and on the other hand, aliphatic carbon and nitrogenous compounds, such as carbohydrates and proteins, sugar and amino acids make up the hydrophilic NOM [130-132]. Figure 6 shows a summary of the different fractions and chemical groups of natural organic matter.

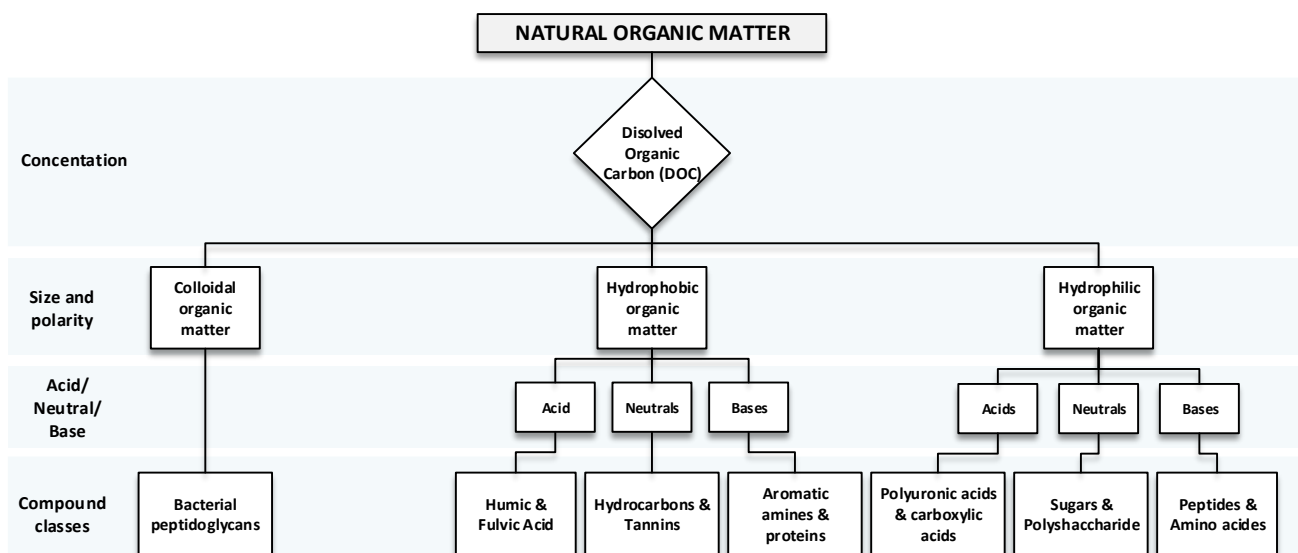

Figure 6. Fractions and chemical groups of NOM. (Adapted from: [132-136])

In surface water, these NOM fractions are found in different percentages. Mostly hydrophobic and hydrophilic fractions are found, followed by other minority fractions (carbohydrates, carboxylic acids, etc.) [130].

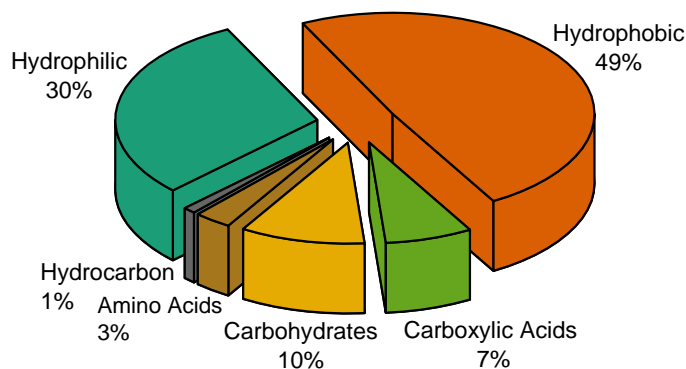

Figure 7. NOM fraction in surface water. (Adapted from: [130])

Natural organic matter, its characteristics, its components and interactions with other substances have been studied in depth since NOM causes a large number of problems when it is found in water:

- Gives taste, odour and colour to raw drinking water [130];
- Increases chemical demand for oxidation, coagulation and disinfection [137, 138];
- Forms halogenated organic disinfection by-products (DBPs) [139-141];
- Fouls membranes [142-147];
- Promotes biological growth in water distribution systems [148];
- Enables the transport of heavy metals and hydrophobic organic chemicals through natural and engineered environments [149, 150].

Therefore, knowing their characteristics and the different fractions that can be found in water is essential to improve the control or the removal efficiency of NOM [151]. Characterization methods have a fundamental function before and during the water treatment process, in order to know if the treatments are adequate in the presence of the different types of NOM that can be found in natural waters [152-154]. It is crucial to have a better understanding of the chemical and physical characteristics of a variety of organic compounds and how they affect their properties in the removal or, in this case, interaction with compounds such as steroid hormones and adsorbent materials such as CNPs.

Hence, different organic compounds have been evaluated in this study and important parameters such as hydrophobicity or hydrophilicity, aromaticity, molecular weight, types of fractions, functional groups and ability to form  $\pi$ - $\pi$  bonds have been described.

#### *2.2.4. NOM characterization methods*

Currently, there are several highly developed methods for the characterization of NOM, as well as new methods with advanced detection techniques are being investigated. Spectrometric methods such as fluorescence, UV-Vis, FTIR and NMR techniques; chromatographic methods such as HP-SEC and FIFF; mass spectrometric methods such as LC-MS, FTICR MS and GC-MS and general methods such as TOC, DOC and SUVA can be found in NOM research literature [155].

The techniques selected in this study are TOC analysis, SUVA, UV-vis adsorption, LC-OCD and FFFF. Table 3 summarizes the NOM characterization techniques used in this study and their main features.

- Total organic carbon (TOC)/Dissolved organic carbon (DOC)

TOC and DOC are the most convenient parameters for analysing the NOM removal of treatment processes. However, TOC and DOC measurements alone do not provide much insight into the behaviour of NOM during water treatment [156]. A variety of oxidation techniques and instruments are currently in use, including burning, radiation, and oxidizing agents. The resulting CO<sub>2</sub> is measured mostly by infrared spectroscopy (IR) [151].

- UV-Vis absorption spectroscopy

UV-Vis absorption spectroscopy is a semi quantitative method to determine humic substances in natural waters. It is based on the measurement of the attenuation of a beam of light after it passes through a sample or after its reflection from a sample surface [155]. The concentration of an analyte in a solution can be determined by measuring the absorbance at a certain wavelength, applying the Beer-Lambert law [151].

The different wavelengths are believed to identify different chromophores: absorbance at 220 nm is associated with both the carboxylic and aromatic chromophores, whereas absorbance at 254 nm is typical for aromatic groups with varying degrees of activation [157]. Any wavelength from 220 to 280 nm is appropriate for NOM measurements, although the molar absorptivities will vary due to the range of chromophores in the structure of NOM [155].

- Specific UV-absorbance (SUVA)

SUVA is defined as the UV absorbance of a given sample at 254 nm divided by the DOC concentration of the sample (UV adsorption  $A_{254\text{nm}(1\text{cm})}/\text{mg}\cdot\text{L}$ ). Therefore, this ratio can be determined by combining the results from a DOC detector and a UV detector. SUVA describes the hydrophobicity and hydrophilicity of NOM in water.  $\text{SUVA} > 4$  indicate mainly high hydrophobicity, high molecule weight and high aromaticity usually related to aquatic humics. Values between 2 and 4 indicate mixtures of hydrophilic and hydrophobic NOMs, while values  $< 2$  indicate low hydrophobicity, i.e., hydrophilic and low molecular weight substances [133, 158].

- Liquid Chromatography – organic carbon detection (LC-OCD)

Liquid chromatography - organic carbon detection (LC-OCD) is a combination of SEC separation (fractionation method based on molecular size: the larger the molecules, the shorter the retention time [151]) and continuous analysis to quantify organic carbon, nitrogen, and UV absorbance [159]. With this method, it is possible to evaluate the content of HMW polysaccharides and biopolymers in the sample, which are not generally visible or traceable by UV detectors [155]. LC-OCD allows fractionate NOM into five parts: (1) biopolymers (such as polypeptides, polysaccharides, proteins and amino sugars), (2) humic substances (fulvic and humic acids), (3) building blocks (hydrolysates of humic substances), (4) LMW humic substances and acids, and (5) LMW neutrals (such as alcohols, aldehydes, ketones and amino acids) [159]. This method is especially interesting when characterizing different mixtures and NOM fractions. A SUVA measurement can be obtained with this instrument alone.

- Flow Field-Flow Fractionation (FFFF)

FFF is similar to chromatography as a method for separating macromolecules, colloids, and particles [160]. FFFF is also a molecular size fractionation method that is used to determine the MW of NOM [161, 162], but the interaction of solutes with the stationary phase is prevented. However, size distributions determined by FFFF should be treated with caution, because the sample recovery of humic substances decreases rapidly with increasing cross flow, lower pH, and ionic strength, and varies according to the material of the accumulation wall membrane [161]. At IFG-MT, currently, UV detection is the only detection method applied with FFFF, so the FFFF is not applicable for characterizing UV non-responsive NOMs.

The analytical methods mentioned are described in detail in the following chapter.

Table 3. Main features of the techniques selected in this study. (Adapted from [151])

Techniques	Features	Relevant properties
<b>Total Organic Carbon (TOC)</b>	Total organic carbon content in water	Only gives information on quantity of NOM, not quality. Easy and fast to use
<b>LC-OCD</b>	Characterizing different mixtures and NOM fractions	NOM fractionation into 5 categories. Different detectors (OCD, OND and UVD). Possibility of coupling other detectors.
<b>UV-Vis absorption spectroscopy</b>	Quantitative measurement of all compounds in the sample that adsorb UV light. Conjugated C-C multiple bonds, aromatic carbon, -COOH and -OH increase adsorption	Not all compounds of NOM can be detected; Wavelength-specific adsorption; sensitive to chemical environment. Simple and rapid method.
<b>Specific UV-Absorbance (SUVA)</b>	High SUVA value > 4 refers to hydrophobic and aromatic compounds. Low SUVA < 3 indicates mainly hydrophilic material	UV absorbance of a given sample at 254nm divided by the DOC concentration of the sample. This ratio describes the hydrophobicity and hydrophilicity of NOM in water.
<b>Flow Field-Flow Fractionation</b>	Separation technique similar to chromatography. Fractionate NOM by size and MWD	NOM fractionation based on size. Not all compounds of NOM can be detected.

### 2.2.5. Surrogate of NOMs

Due to the heterogeneity of NOM and the inconsistency of the natural water quality phenomenon, NOM surrogates are often used to represent organic materials of homogeneous natural origin. The selection of different types of NOM surrogates provides a basis for understanding the behaviour in interactions by different NOM characteristics (size distribution, structure, variation and functionality) [163, 164].

In this study, surrogate model compounds simulating natural macromolecular organic, such as humic acid (HA), tannic acid (TA), sodium alginate (alginic acid), glucose, extract of black tea from commercial source (tata tea) and real natural organic matter extract from Australia surface water were employed with the perspective of studying NOM interactions in the removal of steroid hormones by CNPs.

These NOM substitutes were chosen because they represent the two most abundant NOM fractions in surface water and wastewater: the hydrophobic fraction (HA, TA, tea extract, Australian NOM) and the hydrophilic fraction (glucose and sodium alginate). They can also be distinguished by their molecular weight, differentiating between compounds of high molecular weight (sodium alginate), low molecular weight (glucose) and common molecular weights of humic substances (HA, TA, tea extract and Australian NOM). On the other hand, they were also chosen for being compounds that present different aromaticity, as compounds with high aromaticity such as tannic acid and humic acid, and compounds with null aromaticity such as glucose and sodium alginate. Finally, they were also selected for having different structures with different functional groups, such as carboxylic acid in humic acid, phenolic groups in tannic acid and tea extract, and non-phenolic -OH and -COOH in sodium alginate and glucose.

Table 4 shows the main characteristics of the NOM surrogate compounds employed in this study. Moreover, the characterisation of these compounds is further discussed in chapter 5.

Table 4. Characteristics of natural organics surrogates compounds selected in this study.

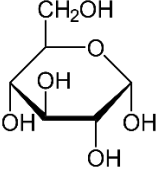
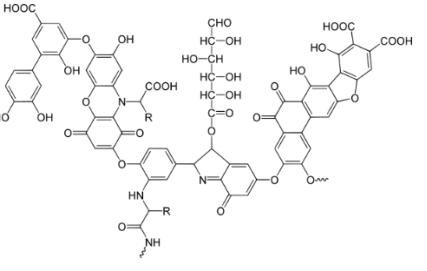
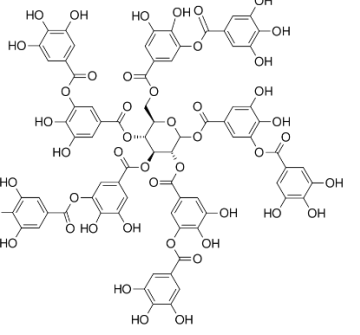
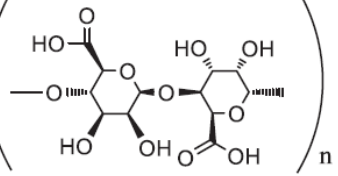
Compound	Glucose	Humic Acid <sup>1</sup>	Tannic acid <sup>1</sup>	Tea extract <sup>2</sup>	Australian NOM <sup>3</sup>	Sodium alginate (Alginic acid) <sup>1</sup>
<b>Molecular formula</b>	C <sub>6</sub> H <sub>12</sub> O <sub>6</sub>	n.a.	C <sub>76</sub> H <sub>52</sub> O <sub>46</sub>	n.a.	n.a.	(C <sub>6</sub> H <sub>8</sub> O <sub>6</sub> ) <sub>n</sub>
<b>Structure</b>		 (5)		n.a.	n.a.	
<b>Compound class</b>	Hydrophilic (Sugar)	Hydrophobic (Humic)	Hydrophobic (Tannin)	Hydrophobic (Mixture)	NOM Mixture	Hydrophilic (Sugar)
<b>MW (g/mol)</b>	180.16	600–60000	1701.19	n.a.	1200	12000-180000 <sup>4</sup>
<b>pKa</b>	10-12	4.3	8.5	n.a.	n.a.	3.4
<b>Carboxylic groups (meq/g)</b>	n.a.	4.8	1.88	n.a.	5.1	7.02
<b>Hidroxyl groups (meq/g)</b>	n.a.	2.26	9.55	n.a.	1.3	1.63
<b>Source</b>	Plants & animals	Vegetation, peat, coal and soil	Leaching from vegetation	Vegetation	Soil	Main constituent of Brown Algae
<b>Constituents</b>	-	Humic substances	Phenolic, catechol and Gallic acid moieties	Main constituent polyphenols	HA (~47%), Hydrophilic fractions (~19%)	Mannuronic (~60%) and Guluronic acids (~40%)

<sup>1</sup>[164]<sup>2</sup>[165]<sup>3</sup>[166]<sup>4</sup>[167]<sup>5</sup>[168]. n.a.: Not available.

### 2.2.6. Adsorption of NOM by CNPs

Removal of NOM from water can be achieved by number carbon-based adsorbents. Granular activated carbon (GAC), biological activated carbon (BAC), and powdered activated carbon (PAC) are mainly used for removal of NOM. The adsorption of NOM on carbon surfaces is a function of both, the physical properties of the carbon material and chemical composition of NOM [110].

However, the adsorption of NOM in CNTs is different from these microporous materials (activated carbons, ACs). Since adsorption in CNTs is based on accessible surface area and thus, high molecular weight portion of NOM is adsorbed relatively strongly [46]. In addition, the presence of aggregated pores with large mesoporous volumes and the presence of less negative surface charge as compared to activated carbon are the two factors responsible for superior adsorption capacity of carbon nanotubes [110]. Furthermore, the  $\pi$ - $\pi$  bonds support the interactions between the cross aromatic network of molecules with the aromatic rings of CNTs, enhancing NOM-CNT interactions [111], and due to these  $\pi$ - $\pi$  interactions with aromatic compounds, the adsorption capacity of NOM in CNPs will depend strongly on the type of NOM [169].

The  $\pi$ - $\pi$  interactions between CNPs and molecules with aromatic rings could be demonstrated, for example, with the tannic acid molecule. As stated above, TA is a very aromatic compound with a high number of aromatic rings. A strong  $\pi$ - $\pi$  interaction between CNPs is therefore expected. D. Lin and B. Xing [170] studied the CNP-TA interactions and observed two different models: On the one hand TA molecules may be adsorbed first onto CNTs with aromatic rings binding to the surface carbon rings via  $\pi$ - $\pi$  interactions, until forming a monolayer. On the other hand, the TA monolayer then further sorbed the dissolved TA by hydrogen bonds and other polar interactions. Figure 8 shows a diagram of the two proposed models.

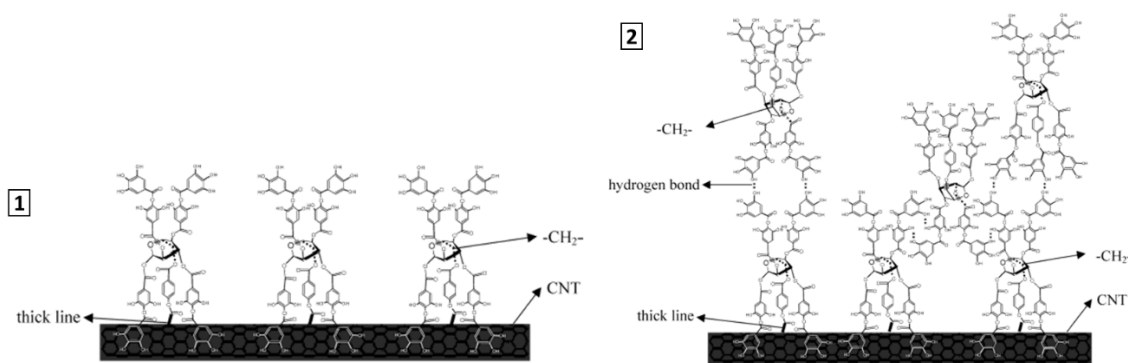

Figure 8. Schematic model for the interaction between carbon nanotube (CNT) and tannic acid (TA). **1:** TA molecule anchored onto the tube wall with benzene rings binding to the surface carbon rings via  $\pi$ - $\pi$  interactions to form a monolayer. **2:** The adsorbed TA monolayer sorbed more dissolved TA molecules (multilayer). (From [170])

Other studies also demonstrates this [171], so a generally accepted mechanism was that aromatic rings in the structure of TA could interact with the surface of CNTs through  $\pi$ - $\pi$  interactions. Therefore the interactions between TA and CNTs are very strong. Moreover, once TA was adsorbed on the surface of CNTs, many functional groups will also be introduced onto the surface of CNTs. They may continue interacting with TA in solution through  $\pi$ - $\pi$  interactions and hydrogen bonds. Therefore, the sorption between TA and CNTs may not be regarded as monomolecular layer adsorption when CNTs are dispersed in a high concentration of TA solution [171].

However, although the mechanisms for some NOMs are well defined, further research is needed under real dynamic conditions, for example, when different factors come into play, such as interaction with micropollutants or other materials, such as the active layer of a membrane, to really understand how NOM can behave in the adsorption of CNPs in combined water treatment processes.

### *2.2.7. Interactions between NOM and steroid hormones*

Several authors have evaluated the occurrence, fate, transport and degradation of estrogens, together with the impact of DOM on hydrophobic contaminant behaviour [172-174], determining that as NOM exhibits high capacity to bind with organic contaminants, NOM colloids are suggested as an important sink for environmental estrogens and as a cause of increased solubility of estrogenic compounds.

In spite of this, estrogen-NOM interactions and their impacts on estrogen removal have not yet been systematically addressed [72]. However, some studies suggest that  $\pi$ - $\pi$  interactions between estrogens and NOM govern binding behaviour. In  $\pi$ - $\pi$  complexes, the sorbate (in this case estrogenic compounds) that acts as a donor of  $\pi$  electrons interacts with NOMs that contain abundant  $\pi$  accepting groups (e.g., quinones, compounds with aromatic rings) and these interactions are known as " $\pi$ - $\pi$  stacking", " $\pi$ - $\pi$  charge transfer", or " $\pi$ - $\pi$  electron donor-acceptor" interactions [175].

Moreover, Jin et al [176] noted that E1 interacted more strongly with phenolic groups containing hydrophobic acid than with HA without phenolic groups, although the latter had much greater aromaticity than the former. These suggest the involvement of hydrogen bonds in overall absorption in addition to the interaction  $\pi$ - $\pi$ . The hydrogen bond can occur between the estrogen group -OH and groups containing oxygen or nitrogen in NOM [72]. A high sorption was also demonstrated for tannic acid, which is characterized by the abundance of phenolic groups [172]. In the same way, Neale et al. [164] also demonstrated the high affinity of tannic acid to humic substances and polysaccharides is due to the abundance of phenolic groups, while HS tend to have fewer phenolic groups and polysaccharides contain fewer aromatic groups.

From this, it can be concluded that there are two main mechanisms by which estrogenic compounds and NOM interact:  $\pi$ - $\pi$  interactions and hydrogen bonding [72]. In this way, the characteristics of the NOM play a very important role, since the more phenolic groups it contains, the greater its capacity to form these interactions, and hence the stronger estrogen-NOM bonding.

Finally, it should be noted that, interestingly, these interactions are the same ones that control the adsorption of estrogenic compounds in CNPs and the adsorption of NOM in CNPs, so it can be expected that estrogen-NOM-CNPs interactions may have a high likelihood of occurrence. Despite this evidence, there are not yet any available studies addressing estrogen-NOM-CNPs interactions.



## 2.4 Ultrafiltration (UF)

### 2.2.8. Basic principles of Ultrafiltration

Nowadays, membrane technology is widely used in the field of water treatment and reuse. The benefits of membrane technologies are well known: wide range of applications, high contaminant removal efficiencies, relatively low production cost, ease of operation, reliable, resistant under a large range of operating conditions and easily scalable [177].

A membrane is basically defined as a selective barrier that allows the passage of certain components and retains others due to physical (molecular size) or chemical (interactions) differences [178].

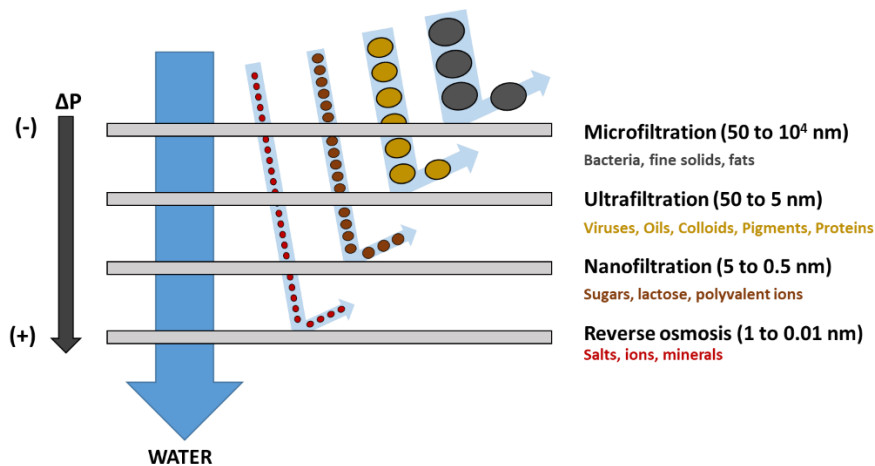

Figure 9. Membrane processes (pressure driven membrane) and their separation characteristics. (Adapted from [178]).

Membrane filtration process can be operated in two different modes. The dead-end mode, which is mainly used in conventional filtration process. In this mode, the feed flow is filtered perpendicular to the filter. In contrast, in cross-flow mode, the feed flow is parallel to the membrane. In this case, the filtration is carried out transversally. This mode favours the filtration of feed concentrated in solutes, as the tangential velocity of the flow minimises the fouling of the membrane. As a disadvantage, in this mode there is an increase in energy consumption due to the loss of pressure in the tangential flow (effect of the flow velocity) [178, 179]. Figure 10 shows the two main operating modes mentioned.

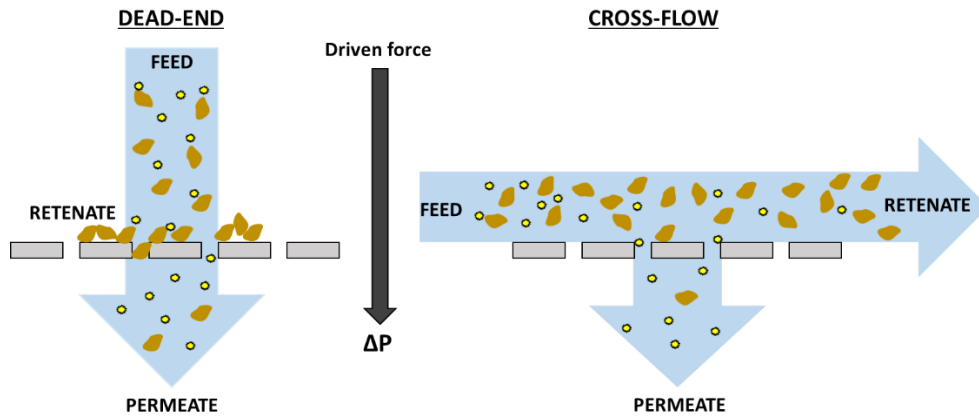

Figure 10. Membrane process mode: Dead-end and cross-flow (Adapted from [179])

In this study, the cross-flow mode was used, since working with natural organic matter causes severe fouling in the membrane and with this configuration it is possible to reduce it.

Finally, it should be mentioned that the transport through the membrane is due to a driving force. In this case, the driving force is the pressure applied. There are four main pressure driven membrane processes: MF, UF, NF and RO (Figure 9). The required applied pressure increases when the retention size is reduced, so the applied pressure increases in this order: MF < UF < NF < RO. In ultrafiltration processes, the operating pressure is usually in the range of 0.5 to 5 Bar [178, 179].

### 2.2.9. UF operation parameters

In membrane filtration processes there are two essential to characterize the membrane filtration: Flux ( $J$ ) and Retention ( $R$ ).

#### Flux ( $J$ ):

Flux is defined as permeate volume per unit of time and area. Membrane flux at a given pressure is related to the transport of water and solute through the membrane material, and hence depends upon the pore size and porosity. In adsorption studies, the flux is directly related to the residence time at which the adsorbates travel through the membrane, and therefore the contact time between the adsorbent and the adsorbate .

$$J = \frac{1}{A} \cdot \frac{dV}{dt} = \frac{4}{\pi \cdot d^2} \cdot \frac{dV}{dt} \quad [1]$$

Where:

$J$	Flux	[L/h·m <sup>2</sup> ]
$t$	Time	[h]
$V$	Permeate volume	[L]
$A$	Active filtration area	[m <sup>2</sup> ]
$d$	Diameter of active filtration area	[m]

Permeability is calculated by dividing the flux by the transmembrane pressure. The permeability is a parameter that can be compared with values given by the manufacturer or other works in which the membranes are operated at different conditions. The pure water permeability must be determined experimentally with pure water and at different operating pressures.

$$L_p = \frac{J}{\Delta P} \quad [2]$$

Where:

$L_p$	Permeability	[L/h·m <sup>2</sup> ·bar]
$J$	Flux	[L/h·m <sup>2</sup> ]
$\Delta P$	Transmembrane pressure	[h]

Retention:

Retention gives information about how efficiently the water component (e.g. steroid or NOM) is removed from a membrane process.

Retention depends on many factors, such as operating conditions: pressure and feed flow, feed conditions: concentration and type of solutes, and process conditions: process mode (dead-end, cross-flow), membrane molecular cut off (MWCO), active membrane layer material, etc [178]. In the composite set-up, retention also depends on the adsorption properties of incorporated SWCNTs. Hence, the importance of defining the operational conditions of the process and keeping the parameters of the system fixed so that the terms of retention or removal can be analysed correctly.

$$R = \left(1 - \frac{C_p}{C_f}\right) \cdot 100 \quad [3]$$

Where:

$R$	Retention	[%]
$C_p$	Permeate solute concentration	[mg/L], [ng/L]
$C_f$	Feed solute concentration	[mg/L], [ng/L]



## **CHAPTER 3. OBJECTIVES**

**T**he main objective of this work is the study of the effect of natural organic matter on the removal of steroid hormones by carbon nanoparticles, and how this effect can be reduced or avoided with UF-SWCNTs composite membranes that shield carbon nanoparticles from natural organic matter.

This work seeks to find answers to the following research questions:

1. What is the impact of different NOM surrogates on hormone adsorption when NOM and SWCNTs interact with each other?
2. How do steroids hormones interact with SWCNT-UF composite membranes at different fluxes / residence times in the presence of an interfering NOM?
3. Does the variation in membrane MWCO play an important in NOM shielding and hence prevent control the interference with SWCNT adsorption?

In order to achieve the objectives and answer the research questions, the following points were developed in this work:

- i. Characterization of the surrogate natural organic matter compounds with liquid chromatography-organic carbon detector (LC-OCD), TOC analyser and UV spectrophotometer.
- ii. Performance of E2 filtration experiments with different surrogates of natural organic matter and without, in a cross-flow system with UF-SWCNTs composite membranes. Samples analysed with a liquid scintillation counter (LSC) to determine the interference of the NOMs in the removal of E2 and analysed with LC-OCD and UV to determine if the membranes remove any fraction of NOM.
- iii. Performance of filtration experiments with different steroid hormones (E1, P and T) with and without tannic acid, by UF-SWCNTs composite membranes, to demonstrate the reproducibility of the results and to study if there are differences in the elimination of different steroid hormones. Samples analysed with LSC to determine the interference of tannic acid in the elimination of steroid hormones and analysed with UV to determine if there is retention of tannic acid by means of the membrane.
- iv. Performance of E2 filtration experiments with and without tannic acid with UF-SWCNTs composite membranes of different MWCOs (5, 10, 30, 100kDa). Analysis of the samples with LSC to determine the removal of E2 and with UV to determine the retention of tannic acid by means of the membranes.
- v. Performance of E2 filtration experiments with tannic acid with UF-SWCNTs composite membrane at different pressures (hence different transmembrane fluxes and residence times) to see the effect on the removal of hormones.



## **CHAPTER 4. MATERIALS AND METHODS**

This chapter provides information about the different elements used and protocols followed during the execution of this thesis. On one hand, the chemicals and chemistry solution used on this work as well as the membranes and their preparation method. On the other hand, the filtration system used to carry out the ultrafiltration tests and the experimental protocol are explained in detail. Finally, it also exposes the analytical equipment used to characterize the samples, as well as the cleaning protocol to avoid sample contamination.

### **4.1 Chemicals**

In this section are the most important characteristics of the chemicals used. Information is given about carbon nanoparticles, compounds that were used as surrogates of natural organic matter, hormones and other chemicals used.

#### *4.1.1. Carbon nanoparticles (CNPs)*

As it has been seen, carbon nanoparticles have very interesting adsorbent properties with a great capacity to eliminate different contaminants, so CNPs were used to eliminate micropollutants such as estrogenic hormones. Therefore, in this project it were used single-walled carbon nanotubes (SWCNTs) provided by Thomas Swan. The properties of SWCNTs are gathered in Table 5.

Table 5. Nanoparticle properties

Nanoparticle	Company	Dimensions	Purity	IEP	Zeta potential in water at pH 7-8 (mV)	Specific surface area (m <sup>2</sup> /g)	Cost (€/g)
Single-walled carbon nanotubes (SWCNTs)	Thomas Swan	Length: 0.2-0.5µm Diameter: 2-3 nm [180]	95%	7.1 [181]	0 [181]	800	99.0

#### *4.1.2. Natural organic matter (NOM)*

Different surrogate compounds of natural organic matter have been used in experimental work. Each compound is interesting as they have different characteristics and properties as discussed in Chapter 1. Humic acid, glucose, tannic acid, alginate, Australian NOM and tea extract have been used as surrogate compounds of natural organic matter. A summary of these compounds is shown in Table 6.

Table 6. Compounds used as surrogate natural organic matter

NOM	Real stock concentration <sup>1</sup> (mgC/L)	Description	Physical form	Molecular weight (g/mol)
Humic acid (HA)	404	Humic Acid Technical (Sigma-Aldrich)	Powder	1986.29 <sup>2</sup>
Glucose (GLU)	442	D-(+)-Glucose BioUltra, anhydrous, >99.5% (Sigma-Aldrich)	Powder	180.16 (C <sub>6</sub> H <sub>12</sub> O <sub>6</sub> )
Tannic Acid (TA)	482	Tannic Acid, ACS (Alfa Aesar)	Powder	1701.19 (C <sub>76</sub> H <sub>52</sub> O <sub>46</sub> )
Alginate (ALG)	322	Alginic acid sodium salt, low viscosity (Alfa Aesar)	Powder	12000 – 180000 [182] (C <sub>6</sub> H <sub>8</sub> O <sub>6</sub> ) <sub>n</sub>
Australian NOM (AUS)	440	NOM concentrated from surface water from Gosford Mooney pump station in the Brisbane Water National Park (Gosford, NWS, Australia) [166]	Powder	1381 [166]
Tea extract (TEA)	271	Extract TATA tea (commercial tea)	Powder	1604.37 <sup>2</sup>

<sup>1</sup>Measured with TOC analyser.

<sup>2</sup>Estimated with FFF.

#### 4.1.3. Hormones

In this project four different steroid hormones as micropollutants have been used: Estrone (E1), Estradiol (E2), Progesterone (P) and Testosterone (T). The hormones used were provided by Perkin Elmer. Hormones are presented in a native solution with ethanol and they are radiolabelled (activity of 37 MBq/mL) so can be detected with the Liquid scintillation counter (LSC) which makes it possible very low concentrations of hormones to be detected.

#### 4.1.4. Other chemicals

Apart from the compounds used as natural organic matter and the hormones used, other chemical compounds were used during the realization of this project. The compounds are listed in Table 7. Their use as well as their preparation are detailed in the following section.

Table 7. Other chemicals used

Compounds	Supplier	Function	Physical form
Sodium Chloride (NaCl)	Sigma-Aldrich	Background electrolyte	Powder
Sodium bicarbonate (NaHCO <sub>3</sub> )	VWR	Background electrolyte	Powder
Hydrochloric acid (HCl)	MERCK	pH adjustment	Liquid
Sodium hydroxide (NaOH)	MERCK	pH adjustment	Pellets
Triton-X	Sigma-Aldrich	CNPs surfactant	Liquid
Ultima Gold LLT	Perkin Elmer	Scintillation cocktail	Liquid



#### 4.1.5. Solution Chemistry

This section describes the procedure followed to prepare the different chemical solutions used in this work.

- Background electrolyte solution

1 mM NaHCO<sub>3</sub> and 10 mM NaCl was used as background electrolyte solution in feed solution of filtration experiments. It was prepared two litres of 5 mM NaHCO<sub>3</sub> and 2L of 50 mM NaCl as a stock solution to be able to use it with a dilution of 5 times in feed solutions.

To prepare the stock solution, the necessary mass of each compound was calculated following the equation:

$$Mass = C \cdot V \cdot MW \quad [4]$$

Where *C* is the required concentration (mol/L), *V* is the volume to be prepared (L) and *MW* is molecular weight (g/mol).

Therefore, 0.84 g of NaHCO<sub>3</sub> and 5.884 g of NaCl were weighed and dissolved in 2 L of Milli-Q water to prepare the background electrolyte stock solutions.

- NOM solutions

NOM stock solutions were prepared by weighing 0.5g of each compound and dissolving them in a volume of 500 mL of Milli-Q water. It was taken into account that humic acid does not dissolve well at neutral pH, so 1g of NaOH was added to increase the pH and hence increasing dissolution.

The most difficult compounds to dissolve in water such as humic acid, tea extract and Australian NOM were filtered with a 0.45 µm filter to remove suspended particles. These suspended particles could cause problems for analytical equipment, so filtration was essential before using these solutions.

The concentration of each solution in this case was variable, since not all compounds dissolve in the same way, so once the solution was prepared, a sample of each was taken and analysed in the TOC analyser to measure DOC (mgC/L). Once the dissolved organic carbon was known, the required NOM solutions were prepared according to this concentration.

The stock solutions were kept in the fridge in order to avoid carbon degradation.



*Figure 11. NOM stock solutions (Left to right: Alginate, tannic acid, humic acid, Australian NOM and tea extract)*

▪ Hormone solutions

To prepare hormone solutions, a mother solution of radiolabelled hormone of 10 µg/L, prepared by the responsible for radiotracers, was used. The hormone filtration solutions of 100 ng/L was prepared from this mother solution diluting with Milli-Q water.

▪ CNP suspension

To load the CNPs into the UF membrane a suspension must be prepared. For this, a concentration of 0.1 g/L of CNPs was prepared. The CNP suspension prepared was 1 L, so 0.1 grams of SWCNTs were weighed and added to Milli-Q water. To improve the suspension of SWCNTs a surfactant must be added. In this case, a concentration of 0.1 wt.% Triton X-100 was used as surfactant. Finally, to ensure a homogeneous dispersion of SWCNTs, the mixture should be placed in an ultrasonic bath for 1 hour. In addition, each time the suspension was used it was previously placed for 1 hour in the ultrasonic bath.

The amount of CNPs loaded on the membranes was 2 g/m<sup>2</sup>. To achieve this quantity, the volume of CNPs suspension to be added in the loading process was calculated. Knowing the membrane area and CNP suspension concentration, the necessary volume can be calculated.

$$Membrane\ area = \frac{\pi}{4} \cdot (Effective\ membrane\ diameter)^2 \quad [5]$$

$$V_{CNP\ suspension} = \frac{Membrane\ area \cdot Required\ load}{CNPs\ suspension\ concentration} \quad [6]$$

The membrane area calculated with equation [5] is 0.00441 m<sup>2</sup> (effective membrane diameter 73mm). The required load of CNPs was in all cases 2 g/m<sup>2</sup> and the concentration of the prepared CNP suspension was 0.1 g/L. Therefore, using equation [6], a volume of 84 mL was used in each CNPs load.

## 4.2 Membranes

In this section can be found information about the membranes used, their preparation and the process of loading CNPs into the membranes.

### 4.2.1. Ultrafiltration membranes

For the filtration tests, UF membranes from Millipore Company were used. Membranes of Ultracel series with different MWCO have been used. Their main characteristics are summarized in Table 8.

Table 8. Membrane characteristics

MWCO (kDa)	Serie	Serial code	Surface material <sup>1</sup>	Support material	Thickness <sup>1</sup> (mm)	Permeability (L/h·m <sup>2</sup> ·bar)
100	Ultracel	PLHK	Regenerate Cellulose	Polypropylene	0.23	750 [183, 184]
30	Ultracel	PLHTK	Regenerate Cellulose	Polypropylene	0.23	300 [183] , 200 [184]
10	Ultracel	PLGC	Regenerate Cellulose	Polypropylene	0.23	80 [60, 185]
5	Ultracel	PLHCC	Regenerate Cellulose	Polypropylene	0.23	11-14 [183-185]

<sup>1</sup>According to manufacturer

#### 4.2.2. Membrane preparation

Pre-preparation of the membranes is necessary since commercial membranes are provided in standard dimensions square sheets and by contrast, cell filtration is designed to place a circular membrane of 2 cm diameter and CNTs load process onto membrane is also conceived for a 7.5 cm diameter circular membrane. Hence, membranes must be cut to the required shape and size before it can be used.

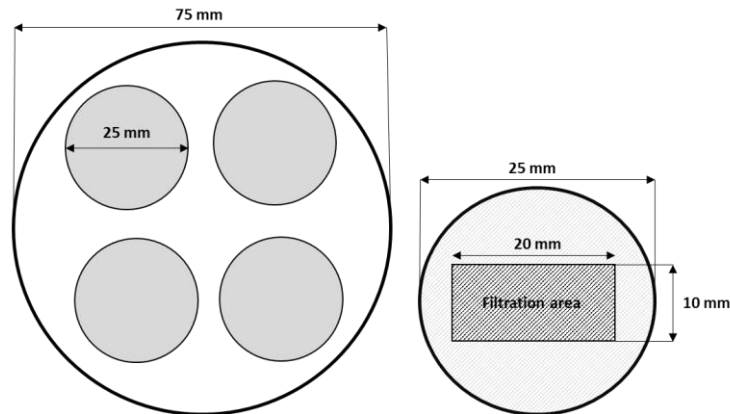

*Figure 12. Left: Membrane dimensions used for loading CNPs (75 mm). Right: Dimensions of membrane used in the filtration cell (25 mm).*

For this reason, cutting tools of different diameters must be used. The 75 mm cutting tool was used to cut the membrane to be loaded with CNPs. Once the nanoparticles are incorporated, the membrane must be cut with the 25mm cutting tool, which is the size that is be used in the filtration system. Finally, the 13 mm cutting tool has been used for some membrane porosity tests. Figure 13 shows the cutting tools used.



*Figure 13. Membrane cutting tools (From left to right, cutting diameters 75, 25 and 13 mm)*

#### 4.2.3. UF-SWCNTs membrane fabrication

In order to incorporate the CNPs into the UF membrane, two different processes were used depending on the MWCO of the membranes.

For MWCO membranes between 10 and 100 kDa, a vacuum pump was used. The configuration of the system used can be seen in Figure 14.

For membranes of 5 kDa, the vacuum pump does not have enough power to introduce the CNPs into the membranes, as the pore size is very small. For this reason, a stirred cell was used as shown in Figure 15.

The conditions and differences of each process are explained below.

On the one hand, for MWCO membranes between 10 and 100 kDa, vacuum filtration is powerful enough to allow water to be filtered through the membranes, incorporating the CNPs on the backside of the membranes.

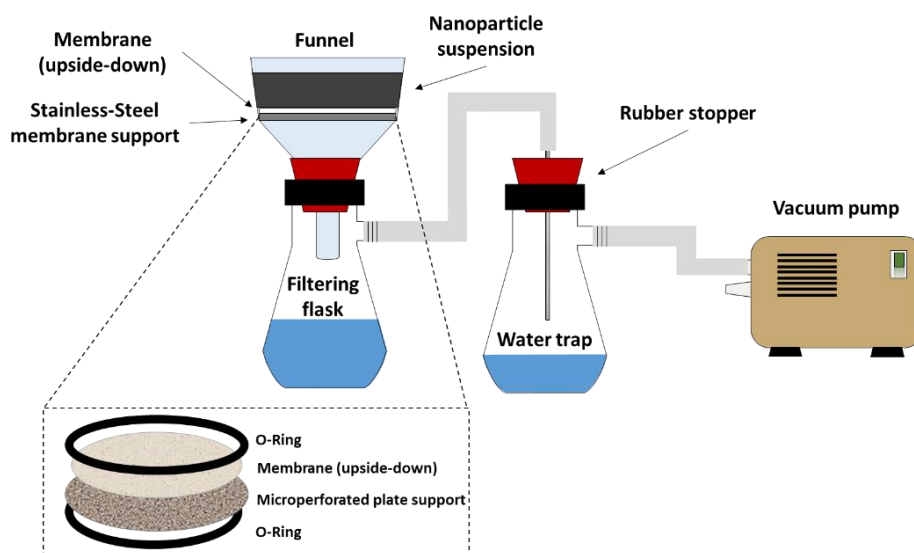

Figure 14. Assembly schematic used for loading CNPs into UF membranes (10-100 kDa).

The protocol for loading CNPs on the 10-100 kDa membranes is as follows:

<b>1. Assembly of auxiliary elements</b>
On the one hand, a filtration flask must be connected to another flask that is used as a water trap (vacuum pump protection), and both must be connected to a vacuum pump. On the other hand, a funnel is placed above the filtration flask and an O-ring must be placed in the funnel, followed by a micro-perforated metal plate (prevents loss of CNPs).
<b>2. Membrane placement</b>
The membrane must be placed upside down, i.e. the active layer oriented towards the micro-perforated metal plate, with the reverse side of membrane visible. Another O-ring must be placed above the membrane to ensure sealing.
<b>3. Loading process</b>
Once the membrane and auxiliary elements are correctly positioned, CNPs suspension (see section 4.1.5) is added and a suction is applied with a vacuum pump. The water passes through the membrane and CNPs are incorporated into the membrane from his reverse side.

<p><b>4. Membrane storage</b></p> <p>Loaded membranes should be stored sealed and with a wet tissue and kept in the refrigerator to prevent degradation, keep them moist and preserve their properties.</p>
---

On the other hand, loading CNPs on membranes of 5 kDa requires high pressure. For this reason, a pressurized stainless steel cell was used. The cell works completely sealed and pressure is applied with synthetic air to carry out dead-end filtrations. In this case, the pressure required for loading CNPs was 8 bar.

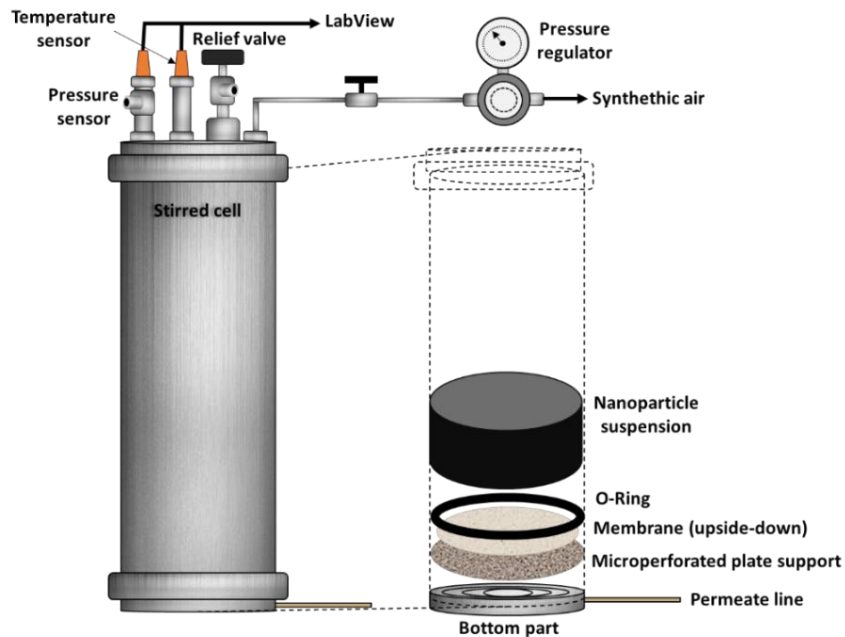

Figure 15. Assembly schematic used for loading CNPs into UF membranes (5 kDa).

The protocol for loading CNPs on the 5 kDa membranes is as follows:

<p><b>1. Identify elements</b></p> <p>The cell consists of 3 basic elements: top cover, cell body and bottom part. In the top cover are located the sensors as well as the synthetic air inlet and a relief valve. The solution to be filtered is located in the cell body. The membrane is placed at the bottom and the permeate is collected through it. The cell must be disassembled to allow the membrane to be placed at the bottom.</p>
<p><b>2. Membrane placement</b></p> <p>A microperforated metal plate should be placed at the bottom, followed by the membrane in the upside-down position.</p>
<p><b>3. Cell assembly</b></p> <p>Once the membrane is correctly positioned, the cell body should be positioned above the bottom. The cell body has two O-rings, one inside and one outside on the bottom to seal the membrane and cell. Once the bottom part is sealed with a clamp, the CNPs suspension should be added to the cell body and the top cover should be placed with another clamp.</p>
<p><b>4. Loading process</b></p> <p>To load the CNPs, pressure is applied by opening the valve of the synthetic air line, and the pressure is increased with the manometer up to 8Bar. The process lasts until the entire suspension has filtered out.</p>

Once the entire suspension has been filtered, the synthetic air valve must be closed and the cell depressurized by opening the relief valve with caution. Once the cell is depressurized, the cell can be disassembled and the membrane can be removed.

#### **5. Membrane storage**

Loaded membranes should be stored sealed and with a wet tissue and kept in the refrigerator to prevent degradation, keep them moist and preserve their properties.

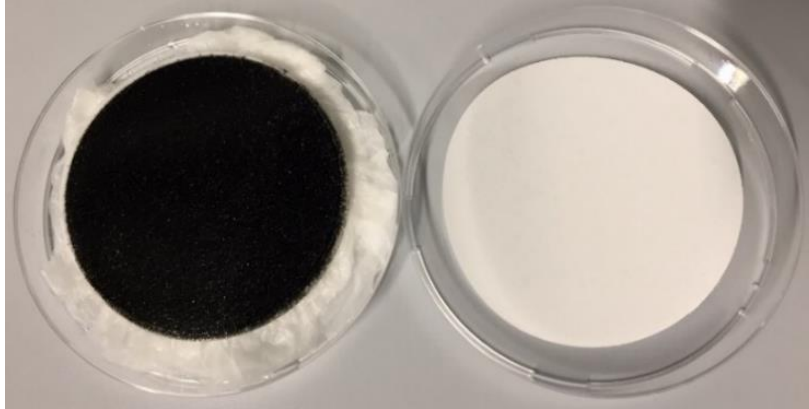

*Figure 16. Left: 100 kDa UF membrane loaded with 2 g/m<sup>2</sup> CNPs. Right: 100 kDa UF membrane before loading.*

### **4.3 Filtration system**

A cross-flow system was used to carry out the filtration experiments. This system was chosen to reduce the extent of NOM fouling. The system as well as the filtration protocol and the parameters most important of filtration tests are explained below.

#### **4.3.1. Filtration system overview**

The filtration set-up is composed of two pressure transducers, a pressure control valve, and a relief valve. There are also two sensors in the feed water tank, one of which is temperature and the other conductivity. A peristaltic pump is necessary to pass the feed water through the membrane filtration cell. At the exit of the membrane filtration module, there are a contactless conductivity sensor, followed by a switching valve device where the sample is collected by means of vials placed on a balance. The balance is connected to a computer to be monitored. In addition, the temperature as well as the conductivities (feed and permeate) and the pressures at the entrance and exit of the membrane filtration cell are monitored. The configuration of the system is shown in Figure 17.

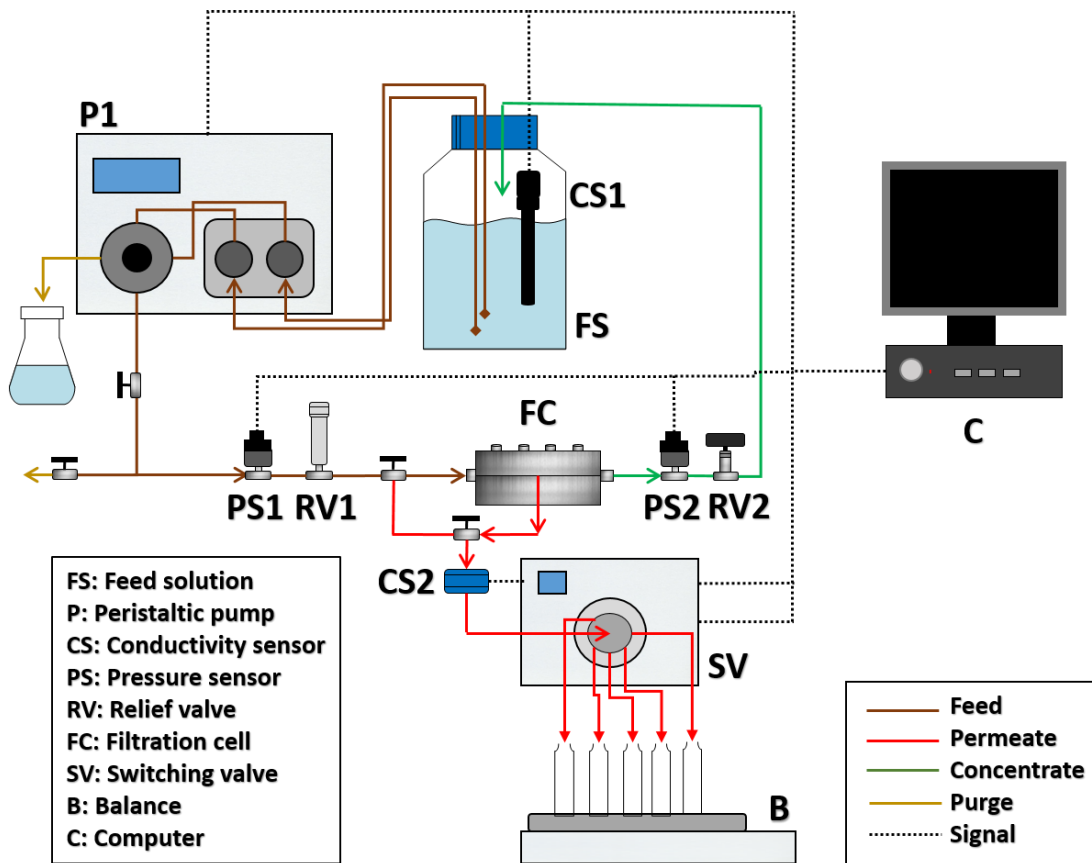

Figure 17. Scheme of the filtration system.

The filtration cell is the most important part of this system. The cell (manufactured by IMVT, KIT) is made of stainless steel and consists of two parts (top and bottom) that are perfectly sealed by eight bolts. In the central part of the cell, there is a rectangular opening of 1 cm x 2 cm where the membrane is placed. The feed flow that is filtered through the membrane passes through the opening and it out through the front of the cell. Concentrate flow does not pass through the membrane and it comes out in opposite side of the cell.

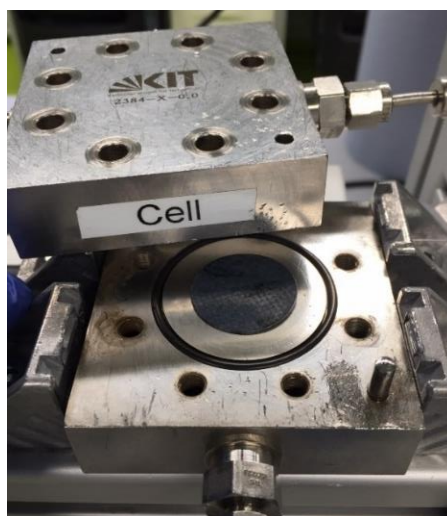

Figure 18. Picture of filtration cell with 100kDa UF-SWCNTs composed membrane.

#### 4.3.2. Filtration protocol

A well-defined protocol was followed to perform filtration experiments with the cross-flow system. The protocol can be summarized in the following steps:

<b>1. Membrane conditioning</b>
Membranes should be washed with Milli-Q before experiment to wash off any kind of coating or preservatives
<b>2. Pump purging</b>
Pump is purged opening purge valve and setting the pump flow rate at 100 L/min with LabVIEW.
<b>3. Air bubble removal</b>
In order to eliminate air bubbles, which cause erratic flow, pressure variations and errors in conductivity measurement with contactless conductivity sensor, the whole system must be flushed with Milli-Q water. The pump flow rate must be set at 100 mL/min.
<b>4. Compaction</b>
To make sure a constant permeability of the membrane, a compaction must be realized. This is done with each new membrane and is carried out at a higher pressure than used during filtration tests. For this, the membrane is placed in the correct position in the filtration cell, the pump flow rate is set at 30 mL/min in LabVIEW and the pressure is manually adjusted to 4 Bar with the needle valve. After the pressure and permeate flow are stabilized, compaction should be performed for 30 min.
<b>5. Pure water flux</b>
Before each test, the flux of pure water must be measured. In this case, the operating pressure vary according to the molecular cut off the membranes used. The pressure must be set to 0.5 bar for membranes from 300 to 1000kDa, 1 bar for membranes from 8 to 100kDa and 5 bar for membranes from 1 to 5 kDa. The other operating conditions are identical in all cases. The pump flow rate is set to 30mL/min and the duration set to 15 min in LabVIEW. The pressure is adjusted manually with the needle valve.
<b>6. Filtration test</b>
To start the filtration test, the pump must be paused and the pump feeding tube submerged in Milli-Q water bottle must be changed to hormone feed solution Schott bottle (1L).
<b>7. System flush</b>
Flushing is must done to remove contaminants in the system. To ensure the system is clean, a flushing period of 5 minutes with feed flow rate at 30mL/min is carried out. The flush water used is discarded.
<b>8. Pure water flux</b>
The flux of pure water should be measured again after the filtration test. This allows to observe any change in the membrane or fouling action after the filtration test. The procedure is identical to that explained in step 5.
<b>9. Membrane removal and storage</b>
At this point, membrane is removed from the system. Membrane should be stored in the cool room in a plastic petri-dish with the active layer in contact with a moist tissue to preserve the membrane.
<b>10. System flush without membrane</b>
The system must be cleaned without the membrane. The pump flow rate is set at 30mL/min for 2 min.
<b>11. Remove water from switching valve</b>
Finally, with a syringe, the switching valve must be flushed with air to remove residual water.



#### 4.3.3. Monitored and calculated parameters

By means of the sensors installed in the system, the following parameters are collected in LabView: Feed and retentate pressure, feed and permeate conductivity, feed temperature and permeate mass. These parameters allow the system to be controlled at any time and are stored to report on the conditions under which each test was conducted.

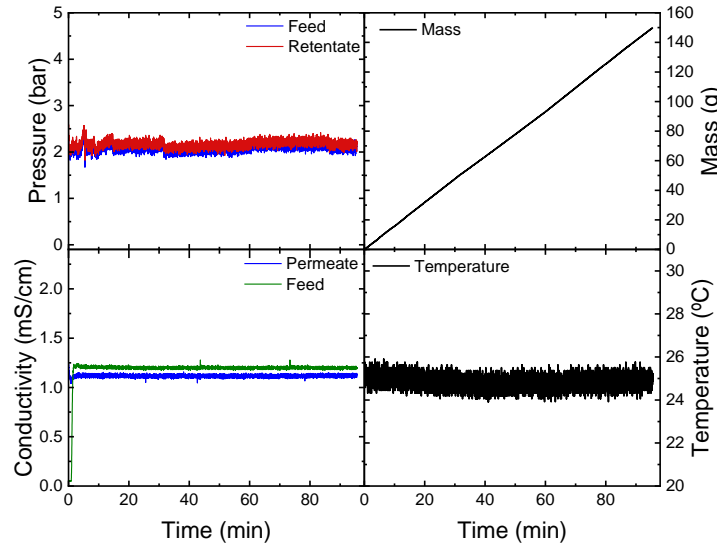

Figure 19. Example of the parameters collected in a filtration test. (Data: test with 100kDa UF-SWCNT, feed E1 100 ng/L and TA 10 mgC/L)

The parameters calculated after each test were pure water flux, permeability, hormone removal and adsorbed mass. These parameters were calculated with the equations shown in Table 9.

Table 9. Parameters measured after filtration experiments.

Parameter	Symbol	Unit	Equation	Eq.
Flux	$J$	$L/m^2 \cdot h$	$J = \frac{m_{wat,p}}{t_{elapsed} \cdot \rho_{wat} \cdot A_{membrane}}$	[1]
Permeability	$L_p$	$L/m^2 \cdot h \cdot bar$	$L_p = \frac{Flux}{\Delta P}$	[2]
Hormone removal	-	%	$Removal = \left(1 - \frac{C_p}{C_f}\right) \cdot 100$	[3]
Mass adsorbed	$m_{ads}$	ng	$m_{ads} = V_f \cdot C_f - \sum_{i=1}^{n \text{ sample}} V_{p,i} \cdot C_{p,i} - V_r \cdot C_r$	[6]
Specific mass adsorbed	$m_{s,ads}$	ng/g	$m_{s,ads} = \frac{m_{ads}}{m_{adsorbent}} \text{ or } m_{s,ads} = \frac{m_{ads}}{A_{membrane}}$	[7]
Residence time	-	s	$Residence \ time = \varepsilon \frac{h}{J_0} = \varepsilon \frac{h}{L_p \cdot \Delta P}$	[8]
$m_{wat,p}$ = permeate mass $t_{elapsed}$ = test duration time $\rho_{wat}$ = density of water $A_{membrane}$ = Active membrane area		$\Delta P$ = transmembrane pressure (bar) $C_p$ = permeate, feed and retentate concentration $m_{adsorbent}$ = mass loaded of SWCNTs $\varepsilon$ = porosity of membrane $h$ = membrane thickness		

#### **4.4 Analytical methods**

The analytical methods were of great importance for the accomplishment of this work. The different samples obtained after experiments were analysed to know their concentration in organic carbon (TOC, LC-OCD), their concentration of hormones (LSC) as well as to determine the concentration and characteristics of natural organic matter (LC-OCD, UV).

Table 10 summarizes the analytical methods used. Each method is described in detail in the following sections.

Table 10. Summary of analytical methods used (Purpose, results, advantages and disadvantages are only applied for this study).

Instrument	Purpose	Outputs	Based method	Advantages	Disadvantages	Sample Limitations
LC-OCD	Characterization of organic compounds (Fractions, Signal); Organic sample Concentration	<ul style="list-style-type: none"> <li>· OCD Signal response</li> <li>· UVD Signal response</li> <li>· Elution time</li> <li>· SUVA</li> </ul>	<ul style="list-style-type: none"> <li>· Size exclusion chromatography (column chromatography)</li> <li>· Hydrophobic and ionogenic separation</li> <li>· Absorbance of ultraviolet light (UVD)</li> </ul>	<ul style="list-style-type: none"> <li>- Detection and characterization of different organic fractions</li> <li>- Very accurate for studying humic substances</li> <li>- Possibility to differentiate the type of substance by its elution time.</li> </ul>	<ul style="list-style-type: none"> <li>- Some organic compounds cannot be detected (high molecular weight, highly aromatic structures such as tannins)</li> <li>- Not accurate for determination of bigger molecular sizes.</li> <li>- UV detector operates at fix wavelength.</li> </ul>	<ul style="list-style-type: none"> <li>· Concentration limits from 0.1 to 5 mgC/L</li> <li>· Required volume: min 5 mL</li> <li>· Analysis time: 90 min.</li> </ul>
UV	Characterization of organic compounds (Signal, SUVA); Tannic Acid Concentration	<ul style="list-style-type: none"> <li>· Absorbance</li> </ul>	<ul style="list-style-type: none"> <li>· Absorbance of ultraviolet light</li> </ul>	<ul style="list-style-type: none"> <li>- Absorbance at different wavelengths</li> <li>- Useful for compounds with aromatic structures</li> </ul>	<ul style="list-style-type: none"> <li>- Some organic compounds have no absorption to ultraviolet light (No aromatic compounds).</li> </ul>	<ul style="list-style-type: none"> <li>· Required volume: min 3mL</li> <li>· Analysis time: &lt; 1 min.</li> </ul>
TOC	Organic carbon concentration (Stock solutions, SUVA)	<ul style="list-style-type: none"> <li>· Total organic carbon (TOC)</li> <li>· Inorganic carbon (IC)</li> <li>· Total carbon (TC)</li> </ul>	<ul style="list-style-type: none"> <li>· Acidification (IC) and oxidation (TC) of carbon</li> </ul>	<ul style="list-style-type: none"> <li>- Highly accurate carbon concentration (up to ppb)</li> </ul>	<ul style="list-style-type: none"> <li>- It is not possible to distinguish between organic compounds.</li> <li>- Alcohols (solvents for hormones, such as Ethanol) interfere with results.</li> </ul>	<ul style="list-style-type: none"> <li>· Concentration limits from 0.1 to 5 mgC/L</li> <li>· Required volume: min 20 mL</li> <li>· Analysis time: 15 min</li> </ul>
FFF	Molecular weight	<ul style="list-style-type: none"> <li>· Elution time</li> <li>· UV Signal response</li> </ul>	<ul style="list-style-type: none"> <li>· Size exclusion chromatography (Laminar carrier flow)</li> </ul>	<ul style="list-style-type: none"> <li>- High resolution of size distribution</li> </ul>	<ul style="list-style-type: none"> <li>- Complex use: Type of membrane used (Material and MWCO), operating conditions (flow, pressure and concentration), need for calibration with molecular standards, possible compound-membrane interaction, interpretation of data, etc.</li> <li>- Cannot be used for compounds with high molecular weight.</li> </ul>	<ul style="list-style-type: none"> <li>· Concentration required: 1 mgC/L</li> <li>· Required volume: min 1 mL</li> <li>· Analysis time: 30 min</li> </ul>
LSC	Hormone detection	<ul style="list-style-type: none"> <li>· Bq/sample</li> </ul>	<ul style="list-style-type: none"> <li>· Transformation of light (induced by radiation) into electrical impulses</li> </ul>	<ul style="list-style-type: none"> <li>- Possibility of detection of hormones at very low concentrations (up to 0.1 ng/L)</li> </ul>	<ul style="list-style-type: none"> <li>- Hazardous chemicals (Scintillation cocktail).</li> <li>- Handling of radioactive substances.</li> <li>- Requires special waste management</li> </ul>	<ul style="list-style-type: none"> <li>Required volume: 1 mL</li> <li>Analysis time: 33 min</li> </ul>

#### 4.4.1. Liquid chromatography – Organic carbon detector (LC-OCD)

The detection as well as the quantification of the concentration of the different compounds used as surrogates of NOM in the samples, has been essential to analyse the results presented in this work. For this purpose, Liquid chromatography – Organic carbon detector (LC-OCD, Model 9) provided for DOC-LABOR was used.

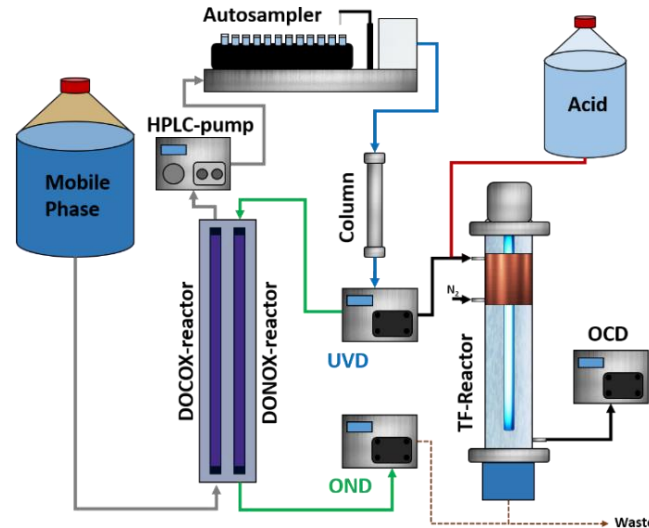

Figure 20. Scheme of LC-OCD system. (Adapted from [159])

The system is composed of three different detectors: OCD, an organic carbon detector; UVD, a UV-detector at 254nm; OND, an organic nitrogen detector [186]. Therefore, three different signals are obtained for each analysed sample. For data acquisition and signal processing were used ChromLOG and ChromCALC software (version 2.5), designed by DOC-LABOR.

This system is ideal for the study of natural organic matter, since in addition to giving information about the concentration of dissolved organic carbon contained in each sample, the LC-OCD permits divide the different compounds that forms natural organic matter into several fractions, since it uses a fractionation method based on size exclusion chromatography. Furthermore, apart from the size exclusion, hydrophobic and ionogenic characteristics of each compound also affects in this separation.

According to the different fractions, these can be classified into 6 sub-fractions [159]:

- Biopolymers: Composed of polysaccharides and proteins.
- Humics: Humic and fulvic substances.
- Building blocks: Corresponding to breakdown products of humics.
- Low molecular weight (LMW) acids: Organic acids.
- LMW neutrals: Alcohols, aldehydes, ketones, sugars and aminoacids.
- Hydrophobic organic carbon (HOC): Organic matter remaining on the column due to strong hydrophobic interaction.

These fractions and the position where they are found are shown in Figure 21.

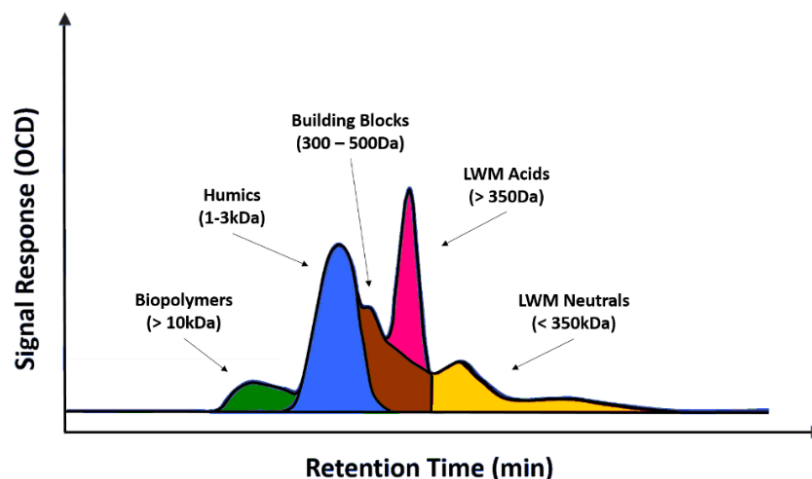

Figure 21. Theoretical chromatograph with the different fractions of organic matter detected with LC-OCD. (Adapted from [187])

Therefore, when a sample is analysed in the LC-OCD, it can be characterized by the characteristic peaks that it presents, since the position that appear in the chromatogram gives information about the type of organic compound that it is. In addition, it is possible to know the concentration of dissolved organic in the analysed sample according to the signal response and the area under the curve of the characteristic peak.

The ChromCALC software is used to calculate the chromatogram parameters. Two types of chromatograms can be found, those that contain humic substances (HS) or those that do not. The software has an automatic integration option in the case of HS, but in the case that is not HS, a manual integration must be carried out. Basically, it is the same in both cases, the only difference is when defining the 5 distinctive points of a chromatogram. In Figure 22 it is possible to visualize a chromatogram with a HS and its 5 distinctive points (A, B, C, D and E) that the program will use to calculate the area under the curve.

The 5 distinctive points are defined as:

- A** Peak maximum of the HS peak
- B** Point with the highest slope left of the peak maximum of HS fraction
- C** Point with the highest slope right of the peak maximum of HS fraction
- D** Boundary between building blocks and low molecular weight (LWM) acids (for OCD and UVD only)
- E** Boundary between LMW acids and LMW neutrals (for OCD and UVD only)

These points can always be modified manually. Once defined, the software uses points A and B to calculate a curved fit using the Poisson distribution. Then, the software combines the original data and the calculated baseline with the Poisson distribution to calculate the area. In addition, with points D and E a boundary (exponential function) between LMW acids and LMW neutrals is calculated.

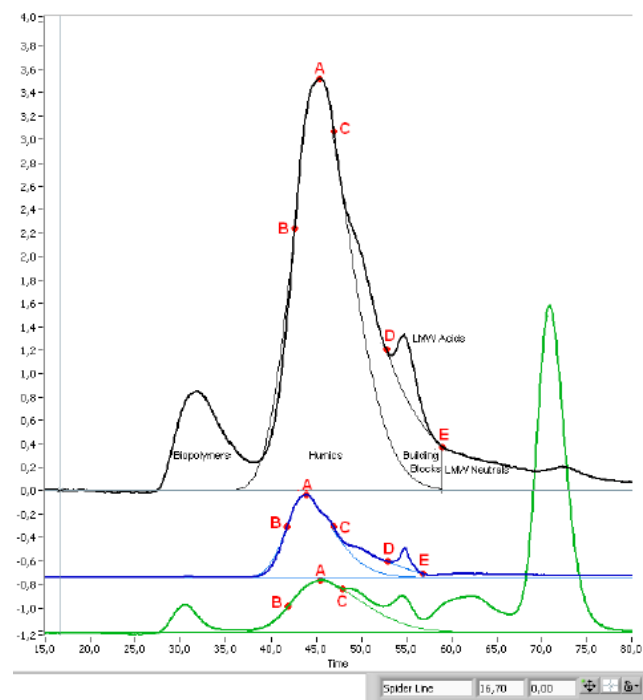

Figure 22. LC-OCD chrom and 5 distinctive points (A, B, C, D and E) use by ChromCALC software to calculate characteristics parameters of organics [186].

In Figure 23 the areas below the curve defined by the software can be seen. These areas are calculated and the results are shown on the program screen, along with other related parameters.

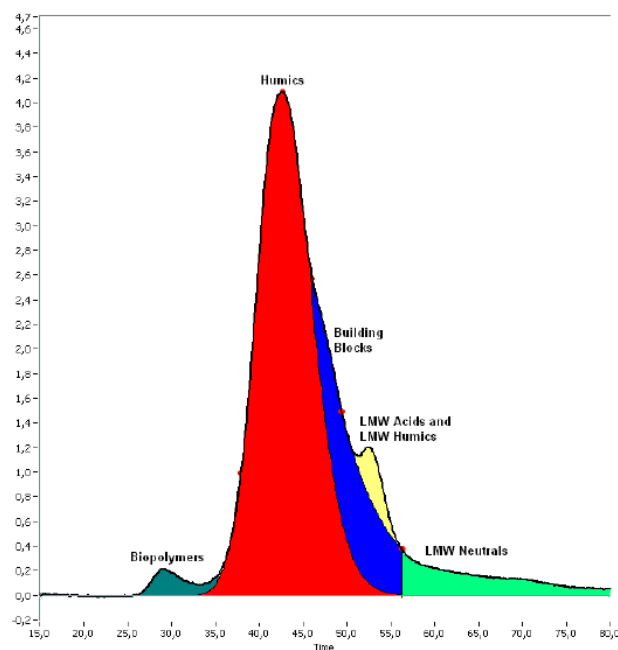

Figure 23. Different areas of an HS chromatogram calculated by ChromCALC software [186].

The chromatographs of organics used in this project, as well as the results obtained with this analytical method and the conclusions derived from them are shown in the following chapters.

#### 4.4.2. Ultraviolet Visible Spectrophotometer (UV)

Natural organic matter was characterized, in terms of absorbance and aromaticity, with a UV-vis spectrophotometer (Lambda 25, Perkin Elmer). The system analyses the samples contained in a 1 cm quartz cuvette by applying an ultraviolet light source to a specific wavelength. The equipment can apply ultraviolet light in a wave range of 190 to 1100 nm with a bandwidth of 1nm and has an absorbance range of up to 3.2A [188].

The software used for data collection and analysis was UV WinLab (Perkin Elmer). The program was operated with two modes: Scanning and Wavelength Program. Scanning mode, allows the measurement of the absorbance in a range of a wavelengths from 200 to 600 nm, and it is possible to determine which wavelength is best suited to analyse the samples. On the other hand, Wavelength program, allows applying a specific wavelength of 254 nm to analyse the specific absorbance of the samples (SUVA) and 213 nm to determine tannic acid concentration.



Figure 24. UV-vis spectrophotometer Lambda 25 (Perkin Elmer) [188].

#### 4.4.3. Total organic carbon analyser (TOC)

Total organic carbon (TOC) concentration of the samples was determined with a TOC analyser (Sievers M9 Portable, GE Analytical Instruments). The system measures the total carbon (TC) and inorganic carbon (IC) of each sample and calculates the TOC by difference, applying the following equation:

$$TOC = TC - IC$$

To measure these two types of carbon, the sample volume (approximately 10 ml) is divided into two different flows. An acid (phosphoric acid) are injected into one of them and an oxidant (ammonium persulfate) are injected into the other one. The acid converts the carbonates (inorganic carbon) into carbon dioxide (CO<sub>2</sub>). The oxidant, which is activated by ultraviolet light, transform both types of carbon (organic and inorganic) into CO<sub>2</sub>. The two volumes of CO<sub>2</sub> generated are measured by means of a selective conductometric membrane technology.

The flow rate of acid and oxidant must be taken into account, as the optimum value depends on the chemical nature of the sample to be analysed. When analysing samples containing natural organic matter, an acid flow rate of 2 µL/min and an oxidant flow rate of 1 µL/min were used. This also affects the range of concentration that can be measured with the equipment. In this case, the detection limits were between 0.1 and 5 mgC/L (following the manufacturer's recommendations), so the samples were diluted with Milli-Q water according to this range.

Before analysing the samples, a calibration curve should be made to know the detection efficiency of the instrument. For this purpose, a standard TOC (100 mgC/L potassium hydrogen phthalate, Sigma-Aldrich) was used to prepare samples of known concentrations between 0.1 and 5 mgC/L. This calibration curve can be found in Appendix.

Finally, the software used for data acquisition was DataPro 2 (GE Analytical Instruments). This software allows configuring the system and the analysis protocol of the samples (flow rates, analysis time, number of repetitions of sample measurement...). In addition, TOC analyser is connected to a fully automated autosampler, which allows to place up to 64 samples to run at once.



*Figure 25. Picture of TOC analyser, Sievers M9 Portable (GE Analytical Instruments).*

#### *4.4.4. Liquid scintillation counter (LSC)*

For the detection of hormones at low concentrations, Liquid scintillation counter (LSC; 2550 TR/AB, Packard) was used. This method allows the detection of radioactively labelled hormones up to a concentration as low as 0.1 ng/L [189].

This analytical method is based on the formation of light induced by radiation and the transformation of light into electrical impulses. Liquid scintillation cocktails absorb the energy emitted by radioisotopes and re-emit it as flashes of light [190]. In this case, the liquid scintillation cocktail consists in a mixture of 1ml of the sample that contains the radioactively labelled hormone and 1 mL of scintillation liquid (Ultima Gold LLT, Perkin Elmer) in a special 20 mL glass scintillation vial (Wheaton, Fisher Scientific).

Each sample is counted for 10 min in the system and measured in triplicate. The system returns results in Bq/sample units, and the hormone concentration is calculated using a linear regression of a previous performed calibration with hormone calibration standards (0.2, 1, 10, 50, 100ng/L). (see Appendix)

Besides, when working with samples that contain natural organic matter a phenomenon of quenching may occur. Quenching is the loss of counts due to sample or cocktail characteristics and may result from a variety of components in a sample. Quenchers are customarily divided into two categories: chemical quenchers or colour quenchers. Chemical quenchers absorb



radioactive energy before it is converted to light and colour quenchers absorb light in the range of the wavelength emitted by the scintillator, reducing the number of photons reaching the photomultiplier tube [190].

For this reason, a hormone calibration should be performed in the presence of different concentrations of surrogate natural organic matter (*see Appendix*). But, despite this, it has been shown that concentrations of less than 10 mg/L of natural organic matter has an almost negligible impact on the efficiency of hormone detection [38]. Because of that, the samples were diluted by 5 times with Milli-Q water before being analysed in the LSC.



*Figure 26. Picture of LSC, 2550 TR/AB (Packard).*

#### *4.4.5. Asymmetric flow field flow fractionation (AFFFF, AF4)*

To determine the molecular weight of humic acid (Sigma-Aldrich) and extract of tea (TATA tea), AF2000 MultiFlow FFF (Postnova) was used with the help of the FFF responsible. The AFFFF tool is a chromatographic technique that provide a high resolution of size distribution. The analytes separation is due to their interaction with a cross flow of a liquid laminar carrier under the action of an applied flow field in a cross section of a thin flat channel. The particle retention element in the channel is usually an ultrafiltration membrane (main difference between gel chromatographic columns). The sample is eluted along the channel by a longitudinal channel flow, perpendicular to the cross flow. The time it takes to elude the particle is directly related to the molecular distribution of the particle. The elution time will depend on the particle, the membrane and the flow applied [161, 191, 192].

The system was calibrated beforehand, using standard molecules of known molecular weight. In this case an Ultracel membrane of 1kDa (PLCAC, Millipore, USA) and polystyrene sulphonate (PSS) of different sizes was used to calibrate the system.



Figure 27. Picture of AF4, AF2000 MultiFlow FFF (Postnova).

#### 4.5 Cleaning procedures

The cleanliness of the elements used during the development of this work was very important, since when working with organic compounds in low concentrations, any external contamination must be avoided so that the results of organic carbon detection are not affected.

Special attention was paid to the glass vials used to analyse the samples. Since the vials are in contact with the samples to be analysed, it must be guaranteed that they do not contain any contamination organic compound that could affect the analyses. To this end, the cleaning of the vials was carried out following the cleaning protocol developed in the department (IFG-MT). The cleaning protocol is described below:

<b>1. Acid solution bath</b>
Empty vials should be upward in stainless steel baskets and covered by a perforated plate. Baskets with vials should be soaked for 24 hours in an acid bath (0.01 M HCl, pH 2). This first step eliminates inorganic carbon (IC).
<b>2. Alkaline solution bath</b>
After 24 hours in the acid bath, the vials should be emptied and rinsed with fresh tap water to removal acid solution. Subsequently, the basket should be immersed for 24 hours in an alkaline bath (0.01 M NaOH, pH 12). This allows to eliminate the total organic carbon (TOC)
<b>3. Milli-Q water bath</b>
The vials are then rinsed again with fresh tap water to removal alkaline solution. After this, the vials are immersed in milli-Q water for 24 hours. Finally, after 24 hours, the vials will be rinsed again with milli-Q water.
<b>4. Oven dried at 80°C</b>
The last step is to dry the vials in the oven at 80°C for 8 hours. Once dry, the vials must be sealed immediately with clean caps.

In addition to cleaning the vials, the use of organic solvents is not permitted in the laboratory where the TOC and LC-OCD analyses are performed. Moreover, each time a sample is prepared for analysis, the vials are immediately covered with aluminium foil to isolate the sample from the outside atmosphere, thus avoiding any possible contamination.

## **CHAPTER 5. EXPERIMENTAL RESULTS AND DISCUSSION**

### **5.1 Characterization of Natural Organic Matter (NOM)**

As mentioned in previous chapters, different surrogate NOM compounds have been used in this study. The compounds used have been humic acid (HA), tannic acid (TA), glucose (Glu), sodium alginate (Alg), tea extract (Tea) and Australian NOM (Aus). In Table 6, the most interesting properties of each compound can be found. In addition, ethanol was also analysed, since it is a solvent used in the hormone solution and therefore, being an organic compound, it can have relevant significance when characterizing the samples after tests with estrogenic compounds.

In order to examine these compounds, an initial characterisation has been carried out using different analytical techniques. This section systematically reviews the properties of each surrogate NOM compound.

#### *5.1.1. LC-OCD*

Surrogate NOM compounds were analysed with Liquid chromatography-Organic Carbon Detection (LC-OCD). The distinctive chromatographs of each compound are plotted in Figure 28. The elution time, as well as the molecular weight and the fraction in which it is found according to its elution time are shown in Table 11.

*Table 11. NOM chromatographic analysis results (LC-OCD)*

<b>NOM</b>	<b>Elution time (min)</b>	<b>MW (g/mol)</b>	<b>LC-OCD fraction</b>	<b>NOM fraction</b>
<b>Alginate</b>	10-16.5	12000-180000	Biopolymer	Polysaccharides
<b>Humic acid</b>	14-24	1986.29	Humics	Humic substances
<b>Australian NOM</b>	15-24	1381	Humics	Humic substances
<b>Tea extract</b>	19-31	1604.372	Humics	Humic substances
<b>Glucose</b>	28-38	180.16	LMW neutrals	Sugars
<b>Tannic acid</b>	-	1701.19	Hydrophobic organic carbon (HOC)	Polyphenols
<b>Ethanol</b>	35-41	46.07	LMW neutrals	Alcohols

Several conclusions can be drawn after the results of the chromatographs obtained with the LC-OCD.

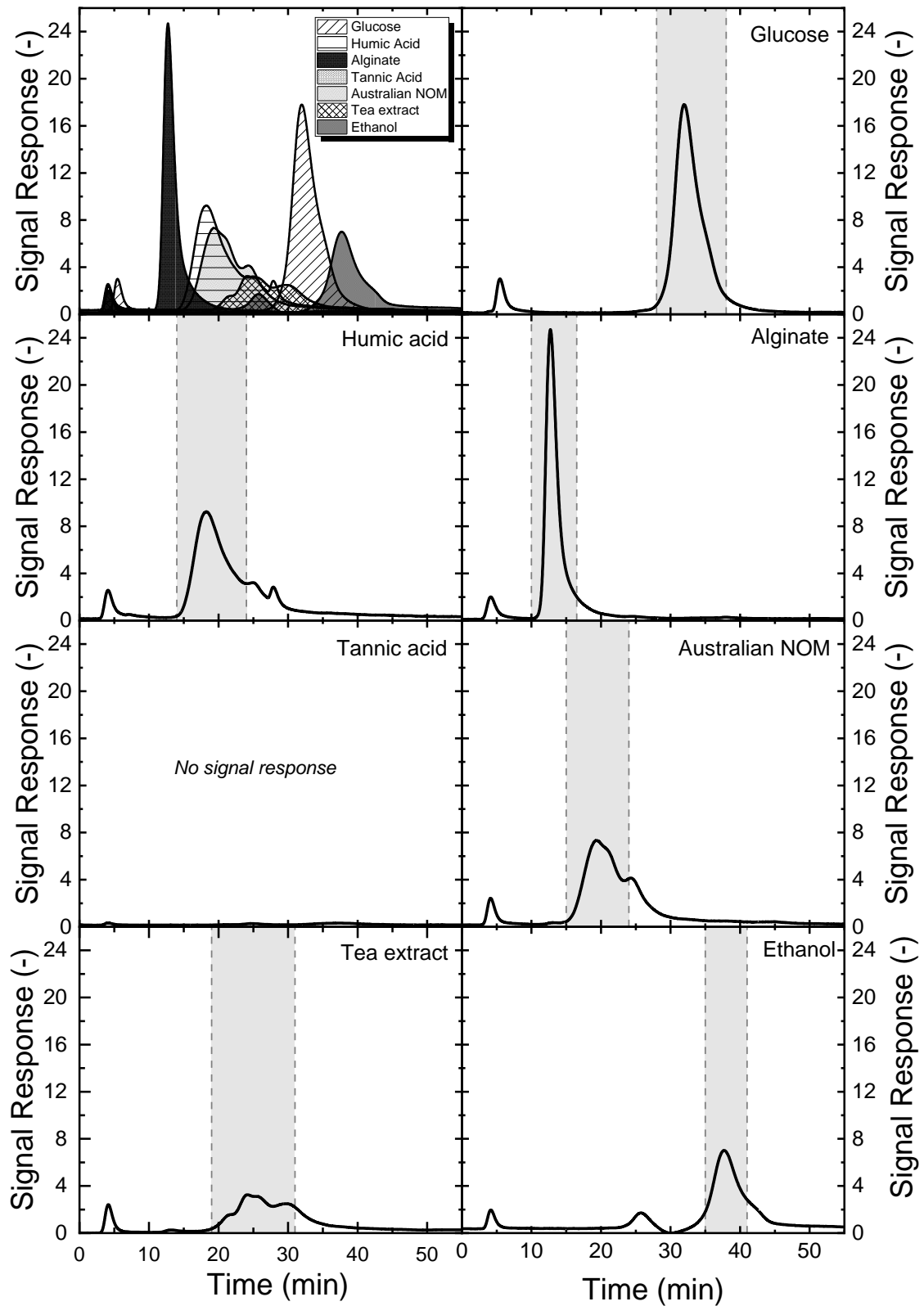

Figure 28. Characteristics peaks of humic acid, glucose, tannic acid, alginate, Australian NOM, tea extract and ethanol in LC-OCD, signal response from organic carbon detector (OCD).

On the one hand, the elution time in the chromatographic column is directly related to the molecular weight of the compound. The higher the molecular weight of the compound, the less time it resides in the column and therefore, the shorter the elution time. Compounds such as polysaccharides that have large molecular weights (sodium alginate) have the shortest elution times (10 – 16.5 min). In contrast, low molecular weight and neutral compounds such as sugars (glucose) or alcohols (ethanol) have the highest elution times (30 – 40 min).

On the other hand, the interactions between the NOM compounds and the chromatographic column must be taken into account. The intensity of the response signal is different for each compound, being more intense for less aromatic compounds (fewer interactions with the column). Tannic acid deserves special attention, as it is a phenolic compound with a large number of aromatic rings, and therefore a strongly hydrophobic compound; it has a very strong interaction with the column and thus, remains in the column. For this reason, it does not show any signal in the detector, as it does not escape from the column. This must be considered in phenolic compounds, such as tea (mostly formed by phenolic compounds) that may interact in the column, reaching the detector only some compounds that form it, and hence, the signal response has a low intensity.

Finally, the LC-OCD is a very precise instrument that can also give information about the concentration of dissolved organic carbon, depending on the signal response intensity and the amplitude of the characteristic peak (area under the curve). It can therefore be used quantitatively to know the concentration of a specific organic compound in a water sample. In Figure 29 it can be seen how the response signal varies directly with the concentration.

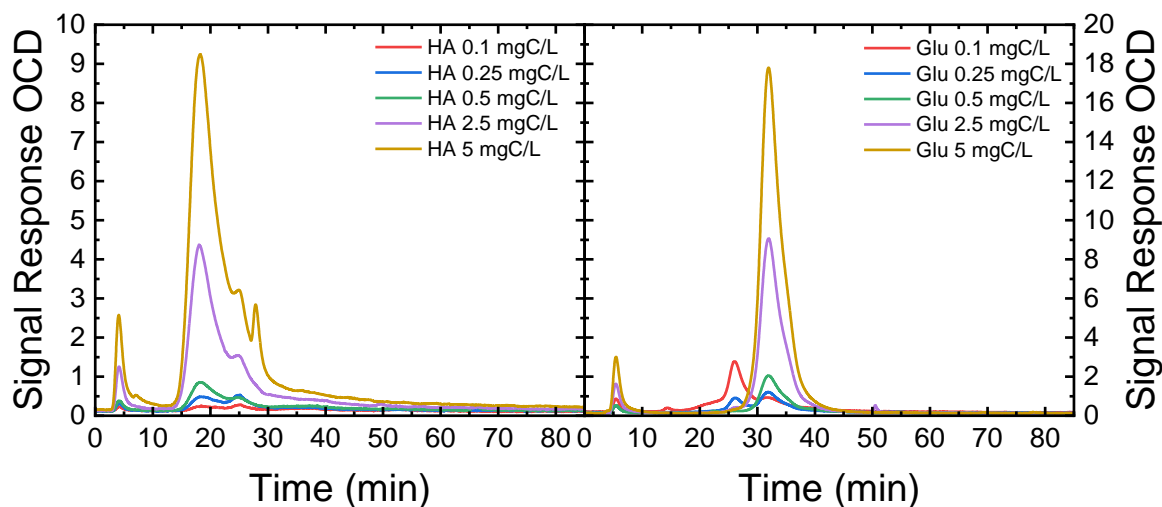

Figure 29. Different response signals for different concentrations for humic acid and glucose in LC-OCD.

### 5.1.2. UV spectrophotometer

Surrogate NOM compounds were also characterized in the UV spectrophotometer. Absorbance was studied for each compound in a wavelength of 200 to 600 nm. Figure 30 shows the absorbance of each NOM throughout the spectrum.

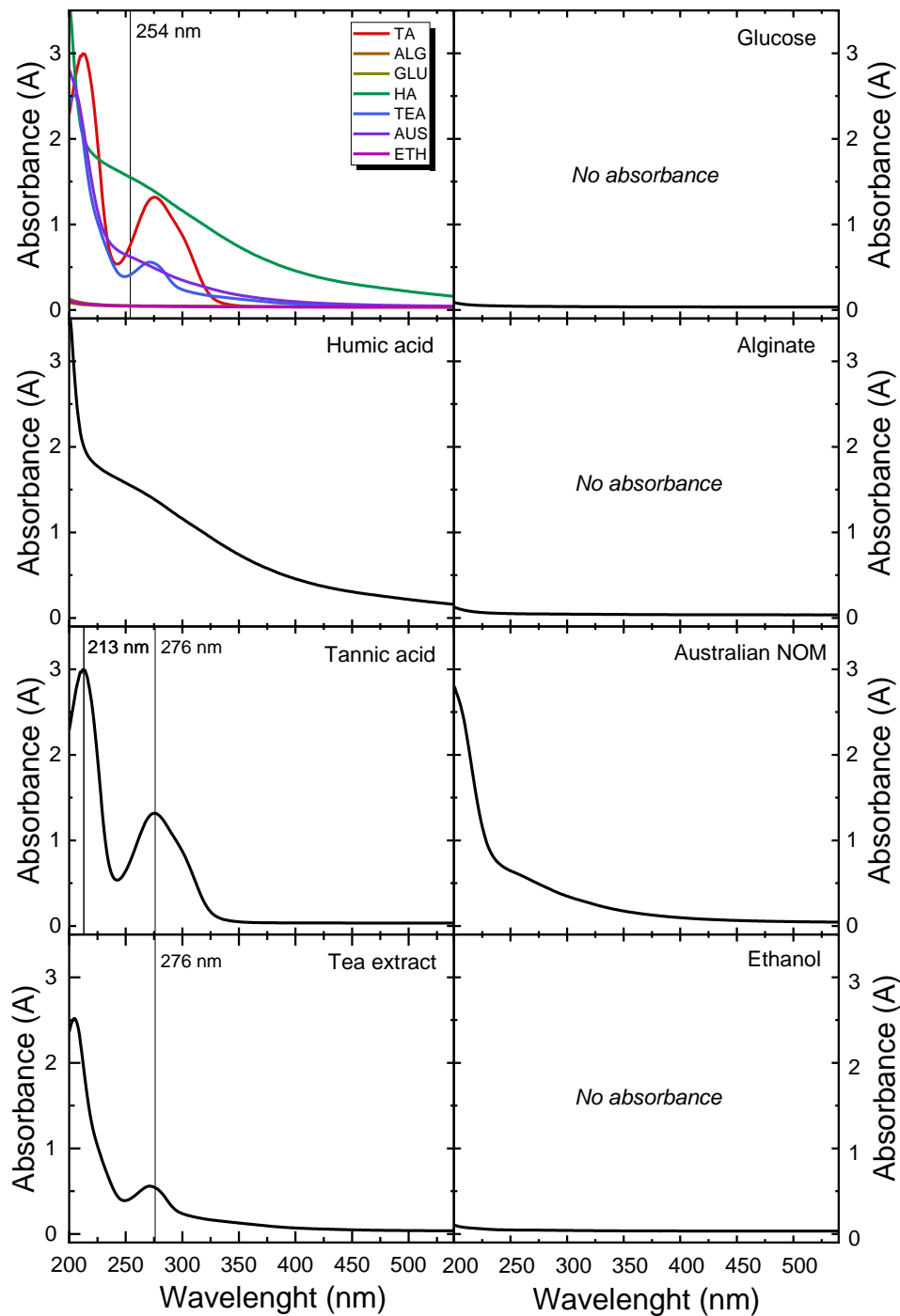

Figure 30. Ultraviolet light absorbance of humic acid, glucose, tannic acid, alginate, Australian NOM, tea extract and ethanol in a wavelength range of 200 to 600 nm. Samples of 20 mgC/L concentration.

First, it can be observed that the non-aromatic compounds (glucose, alginate and ethanol) do not present absorption to any wavelength, which was expected. Then, it can be observed that humic acid presents absorbance in a wide wavelength (220 - 400 nm) because it is a strong aromatic molecule with different functional groups (carboxylic groups, some aromatics rings).

Regarding the Australian NOM, it can be observed that the absorbance trend is similar to that shown by humic acid, since the Australian NOM is composed mostly of humic substances. The

lower absorbance is because the Australian NOM is also constituted by other compounds, such as hydrophilic, non-aromatic compounds.

Analysing the absorbance of tannic acid, two significant peaks are identified at two different wavelengths: 213 and 276 nm. Two peaks with that strong absorbance can be related to the high aromaticity of the molecule and the phenolic groups it contains. Interestingly, the tea extract shows the same peak at a wavelength of 276 nm but with a lower intensity (lower absorbance). This suggests that tea extract possesses molecules with phenolic group's characteristic of tannic acid, and this can be explained by the fact that tea extract contains compounds such as tannins.

Finally, in tannic acid absorbance, the peak at 213 nm shows a stronger absorbance, so this signal has been used to relate it to the concentration of tannic acid (Beer-Lambert's Law). In Figure 31 it can be seen how the absorbance is directly proportional to the concentration. In addition, the calibration curve of the tannic acid in the UV spectrophotometer at a wavelength of 213 nm can be found in the appendix.

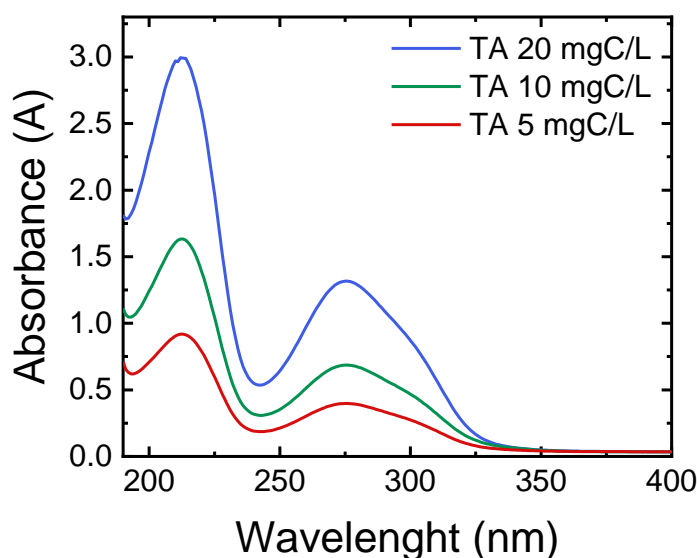

*Figure 31. Absorbance of tannic acid at different concentrations (5, 10 and 20 mgC/L) for a wavelength of 190 to 400 nm measured with the UV spectrometer.*

### 5.1.3. SUVA (Specific absorption at 254nm)

Another characterization of NOM was by the technique known as SUVA, which, as explained above, is specific absorbance at a wavelength of 254 nm. The value of absorbance at 254 nm must be divided by the dissolved organic carbon concentration of the sample to obtain the value of SUVA. This technique is used to directly relate the aromaticity of an organic compound, since it has been demonstrated that higher SUVA values correspond to higher aromaticity.

The values obtained from SUVA are presented in Table 12. These values were obtained in two ways: 1) the absorbance in the UV spectrophotometer at a wavelength of 254 nm and measuring the organic carbon concentration of the sample in the TOC analyser and 2) obtaining a value directly in the LC-OCD, as the UV detector is fixed at a wavelength of 254nm.

Table 12. SUVA values obtained by two different UV/TOC and LC-OCD methods.

	SUVA (L/mg·m)	
	UV/TOC	LC-OCD
<b>Humic acid</b>	8.09	13.19
<b>Tannic acid</b>	5.34	7.47
<b>Australian NOM</b>	2.63	4.09
<b>Tea extract</b>	2.02	0.77
<b>Alginate</b>	0.23	0.02
<b>Glucose</b>	0.19	0.62

The SUVA values obtained vary according to the method used. This is logical, since the method used to know the concentration of dissolved organic depends especially on how the compounds interact and are analysed in the TOC analyser and the LC-OCD. Even so, the trend of SUVA values is the same, being in both cases HA > TA > Australian NOM > Tea extract > Alginate / Glucose. In addition, it should be noted that this method is based on the absorption of UV light at 254 nm. As can be seen in Figure 30, at 254 nm the absorbance of tannic acid is between its two significant peaks, which explains why it has a lower SUVA value (related to a lower aromaticity) being a highly aromatic molecule as can be seen by its structure.

This is intended to emphasise that perhaps a systematic review of this technique should be carried out. On the one hand, to compare the analytical methods by which a SUVA value can be obtained, and to review whether these values can be compared in all cases, and on the other hand the review whether the absorbance at 254 nm, directly related to aromaticity, can be extrapolated to all the compounds that compose natural organic matter.

SUVA values can be related to aromaticity and to the hydrophobic and hydrophilic character of the compounds. As mentioned in chapter 3, SUVA values above 4 are related to highly hydrophobic compounds, values between 2 and 4 are related to mixed compounds with hydrophobic and hydrophilic character and values below 2 are related to hydrophilic compounds [158]. Therefore, humic acid and tannic acid can be characterized as strongly hydrophobic compounds. Australian NOM and tea extract as compounds formed by hydrophobic and hydrophilic molecules and finally glucose and alginate as completely hydrophilic compounds.

#### 5.1.4. Humidification diagram

Once the SUVA values for the organic compounds and the molecular weight of each are known, they can be related to the humidification diagram. This diagram is used to relate natural organic compounds according to their aromatic, molecular and chemical (aromaticity) characteristics. Huber et al [159] began this work by quantifying a large amount of natural waters from different sources and representing them in a humidification diagram. Thus, it was possible to establish the humidification pathway, which maintains that the humidification of compounds increases with increasing molecular weight and aromaticity (SUVA). A. Schäfer [166] in her extensive study of natural organic matter from different origins also completed this diagram by following the same humidification path.



Figure 32 shows the humidification diagram where the compounds characterized by Huber et al. [159] and Schäfer [166] are plotted, and where the surrogate NOM compounds used in this study can be seen.

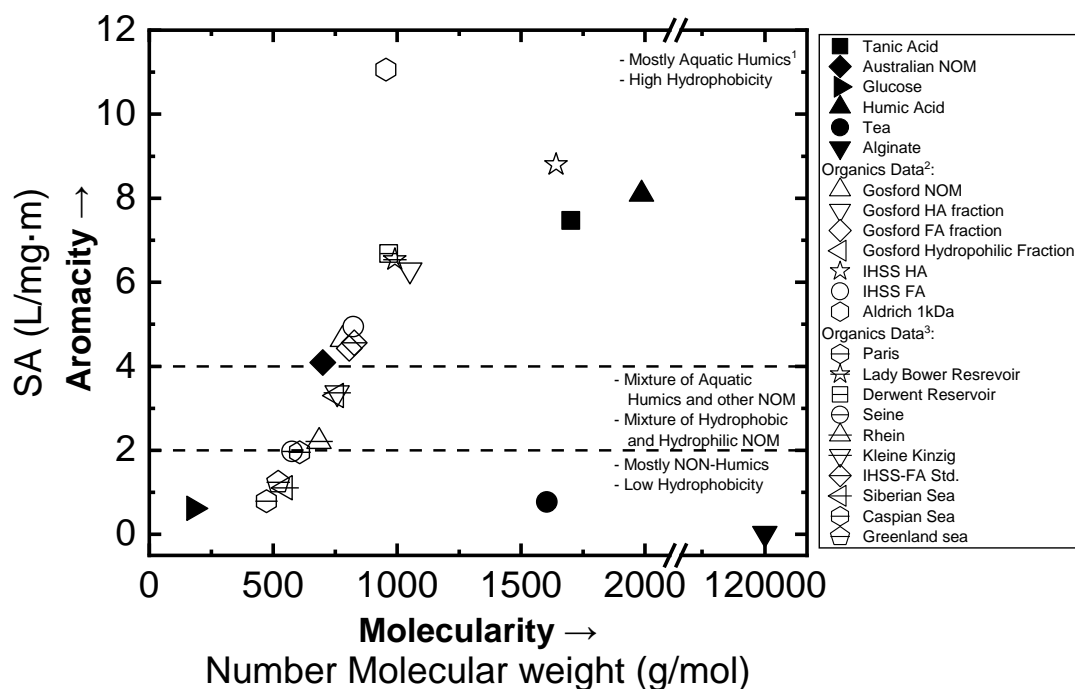

Figure 32. Humidification diagram (SUVA measured with LC-OCD). [133]<sup>1</sup> [166]<sup>2</sup> [159]<sup>3</sup>

Several conclusions can be drawn from the humidification diagram. On the one hand, it can be seen how surrogate NOM compounds are found throughout the humidification diagram, so these compounds will be analogous to those contained in natural waters. On the other hand, it is verified what had already been exposed previously, the humic acid as well as the tannic acid are hydrophobic compounds. The Australian NOM is in the range of a mixture of both hydrophobic and hydrophilic compounds, but being mostly hydrophobic compounds. Finally, glucose, alginate and tea extract are found in the area of hydrophilic compounds. The tea extract is found in this zone, since as previously mentioned, the phenolic compounds of the tea interact with the chromatographic column, remaining retained in it and this would explain its low aromaticity value and hence its position in the humidification diagram.

Once the NOM surrogate compounds used in this work have been characterized in depth, the results obtained for the removal of steroid hormones are discussed below.

## 5.2 Hormone removal by UF-SWCNTs membranes

In the first step, the removal of four different steroid hormones (Estrone (E1), Estradiol (E2), Progesterone (P) and Testosterone (T)) by UF-SWCNTs composite membranes were evaluated. In this case, the membranes (100 kDa Ultracel) had the role of holding the SWCNTs, since due to their high MWCO, the membranes by themselves are not able to remove micropollutants.

The results obtained are shown in Figure 33, which represents the hormone breakthrough in the permeate and the removal efficiency.

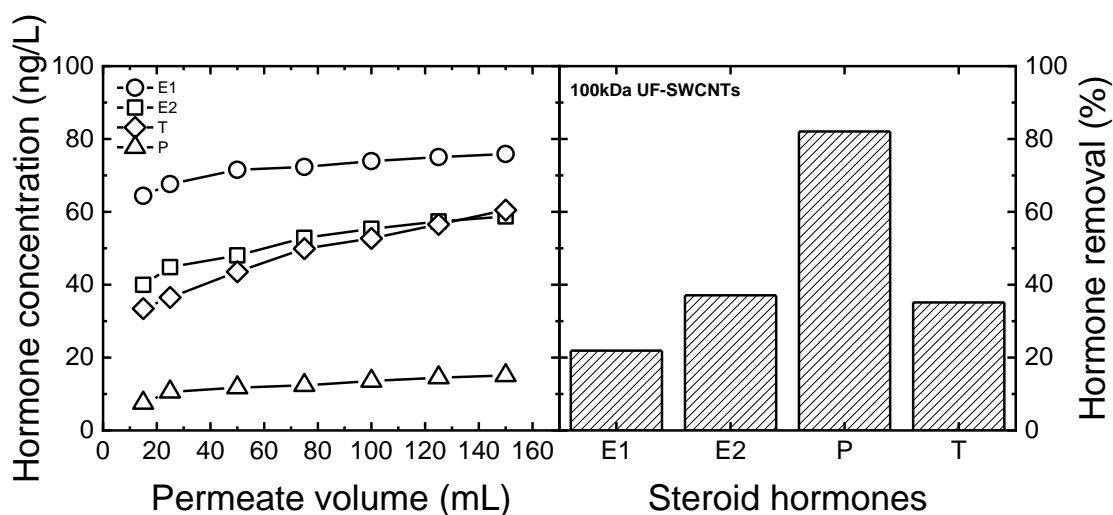

Figure 33. Left: Hormone (E1, E2, T and P) permeate concentration vs permeate volume (feed concentration  $\sim 95$  ng/L), Right: Hormone (E1, E2, T and P) removal. Filtration test with 100 kDa UF-SWCNTs ( $2 \text{ g/m}^2$  CNPs, 1 bar).

In view of the results, it can be seen how the CNPs are better predisposed to adsorb some compounds better than others. In this case, progesterone (P) is the one with the best elimination by CNPs, followed by T and E2 with similar adsorption and finally E1, which shows low adsorption by CNPs. These differences can be explained based on differences in the structure of the four steroid hormones. E1 and E2 hormones have the same base structure, so the aromaticity and ability to form  $\pi$ - $\pi$  bonds is practically the same. On the other hand, P and T do not have aromatic ring in his structure, and the double bond is probably not causing pi-pi interaction. Nevertheless, their great difference is due to the free functional groups they have. Thus, the progesterone is the only one that has groups -O in the two edges of the molecule reason why it has more free hydrogens in his structure (18 X-H bonds). Because of this it is able to form more H bonds, and therefore to improve the adsorption in the CNPs by means of H bonds. Oppositely, E1 is the hormone that presents the least free hydrogens in its structure (11 X-H bonds), which explains why it has the least capacity to form hydrogen bonds with CNPs and therefore results in less absorption.

Analysing the results, it can be observed how hydrogen bonds play a very important role in the adsorption of estrogenic compounds in CNPs. This is important for the study of the different mechanisms of adsorption and estrogen-CNPs interactions and may give an idea of how steroid hormones behave in adsorption by CNPs.

Finally, with regard to removal efficiencies, the removal of steroid hormones by UF-SWCNTs depends on the compound under study. For progesterone there is an elimination above 80%,

for E2 and T the elimination decreases to 35% and finally E1 presents a removal of 20%. These efficiencies could perhaps be improved in two ways: a greater amount of SWCNTs in the membrane could better adsorb steroid hormones or a longer residence time between hormones and SWCNTs could improve adsorption. The latter could be achieved with lower membrane MWCOs, but this case will be discussed in subsequent sections.

### 5.3 Interference of natural organic matter in E2 removal by CNPs

In a second step, the effect of natural organic matter on the removal of steroid hormones was investigated. For this, the hormone E2 was chosen to carry out filtration tests. As natural organic matter the 6 different NOM surrogates characterized in depth above were used. In addition, the membrane chosen in this case was a 100kDa molecular cut-off. This MWCO was chosen because it is far over the molecular weight of the organic compounds used (except in the case of alginate) and therefore, the only function it has is to hold the CNPs, which allows observing the interaction when the NOM comes into contact with the estrogenic compounds (E2) and the CNPs.

Figure 34 shows the E2 breakthrough in the permeate volume and the removal of E2, when natural organic matter is found in the feed. This allows studying the existence of NOM interferences in the removal of E2 by CNPs adsorption.

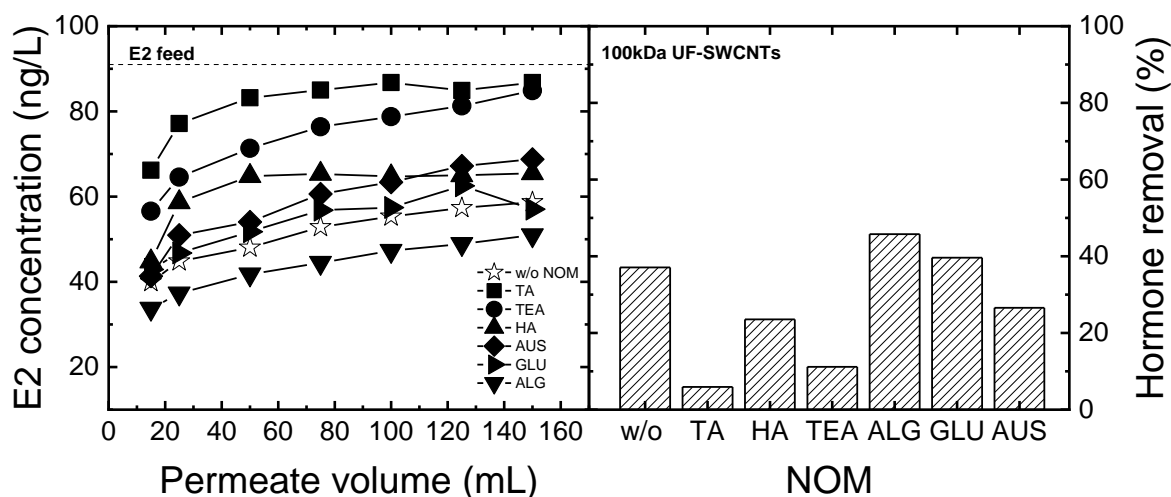

Figure 34. Left: E2 permeate concentration vs permeate volume (E2 feed concentration ~95 ng/L), Right: E2 removal. Filtration test with 100 kDa UF-SWCNTs (2 g/m<sup>2</sup> CNPs, 1 bar) with different NOM surrogates: HA, TA, Glu, Alg, Aus and Tea (feed concentration 10 mc/L) and one without NOM (hollow points).

When the breakthrough of E2 in the permeate is analysed in the different filtration tests, it can be seen how the greater difference between the E2 removal with NOM and E2 removal without NOM occurs for tannic acid. In the presence of tannic acid, the removal of E2 decreases significantly (from 35% to approx. 5%). The strong interference of tannic acid in the adsorption of E2 by CNPs can be explained by the characteristics of this compound. Thus, as explained in chapter 2 and in the characterization of NOM in the first section of this chapter, tannic acid is a polyphenol with many aromatic rings, and therefore a highly hydrophobic compound with great aromaticity. As a result, the ability of this compound to form  $\pi$ - $\pi$  bonds as well as hydrogen bonds is exceptionally high. Because of this, the affinity for being adsorbed by CNPs is very strong.

Furthermore, the interaction model between tannic acid and CNPs suggests that it can form multilayers on the surface of CNPs [170]. This could explain a shielding/blinding effect of tannic acid on the adsorption of estrogenic hormones in CNPs. In this process, tannic acid may be competing for adsorption sites on the surface of the CNPs with steroid hormones and tannic acid, in this case, has much more capacity to form  $\pi$ - $\pi$  bonds and H bonds. Moreover, the differences in the concentrations of these two compounds (mg vs. ng) that may cause tannic acid to occupy all CNPs adsorption sites causing estrogenic hormones not to be adsorbed in the CNPs, and therefore not be removed.

Finally, other NOM compounds also show interferences in the removal of E2 by CNPs. This interference is smaller, and corresponds to the characteristics of each compound. The tea extract, for example, also presents some of the greatest interferences in the removal of E2, underlining the importance of phenolic groups with aromatic rings in the adsorption by CNPs. These results help to better understand the strong affinity that aromatic compounds have in adsorption by CNPs. Hydrophobic compounds such as humic acid and Australian NOM also have interference but at a lower rate. Non-aromatic compounds and low molecular weight such as glucose are not adsorbed by CNPs. Finally, alginate differs in removal interference, showing a greater removal of E2 when it is present. This can be explained by its high molecular weight, which suggests that it remains on the surface of the membrane, blocking the pores of the membrane and therefore improving removal by blocking the penetration of estrogenic compounds through the membrane.

Figure 35 shows the variation of NOM in the feed and permeate. With this graph it is possible to notice that the NOM is not retained by the membrane. NOM concentrations were analysed with the LC-OCD and the UV spectrophotometer (tannic acid).

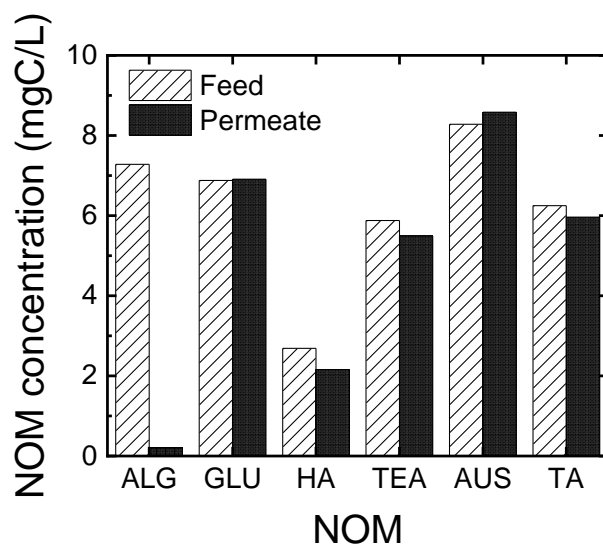

Figure 35. Variation of NOM concentration in E2 filtration test with 100 kDa UF-SWCNTs (2 g/m<sup>2</sup> CNPs, 1 bar). NOM concentration measured with LC-OCD and UV spectrophotometer.

#### 5.4 Interference of tannic acid in hormone removal by CNPs

After it was confirmed that tannic acid was the NOM surrogate compound with the greatest interference in the adsorption of E2 by CNPs, different filtration tests were carried out with other steroid hormones (E1, P & T) with tannic acid, to determine whether the interference of tannic acid is the same for different steroid compounds.

In Figure 36 the breakthrough of different hormones in the permeate during filtration tests is compared for tests without the presence of tannic acid and with the presence of tannic acid. This allows validating the interference of the TA in the adsorption of different steroid hormones by CNPs.

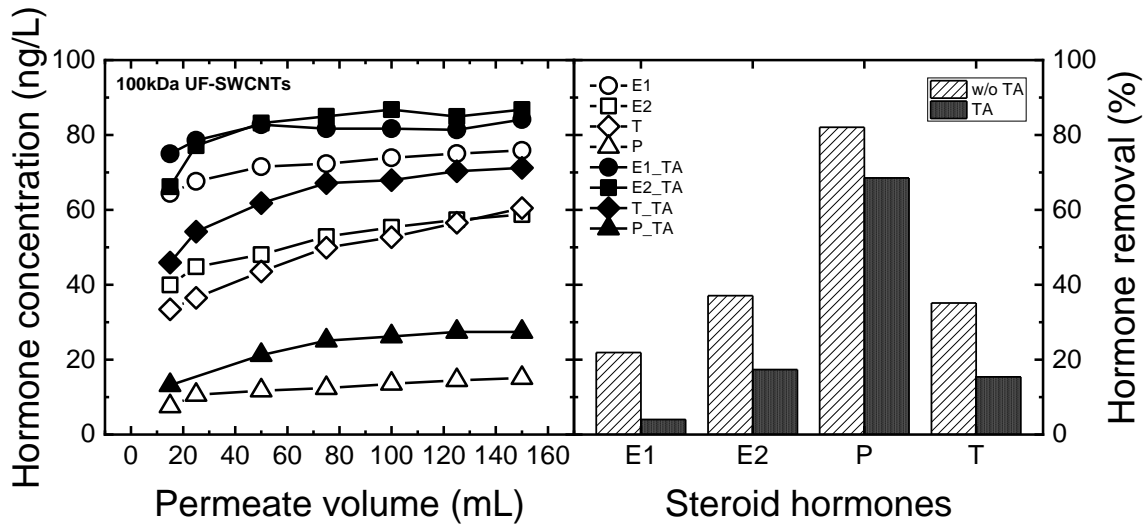

Figure 36. Left: Hormone (E1, E2, T and P) permeate concentration vs permeate volume (feed concentration ~95 ng/L), Right: Hormone (E1, E2, T and P) removal. Filtration test with 100 kDa UF-SWCNTs (2 g/m<sup>2</sup> CNPs, 1 bar) with and without tannic acid (feed concentration 10 mgC/L).

If the results obtained are analysed, it can be confirmed that TA interference is similar in the adsorption of different steroid hormones by CNPs. This comparison also allows elucidating the interactions between TA and steroid hormones. As discussed in Chapter 3, interactions between NOM and steroid compounds are very likely to occur. In addition, tannic acid, being a molecule with a large number of aromatic rings, has a great predisposition to form  $\pi$ - $\pi$  bonds and especially H bonds with steroid compounds. In view of the results, this is not happening or at least not significantly, because if it were the case, the concentration of hormones in the permeate would be reduced by the effect of TA-hormone interaction. Therefore, one interaction model that may be suggested in this scenario is the non-TA-hormone interaction, because of the strong TA-CNPs affinity, which causes the tannic acid to contact the surface of the CNPs to form  $\pi$ - $\pi$  bonds and H bonds, and not to create interactions with steroid hormones.

Finally, Figure 37 shows the variation in the concentration of tannic acid from the feed to the permeate. As can be seen, the tannic acid is not retained through the membrane (100kDa).

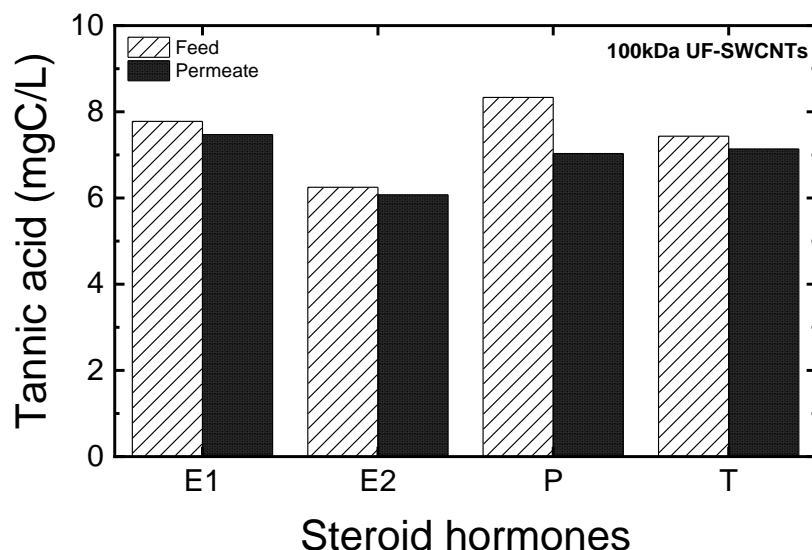

Figure 37. Variation of TA concentration in E1, E2, P & T filtration tests with 100 kDa UF-SWCNTs (2 g/m<sup>2</sup> CNPs, 1 bar). TA concentration measured with UV spectrophotometer.

### 5.5 Effect of flux on E2 removal by UF-SWCNTs

The effect of flux, and therefore the residence time was intended to be verified in the presence of tannic acid. The purpose is to see whether the interference of tannic acid depends on the time it is in contact with UF-SWCNTs. For this purpose, E2 filtration tests were carried out in the presence of tannic acid at different pressures (0.5, 1, 2, 3 & 4 bar), with the SWCNT composite of a specific membrane (MWCO 10 kDa).

The pressure is directly related to the flux, since the higher the pressure the higher the flux is expected, due to the fact that the pressure is the driving force in UF processes. Hence, the residence time, which is inversely proportional to the flux, will decrease as the pressure increases. In addition, the expected effect of the residence time is to improve adsorption when it is greater, since the contact time between the CNTs and the hormone increases promoting adsorption.

Therefore, Figure 38 shows the results of these tests. The E2 breakthrough in the presence of tannic acid is shown for the different pressures (0.5, 1, 2, 3 & 4 bar). It is also compared with the breakthrough of the E2 in the absence of tannic acid at a pressure of one bar. In addition, the flux associated to the different pressures is also shown and compared with the removal of E2.

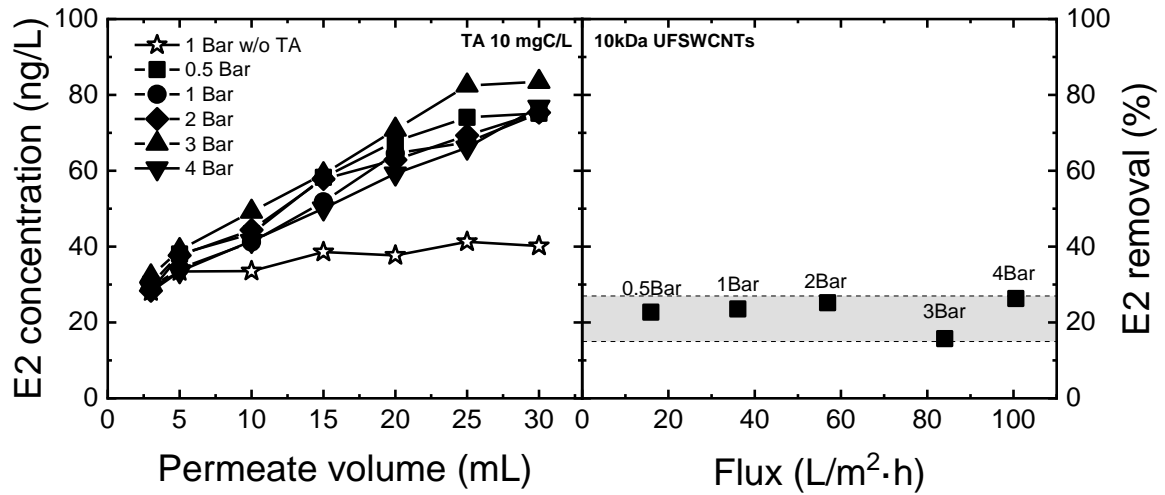

Figure 38. Left: Permeate concentration of E2 (initial concentration 100 ng/L, with tannic acid (10 mgC/L) and without) in UF-SWCNTs filtration (CNPs 2 g/m<sup>2</sup>, UF Ultracel 10 kDa) at several pressures (0.5, 1, 2, 3 & 4 bar). Right: Fluxes associated with different pressures vs. E2 removal.

In the presence of tannic acid, the same interference can be observed for different operating pressures, and thus for different fluxes and residence times between hormone-CNPs. This result simply confirms once again the strong interference of tannic acid in the adsorption of E2 by CNPs. The conclusions that can be extracted from this result are that tannic acid may be quickly adsorbed by the CNPs, and/or tannic acid and E2 interact strongly and prevent adsorption from SWCNTs.

The same can be observed in figure 39, where the concentration and adsorbed mass of E2 in the presence of tannic acid versus residence time is shown. As can be seen, the adsorbed mass is similar for different residence times in the range 8 – 52 s, so the effect of residence time in this range on adsorption is not observed in the presence of tannic acid. However, it can be expected that a shorter residence time than 8 s might reduce adsorption of SWCNT through limitation of mass transfer.

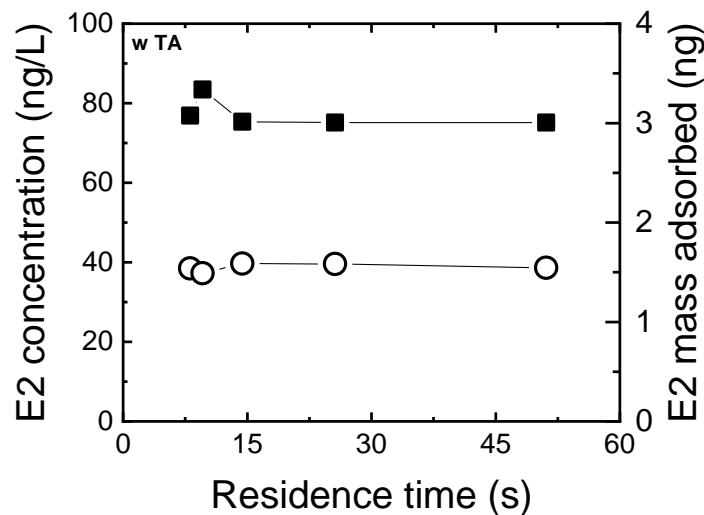

Figure 39. E2 permeate concentration and mass adsorbed in UF-SWCNTs filtration (CNPs 2 g/m<sup>2</sup>, UF Ultracel 10 kDa) at several pressures (0.5, 1, 2, 3 & 4 bar) versus the residence time.

### 5.6 Shielding effect of tannic acid by different MWCOs of UF-SWCNTs membranes.

After the results shown in the previous sections, it is evidenced that in the presence of tannic acid the removal of steroid hormones by means of CNPs is compromised. For this reason, this study seeks a shielding effect of tannic acid using SWCNT-UF composite membranes. The main concern that arises is the low molecular weight of tannic acid (1701Da), compared to the MWCO of UF membranes that are often used. Even so, different membrane MWCOs were tested (100, 30, 10 and 5kDa), since the smaller the pore size the greater the probability of retention of tannic acid.

When membranes of different MWCOs are used, the flux is also modified; hence, the residence time between steroid hormones and CNPs is affected. Therefore, the first target of this chapter is to observe if different MWCOs of composite membrane (hence different transmembrane fluxes and residence times) show differences in E2 removal.

Figure 40 shows the removal of E2 and the residence time for tests carried out with different membrane pore size (5, 10, 30 and 100 kDa) with and without the presence of tannic acid.

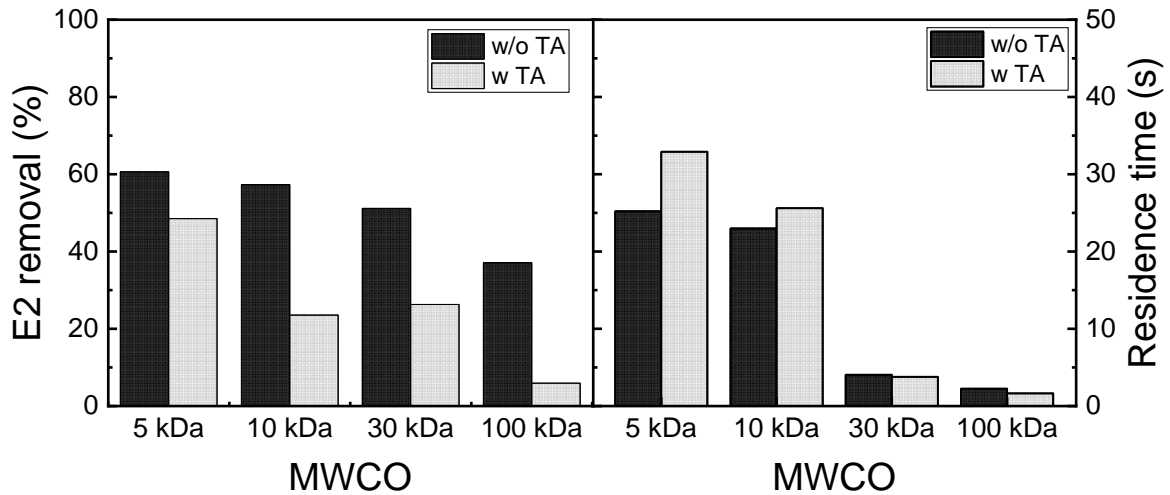

Figure 40. Left: E2 removal in UF-SWCNTs filtration tests (CNPs 2g/m<sup>2</sup>, UF Ultracel 5, 10, 30 and 100 kDa) with and without tannic acid (10 mgC/L). Right: Residence time of filtration tests with different MWCO membranes (5, 10, 30 and 100 kDa) with and without tannic acid (10 mgC/L).

As can be seen, for membranes with smaller pore size and longer residence time the removal of E2 is higher when there is no presence of tannic acid. E2 removal is relatively low with 100 kDa, when the residence time (2.5 s) stays outside the above-mentioned range (8 – 52 s). Therefore, there is the decrease of E2 removal upon short residence time in the presence of TA, but unfortunately, residence time of < 8 s has not been studied in Section 5.5. In the presence of TA, E2 removal shows decreasing trend with increasing MWCO, which arises because of TA blockage. As the blockage of tannic acid increases with the decrease in pore size of the membranes, there is less TA in contact with SWCNT to cause interference.



Therefore, the effect of the residence time on E2 adsorption in the presence of tannic acid cannot be directly concluded because residence times outside the range 8-52 need further testing. However, it can be verified that when the membrane can retain tannic acid, its interference is less, and therefore, the interference in the removal of E2 is reduced, as explained below.

Figure 41 shows the breakthrough of E2 (with and without tannic acid) as a function of permeate volume for membranes of different MWCO, which provides information about the shielding effect of tannic acid by UF-SWCNTs composite membranes. Moreover, it shows the development of the concentration of tannic acid as a function of the volume of permeate, which provides information on the retention of TA by membranes of different MWCO.

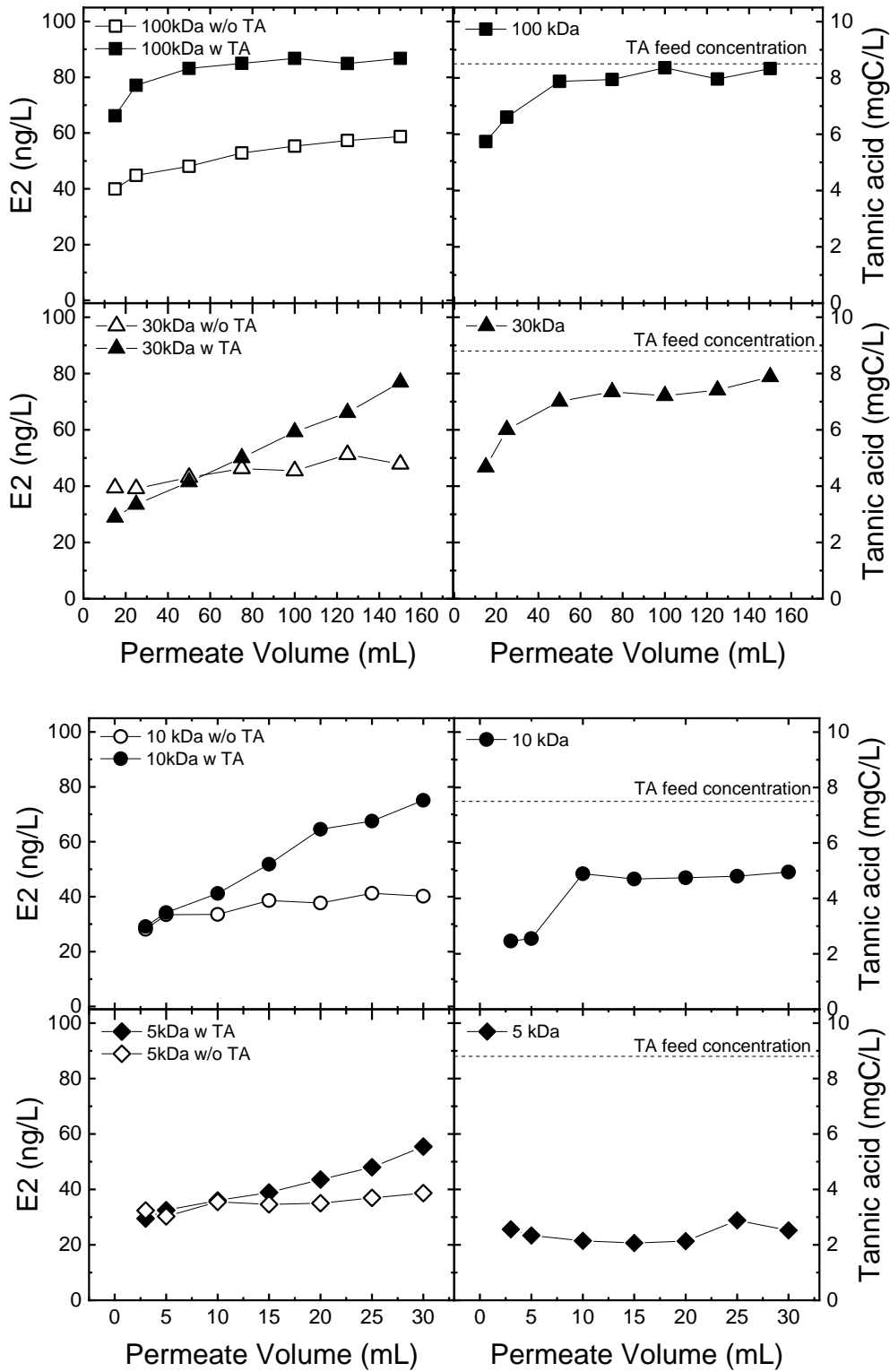

Figure 41. Left: Permeate concentration of E2 (initial concentration 100 ng/L, with tannic acid (10 mgC/L) and without) in UF-SWCNTs filtration (CNPs 2g/m<sup>2</sup>, UF Ultracel 5, 10, 30 and 100 kDa). Right: Permeate concentration of TA for membranes of 5, 10, 30 and 100 kDa.

Several results can be extracted from the previous graph when analyses in detail. First, it can be seen how there is a clear shielding effect of the UF membrane by reducing the MWCO. It is

possible to confirm with the breakthrough of E2 in the different MWCO tests, as with the 5kDa membrane the breakthrough of E2 achieved in the presence of tannic acid is quite comparable to that obtained without the presence of tannic acid. This is significantly different if the MWCO is higher, since the shielding effect is reduced or non-existent and hence the interference of the TA is clearly noticeable.

Subsequently, it can be observed how tannic acid also presents a breakthrough curve in the filtration tests. This is especially remarkable, as it indicates a possible adsorption effect, followed by a diffusion effect. This breakthrough curve is clearer the higher the MWCO of the membrane, being not visible in the filtration test with the 5kDa membrane. This can be explained because of the nearly complete retention of tannic acid by the membrane.

Moreover, it can be observed how the effect of the TA is present even at low concentrations (2mgC/L for the 5kDa test). In addition, the breakthrough curves of E2 when TA is in presence have a peculiarly upward trend during the filtration. This again, can be explained by the adsorption of TA in the CNPs, blocking the adsorption sites and avoiding the adsorption of E2 in the surface of the CNPs. This does not occur for the 100kDa membrane, since the interference is total from the first moment by not retaining the tannic acid at all. For membranes with lower MWCO it can be observed how the interference increases as the filtration advances.

### 5.7 Suggested interference mechanism.

At this point and in view of the results obtained, two different mechanisms can be suggested in the interference of tannic acid. On the one hand, a suggested mechanism is that of hormone-tannic acid interaction. This mechanism would explain why the removal of hormones is reduced in the presence of tannic acid and why the concentration of tannic acid is not reduced. According to this suggested mechanism, tannic acid would interact with steroid hormones, joining with them forming  $\pi$ - $\pi$  bonds and H bonds and through SWCNTs without being adsorbed, maybe because of the high concentration of TA compared to hormone concentration. On the other hand, another suggested mechanism could be the strong adsorption of tannic acid by the SWCNTs and therefore, a blockage of the SWCNTs adsorption sites could be occurring blocking the adsorption of the hormones.

Finally, the use of ultrafiltration membranes can avoid this interference when a suitable MWCO of membrane is used. The membrane would act by blocking the passage of organic matter, in this case, tannic acid, avoiding its interference.

Figure 42 shows the suggested mechanisms of adsorption and interference of tannic acid, as well as the effect of UF membranes.

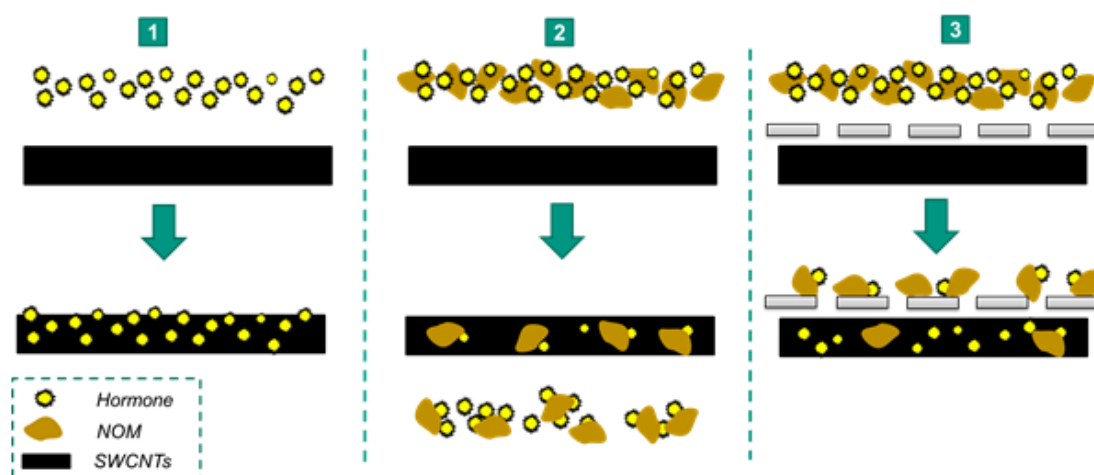

Figure 42. 1) Expected adsorption of steroid hormones in SWCNTs. 2) In the presence of interfering NOM two suggested mechanisms: Hormone-NOM reducing adsorption in SWCNTs and NOM-SWCNTs blocking adsorption sites. 3) Effect of UF membranes shielding, blocking NOM.

Even so, the interactions between tannic acid, phenolic compound, highly aromatic and hydrophobic, natural steroid hormones and SWCNTs must be further researched to understand in depth the mechanisms of interaction and how they can be avoided.

## **CHAPTER 6. CONCLUSIONS AND OUTLOOK**

In this study some interesting surrogate NOM compounds have been studied to characterize different types of Natural Organic Matter. The effect of NOM on the adsorption of steroid hormones by CNPs has also been studied. Furthermore, the shielding effect that novel UF-SWCNTs composite membranes have on natural organic matter has been investigated, and how these can prevent NOM interferences in the adsorption of steroid hormones by CNPs.

Therefore, after the results have been reported and analysed, the following conclusions and outlook can be extracted:

- ✓ It is essential to know the characteristics of natural organic matter in order to understand how it will behave in response to a variety of treatments and analytical methods.
- ✓ The LC-OCD technique is a precise method for characterizing the different NOM fractions, but attention should be paid to highly aromatic and hydrophobic compounds that are retained in the column, and therefore not detectable. Coupled analytical methods, such as UV analysis prior to LC-OCD, could be explored to jointly detect highly aromatic compounds and analyse NOM fractions.
- ✓ Tannic acid, due to its phenolic structure with a large number of aromatic rings, has a high hydrophobicity and aromaticity. Thus, it has special properties compared to other types of NOM (hydrophilic and non-aromatic compounds), and are capable of building strong  $\pi$ - $\pi$  bonds and H bonds, which are characteristic in most adsorption interactions with other organic compounds and adsorbent materials. Research with its derived compounds such as tannins, which can be found in plants, seeds and leaves and which are present in a large number of natural compounds, such as tea, wine or different species and fruits could be very interesting to further the understanding of NOM in aquatic environments.
- ✓ The adsorption of steroid hormones in CNPs depends significantly on the functional groups of steroid hormones, being promoted by the ability to form  $\pi$ - $\pi$  interactions and H bonds. Adsorption of steroid hormones by CNPs has been observed to be higher for progesterone (P), followed by Estradiol (E2) and Testosterone (T) and finally Estrone (E1).
- ✓ There is a high interference of tannic acid in the adsorption of steroid hormones by CNPs due to its strong affinity for forming  $\pi$ - $\pi$  bonds and H bonds with CNPs. Models of interaction of tannic acid with CNPs may explain the competition and blockage of tannic acid against steroid hormones on CNP adsorption sites. On the other hand, interactions between steroid hormones and tannic acid may be suggested, as they also have a high predisposition to form H-bonds. These interactions can reduce the adsorption of hormones by SWCNTs, as they would be interacting with tannic acid thus avoiding their adsorption in SWCNTs.
- ✓ The effect of residence time on adsorption is not observed in the presence of tannic acid in the range studied (8 – 52 s). However, it can be expected that a shorter residence time than 8 s might reduce adsorption of SWCNT through limitation of mass transfer. Therefore, the effect of the residence time on E2 adsorption in the presence of tannic acid cannot be directly concluded because residence times outside the range 8-52 need

further testing. Hence, an in-depth study of the effect of residence time in a wider range would help to better understand the interference mechanisms of tannic acid.

- ✓ Novel composite UF-SWCNTs membranes are capable of shielding SWCNTs from NOMs such as tannic acid, if a proper MWCO membrane size is selected for NOM retention. Research with these membranes is still required to understand how shielding can be optimized, since the molecular weight of NOM compounds plays a very important role in membrane retention and therefore, the shielding effect is enhanced when the molecular weight of the NOM is higher.

## **CHAPTER 7. REFERENCES**

- [1] T. Colborn, F.S. Vom Saal, A.M. Soto, Developmental effects of endocrine-disrupting chemicals in wildlife and humans, *Environmental health perspectives*, 101 (1993) 378-384.
- [2] G.T. Ankley, J.P. Giesy, Endocrine disruptors in wildlife: a weight of evidence perspective, *Principles and processes for evaluating endocrine disruption in wildlife*. SETAC Press, Pensacola, Florida, (1998) 349-367.
- [3] E.R. Kabir, M.S. Rahman, I. Rahman, A review on endocrine disruptors and their possible impacts on human health, *Environ Toxicol Pharmacol*, 40 (2015) 241-258.
- [4] E. Diamanti-Kandarakis, J.P. Bourguignon, L.C. Giudice, R. Hauser, G.S. Prins, A.M. Soto, R.T. Zoeller, A.C. Gore, Endocrine-disrupting chemicals: an Endocrine Society scientific statement, *Endocr Rev*, 30 (2009) 293-342.
- [5] A. Kortenkamp, O. Martin, M. Faust, R. Evans, R. McKinlay, F. Orton, E. Rosivatz, State of the art assessment of endocrine disrupters, Final report, 23 (2011).
- [6] J. McLachlan, Environmental signaling: from environmental estrogens to endocrine-disrupting chemicals and beyond, *Andrology*, 4 (2016) 684-694.
- [7] R. Hampl, J. Kubatova, L. Starka, Steroids and endocrine disruptors--History, recent state of art and open questions, *J Steroid Biochem Mol Biol*, 155 (2016) 217-223.
- [8] M. Schriks, M.B. Heringa, M.M. van der Kooi, P. de Voogt, A.P. van Wezel, Toxicological relevance of emerging contaminants for drinking water quality, *Water research*, 44 (2010) 461-476.
- [9] H. Sanderson, Presence and risk assessment of pharmaceuticals in surface water and drinking water, *Water Science and Technology*, 63 (2011) 2143-2148.
- [10] D. Fatta, A. Achilleos, A. Nikolaou, S. Meric, Analytical methods for tracing pharmaceutical residues in water and wastewater, *TrAC Trends in Analytical Chemistry*, 26 (2007) 515-533.
- [11] M. Locatelli, F. Sciascia, R. Cifelli, L. Malatesta, P. Bruni, F. Croce, Analytical methods for the endocrine disruptor compounds determination in environmental water samples, *J Chromatogr A*, 1434 (2016) 1-18.
- [12] F.A. Caliman, M. Gavrilesco, Pharmaceuticals, Personal Care Products and Endocrine Disrupting Agents in the Environment - A Review, *CLEAN - Soil, Air, Water*, 37 (2009) 277-303.
- [13] S.Y. Wee, A.Z. Aris, Endocrine disrupting compounds in drinking water supply system and human health risk implication, *Environ Int*, 106 (2017) 207-233.
- [14] A.C. Gore, D. Crews, L.L. Doan, M. La Merrill, H. Patisaul, A. Zota, Introduction to endocrine disrupting chemicals (EDCs), A Guide for Public Interest Organizations and Policy-Makers; Endocrine Society: Washington, DC, USA, (2014).
- [15] B. Kudlak, J. Namieśnik, Environmental fate of endocrine disrupting compounds—analytical problems and challenges, *Critical Reviews in Analytical Chemistry*, 38 (2008) 242-258.
- [16] WHO - UNEP, State of the science of endocrine disrupting chemicals-2012, Geneva: World Health Organization, United Nations Environment Programme, (2013).
- [17] W.H. Organization, Global assessment of the state-of-the-science of endocrine disruptors, International Program on Chemical Safety, (2002).
- [18] E.P.A. (EPA), Contaminant Candidate List (CCL3) and unregulated contaminant monitoring rule (UCMR 3), (2015).
- [19] M.O. Barbosa, N.F. Moreira, A.R. Ribeiro, M.F. Pereira, A.M. Silva, Occurrence and removal of organic micropollutants: an overview of the watch list of EU Decision 2015/495, *Water research*, 94 (2016) 257-279.
- [20] R.P. Schwarzenbach, B.I. Escher, K. Fenner, T.B. Hofstetter, C.A. Johnson, U. Von Gunten, B. Wehrli, The challenge of micropollutants in aquatic systems, *Science*, 313 (2006) 1072-1077.
- [21] M. Rahman, E. Yanful, S. Jasim, Endocrine disrupting compounds (EDCs) and pharmaceuticals and personal care products (PPCPs) in the aquatic environment: implications

- for the drinking water industry and global environmental health, *Journal of Water and Health*, 7 (2009) 224-243.
- [22] R.D. Briciu, A. Kot-Wasik, J. Namiesnik, Analytical challenges and recent advances in the determination of estrogens in water environments, *Journal of chromatographic science*, 47 (2009) 127-139.
- [23] S.D. Richardson, T.A. Ternes, *Water analysis: emerging contaminants and current issues*, *Analytical chemistry*, 86 (2014) 2813-2848.
- [24] C.M. Villanueva, M. Kogevinas, S. Cordier, M.R. Templeton, R. Vermeulen, J.R. Nuckols, M.J. Nieuwenhuijsen, P. Levallois, Assessing exposure and health consequences of chemicals in drinking water: current state of knowledge and research needs, *Environmental health perspectives*, 122 (2014) 213-221.
- [25] R.J. Kavlock, G.P. Daston, C. DeRosa, P. Fenner-Crisp, L.E. Gray, S.K. Lucier, M. Luster, M.J. Mac, C. Maczka, R. Miller, J. Moore, R. Rolland, G. Scott, D.M. Sheehan, T. Sinks, H.A. Tilson, Research needs for the assessment of health and environmental effects of endocrine disruptors: a report of the U.S. EPA-sponsored workshop.pdf, *Environmental Health Perspectives*, 104 (1996) 715-750.
- [26] L. Racz, R.K. Goel, Fate and removal of estrogens in municipal wastewater, *Journal of Environmental Monitoring*, 12 (2010) 58-70.
- [27] R.L. Gomes, M.D. Scrimshaw, J.N. Lester, Determination of endocrine disrupters in sewage treatment and receiving waters, *TrAC Trends in Analytical Chemistry*, 22 (2003) 697-707.
- [28] Z.H. Liu, Y. Kanjo, S. Mizutani, Removal mechanisms for endocrine disrupting compounds (EDCs) in wastewater treatment - physical means, biodegradation, and chemical advanced oxidation: a review, *Sci Total Environ*, 407 (2009) 731-748.
- [29] Y. Luo, W. Guo, H.H. Ngo, L.D. Nghiem, F.I. Hai, J. Zhang, S. Liang, X.C. Wang, A review on the occurrence of micropollutants in the aquatic environment and their fate and removal during wastewater treatment, *Science of the total environment*, 473 (2014) 619-641.
- [30] S. Esplugas, D.M. Bila, L.G.T. Krause, M. Dezotti, Ozonation and advanced oxidation technologies to remove endocrine disrupting chemicals (EDCs) and pharmaceuticals and personal care products (PPCPs) in water effluents, *Journal of hazardous materials*, 149 (2007) 631-642.
- [31] W.H. Organization, *Pharmaceuticals in drinking-water*, (2012).
- [32] J. Wang, S. Wang, Removal of pharmaceuticals and personal care products (PPCPs) from wastewater: a review, *Journal of Environmental Management*, 182 (2016) 620-640.
- [33] D. Zhang, R.M. Gersberg, W.J. Ng, S.K. Tan, Removal of pharmaceuticals and personal care products in aquatic plant-based systems: a review, *Environmental Pollution*, 184 (2014) 620-639.
- [34] K.M. Onesios, T.Y. Jim, E.J. Bouwer, Biodegradation and removal of pharmaceuticals and personal care products in treatment systems: a review, *Biodegradation*, 20 (2009) 441-466.
- [35] Y. Yoon, P. Westerhoff, S.A. Snyder, E.C. Wert, J. Yoon, Removal of endocrine disrupting compounds and pharmaceuticals by nanofiltration and ultrafiltration membranes, *Desalination*, 202 (2007) 16-23.
- [36] L.D. Nghiem, A. Manis, K. Soldenhoff, A.I. Schäfer, Estrogenic hormone removal from wastewater using NF/RO membranes, *J Membrane Sci*, 242 (2004) 37-45.
- [37] S.A. Snyder, S. Adham, A.M. Redding, F.S. Cannon, J. DeCarolis, J. Oppenheimer, E.C. Wert, Y. Yoon, Role of membranes and activated carbon in the removal of endocrine disruptors and pharmaceuticals, *Desalination*, 202 (2007) 156-181.
- [38] M. Tagliavini, F. Engel, P.G. Weidler, T. Scherer, A.I. Schäfer, Adsorption of steroid micropollutants on polymer-based spherical activated carbon (PBSAC), *Journal of hazardous materials*, 337 (2017) 126-137.



- [39] A. Imbrogno, J. Biscarat, A.I. Schäfer, Estradiol uptake in a combined magnetic ion exchange - ultrafiltration (MIEX-UF) process during water treatment, *Current Pharmaceutical Design*, 23 (2017) 328-337.
- [40] A.I. Schäfer, I. Akanyeti, A.J. Semiao, Micropollutant sorption to membrane polymers: A review of mechanisms for estrogens, *Adv Colloid Interface Sci*, 164 (2011) 100-117.
- [41] C. Jung, A. Son, N. Her, K.-D. Zoh, J. Cho, Y. Yoon, Removal of endocrine disrupting compounds, pharmaceuticals, and personal care products in water using carbon nanotubes: A review, *Journal of Industrial and Engineering Chemistry*, 27 (2015) 1-11.
- [42] Q. Zaib, I.A. Khan, N.B. Saleh, J.R. Flora, Y.-G. Park, Y. Yoon, Removal of bisphenol A and 17 $\beta$ -estradiol by single-walled carbon nanotubes in aqueous solution: adsorption and molecular modeling, *Water, Air, & Soil Pollution*, 223 (2012) 3281-3293.
- [43] S. Ali, S.A.U. Rehman, H.-Y. Luan, M.U. Farid, H. Huang, Challenges and opportunities in functional carbon nanotubes for membrane-based water treatment and desalination, *Science of the Total Environment*, (2018).
- [44] X. Ren, C. Chen, M. Nagatsu, X. Wang, Carbon nanotubes as adsorbents in environmental pollution management: a review, *Chemical Engineering Journal*, 170 (2011) 395-410.
- [45] R. Thines, N. Mubarak, S. Nizamuddin, J. Sahu, E. Abdullah, P. Ganesan, Application potential of carbon nanomaterials in water and wastewater treatment: a review, *Journal of the Taiwan Institute of Chemical Engineers*, 72 (2017) 116-133.
- [46] V.K. Upadhyayula, S. Deng, M.C. Mitchell, G.B. Smith, Application of carbon nanotube technology for removal of contaminants in drinking water: a review, *Sci Total Environ*, 408 (2009) 1-13.
- [47] S. Boncel, J. Kyzioł-Komosińska, I. Krzyżewska, J. Czupioł, Interactions of carbon nanotubes with aqueous/aquatic media containing organic/inorganic contaminants and selected organisms of aquatic ecosystems—a review, *Chemosphere*, 136 (2015) 211-221.
- [48] A.M. Jastrzębska, P. Kurtycz, A.R. Olszyna, Recent advances in graphene family materials toxicity investigations, *Journal of Nanoparticle Research*, 14 (2012) 1320.
- [49] G. Ersan, Y. Kaya, O.G. Apul, T. Karanfil, Adsorption of organic contaminants by graphene nanosheets, carbon nanotubes and granular activated carbons under natural organic matter preloading conditions, *Science of the Total Environment*, 565 (2016) 811-817.
- [50] X. Wang, S. Tao, B. Xing, Sorption and competition of aromatic compounds and humic acid on multiwalled carbon nanotubes, *Environmental science & technology*, 43 (2009) 6214-6219.
- [51] F.-f. Liu, S.-g. Wang, J.-l. Fan, G.-h. Ma, Adsorption of natural organic matter surrogates from aqueous solution by multiwalled carbon nanotubes, *The Journal of Physical Chemistry C*, 116 (2012) 25783-25789.
- [52] A. Naghizadeh, S. Nasserri, A.M. Rashidi, R. Rezaei Kalantary, R. Nabizadeh, A.H. Mahvi, Adsorption kinetics and thermodynamics of hydrophobic natural organic matter (NOM) removal from aqueous solution by multi-wall carbon nanotubes, *Water Science and Technology: Water Supply*, 13 (2013) 273-285.
- [53] G.S. Ajmani, H.H. Cho, T.E. Abbott Chalew, K.J. Schwab, J.G. Jacangelo, H. Huang, Static and dynamic removal of aquatic natural organic matter by carbon nanotubes, *Water Res*, 59 (2014) 262-270.
- [54] S. Zhang, T. Shao, T. Karanfil, The effects of dissolved natural organic matter on the adsorption of synthetic organic chemicals by activated carbons and carbon nanotubes, *Water Res*, 45 (2011) 1378-1386.
- [55] H. Hyung, J.-H. Kim, Natural organic matter (NOM) adsorption to multi-walled carbon nanotubes: effect of NOM characteristics and water quality parameters, *Environmental science & technology*, 42 (2008) 4416-4421.
- [56] J. Davey, A. Schäfer, Ultrafiltration to supply drinking water in international development: a review of opportunities, in: *Appropriate technologies for environmental protection in the developing world*, Springer, 2009, pp. 151-168.

- [57] A.-S. Jönsson, G. Trägårdh, Ultrafiltration applications, *Desalination*, 77 (1990) 135-179.
- [58] P. Amaral, E. Partlan, M. Li, F. Lapolli, O.T. Mefford, T. Karanfil, D.A. Ladner, Superfine powdered activated carbon (S-PAC) coatings on microfiltration membranes: Effects of milling time on contaminant removal and flux, *Water research*, 100 (2016) 429-438.
- [59] H.-J. Hong, H. Kim, Y.-J. Lee, J.-W. Yang, Removal of anionic contaminants by surfactant modified powdered activated carbon (SM-PAC) combined with ultrafiltration, *Journal of hazardous materials*, 170 (2009) 1242-1246.
- [60] P.B. Trinh, Immobilization of carbon-based nanoparticles in ultrafiltration support structure for steroid hormone removal, in: *Membrane Technology Department, Institute of Functional Interfaces (IFG), Karlsruhe Institute of Technology (KIT)*, 2018.
- [61] C. Monneret, What is an endocrine disruptor?, *C R Biol*, 340 (2017) 403-405.
- [62] J.M. Vogel, Tunnel vision: The regulation of endocrine disruptors, *Policy Sciences*, 37 (2004) 277-303.
- [63] G.G. Kuiper, B. Carlsson, K. Grandien, E. Enmark, J. Häggblad, S. Nilsson, J.-A.k. Gustafsson, Comparison of the ligand binding specificity and transcript tissue distribution of estrogen receptors  $\alpha$  and  $\beta$ , *Endocrinology*, 138 (1997) 863-870.
- [64] A.Z. Aris, A.S. Shamsuddin, S.M. Praveena, Occurrence of 17 $\alpha$ -ethynylestradiol (EE2) in the environment and effect on exposed biota: a review, *Environment international*, 69 (2014) 104-119.
- [65] T.A. Ternes, A. Joss, H. Siegrist, Peer reviewed: scrutinizing pharmaceuticals and personal care products in wastewater treatment, in: *ACS Publications*, 2004.
- [66] E. Topp, S.C. Monteiro, A. Beck, B.B. Coelho, A.B. Boxall, P.W. Duenk, S. Kleywegt, D.R. Lapen, M. Payne, L. Sabourin, Runoff of pharmaceuticals and personal care products following application of biosolids to an agricultural field, *Science of the Total Environment*, 396 (2008) 52-59.
- [67] C.P. Silva, M. Otero, V. Esteves, Processes for the elimination of estrogenic steroid hormones from water: a review, *Environ Pollut*, 165 (2012) 38-58.
- [68] E. Commission, Commission Implementing Decision (EU) 2015/495 of 20 march 2015. Establishing a watch list of substances for union-wide monitoring in the field of water policy pursuant to Directive 2008/105/EC of the European Parliament and of the Council, *Official Journal of the European Union*, (2015).
- [69] J.O. Tijani, O.O. Fatoba, L.F. Petrik, A review of pharmaceuticals and endocrine-disrupting compounds: sources, effects, removal, and detections, *Water, Air, & Soil Pollution*, 224 (2013) 1770.
- [70] J.N. Lester, J.W. Birkett, *Endocrine disrupters in wastewater and sludge treatment processes*, CRC Press, 2002.
- [71] L.D. Nghiem, A.I. Schäfer, M. Elimelech, Removal of natural hormones by nanofiltration membranes: measurement, modeling, and mechanisms, *Environmental science & technology*, 38 (2004) 1888-1896.
- [72] L. Ma, S.R. Yates, Dissolved organic matter and estrogen interactions regulate estrogen removal in the aqueous environment: A review, *Sci Total Environ*, 640-641 (2018) 529-542.
- [73] D.D. Perrin, B. Dempsey, E.P. Serjeant, *pKa prediction for organic acids and bases*, Chapman and Hall, London ; New York, 1981.
- [74] K.M. Lewis, R.D. Archer, pKa values of estrone, 17 $\beta$ -estradiol and 2-methoxyestrone, *Steroids*, 34 (1979) 485-499.
- [75] A. Bhandari, *Emerging Contaminants of Concern Task Committee of Environmental Council, Contaminants of emerging environmental concern*, American Society of Civil Engineers, Reston, Virginia, USA, 2009.
- [76] C. Hansch, A. Leo, D.H. Hoekman, *Exploring QSAR: Hydrophobic, electronic, and steric constants*, American Chemical Society, Washington, DC, 1995.

- [77] N. Bolong, A. Ismail, M.R. Salim, T. Matsuura, A review of the effects of emerging contaminants in wastewater and options for their removal, *Desalination*, 239 (2009) 229-246.
- [78] D. Jermann, W. Pronk, M. Boller, A.I. Schäfer, The role of NOM fouling for the retention of estradiol and ibuprofen during ultrafiltration, *Journal of Membrane Science*, 329 (2009) 75-84.
- [79] K. Kimura, S. Toshima, G. Amy, Y. Watanabe, Rejection of neutral endocrine disrupting compounds (EDCs) and pharmaceutical active compounds (PhACs) by RO membranes, *Journal of membrane science*, 245 (2004) 71-78.
- [80] I. Koyuncu, O.A. Arıkan, M.R. Wiesner, C. Rice, Removal of hormones and antibiotics by nanofiltration membranes, *J Membrane Sci*, 309 (2008) 94-101.
- [81] A. Schäfer, L. Nghiem, T. Waite, Removal of the natural hormone estrone from aqueous solutions using nanofiltration and reverse osmosis, *Environmental Science & Technology*, 37 (2003) 182-188.
- [82] A. Aqel, K.M.A. El-Nour, R.A. Ammar, A. Al-Warthan, Carbon nanotubes, science and technology part (I) structure, synthesis and characterisation, *Arabian Journal of Chemistry*, 5 (2012) 1-23.
- [83] E.T. Thostenson, Z. Ren, T.-W. Chou, Advances in the science and technology of carbon nanotubes and their composites: a review, *Composites science and technology*, 61 (2001) 1899-1912.
- [84] C.P. Bergmann, F.M. Machado, Carbon nanomaterials as adsorbents for environmental and biological applications, Springer, 2015.
- [85] A. Hirsch, Functionalization of single-walled carbon nanotubes, *Angewandte Chemie International Edition*, 41 (2002) 1853-1859.
- [86] P. Kondratyuk, J.T. Yates Jr, Molecular views of physical adsorption inside and outside of single-wall carbon nanotubes, *Accounts of chemical research*, 40 (2007) 995-1004.
- [87] K. Yang, B. Xing, Adsorption of organic compounds by carbon nanomaterials in aqueous phase: Polanyi theory and its application, *Chemical reviews*, 110 (2010) 5989-6008.
- [88] B. Pan, B. Xing, Adsorption mechanisms of organic chemicals on carbon nanotubes, *Environmental science & technology*, 42 (2008) 9005-9013.
- [89] Z.-C. Di, J. Ding, X.-J. Peng, Y.-H. Li, Z.-K. Luan, J. Liang, Chromium adsorption by aligned carbon nanotubes supported ceria nanoparticles, *Chemosphere*, 62 (2006) 861-865.
- [90] Y.-H. Li, Z. Di, J. Ding, D. Wu, Z. Luan, Y. Zhu, Adsorption thermodynamic, kinetic and desorption studies of Pb<sup>2+</sup> on carbon nanotubes, *Water research*, 39 (2005) 605-609.
- [91] G.P. Rao, C. Lu, F. Su, Sorption of divalent metal ions from aqueous solution by carbon nanotubes: a review, *Separation and Purification Technology*, 58 (2007) 224-231.
- [92] X. Peng, Z. Luan, J. Ding, Z. Di, Y. Li, B. Tian, Ceria nanoparticles supported on carbon nanotubes for the removal of arsenate from water, *Materials letters*, 59 (2005) 399-403.
- [93] S. Gotovac, C.-M. Yang, Y. Hattori, K. Takahashi, H. Kanoh, K. Kaneko, Adsorption of polyaromatic hydrocarbons on single wall carbon nanotubes of different functionalities and diameters, *Journal of colloid and interface science*, 314 (2007) 18-24.
- [94] T.G. Hedderman, S.M. Keogh, G. Chambers, H.J. Byrne, In-depth study into the interaction of single walled carbon nanotubes with anthracene and p-terphenyl, *The Journal of Physical Chemistry B*, 110 (2006) 3895-3901.
- [95] K. Yang, L. Zhu, B. Xing, Adsorption of polycyclic aromatic hydrocarbons by carbon nanomaterials, *Environmental science & technology*, 40 (2006) 1855-1861.
- [96] X. Yan, B. Shi, J. Lu, C. Feng, D. Wang, H. Tang, Adsorption and desorption of atrazine on carbon nanotubes, *Journal of Colloid and Interface Science*, 321 (2008) 30-38.
- [97] L. Joseph, J. Heo, Y.-G. Park, J.R.V. Flora, Y. Yoon, Adsorption of bisphenol A and 17 $\alpha$ -ethinyl estradiol on single walled carbon nanotubes from seawater and brackish water, *Desalination*, 281 (2011) 68-74.

- [98] Y. Wang, J. Zhu, H. Huang, H.-H. Cho, Carbon nanotube composite membranes for microfiltration of pharmaceuticals and personal care products: Capabilities and potential mechanisms, *Journal of Membrane Science*, 479 (2015) 165-174.
- [99] J. Heo, L. Joseph, Y. Yoon, Y.-G. Park, N. Her, J. Sohn, S.-H. Yoon, Removal of micropollutants and NOM in carbon nanotube-UF membrane system from seawater, *Water Science and Technology*, 63 (2011) 2737-2744.
- [100] J. Heo, J.R.V. Flora, N. Her, Y.-G. Park, J. Cho, A. Son, Y. Yoon, Removal of bisphenol A and 17 $\beta$ -estradiol in single walled carbon nanotubes-ultrafiltration (SWNTs-UF) membrane systems, *Separation and Purification Technology*, 90 (2012) 39-52.
- [101] A.K. Kumar, S.V. Mohan, Removal of natural and synthetic endocrine disrupting estrogens by multi-walled carbon nanotubes (MWCNT) as adsorbent: kinetic and mechanistic evaluation, *Separation and Purification Technology*, 87 (2012) 22-30.
- [102] T. Akasaka, F. Watari, Capture of bacteria by flexible carbon nanotubes, *Acta biomaterialia*, 5 (2009) 607-612.
- [103] S. Deng, V.K. Upadhyayula, G.B. Smith, M.C. Mitchell, Adsorption equilibrium and kinetics of microorganisms on single-wall carbon nanotubes, *IEEE Sensors Journal*, 8 (2008) 954-962.
- [104] A. Srivastava, O. Srivastava, S. Talapatra, R. Vajtai, P. Ajayan, Carbon nanotube filters, *Nature materials*, 3 (2004) 610.
- [105] V.K. Upadhyayula, S. Deng, M.C. Mitchell, G.B. Smith, V.K. Nair, S. Ghoshroy, Adsorption kinetics of *Escherichia coli* and *Staphylococcus aureus* on single-walled carbon nanotube aggregates, *Water Science and Technology*, 58 (2008) 179-184.
- [106] V.K. Upadhyayula, S. Ghoshroy, V.S. Nair, G.B. Smith, M.C. Mitchell, S. Deng, Single-walled carbon nanotubes as fluorescence biosensors for pathogen recognition in water systems, *Journal of Nanotechnology*, 2008 (2008).
- [107] V.K. Upadhyayula, S. Deng, G.B. Smith, M.C. Mitchell, Adsorption of *Bacillus subtilis* on single-walled carbon nanotube aggregates, activated carbon and NanoCeram™, *Water research*, 43 (2009) 148-156.
- [108] A.S. Brady-Estévez, S. Kang, M. Elimelech, A single-walled-carbon-nanotube filter for removal of viral and bacterial pathogens, *Small*, 4 (2008) 481-484.
- [109] S. Mostafavi, M. Mehrnia, A. Rashidi, Preparation of nanofilter from carbon nanotubes for application in virus removal from water, *Desalination*, 238 (2009) 271-280.
- [110] C. Lu, F. Su, Adsorption of natural organic matter by carbon nanotubes, *Separation and Purification Technology*, 58 (2007) 113-121.
- [111] N.B. Saleh, L.D. Pfefferle, M. Elimelech, Aggregation kinetics of multiwalled carbon nanotubes in aquatic systems: measurements and environmental implications, *Environmental science & technology*, 42 (2008) 7963-7969.
- [112] F. Su, C. Lu, Adsorption kinetics, thermodynamics and desorption of natural dissolved organic matter by multiwalled carbon nanotubes, *Journal of Environmental Science and Health, Part A*, 42 (2007) 1543-1552.
- [113] E.C.d. Albuquerque Júnior, M.O.A. Méndez, A.d.R. Coutinho, T.T. Franco, Removal of cyanobacteria toxins from drinking water by adsorption on activated carbon fibers, *Materials Research*, 11 (2008) 371-380.
- [114] H. Yan, A. Gong, H. He, J. Zhou, Y. Wei, L. Lv, Adsorption of microcystins by carbon nanotubes, *Chemosphere*, 62 (2006) 142-148.
- [115] H. Yan, G. Pan, H. Zou, X. Li, H. Chen, Effective removal of microcystins using carbon nanotubes embedded with bacteria, *Chinese Science Bulletin*, 49 (2004) 1694-1698.
- [116] B. Pan, D. Lin, H. Mashayekhi, B. Xing, Adsorption and hysteresis of bisphenol A and 17 $\alpha$ -ethinyl estradiol on carbon nanomaterials, *Environmental science & technology*, 42 (2008) 5480-5485.
- [117] K. Kostarelos, The long and short of carbon nanotube toxicity, *Nature biotechnology*, 26 (2008) 774.

- [118] P. Wick, P. Manser, L.K. Limbach, U. Dettlaff-Weglikowska, F. Krumeich, S. Roth, W.J. Stark, A. Bruinink, The degree and kind of agglomeration affect carbon nanotube cytotoxicity, *Toxicology letters*, 168 (2007) 121-131.
- [119] X. Qu, P.J. Alvarez, Q. Li, Applications of nanotechnology in water and wastewater treatment, *Water Res*, 47 (2013) 3931-3946.
- [120] G. Jia, H. Wang, L. Yan, X. Wang, R. Pei, T. Yan, Y. Zhao, X. Guo, Cytotoxicity of carbon nanomaterials: single-wall nanotube, multi-wall nanotube, and fullerene, *Environmental science & technology*, 39 (2005) 1378-1383.
- [121] S. Kar, R. Bindal, P. Tewari, Carbon nanotube membranes for desalination and water purification: Challenges and opportunities, *Nano Today*, 7 (2012) 385-389.
- [122] Ihsanullah, Carbon nanotube membranes for water purification: Developments, challenges, and prospects for the future, *SEPARATION AND PURIFICATION TECHNOLOGY*, 209 (2019) 307-337.
- [123] M. Rashid, S.F. Ralph, Carbon nanotube membranes: synthesis, properties, and future filtration applications, *Nanomaterials*, 7 (2017) 99.
- [124] J. Yin, G. Zhu, B. Deng, Multi-walled carbon nanotubes (MWNTs)/polysulfone (PSU) mixed matrix hollow fiber membranes for enhanced water treatment, *Journal of Membrane Science*, 437 (2013) 237-248.
- [125] H. Wu, B. Tang, P. Wu, Novel ultrafiltration membranes prepared from a multi-walled carbon nanotubes/polymer composite, *Journal of Membrane Science*, 362 (2010) 374-383.
- [126] L. Ma, X. Dong, M. Chen, L. Zhu, C. Wang, F. Yang, Y. Dong, Fabrication and water treatment application of carbon nanotubes (CNTs)-based composite membranes: a review, *Membranes*, 7 (2017) 16.
- [127] M. Sillanpää, *Natural organic matter in water: Characterization and treatment methods*, Butterworth-Heinemann, 2014.
- [128] R. Fabris, C.W. Chow, M. Drikas, B. Eikebrokk, Comparison of NOM character in selected Australian and Norwegian drinking waters, *Water Res*, 42 (2008) 4188-4196.
- [129] Q.S. Wei, C.H. Feng, D.S. Wang, B.Y. Shi, L.T. Zhang, Q. Wei, H.X. Tang, Seasonal variations of chemical and physical characteristics of dissolved organic matter and trihalomethane precursors in a reservoir: a case study, *J Hazard Mater*, 150 (2008) 257-264.
- [130] E.M. Thurman, *Organic geochemistry of natural waters*, Springer Science & Business Media, 2012.
- [131] J.-P. Croue, G.V. Korshin, M.M. Benjamin, *Characterization of natural organic matter in drinking water*, American Water Works Association, 2000.
- [132] A. Bhatnagar, M. Sillanpää, Removal of natural organic matter (NOM) and its constituents from water by adsorption - A review, *Chemosphere*, 166 (2017) 497-510.
- [133] J. Edzwald, Coagulation in drinking water treatment: particles, organics and coagulants, *Water Science and Technology*, 27 (1993) 21-35.
- [134] A. Matilainen, Removal of the natural organic matter in the different stages of the drinking water treatment process, Tampereen teknillinen yliopisto. Julkaisu-Tampere University of Technology. Publication; 651, (2007).
- [135] J.A. Leenheer, J.-P. Croué, Peer reviewed: characterizing aquatic dissolved organic matter, in, ACS Publications, 2003.
- [136] A. Callegari, J. Boguniewicz-Zablocka, A. Capodaglio, Experimental application of an advanced separation process for NOM removal from surface drinking water supply, *Separations*, 4 (2017) 32.
- [137] D.B. Babcock, P.C. Singer, Chlorination and coagulation of humic and fulvic acids, *Journal-American Water Works Association*, 71 (1979) 149-152.
- [138] M.C. White, J.D. Thompson, G.W. Harrington, P.C. Singer, Evaluating criteria for enhanced coagulation compliance, *Journal-American Water Works Association*, 89 (1997) 64-77.

- [139] R.F. Christman, D.L. Norwood, D.S. Millington, J.D. Johnson, A.A. Stevens, Identity and yields of major halogenated products of aquatic fulvic acid chlorination, *Environmental science & technology*, 17 (1983) 625-628.
- [140] S.W. Krasner, M.J. McGuire, J.G. Jacangelo, N.L. Patania, K.M. Reagan, E.M. Aieta, The occurrence of disinfection by-products in US drinking water, *Journal-American Water Works Association*, 81 (1989) 41-53.
- [141] S.W. Krasner, H.S. Weinberg, S.D. Richardson, S.J. Pastor, R. Chinn, M.J. Sclimenti, G.D. Onstad, A.D. Thruston, Occurrence of a new generation of disinfection byproducts, *Environmental science & technology*, 40 (2006) 7175-7185.
- [142] N. Lee, G. Amy, J.P. Croue, H. Buisson, Identification and understanding of fouling in low-pressure membrane (MF/UF) filtration by natural organic matter (NOM), *Water Res*, 38 (2004) 4511-4523.
- [143] H. Yamamura, K. Kimura, Y. Watanabe, Mechanism involved in the evolution of physically irreversible fouling in microfiltration and ultrafiltration membranes used for drinking water treatment, *Environmental science & technology*, 41 (2007) 6789-6794.
- [144] W. Guo, H.H. Ngo, J. Li, A mini-review on membrane fouling, *Bioresour Technol*, 122 (2012) 27-34.
- [145] K.S. Katsoufidou, D.C. Sioutopoulos, S.G. Yiantsios, A.J. Karabelas, UF membrane fouling by mixtures of humic acids and sodium alginate: Fouling mechanisms and reversibility, *Desalination*, 264 (2010) 220-227.
- [146] H.-C. Kim, B.A. Dempsey, Membrane fouling due to alginate, SMP, EfOM, humic acid, and NOM, *Journal of Membrane Science*, 428 (2013) 190-197.
- [147] A.W. Zularisam, A.F. Ismail, M.R. Salim, M. Sakinah, H. Ozaki, The effects of natural organic matter (NOM) fractions on fouling characteristics and flux recovery of ultrafiltration membranes, *Desalination*, 212 (2007) 191-208.
- [148] I.C. Escobar, A.A. Randall, J.S. Taylor, Bacterial growth in distribution systems: effect of assimilable organic carbon and biodegradable dissolved organic carbon, *Environmental science & technology*, 35 (2001) 3442-3447.
- [149] Y.-P. Chin, G.R. Aiken, K.M. Danielsen, Binding of pyrene to aquatic and commercial humic substances: the role of molecular weight and aromaticity, *Environmental Science & Technology*, 31 (1997) 1630-1635.
- [150] J.S. Waples, K.L. Nagy, G.R. Aiken, J.N. Ryan, Dissolution of cinnabar (HgS) in the presence of natural organic matter, *Geochimica et Cosmochimica Acta*, 69 (2005) 1575-1588.
- [151] M. Sillanpää, A. Matilainen, T. Lahtinen, Characterization of NOM, *Natural Organic Matter in Water*, 2 (2015) 17-53.
- [152] C. Chen, X. Zhang, W. He, W. Lu, H. Han, Comparison of seven kinds of drinking water treatment processes to enhance organic material removal: a pilot test, *Science of the Total Environment*, 382 (2007) 93-102.
- [153] S.R. Sarathy, M. Mohseni, The impact of UV/H<sub>2</sub>O<sub>2</sub> advanced oxidation on molecular size distribution of chromophoric natural organic matter, *Environmental science & technology*, 41 (2007) 8315-8320.
- [154] N. Her, G. Amy, J. Chung, J. Yoon, Y. Yoon, Characterizing dissolved organic matter and evaluating associated nanofiltration membrane fouling, *Chemosphere*, 70 (2008) 495-502.
- [155] A. Matilainen, E.T. Gjessing, T. Lahtinen, L. Hed, A. Bhatnagar, M. Sillanpää, An overview of the methods used in the characterisation of natural organic matter (NOM) in relation to drinking water treatment, *Chemosphere*, 83 (2011) 1431-1442.
- [156] J. Haarhoff, M. Kubare, B. Mamba, R. Krause, T. Nkambule, B. Matsebula, J. Menge, NOM characterization and removal at six Southern African water treatment plants, *Drinking Water Engineering and Science*, 3 (2010) 53-61.

- [157] G. Korshin, C.W. Chow, R. Fabris, M. Drikas, Absorbance spectroscopy-based examination of effects of coagulation on the reactivity of fractions of natural organic matter with varying apparent molecular weights, *Water Research*, 43 (2009) 1541-1548.
- [158] J.K. Edzwald, J.E. Tobiason, Enhanced coagulation: US requirements and a broader view, *Water Science and Technology*, 40 (1999) 63-70.
- [159] S.A. Huber, A. Balz, M. Abert, W. Pronk, Characterisation of aquatic humic and non-humic matter with size-exclusion chromatography–organic carbon detection–organic nitrogen detection (LC-OCD-OND), *Water research*, 45 (2011) 879-885.
- [160] F.A. Messaud, R.D. Sanderson, J.R. Runyon, T. Otte, H. Pasch, S.K.R. Williams, An overview on field-flow fractionation techniques and their applications in the separation and characterization of polymers, *Progress in Polymer Science*, 34 (2009) 351-368.
- [161] M. Baalousha, B. Stolpe, J. Lead, Flow field-flow fractionation for the analysis and characterization of natural colloids and manufactured nanoparticles in environmental systems: A critical review, *Journal of Chromatography A*, 1218 (2011) 4078-4103.
- [162] J. Moon, S.-H. Kim, J. Cho, Characterizations of natural organic matter as nano particle using flow field-flow fractionation, *Colloids and Surfaces A: Physicochemical and Engineering Aspects*, 287 (2006) 232-236.
- [163] A. Zularisam, A. Ahmad, M. Sakinah, A. Ismail, T. Matsuura, Role of natural organic matter (NOM), colloidal particles, and solution chemistry on ultrafiltration performance, *Separation and Purification Technology*, 78 (2011) 189-200.
- [164] P.A. Neale, B.I. Escher, A.I. Schafer, pH dependence of steroid hormone–organic matter interactions at environmental concentrations, *Sci Total Environ*, 407 (2009) 1164-1173.
- [165] H.N. Graham, Green tea composition, consumption, and polyphenol chemistry, *Preventive medicine*, 21 (1992) 334-350.
- [166] A. Schafer, *Natural organics removal using membranes: principles, performance, and cost*, CRC Press, 2001.
- [167] F.A. Johnson, D.Q. Craig, A.D. Mercer, Characterization of the block structure and molecular weight of sodium alginates, *Journal of pharmacy and pharmacology*, 49 (1997) 639-643.
- [168] F.J. Stevenson, *Humus chemistry: genesis, composition, reactions*, John Wiley & Sons, 1994.
- [169] H. Hyung, J.H. Kim, Natural organic matter (NOM) adsorption to multi-walled carbon nanotubes: effect of NOM characteristics and water quality parameters, *Environ Sci Technol*, 42 (2008) 4416-4421.
- [170] D. Lin, B. Xing, Tannic acid adsorption and its role for stabilizing carbon nanotube suspensions, *Environmental science & technology*, 42 (2008) 5917-5923.
- [171] X. Zhang, M. Liu, X. Zhang, F. Deng, C. Zhou, J. Hui, W. Liu, Y. Wei, Interaction of tannic acid with carbon nanotubes: enhancement of dispersibility and biocompatibility, *Toxicology Research*, 4 (2015) 160-168.
- [172] H. Yamamoto, H.M. Liljestrand, Y. Shimizu, M. Morita, Effects of physical– chemical characteristics on the sorption of selected endocrine disruptors by dissolved organic matter surrogates, *Environmental science & technology*, 37 (2003) 2646-2657.
- [173] M. Nie, Y. Yang, M. Liu, C. Yan, H. Shi, W. Dong, J.L. Zhou, Environmental estrogens in a drinking water reservoir area in Shanghai: Occurrence, colloidal contribution and risk assessment, *Science of the Total Environment*, 487 (2014) 785-791.
- [174] C.G. Campbell, S.E. Borglin, F.B. Green, A. Grayson, E. Wozei, W.T. Stringfellow, Biologically directed environmental monitoring, fate, and transport of estrogenic endocrine disrupting compounds in water: a review, *Chemosphere*, 65 (2006) 1265-1280.
- [175] D. Zhu, S. Hyun, J.J. Pignatello, L.S. Lee, Evidence for  $\pi$ –  $\pi$  electron donor– acceptor interactions between  $\pi$ -donor aromatic compounds and  $\pi$ -acceptor sites in soil organic matter through pH effects on sorption, *Environmental Science & Technology*, 38 (2004) 4361-4368.

- [176] X. Jin, J. Hu, S.L. Ong, Influence of dissolved organic matter on estrone removal by NF membranes and the role of their structures, *Water research*, 41 (2007) 3077-3088.
- [177] L.J. Zeman, A.L. Zydney, *Microfiltration and ultrafiltration: principles and applications*, CRC Press, 2017.
- [178] M. Cheryan, *Ultrafiltration and microfiltration handbook*, CRC press, 1998.
- [179] J. Mulder, *Basic principles of membrane technology*, Springer Science & Business Media, 2012.
- [180] A. Clancy, D. Anthony, S. Fisher, H. Leese, C. Roberts, M. Shaffer, Reductive dissolution of supergrowth carbon nanotubes for tougher nanocomposites by reactive coagulation spinning, *Nanoscale*, 9 (2017) 8764-8773.
- [181] H. Hu, A. Yu, E. Kim, B. Zhao, M.E. Itkis, E. Bekyarova, R.C. Haddon, Influence of the zeta potential on the dispersability and purification of single-walled carbon nanotubes, *The Journal of Physical Chemistry B*, 109 (2005) 11520-11524.
- [182] F.A. Johnson, D.Q.M. Craig, A.D. Mercer, Characterization of the block structure and molecular weight of sodium alginates, *Journal of Pharmacy and Pharmacology*, 49 (1997) 639-643.
- [183] P.A. Neale, A.I. Schäfer, Quantification of solute-solute interactions in steroidal hormone removal by ultrafiltration membranes, *Separation and Purification Technology*, 90 (2012) 31-38.
- [184] A. Imbrogno, J. Biscarat, A. Iris Schafer, Estradiol uptake in a combined magnetic ion exchange-ultrafiltration (MIEX-UF) process during water treatment, *Current pharmaceutical design*, 23 (2017) 328-337.
- [185] G. Aschermann, A. Jeihanipour, J. Shen, G. Mkongo, L. Dramas, J.P. Croue, A. Schäfer, Seasonal variation of organic matter concentration and characteristics in the Maji ya Chai River (Tanzania): Impact on treatability by ultrafiltration, *Water Res*, 101 (2016) 370-381.
- [186] D.-L.D. Huber, *LC-OCD-OND Operational Manual Version 4.0 for Model 9*.
- [187] F.X. Simon, Y. Penru, A.R. Guastalli, S. Esplugas, J. Llorens, S. Baig, NOM characterization by LC-OCD in a SWRO desalination line, *Desalination and Water Treatment*, 51 (2013) 1776-1780.
- [188] P. Elmer, *Lamda 25/35/45 brochure*.
- [189] S. Chang, T.D. Waite, P.E. Ong, A.I. Schäfer, A.G. Fane, Assessment of trace estrogenic contaminants removal by coagulant addition, powdered activated carbon adsorption and powdered activated carbon/microfiltration processes, *Journal of Environmental Engineering*, 130 (2004) 736-742.
- [190] N. Staff, *Principles and Applications of Liquid Scintillation Counting: A primer for orientation*. 2004, in, 2016.
- [191] N.M. Thang, H. Geckeis, J. Kim, H. Beck, Application of the flow field flow fractionation (FFFF) to the characterization of aquatic humic colloids: evaluation and optimization of the method, *Colloids and Surfaces A: Physicochemical and Engineering Aspects*, 181 (2001) 289-301.
- [192] R. Beckett, B.T. Hart, J. Buffle, H. van Leeuwen, Use of field-flow fractionation techniques to characterize aquatic particles, colloids, and macromolecules, *Buffle, J., van Leeuwen, HP, (1993)*.







## APPENDIX

### A.1 Filtration tests mass balance

Table 13. Hormone concentration in feed and retentate samples (LSC analysis) and mass balance of filtration test with different hormones, with and without tannic acid (10 mgC/L).

Filtration Test	Feed concentration (ng/L)	Feed mass (ng)	Retentate concentration (ng/L)	Retentate mass (ng)	Permeate mass (ng)	Mass adsorbed (ng)
100kDa_E2	90.79	22.70	91.86	8.730	1.470	11.07
100kDa_E2_TA	91.58	22.89	89.79	8.530	2.170	2.122
100kDa_E1	93.96	23.49	86.09	8.178	1.897	5.125
100kDa_E1_TA	85.84	21.46	84.69	8.046	2.103	1.431
100kDa_P	80.21	20.05	85.48	8.121	0.377	10.05
100kDa_P_TA	85.80	21.45	81.26	7.720	0.685	6.559
100kDa_T	87.24	21.81	91.91	8.732	1.511	5.749
100kDa_T_TA	82.52	20.63	83.37	7.920	1.781	3.179

Table 14. Hormone concentration in feed and retentate samples (LSC analysis) and mass balance of E2 filtration test with different NOMs (10 mgC/L).

Filtration Test	Feed concentration (ng/L)	Feed mass (ng)	Retentate concentration (ng/L)	Retentate mass (ng)	Permeate mass (ng)	Mass adsorbed (ng)
100kDa_Blank	90.79	22.70	91.86	8.730	1.470	11.07
100kDa_GLU	97.70	24.43	94.66	8.992	1.426	12.44
100kDa_HA	85.10	21.27	72.61	6.898	1.636	11.12
100kDa_TEA	91.87	22.97	93.41	8.873	2.121	9.942
100kDa_ALG	90.43	22.61	88.96	8.452	1.274	7.504
100kDa_AUS	90.43	22.61	91.60	8.702	1.719	5.045
100kDa_TA	91.58	22.89	89.79	8.530	2.17	2.122

Table 15. Hormone concentration in feed and retentate samples (LSC analysis) and mass balance of E2 filtration test with different MWCO membranes, with and without tannic acid (10 mgC/L).

Filtration Test	Feed concentration (ng/L)	Feed mass (ng)	Retentate concentration (ng/L)	Retentate mass (ng)	Permeate mass (ng)	Mass adsorbed (ng)
100kDa	90.79	22.70	91.86	8.730	1.470	11.07
100kDa_TA	91.58	22.89	89.79	8.530	2.17	2.122
30kDa	98.60	24.65	96.13	9.130	1.280	8.774
30kDa_TA	91.44	22.86	91.76	8.720	1.920	6.169
10kDa	93.05	23.26	91.76	19.73	0.200	2.452
10kDa_TA	90.31	22.58	91.77	19.73	0.380	1.583
5kDa	93.61	23.40	95.35	20.98	0.190	1.868
5kDa_TA	95.20	23.80	96.00	20.64	0.280	1.923

Table 16. Hormone concentration in feed and retentate samples (LSC analysis) and mass balance of E2 filtration test at different pressures in presence of tannic acid (10 mgC/L).

Filtration Test	Feed concentration (ng/L)	Feed mass (ng)	Retentate concentration (ng/L)	Retentate mass (ng)	Permeate mass (ng)	Mass adsorbed (ng)
1 bar_w/o TA	93.05	23.26	91.76	19.73	0.200	2.452
0.5 bar_TA	93.57	23.39	93.56	20.12	0.376	1.544
1 bar_TA	90.31	22.58	91.77	19.73	0.380	1.583
2 bar_TA	92.47	23.12	93.42	20.08	0.377	1.588
3 bar_TA	93.66	23.41	95.95	20.63	0.417	1.489
4 bar_TA	91.44	22.86	91.76	19.73	0.384	1.538

## A.2 Filtration tests parameters: Flux and residence time

For the calculation of the residence time, a porosity of 50% has been assumed.

Table 17. Flux and residence time of E2 filtration experiments with different MWCO membranes (100, 30, 10 and 5kDa, Ultracel).

Filtration tests	Flux (L/m <sup>2</sup> ·h)	Residence time (s)
100kDa	367	2.25
30kDa	205	4.04
10kDa	36	23.0
5kDa	23.4	25.2

Table 18. Flux and residence time of E2 filtration experiments in presence of tannic acid (10 mgC/L) with different MWCO membranes (100, 30, 10 and 5kDa, Ultracel).

Filtration tests	Flux (L/m <sup>2</sup> ·h)	Residence time (s)
100kDa_TA	367	1.64
30kDa_TA	205	3.77
10kDa_TA	36	25.6
5kDa_TA	23.4	32.9

Table 19. Flux and residence time of E2 filtration experiments in presence of tannic acid (10 mgC/L) with 10kDa membrane (Ultracel) at different operation pressures (0.5, 1, 2, 3 and 4 bar)

Filtration tests	Flux (L/m <sup>2</sup> ·h)	Residence time (s)
0.5 bar	16.2	51.1
1 bar	32.4	25.6
2 bar	57.6	14.4
3 bar	86.4	9.58
4 bar	103	8.07

### A.3 Calibration Curves

This section shows the calibration curves used for analytical equipment: TOC, UV spectrophotometer and LSC. In addition, the quenching that tannic acid can cause for LSC is shown and it is established that at the concentration analysed, it does not cause a quenching effect.

#### I. TOC calibration curve

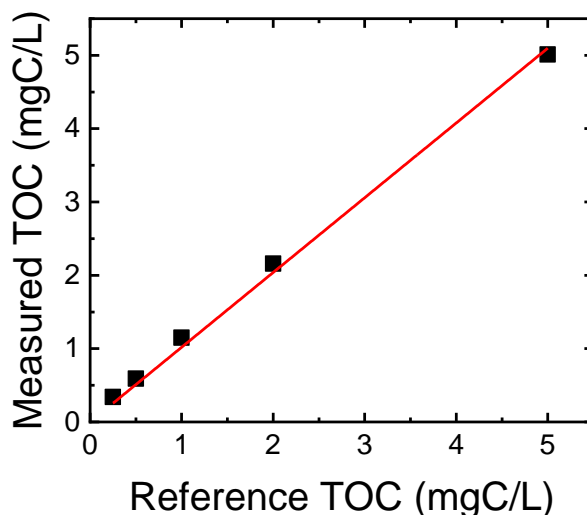

Figure 43. TOC calibration curve with TOC standards (0.25, 0.5, 1, 2 & 5 mgC/L)

#### II. UV calibration curve

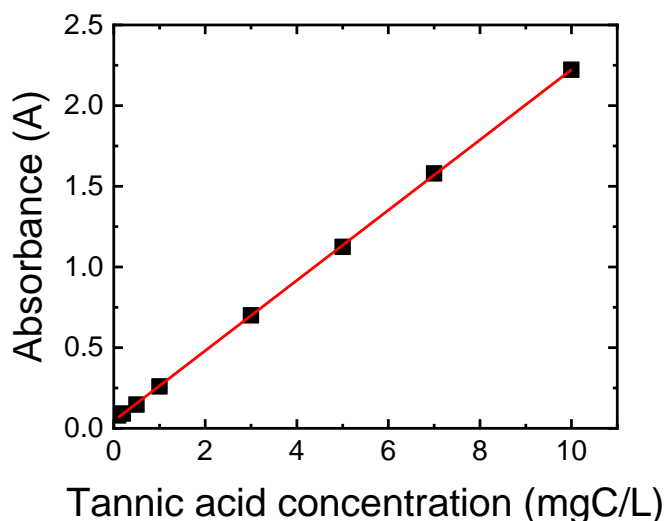

Figure 44. UV calibration curve for tannic acid (At fix wavelength of 213 nm)

	Calibration curve	R <sup>2</sup>
Tannic Acid	$y = 0.2177x + 0.0459$	0.9999

III. LSC calibration curve

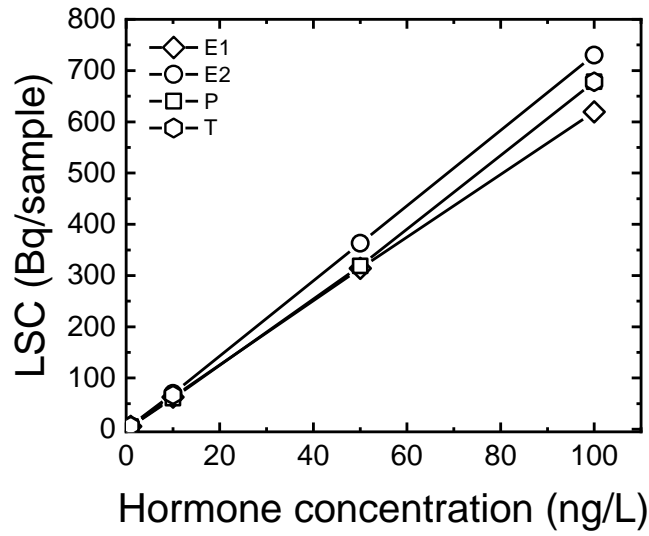

Figure 45. LSC calibration curve for different hormone (E1, E2, P and T)

Hormone	Calibration curve	R <sup>2</sup>
E1	$y = 6.2135x$	0.9999
E2	$y = 7.2922x$	1
P	$y = 6.6963x$	0.9987
T	$y = 6.7831x$	1

IV. LSC quenching curve

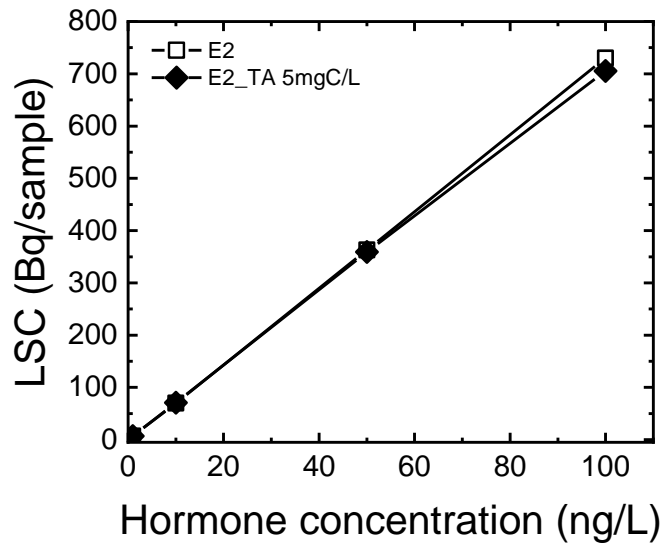

Figure 46. LSC quenching curve in presence of tannic acid (5mgC/L).

#### A.4 LC-OCD results

This section shows the signals of different samples analysed with LC-OCD for E2 filtration tests in the presence of different OM compounds.

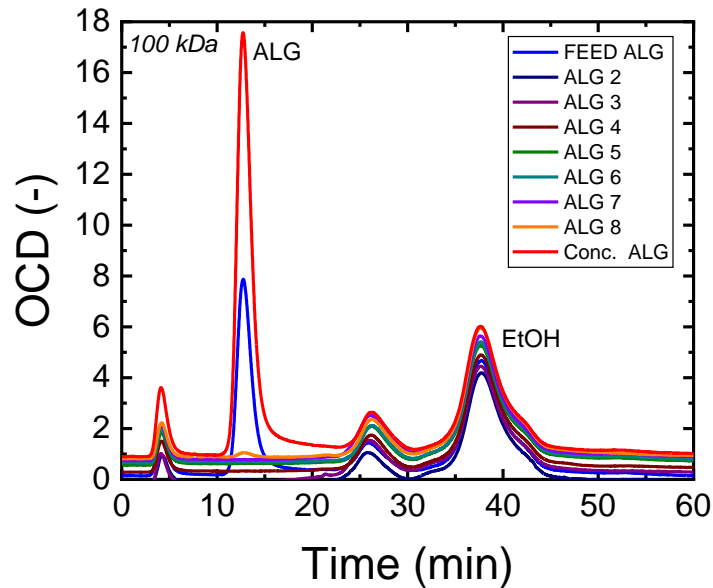

Figure 47. Samples of E2 filtration test with sodium alginate (feed concentration: 10 mgC/L) with 100 kDa UF-SWCNTs (2 g/m<sup>2</sup> CNPs, 1 bar) analysed with LC-OCD.

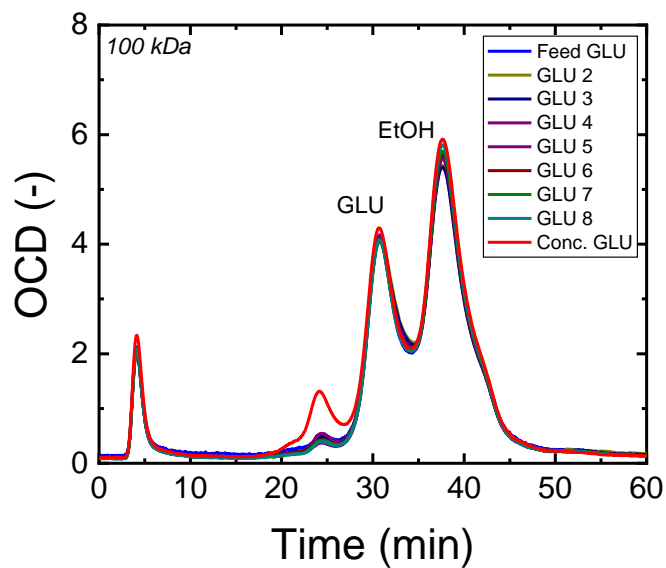

Figure 48. Samples of E2 filtration test with glucose (feed concentration: 10 mgC/L) with 100 kDa UF-SWCNTs (2 g/m<sup>2</sup> CNPs, 1 bar) analysed with LC-OCD.



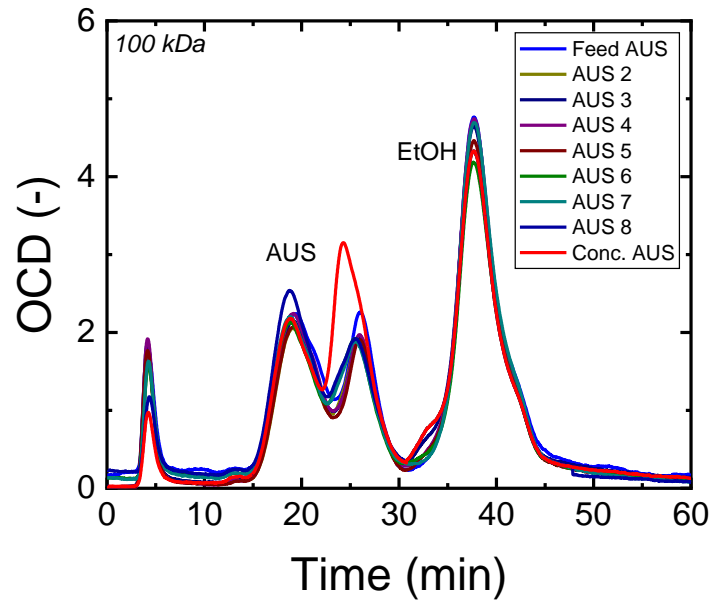

Figure 49. Samples of E2 filtration test with Australian NOM (feed concentration: 10 mgC/L) with 100 kDa UF-SWCNTs (2 g/m<sup>2</sup> CNPs, 1 bar) analysed with LC-OCD.

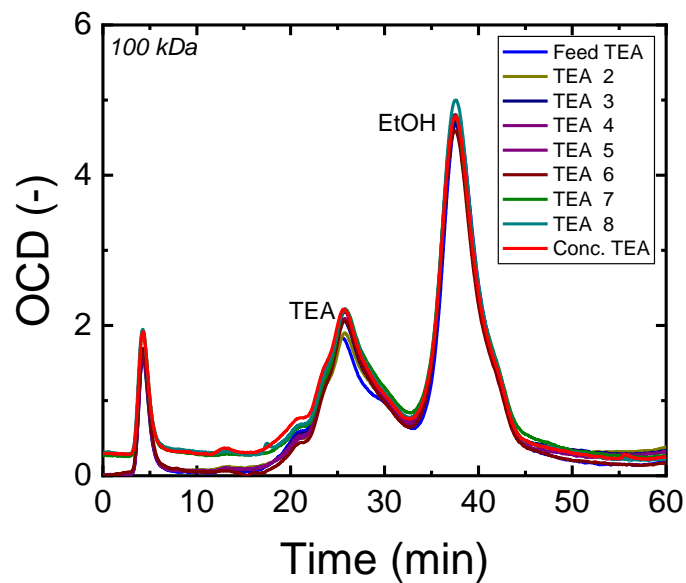

Figure 50. Samples of E2 filtration test with Tea extract (feed concentration: 10 mgC/L) with 100 kDa UF-SWCNTs (2 g/m<sup>2</sup> CNPs, 1 bar) analysed with LC-OCD.

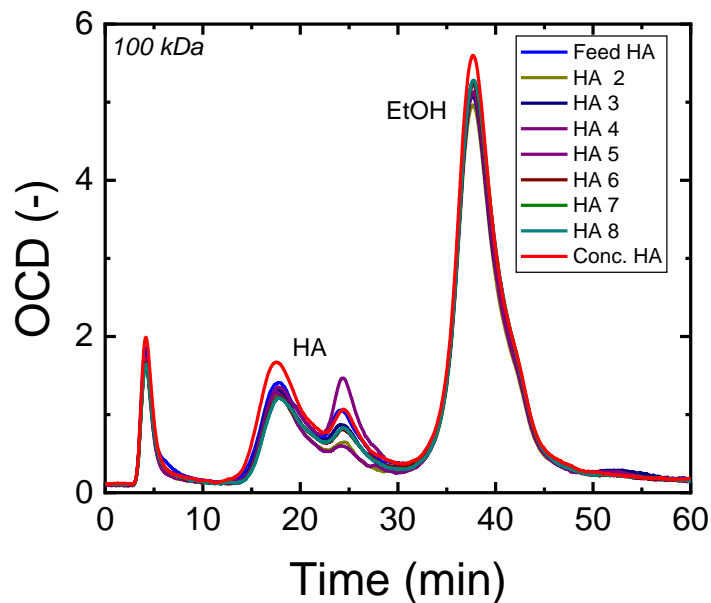

Figure 51. Samples of E2 filtration test with Tea extract (feed concentration: 10 mgC/L) with 100 kDa UF-SWCNTs (2 g/m<sup>2</sup> CNPs, 1 bar) analysed with LC-OCD.

#### A.5 LC-UVD signal

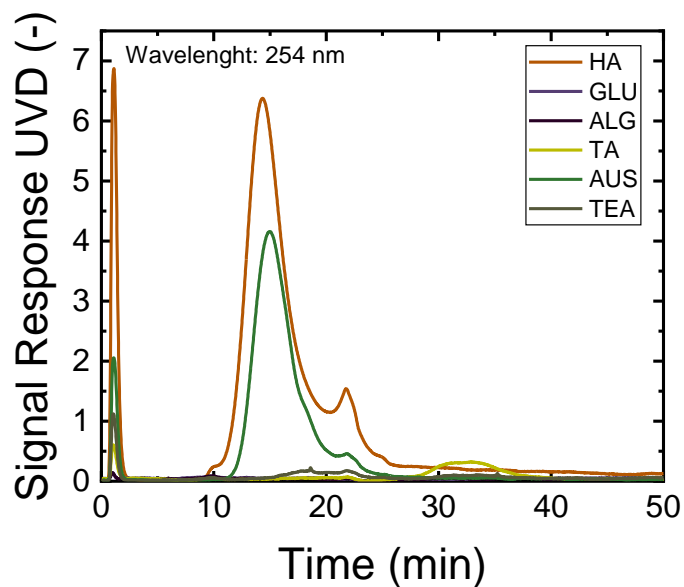

Figure 52. Signal response of different NOMs measured by Ultraviolet detector (LC-UVD) at 254 nm wavelength.

#### A.6 FFFF organics signals data

This section shows the signals obtained from humic acid, tea extract and Australian NOM with the FFFF. This signal allows to determinate the molecular weight based on the elution time.

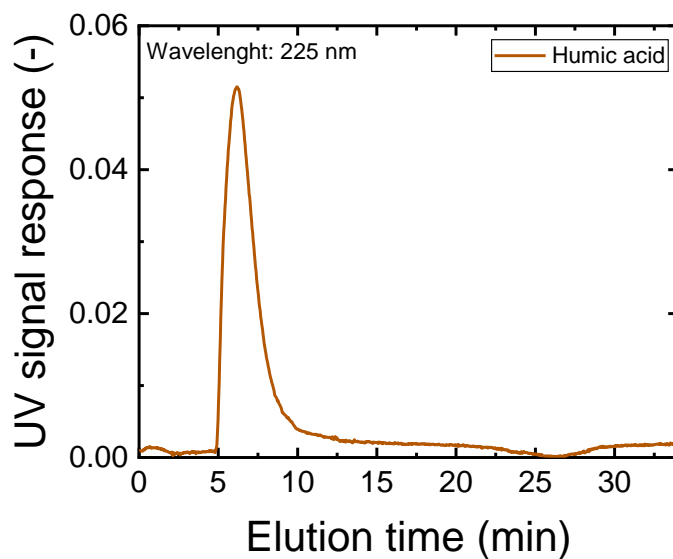

Figure 53. Signal response and elution time of humic acid measured by FFFF.

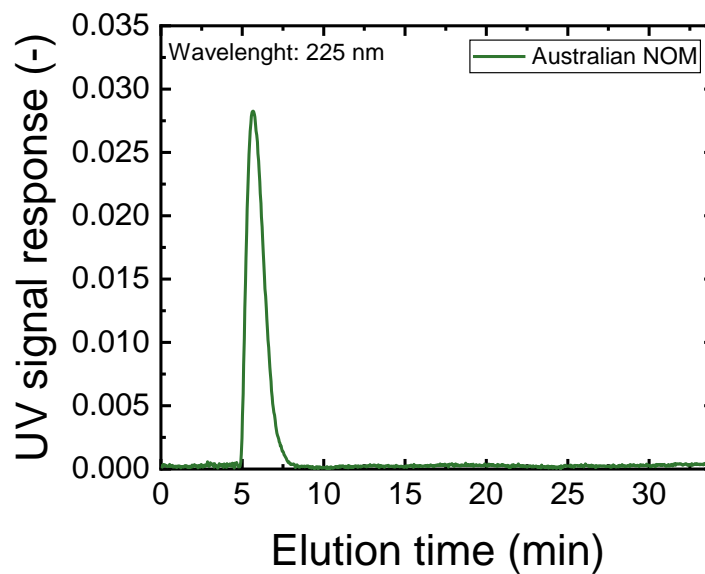

Figure 54. Signal response and elution time of Australian NOM measured by FFFF.

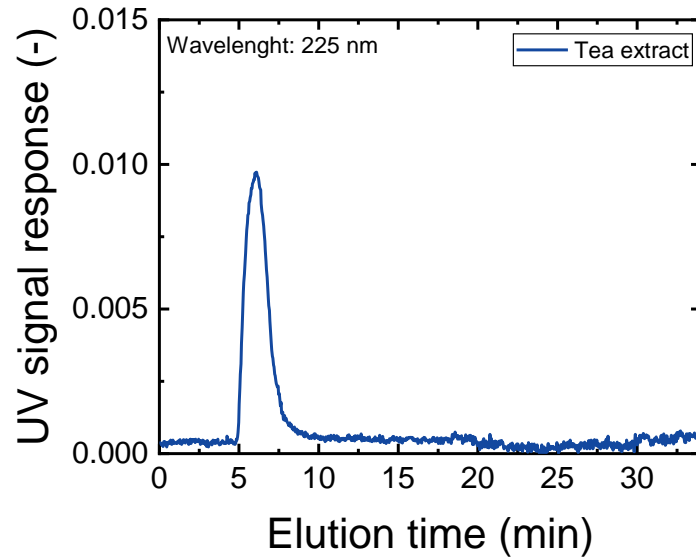

Figure 55. Signal response and elution time of tea extract measured by FFFF.

### A.7 Filtration tests data

This section shows the monitored parameters (Pressure, temperature, conductivity and mass) of the filtration tests carried out.

- Hormone removal tests (E1, E2, P & T)

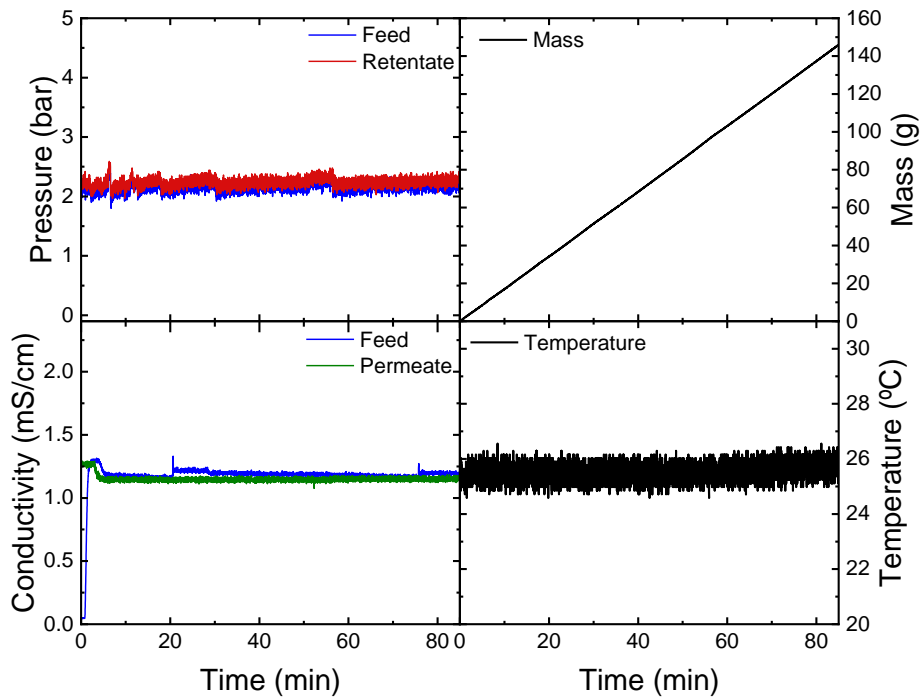

Figure 56. Data: E1 filtration test with 100kDa UF-SWCNT, feed 100 ng/L.

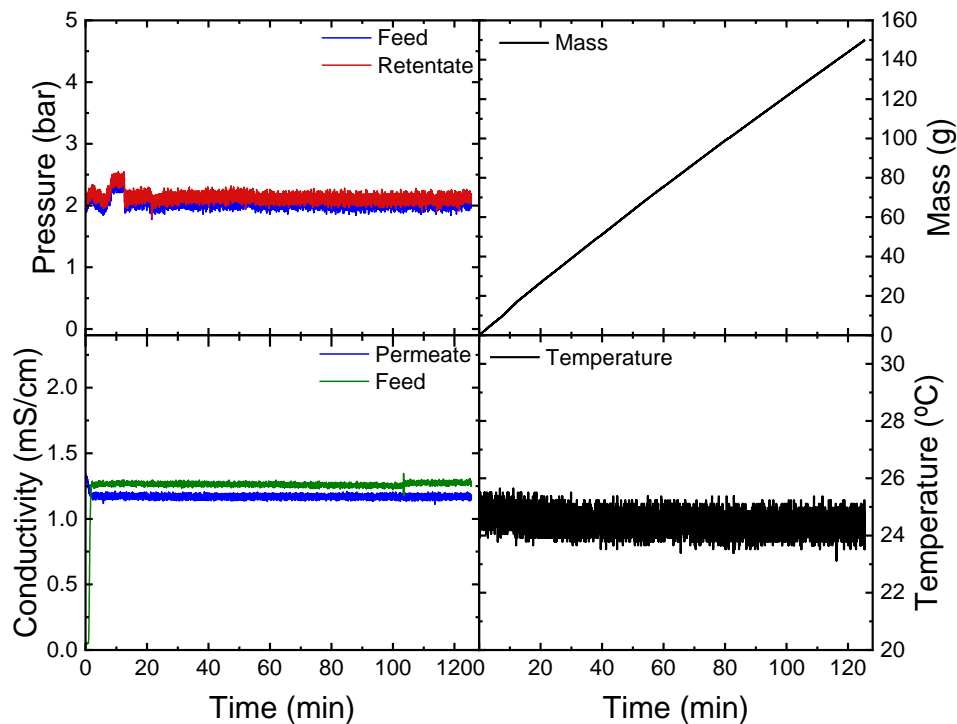

Figure 57. Data: E2 filtration test with 100kDa UF-SWCNT, feed 100 ng/L.

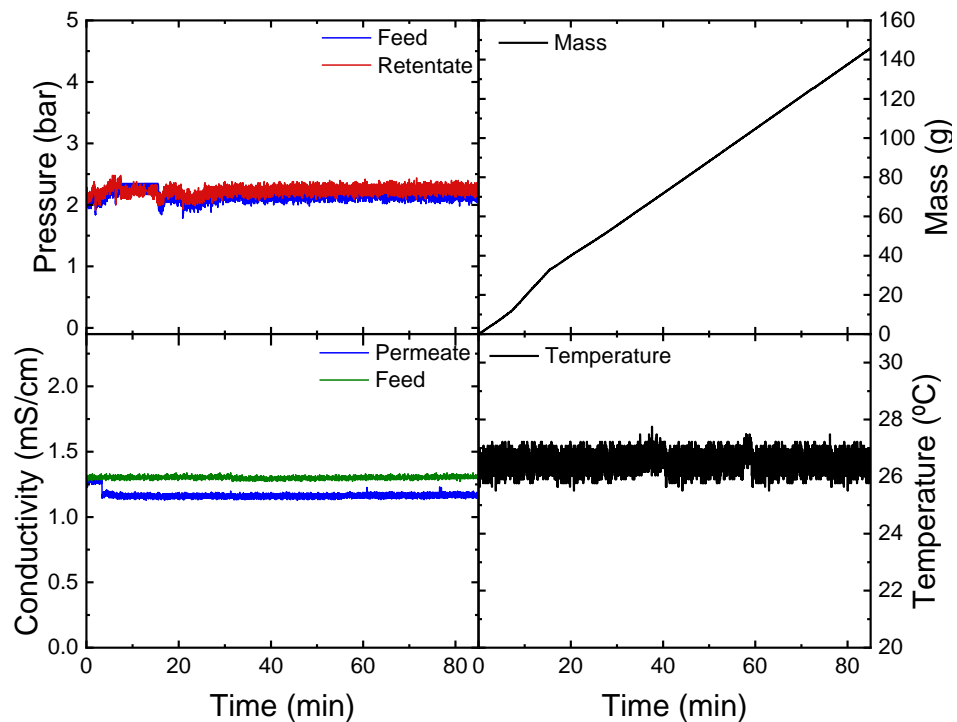

Figure 58. Data: Progesterone filtration test with 100kDa UF-SWCNT, feed 100 ng/L.

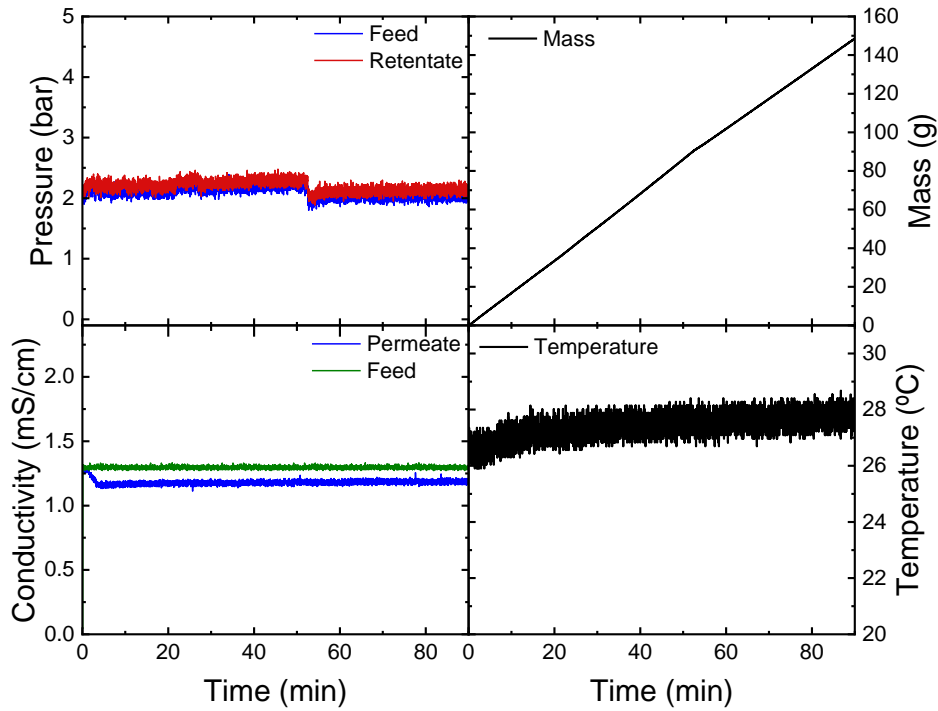

Figure 59. Data: Testosterone filtration test with 100kDa UF-SWCNT, feed 100 ng/L.

▪ E2 removal tests in presence of different NOM

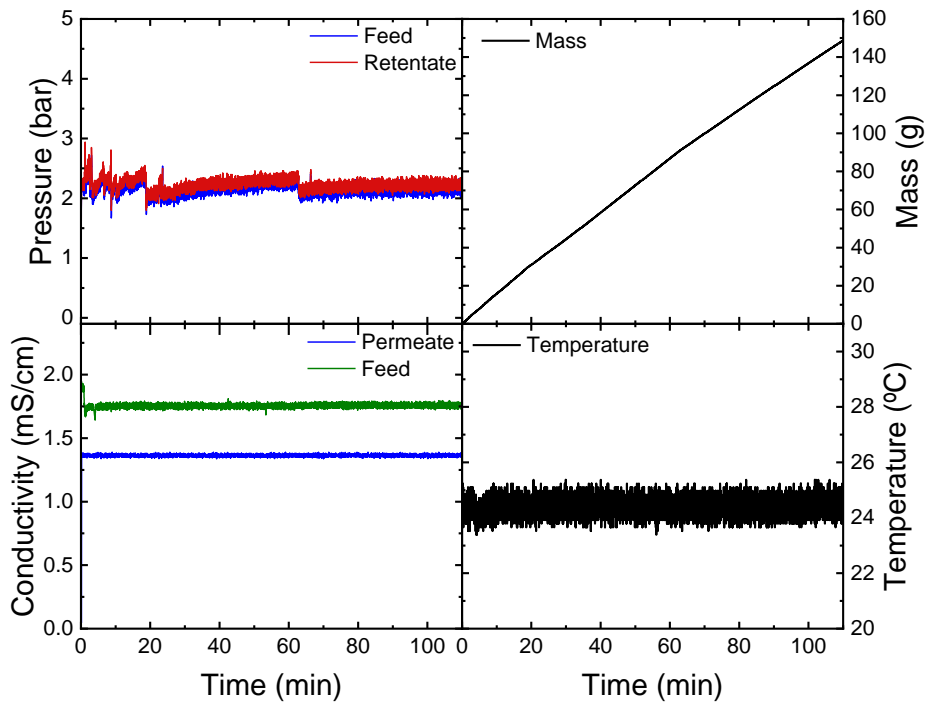

Figure 60. Data: E2 filtration test with 100kDa UF-SWCNT, feed 100 ng/L and glucose 10 mg/L.

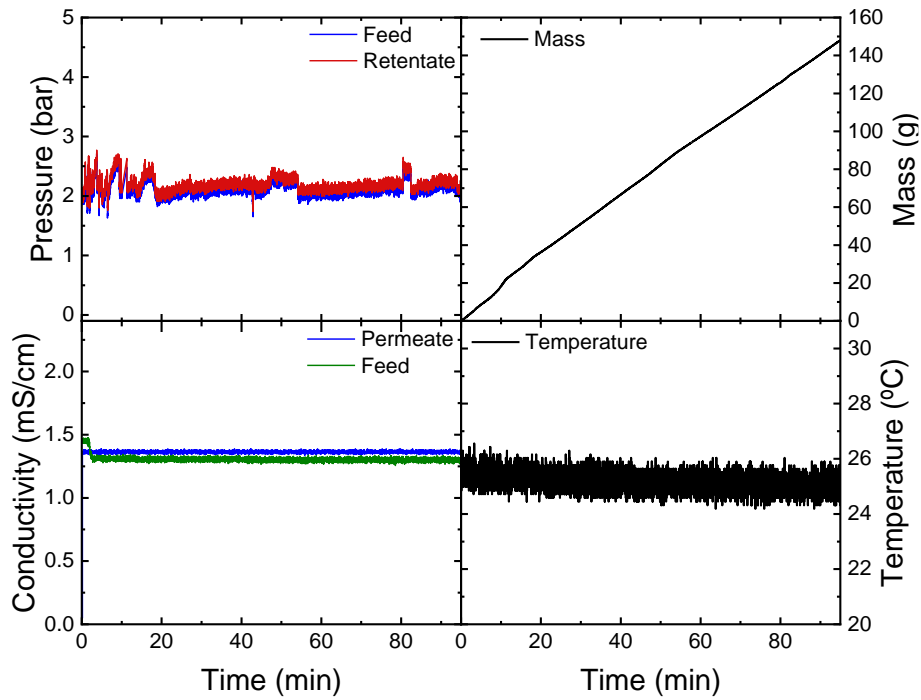

Figure 61. Data: E2 filtration test with 100kDa UF-SWCNT, feed 100 ng/L and alginate 10 mgC/L.

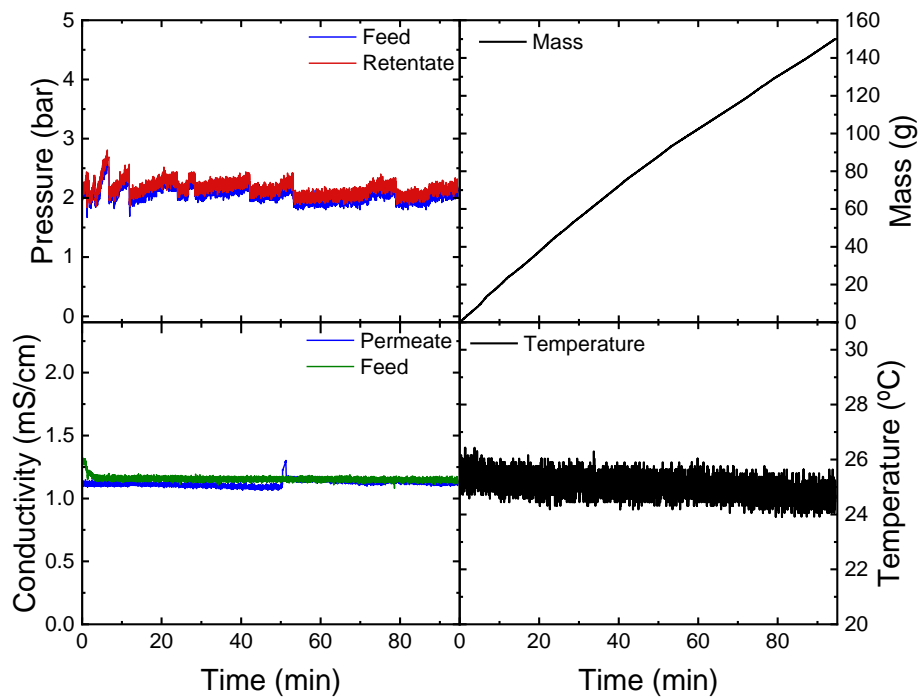

Figure 62. Data: E2 filtration test with 100kDa UF-SWCNT, feed 100 ng/L and tea extract 10 mgC/L.

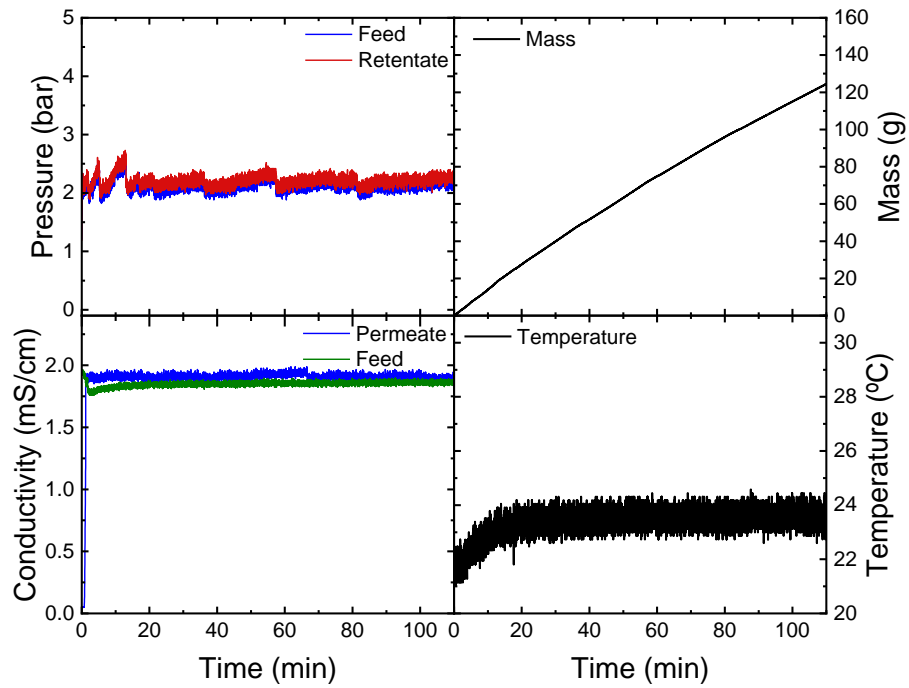

Figure 63. Data: E2 filtration test with 100kDa UF-SWCNT, feed 100 ng/L and humic acid 10 mgC/L.

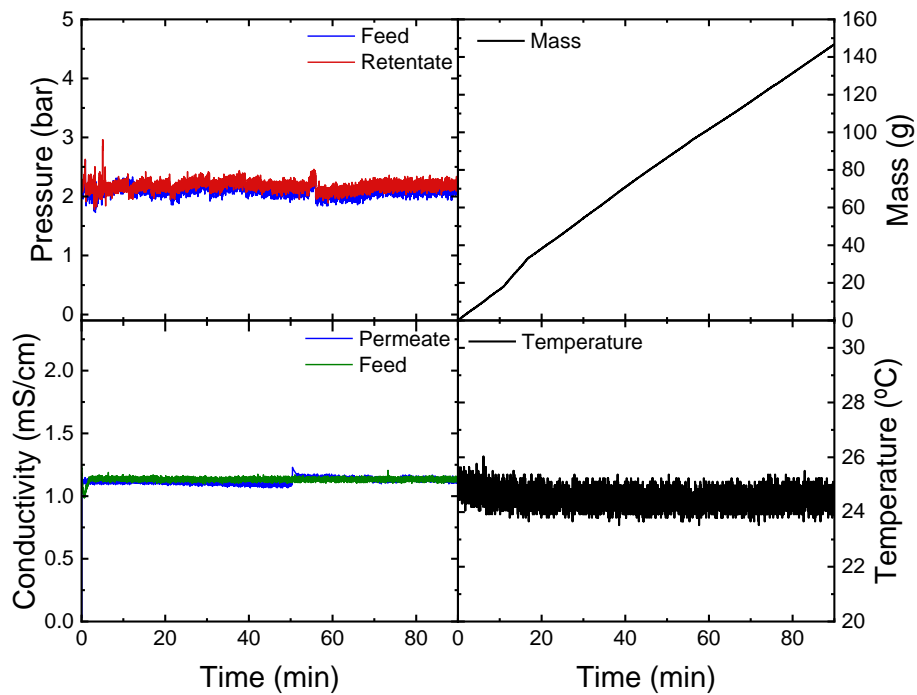

Figure 64. Data: E2 filtration test with 100kDa UF-SWCNT, feed 100 ng/L and tannic acid 10 mgC/L.

- Hormone removal tests in presence of tannic acid (TA)



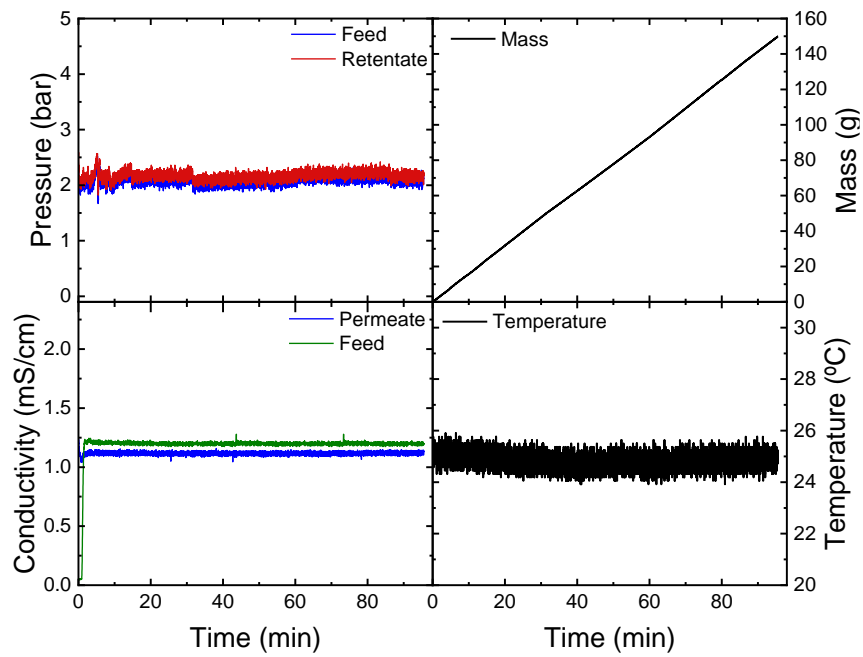

Figure 65. Data: E1 filtration test with 100kDa UF-SWCNT, feed 100 ng/L and TA 10 mgC/L.

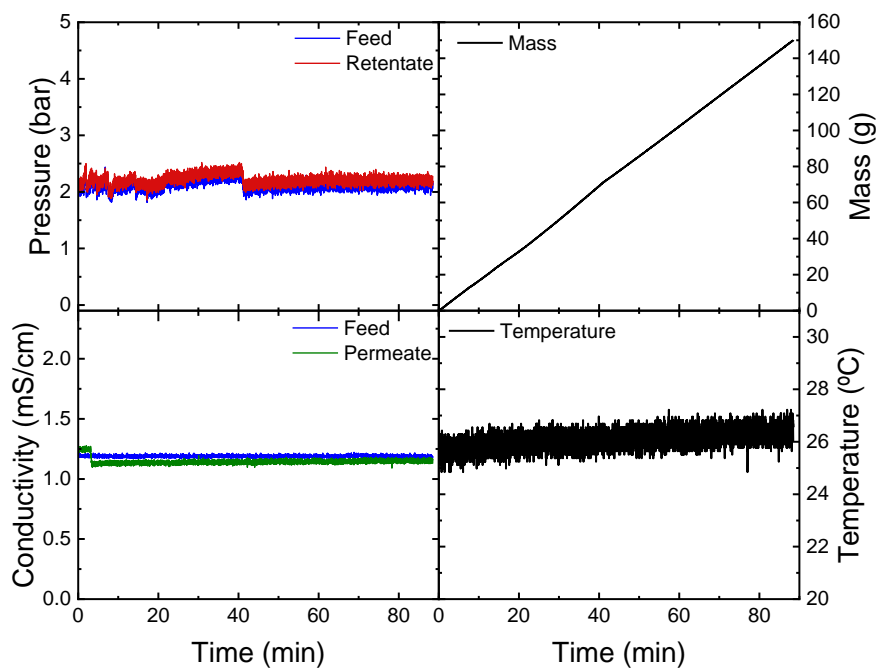

Figure 66. Data: Testosterone filtration test with 100kDa UF-SWCNT, feed 100 ng/L and TA 10 mgC/L.

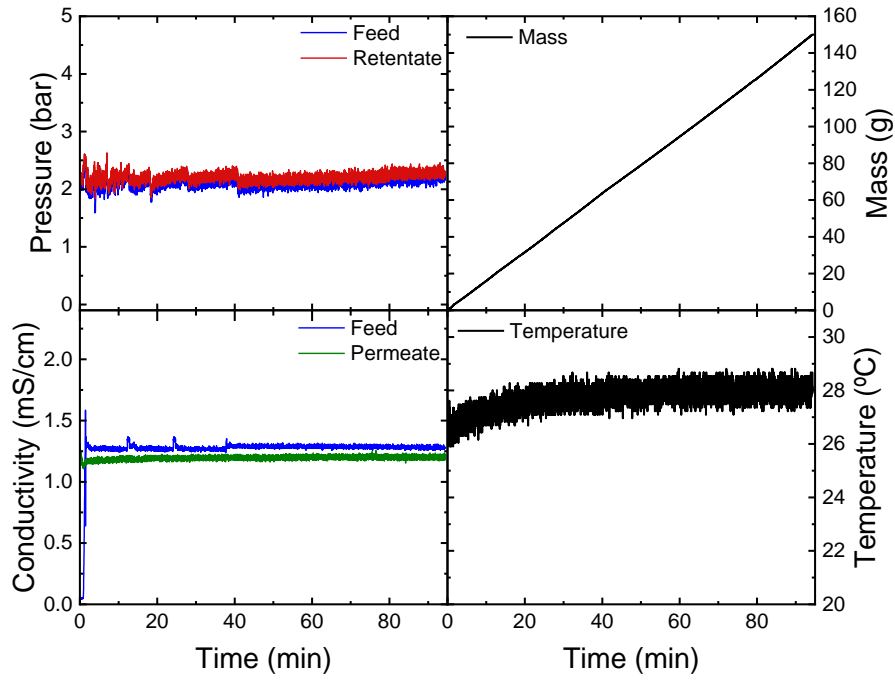

Figure 67. Data: Progesterone filtration test with 100kDa UF-SWCNT, feed 100 ng/L and TA 10 mgC/L.

- E2 removal tests with different MWCO membranes

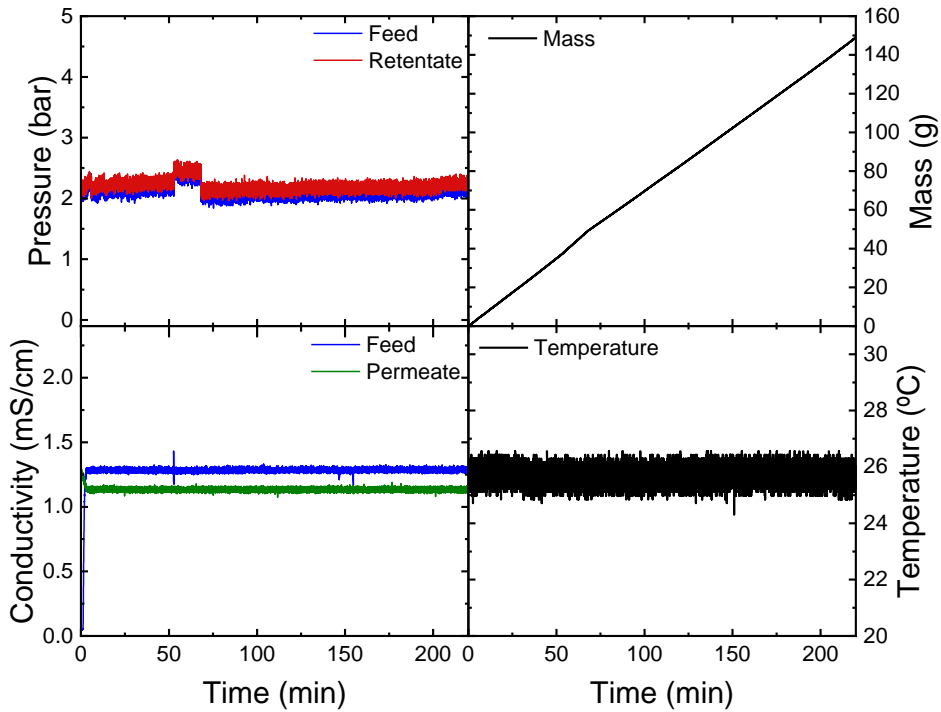

Figure 68. Data: E2 filtration test with 30kDa UF-SWCNT, feed 100 ng/L.

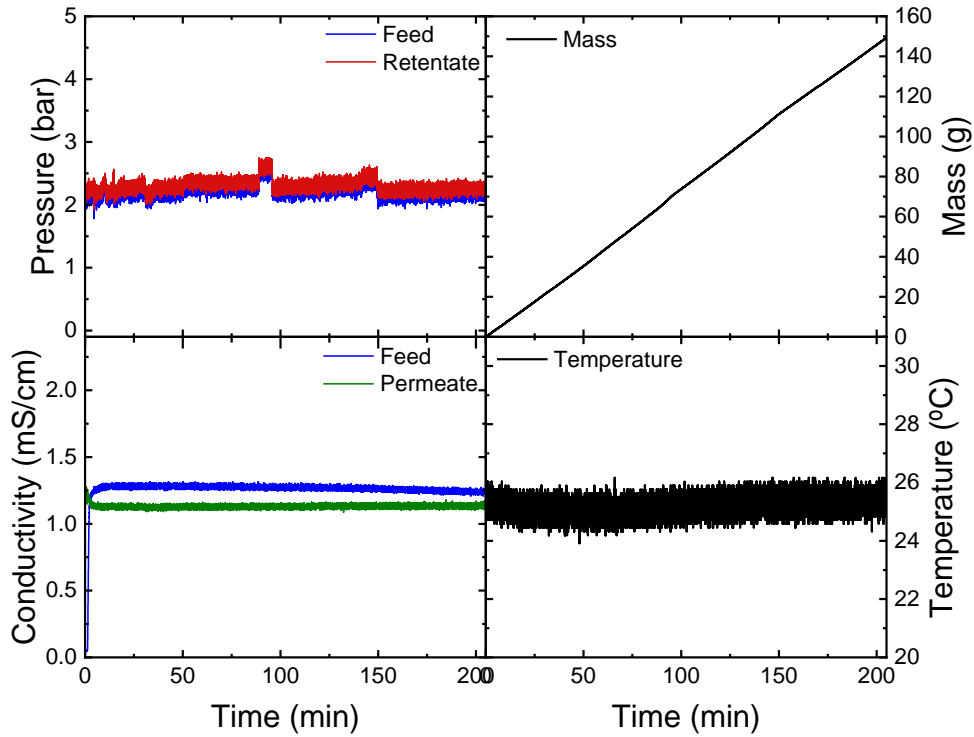

Figure 69. Data: E2 filtration test with 30kDa UF-SWCNT, feed 100 ng/L with TA 10 mg/L.

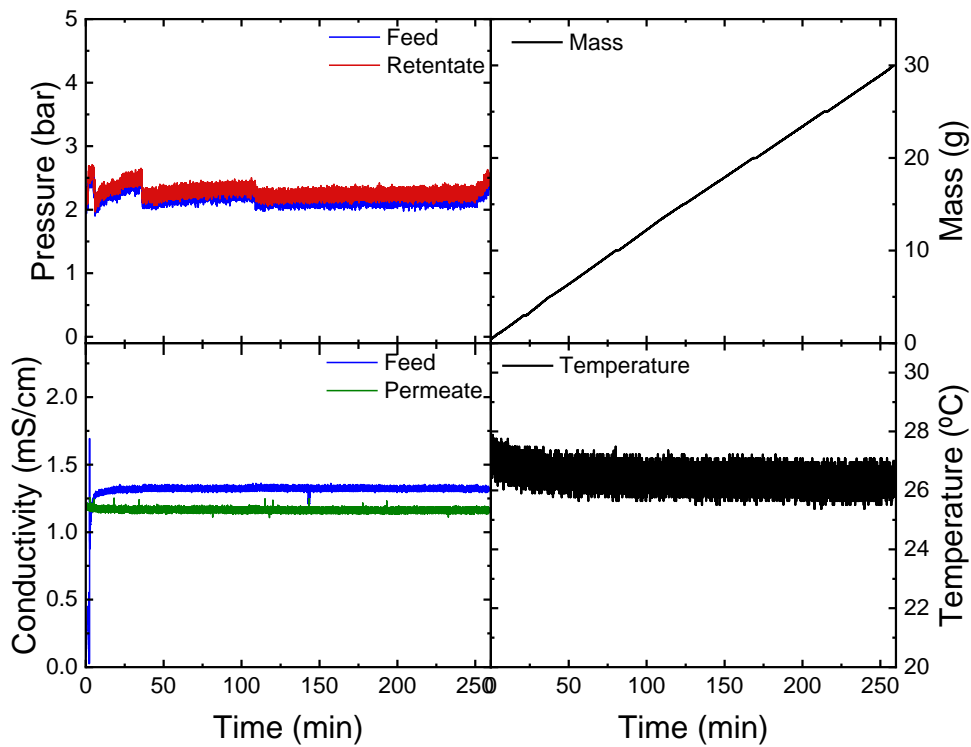

Figure 70. Data: E2 filtration test with 10kDa UF-SWCNT, feed 100 ng/L.

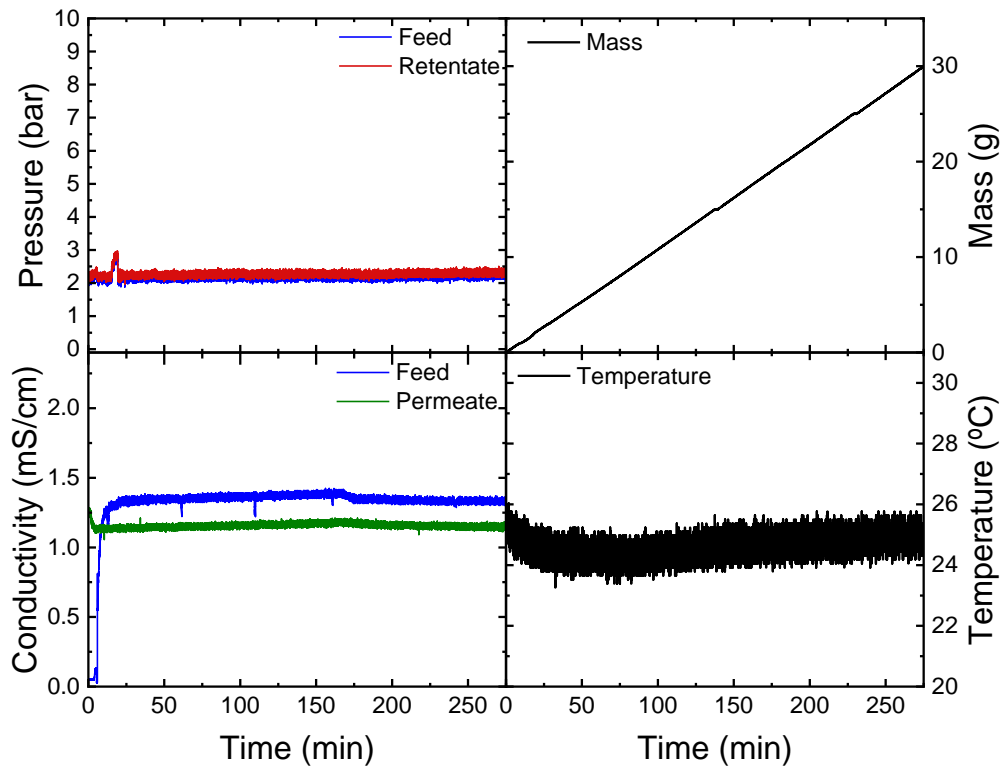

Figure 71. Data: E2 filtration test with 10kDa UF-SWCNT, feed 100 ng/L with TA 10 mg/L.

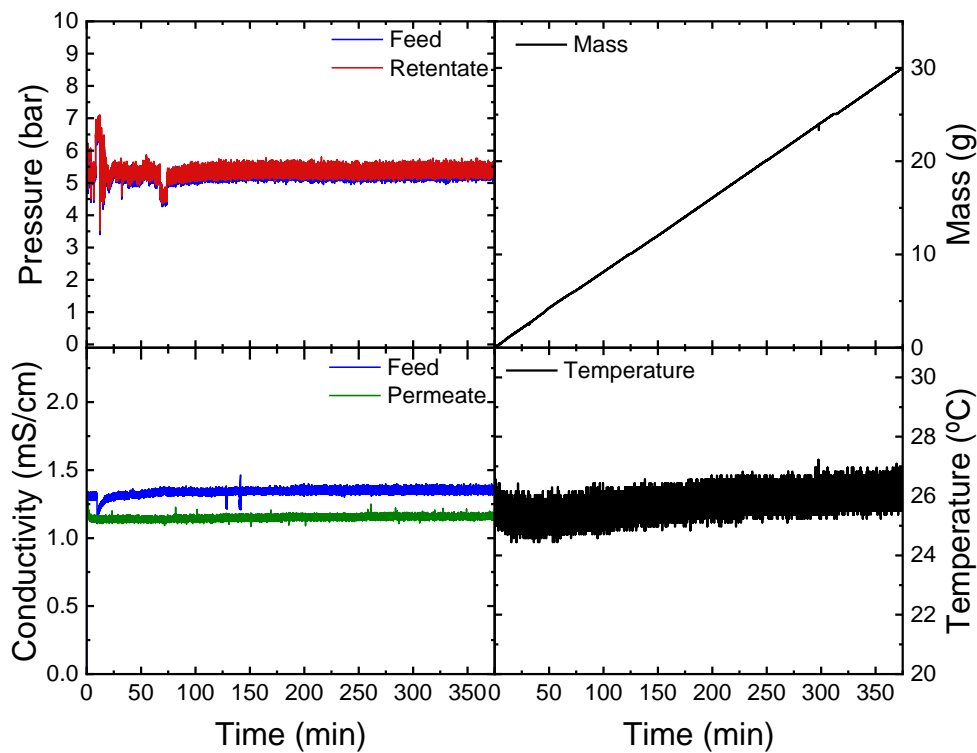

Figure 72. Data: E2 filtration test with 5kDa UF-SWCNT, feed 100 ng/L.

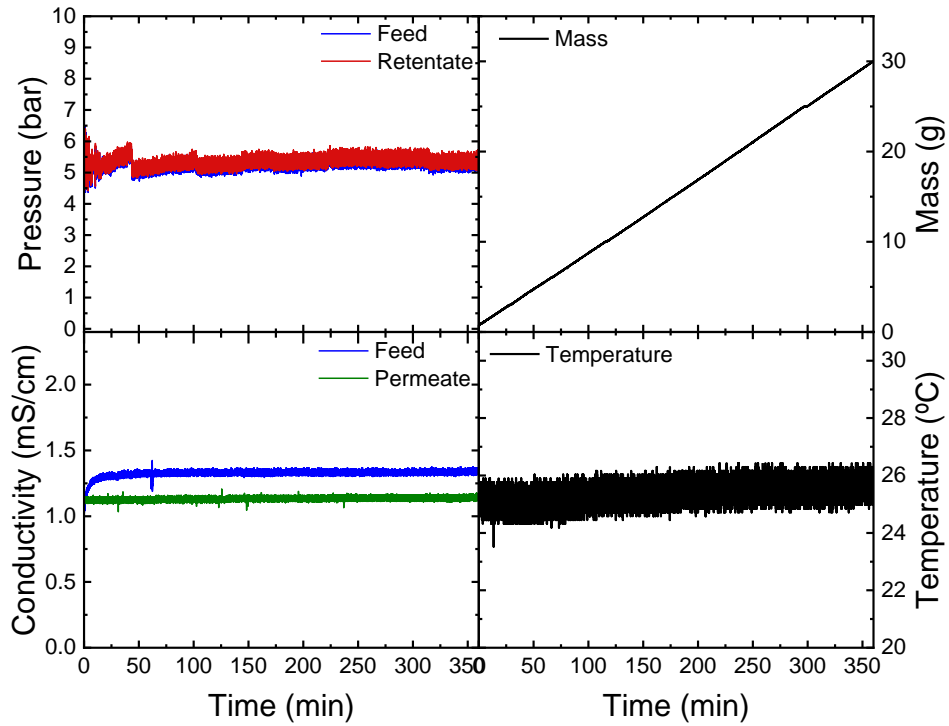

Figure 73. Data: E2 filtration test with 5kDa UF-SWCNT, feed 100 ng/L with TA 10 mg/L.

▪ E2 removal tests with 10kDa membrane at different pressures

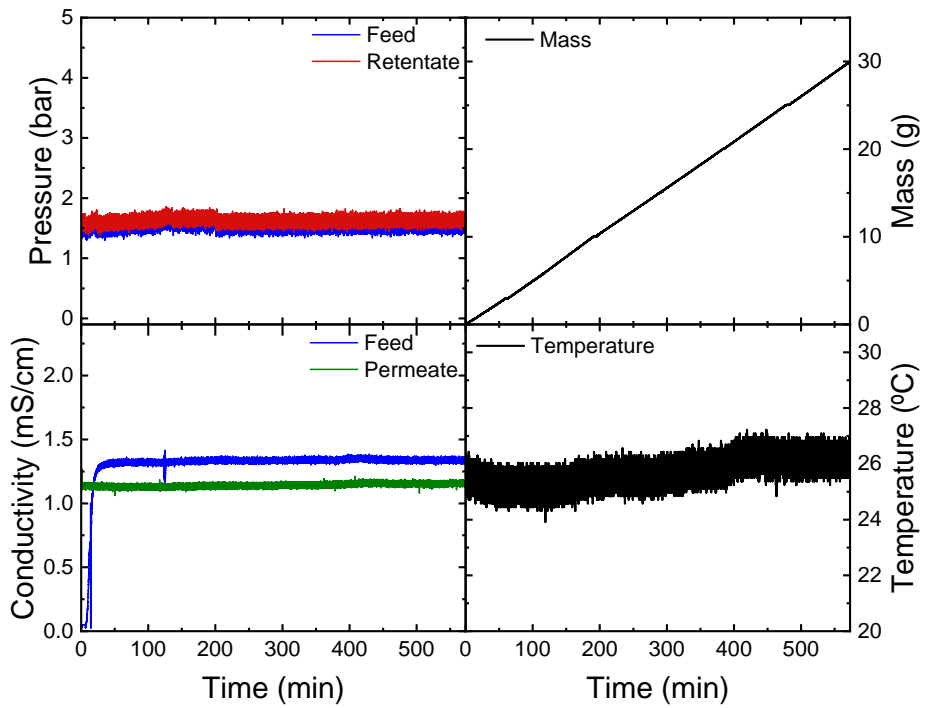

Figure 74. Data: E2 filtration test with 10kDa UF-SWCNT at 0.5 bar, feed 100 ng/L with TA 10 mg/L.

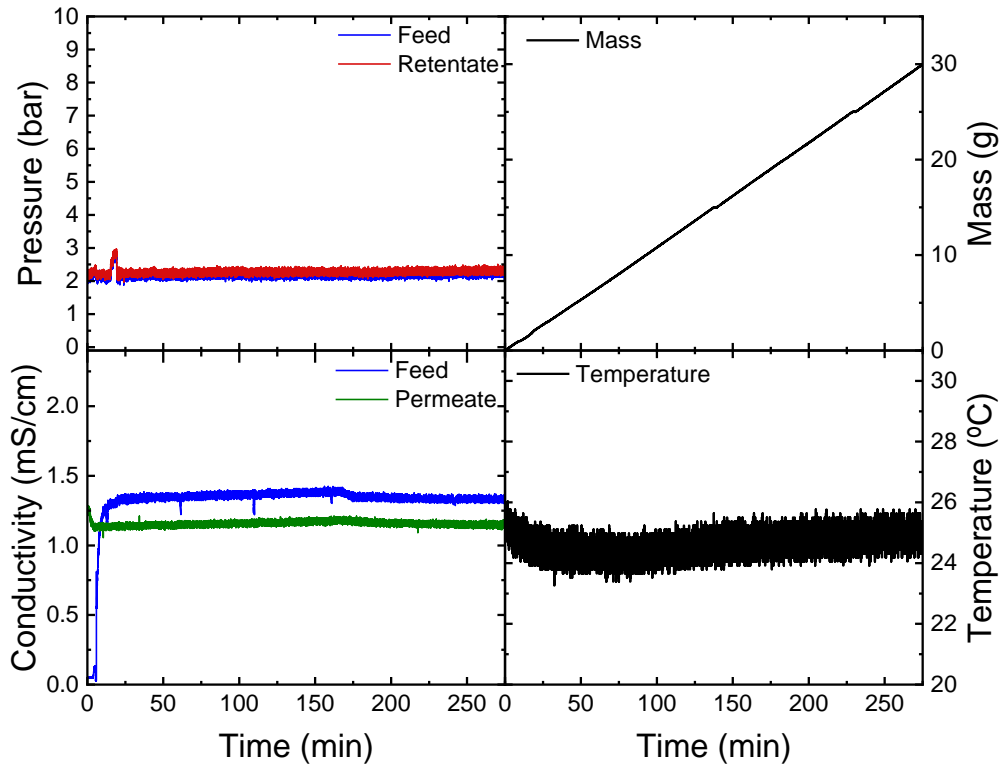

Figure 75. Data: E2 filtration test with 10kDa UF-SWCNT at 1 bar, feed 100 ng/L with TA 10 mg/L.

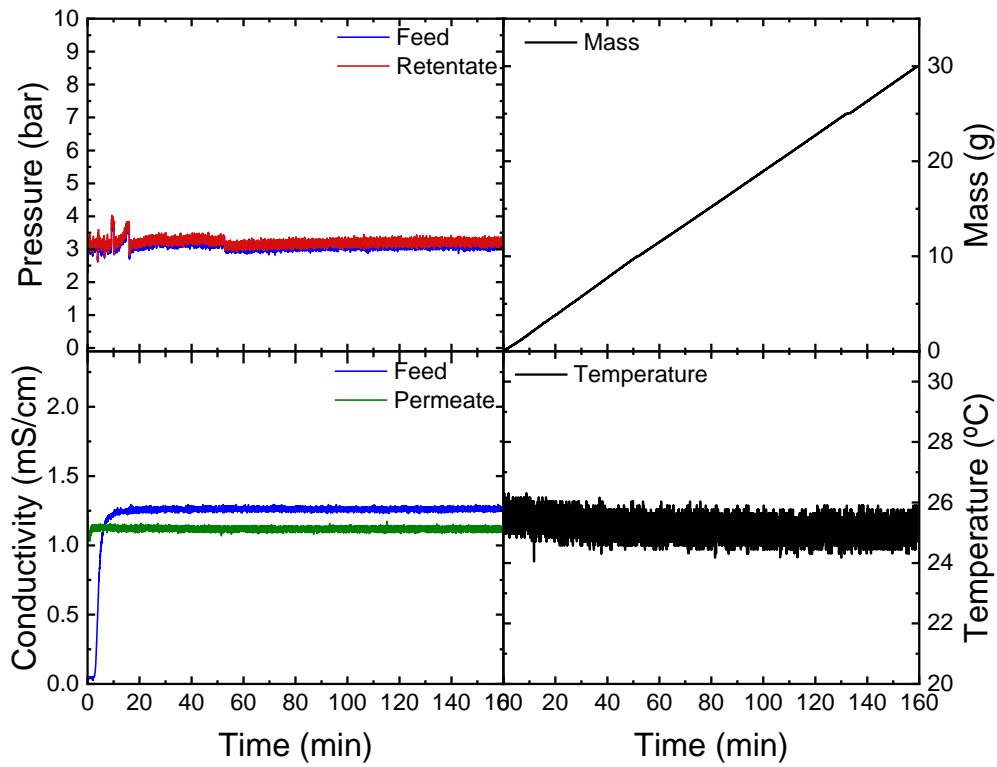

Figure 76. Data: E2 filtration test with 10kDa UF-SWCNT at 2 bar, feed 100 ng/L with TA 10 mg/L.

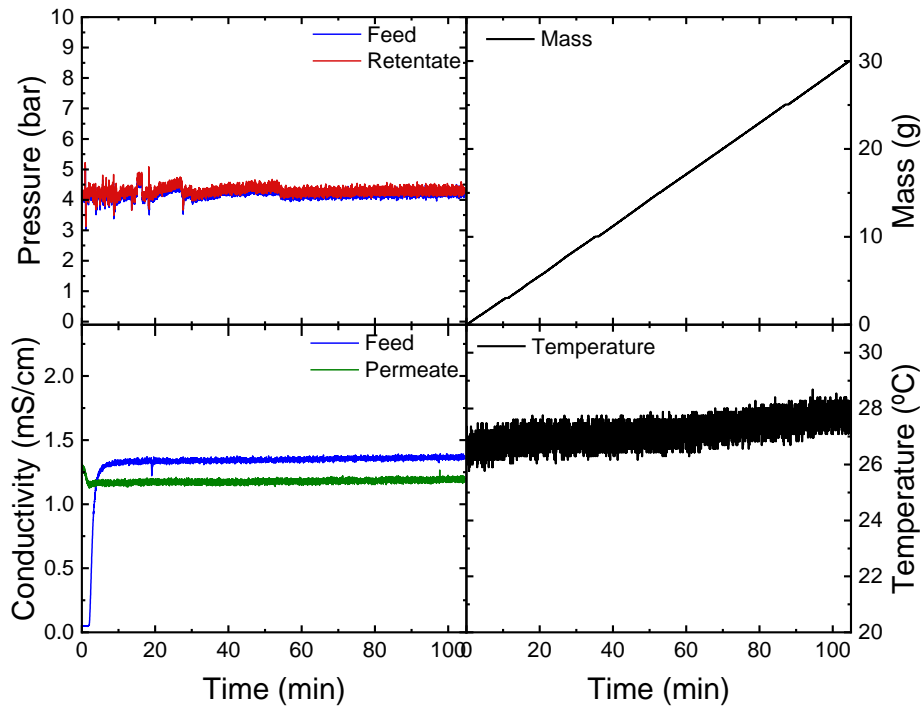

Figure 77. Data: E2 filtration test with 10kDa UF-SWCNT at 3 bar, feed 100 ng/L with TA 10 mg/L.

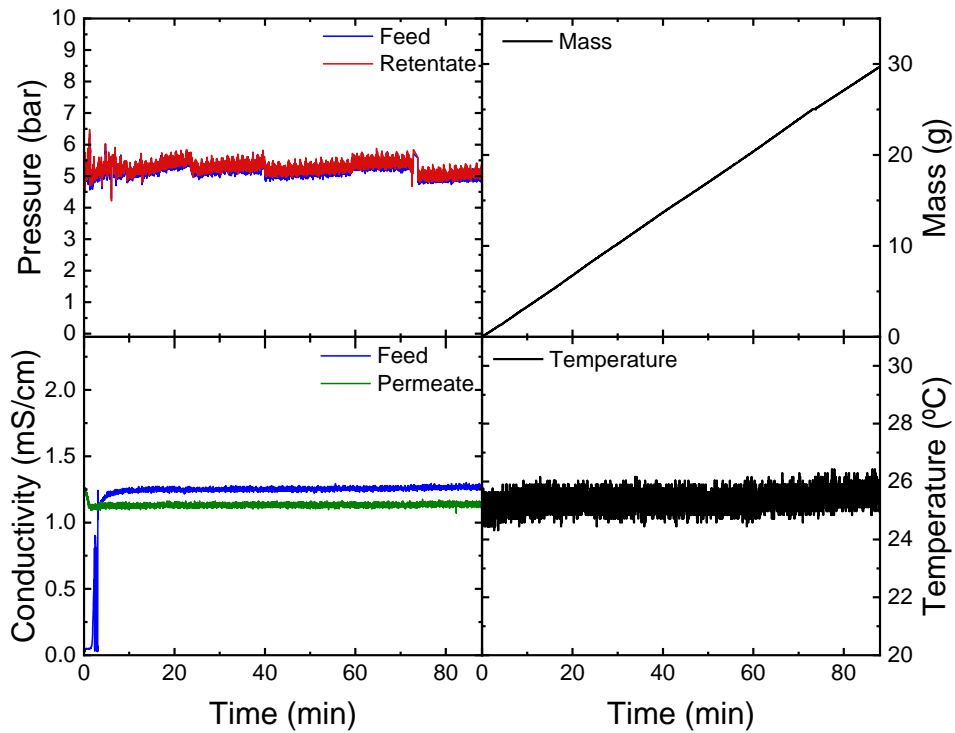

Figure 78. Data: E2 filtration test with 10kDa UF-SWCNT at 4 bar, feed 100 ng/L with TA 10 mg/L..

### A.8 Tannic acid removal at different pressures

Figure 79 shows the removal of tannic acid for filtration tests carried out at different pressures (MWCO 10 kDa). It can be seen how when the pressure increases, the removal of tannic acid increases.

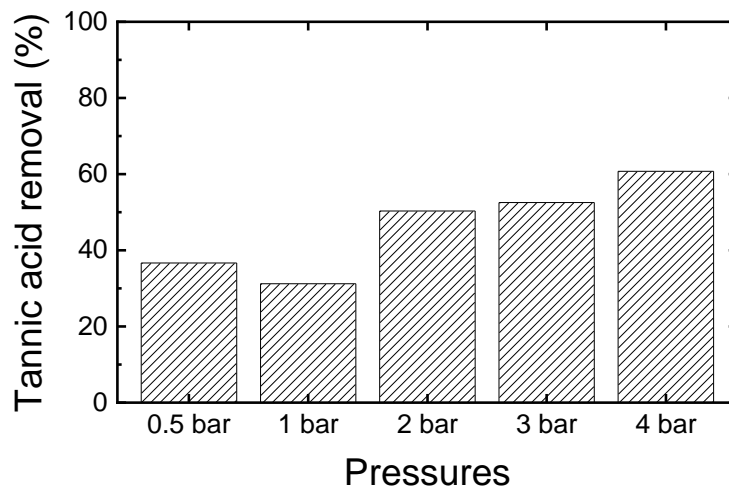

Figure 79. Tannic acid removal (initial concentration 10 mgC/L) UF-SWCNTs filtration (E2 100 g/L, CNPs 2g/m<sup>2</sup>, UF Ultracel 10 kDa) at different pressures (0.5, 1, 2, 3 and 4 bar).

### A.9 Additional test

In this test, it can be observed how HA interference is eliminated with 10kDa membranes. On the other hand, as it has been seen in the results section, with this MWCO membrane tannic acid continues interfering (different MW and different chemical structure).

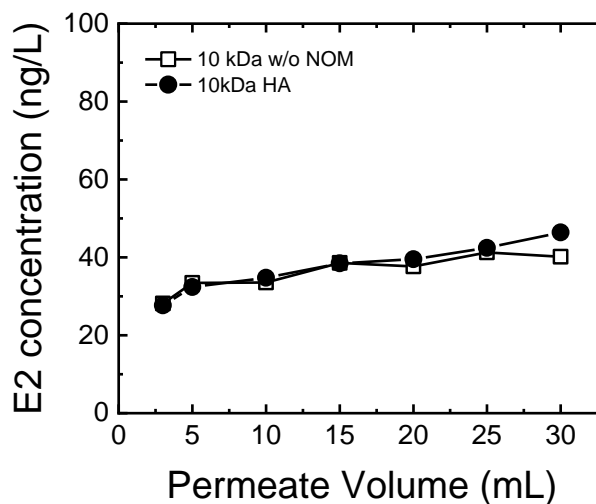

Figure 80. Permeate concentration of E2 (initial concentration 100 ng/L) with and without humic acid (10 mgC/L) in UF-SWCNTs filtration (CNPs 2g/m<sup>2</sup>, UF Ultracel 10 kDa).