



Article

# Environmental and Social Impact Assessment of Optimized Post-Tensioned Concrete Road Bridges

Vicent Penadés-Plà <sup>1</sup>, David Martínez-Muñoz <sup>1</sup> , Tatiana García-Segura <sup>2</sup> , Ignacio J. Navarro <sup>2</sup> and Víctor Yepes <sup>1,\*</sup> 

<sup>1</sup> Institute of Concrete Science and Technology (ICITECH), Universitat Politècnica de València, 46022 Valencia, Spain; vipepl2@cam.upv.es (V.P.-P.); damarmu1@cam.upv.es (D.M.-M.)

<sup>2</sup> Department of Construction Engineering and Civil Engineering Projects, Universitat Politècnica de València, 46022 Valencia, Spain; tagarse@upv.es (T.G.-S.); ignamar1@cam.upv.es (I.J.N.)

\* Correspondence: vyepesp@cst.upv.es; Tel.: +34-9638-79563; Fax: +34-9638-77569

Received: 3 April 2020; Accepted: 20 May 2020; Published: 22 May 2020



**Abstract:** Most of the definitions of sustainability include three basic pillars: economic, environmental, and social. The economic pillar has always been evaluated but not necessarily in the sense of economic sustainability. On the other hand, the environmental pillar is increasingly being considered, while the social pillar is weakly developed. Focusing on the environmental and social pillars, the use of methodologies to allow a wide assessment of these pillars and the integration of the assessment in a few understandable indicators is crucial. This article is structured into two parts. In the first part, a review of life cycle impact assessment methods, which allow a comprehensive assessment of the environmental and social pillars, is carried out. In the second part, a complete environmental and social sustainability assessment is made using the ecoinvent database and ReCiPe method, for the environmental pillar, and SOCA database and simple Social Impact Weighting method, for the social pillar. This methodology was used to compare three optimized bridges: two box-section post-tensioned concrete road bridges with a variety of initial and maintenance characteristics, and a pre-stressed concrete precast bridge. The results show that there is a high interrelation between the environmental and social impact for each life cycle stage.

**Keywords:** sustainability; LCA; S-LCA; social assessment; ecoinvent; SOCA

## 1. Introduction

Since its definition in 1987 by the World Commission on Environment and Development [1], the concept of sustainability has been attracting increasing attention in many sectors of our society. However, it was not until 2015 that the first set of Sustainable Development Goals was established as a response to growing social needs and environmental degradation [2].

Despite social assessment being an important part of the sustainability definition, its evaluation is underestimated or relatively weak with respect to the other pillars of sustainability when sustainability assessments of products, processes, or services have been carried out [3,4]. Vallance et al. [5] stated that this is due to the fact that the definition of social sustainability is quite ambiguous, and Murphy [3] indicated that there are no clear criteria for assessing sustainability. However, social equity, education, basic health, and participatory democracy are important for sustainability development [6]. At present, there is a trend toward giving the social pillar the same importance as the economic and environmental pillars [7–10]. This is demonstrated by the fact that 6 of the 17 sustainable development goals proposed by the United Nations focus on social problems.

The complex stakeholder situation in construction projects makes performing a social sustainability assessment difficult [11]. Valdes-Vasquez and Klotz [12] indicated that projects in the construction sector

involve clients, employees, the community, and industry, and have the intention of satisfying current and future needs. Later, Almahmoud and Doloi [13] stated that the social aspect in the construction sector can be represented through the satisfaction of the different stakeholders involved in the projects, including industry, users, and the community. They also indicated that the importance of the impact of the project for future generations and the impact on present generations through health, safety, and conditions of workers must be taken into account.

A sustainability assessment becomes a decision-making problem [14–17]. In addition, this decision-making problem can be assessed taking into account the different perspectives of the decision-makers reaching robust sustainable solutions [18]. Bridges have been widely investigated from the technical point of view [19–21]. This provides a great number of different designs of bridges that engineers must select from a sustainable point of view. Penadés-Plà et al. [22] reviewed the criteria considered to assess the different pillars of sustainability in bridges, as well as the multi-attribute decision-making methods used to obtain a global sustainability assessment. This review shows that the economic pillar is the most developed pillar. Although some early works only studied the initial cost of the bridge, a life cycle cost assessment (LCCA) is, nowadays, widely used. Conversely, a life cycle assessment (LCA) is less common. For the environmental part, few studies have applied environmental life cycle assessments (E-LCAs) to bridges. Horvath and Hendrickson [23] and Widman [24] conducted the first investigations. Then other works followed. However, most of them did not consider all phases of the bridge's life cycle [25,26], or they focused on a limited number of environmental indicators (usually energy and CO<sub>2</sub>) [27,28]. It was not before the study by Steele et al. [29] that a full E-LCA was performed. Pang et al. [30] compared different bridge maintenance operations, and Du et al. [31] and Hammervold et al. [32] compared several bridge designs. Regarding the social part, there is no consensus to define the criteria that best represent social life cycle assessment (S-LCA). Some works have considered criteria as divergent as detour time, dust, or noise [33–35].

In this paper, a bibliographic review of the LCA methods, both environmental and social, will first be conducted in Section 2. After that, Section 3 explains the methodology used, after discussing the best methods to assess the social and environmental pillars of bridges. In Section 4, these methods are used to carry out a sustainability assessment of three road bridges: two box-section road bridges with different initial and maintenance characteristics, and a pre-stressed concrete precast bridge. Section 5 shows the results of all the pillars of sustainability, focusing on social assessment. As a final point, conclusions are presented in Section 6.

## 2. Life Cycle Assessment Methods

To carry out a complete sustainability assessment, it is essential to consider the whole life cycle of a product, service, or process. This is even more important in the construction sector, because structures are built to provide a service over a long time, and therefore the assessment of the use and maintenance stage becomes quite important. For this purpose, a life cycle assessment methodology is used. At this point, it is necessary to point out that despite the LCA techniques—used to assess both the environmental and social pillars—having the same central core, there are some differences between them. For this reason, in this study, the term LCA will be used when referring to the common trunk of the technique and the terms E-LCA (environmental pillar) and S-LCA (social pillar) are going to be used for specific assessments.

Focusing on environmental, the ISO 14040 [36] defines LCA as a technique for evaluating the environmental aspect and impacts caused by a process, product, or service through a system of input flows (data) that cause output flows (impacts). The most common guide to carry out the social assessment [37] follows the same steps as this code. ISO 14040 [36] divides the LCA into four phases:

- Goal and scope definition
- Inventory analysis
- Impact assessment
- Interpretation of results

The impact assessment step of the LCA is crucial since the information obtained from the life cycle inventory is transformed into a set of understandable indicators. Due to the complexity of this transformation, some methodologies have been developed to simplify this step, called life cycle impact assessment (LCIA) methods. In this sense, the assessment and comparison between different cases become easier.

### 2.1. Environmental Life Cycle Impact Assessment

In the E-LCA, there are two approaches to transform the life cycle inventory into understandable indicators: the “midpoint approach” and the “endpoint approach”. The midpoint approach refers to environmental impact, while the endpoint approach refers to environmental damage. The midpoint approach provides more complete information, and the endpoint approach allows for more concise information (Figure 1).

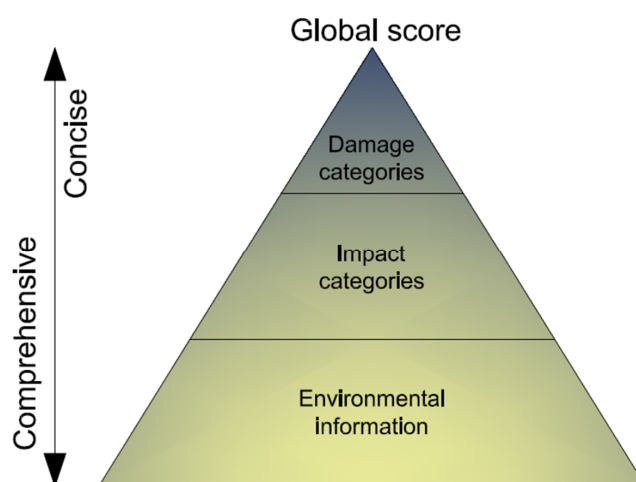

Figure 1. Environmental life cycle cost assessment (E-LCA) approaches.

Another way to understand the differences between these two approaches is to consider that the midpoint approach is the direct cause, while the endpoint approach is the long-term consequence. For example, any process, product, or service that affects climate change has gas emissions to the atmosphere that cause several environmental problems such as ozone depletion or global warming (midpoint approach); in the long-term approach, these gas emissions will cause damage to the ecosystem, human health, or resources. In this example, ozone depletion can lead to increased skin cancer problems (endpoint approach).

Table 1 shows the most common methods for each category and the indicators (midpoint indicators for the midpoint approach and endpoint indicators for the endpoint approach) considered for each E-LCIA method. Each approach uses different methods to convert environmental information into comprehensible and understandable indicators. Within midpoint approach methods, the classical methods are the CML [38], EDIP 2003 [39], and TRACI [40]. These methods provide a set of midpoint indicators that indicate the direct cause by a process, product, or service. The total number of these indicators is usually quite high, providing accurate information, but which is sometimes difficult to interpret. In addition, midpoint indicators are more difficult to understand because they depict an earlier stage in the cause–effect chain. Endpoint approach methods are damage-oriented methods, such as the Eco-indicator 99 [41], EPS [42], and eco-scarcity [43]. These methods provide a set of endpoint indicators that indicate the long-term consequences for a process, product, or service. The number of these indicators is usually quite small because it is an aggregation of the midpoint indicators. Therefore, there is a loss of detail and the information is not as accurate as in the case of midpoint methods, but much easier to interpret. In addition, there is a set of new methods, which combines the methods of midpoint and endpoint approaches, such as the ReCiPe [44,45], LIME [46], and IMPACT 2008 [47].

**Table 1.** Environmental life cycle impact assessment (E-LCIA) indicators.

E-LCIA Group	E-LCIA Method	Midpoint Indicators	Endpoint Indicators
Midpoint approach	CML 2000	Obligatory impact categories: Depletion of abiotic resources, climate change, land competition, stratospheric ozone depletion, human toxicity, freshwater aquatic ecotoxicity, terrestrial ecotoxicity, marine aquatic ecotoxicity, photo-oxidant formation, acidification, and eutrophication. Optional impact categories: Loss of life support function, loss of biodiversity, marine sediment ecotoxicity, freshwater sediment ecotoxicity, impacts of ionizing radiation, waste heat, malodorous air, noise, casualties, lethal, non-lethal, depletion of biotic resources, desiccation, and malodorous water	
	EDIP 2003	Global warming, ozone depletion, terrestrial eutrophication, acidification, aquatic eutrophication, photochemical ozone formation, ecotoxicity, human toxicity, and noise	
	TRACI	Ozone depletion, global warming, smog formation, eutrophication, acidification, eco-toxicity, human health cancer, human health non-cancer, human health criteria pollutants, and fossil fuel depletion	
Endpoint approach	EI99		Climate change, ozone layer depletion, acidification, eutrophication, respiratory effects, carcinogenicity, ionizing radiation, ecotoxicity, land use, mineral resources, fossil resources
	EPS		Life expectancy, severe morbidity and suffering, morbidity, severe nuisance, wood production capacity, nuisance crop production capacity, fish and meat production capacity, base cation capacity, production capacity for water, share of species extinction, depletion of element reserves, depletion of fossil reserves (coal), depletion of fossil reserves (gas), depletion of fossil reserves (oil), and depletion of mineral reserves
	Eco-scarcity		Ozone depletion, photochemical oxidant formation, respiratory effects, air emissions, surface water emissions, radioactive emissions, cancer caused by radionuclides emitted to the sea, emissions to groundwater, emissions to soil, radioactive wastes, landfill municipal (reactive) wastes, hazardous wastes (stored underground), water consumption, gravel consumption, primary energy resources, endocrine disruptors, and biodiversity losses

Table 1. Cont.

E-LCIA Group	E-LCIA Method	Midpoint Indicators	Endpoint Indicators
Midpoint/Endpoint approach	ReCiPe	Climate change, ozone depletion, terrestrial acidification, freshwater eutrophication, marine eutrophication, human toxicity, photochemical oxidant formation, particulate matter formation, marine ecotoxicity, terrestrial ecotoxicity, freshwater ecotoxicity, ionizing radiation, agricultural land occupation, urban land occupation, natural land transformation, water depletion, mineral resource depletion, fossil fuel depletion	Damage to human health, damage to ecosystem diversity, and damage to resource availability
	LIME	Ozone layer depletion, global warming, acidification, photochemical oxidant formation, regional air pollution, human-toxic chemicals, ecotoxic chemicals, eutrophication, waste landfill, land use, resources, and consumption	Cataracts, skin cancer, other cancers, respiratory diseases, thermal stress, infectious diseases, agricultural production, hypoalimentation, disaster causality, forestry production, fishery production, loss of land-use, energy consumption, user cost, terrestrial ecosystem, aquatic ecosystem
	IMPACT 2000+	Human toxicity, respiratory effects, ionizing radiation, ozone depletion, photochemical oxidant formation, terrestrial ecotoxicity, aquatic ecotoxicity, aquatic eutrophication, terrestrial eutrophication and acidification, land occupation, global warming, non-renewable energy, and mineral extraction	Damage to human health, damage to ecosystem quality, damage to climate change, and damage to resources

## 2.2. Social Life Cycle Impact Assessment

The social pillar of sustainability is the least studied and probably the most diffuse and weakest pillar of sustainability. However, for a complete sustainability assessment, it is necessary to obtain a complete set of social indicators that can be used to carry out an accurate comparison and assessment of alternatives. Currently, a simple Social Impact Weighting Method is used to convert the life cycle inventory into understandable indicators. However, there are two important social databases: PSILCA (Product Social Impact Life Cycle Assessment) [48] and SHDB (Social Hotspots Database) [49]. Both S-LCIA databases are inspired by UNEP/SETAC guidance [37] and use the activity variable “worker hour” in order to quantify the social impacts. Table 2 shows existing and planned categories of both methods grouped by stakeholders for the PSILCA database [50] and for the SHDB database [51]. However, the number of categories is lower nowadays.

**Table 2.** Social life cycle impact assessment (S-LCIA) categories.

S-LCIA Database	CATEGORIES
Product Social Impact Life Cycle Assessment (PSILCA)	<p>WORKERS: Child labor, fair salary, discrimination, forced labor, health and safety, social benefits and legal issues, working time, workers’ rights.</p> <p>VALUE CHAIN ACTORS: Corruption, promoting social responsibility, fair competition, supplier relationships.</p> <p>SOCIETY: Contribution to economic development, health and safety, prevention and mitigation of conflicts.</p> <p>LOCAL COMMUNITY: Access to material resources, respect of indigenous rights, local employment, safe and healthy living conditions, migration.</p> <p>CONSUMERS: Health and safety, transparency, end of life responsibility.</p>
Social Hotspot Database (SHDB)	<p>LABOR RIGHTS AND DECENT WORK: Child labor, discrimination, excessive working time, freedom of association, forced labor, labor laws, migrant labor, poverty, social benefits, unemployment, wage assessment.</p> <p>HUMAN RIGHTS: Indigenous rights, human health issues, gender equity, high conflicts.</p> <p>HEALTH AND SAFETY: Injuries and fatalities, toxins and hazards.</p> <p>GOVERNANCE: Legal system, corruption.</p> <p>COMMUNITY: Drinking water, children out of school, hospital beds, sanitation, smallholder vs. commercial farms.</p>

The PSILCA database was developed by GreenDelta and presented in 2013. This database provides information to carry out the assessment of the social pillar of products, processes, or services for their whole life cycle. The PSILCA covers 189 individual countries represented by around 15,000 units classified by entities (i.e., industries and commodities). Currently, there are 54 indicators grouped into 18 categories and 4 affected stakeholders, and it is expected to reach 88 indicators [50].

The SHDB database is a project, which was developed by New Earth in 2009 and published in 2013. The project seeks to provide in-depth information on human rights and working conditions along supply chains, to assess risks and provide methods to calculate social footprints. This database covers 113 individual countries represented by around 6500 units classified by entities (i.e., industries and commodities). Currently, there are over 157 indicators grouped into 26 themes and 5 big groups [51].

## 3. Methodology

Section 2 reviews the most important methodologies used to carry out a complete E-LCA and S-LCA. Although E-LCA is a methodology that is increasingly being implemented, the bibliographic review shows that only a few works have applied E-LCIA methods to evaluate the environmental pillar of sustainability in bridges. These works only use three different E-LCIA methods: CML 2000 (midpoint approach) [52–54], EI99 (endpoint approach) [29], and ReCiPe (midpoint/endpoint approach) [10,31,55,56].

This paper tries to show a methodology to carry out the environmental assessment at all levels. For this purpose, a midpoint/endpoint approach method is necessary. Among the different midpoint/endpoint approaches, the ReCiPe [44,45] method is considered an evolution of CML (midpoint method) and Eco-indicator (endpoint method). The Eco-indicator and CML methods are currently obsolete and have been substituted with the ReCiPe method that has updated characterization and weight factors.

The midpoint approach of the ReCiPe method groups the results into 18 midpoint impact categories, measuring each according to its respective units: agricultural land occupation (ALO), climate change (GWP), fossil depletion (FD), freshwater eutrophication (FEP), freshwater ecotoxicity (FEPT), human toxicity (HTP), ionizing radiation (IRP), marine ecotoxicity (MEPT), marine eutrophication (MEP), particulate matter formation (PMF), metal depletion (MD), natural land transformation (NLT), ozone depletion (OD), photochemical oxidant formation (POFP), terrestrial acidification (TAP), terrestrial ecotoxicity (TEPT), urban land occupation (ULO), and water depletion (WD). These environmental midpoint impact categories have a high level of detail, providing accurate results, although they are more difficult to interpret. The endpoint approach of the ReCiPe method integrates several midpoint impact categories into three endpoint areas of protection: human health (HH), ecosystems (E), and resource availability (R). These endpoint areas of protection have the advantage of being easier to interpret and understand. However, the uncertainty of these results increases due to the high level of aggregation of them. In order to integrate all environmental midpoint impact categories into an overall score, the E-LCIA results are normalized under the use of the ReCiPe normalization factors with respect to Europe per capita emissions [44,57]. In this way, a global score of the total environmental impact caused by the bridge throughout all of its life cycle can be obtained. This overall score is measured in points. In addition, in order to include the long-term perspective of environmental impacts, the hierarchical perspective was used, due to the inclusion of recycling and the subsequent use of steel and concrete for other purposes after the end of the useful life of the structure.

Regarding the S-LCA, although some authors have stated that this methodology is important [3], it is rarely studied, and even less so in the construction sector. The bibliographic review did not find studies that have used the PSILCA or SHDB databases to assess the social pillar of sustainability. This work considers the PSILCA database because it has the most updated available data source, transparent documentation of original data sources, and risk assessment, and provides data quality assessment. In addition, the social information from the PSILCA database can be associated with the processes of the ecoinvent database by the means of an add-on called SOCA developed by Green Delta. In this way, the social assessment can be carried out using the same processes as the environmental assessment, giving coherence to the overall assessment. The SOCA database uses the first version of PSILCA, and provides 54 quantitative and qualitative indicators addressing 18 categories and 4 affected stakeholder groups [48]. In this way, the final indicators of the environmental and social pillars broadly represent the assessment of these pillars, as these indicators group all the information from the databases into the indicators described. In addition, both environmental and social evaluations are carried out using the open source life cycle assessment OpenLCA software. Figure 2 shows the methodology used in this work. To reduce the number of outputs, the endpoint approach of ReCiPe is used to assess the environmental pillar of sustainability, and the indicators provided by the SOCA database are grouped into the four stakeholders represented.

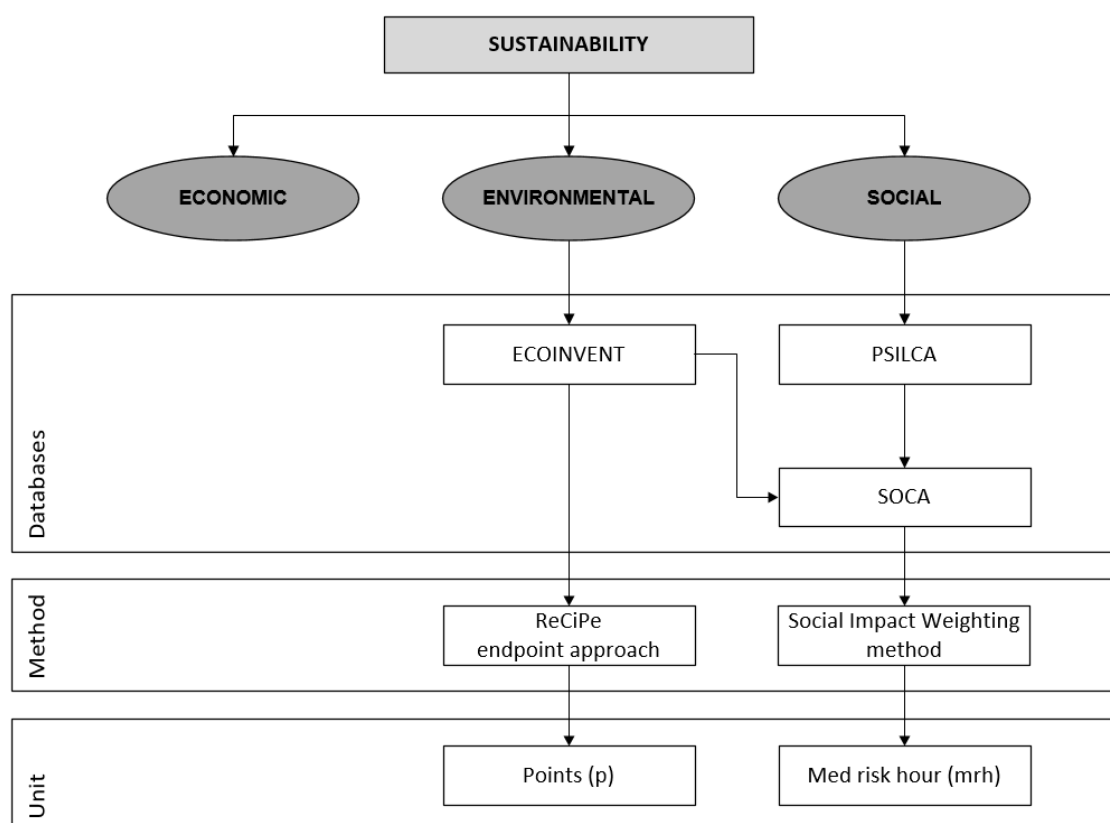

Figure 2. Methodology used in this work.

## 4. Case Study

### 4.1. Goal and Scope

The present work aims to provide a comparative life cycle assessment of three alternative concrete bridge designs, from the social and the environmental perspectives. The results of such an approach shall provide valuable information regarding the relationship existing between both dimensions when it comes to the sustainable design of infrastructures. In particular, special emphasis is put on the assessment of the social impacts derived from the different designs under analysis. The conclusions drawn from this case study aim to contribute to the existing knowledge on the social consequences of transport infrastructures.

#### 4.1.1. Functional Unit

Three optimized bridges are analyzed: two box-section post-tensioned concrete road bridges that have different initial and maintenance characteristics, and a pre-stressed concrete precast bridge. These bridges have a width of 12 m and are situated in a seaside region of eastern Spain, whose environment is classified as XC-4 according to EN 206-1 [58]. Therefore, corrosion is mostly due to carbonation and these bridges are subject to the same environmental and traffic conditions. In addition, they have the same width and similar lengths. Therefore, the bridges can be considered equivalent.

The box-section post-tensioned concrete road bridges have a continuous span of 35.2 m, 44 m, and 35.2 m. The first bridge (or alternative A1) was constructed using 50 MPa of concrete and requires one maintenance period, while the second bridge (or alternative A2) was constructed using 35 MPa of concrete and requires two maintenance periods. These bridges are optimized to meet the codes during a service life of 150 years. The distances considered for these bridges are 20 km to carry the aggregate to the concrete plant, 10 km to carry the cement to the concrete plant, 20 km to carry the concrete to the construction place, and 100 km to carry the steel to the construction place.



The pre-stressed concrete precast bridge has three spans of 40 m. This bridge (or alternative A3) was constructed using 35 MPa of concrete in the beams and 40 MPa of concrete in the slab, and requires one maintenance period. This bridge is optimized to meet the codes during a service life of 120 years. The distances considered are 50 km to carry the aggregate to the precast concrete plant, 10 km to carry the cement to the concrete plant, 50 km to carry the precast concrete beams to the construction place, and 100 km to carry the steel to the construction place. Figure 3 shows the three alternatives considered. Due to the total length and service life being a bit different among the three alternatives, the functional unit considered is meter length  $\times$  year [30,59].

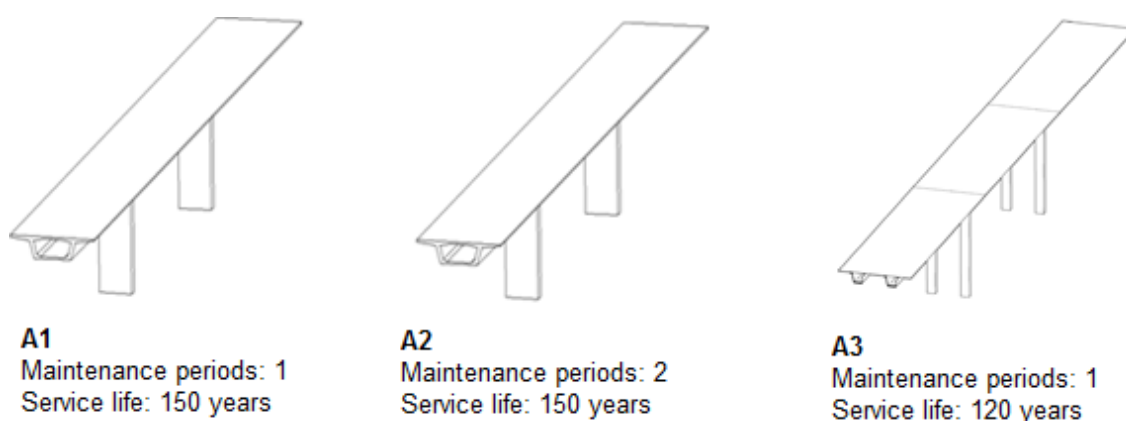

Figure 3. Alternatives.

#### 4.1.2. System Boundaries

The present study considers a “cradle-to-grave” approach, including every relevant manufacturing process related to both the construction and the maintenance activities of each alternative. Given that this assessment is intended for comparative purposes, processes assumed to be identical between alternatives are excluded from the evaluation, following the cut-off criterion established in ISO 14044. This approach has been widely considered in recent comparative life cycle assessments [10,60].

The environmental pillar of the two box-section post-tensioned concrete road bridges have already been assessed by Penadés-Plà et al. [55], and the pre-stressed concrete precast bridge was evaluated by Penadés-Plà et al. [56]. These previous works show the flowchart of the different processes considered in this study. In this work, the social pillar is also considered to obtain a complete life cycle assessment.

#### 4.2. Inventory Analysis

Table 3 shows the quantity of material per 1 m<sup>2</sup> of bridge and the dosage required to manufacture 1 m<sup>3</sup> of concrete according to the concrete strength level. The concrete manufacturing residues are as indicated by Marceau et al. [61]. Reinforced steel is achieved as a mix of the different methods of steel production in accordance with the place of the study. In Spain, the electric arc furnace process manufactures about 67% of steel, while the basic oxygen furnace process manufactures the other 33% of steel. Taking the same steel recycled ratio for each process as inecoinvent (100% in the electric arc furnace process and 19% in the basic oxygen furnace process), the steel recycled ratio obtained is 71%. These amounts of materials have been obtained from the design of the bridges which follow the Spanish codes for this structure type [62,63], as also the Eurocodes [64,65]. The serviceability and ultimate limit states of compression and tension stress, punching shear, vertical shear, longitudinal shear, torsion, torsion combined with bending and shear, bending, vibration, and cracking have been checked. Furthermore, the geometrical and constructability requirements have been verified.

The construction is organized in this manner: the concrete box girder road bridges prestressed with post-tensioning tendons and the slab of the pre-stressed concrete precast bridge is supposed to be cast in place. Afterward, the beams of the pre-stressed concrete precast bridge are transported to the

construction site with special transport and lifted and positioned using tower cranes. Furthermore, the heavy machinery taken into consideration in this section were classified into two categories: the concrete machinery and post-tensioned steel handlings. The quantity of CO<sub>2</sub> emissions and energy for each category was taken from the BEDEC database [66]. In addition, the concrete needs to be handled by heavy equipment that generates 32.24 kg of CO<sub>2</sub> and requires 123.42 MJ of energy per m<sup>3</sup> of concrete produced. Additionally, the machinery for the production of active reinforcement emits 2.62 kg of CO<sub>2</sub> and consumes 10.2 MJ of energy for each kg of active steel. Finally, the formwork taken into account in this study is made of wood and reusable thrice.

**Table 3.** Amount of materials.

	A1	A2	A3	
			Precast Concrete Beam	Concrete Slab
Strength (MPa)	50	35	35	40
Passive steel (kg/m <sup>2</sup> )	74.67	66.89	12.52	23.92
Active steel (kg/m <sup>2</sup> )	19.8	21.98	10.53	–
Concrete (m <sup>3</sup> /m <sup>2</sup> )	0.67	0.674	0.1117	0.1797
Cement (kg/m <sup>3</sup> )	400	300	300	320
Gravel (kg/m <sup>3</sup> )	726	848	848	829
Sand (kg/m <sup>3</sup> )	1136	1088	1088	1102
Water (kg/m <sup>3</sup> )	160	160	160	162
Superplasticizer (kg/m <sup>3</sup> )	7	4	4	5

For each rehabilitation period, maintenance interventions and infrastructure closures are the same. Hence, the different strategies differ in the number of maintenance periods necessary. Each period of rehabilitation, whose duration is 7 days, involves the removal of the deteriorated concrete surface and its substitution with repair mortar. Furthermore, the traffic detour was quantified considering the percentage of trucks (12%) of the average daily traffic, equal to 8500 vehicles/day, and computing a detour distance of 2.9 km. The process of concrete rehabilitation consists of several phases. First, the deteriorated concrete cover is removed through water blasting. Secondly, by applying an adhesion coating, an appropriate surface for the correct adherence of the new concrete cover is obtained. To conclude, the concrete cover is built by casting the repair mortar. The aforementioned activities are performed by employing a truck-mounted platform [67]. As explained above, the estimation of energy and CO<sub>2</sub> emissions associated with the use of the machinery was acquired from the BEDEC database [66] and amounts to 584.28 MJ and 46.58 CO<sub>2</sub> for each m<sup>2</sup> repaired per maintenance period. Lastly, fixed CO<sub>2</sub> during the entire service life is taken into consideration [68].

The end of life includes the equipment used for the demolition of the bridge and the management of the materials. In this work, the ratio of recycled steel considered is 71% and all the concrete is crushed and disposed of in a landfill. The crushed concrete is supposed to be completely carbonated, and the ratio of recycled steel considered in the manufacturing phase corresponds to that of the end of life phase. Thus, the life cycle of the bridge is closed.

#### 4.3. Impact Assessment

Environmental and social dimensions of sustainability are considered to carry out a complete life cycle assessment: the environmental dimension was evaluated using the ReCiPe method and the ecoinvent database, and the social dimension is assessed by means of the Social Impact Weighting Method and the SOCA database. Due to the large number of indicators in the environmental and social dimensions, this study aims to obtain a smaller number of indicators so that results are understandable and complete for these dimensions. For this purpose, the environmental assessment is made according to the endpoint areas of protection of the endpoint approach of the ReCiPe method, and stakeholders made the social assessment.

The endpoint areas of protection obtained by the endpoint approach of the ReCiPe method that represent the environmental dimension are the ecosystems (E), resources (R), and human health (HH). In addition, the four obtained by the SOCA method that represent the social dimension are workers (W), local communities (LC), society (S), and value chain actors (VCA). Such stakeholders are in accordance with those suggested in the Guidelines [37] and are considered representative of the social context of the Spanish region where the structures under analysis are located.

The weighting step of the impact assessment is considered essential when it comes to the holistic evaluation of the sustainability performance of products. However, subjective weighting may lead to jeopardized solutions that might result in inappropriate solutions [69]. This is particularly relevant when it comes to decision making in the field of sustainability, where the complex relations between criteria are usually in conflict. Consequently, great efforts have been applied in recent times to study the influence of such subjectivity in decision-making processes related to sustainable designs in the field of construction [70–72]. As stated above, the scope of the present work is to draw objective conclusions regarding the environmental and social perspectives of infrastructure design. As a consequence, and given that this study is not intended to provide a decision, but to assess the relations existing between the abovementioned dimensions, the different indicators have been considered equally important. Such an approach has been proved to be consistent when assessing the social impacts related to the design of concrete bridge decks [8]. In this way, the subjective assignment of weights is avoided.

## 5. Results and Discussion

Tables 4–6 show the environmental and social impacts on sustainability for the alternatives A1, A2, and A3, respectively. These tables show the environmental and social impact for each life cycle stage. Here, impacts have been grouped into four stages: impacts related to the manufacturing of the materials required for the construction of the alternatives, including every extraction activity of raw materials and production of the final construction materials, as well as the transport activities from the production facilities to the installation site. Impact results included under the “construction” category consider those related to the machinery involved in construction activities and in the production of auxiliary elements, such as formwork panels. The impacts related to the production of construction materials, as well as to the energy consumption and transport associated with construction activities related to maintenance have been summarized as “use and maintenance”. Finally, the results under “EoL” include the impacts associated with the recycling of materials.

**Table 4.** Sustainability assessment of A1.

Assessment	Unit	Manufacturing	Construction	Use and Maintenance	EoL	Total
Environmental	HH p	1.33	0.30	0.42	−0.20	1.86
	R p	1.05	0.10	0.36	0.02	1.53
	E p	0.69	0.26	0.18	−0.13	1.01
<b>Total</b>						<b>4.40</b>
Social	W mrh	227.17	20.27	57.87	2.25	307.56
	LC mrh	273.58	22.03	71.49	2.54	369.65
	S mrh	320.67	25.05	79.56	2.98	428.26
	VCA mrh	199.67	14.09	56.44	1.90	272.11
<b>Total</b>						<b>1377.58</b>

Note: p—points, mrh—med risk hour, E—ecosystems, R—resources, HH—human health, W—workers, LC—local communities, S—society, VCA—value chain actors, EoL—impacts associated with the recycling of materials.

**Table 5.** Sustainability assessment of A2.

Assessment	Unit	Manufacturing	Construction	Use and Maintenance	EoL	Total
Environmental	HH p	1.13	0.32	0.86	−0.15	2.16
	R p	0.93	0.11	0.72	0.01	1.77
	E p	0.57	0.28	0.31	−0.10	1.06
<b>Total</b>						4.98
Social	W mrh	197.63	20.68	115.75	2.26	336.31
	LC mrh	238.77	22.36	142.98	2.55	406.67
	S mrh	285.49	25.42	159.12	3.00	473.02
	VCA mrh	174.01	14.34	112.87	1.91	303.14
<b>Total</b>						1519.14

Note: p—points, mrh—med risk hour, E—ecosystems, R—resources, HH—human health, W—workers, LC—local communities, S—society, VCA—value chain actors, EoL—impacts associated with the recycling of materials.

**Table 6.** Sustainability assessment of A3.

Assessment	Unit	Manufacturing	Construction	Use and Maintenance	EoL	Total
Environmental	HH p	0.74	0.08	0.56	0.00	1.38
	R p	0.64	0.05	0.46	0.03	1.17
	E p	0.36	0.04	0.23	−0.01	0.63
<b>Total</b>						3.19
Social	W mrh	124.88	4.02	82.27	2.81	213.97
	LC mrh	151.20	5.08	101.62	3.44	261.34
	S mrh	182.92	5.93	113.08	4.05	305.98
	VCA mrh	109.66	4.11	80.22	2.73	196.72
<b>Total</b>						978.02

Note: p—points, mrh—med risk hour, E—ecosystems, R—resources, HH—human health, W—workers, LC—local communities, S—society, VCA—value chain actors, EoL—impacts associated with the recycling of materials.

In general, the manufacturing phase is the life cycle stage with the highest impact in every alternative. A3 has the lowest impact for all the indicators. However, A1 has a lower impact in the use and maintenance and end-of-life phases. This is because A1 requires one maintenance period for 150 years of service life, while A2 requires two maintenance periods for the same service life and A3 requires one maintenance period for 120 years of service life. Therefore, A1 has the lowest ratio between maintenance days and service life. Similar trends were recently observed by Tait and Cheung [73] and García-Segura et al. [71], who concluded that, in general, sustainable solutions based on the use of conventional construction materials should focus on reducing the maintenance needs of the designs, given the relevance of this stage in aggressive environments. It is interesting to note that the greater the surface of the deck exposed to chlorides, the greater the impact related to each maintenance activity from both the environmental and the social perspectives.

Figure 4 compares the social and environmental impacts of the three alternatives for each life cycle stage. For this purpose, the upper vertical axis represents the social impact, and the lower vertical axis represents the environmental impact. It is observed that, in general, the negative social impacts considered here are proportional to the environmental impacts associated with each alternative and, consequently, there is a symmetry between these two dimensions of sustainability. However, this observation shall be considered carefully, as it is highly dependent on the social context associated with each alternative analyzed [74]. The observed proportionality is due to the fact that the three alternatives under study are assumed to affect the same social system.

A3 has the lowest global social and environmental impacts and the lowest social and environmental impacts in the manufacturing and construction stages. However, A1 has the lowest social and environmental impacts in the use and maintenance and end-of-life phase. The manufacturing stage has the highest contribution to both impacts. It is observed that, but for the alternative A1, the impacts related to maintenance take a significant proportion of the total life cycle impacts both from a social as well as from an environmental perspective. Such results are in good accordance with other studies on

the life cycle impacts of bridges. Navarro et al. [75] observed that, in chloride-laden environments, environmental impacts related to maintenance can even double the impacts related to construction in very aggressive exposures.

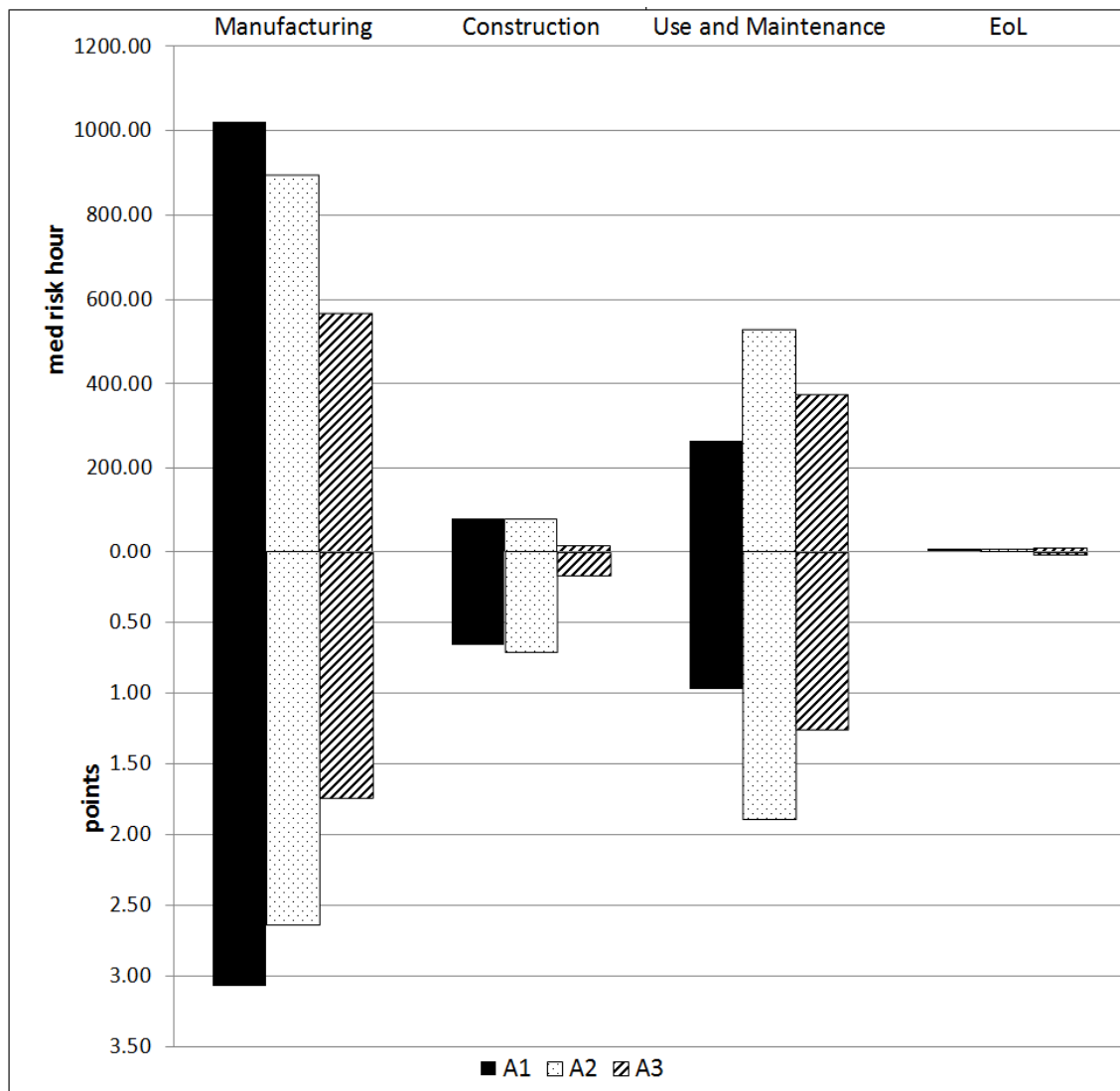

**Figure 4.** Total social and environmental impact.

In addition, more detailed information can be obtained for each social indicator. Thirteen social indicators have been selected according to a hot spot analysis carried out to identify the relevant social concerns for the specific location of the case study analyzed [76]: association and bargaining rights (ACB), non-fatal accidents (NFA), fatal accidents (FA), gender wage gap (GW), violations of employment laws and regulations (VL), safety measures (SM), frequency of forced labor (FL), trade unionism (TU), fair salary (FS), workers affected by natural disasters (ND), weekly hours of work per employee (WH), social security expenditures (SS) and international migrant workers (IMW). Table 7 shows the influence of the main materials used along the whole bridge life cycle for the selected social indicators. Both concrete and steel manufacturing are the processes with the biggest impacts. This table shows that steel production is the bridge process with the main social impact, followed by concrete production. However, there are two indicators for which diesel consumption has the highest contribution: FA and IMW. Figures 5 and 6 show the contribution of steel production, concrete production, and diesel consumption in these indicators. These figures show that the contribution of

diesel consumption in A1 is relatively weak when compared with A2 and A3 because the importance of the materials is higher for A1. In A2 and A3, around half of the impact is due to diesel consumption.

**Table 7.** Contribution of material in the social impact.

	A1		A2		A3	
	Steel	Concrete	Steel	Concrete	Steel	Concrete
FL	57.93%	24.11%	53.04%	17.82%	54.82%	16.46%
FS	55.63%	29.60%	53.14%	22.73%	55.42%	21.10%
WH	49.90%	27.02%	43.92%	19.26%	45.12%	17.74%
GW	41.82%	42.58%	42.18%	34.56%	48.36%	34.60%
NFA	31.87%	49.36%	30.03%	37.22%	31.67%	34.12%
FA	35.70%	28.26%	28.27%	18.23%	28.64%	16.59%
SM	24.51%	49.95%	23.15%	36.30%	26.02%	36.09%
ND	51.76%	28.34%	46.35%	20.56%	47.38%	18.65%
SS	50.01%	27.31%	44.01%	19.49%	45.21%	17.88%
VL	53.19%	29.07%	49.35%	21.92%	51.51%	20.32%
ACB	58.06%	29.96%	57.53%	23.94%	62.05%	22.52%
TU	48.20%	29.57%	42.91%	21.32%	44.28%	19.64%
IMW	37.90%	22.07%	28.26%	13.29%	27.11%	11.98%

Note: FL—frequency of forced labor, FS—fair salary, WH—weekly hours of work per employee, GW—gender wage gap, NFA—non-fatal accidents, FA—fatal accidents, SM—safety measures, ND—workers affected by natural disasters, SS—social security expenditures, VL—violations of employment laws and regulations, ACB—association and bargaining rights, TU—trade unionism, IMW—international migrant workers.

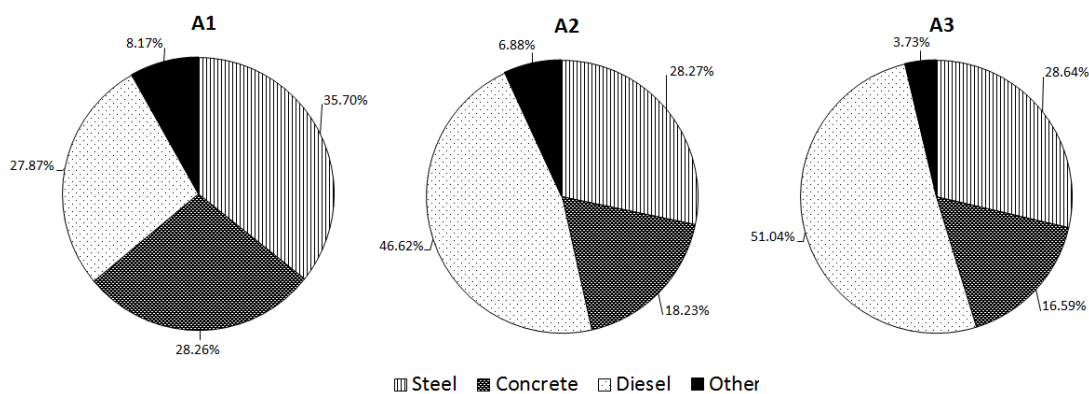

**Figure 5.** Contribution of processes to FA social impact.

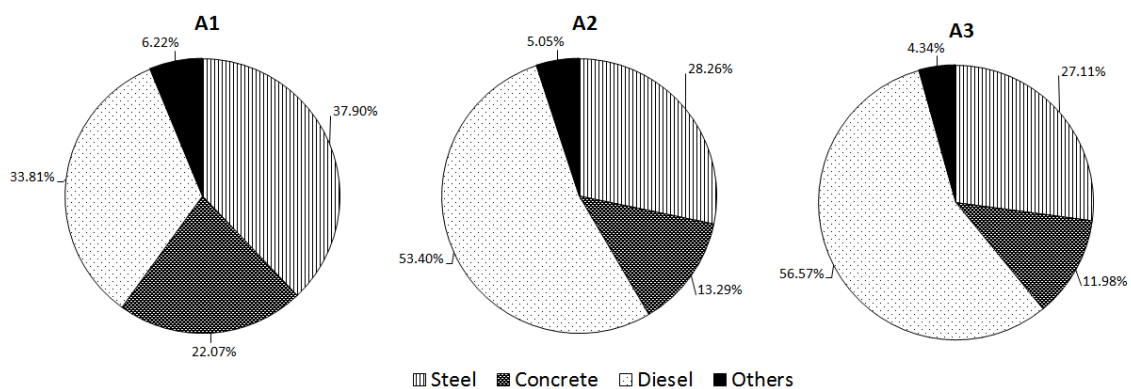

**Figure 6.** Contribution of processes to IMW social impact.

## 6. Conclusions

This work carried out a complete life cycle assessment of three bridges: two box-section post-tensioned concrete road bridges, with different initial and maintenance characteristics,

and a pre-stressed concrete precast bridge. For this purpose, the environmental and social pillars were evaluated following the LCA methodology. After reviewing and discussing the different LCIA that best represent these pillars, a full sustainability assessment was performed using existing LCIA methods. The ReCiPe method and ecoinvent database were used to carry out the environmental assessment, and the Social Impact Weighting Method and the PSILCA database with the SOCA add-on were used to carry out the social assessment.

The comparison between the three bridges shows that the most sustainable bridge is the pre-stressed concrete precast bridge. This bridge has the lowest impact for all environmental and social indicators. In addition, when the different phases of the bridge life cycle are compared, results show that the manufacturing stage has the highest environmental and social impact. In this phase, concrete production is the process with the highest environmental impact, and steel production is the process with the highest social impact. Focusing on the social assessment, the processes of concrete and steel production have a higher contribution to the social impact. However, other indicators such as the FA and INW are more affected by diesel consumption.

This work aims to propose a complete methodology to evaluate the environmental and social sustainability of bridges using a small number of indicators. This methodology can be applied to other case studies. However, this study has potential limitations. One limitation is that results cannot be compared with other works as they use different methodologies. The wide variety of methods means that the contrast of the environmental and social assessment can only be done with works that use the same methodology, and this leads to a global loss of information about the sustainability assessment. For this reason, future research may unify the methodology to carry out environmental and social assessments. Thus, engineers would have a standard methodology to choose the most sustainable structure among different alternatives.

**Author Contributions:** This paper represents a result of teamwork. The authors jointly designed the research. V.P.-P. drafted the manuscript. D.M.-M., T.G.-S., I.J.N., and V.Y. edited and improved the manuscript until all authors were satisfied with the final version. All authors have read and agreed to the published version of the manuscript.

**Funding:** This research was funded by the Ministerio de Economía, Ciencia y Competitividad and FEDER funding grant number [BIA2017-85098-R].

**Conflicts of Interest:** The authors declare no conflict of interest.

## References

1. United Nations. *World Commission on Environment and Development Our Common Future*; Oxford University Press: New York, NY, USA, 1987.
2. United Nations. *Transforming our world: The 2030 agenda for sustainable development*; General Assembly: New York, NY, USA, 2015.
3. Murphy, K. The social pillar of sustainable development: A literature review and framework for policy analysis. *Sustain. Sci. Pract. Policy* **2012**, *8*, 15–29. [[CrossRef](#)]
4. Montalbán-Domingo, L.; García-Segura, T.; Sanz, M.A.; Pellicer, E. Social sustainability criteria in public-work procurement: An international perspective. *J. Clean. Prod.* **2018**, *198*, 1355–1371. [[CrossRef](#)]
5. Vallance, S.; Perkins, H.C.; Dixon, J.E. What is social sustainability? A clarification of concepts. *Geoforum* **2011**, *42*, 342–348. [[CrossRef](#)]
6. Harris, J.M.; Wise, T.A.; Gallagher, K.P.; Goodwine, N.R. *A Survey of Sustainable Development: Social and Economic Dimension*; Island Press: Washington, DC, USA, 2001.
7. Sierra, L.A.; Yepes, V.; Pellicer, E. Assessing the social sustainability contribution of an infrastructure project under conditions of uncertainty. *Environ. Impact Assess. Rev.* **2017**, *67*, 61–72. [[CrossRef](#)]
8. Navarro, I.J.; Yepes, V.; Martí, J.V. Social life cycle assessment of concrete bridge decks exposed to aggressive environments. *Environ. Impact Assess. Rev.* **2018**, *72*, 50–63. [[CrossRef](#)]
9. Navarro, I.J.; Martí, J.V.; Yepes, V. Reliability-based maintenance optimization of corrosion preventive designs under a life cycle perspective. *Environ. Impact Assess. Rev.* **2019**, *74*, 23–34. [[CrossRef](#)]

10. Navarro, I.J.; Yepes, V.; Martí, J.V. Sustainability assessment of concrete bridge deck designs in coastal environments using neutrosophic criteria weights. *Struct. Infrastruct. Eng.* **2019**, 1–19. [[CrossRef](#)]
11. Montalbán-Domingo, L.; García-Segura, T.; Amalia Sanz, M.; Pellicer, E. Social Sustainability in Delivery and Procurement of Public Construction Contracts. *J. Manag. Eng.* **2019**, 35, 1–11. [[CrossRef](#)]
12. Valdes-Vasquez, R.; Klotz, L.E. Social sustainability considerations during planning and design: Framework of processes for construction projects. *J. Constr. Eng. Manag.* **2013**, 139, 80–89. [[CrossRef](#)]
13. Almahmoud, E.; Doloi, H.K. Assessment of social sustainability in construction projects using social network analysis. *Facilities* **2015**, 30, 152–176. [[CrossRef](#)]
14. Sánchez-Garrido, A.J.; Yepes, V. Multi-criteria assessment of alternative sustainable structures for a self-promoted, single-family home. *J. Clean. Prod.* **2020**, 258, 120556. [[CrossRef](#)]
15. Navarro, I.; Yepes, V.; Martí, J. Life cycle cost assessment of preventive strategies applied to prestressed concrete bridges exposed to chlorides. *Sustainability* **2018**, 10, 845. [[CrossRef](#)]
16. Salas, J.; Yepes, V. VisualUVAM: A decision support system addressing the curse of dimensionality for the multi-scale assessment of urban vulnerability in Spain. *Sustainability* **2019**, 11, 2191. [[CrossRef](#)]
17. Kripka, M.; Yepes, V.; Milani, C.J. Selection of sustainable short-span bridge design in Brazil. *Sustainability* **2019**, 11, 1307. [[CrossRef](#)]
18. Penadés-Plà, V.; Yepes, V.; García-Segura, T. Robust decision-making design for sustainable pedestrian concrete bridges. *Eng. Struct.* **2020**, 209, 109968. [[CrossRef](#)]
19. Rasheed, A.; Farooq, S.H.; Usman, M.; Hanif, A.; Khan, N.A.; Khushnood, R.A. Structural reliability analysis of superstructure of highway bridges on China-Pakistan Economic Corridor (CPEC): A case study. *J. Struct. Integr. Maint.* **2018**, 3, 197–207. [[CrossRef](#)]
20. Hansen, M. Determination and assessment of fatigue stresses on concrete bridges. *Struct. Concr.* **2020**, 1–12. [[CrossRef](#)]
21. Sargsyan, A.; Sargsyan, G.; Resnik, B. Influence of Cracks on Frequency of the Self-Vibration of Reinforced Concrete T Beam of Road Bridges | Scientific.Net. *Key Eng. Mater.* **2019**, 828, 9–13. [[CrossRef](#)]
22. Penadés-Plà, V.; García-Segura, T.; Martí, J.; Yepes, V. A review of multi-criteria decision-making methods applied to the sustainable bridge design. *Sustainability* **2016**, 8, 1295. [[CrossRef](#)]
23. Horvath, A.; Hendrickson, C. Steel versus steel-reinforced concrete bridges: Environmental assessment. *J. Infrastruct. Syst.* **1998**, 4, 111–117. [[CrossRef](#)]
24. Widman, J. Environmental impact assessment of steel bridges. *J. Constr. Steel Res.* **1998**, 46, 291–293. [[CrossRef](#)]
25. Stengel, T.; Schiessl, P. Life cycle assessment of UHPC bridge constructions: Sherbrooke Footbridge, Kassel Gärtnerplatz Footbridge and Wapello Road Bridge. *Archit. Civ. Eng. Environ.* **2009**, 1, 109–118.
26. Gervasio, H.; Simoes da Silva, L. Comparative life-cycle analysis of steel-concrete composite bridges. *Struct. Infrastruct. Eng.* **2008**, 4, 251–269. [[CrossRef](#)]
27. Itoh, Y.; Kitagawa, T. Using CO<sub>2</sub> emission quantities in bridge lifecycle analysis. *Eng. Struct.* **2003**, 25, 565–577. [[CrossRef](#)]
28. Bouhaya, L.; Roy, R.L.; Feraille-Fresnet, A. Simplified environmental study on innovative bridge structure. *Environ. Sci. Technol.* **2009**, 43, 2066–2071. [[CrossRef](#)] [[PubMed](#)]
29. Steele, K.N.P.; Cole, G.; Parke, G. Application of life cycle assessment technique in the investigation of brick arch highway bridges. In Proceedings of the 6th International Masonry Conference, London, UK, 9 November 2002; pp. 1–8.
30. Pang, B.; Yang, P.; Wang, Y.; Kendall, A.; Xie, H.; Zhang, Y. Life cycle environmental impact assessment of a bridge with different strengthening schemes. *Int. J. Life Cycle Assess.* **2015**, 20, 1300–1311. [[CrossRef](#)]
31. Du, G.; Safi, M.; Pettersson, L.; Karoumi, R. Life cycle assessment as a decision support tool for bridge procurement: Environmental impact comparison among five bridge designs. *Int. J. Life Cycle Assess.* **2014**, 19, 1948–1964. [[CrossRef](#)]
32. Hammervold, J.; Reenaas, M.; Brattebø, H. Environmental life cycle assessment of bridges. *J. Bridg. Eng.* **2013**, 18, 153–161. [[CrossRef](#)]
33. Gervasio, H.; Simões Da Silva, L. A probabilistic decision-making approach for the sustainable assessment of infrastructures. *Expert Syst. Appl.* **2012**, 39, 7121–7131. [[CrossRef](#)]
34. Sabatino, S.; Frangopol, D.M.; Dong, Y. Sustainability-informed maintenance optimization of highway bridges considering multi-attribute utility and risk attitude. *Eng. Struct.* **2015**, 102, 310–321. [[CrossRef](#)]



35. Chen, Z.; Abdullah, A.B.; Anumba, C.J.; Li, H. ANP experiment for demolition plan evaluation. *J. Constr. Eng. Manag.* **2013**, *140*, 51–60. [[CrossRef](#)]
36. International Organization for Standardization (ISO). *International Organization for Standardization (ISO) Environmental Management—Life Cycle Assessment—Principles and Framework*; International Organization for Standardization: Geneva, Switzerland, 2006.
37. Benoît, C.; Mazijn, B. *Guidelines for Social Life Cycle Assessment of Products*; UNEP/SETAC Life Cycle Initiative, Sustainable Product and Consumption Branch: Paris, France, 2009; Volume 15, ISBN 9789280730210.
38. Guinée, J.B.; Gorrié, M.; Heijungs, R.; Huppes, G.; Kleijn, R.; Wegener Sleeswijk, A.; Udo De Haes, H.A.; de Bruijn, J.A.; van Duin, R.; Huijbregts, M.A.J. Life cycle assessment: An operational guide to the ISO standards. *III Sci. Backgr.* **2001**, 692. [[CrossRef](#)]
39. Hauschild, M.; Potting, J. Background for spatial differentiation in LCA impact assessment—The EDIP2003 methodology. *Environ. News* **2005**, *80*, 1–195.
40. Bare, J.C. The Tool for the Reduction and Assessment of Chemical and Other Environmental Impacts. *J. Ind. Ecol.* **2002**, *6*, 49–78. [[CrossRef](#)]
41. Goedkoop, M.; Hofstetter, P.; Müller-Wenk, R.; Spriemsma, R. The Eco-Indicator 98 explained. *Int. J. Life Cycle Assess.* **1998**, *3*, 352–360. [[CrossRef](#)]
42. Steen, B. *A Systematic Approach to Environmental Priority Strategies in Product Development (EPS)*; Centre for Environmental Assessment of Products and Material System: Gothenburg, Sweden, 1999.
43. Frischknecht, R.; Steiner, R.; Jungbluth, N. *Methode der ökologischen Knappheit—Ökofaktoren 2006*. 2009.
44. Goedkoop, M.; Heijungs, R.; Huijbregts, M.; De Schryver, A.; Struijs, J.; Van Zelm, R. *ReCiPe 2008 A Life Cycle Impact Assessment Method which Comprises Harmonised Category Indicators at the Midpoint and the Endpoint Level*; Ministerie van VROM: Hague, The Netherlands, 2009.
45. Huijbregts, M.A.J.; Steinmann, Z.J.N.; Elshout, P.M.F.; Stam, G.; Verones, F.; Vieira, M.D.M.; Hollander, A.; Zijp, M.; Zelm, R. *ReCiPe 2016 A Harmonized Life Cycle Impact Assessment Method at Midpoint and Endpoint Level Report I: Characterization*; Rijksinstituut voor Volksgezondheid en Milieu RIVM: De Bilt, The Netherlands, 2016.
46. Itsubo, N.; Sakagami, M.; Washida, T.; Kokubu, K.; Inaba, A. Weighting across safeguard subjects for LCIA through the application of conjoint analysis. *Int. J. Life Cycle Assess.* **2004**, *9*, 196–205. [[CrossRef](#)]
47. Jolliet, O.; Margni, M.; Charles, R.; Humbert, S.; Payet, J.; Rebitzer, G.; Rosenbaum, R. IMPACT 2002+: A new Life Cycle Impact Assessment Methodology. *Int. J. Life Cycle Assess.* **2003**, *8*, 324–330. [[CrossRef](#)]
48. *GreenDelta PSILCA v1.0 (Product Social Impact Life-Cycle Assessment)*; Greendelta: Berlin, Germany, 2013.
49. New Earth SHDB v1.0 (Social Hotspot Database). 2009. Available online: <https://www.socialhotspot.org/> (accessed on 1 October 2019).
50. GreenDelta PSILCA Database. Available online: <https://psilca.net/> (accessed on 1 October 2019).
51. New Earth SHDB Database. Available online: <https://www.socialhotspot.org/for-more-information.html> (accessed on 1 October 2019).
52. Du, G.; Karoumi, R. Environmental life cycle assessment comparison between two bridge types: Reinforced concrete bridge and steel composite bridge. In Proceedings of the 3rd International Conference on Sustainable Construction Materials and Technologies, Kyoto, Japan, 18–21 August 2013.
53. Hettinger, A.; Birat, J.; Hechler, O.; Braun, M. Sustainable bridge—LCA for a composite and a concrete bridge. In *Economical Bridge Solutions Based on Innovative Composite Dowels and Integrated Abutments*; Petzek, E., Bancila, R., Eds.; Springer Vieweg: Wiesbaden, Germany, 2015; pp. 45–54.
54. Du, G.; Karoumi, R. Life cycle assessment of a railway bridge: Comparison of two superstructure designs. *Struct. Infrastruct. Eng.* **2012**, *9*, 1149–1160. [[CrossRef](#)]
55. Penadés-Plà, V.; Martí, J.V.; García-Segura, T.; Yepes, V. Life-cycle assessment: A comparison between two optimal post-tensioned concrete box-girder road bridges. *Sustainability* **2017**, *9*, 1864. [[CrossRef](#)]
56. Penadés-Plà, V.; García-Segura, T.; Martí, J.V.; Yepes, V. An optimization-LCA of a prestressed concrete precast bridge. *Sustainability* **2018**, *10*, 685. [[CrossRef](#)]
57. Pons, J.J.; Penadés-Plà, V.; Yepes, V.; Martí, J.V. Life cycle assessment of earth-retaining walls: An environmental comparison. *J. Clean. Prod.* **2018**, *192*, 411–420. [[CrossRef](#)]
58. European Committee for Standardization. *EN 206-1 Concrete—Part 1: Specification, Performance, Production and Conformity*; European Committee for Standardization: Brussels, Belgium, 2000.
59. Steele, K.; Cole, G.; Parke, G.; Clarke, B.; Harding, J.; Harding, J. Highway bridges and environment-sustainable perspectives. *Proc. Inst. Civ. Eng.* **2003**, *156*, 176–182. [[CrossRef](#)]

60. Martínez-Blanco, J.; Lehmann, A.; Muñoz, P.; Antón, A.; Traverso, M.; Rieradevall, J.; Finkbeiner, M. Application challenges for the social Life Cycle Assessment of fertilizers within life cycle sustainability assessment. *J. Clean. Prod.* **2014**, *69*, 34–48. [[CrossRef](#)]
61. Marceau, M.L.; Nisbet, M.A.; Vangeem, M.G. *Life Cycle Inventory of Portland Cement Concrete*; Portland Cement Association: Skokie, IL, USA, 2007.
62. Ministerio de Fomento. *EHE-08: Code on Structural Concrete*; Ministerio de Fomento: Madrid, Spain, 2008.
63. Ministerio de Fomento. *IAP-11: Code on the Actions for the Design of Road Bridges*; Ministerio de Fomento: Madrid, Spain, 2011.
64. European Committee for Standardization. *EN 1001-2:2003. Eurocode 1: Actions on Structures—Part 2: Traffic Loads Bridges*; European Committee for Standardization: Brussels, Belgium, 2003.
65. European Committee for Standardisation. *EN1992-2:2005. Eurocode 2: Design of Concrete Structures—Part 2: Concrete Bridge-Design and Detailing Rules*; European Committee for Standardization: Brussels, Belgium, 2005.
66. Catalonia Institute of Construction Technology. BEDEC PR/PCT ITEC Material Database. 2016. Available online: <https://metabase.itec.cat/vidoe/ca/bedec> (accessed on 1 October 2019).
67. García-Segura, T.; Yepes, V.; Frangopol, D.M.; Yang, D.Y. Lifetime reliability-based optimization of post-tensioned box-girder bridges. *Eng. Struct.* **2017**, *145*, 381–391. [[CrossRef](#)]
68. García-Segura, T.; Yepes, V.; Alcalá, J. Life cycle greenhouse gas emissions of blended cement concrete including carbonation and durability. *Int. J. Life Cycle Assess.* **2014**, *19*, 3–12. [[CrossRef](#)]
69. Radwan, N.M.; Senousy, M.B.; El, A.; Riad, D.M. Neutrosophic AHP multi criteria decision making method applied on the selection of learning management system. *Int. J. Adv. Comput. Technol.* **2016**, *8*, 95–105.
70. Prasevic, N.; Prasevic, Z. Application of fuzzy AHP for ranking and selection of alternatives in construction project management. *J. Civ. Eng. Manag.* **2017**, *23*, 1123–1135. [[CrossRef](#)]
71. García-Segura, T.; Penadés-Plà, V.; Yepes, V. Sustainable bridge design by metamodel-assisted multi-objective optimization and decision-making under uncertainty. *J. Clean. Prod.* **2018**, *202*, 904–915. [[CrossRef](#)]
72. Pamučar, D.; Badi, I.; Sanja, K.; Obradović, R. A novel approach for the selection of power-generation technology using a linguistic neutrosophic CODAS method: A case study in Libya. *Energies* **2018**, *11*, 2489. [[CrossRef](#)]
73. Tait, M.W.; Cheung, W.M. A comparative cradle-to-gate life cycle assessment of three concrete mix designs. *Int. J. Life Cycle Assess.* **2016**, *21*, 847–860. [[CrossRef](#)]
74. Sierra, L.A.; Pellicer, E.; Yepes, V. Method for estimating the social sustainability of infrastructure projects. *Environ. Impact Assess. Rev.* **2017**, *65*, 41–53. [[CrossRef](#)]
75. Navarro, I.J.; Yepes, V.; Martí, J.V.; González-Vidosa, F. Life cycle impact assessment of corrosion preventive designs applied to prestressed concrete bridge decks. *J. Clean. Prod.* **2018**, *196*, 698–713. [[CrossRef](#)]
76. Hosseiniyou, S.A.; Mansour, S.; Shirazi, M.A. Social life cycle assessment for material selection: A case study of building materials. *Int. J. Life Cycle Assess.* **2014**, *19*, 620–645. [[CrossRef](#)]

