

Study of geometric effects on the performance of CIGS flexible photovoltaic panels

Martí Segarra Balaguer

Bachelor's thesis in Industrial Engineering

Bergen, Norway 2021

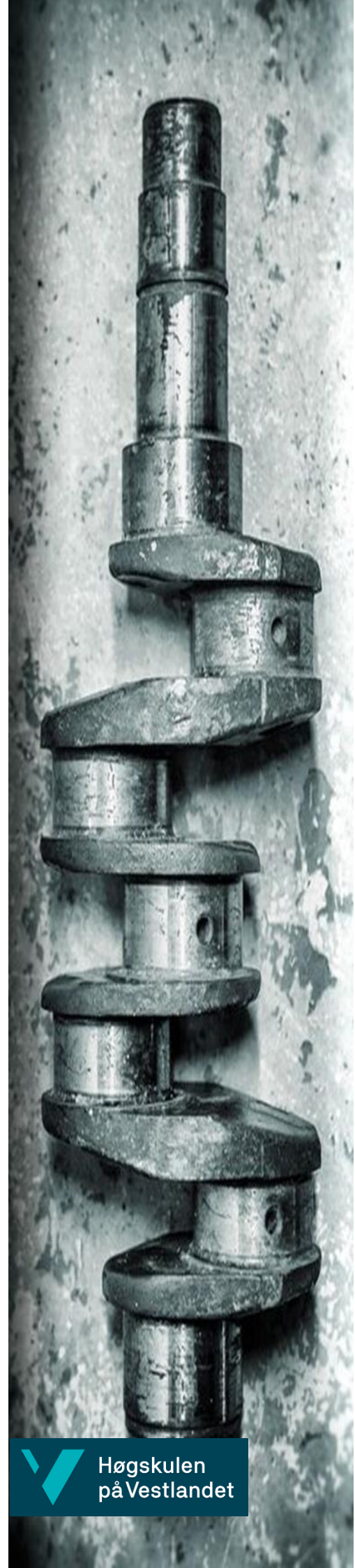

Study of geometric effects on the performance of CIGS flexible photovoltaic panels

Martí Segarra Balaguer

Department of Mechanical- and Marine Engineering

Western Norway University of Applied Sciences

NO-5063 Bergen, Norway

IMM2021-M74

Høgskulen på Vestlandet
Fakultet for Ingeniør- og Naturvitskap
Institutt for maskin- og marinfag
Inndalsveien 28
NO-5063 Bergen, Norge

Cover and backside images © Norbert Lümmer

Norsk tittel: Studie av geometriske effekter på ytelsen til CIGS
fleksible solcellepaneler

Author, student number: Martí Segarra Balaguer, 596310

Study program: MAS151-Bachelor Project – Industrial Engineering

Date: May 2021

Report number: IMM 2021-M74

Supervisor at HVL: Richard J. Grant

Assigned by: HVL

Contact person: Richard J. Grant

Antall filer levert digitalt: One

Preface

This project is part of MAS151- Bachelor Project- Industrial Engineering of the Department of Mechanical and Marine Engineering at Western University of Applied Sciences (WNUAS). It is the final work of my Erasmus program.

The project begins with an idea from Professor Richard John Grant, teacher of the Department of Mechanical and Marine Engineering. The idea is to study the performance of the flexible photovoltaic panels if we change their geometries.

First of all, I want to thank Professor Richard J. Grant my supervisor and guide in the thesis. Thank you for your knowledge, dedication, and interest in the project. Your devotion to teaching and your comprehension make my thesis more pleasant and interesting.

Furthermore, I want to thank Professor Harald Moen for your help in the project. I am grateful for your knowledge and your commitment. I have learned a lot from you. I would also like to thank the technicians of the workshop for your help with my work there.

Finally, I would like to thank Professor Sergio Gallardo Bermell, tutor of my thesis at my home university. Thank you for your patience and understanding.

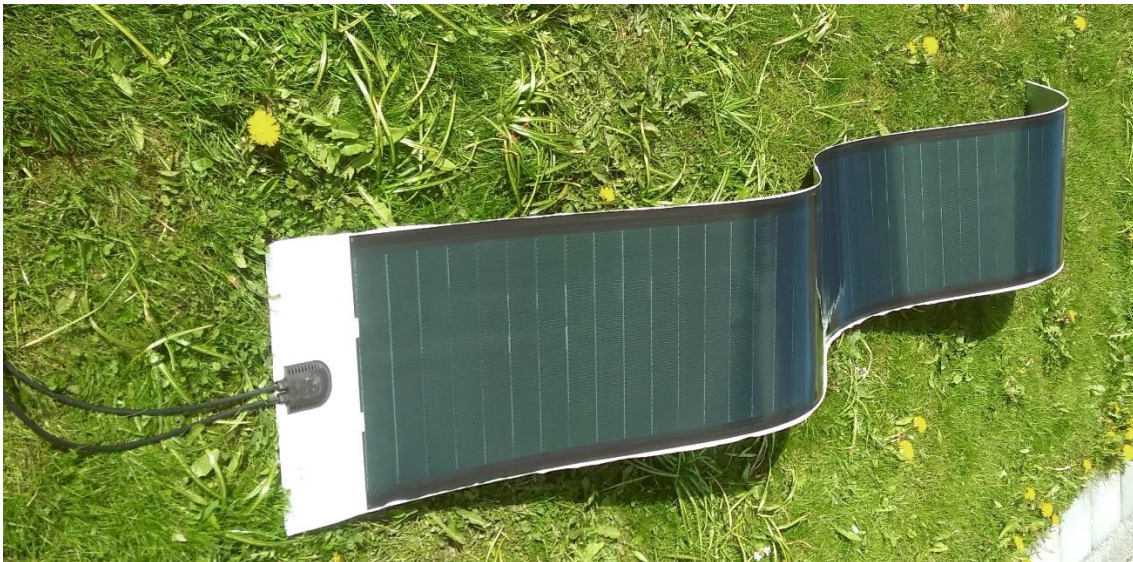

Abstract

In all cities, there are some buildings as public toilets, bus stops, structures of advertisements, where it is interesting to be able to produce electric energy since these buildings are close to the consumers. The use of photovoltaic (PV) panels may be a good option to produce carbon dioxide-free electric energy. Nevertheless, the use of the most common PV panels, the rigid ones, is not possible in some buildings. Some of these buildings have curved or wavy surfaces and rigid PV panels are not able to facet their surfaces. In these cases, the use of flexible PV panels that can be used in a wide range of geometries is a good option.

In order to know the performance of a flexible PV panel in a specific geometry that can be used in a real-world application, it is necessary to have a reference solar test. For this, this thesis performs tests with Cooper Indium Gallium Selenide (CIGS) flexible PV panels in different geometries. Tests consist of comparing the performance of one panel in a semi-circular geometry and another in a flat position. With this, the differences on the performance of the PV panels due to their geometry are studied. In addition, it is possible to know if the use of the panels in the specified geometry is or not profitable.

An adaptable structure has been designed that can allow flexible PV panels to assume a wide range of geometries. This structure can be used to perform future tests to the flexible panels in a lot of different geometries for real-world applications. This adaptable support has not been constructed for this thesis. Instead, two simple supports of wood have been built for testing with the panels.

This thesis concludes that the performance of the flexible PV panels has a significant reduction in the energy produced using a semi-circular geometry panel comparing with the performance of the flat panel, especially on sunny days. Although the performance of the semi-circular panel is better than the flat panel in the first and the last hours of the day.

Sammendrag

I alle byer er det noen bygninger som offentlige toaletter, bussholdeplasser, reklamestrukturer, der det er interessant å kunne produsere elektrisk energi siden disse bygningene er nær forbrukerne. Bruk av solcellepaneler (PV) kan være et godt alternativ for å produsere karbondioksidfri elektrisk energi. Likevel er det ikke mulig å bruke de vanligste solcellepanelene, de stive, i noen bygninger. Noen av disse bygningene har buede eller bølgete overflater, og stive solcellepaneler er ikke i stand til å fasettere overflatene. I disse tilfellene er bruk av fleksible PV-paneler som kan brukes i et bredt spekter av geometrier et godt alternativ.

For å kjenne ytelsen til et fleksibelt PV-panel i en bestemt geometri som kan brukes i en virkelig applikasjon, er det nødvendig å ha en referansetest for solenergi. For dette utfører denne oppgaven tester med Cooper Indium Gallium Selenid (CIGS) fleksible PV-paneler i forskjellige geometrier. Tester består i å sammenligne ytelsen til et panel i en halvsirkelformet geometri og et annet i en flat stilling. Med dette studeres forskjellene på ytelsen til PV-panelene på grunn av geometrien. I tillegg er det mulig å vite om bruken av panelene i den angitte geometrien er eller ikke er lønnsom.

En tilpasningsdyktig struktur er designet som gjør det mulig for fleksible solcellepaneler å anta et bredt spekter av geometrier. Denne strukturen kan brukes til å utføre fremtidige tester på de fleksible panelene i mange forskjellige geometrier for virkelige applikasjoner. Denne tilpasningsdyktige støtten er ikke konstruert for denne oppgaven. I stedet er det bygd to enkle støtter av tre for testing med panelene.

Denne oppgaven konkluderer med at ytelsen til de fleksible solcellepanelene har en betydelig reduksjon i energien som produseres ved hjelp av et halvsirkulært geometrisk panel sammenlignet med ytelsen til flatpanelet, spesielt på solrike dager. Selv om ytelsen til det halvsirkulære panelet er bedre enn flatpanelet de første og siste timene på dagen.

Table of contents

Preface	V
Abstract.....	VII
Sammendrag	IX
Nomenclature.....	XIII
1. Introduction	1
1.1 Background and initial ideas	1
1.2. Aim and objectives	1
2.3. Structure of the report.....	2
2. Theoretical approach	3
2.1. Solar energy and irradiation	3
2.2. Solar cells	4
2.3. Effects of temperature and irradiance on solar cells.....	5
2.4. Connections between cells.....	5
2.5. Mismatches losses	6
2.6. Bypass diodes	7
2.7. PV panel connected to the loads.....	8
2.8. Maximum power point tracker (MPPT)	10
2.9. Cooper, indium, gallium and selenium (CIGS) panels.....	11
2.10. Performance measurements in PV panels	11
3. Analysis of performance of the PV panels	12
3.1. CIGS flexible PV panels	12
3.2. Tests procedure.....	13
3.3. Performance test and devices used	15
4. Design of the adaptable support	18
4.1. Geometries of possible applications	18
4.2. Design and pieces	19
5. Results	24
5.1. Long-term test	24
5.2. Test of both panels connected in series	30
6.Conclusion.....	32

References	33
List of figures	34
Attachment 1	36
Attachment 2	37
Attachment 3	40

Nomenclature

Abbreviations	Explanation
PV	Photovoltaic
CIGS	Cooper Indium Gallium Selenide
G_{dir}	Direct irradiation, W/m^2
G_{dif}	Diffuse irradiation, W/m^2
G_{ref}	Reflected irradiation, W/m^2
G_{gl}	Global irradiation, W/m^2
AM	Air Mass
V_{oc}	Open circuit voltage, V
I_{sc}	Short circuit current, A
MPP	Maximum power point, W
MPPT	Maximum power point tracker
DC	Direct current
STC	Standard Test Conditions
NI	National Instruments
DAQ	Data acquisition

1. Introduction

1.1 Background and initial ideas

One of the ways to fight climate change is to produce carbon dioxide-free electric energy and photovoltaic panels are known to be one of these green ways of producing electricity. Currently, the PV panels most used are mono and poly crystalline photovoltaic panels. These panels are usually mounted on glass and leave the factory as framed units. It is possible to use these PV panels in large buildings with curved geometry, in which the curvatures have large radius. Namely, it is possible to facet large buildings with rigid panels slightly changing the angle between adjoining panels. Whilst, for smaller structures such as curved section public toilet, advertising structure in a town centre, bus stops, or constructions where changes of curvature are more pronounced, it is not possible to follow the silhouette with rigid solar panels. However, these constructions can be a good place to obtain electricity, since it is close to the consumption points, and it is even more interesting if it is green energy. In these situations, the use of flexible PV panels may be the best solution. [1]

It is interesting to understand the real-world performance characteristics when using flexible PV panels, which can be used in many different places and shapes. To show the characteristics, it will be necessary to have a reference test solar cell in various curved geometries. In order to understand the performance of the flexible solar panels, the project will require the construction of a support system. That will allow adaptation of a CIGS PV panel to the desired forms.

The first idea for the project was to design and construct a mounting structure to allow flexible film photovoltaic panels to assume a range of geometries to enable performance testing when are used in various applications. Then, start testing the CIGS PV panels in different geometries, using the support. Nevertheless, for design an adaptable support that can allow us to test the maximum range of geometries, it is necessary to take into account a lot of possibilities in the design and think about the wide range of movements to adapt to the forms and the materials to use. Moreover, to design the support is interesting to know the type of tests to do.

Accordingly, due to the complexity of the design and the interest to know about the test of the panels for making an appropriate design, the final decision is to start making test of the PV panels in a simple support while the design of the final support is done.

1.2. Aim and objectives

This thesis studies the effects of geometry on the performance of the flexible PV panels. The performance of a panel in a specific curved geometry is compared with the performance of a similar panel in a flat form, without any curves.

This project intends to study if the flexible PV panels can have a good performance when used in curved geometries, geometries that can be found in some real-world applications.

At the same time, an adaptable support is designed to allow flexible panels to take on a wide range of real-world application geometries.

To achieve the aim, it is necessary: construct simple supports in the desired forms, make and program electronic devices to measure the performance, and perform the tests. Otherwise, to design the adaptable support the possible applications and geometries have to be studied. Then, the support must be designed with the materials and pieces to be used.

2.3. Structure of the report

This report is divided into different parts according to the development of the project. Firstly, Chapter 2 is an explanation of the theoretical concepts related to the PV panels. These theoretical concepts are necessary to understand the posed problems in the thesis and the taken way to solve them. Then, Chapter 3 explains the methodology used for the performed tests on flexible PV panels. After this, the design of the adaptable support is presented in Chapter 4.

In this thesis a PV panel in a semi-circular geometry is tested, which can be used in some advertising structures or in some public toilets. In Chapter 5, the results are presented and the effects of the semi-circular geometry on the performance of the panels are analysed. Moreover, it is studied if the difference in power production can be acceptable to use these panels in the form of a semi-circular in some applications. Finally, there is a conclusion in Chapter 6.

This thesis concludes with some results about the performance of the CIGS panels in a specific geometry and the design of adaptable support. But it is missing a lot of interesting analysis to do that can be done in future thesis or work. If the support were constructed, much more tests could be done. There are a lot of geometries to test and different tests to do to know the performance of the panels. Testing a panel in one geometry is useful in deciding whether or not placing the panel in this form will be profitable.



Figure 1.1: Flexible PV panels in solar lab, HVL.

2. Theoretical approach

In this chapter, some theoretical aspects related to this thesis are explained. It is not intended to explain all theoretical aspects related to PV panels since it would be very extensive. It only intends to explain the theoretical questions related to the thesis, in order to understand the problems it raises, and the way is taken to solve them.

2.1. Solar energy and irradiation

The Sun is a green energy source, it releases large amounts of energy in form of radiation. Around 1367W/m^2 arrive at the exterior of the earth's atmosphere. Irradiation is attenuated passing through the atmosphere. And the irradiation that arrives on the earth depends on the distance from the atmosphere that has crossed and from the gases it has passed through. Due to these changes produced in the atmosphere, it is possible to classify solar irradiation into three types: direct irradiation (G_{dir}), diffuse irradiation (G_{dif}) and reflected irradiation (G_{ref}). It is illustrated in Figure 2.1.

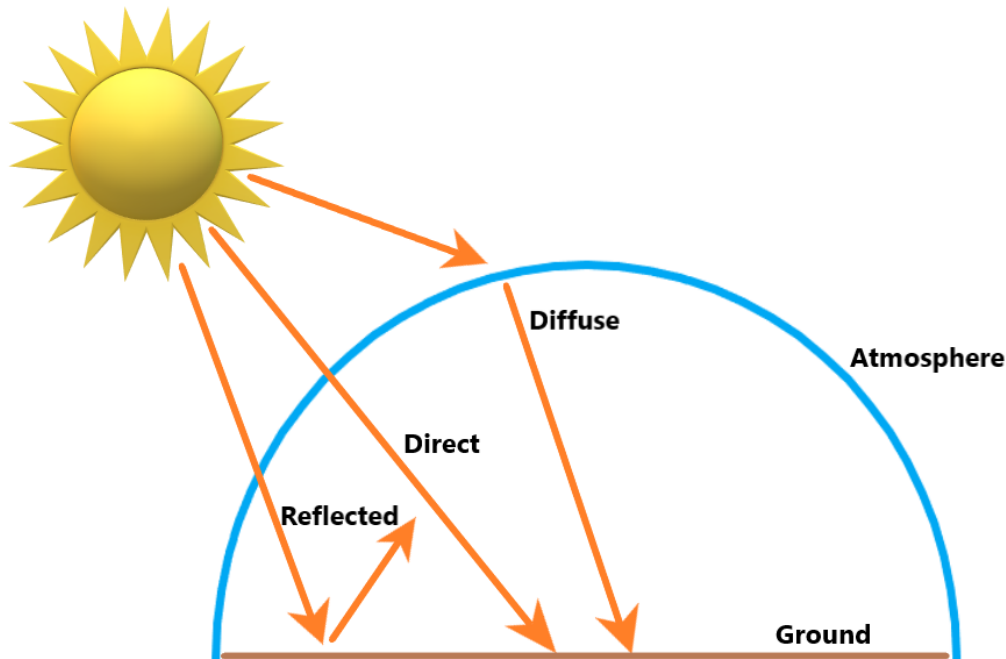

Figure 2.1: Types of irradiation.

Another important parameter to consider is the global irradiation (G_{gl}), the sum of G_{dir} and G_{dif} . It is possible to measure direct, diffuse and global irradiation with a pyranometer. Besides, it is possible to use a reference solar cell to measure global irradiation.

Air Mass (AM) is the measure of the length of the path through the atmosphere. Formula (1) is used for calculating the AM; where L is the length between the sun and the point where irradiation is measured; L_0 is the length between the sun and the earth surface perpendicularly; and θ is the angle between the zenith and the position of the sun. Some examples are: AM0 is obtained outside the atmosphere, AM1 on the earth surface when

the sun is perpendicular to the location, and AM1,5 on the earth surface when the sun is at $48,2^\circ$ with the zenith. [2]

$$AM = \frac{L}{L_0} = \frac{1}{\cos \theta} \quad (1)$$

2.2. Solar cells

Thanks to the photovoltaic effect solar cells can transform the irradiation energy from the sun into electric energy. It is not the purpose of this thesis to explain the physics behind the photovoltaic effect, but it is interesting to know that solar cells are the elemental component and are composed of a thin film of doped semiconductor material. Solar cells are connected forming a module, several modules connected form a panel, and several panels connected form an array, which is illustrated in Figure 2.2.

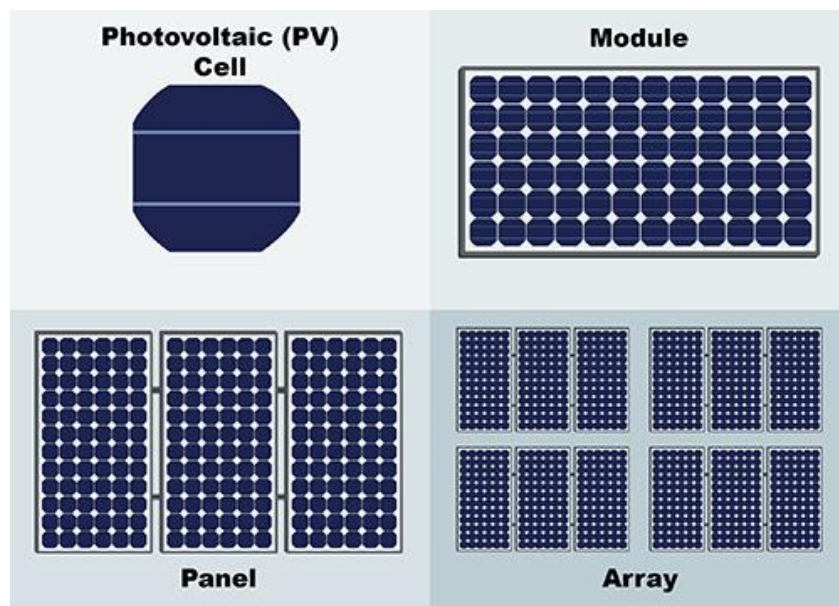

Figure 2.2: Cell, module, panel and array [2]

Figure 2.3 illustrates the current-voltage curve (blue) and the power-voltage curve (orange) of a solar cell when is illuminated. Moreover, some important parameters appear in the figure too. Open circuit voltage (V_{OC}) is the voltage produced when the circuit of the photovoltaic cell is open and is the maximum value of voltage. Short circuit current (I_{SC}) is the current produced with a short circuit of the cell and is the maximum value of current. Power at the maximum power point (P_{MPP}), as its name suggests, is the point of the curve where the cell produces the maximum power. Therefore, the product of voltage in the maximum power point (V_{MPP}) with current in the maximum power point (I_{MPP}) equals P_{MPP} .

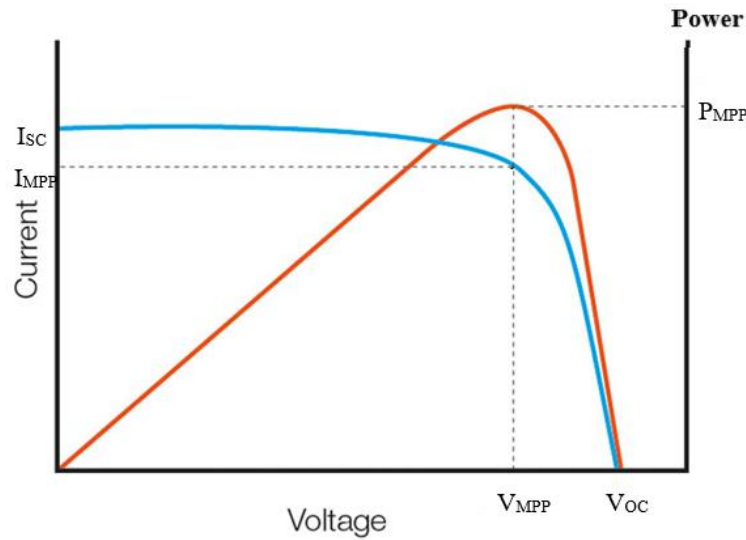

Figure 2.3: Current, Voltage and power curves of a cell (adapted from [3]).

2.3. Effects of temperature and irradiance on solar cells

The values of the current-voltage curve depend on the temperature of the cells and the irradiance that receive, as is shown in Figure 2.4. When the irradiance decreases, the current generated decreases at the same time, while the voltage remains practically constant (a). Otherwise, when the temperature of the cells increases, the voltage decreases at the same time, while the current remains constant (b). Thus, when the temperature increases, or the irradiance decreases, the maximum power produced decreases too.

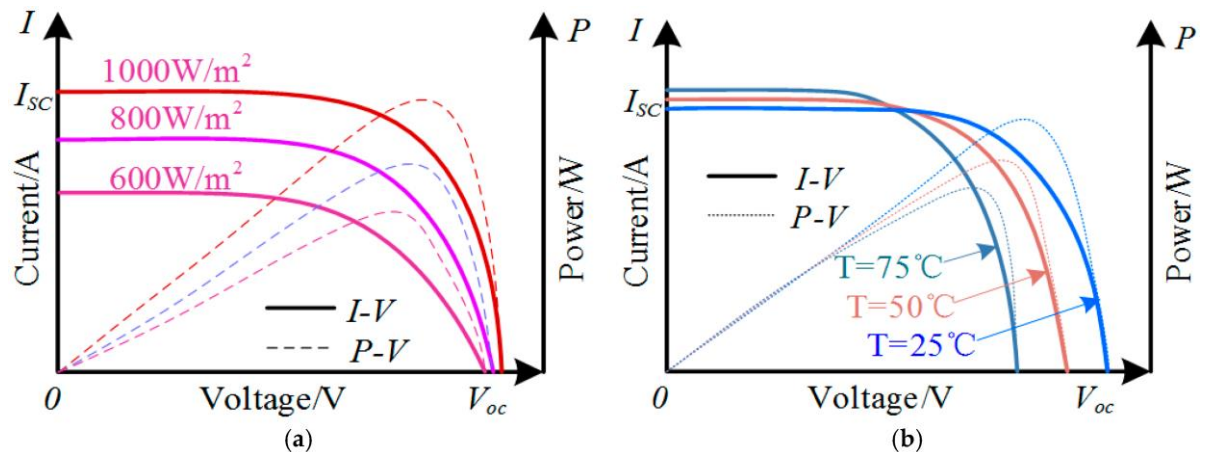

Figure 2.4: Effects of variations in (a) irradiance and (b) temperature [4].

2.4. Connections between cells

It is possible to connect the cells in parallel or series. In the case of identical cells, when are connected in parallel the current adds up, while the voltage remains the same. When cells are connected in series the voltage adds up, while the current does not change. In Figure 2.5 the red curve shows three cells connected in parallel and the blue one shows three cells connected in series. As it has been explained before, several cells connected in

series or parallel form a module, this module has its own current-voltage curve depending on the connection of the cells. Moreover, this module can be connected in parallel or series with other modules as the cells. The connection of several modules has the same effects on current-voltage curves as the connection of several cells. In addition, connections between panels and between arrays work in the same way.

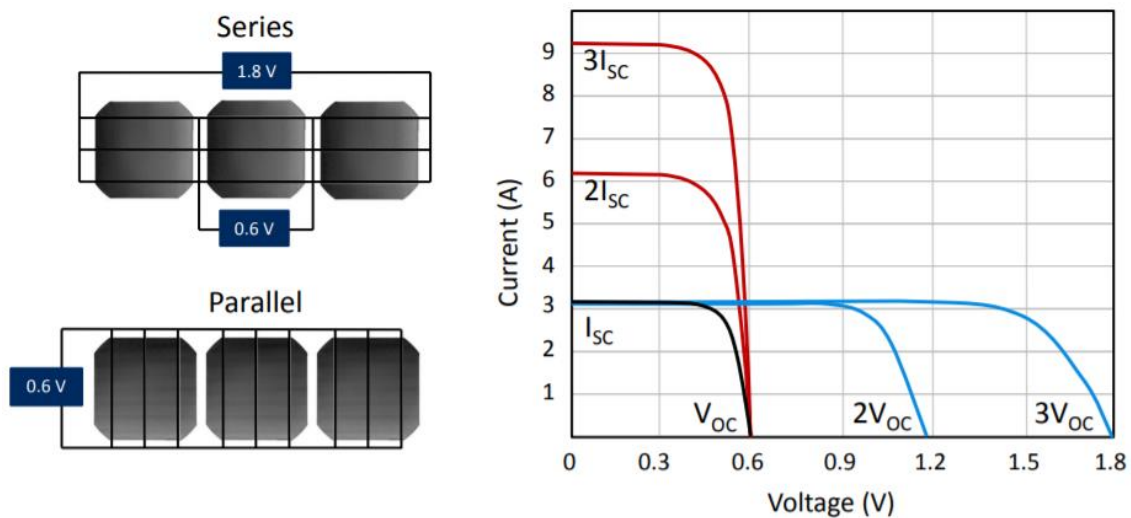

Figure 2.5: Cells in parallel and series [2].

2.5. Mismatches losses

In Section 2.4 is explained the connection between identical cells, modules, panels, or arrays. But if the devices that are connected are not identical, mismatch losses occur. These mismatches may occur due to slight variations in the fabrication of two cells connected. The cells have different values in the current-voltage curve and the efficiency of the set can be limited by the cell with worse parameters. Furthermore, these mismatches may occur due to a partially or completely shaded cell. If a cell is shaded, it receives less irradiation, and as it has been explained in Section 2.3, the current produced decreases.

If there are two cells connected in series and one of them is shaded, and both cells connected to a load (Figure 2.6). The current through both cells and the load must be the same and shaded cell (blue cell) limits the current that can flow in the circuit (red line in the graphic has the same maximum current that the blue line). The cell that is not shaded (green cell) produces more current but, the current extra is recirculated at the same cell. If the current in the net is reduced, the voltage in the load decrease too (Ohm's law). While the voltage in the cell not shaded remains the same. In order to compensate for the reduction in voltage consumed in the load, the cell shaded becomes counter-polarized. This means that the shaded cell starts to consume power. This power is dissipated in form of heat. Indeed, this heat can damage the cells and their connections.

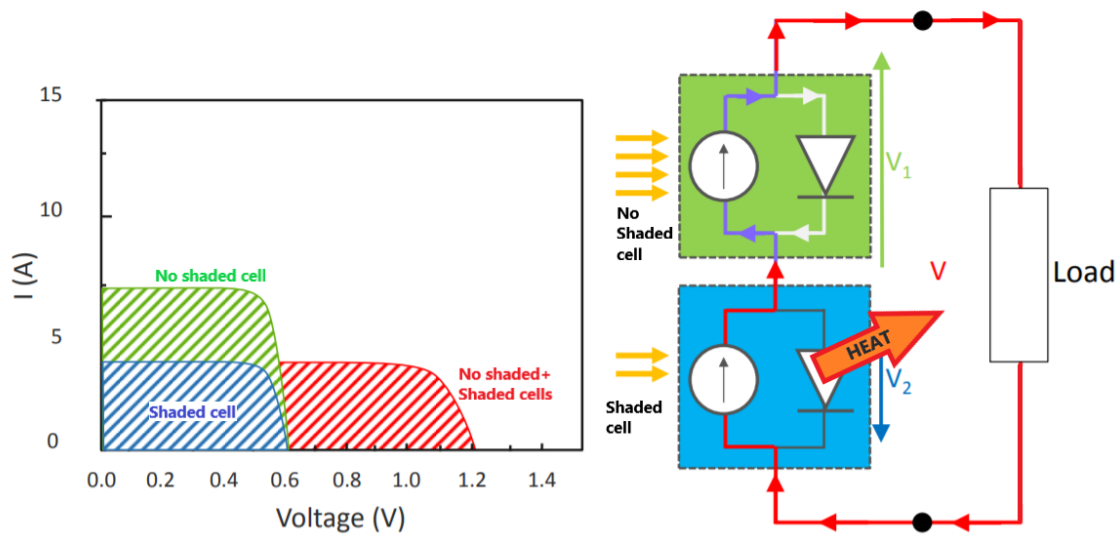

Figure 2.6: Two cells in series with one of them partially shaded.

2.6. Bypass diodes

Shading is an event that occurs often, thereupon it is necessary to solve the problem of power losses caused by mismatches. Bypass diodes are a way to solve this problem. They are connected in parallel with cells. As illustrated in the graph of Figure 2.7, when a cell becomes counter-polarized, if there is no bypass diode (B red curve) the cell maintains the current and the negative voltage can be very high, until the cell breaking. But if there is a bypass diode (B blue curve), when voltage reaches around $-0,7V$ the current starts flowing through the bypass diode and current can increase while the voltage remains constant. That is, the shaded cell does not have to withstand more than $-0,7V$ and does not break. Also, the current flowing through the net can be higher than the current that passes through the shaded cell, current passes through the bypass diode too (A).

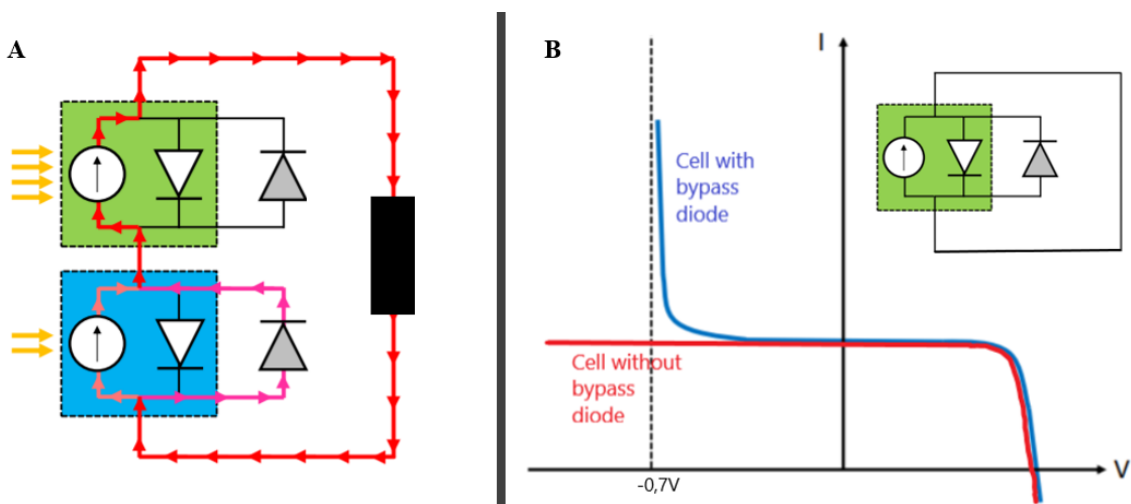

Figure 2.7: Effects of bypass diodes (A) two cells with bypass diodes in series with a load and (B) curve of one cell with and without bypass diode.

When there are multiple cells in series and one of them is shaded, if there are no bypass diodes, the shaded cell will dissipate the excess of power of the other cells and may break. Apart from that, this cell limits the maximum current, so the power produced will decrease at the same time (Figure 2.8, grey curve). On the other hand, if there are bypass diodes (Figure 2.8, red curve), the cell dissipates less power than in the case without bypass diode and the maximum current is not limited by the shaded cell because can flow through the diode. Whereby the power produced by the string of cells in series does not decrease as much as when there are no bypass diodes. The current-voltage curve of the bypass diode cells string with shades, has more than one step. This means that there are more power peaks.

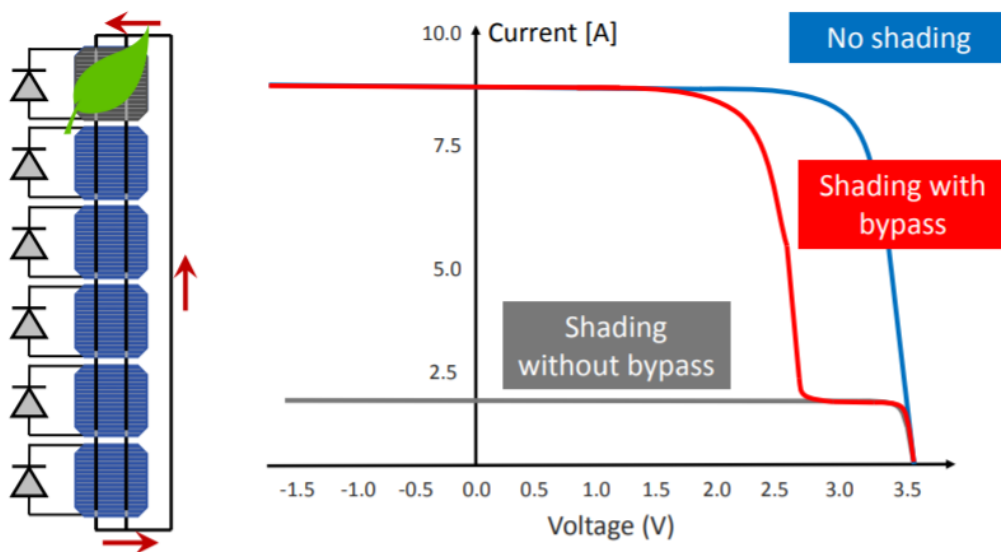

Figure 2.8: Curves of 6 cells connected in series [2].

For the best performance, every cell should have its bypass diode. Nevertheless, to have a good balance quality-price, manufacturers use one bypass diode for more than one cell. With this, manufacturers reduce the price of the PV panels but, it reduces the performance when some cells are shaded.

2.7. PV panel connected to the loads

The purpose of the PV panels is to use the power that they produce. It has been explained in Section 2.2 the current-voltage curves of the panels and how power is produced. Now, it is interesting to learn about how these curves interact with the loads and how to use the maximum power available.

The curve of a resistance in a current-voltage graph is a straight line by Ohm's law. If a PV panel is directly connected to a load, the point where the straight line of the resistance intersects the curve of the PV panel is the operating point (Figure 2.9). The resistance value controls the slope of the line, so depending on the resistance the intersection of the lines may or may not be the maximum power point (MPP). If the intersection of both

lines coincides with the MPP (as in Figure 2.9 with 1000W/m^2) when the irradiation of the cell changes the new intersection does not coincide with the MPP. If the operating point does not coincide with the MPP, the power produced is less than the power that the PV can produce under the same conditions. In Figure 2.9 with 200W/m^2 the red area (power produced by the PV panel and consumed in the load) is smaller than the blue area, which is the P_{MPP} with 200W/m^2 .

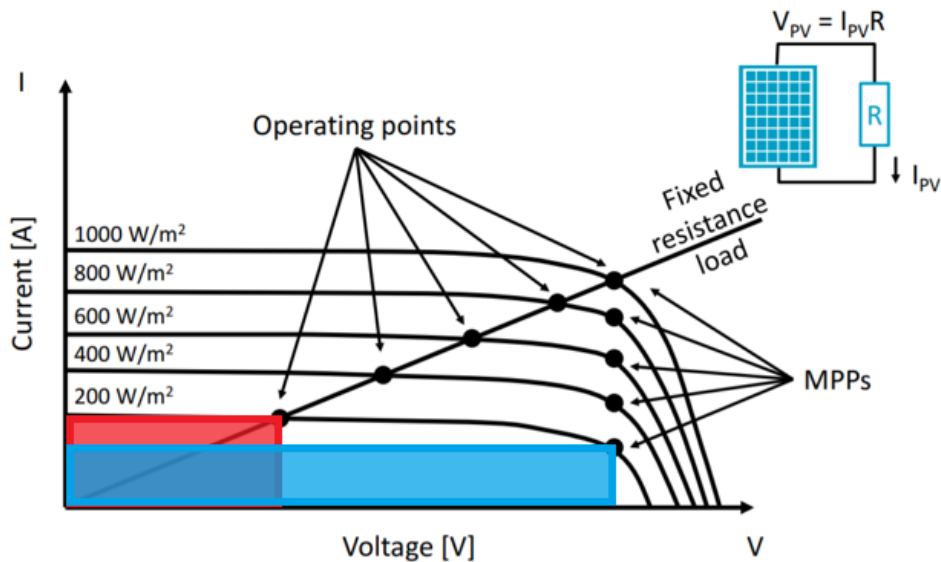

Figure 2.9: Fixed load connected to a PV panel with variable irradiance [5].

As it is said, the slope of the resistance line depends on the value of the resistance. If the resistance connected to the PV panel is variable, changing the resistance value changes the operating point of the PV panel (Figure 2.10). Thus, by changing the value of a variable resistance directly connected to a PV panel, it is possible to obtain the points of the current-voltage curve of the PV panel under the conditions in which it is found.

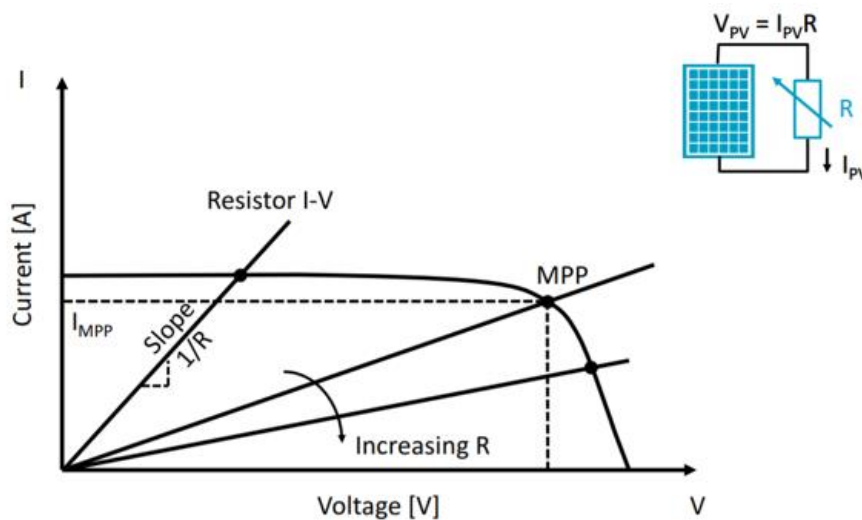

Figure 2.10: Variable resistance connected to a PV panel.

2.8. Maximum power point tracker (MPPT)

When the irradiance of the PV panel changes or the value of loads changes, the operating point of the assembly changes. With these changes the operating point probably does not coincide with the MPP and the power produced is less than the power that can be produced under the same conditions. That is, there are losses of power, and the yield decreases.

In order to prevent these losses, there exist the maximum power point tracker (MPPT). The MPPT is connected directly to the PV panels and basically, it is a DC-DC converter that decouples the voltage produced in the part of PV panels from the voltage in the consuming part. It is responsible to adjust the operating point of the PV panels to be as close as possible to the P_{MPP} . There are direct and indirect techniques to find the P_{MPP} . Direct technique tracks the curve of the PV panel to find the P_{MPP} in the moment of power production, thus these techniques consider the possible changes in irradiance and shades. Indirect techniques estimate the MPP using predefined parameters, thus these techniques do not consider the changes in irradiance and shades. Direct techniques are more efficient but more complex and expensive. [6] Usually, MPPTs are hard coded in inverters or charge controllers depending on the configuration of the assembly.

Figure 2.11 shows the curve of a PV panel with several shades. In this picture, it is possible to observe the most important drawback of MPPTs. When there are some shades there are several power peaks and MPPTs can find power peaks but do not distinguish between the maximum global peak (point 2) or local peaks (points 1 and 3). Consequently, MPPTs may work at a local peak (for example point 3) and the output of the panels might be considerably lower than it should be (point 2). To overcome this problem is necessary another method that analyses all the power-voltage curve and finds the global peak. [7]

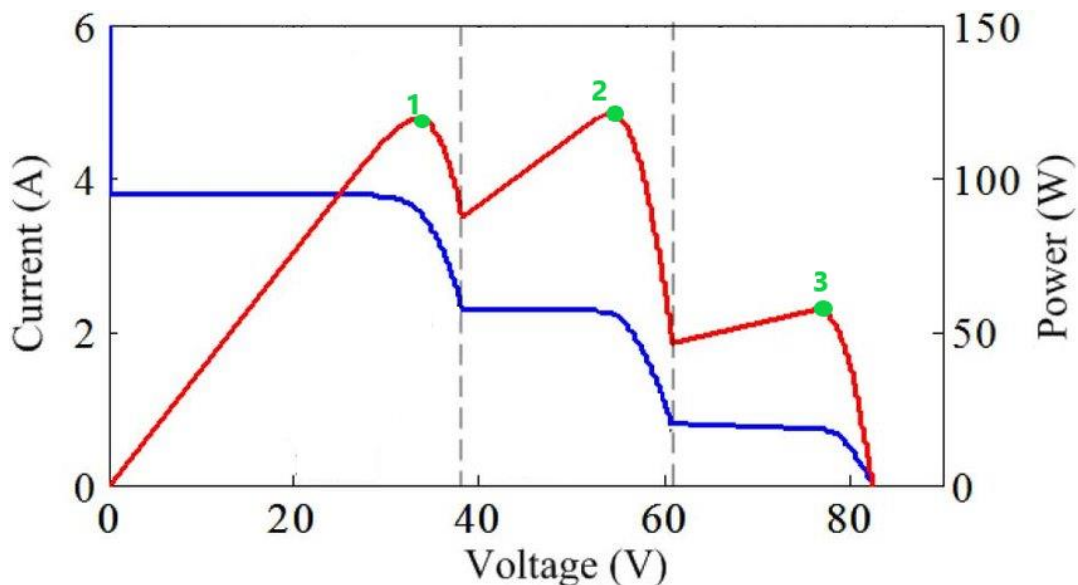

Figure 2.11: Curves of current-voltage (blue) and power-voltage (red).

2.9. Cooper, indium, gallium and selenium (CIGS) panels

The most extended technology in PV panels is silicon-based material as rigid frames. But this thesis uses thin film PV panels, and specifically CIGS panels. This technology is conformed of a thin layer of copper, indium, gallium, and selenium and covered by material for protection. This makes the panels lighter and enables to modification of the geometry of the PV panels. Moreover, thin film PV panels have less influence on the temperature in their performance and work better with more diffuse irradiance, especially on cloudy days. On the other hand, the performance of flexible PV panels can oscillate a little depending on the used technology (11-18%) but usually is less than mono and polycrystalline silicon panels. Technologies of thin film PV panels are technologies that are not very widespread but, much progress has been made in recent years and are expected to improve their yields further. [8]

2.10. Performance measurements in PV panels

In order to obtain the important parameters of the PV panels and compare the performance of different PV panels, manufacturers test them under the same conditions. The most common test is with Standard Test Conditions (STC). The conditions are irradiation of 1000W/m^2 , 25°C of temperature, and AM 1,5.

To analyse the energy yield of PV panels is necessary to control some important parameters. On one side, the power produced for the panels must be known. For this, some current and voltage sensors are used. On the other side, the energy that receive the panels must be known. For this, is necessary to know the irradiance received by the panels, the temperature of the panels and the ambient temperature.

To measure irradiance there are two types of sensors: pyranometers and reference solar cells. Pyranometers are based on thermocouple devices, are more accurate and have a time of response between 5 and 30 seconds. Reference solar cells are solar cells calibrated. In addition, reference solar cells measure less irradiation than pyranometers and have a time of response of some milliseconds. Accordingly, reference solar cells have advantages to measure in the per-second range during scattered cloud conditions. On the other hand, pyranometers are more useful to have a more precise measurement of irradiance.

The other important balance of energy is heat. The heat dissipated by the PV panel is proportional to the different temperatures between the module and ambient temperature. For this, the temperature of the panel and ambient temperature must be measured. The thermocouple is the most used sensor for measure temperature. To measure the temperature of the panel thermocouple is placed on the back of the panel. [9]

3. Analysis of performance of the PV panels

This chapter contains all aspects related to the tests of the CIGS flexible PV panels in different geometries. It is divided into three sections. The first one explains the characteristics of the PV panels used for the tests. The second section explains the arguments carried out to decide the type of tests to do. The final section contains the description of the devices used for the tests and how are performed.

3.1. CIGS flexible PV panels

In the department of Mechanical and Marine Engineering, there are several CIGS flexible PV panels. Manufactured by MiaSolé company and model FLEX-02 120N. These panels are used to test the differences between panels with different geometries. Its electrical characteristics in STC and main measures are:

Nominal Power	P_{MPP}	120W
Aperture Efficiency	η	15,7%
Maximum Power Voltage	V_{MPP}	30,5V
Maximum Power Current	I_{MPP}	3,93A
Open Circuit Voltage	V_{OC}	38,1V
Short Circuit Current	I_{SC}	4,53A
Length		2597 ± 7 mm
Width		363 ± 13 mm
Thickness		2,5mm
Weight		2kg

Table 3.1: Characteristics and measures of flexible PV panels for test [10]

Panels are composed of 56 cells connected in series and have one bypass diode every two cells. The cells are produced depositing the CIGS semiconductors on a stainless-steel foil, are protected by a transparent plastic in the front part and a film of aluminium with plastic in the back. These panels can easily modify their form, can roll up, twist, and adopt a semi-circular or wavy geometry.



Figure 3.1: CIGS flexible panels.

3.2. Tests procedure

When a PV panel remains in a curved geometry, the irradiation of the cells changes. This effect resembles the way some cells were shaded. Whereas the cells that are more oriented to the sun produce more energy and the cells worse oriented produce less energy. Furthermore, if the geometry is a semicircle or deep waves, the differences between the good and bad oriented cells can be considerable. As it has been explained in sections 2.5 and 2.6, when there are cells connected in series and some are shaded, there are problems with power dissipated by the shaded cells. What is more, there is a reduction of the power produced. Because of this, the panels have a bypass diode every two cells and the manufacturer says that when panels are shaded have less power reduction compared with common rigid panels. Since common rigid panels usually have one bypass diode every 9-18 cells.

Considering these points, the first idea was to test the performance of a PV panel in a semi-circular form, and then compare the results with the performance of another panel tested in a flat way, both panels in the same place, at the same time and in the same orientation. Nonetheless, problems arise to deciding what parameters measures and what device is the best for connecting to PV panels. As explained in sections 2.7 and 2.8, it is viable both to connect PV panels directly to the loads as well as connect to an MPPT and then to the loads.

On one hand, if the panels are connected directly to the loads, the operating point changes when the irradiance or temperature changes, and most of the time panels are not working at the MPP. Moreover, the flat panel without shades has a current-voltage curve with only one step (Figure 3.2 yellow curve). However, the curved panel has a current-voltage curve with more than one step due to the differences in irradiance by the geometry (Figure 3.2 blue and green curves). If there are several steps, the intersection between the current-voltage curve and the straight line of the loads can change a lot with little differences in the irradiance. There is a huge difference if the intersection is at the peak of the step or at the falling flank. Thus, the power production may be very unstable and the comparison between the flat and curved panel may be inaccurate.

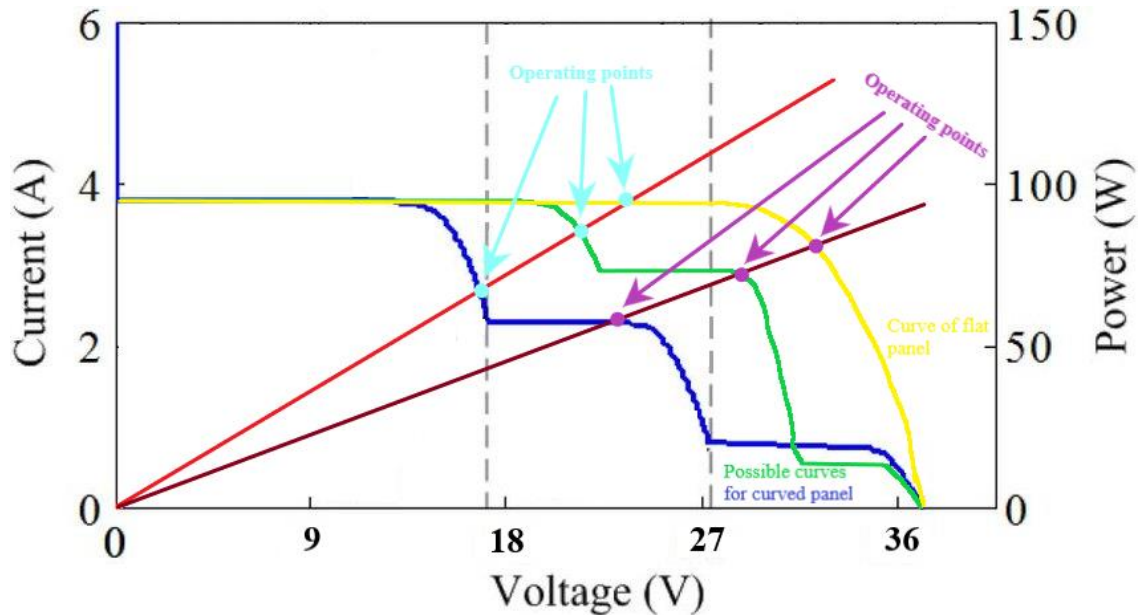

Figure 3.2: Curved and flat panels connected to the loads.

On the other hand, another option is to connect the panels with an MPPT and then to the loads, to have the maximum power produced in each panel. Notwithstanding this, the MPPT has two drawbacks. The former is that MPPTs on the market are embedded into an inverter or a charge controller which makes the test more complex. Besides this, it introduces new possible errors depending on the device used and makes the test more expensive. The latter disadvantage is that the MPPTs track peaks of power, but if there are more peaks may work in a local peak and not in the global peak. Accordingly, the flat panel may be working at the MPP because it has a curve with a single step. On the contrary, the curve panel may work in a local peak due to the multiple peaks that it has. This can lead to big errors in results.

In light of the points discussed above, the best test to do is connect the panels to a variable resistance to know the current-voltage curves of the flat and semi-circular geometry panels in different parts of the day and days with different irradiance types. Knowing the curve of the PV panel provide important information about geometry effects on the performance of the panels. Furthermore, it should be possible to see changes due to the geometry, whether the current-voltage curve of the semi-circular panel has multiple steps and how these steps change during the day. What is more, the availability of the curves of the panels should be useful to choose whether it is interesting to use an MPPT or not for future tests. In addition, it should provide performance information among the two geometries in days with different types of irradiances.

A long-term test is performed. The current-voltage curves of the flat and semi-circular geometry panels are tested every 10 minutes for a few days. With this test, it is possible to see the differences in the curves on different parts of the day and different irradiances. Moreover, it is feasible to calculate the maximum power produce in each measure. Thanks

to this, the maximum energy that the panels produce in one day can be estimated. Having all these parameters, the performance of both panels can be compared.

Another performed assay is test both panels in their own geometry connected in series and compare the obtained current-voltage curve with the curves of the panels alone. This test is interesting to see the effects of two panels with different current-voltage curves connected in series. Since, two panels with different curves connected in series have the same effects as mismatch losses as it has been explained in Section 2.5 and Section 2.6.

3.3. Performance test and devices used

It is worth noting that the objective of the test is not to obtain a reference on the overall performance of the panels, but rather to compare both geometries. Namely, this thesis aims to compare the differences in performance between two equal panels that have different geometry. It is not intended to obtain the yield of the panels measuring the energy that they receive and the energy that they produce.

In Section 2.10, it is explained that to measure the performance of the PV panels must be measured: the energy produced by the panels, the irradiance that they receive, the ambient temperature and the temperature of the panels' surface. But, as explained in the previous paragraph, the test is not for measure the performance, but to compare the performance of both panels. Hereby, in the test there is no need to know the irradiance of the panels and their temperatures. This is due to the fact that both panels are in the same conditions, in the same place, at the same time and with the same orientation. Accordingly, both panels are at the same temperature and receive the same irradiance and comparison without knowing these parameters does not cause any error. Therefore, for the test it is only necessary to measure the values of current and voltage produced by the flexible PV panels.

Firstly, it is necessary to have two supports to sustain the PV panels in the right position. As will be explained in next Section 4, initially this thesis aimed to construct adaptable support to test the panels in different geometries. Nevertheless, due to the complexity of the design and the time constraints, it is not feasible to construct the adaptable support to do the test. As a consequence, two simple supports have been constructed to perform the tests. In particular, one support is used to fix a PV panel in a flat way and another to fix a PV panel in a semi-circular form. The supports in Figure 3.3 are constructed with wood and some screws using the tools of the workshop.

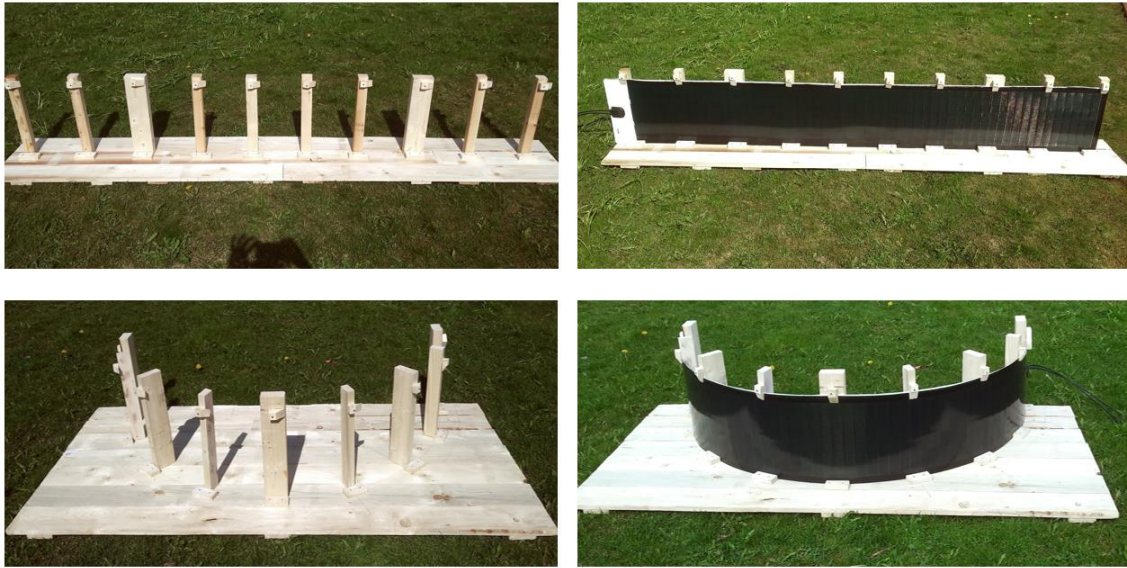

Figure 3.3: Curved and flat supports.

Then, a control circuit is built to measure the current and voltage of the PV panels and vary the loads connected to the panel in order to obtain the current-voltage curve. A National Instruments (NI) data acquisition (DAQ) device is used to collect the data from the control circuit, and it is connected to a laptop. The laptop uses LabVIEW to program and control the circuit. Moreover, the laptop stores and organizes the data collected from the panels.

The control circuit consist of two equal devices, one for each panel, to measure the current-voltage curves at the same time. The devices (Figure 3.4 and Figure 3.5) are made up of a heatsink of aluminium cooled by a fan, a transistor MOSFET IXFN200N10P (to vary the operating point of the PV panels) and resistance of $0,1\Omega$ (to measure the current), both screwed to the heatsink to cool them. The MOSFET endure 100V or 200A and a maximum of 680W at 25°C and is controlled by an output signal of the DAQ device. In Attachment 1 there is the datasheet of the MOSFET. The resistance of $0,1\Omega$ is calculated for a maximum of 5A (the I_{sc} of the panels is 4,53A) and it is measured the difference of voltage with the DAQ device. This voltage difference is scaled to know the current flowing throw the panel. In parallel with this resistance and the MOSFET, there are two resistances for measure the voltage of the panel, one of $56\text{k}\Omega$ and the other of $9\text{k}\Omega$. These resistances are calculated to have a maximum current flowing throw them of 1mA and to measure a maximum of 10V in the small one.

The DAQ device has two inputs for each device, one is the measure of the voltage difference in the $0,1\Omega$ resistance (green wires on Figure 3.4) that is transformed in the measure of the current across the panel. The other input is the measure of the voltage difference across the $9\text{k}\Omega$ resistance (red wires on Figure 3.4) that is scaled to get the panel voltage. On the other side, the DAQ device has one output for each device to control

the gate of the MOSFET (blue wires on Figure 3.4) and change the circuit loads. All these parameters are controlled with the laptop. Finally, a power source of 24V is necessary for the fan.

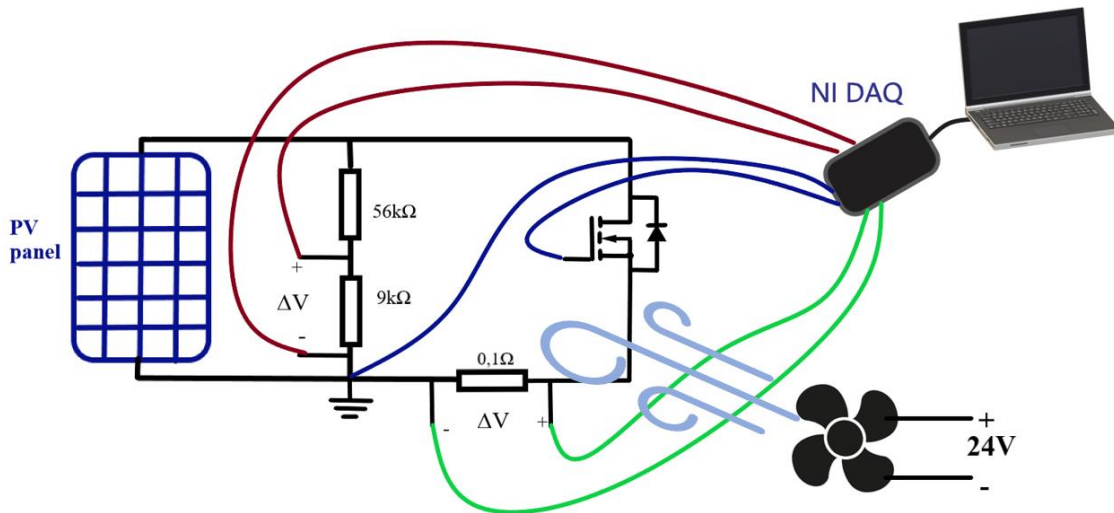

Figure 3.4: Control circuit diagram.

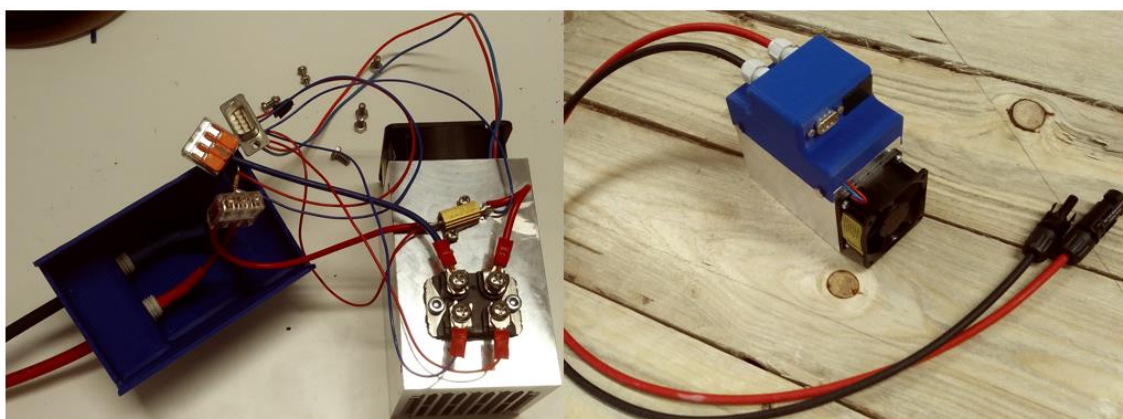

Figure 3.5: Control circuit device.

In Attachment 2 there are screenshots of the program used to control the devices and obtain the data. The software used is LabVIEW. The program increases the voltage difference across the gate of the MOSFET in multiple steps to change the operating point, and then it measures the corresponding current and voltage values. The tests start with 3V in the gate on the MOSFET (the circuit is open) and increase until 5V (the circuit is short circuited). The program performs 200 steps to complete the range and takes one measure every step. In other words, it boosts 0,01V of the MOSFET and takes one measure 200 times. In order to perform the long-term tests, these measures are taken and saved every 10 minutes.

4. Design of the adaptable support

The first idea for this thesis was design and construct an adaptable support, but due to the complexity and time constrains is only made the design. This design is thinking for enable flexible PV panels to assume a wide range of geometries to enable performance testing.

This chapter contains a study of some geometries of real-world applications in Section 4.1. Moreover, in Section 4.2. it is explained the design of the adaptable support and some possible pieces to use. The design only contains ideas of how to build the adaptive support and tries to solve the problems posed to assume a wide range of geometries. In other words, it is not detailed the pieces to use and their measures. Since, the pieces and measures must be decided depending on the PV panels used and the quantity of panels. Anyway, in Attachment 3 there are a list of materials to construct the support for one panel with the dimensions explained in Section 3.1.

4.1. Geometries of possible applications

Rigid PV panels can facet a large number of building with straight lines or curves with a large radius of curvature. But there are some buildings where the curves are more pronounced and rigid PV panels are not able to clad their surfaces. Flexible PV panels can twist, roll up and take different forms to cover many more surfaces.

Some buildings have pronounced curvatures for functionality, others for aesthetics. But in all building may be interesting to integrate PV panels and produce electric energy. One geometry used in many structures is the semi-circular, depending on the radius of curvature, the panel may cover more or less than a semi circumference. It is used in some roof of bus stops, in some toilets in the cities, and in some structures for advertising, view Figure 4.1.



Figure 4.1: Examples of buildings with circumference geometries: toilet, bus stop and advertisements column.

Another interesting geometry is the wavy. It can be found in some buildings mostly for aesthetic reasons. Indeed, there are ripples with different depths and may have more or fewer undulations, view Figure 4.2.



Figure 4.2: Examples of Buildings with wavy geometries.

The flexible PV panels are able to twist, and it may be interesting to test the performance of twisted panels. There exist many more geometries that can be clad with flexible PV panels, and accordingly can be interesting to know the performance of the panels in these forms.

Moreover, all these geometries that have been talking may stay in different angles, directions, and orientations. The flexible panels can stay in a vertical or horizontal way, can have different slopes, and can be directed to different orientations.

4.2. Design and pieces

For the design of the mounting adaptable support is necessary to take into account all the geometries and all considerations described in the previous Section 4.1. The idea is to be able to vary the maximum range of geometries using only one support and making the minimum changes between the different forms.

In order to allow flexible PV panels to assume semi-circular and wavy geometries. It has been designed a structure composed of several small supports that can adapt their height, position, and inclination. These small supports are composed of one plate with flats (A in Figure 4.3), two threaded bars, and two ball and socket joints for each small support (B in Figure 4.3). The height and position of the small support are regulated by four nuts and four spring washers in the thread bars that connect the supports with the structure (D in

Figure 4.3). Similarly, the ball and socket joints allow the rotation and inclination of the plates. Also, with the ball and socket joints the panels can be twisted.

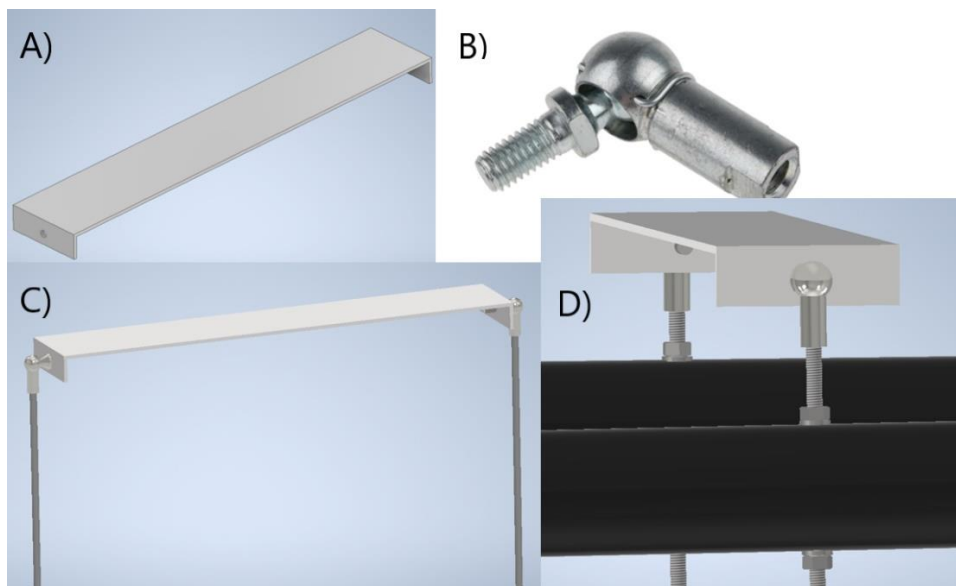

Figure 4.3: A) plate, B) ball and socket joints, C) small supports, and D) supports fixed to the structure with nuts and spring washers.

Placing 14 small supports in the structure, one each 200mm, and using threaded bars of 1 meter. It is possible to adapt a semi-circular form or less than a half circumference using the panels of the Section 3.1. Moreover, it is possible to assume a wavy form with different measurements of ripples. In Figure 4.4 is illustrated different possible geometries to perform with the designed support: flat, different waves and twisted.

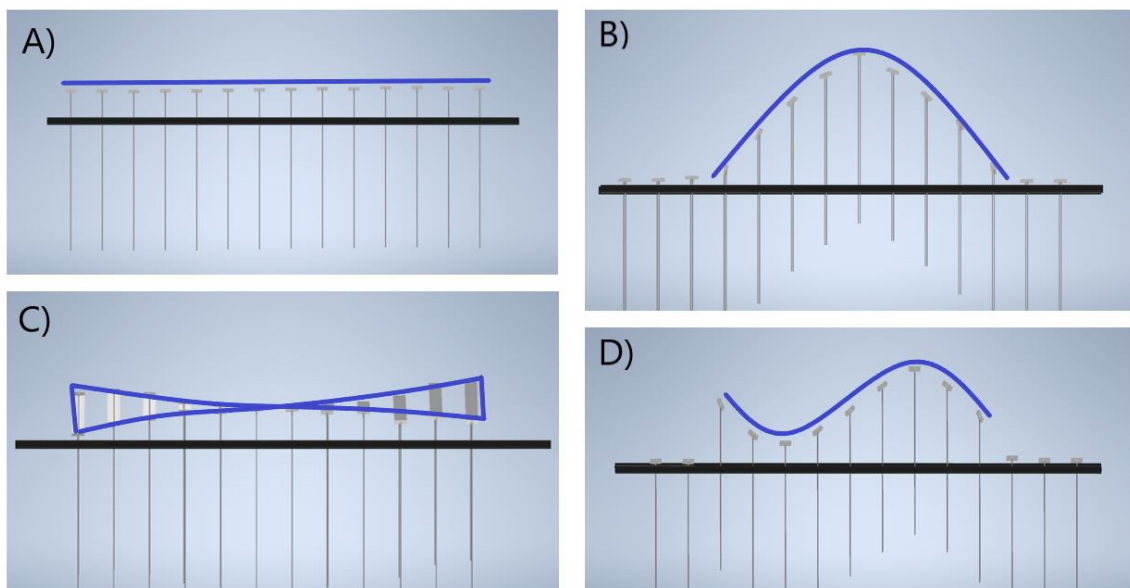

Figure 4.4: A) flat panel, B) panel with one undulation, C) panel twisted, and D) panel with two undulations.

The small supports are united to the structure with the threaded bars and the nuts. The support is composed of scaffolding material, as a result the structure is more adaptable, and is easy to change pieces and change the position. The scaffolding material are aluminium tubes 48,2mm of diameter, and swivel couplings for the tubes (Figure 4.5). Several holes must be done in some tubes to pass the threaded bars of the small supports.



Figure 4.5: Scaffolding tubes and swivel couplings

The structure is made up of some tubes with holes, and some legs to hold the support and allow the movement of the threaded bars (Figure 4.6). Moreover, it is interesting to be able to change the slope of the panels to perform the tests. Figure 4.7 illustrates that to test angles between 0° and 45° the small supports and the panel must stay on the top of the support, whilst to test angles between 45° and 90° the small supports and the panels must stay on one side of the support. In Figure 4.6 is possible to see that additional tubes and connections are necessary in order to make the structure more stable.

To calculate the length of the legs, it must be considered that the threaded bars do not touch the ground when the support is at 45° . Besides, the threaded bars may collide with the support depending on the position, but the support is versatile enough to remove the colliding parts or otherwise position them. Depending on the position of the support and the distribution of weight, the support may be unstable in some geometries. Hence, it may be necessary to fix the support to the ground or use concrete blocks to secure the support.

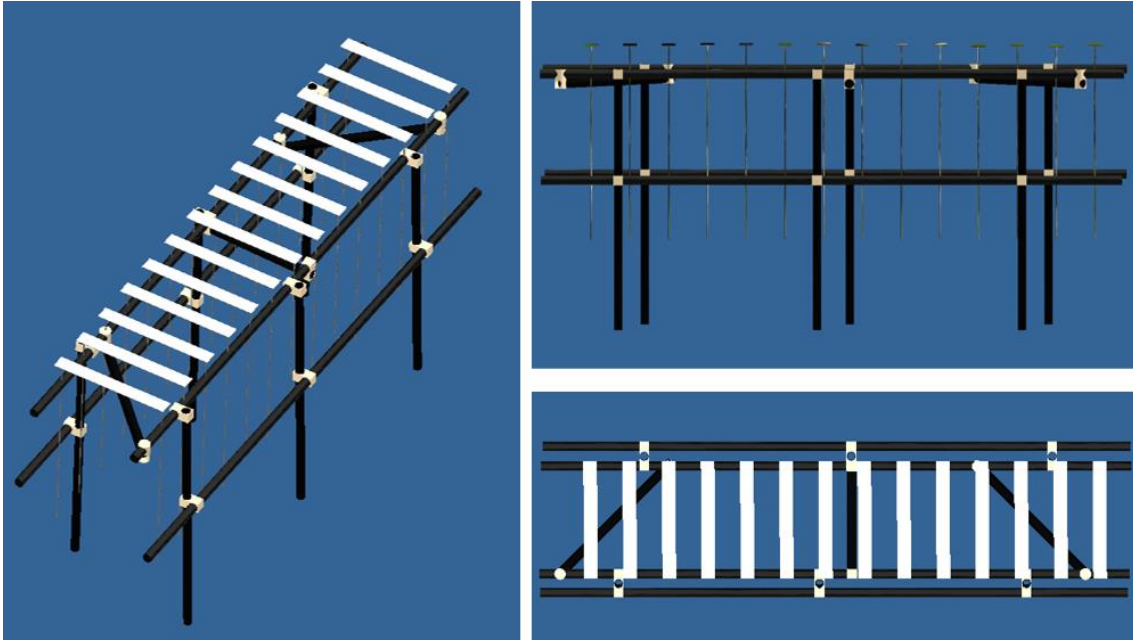

Figure 4.6: Support views

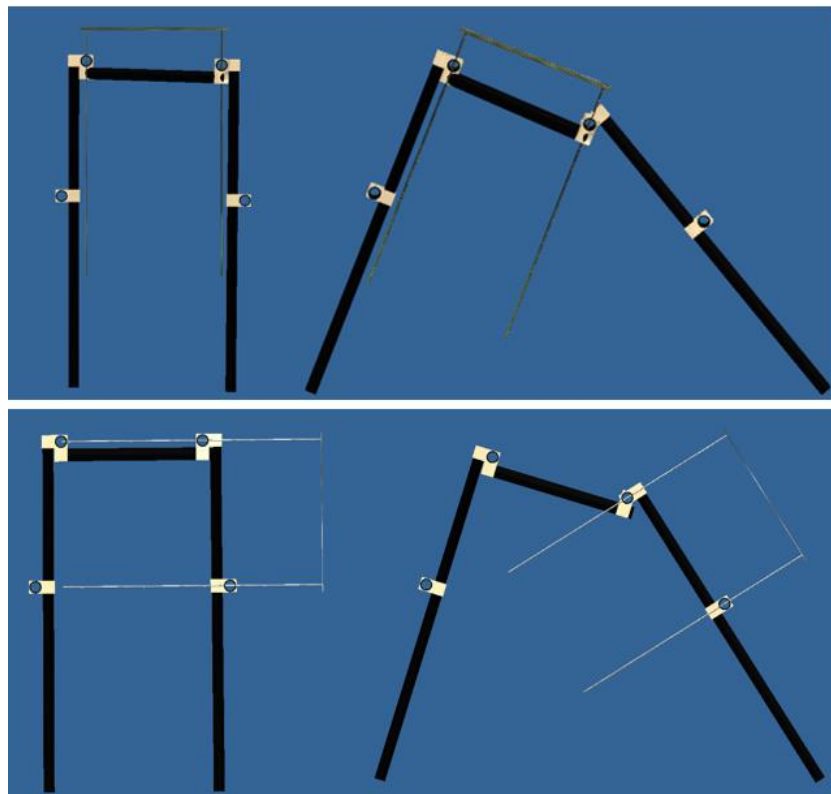

Figure 4.7: angle changes in the support horizontally

With the design of figures 4.6 and 4.7, the support can assume a wide range of geometries and can change the inclination. But the inclination only changes by always keeping the long sides of the panels horizontal. It is interesting to be able to change the slope by keeping the short sides of the panels horizontal. For this, it is necessary to change the legs

of the support, see Figure 4.8. Thanks to the versatility and adaptability of the scaffolding structure, is possible to use the tubes and the swivel couplings used previously to create new legs and change the slope of the panels in a vertical way (Figure 4.8). For some tilts may be necessary new length of tubes or new material. But with the same material of Figure 4.6 and Figure 4.7 and changing the position of the pieces, it is possible to assume a wide range of angles keeping the short sides of the panels horizontal. As shown in Figure 4.8, the support gets taller, and the consequence is that it becomes more unstable. Under these circumstances, it may be necessary to add more legs, fix the legs to the ground, or use concrete blocks at the base of the legs.

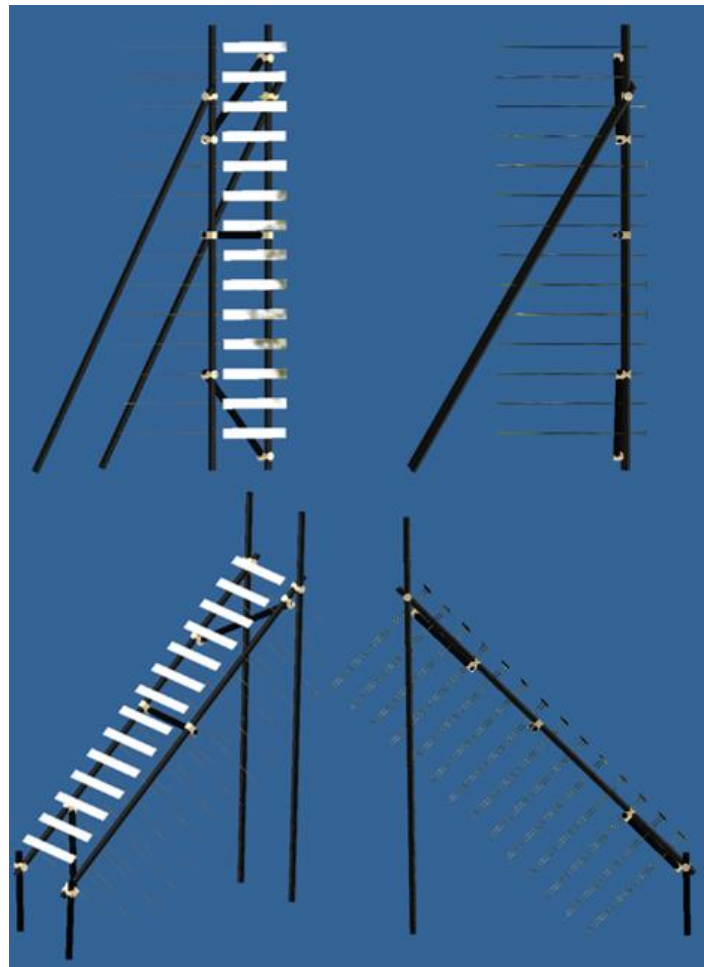

Figure 4.8: Angle changes in the support vertically

Finally, it is thought to use adhesive tapes to fix the panels to the support.

5. Results

This section contains the results of the tests on the CIGS flexible PV panels performed at the solar lab in HVL. The methodology for the tests and devices used are explained in Chapter 3. Moreover, the theoretical aspects necessary to understand the results are explained in Chapter 2.

Two different tests explained in Section 3.3, are performed in this thesis. In the long term, one test shows the differences in power production between both panels and the current-voltage curves with different types of irradiation and different parts of the day. In a short period, the second one shows the differences in the current-voltage curves of a flat and curved panel, and then both are connected in series.

5.1. Long-term test

The test is performed on the flat and semi-circular panel for several days. The measurement of the curve is carried out every 10 minutes at the flat and curve panels at the same time. Both panels are oriented to the south and in a slope of 90° by the long side of the PV panel. Moreover, the test is carried out in overcast and sunny days, but in overcast days sometimes appears the sun and in sunny days appears some clouds. Thus, the measures may change a lot between two consecutive measurements. Even so, with the taken measures is enough to estimate the power produce by the panels and compare between them.

Another point to consider is that in the measurements that have been taken first there are some noises in a part of the curve. This is because for the long-term test the electronic devices are placed inside the passive house. In the house, there are additional noises due to other devices. This noise is filtered out for the subsequent tests using a condenser of $10\mu\text{F}$ between the gate and the source of the MOSFET.

In Figure 5.1, it is shown the differences in the current-voltage curves of the flat and semi-circular panels. In this measurement, both panels are in line with the sun. It is possible to see that the curve of the flat panel has only one step since all the cells receive the same amount of irradiation. Otherwise, the curve of the semi-circular panel has multiple steps due to the different orientations of the cells and the different irradiance in each one. As a consequence of the use of bypass diodes, the curve of the semi-circular panel does not have the maximum current limited by the cell with less irradiance. The curve of the semi-circular panel has less current with the maximum voltage than the flat's curve, due to has some cells bad oriented with less irradiance. Then, as the voltage decreases, the current increases progressively in multiple steps because of the better orientation of the other cells. Finally, in the short circuit current, both panels have the same amount of current as a result of that some cells of the semi-circular panel are in the same direction as the cells of the flat panel, in line with the sun. In addition, it is illustrated that the open-circuit voltage is practically the same in both panels albeit the irradiation that they receive is

different. As it has been explained in Section 2.3, the changes in irradiance have effects on the I_{SC} but no on the V_{OC} and as the temperature is the same in both panels the V_{OC} does not change.

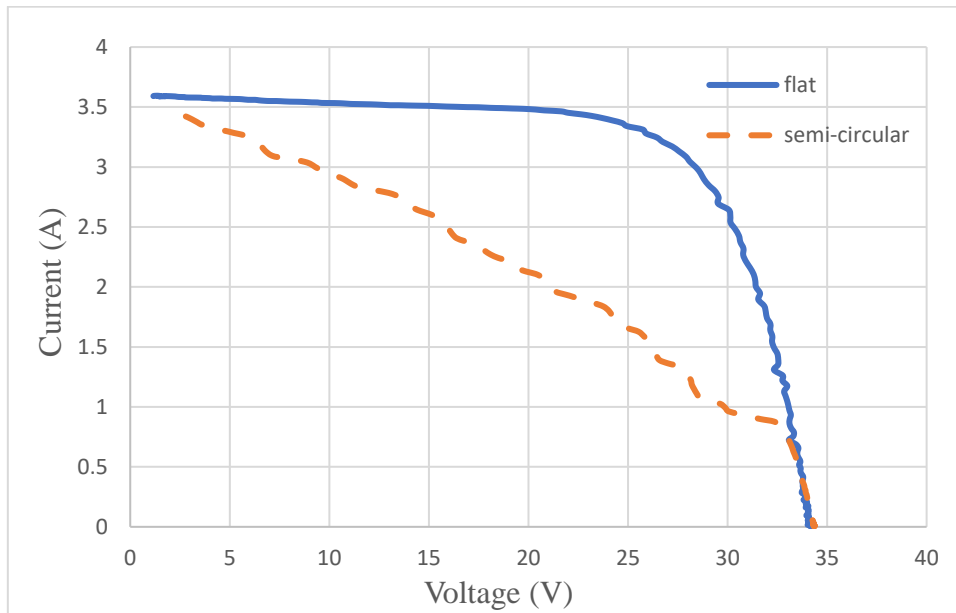

Figure 5.1: Current-voltage curve of flat and semi-circular panels.

As a derivation of the previous curves, the power-voltage curves (Figure 5.2) show that the curve of the flat panel has a marked peak. Nevertheless, the semi-circular curve has not a marked peak, it has a section with more or less constant power. Clearly, the maximum power point is higher in the flat panel.

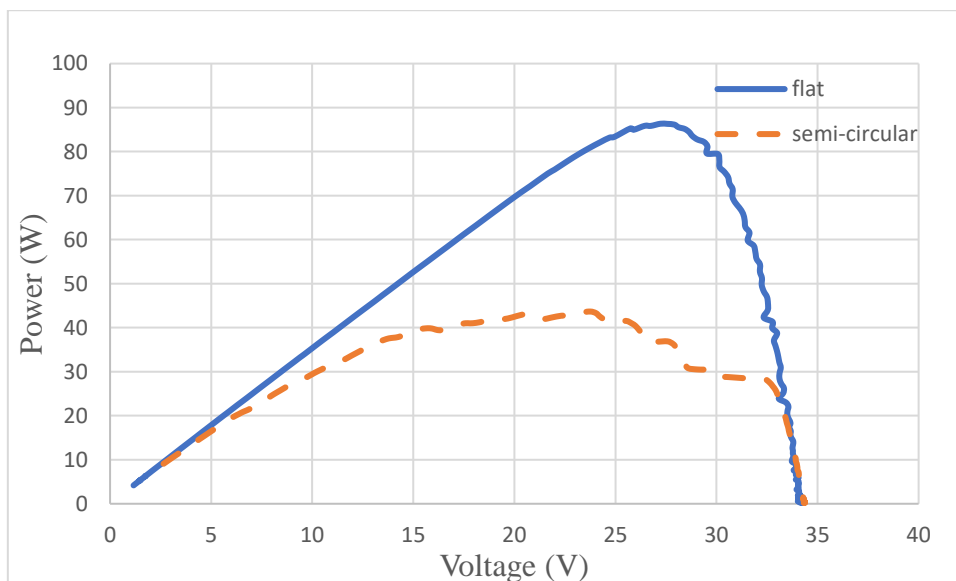

Figure 5.2: Power-voltage curve of flat and semi-circular panels.

These last two figures illustrate the differences between both panels in a sunny time when the sun is in line with the panels. However, with the long-term test is possible to study the curves in different parts of the day and with different irradiances.

In Figure 5.3 is illustrated the current-voltage curves of the flat and semi-circular panels at different hours on a sunny day. It is shown the evolution of the curves due to the movement of the sun in the sky. It must be taken into consideration that the irradiance may change due to the movements of the clouds. For example, in the graph of 12:00 PM between 8 and 20V there is a slight decrease of the current due to the movement of a cloud during the period of measurement. Despite the clouds, the changes on the curves with the movement of the sun can be analysed.

In Figure 5.3 at 8:00 AM the curve of the flat panel has a V_{OC} of around 33V and an I_{SC} of around 0,5A. This curve keeps the shape all day, but the I_{SC} increases while the panel becomes better oriented with the sun and receives more irradiance. In other words, the step becomes steeper during noon hours. Moreover, the V_{OC} increases very little according as the panel receive more irradiance.

On the other hand, the curve of the semi-circular panel at 8:00 AM has a V_{OC} equal to 33V and an I_{SC} of about 2,5A. At high voltage values, the curve of the semi-circular panel remains like the curve of the flat panel. By contrast, between 12 and 0V the curve of the semi-circular panels increases in multiples steps. This difference is because of in the semi-circular panel there are some cells that are well oriented to the sun at that hour. Therefore, the cells well oriented can produce more power and can have a higher current through them. Otherwise, the cells worse oriented that do not receive direct irradiance have a maximum current lower as well as the cells of the flat panel at that hour. As the day progresses, the increase in multiple steps of the current on curved panels, starts with higher values of voltage, until midday. At midday, the panel is in line with the sun and the cells of the middle receive the maximum irradiance as the cells of the flat panel. Consequently, the cells of both parts of the semi-circular receive less irradiance, the cells have a lower maximum current as they are further separated from the cells in the middle. During the afternoon, the curve of the semi-circular panel changes in reverse of how it changes in the morning. The increase of current in multiple steps happens on lower voltages.

To summarise, the curve of the semi-circular panel changes its shape depending on the orientation of the panel with the sun. When the sun is in one side the panel has the cells of that side irradiated and the others shaded. Similarly, when the sun is in the middle the cells of the middle receive the maximum irradiation and the cells of both sides receive less irradiation as the panel curves. In the same way, the flat panel has all cells in line with the sun at midday and has the maximum I_{SC} , and in other parts of the day the cells are worse oriented and the I_{SC} decreases.

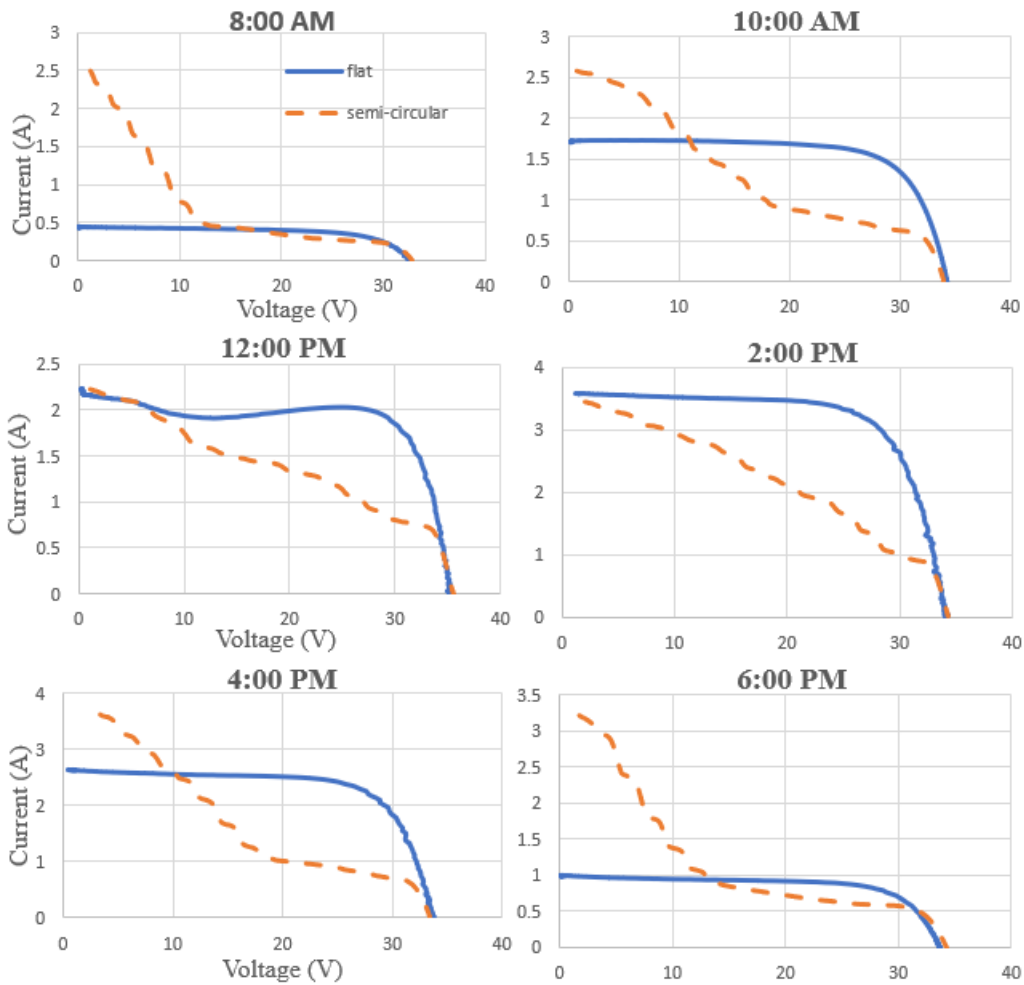

Figure 5.3: Current-voltage curves of flat and semi-circular panels during a sunny day.

In Figure 5.4 is illustrated the power-voltage curves of the flat and semi-circular panels at the same moments as the previous Figure 5.3. The flat panel (solid line) has a curve with one peak of power, and the peak increases with the irradiance received by the panel. The semi-circular panel (dashed line) has not a marked peak, it has a section with more or less constant power or with several small peaks. As it is possible to see in Figure 5.4 at 8:00 AM or before, panels produce around 10W or less. In the morning hours before 8:00 AM or in the afternoon hours after 6:00 PM, the curved panel produces more power than the flat one. However, in the midday hours the flat power produces more power. For instance, at 2:00 PM the flat panel produces a peak of power of 86W, and the curved panel has a MPP of 43W. Namely, at 2:00 PM the power produced by the semi-circular panel is the half of the power produced by the flat panel.

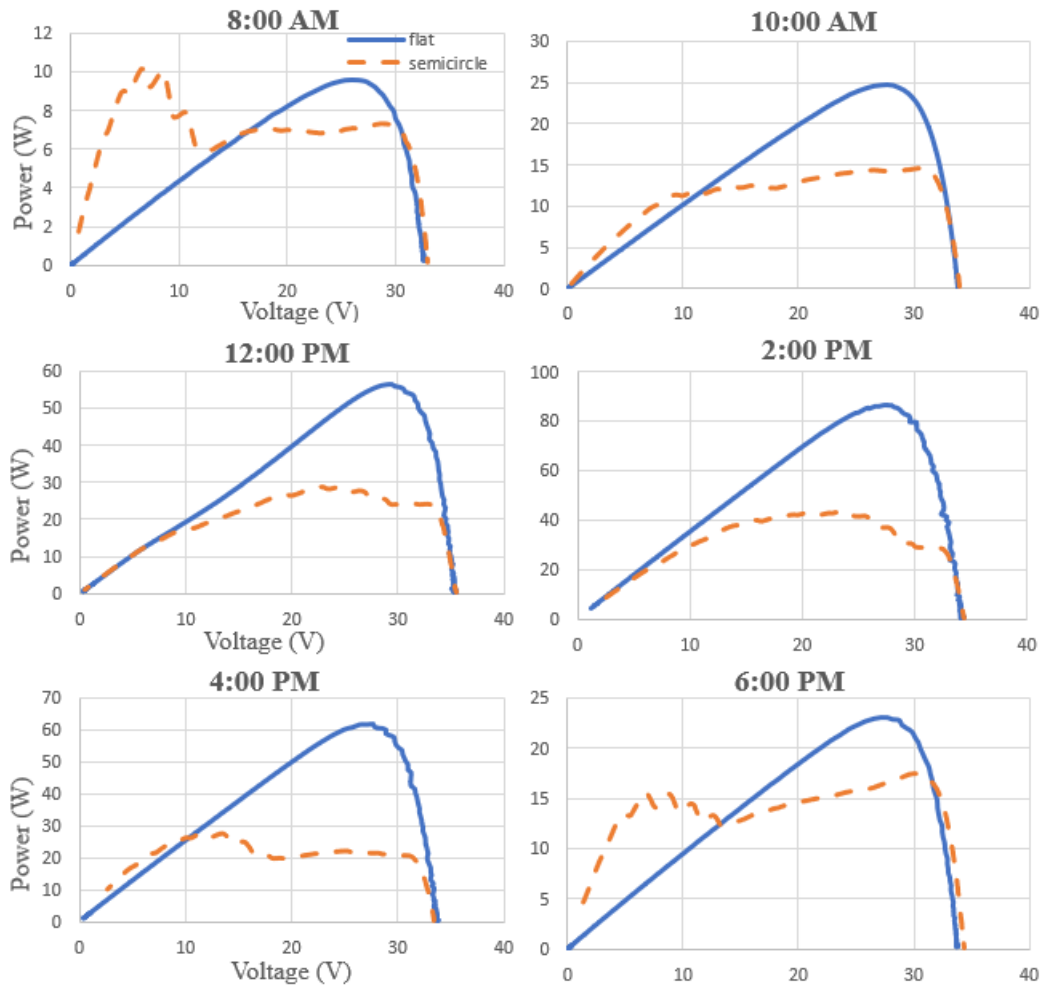

Figure 5.4: Power-voltage curves of flat and semi-circular panels during a sunny day.

The next figure shows the evolution of the current-voltage curves in an overcast day, it may appear different values if there are more or fewer clouds in the time of the measurement. It should be noted that in the next image the curves have a bit of noise as the measurement device does not have a filter, as has been explained before in this section.

Figure 5.5 shows that on cloudy days the curves of the flat and semi-circular panels are very similar. This is because with the clouds the direct irradiance is reduced, and the irradiance is more diffuse. Thus, it is not so important whether the cells are well oriented with the sun or not. In other words, all cells receive the same irradiation regardless of how they are oriented.

It is worth noting that the power produced during a cloudy day is the same in both panels, but the amount of energy is much lower than on sunny days.

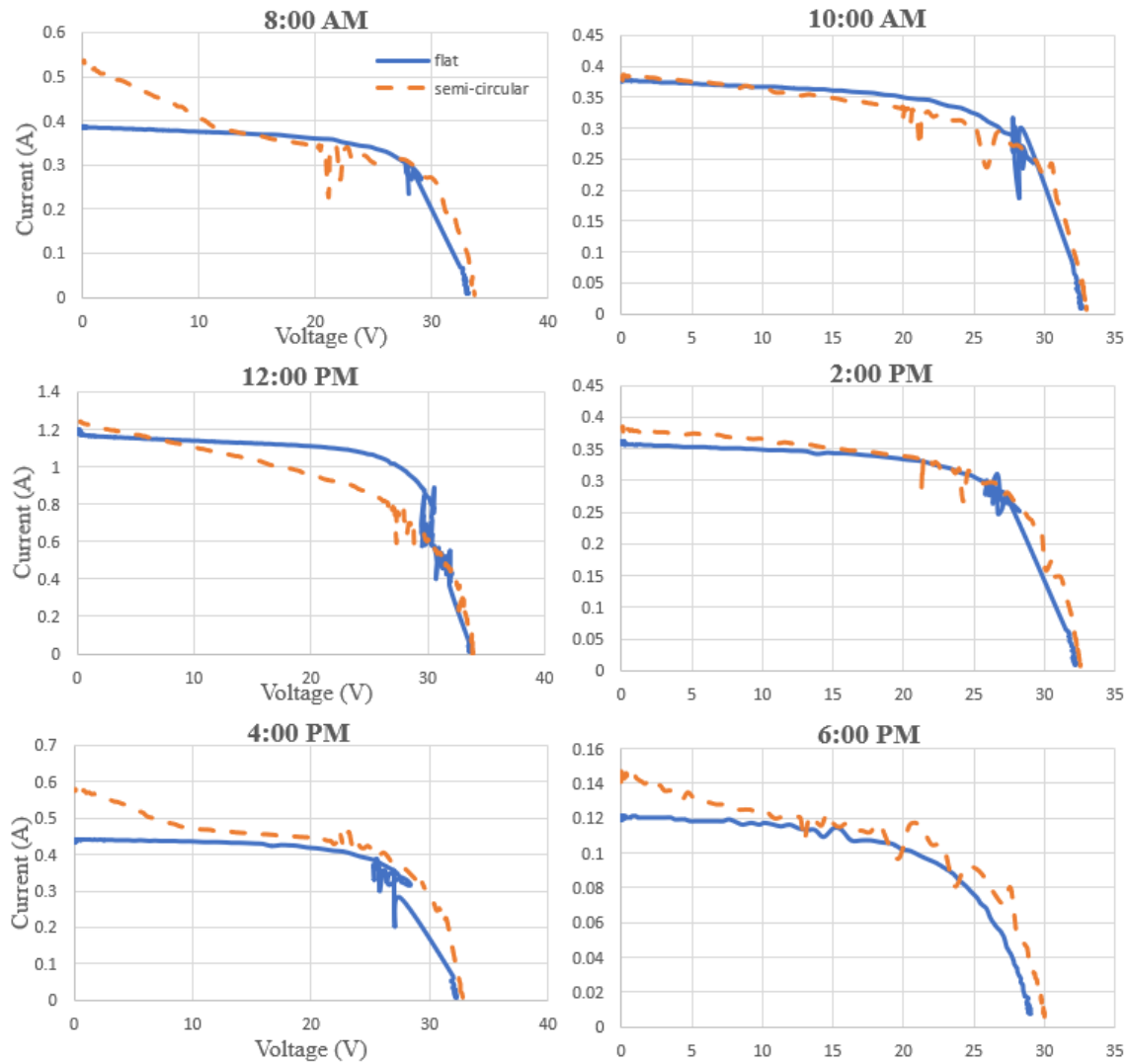

Figure 5.5: Current-voltage curves of a flat and semi-circular panels in an overcast day.

It must be taken into account that these tests have been performed during the month of May. In May, there are more hours of sun, and the Sun has a larger path in the sky than in other months of the year. This fact may be favourable for the curved panel in the summer months. On the contrary, in the winter month when the Sun has a shorter path in the sky, the difference in power production between the flat and the curve panels may be bigger than in the summer months.

Finally, the data of power produced by the panels in two days has been obtained in the long-term tests. During these two days, there were hours with more sun and hours with more clouds.

As is possible to see in Table 5.1, on the first day the flat panel produces 251.4Wh while the curved panel produces 187.8Wh. Namely, with the same irradiance, the flat panel produces 25.3% more energy. On the second day, the flat panel produces 410.1Wh and the semi-circular panel 243Wh. That is, the flat panel produces 40.7% more energy with

the same irradiance. It is feasible to say that during sunny days when the panels produce more energy, there is more difference between the energy produced by the flat panel and the energy produced by the curved panel.

First day	7	8	9	10	11	12	13	14	15	16	17	18	19	20	TOTAL(Wh)
Flat panel (W)	4.3	8.6	15.8	39.3	31.4	33.2	9.7	21.2	48.8	16.0	9.4	5.6	6.1	1.9	251.4
Curved panel (W)	4.7	8.7	12.0	24.1	22.8	22.7	10.2	16.7	29.5	13.7	7.6	5.3	7.4	2.3	187.8
Second day															
Flat panel (W)	5.8	13.3	13.9	41.4	41.0	24.2	51.3	69.9	58.7	42.2	28.2	12.0	5.8	2.6	410.1
Curved panel (W)	6.5	12.5	10.7	20.2	23.1	18.3	32.8	35.2	28.9	20.1	15.7	9.9	6.2	3.0	243.0

Table 5.1: Measures of power production with the flat and semi-circle panels in two days of May.

5.2. Test of both panels connected in series

This test is a short-term test in which the flat and semi-circular panels are tested in a sunny period then the panels are connected in series and tested both together. The change of connections takes place in 1 minute and there are no clouds, thus it is possible to consider that in both measures the panels have the same irradiance.

In Figure 5.6, it is possible to see the curves of the flat and curved panels that follow the same shapes as described above in Section 5.1. Moreover, there is the curve of the connection of both panels. This curve has a V_{OC} equal to 67V is the sum of the V_{OC} of the two panels. Otherwise, it has a I_{SC} equal to 2A, smaller than the I_{SC} of the semi-circular panel and higher than the I_{SC} of the flat panel. The curve of both panels connected shows that in the range of high voltage (40-67V), the shape of the curve is equal to the shape of the curve of the semi-circular panel. This is due to in this range the current is limited by the semi-circular panel since the current is lower in the curved panel. In addition, in the range of 4 to 40V the curve of both panels connected in series follows the same shape as the curve of the flat panel. This is due to in this range the current is limited by the flat panel since the current is lower in the flat panel.

As it has been explained in Section 2.4. and in Section 2.5. two panels connected in series add its V_{OC} and the current is limited by the panel which has less current.

Figure 5.7 illustrates the power-voltage curves of the panels. In this figure is possible to see how the curves of both panels are added in order to form the curve of both panels connected in series. In the same way, the MPP of both panels connected in series is almost the same as the sum of the MPPs of each panel.

It may be interesting for the next test to make the same test but with bypass diodes in parallel with each panel. It would be possible to see the differences produced by the bypass diodes in panels connected in series.

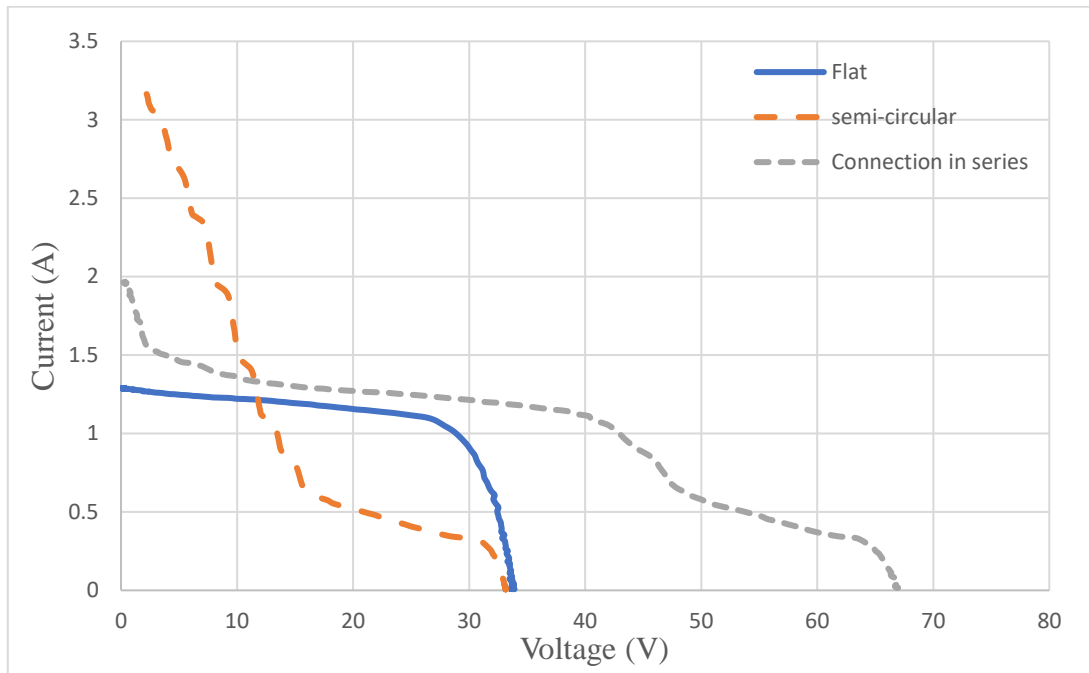

Figure 5.6: Current-voltage curves of flat and semi-circular panels and both panels connected in series.

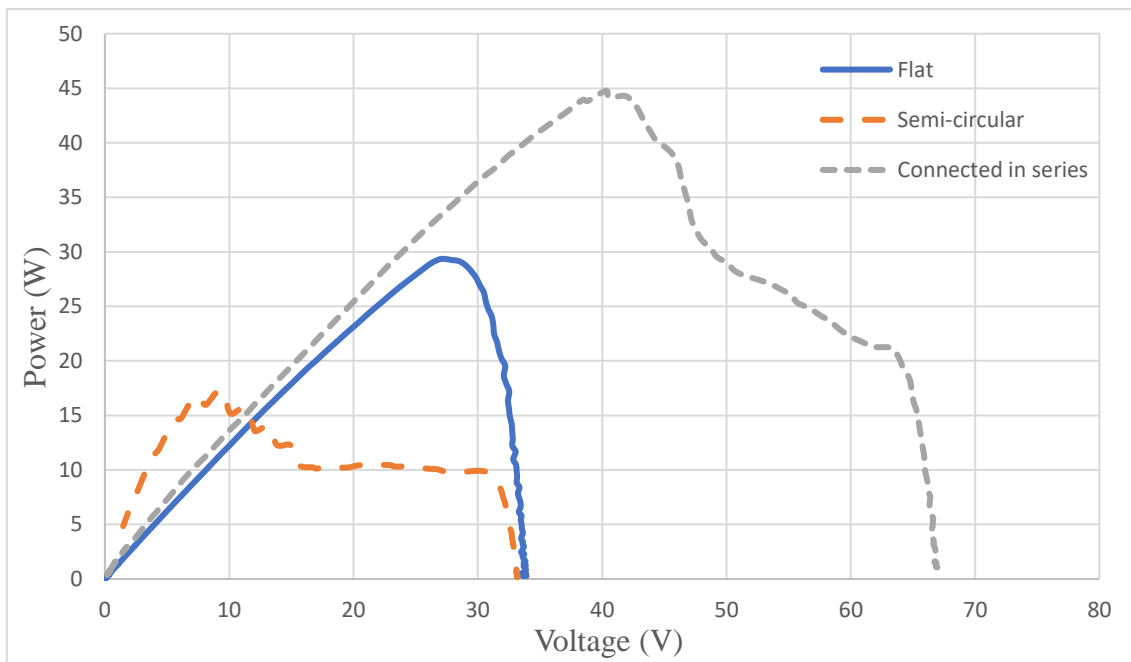

Figure 5.7: Power-voltage curves of flat and semi-circular panels and both panels connected in series.

6. Conclusion

This thesis concludes that the semicircle geometry has different current-voltage curves in different parts of the day, depending on the orientation of the cells with the sun and the shaded cells. Moreover, the semi-circular panel has an important decrease in power produced in comparison with the power produced by the flat panel. Therefore, it is better to use these panels in another geometry than the semi-circular one to cover the surface since it would not be the most profitable.

It should be noted that these tests are performed during the month of May. Consequently, to have a more accurate results about the performance of the panels during the hole year, the tests should be carried out in other parts of the year. Because the path of the Sun in the sky and the hours of sunshine changes a lot in Norway during the year.

The electronic device constructed to perform the tests can be used with more PV panels. Besides, these devices can be used to test different electric devices like batteries.

This thesis is only the start of a project to test the CIGS flexible PV panels in different geometries. It is only tested the semi-circle geometry and compared it with the flat one. However, there are much more geometries that can be used in many real-world applications, which can be tested in future works to know its performance. The construction of the adaptable support designed in this thesis is interesting to allow the PV panels to assume the different geometries to enable performance testing.

Apart from the tests with different geometries, test with MPPTs or fixed loads may be carried out. Also, it may be interesting to measure the performance of panels connected in series or in parallel with different geometries and using or not bypass diodes between the panels.

References

- [1] Asea Brown Boveri, Cuaderno de aplicaciones técnicas n.º10 Plantas fotovoltaicas, Barcelona: ABB, 2011.
- [2] O. Isabella, «edX DelftX PV3x Solar Energy: Photovoltaic (PV) Systems,» edX DelftX, 26 April 2018. [En línea]. Available: <https://learning.edx.org/course/course-v1:DelftX+PV3x+1T2020/home#block-v1:DelftX+PV3x+1T2020+type@chapter+block@00e08638454847a39025fbabfc8ecb30>.
- [3] D. Atsu, «Journal of natural resources and development,» 1 12 2019. [En línea]. Available: <https://www.jnrd.info/2019/12/10-5027-jnrd-v9i0-06/>.
- [4] Y. Wang, Y. Yang, G. Fang, B. Zhang y H. Wen, «MPDI,» 27 10 2018. [En línea]. Available: <https://www.mdpi.com/2079-9292/7/12/355/htm>.
- [5] R. Vasudevan, «DelftX PV3x Solar Energy: Photovoltaic (PV) Systems,» DelftX PV3x, 26 10 2017. [En línea]. Available: <https://learning.edx.org/course/course-v1:DelftX+PV3x+1T2020/home>.
- [6] A. Smets, K. Jäger, M. Zeman, O. Isabella y R. Van swaaij, Solar Energy: The Physics and Engineering of Photovoltaic Conversion, Technologies and Systems, Cambridge: UIT Cambridge, 2016.
- [7] SMA, «OptiTrac Global Peak,» SMA Solar Technology AG, 2017. [En línea]. Available: <https://www.sma.de/en/partners/knowledgebase/optitrac-global-peak.html>.
- [8] G. M Wilson, M. Al-Jassim, W. K Metzeger, S. W Glunz, P. Verlinden y G. Xiong, «The 2020 photovoltaic technologies,» *Journal of Physics D: Applied Physics*, p. 47, 9 9 2020.
- [9] A. Woyte, M. Richeter, D. Moser, N. Reich, M. Green, S. Mau y H. G. Beyer, «Analytical Monitoring of Grid-connected Photovoltaic Systems Good Practices for Monitoring and Performance Analysis,» INTERNATIONAL ENERGY AGENCY, Brussels, 2014.
- [10] MiaSolé, «MiaSolé,» 2017. [En línea]. Available: <http://miasole.com/products/>.

List of figures

Figure 1.1: Flexible PV panels in solar lab, HVL.	2
Figure 2.1: Types of irradiation.....	3
Figure 2.2: Cell, module, panel and array [2].....	4
Figure 2.3: Current, Voltage and power curves of a cell (adapted from [3]).	5
Figure 2.4: Effects of variations in (a) irradiance and (b) temperature [4].	5
Figure 2.5: Cells in parallel and series [2].....	6
Figure 2.6: Two cells in series with one of them partially shaded.	7
Figure 2.7: Effects of bypass diodes (A) two cells with bypass diodes in series with a load and (B) curve of one cell with and without bypass diode.....	7
Figure 2.8: Curves of 6 cells connected in series [2].....	8
Figure 2.9: Fixed load connected to a PV panel with variable irradiance [5].	9
Figure 2.10: Variable resistance connected to a PV panel.	9
Figure 2.11: Curves of current-voltage (blue) and power-voltage (red).	10
Figure 3.1: CIGS flexible panels.	12
Figure 3.2: Curved and flat panels connected to the loads.....	14
Figure 3.3: Curved and flat supports.	16
Figure 3.4: Control circuit diagram.	17
Figure 3.5: Control circuit device.....	17
Figure 4.1: Examples of buildings with circumference geometries: toilet, bus stop and advertisements column.	18
Figure 4.2: Examples of Buildings with wavy geometries.....	19
Figure 4.3: A) plate, B) ball and socket joints, C) small supports, and D) supports fixed to the structure with nuts and spring washers.....	20
Figure 4.4: A) flat panel, B) panel with one undulation, C) panel twisted, and D) panel with two undulations.	20
Figure 4.5: Scaffolding tubes and swivel couplings.....	21
Figure 4.6: Support views.....	22
Figure 4.7: angle changes in the support horizontally.....	22
Figure 4.8: Angle changes in the support vertically.....	23
Figure 5.1: Current-voltage curve of flat and semi-circular panels.....	25
Figure 5.2: Power-voltage curve of flat and semi-circular panels.....	25
Figure 5.3: Current-voltage curves of flat and semi-circular panels during a sunny day.	27
Figure 5.4: Power-voltage curves of flat and semi-circular panels during a sunny day.	28
Figure 5.5: Current-voltage curves of a flat and semi-circular panels in an overcast day.	29

Figure 5.6: Current-voltage curves of flat and semi-circular panels and both panels connected in series..... 31

Figure 5.7: Power-voltage curves of flat and semi-circular panels and both panels connected in series..... 31

Figure A1.0.1: Datasheet of MOSFET IXFN200N10P. 36

Figure A2.1: Front panel, program LabVIEW. 37

Figure A2.2: Block diagram, program LabVIEW first part. 38

Attachment 1

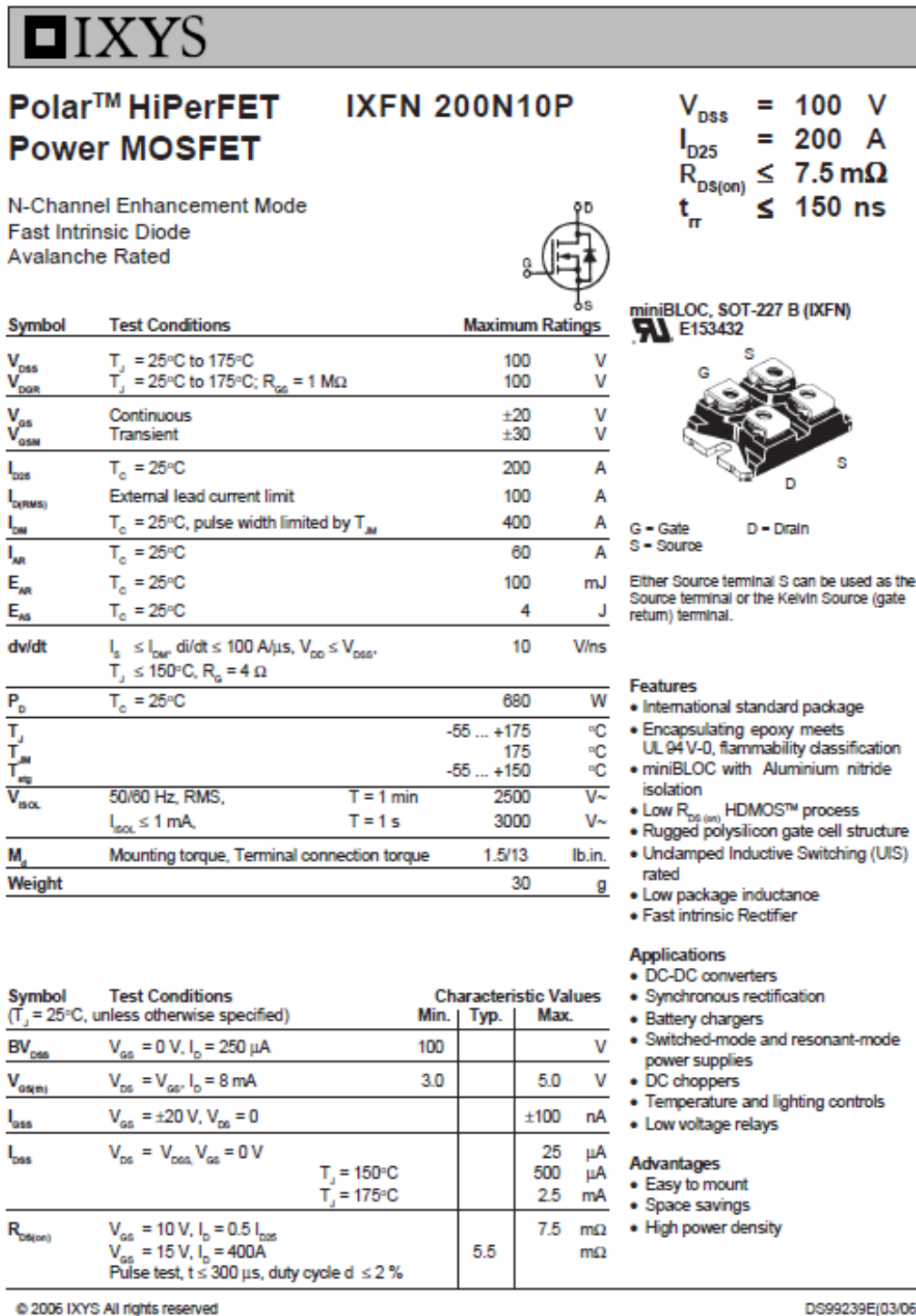

Figure A1.0.1: Datasheet of MOSFET IXFN200N10P.

Attachment 2

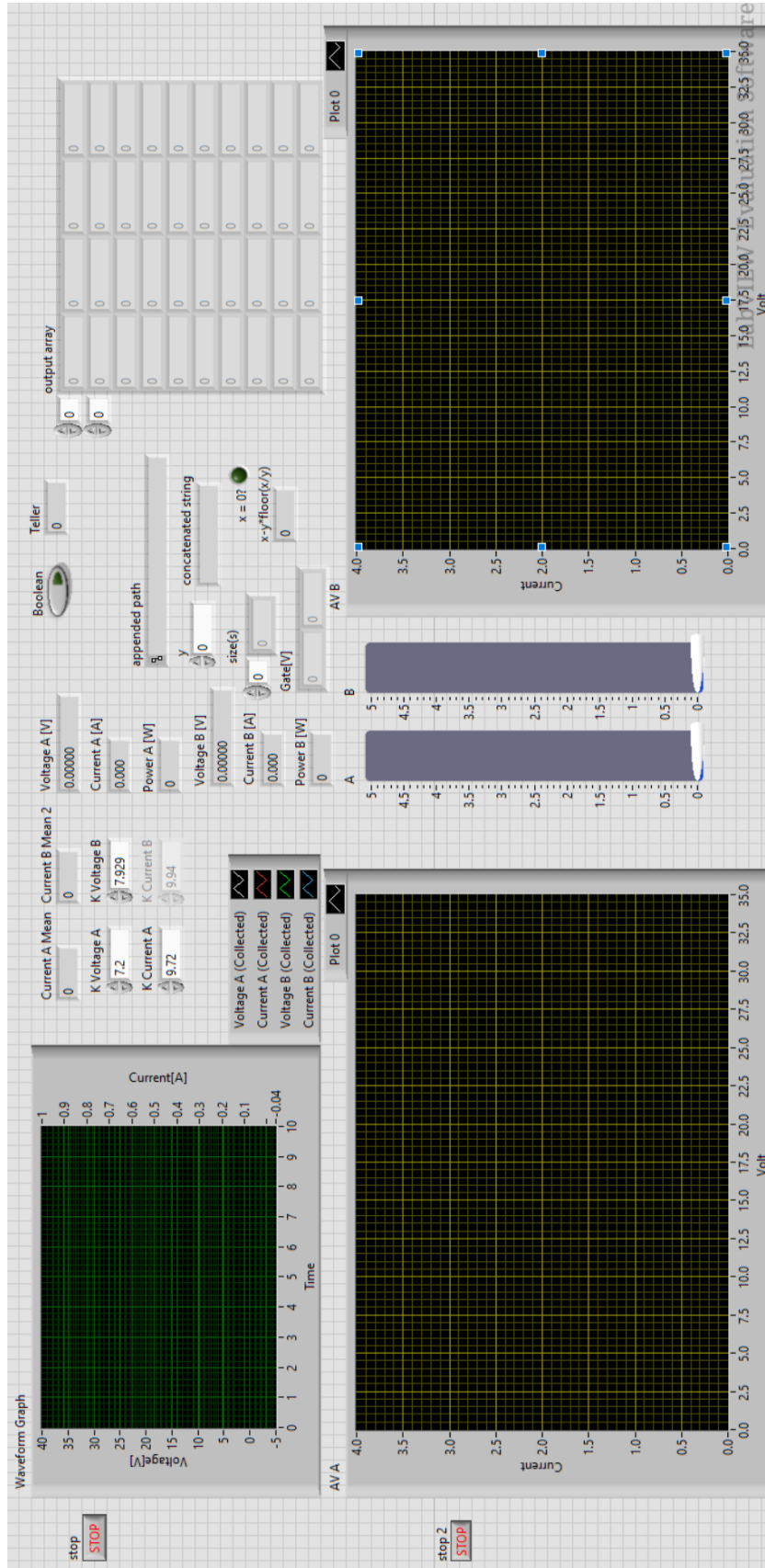
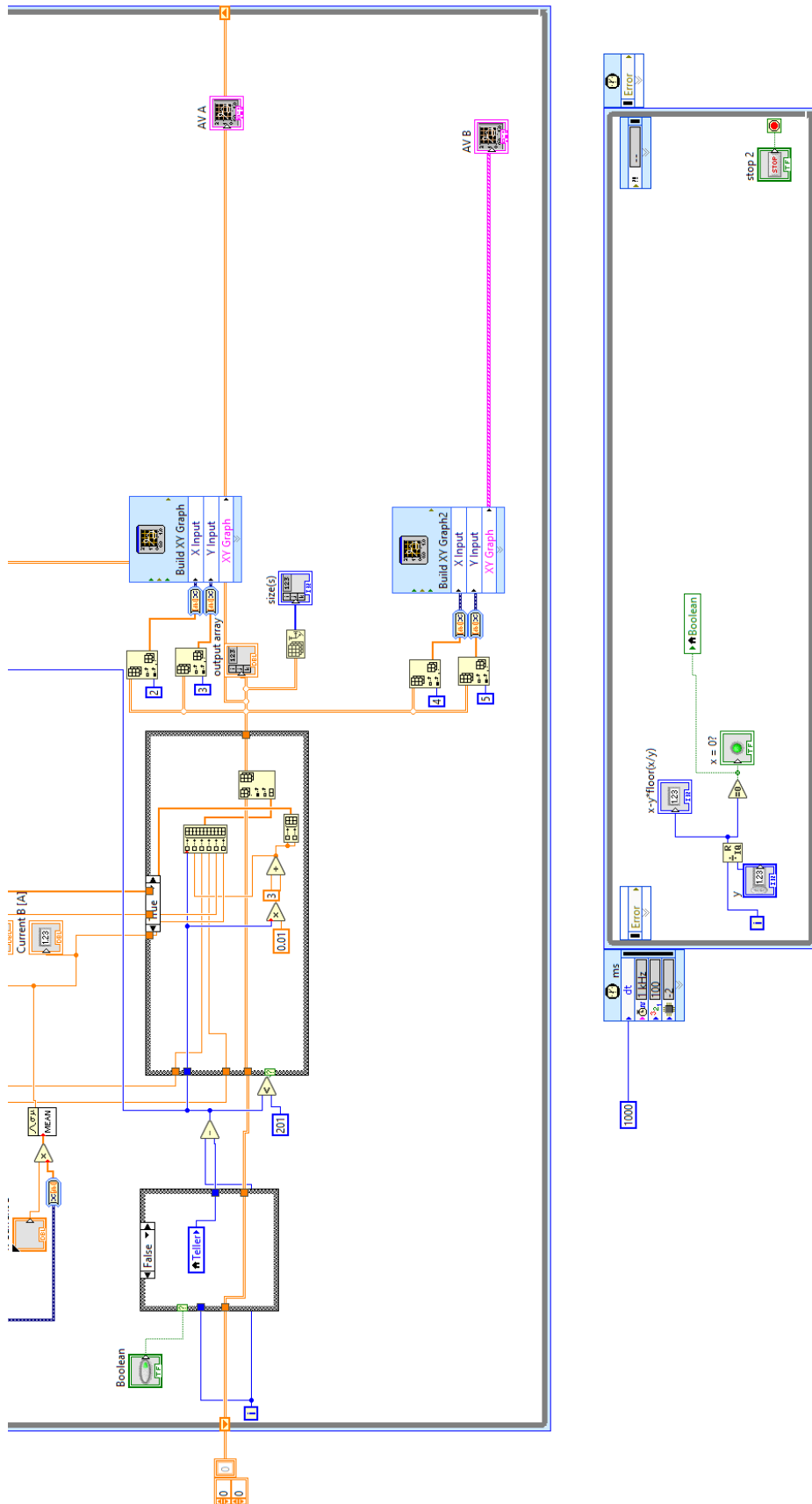

Figure A2.1: Front panel, program LabVIEW.



LabVIEW™ Evolution Coherent

Figure A2.3: Block diagram, program LabVIEW second part.

Attachment 3

Units	Description	Material
4	Tubes 3000mm, dim.48,25mm	Aluminium
6	Tubes 1500mm, dim.48,25mm	Aluminium
2	Tubes 800mm, dim.48,25mm	Aluminium
1	Tubes 500mm, dim.48,25mm	Aluminium
18	Swivel couplings	Zinc plated steel
28	Threaded bars M6, 1m length	Zinc plated steel
56	Nuts M6	Stainless steel
56	Spring washers M6	Stainless steel
28	Ball and socket joins M6	Zinc plated steel
14	Plates 500x80x3mm	Aluminium
1	10,4m adhesive tapes 'Velcro'	-

Table A3.1: Materials for the construction of an adaptable support.

