

# Optimized Design of Comblines Filters with Transmission Zeros

Jose Joaquin Vague Cardona, Javier Ossorio Garcia, Santiago Cogollos, Vicente E. Boria, Fellow, IEEE, and Marco Guglielmi, Fellow, IEEE

*Abstract*—The objective of this paper is to demonstrate how inline combline filters can be designed to implement transmission zeros in the filter transfer function. Following the design procedure described in this paper, up to  $N-1$  transmission zeros can be implemented with a filter of order  $N$ . In addition to theory, comparisons between simulated and measured results are also presented. The agreement between simulation and measurements is indeed good, thereby fully validating the new combline filter topology, and the proposed design technique.

*Index Terms*—Comblines filters, transmission zeros, elliptic, high selectivity

## I. INTRODUCTION

The most common implementations for microwave filters in the 1 to 3 GHz frequency range are based on the combline, interdigital, or re-entrant coaxial technologies with coaxial excitation. These filter technologies have been known for a very long time, and their design is now well established ([1] to [7]). Of particular importance is the possibility of implementing transmission zeros (TZs) in the filter transfer functions by introducing cross-couplings between non adjacent resonators. It is in fact, well known [8], that groups of three (triplets), or four (quadruplets) cross-coupled resonators can be used to implement single, or pairs of TZs, respectively. This is indeed one of the most popular technologies for manufacturing (relatively) low cost, high performance microwave filters. The only drawback of arranging coaxial resonators in triplets or quadruplets is the relatively large footprint of the final hardware. Significantly more compact implementations could result if one could implement TZs with in-line configurations.

This issue has been first addressed in [9], where it is shown how one or two TZs can indeed be implemented using inline combline technology. Other contributions can also be found where the TZs are implemented with in-line structures where adjacent resonators are turned ninety degrees, so that cross coupling can take place between non adjacent resonators [10], [11]. Finally, one more contribution can be found where both capacitive and inductive couplings between resonators are exploited to introduce TZs both above and below the filter passband [12].

In this context, therefore, the objective of this paper is to give a contribution to the state-of-the-art of planar combline filters, showing how a much simpler solution than the one discussed in [12] can effectively be used to introduce transmission zeros both above and below the filter passband. In addition to theory, measured results are also presented. The measured results are shown to be in good agreement with the simulations thereby fully validating the new filter topology.

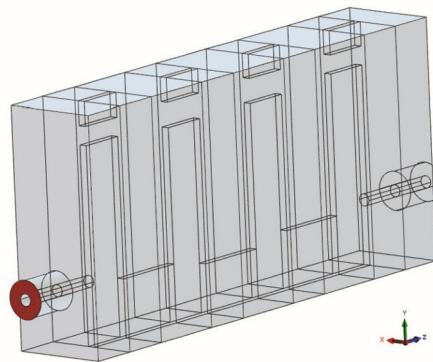

Fig. 1. Basic four pole interdigital filter in low cost planar technology.

## II. BASIC FILTER

The basic filter topology that we use in this paper is the planar, low-cost four-pole combline filter structure shown in Fig. 1. It is important to note, however, that the results obtained are fully applicable also to standard combline filter implementations, based on circular or square metallic posts. The filter design procedure that we have used to obtain the final dimensions of the structure is the one described in [13]. The reference filter used in the design procedure has been a standard four-pole filter in WR229 rectangular waveguide. Fig. 2 shows the superimposed results of the simulations, obtained with FEST3D (v. 2018 from Aurorasat, now with Dassault Systèmes), and the measurements for the filter shown in Fig. 1. One interesting feature of the structure shown in Fig. 1 is that the coupling between resonators is implemented with a length of ridge waveguide that is below cutoff at the frequency of operation. The below cutoff length of ridge waveguide behaves essentially as a series inductance connecting one resonator to the next one. The coupling between resonators can then be easily adjusted by keeping the length constant, and changing the height of the ridge. The higher the ridge, the smaller the series inductance, thus resulting in a stronger coupling.

## III. IMPLEMENTING TRANSMISSION ZEROS

One additional feature that is of interest in the filter performance in Fig. 1, is the presence of a deep rejection valley just before 5.5 GHz. It is indeed the observation of this behaviour

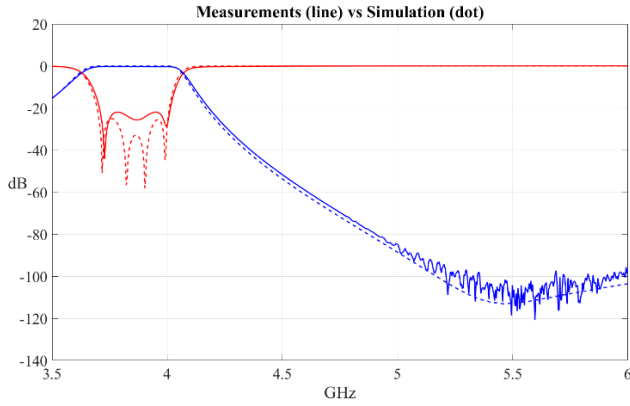

Fig. 2. Comparison between measurements (plot in continuous line) and FEST3D simulations of the filter shown in Fig. 1.

that is at the origin of the research work described in this paper.

To find an explanation for this deep rejection, we recall that the coupling between combline resonators can indeed have both an inductive and a capacitive component [14]. In particular, in the structure in Fig. 1, the inductive component is implemented with the length of ridge waveguide, and the capacitive component could be implemented by the natural capacitive coupling between the upper end of the combline resonators, where the electric field is more intense. This situation could indeed be represented with the equivalent LC circuit shown in Fig. 3, for the case of a simple two pole filter network. The series resonator composed by C2 and L2 could indeed be responsible for the implementation of a transmission zero (TZ) in the two pole filter transfer function.

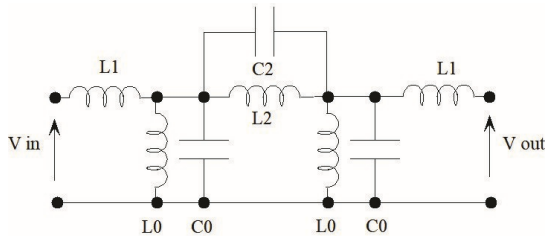

Fig. 3. Two pole filter with a resonant inter resonator coupling.

In the filter in Fig. 1, the inter resonator coupling is implemented with a fixed length of ridge waveguide. This length establishes the distance between the ends of the resonators and could therefore be used to control the capacitive component of the inter resonator coupling. The quantity that controls the inductive coupling is, as already mentioned, the height of the ridge. In practice, therefore, if our interpretation is correct, we should be able to implement clearly visible TZs by simply acting, at the same time, on both the height and the length of the ridge waveguide section.

#### IV. EXPERIMENTAL VERIFICATION

To verify the discussion of the previous section, we have designed a four pole filter where both the height and the length of the ridge waveguide sections have been used as variable

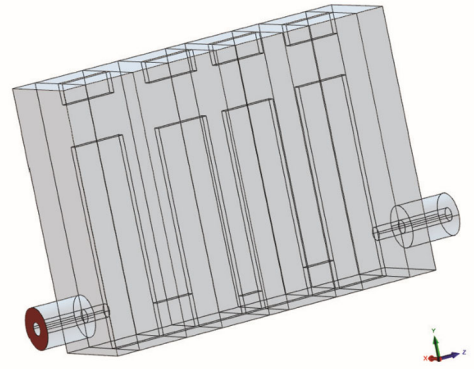

Fig. 4. Four pole filter with clearly visible TZs.

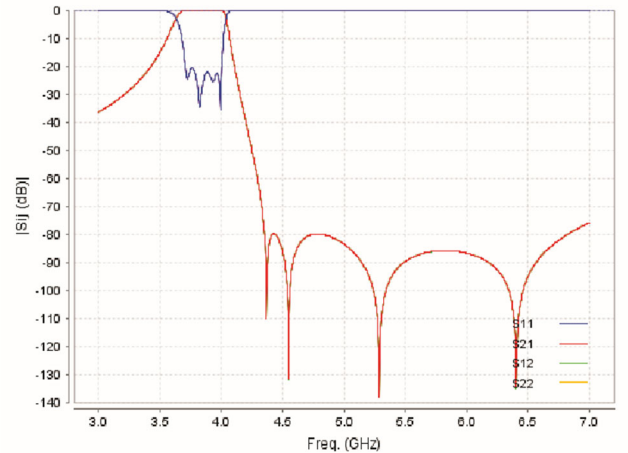

Fig. 5. Four pole filter with both inductive and capacitive inter resonator couplings.

parameters in the design process. Fig. 4 shows the structure of the filter, and Fig. 5 shows the response of the filter simulated with FEST3D.

As we can see, the filter performance now clearly shows a number of TZs in the upper rejection band. Our investigations indicate that the first two TZs after the passband are due to the 1-2 and 3-4 inter resonator couplings. The third TZ, between 5.0 and 5.5 GHz is due to the 2-3 inter resonator coupling. The remaining TZ, near 6.5 GHz, is due to the coupling from input to output. The physical mechanism of this coupling will be explained in detail during the talk.

As an experimental verification, we have manufactured the low cost filter prototype shown in Fig. 6. Fig. 7 shows the comparison between the FEST3D simulations and the measurements.

As we can see, the return losses of the filter are affected by the manufacturing accuracy, but the in-band filter performance is essentially correct. On the other hand, simulation and experimental results are in very good agreement with respect to the four TZs, providing a rejection in the relevant band of about -80dB.

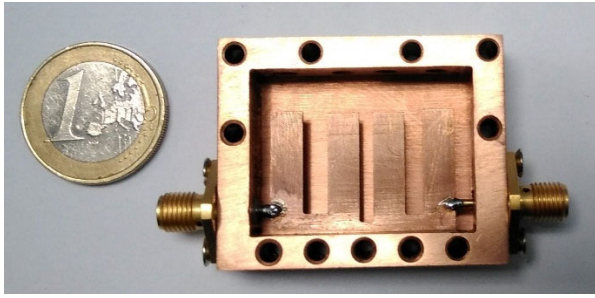

Fig. 6. Implementation of the filter in Fig. 4.

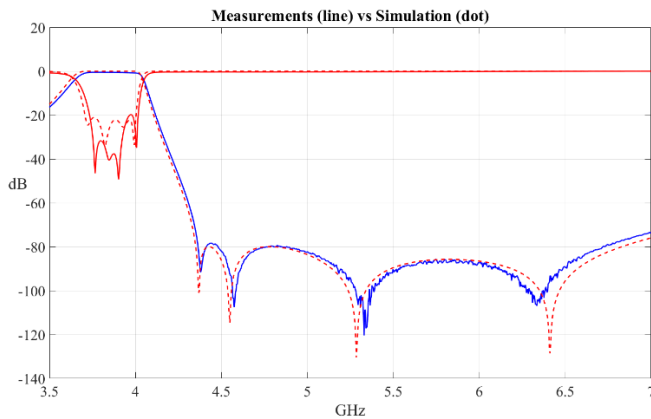

Fig. 7. Measured and simulated performance of the filter in Fig. 6.

## V. CONCLUSIONS

In this paper we have given a contribution to the state-of-the-art of combline filters by showing how, with a simple modification of the basic filter structure,  $N-1$  transmission zeros can be easily implemented with a filter of order  $N$ . The presence of the transmission zeros is explained in terms of the simultaneous inductive and capacitive nature of the inter resonator coupling that can be produced by introducing a simple modification in the basic filter structure. In addition to theory, experimental verification is also provided, showing very good agreement between simulations and measurement, thereby fully validates the theoretical discussions. In the talk, further details will be given with respect to the filter design procedure needed to place the TZs at the desired frequency. A number of further application examples will be also discussed. Finally, it is important to note that improved performance demonstrated in this paper in the context of low cost, planar combline filters is fully applicable also to standard combline filters.

## REFERENCES

- [1] G. Matthaei, "Interdigital Band-Pass Filters", *IRE Transaction on Microwave Theory and Techniques*, November 1962, pp. 479-491.
- [2] R.M. Kurzrok, "Design of Comb-Line Band-Pass Filters", *IEEE Transactions on Microwave Theory and Techniques*, July 1966, pp. 351-353.
- [3] J.D. Rhodes, "The Stepped Digital Elliptic Filters", *IEEE Transactions on Microwave Theory and Techniques*, vol. MTT-17, No 4, April 1969, pp. 178-184.
- [4] J.D. Rhodes, "The Theory of Generalized Interdigital Networks", *IEEE Transactions on Circuit Theory*, vol. CT-16, No 3, August 1969, pp. 280-288.

- [5] R. Levy and J.D. Rhodes, "A Comb Line Elliptic Filter", *IEEE Transactions on Microwave Theory and Techniques*, vol. MTT-19, No 1, January 1971, pp. 26-29.
- [6] R.J. Wenzel, "Synthesis of Combline and Capacitively Loaded Interdigital Bandpass Filters of Arbitrary Bandwidth", *IEEE Transactions on Microwave Theory and Techniques*, vol. MTT-19, NO 8, August 1971, pp. 678-687.
- [7] I.H. Zabalawi, "Design of Linear Phase Selective Comb-Line Filter", *IEEE Transactions on Microwave Theory and Techniques*, vol. MTT-30, No 8, August 1982, pp. 1224-1229.
- [8] J.B. Thomas, "Cross-coupling in coaxial cavity filters - a tutorial overview", *IEEE Transactions on Microwave Theory and Techniques*, vol. 51, Issue: 4, April 2003, pp. 1368 - 1376.
- [9] G. Macchiarella, M. Fumagalli, "Inline comb filters with one or two transmission zeros", *IEEE MTT-S International Microwave Symposium Digest*, vol. 2, October 2004, pp. 1085 - 1088.
- [10] Y. Wang, M. Yu, "Inline realization of cascaded trisection and cascaded quadruplet in coaxial cavity filters", *Proceedings of the 2009 European Microwave Conference (EuMC)*, October 2009, pp. 448 - 451.
- [11] M. Hoft, F. Yousif, "Orthogonal Coaxial Cavity Filters With Distributed Cross-Coupling", *IEEE Microwave and Wireless Components Letters*, vol. 21, Issue: 10, August 2011, pp. 519 - 521.
- [12] H. Wang, Q.X. Chu, "An Inline Coaxial Quasi-Elliptic Filter With Controllable Mixed Electric and Magnetic Coupling", *IEEE Transactions on Microwave Theory and Techniques*, vol. 57, Issue: 3, February 2009, pp. 667 - 673.
- [13] M. Guglielmi, A. Alvarez Melcon, "Novel design procedure for microwave filters", *Proceedings of the 23rd European Microwave Conference*, September 1993, pp. 212 - 213.
- [14] H.W. Yao, K.A. Zaki, A.E. Atia, R. Hershtig, "Generalized slot coupled combline filters", *Proceedings IEEE MTT-S International*, May 1995, pp. 395 - 398.