

Internet of Underground Things ESP8266 WiFi Coverage Study

Laura García, Lorena Parra, Jose M. Jimenez, Jaime Lloret

Integrated Management Coastal Research Institute
Universitat Politècnica de València
Valencia, Spain

email: laugarg2@teleco.upv.es, loparbo@doctor.upv.es,
jojher@dcom.upv.es, jlloret@dcom.upv.es

Abdelhafid Abouaissa, Pascal Lorenz

Network and Telecommunication Research Group
University of Haute Alsace
Colmar, France

email: abdelhafid.abouaissa@uha.fr, lorenz@ieee.org

Abstract— The Internet of Underground Things (IoUT) is a novel concept regarding Internet of Things (IoT). It could have countless applications, particularly in agriculture as buried devices do not interfere with the machinery. Furthermore, wireless communication among buried and above ground devices would allow a significant cost reduction as wires would not need to be deployed and wires would not be destroyed by machinery or impede the correct performance of the activities performed by the workers of the field. In this paper, we perform a WiFi coverage study of ESP8266 nodes placed both underground and above ground so as to assess the current lack of knowledge in IoUT and the performance of low-cost controller boards for IoUT applications. Tests were performed with ESP8266 nodes buried at depths of 10 cm, 20 cm, 30 cm and 40 cm in a field located in an area of citrus fields. A node programmed as an AP (Access Point) was placed at several distances at a height of 50 cm. Results showed that the coverage was better for the node buried at a depth of 20 cm.

Keywords- IoUT; WiFi; coverage; ESP8266; agriculture

I. INTRODUCTION

The forecasts of the increase of the population of the world [1] leads to taking new and better solutions in agriculture. In these forecasts, it is estimated that 70% more food than the food produced nowadays will have to be cultivated and manufactured by 2050. This makes agriculture become one of the key sectors of the global economy. It is necessary to achieve greater efficiency, in order to be able to supply the entire population and optimize the consumption of resources, such as irrigation water, fertilizers or pesticides.

A greater efficiency can be achieved by applying new technologies in crops. Using sensors, farmers obtain information on different parameters related to their crops and help them in making decisions [2]. The application of these new technologies in crops brings with it a significant reduction in production costs and an increase in the quality of the products. In addition, farmers may need to spend less time physically present in the crop fields, being able to obtain the crucial information that will allow them to perform data analysis in real time. This will ultimately improve the quality of life of people and the productivity of their businesses. Initially, the tendency is that, due to the need for a return on investment, the products that reach a

higher price in the market will be the ones that will be subject to a greater investment in technology.

The IoT technology has a fundamental role. Its application in multiple areas makes it possible to adopt the most appropriate solutions to different problems. There are a lot of studies on the application of IoT in different environments. For example, the authors [3] presented a study of the most used IoT technologies in Smart Cities. Agriculture is one of the areas in which this technology is increasingly implemented. For example, if environmental and crop health parameters are controlled, the use of both water resources and pesticides can be avoided, which will reduce the impact on the environment. This is what we usually call precision agriculture.

The transmission of the data obtained by the sensors located in the crop fields, is usually done using wireless technologies, such as IEEE 802.11, Bluetooth, ZigBee, LoRa, 3G, 4G or 5G. Devices usually have a low energy consumption which usually has as a characteristic a low transmission range associated with it. That is partially due to the difficulty in being able to provide a constant energy supply, except if it is done by battery systems that are usually recharged by means of green technologies, such as solar panels.

In the space of IoT applied to agriculture, we can highlight for its novelty the studies presented in the IoUT. In this case, IoT devices are partially or totally buried for monitoring and detection in real time. In its application to agriculture, underground sensors are used, which control different systems, both irrigation and machinery, to help farmers and agronomists in making decisions. By using buried sensors, we can control crop parameters, such as soil temperature and humidity, more efficiently than with the parameters that are only estimated on surface. Furthermore, due to the underground location of the nodes, there are major problems when working with machinery in their environment, because they can be unused or destroyed.

Our proposal presents the study of the transmission between underground and above ground ESP8622 nodes. The study is carried out due to the lack of previous studies related to IoUT regarding its location in crops. We have studied the signal in a low-vegetation area surrounded by citrus fields. We have buried several nodes at different depths, and we have observed the degradation of the signal

as a function of the separation of the emitting and receiving nodes, both in distance and in depth.

The rest of the paper is organized as follows. Section 2 presents the related work. The proposed architecture is presented in Section 3. The testbed description is depicted in Section 4. The results are discussed in Section 5. Section 6 depicts the mathematical model. Finally, the conclusion and future work is presented in Section 7.

II. RELATED WORK

The IoUT is quite the recent concept, thus few papers exist on this topic. Several of them are surveys, such as the survey on the state of the art on the Internet of Underground Things performed by Vuran et al. [4]. The authors determined the different components of an IoUT architecture as Underground Things for sensors and embedded systems deployed underground, mobile sinks that gather the data from underground things, base stations that act as a gateway and cloud services that provide storage and data processing. The communication among the elements of a IoUT architecture can be between underground things or between underground and above ground things. Soil moisture and texture and variations in distance and depth influence on the quality of the communications. Furthermore, Leles et al. [5] presented a summary of the challenges of IoUT for railways networks. The authors performed a coverage test in a tunnel where signal intensities of -55 dB were reached for 100 m of distance. The considered challenges are the environmental requirements, such as power supply, electromagnetic compatibility, and the mechanical and thermal requirements, the mobility, the use of an independent frequency network that should provide enough bandwidth for the transmitted data, the QoS, the safety of the network and the energy efficiency.

Salam et al. [6] performed several studies were different depths and soil types were considered. The effects of soil type and moisture on the multi-carrier modulation were analyzed. The authors analyzed the channel frequency response and the empirical antenna return loss for sandy soil, silt loam and silty clay loam with varied moisture levels. Results showed that for distances up to 12m, 124 Mbps were reached. Furthermore, 362 Mbps were reached for shorter distances and low moisture. Moreover, the authors concluded that capacity gains between 56% and 136% were reached with sub-carrier bandwidth adaptation based on the type and moisture of the soil. Moreover, a real-time permittivity and soil moisture monitoring for wireless underground communication called Di-Sense was presented in [7]. In order to do so, the propagation path loss and the velocity of wave propagation were utilized. Experiments were performed in a greenhouse with burial depths of 10, 20, 30 and 40 cm, a frequency ranges between 100 and 500 MHz and slit loam, silty clay loam and sandy soils. Results showed high accuracy for depths up to 40 cm and distances ranging from 1 to 15 meters. Lastly, a study on the performance of varied modulation schemes in underground communications was performed in [8]. Multiple antennas were utilized to exploit the direct, lateral and reflected components of the wireless underground channel. Results

showed bit errors rates (BER) of 10^{-3} for delay spreads below 0.05. Results showed that equalization impacts the performance of the IoUT communication with the 8-Tap Decision-Feedback Equalizer as the best one. Furthermore, DBPSK and DPSK presented better performance for channels without adaptive equalizations. Lastly, the authors presented two new receiver designs for IoUT communications named Lateral-Direct-Reflected and 3W-Rake. The three antenna LDR design achieved a BER of 10^{-5} .

Magnetic induction has been considered as well to perform wireless underground communication. Saeed et al. [9] presented a study on the localization in magnetic induction for IoUT for gas and oil reservoirs. The authors propose a three-dimensional MI-based location procedure based on the Cramer Rao Lower Bound (CRLB) that considers channel parameters. The considered depth is 1.8 Km. Simulation results showed that the accuracy of the localization procedure is affected by the noise variance, the frequency, the number of anchors and the number of underground things.

Considering the need of more extensive studies of the underground environment for IoT communications, especially for agricultural environments, in this paper we perform a coverage study for IoUT wireless communication performed by ESP 8266 IoT nodes.

III. ARCHITECTURE

In this section, we present the proposed architecture for an IoUT solution for agriculture. Figure 1 shows the different levels of the proposed architecture. It is formed by four levels: Nodes and Sensors, Wireless Network, Internet, Data Center and Artificial Intelligence.

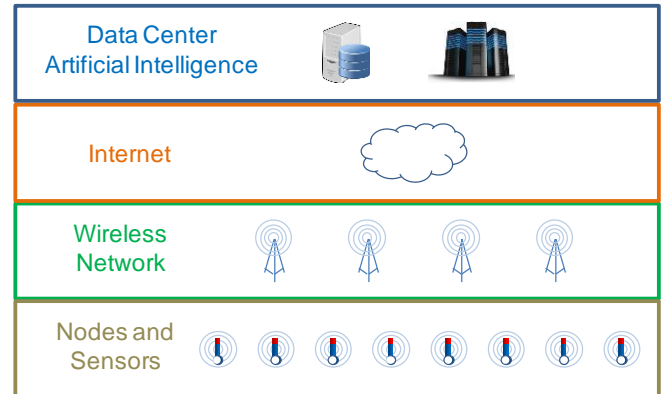

Figure 1. Proposed architecture

The nodes are located in the lower level with the sensors connected to them. These sensors will obtain all the necessary information of the crops for a later decision-making process, in which Artificial Intelligence is used in order to perform smart agriculture. The level above the first one is the level of the wireless network. At this level, the transmission of data, obtained in the fields of agriculture through the sensors by using a wireless network, is performed. At this level, the access points (AP) are located,

which collect the signals sent by the nodes and transmit them until they reach a gateway device. The gateway allows the connection through the Internet to a remote location. The next level is the Internet, where the obtained data is transmitted using an Internet Provider connection to the location where they are stored. This connection can be achieved using different technologies, such as DSL, wireless technology and 3G / 4G mobile data. We select the one that fits our requirements with the lowest costs depending on the location of the crops. Finally, in the upper layer, we locate our Data Processing Center that employs Artificial Intelligence. At this level, the information storage and treatment systems are located. In this location, the data will be stored so that it can be retrieved at any time and then be processed. With this data, the farmers and engineers can obtain relevant information for decision making.

IV. TESTBED DESCRIPTION

In this section, the design of the testbed is going to be described.

To perform this test, four nodes were programmed to measure the Received Signal Strength Indicator (RSSI) and one node was programmed as an AP. The utilized node was the Mini D1 ESP 8266 node for both the AP and the RSSI-meter. The Mini D1 presents 11 digital input/output pins and has an operating voltage of 3.3 V. The specifications of the ESP8266 chip and the antenna can be found in [10].

The nodes that measured the RSSI were placed on 80x80x36 mm sized protective boxes and the AP node was placed inside a 155X105X62 mm protective box that included the power supply. The power supply was a DC 5V-1000mA power bank with a capacity of 2000mAh. The ESP8266 nodes were placed inside the box with the antenna placed upwards. The nodes were taped in order to avoid any movement of the node inside the box at the time they were buried. A cable that connected the node to a laptop went through a hole of the box that was sealed afterwards so as to avoid the soil getting to the node. The data on the RSSI was gathered through the serial port of the node using the Arduino IDE.

As Vuran [4] described, IoUT may be comprised of underground and above ground elements. In this study, we test the signal strength between an underground and an above ground ESP 8266 node so as to determine the possible use of low-cost Wi-Fi nodes for IoUT purposes. As it can be seen in Figure 2, four RSSI-meter nodes were buried underground at distances 10 cm, 20 cm, 30 cm and 40 cm deep into the ground. They were placed in the same hole one on top of the other and adding the necessary soil between each protective box so as to reach the required depth. Then, the AP was placed at a height of 50 cm for each of the measures. The starting point for the measures was 1 meter. Each measure is then performed in increments of 1 meter until the connection is lost. The orientation of the antennas and the position of the nodes was always the same for all the measures. The images of how the nodes were placed on the field are presented in Figure 3. When the RSSI-meter nodes were buried, the soil was slightly

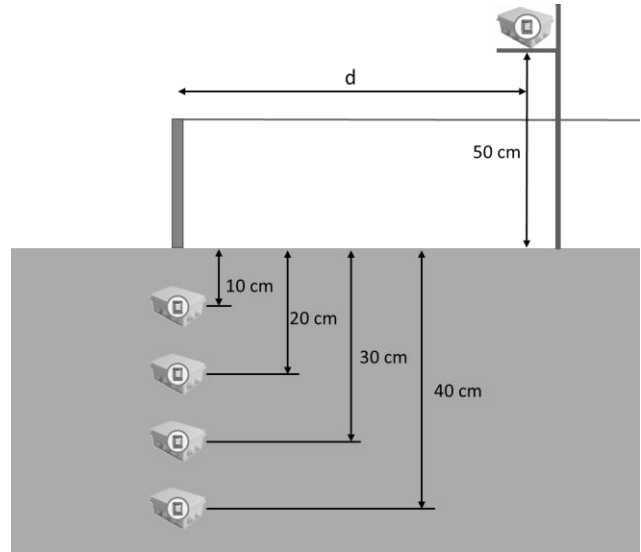

Fig. 2. Description of the testbed.

compacted, and the soil of the surrounding areas was not disrupted.

The test was performed in a Mediterranean area in a field where a citrus plot used to be. The satellite image of the field can be seen in Figure 4. As it can be seen, the area is used for agriculture and several citrus fields surround the field where the tests were performed. That area of the field was selected due to the lack of thicker and other types of vegetation. The soil was a predominantly sandy soil and has the appropriate qualities for citrus plantations. There is no presence of housing in the area and the use of IoT systems for agriculture was unknown. Therefore, a preliminary test was performed to confirm the absence of any other signal from other networks in the area.

V. RESULTS

This section presents the results of the experiment. We show the gathered RSSI at different distances. Then, the attenuation effect of the soil is described.

First, the values of RSSI are presented for each set of data (10, 20, 30 and 40 cm of buried depth.). The mean, maximum, and minimum of the RSSI gathered at different distances are shown. This step is necessary in order to evaluate the variance of the data. Figure 5 presents the data of the RSSI gathered by the node buried at 10cm. Even though we can expect to have a uniform decrease in the signal as no vegetation or building are in the studied area, the soil itself can cause multipath effect. The soil is not uniform and it can have different densities in different points which can cause those constructive and destructive interferences. In the first measured point, at 1m of the node in horizontal distance, the mean RSSI was -66dBm. The RSSI decreased quickly and uniformly to -84 when the node was placed at 3 m from the AP. This signal is considered as a poor or unstable signal, and the communication between both devices might have further problems. From this point, 3m,



Fig. 3. Nodes placed on the field

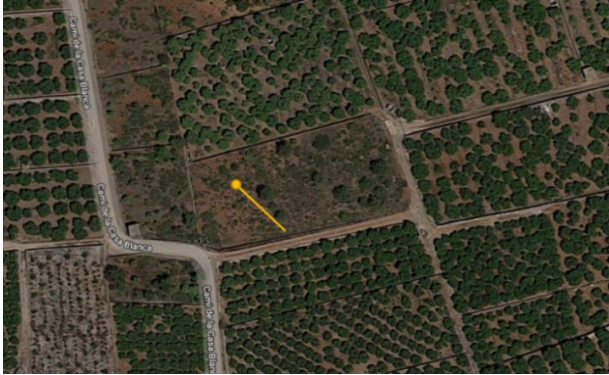

Fig. 4. Satellite image of the field.

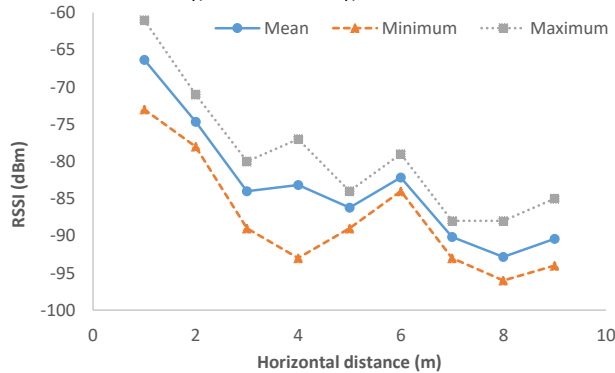

Fig. 5. RSSI with node buried at a depth of 10 cm.

the signal is affected by multipath effect and the attenuation is not uniform. In some points, 4, 6 and 9 m the RSSI increases. It is important to note that some points as 1 or 4m have a big difference between the maximum and the minimum RSSI values, with a standard deviation higher than 4 in both cases. The mean standard deviation of this set of data is 3.21. At distances 10 and 11m the connection between the node and the AP was lost.

Figure 6 details the data gathered with the node buried at a depth of 20cm. In this case the signal attenuation is more uniform than in the previous case. The RSSI in the first measured point is -61dBm (with minimum of -62 and maximum of -60dBm). The last measured point where the node is connected to the AP is 8m with a RSSI of -90dBm. In this case, no clear evidences of multipath effect are found. We suspect that, as in the previous case, there where

different densities in the soil which might cause it. Nonetheless, the data (mean, maximum and minimum) follows a uniform attenuation. The standard deviation of this data is 1.67. Apparently in this case, the standard deviation increases with the distance.

The data of RSSI from the node buried at 30cm can be seen in Figure 7. In this case, the attenuation follows almost a lineal relationship. There is one measured distance, 5m, where the RSSI increases, but in the rest of the cases it decreases with the distance. The mean RSSI at 1m is 71dBm (minimum and maximum are -68dBm and -74dBm). The last measured point where the node was connected to the AP was at 7m, with a mean RSSI of -95dBm. The mean standard deviation of this data is 1.75, which is similar to the standard deviation with the node buried at depth of 20 cm.

Figure 8 presents the data gathered with the node buried at a depth of 40cm. The mean RSSI at 1m was -72dBm, the minimum was -73dBm and the maximum -71dBm. The RSSI indicates a signal attenuation with the distance following a uniform behavior. Besides, at 4m, the RSSI increases because a possible multipath effect could be causing a constructive interference. The signal of the AP was lost after 6m. The last measured RSSI was -92dBm. The standard deviation of the data gathered at a depth of 40cm was 1.57. This data has almost the same standard deviation as the data from the nodes buried at a depth of 20cm and 30cm.

Finally, we can use the data shown in Figures 5 to 8 to create a visual model by interpolating this data. The model can be seen in Figure 9. The points where the signal was lost are entered as -110dB to generate this model. Even though we can expect the best results with the shallowest node, the node buried at 20cm seems to have better signal in the first 8m. Although, the node which has coverage at further distances is the node buried at 10cm, we must consider not only the link existence but also the coverage in terms of RSSI. The values of RSSI lower than -70dBm are considered as fair, lower than -80dBm are considered as unstable signal, and lower than 90 are considered as very unstable connection. Thus, although the node buried at 10cm has coverage until 9m, we should only consider the values higher than 90dBm. Therefore, the node which has higher coverage is the node buried at 20cm. The explanation is that, probably the signal of the node buried at 10 cm is highly affected by the air-soil interface.

VI. MATHEMATICAL MODEL

In this section, the mathematical model of the received power is presented. The received power is obtained utilizing the power balance formula [11-12] provided in (1).

$$P_{rx} = P_{tx-1m} - n * 10 * \log d - L_{humidity} - L_{soil} \quad (1)$$

Where P_{rx} is the received power expressed in dBm, P_{tx-1m} is the transmitted power at 1 meter in dBm which is -59,857 dBm for the ESP8266 nodes, n is the attenuation variation index which is 2 for air, d is the distance between transmitter and receiver expressed in meters, $L_{humidity}$ is the losses due to humidity for the two main hydrometric areas of Spain, areas H and K, which is 0.0026 dB [13] and L_{soil} are the losses due to the underground propagation of the

signal. The theoretical received power at 1 meter is obtained with (2).

$$P_{tx-1m} = 20 \log_{10} d + 20 \log_{10}(f) + 20 \log_{10}\left(\frac{4\pi}{c_0}\right) \quad (2)$$

Where c_0 is $3 \cdot 10^8$ m/s and f is the operational frequency in Hz. Furthermore, the 100 mW power commonly used for WiFi transmissions should be considered. The losses due to

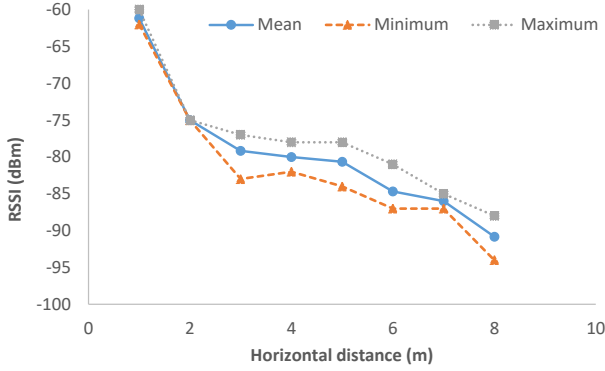

Fig. 6. RSSI with node buried at a depth of 20 cm.

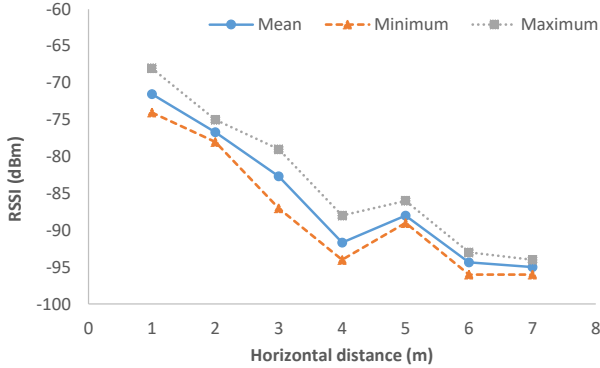

Fig. 7. RSSI with node buried at a depth of 30 cm

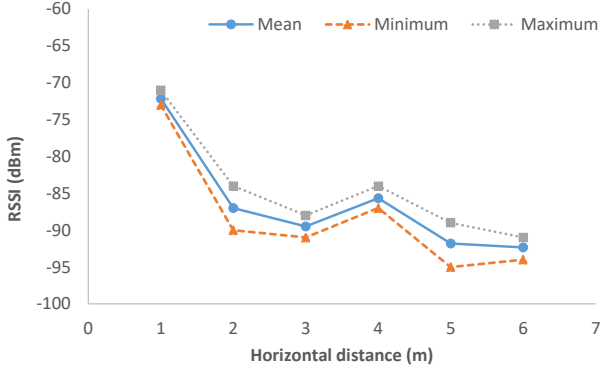

Fig. 8. RSSI with node buried at a depth of 40 cm

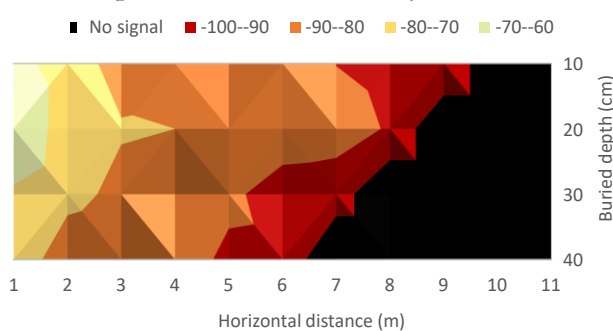

Fig. 9. Visual model of the RSSI at different depths.

soil, L_{soil} , are presented in (3) [14].

$$L_{soil} = L_m + L_\alpha \quad (3)$$

Where L_m is the attenuation caused by the variation in wavelengths and L_α corresponds to the losses due to the attenuation constant. Each of them is presented in (4) and (5) respectively.

$$L_m = 20 \log\left(\frac{\lambda_0}{\lambda}\right) = 20 \log\left(\frac{c_0}{f}\right) = 20 \log(\sqrt{\mu_r \epsilon_r}) \quad (4)$$

$$L_\alpha = 8.69 \alpha d_{soil} \quad (5)$$

The attenuation constant is given by (6).

$$\alpha = \frac{1}{5.31 \cdot 10^{-3} \cdot \frac{\sqrt{\epsilon''}}{\sigma}} \quad (6)$$

Obtained from the expressions of penetration depth $d=1/\alpha$ and the expression simplified expression for mediums where $\mu=1$ as soil [15], expressed as $d = 5.31 \cdot 10^{-3} (\sqrt{\epsilon''}/\sigma)$. The real part of the permittivity for a sandy soil ϵ' is 6.53 (TDR), the imaginary part of the permittivity ϵ'' is 1.88 (TDR) and the conductivity σ is 2.32 (mS/m).

The results of the model for a depth of 10 cm are presented in Figure 10. As it can be seen, the results are very similar to the real measures obtaining a determination coefficient r^2 of 0.8256. The results of the model for a depth of 20 cm are presented in Figure 11. The r^2 for this depth is 0.8259. Figure 12 presents the results of the model for the depth of 30 cm. The obtained determination coefficient r^2 for this depth is 0.6084. Lastly, the results of the model for the depth of 40 cm are presented in Figure 13. The r^2 of this depth is 0.0158. This is the depth where the model is the least approximated, however, it is still useful for an estimation. The heterogeneity of the soil and possible stones or other materials that change the dielectric characteristics of the soil may introduce further losses that do not affect the other depths.

VII. CONCLUSIONS

In this study, we evaluate the effects in the connectivity of different nodes buried at different depths connected to an AP that was located at 0.5m over the soil. The RSSI was measured at each depth and the AP was moved from 1m to 11m from the nodes. An Architecture for an IoUT system was proposed and a mathematical model to determine the received power between underground and above ground nodes was presented.

As it is expected, the deeper the node, the lower the coverage. The coverage with the shallowest node reaches 9m, while the coverage of the deepest node only reaches 5m. Nevertheless, if we consider the quality of the link as the value of RSSI, we can conclude that the coverage is better when the node is buried at 20cm. The standard deviation of the RSSI is maximum when the node is located closer to the surface, with a mean value of 3.21. Once the nodes are buried at higher depths, up to 20cm, the standard deviation decreases to 1.6 approximately. It might be caused by the air-soil interface which affects the node buried at 10cm greatly.

The future works will be aimed to evaluate the effect of the change the height of the AP and to evaluate the effect of having the AP on the soil and inside the soil. Moreover, we

want to repeat this test bench with other IoT devices and different types of soil. Furthermore, we will perform these tests with other wireless technologies, such as ZigBee and LoRa.

ACKNOWLEDGMENT

This work has been partially supported by the European Union through the ERANETMED (Euromediterranean

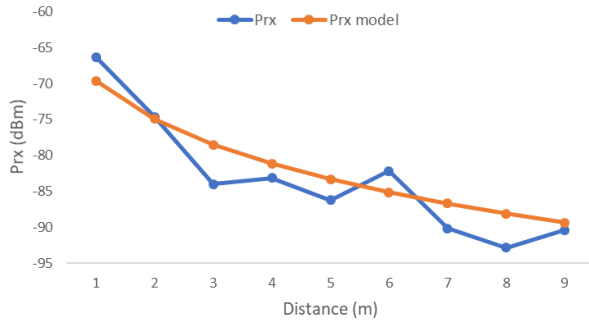

Fig. 10. Results for the model at a depth of 10 cm.

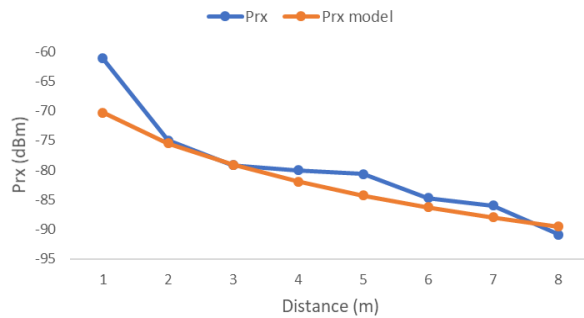

Fig. 11. Results for the model at a depth of 20 cm.

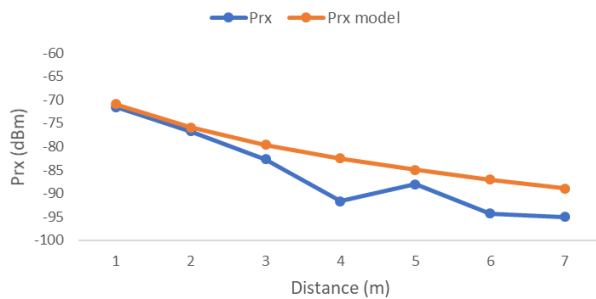

Fig. 12. Results for the model at a depth of 30 cm.

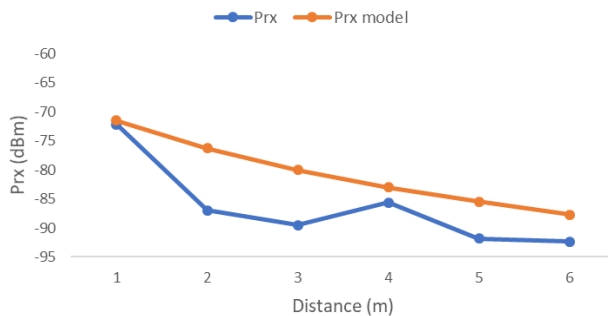

Fig. 13. Results for the model at a depth of 40 cm.

Cooperation through ERANET joint activities and beyond) project ERANETMED3-227 SMARTWATIR and by the European Union with the “Fondo Europeo Agrícola de Desarrollo Rural (FEADER) – Europa invierte en zonas rurales”, the MAPAMA, and Comunidad de Madrid with the IMIDRA, under the mark of the PDR-CM 2014-2020” project number PDR18-XEROCEPED.

REFERENCES

- [1] World Population Prospects 2017. UNITED NATIONS. DESA / POPULATION DIVISION. Available online: <https://population.un.org/wpp/> (Last access October 25, 2019).
- [2] L. García, L. Parra, J. M. Jimenez, J. Lloret and P. Lorenz, “Practical Design of a WSN to Monitor the Crop and Its Irrigation System”, Network Protocols and Algorithms, Vol. 10, No. 4, pp. 35-52, 2018.
- [3] L. Garcia, J. M. Jimenez, M. T. Abdullah and J. Lloret, “Wireless Technologies for IoT in Smart Cities”, Network Protocols and Algorithms. Vol. 10, No. 1, pp. 23-64, 2018.
- [4] M. C. Vuran, A. Salam, R. Wong and S. Imark, “Internet of Underground Things: Sensing and Communications on the Field for Precision Agriculture”, IEEE 4th World Forum on the Internet of Things, Singapore, Singapore, 5-8 February 2018, pp. 586-591.
- [5] R. de C. D. Leles, J. J. P. C. Rodeigues, I. Woungang, R. A. L. Rabêlo and V. Furtado, “Railways Networks – Challenges for IoT Underground Wireless Communications”, IEEE 10th Latin-American Conference on Communications, Guadalajara, Mexico, 14-16 November 2018, pp. 1-6.
- [6] A. Salam and M. C. Vuran, “Impacts of Soil Type and Moisture on the Capacity of Multi-Carrier Modulation in Internet of Underground Things”, 25th International Conference on Computer Communication and Networks, Waikoloa, HI, USA, 1-4 August 2016, pp. 1-9.
- [7] A. Salam, M. C. Vuran and S. Irmak, “Di-Sense: In situ real-time permittivity estimation and soil moisture sensing using wireless underground communications”, Computer Networks, Vol. 151, pp. 31-41, 2019.
- [8] A. Salam and M. C. Vuran, “Wireless Underground Channel Diversity Reception With Multiple Antennas for Internet of Underground Things”, IEEE ICC 2017 Mobile and Wireless Networking, Paris, France, 21-25 May 2017, pp. 1-7.
- [9] N. Saeed, M. Alouini and T. Y. Al-Naffouri, “On Achievable Accuracy of Location in Magnetic Induction-Based Internet of Underground Things for Oil and Gas Reservoirs”, arXiv preprint arXiv:1901.09556, 2019.
- [10] Specifications of the ESP8266. Available online: <https://www.elecrow.com/download/ESP-12F.pdf> [Last access October 25 2019]
- [11] J. Lloret, I. Bosch, S. Sendra and A. Serrano, “A Wireless Sensor Network for Vineyard Monitoring That Uses Image Processing”, Sensors, Vol. 11, pp. 6165-6169, 2011.
- [12] J. Lloret, J. J. López, C. Turró and S. Flores, “A Fast Design Model for Indoor Radio Coverage in the 2.4 GHz Wireless LAN”, 1st - international Symposium on Wireless Communication Systems, Mauritius, 20-22 September 2004, pp. 408-412.
- [13] Recommendation UIT-R PN.837-5. Characteristics of Precipitation for Propagation Modeling. Online: <http://www.itu.int/md/R07-WP3J-C-0014/en> (Last access October 25, 2019)
- [14] L. Li, M. C. Vuran and I. F. Akyildiz, “Characteristics of Underground Channel for Wireless Underground Sensor Networks”, The sixth Annual Mediterranean Ad Hoc Networking Workshop, Corfu, Greece, 12-15 June 2007, 92-99.
- [15] A. M. Sadeghion, D. N. Chapman, N. Metje and C. J. Anthony, “A New Approach to Estimating the Path Loss in Underground Wireless Sensor Networks”, Journal of Sensor and Actuator Networks, Vol. 6, No. 18, pp. 1-11, 2007.