

Multisensor monitoring of ground movements over large areas to conduct the change from the active underground hard coal mining ages to the post-mining era

Volker Spreckels

RAG Aktiengesellschaft, Im Welterbe 10, 45141 Essen, Germany, (volker.spreckels@rag.de)

Key words: *Ground movements; geometric monitoring; dynamic network adjustment; levelling; GNSS; InSAR; time series; 4D-database; Double Corner Reflector*

ABSTRACT

End of 2018 about 300 years of underground deep hard coal mining in Germany came to an end. Under regard to the ordinances of the mining authorities, RAG Aktiengesellschaft (RAG) further on remains responsible for the effects of the former underground mining in the post-mining era (Hager and Wollnik, 2016). The current and future geometric monitoring based on official federal reference networks concerns the tasks to record the fading mining induced subsidence movements and to detect the beginning uplifts to the earth surface resulting from to the controlled, ordinated flooding of the underground mine building. The geometric monitoring of the earth surface had up to now steadily been adapted to the state of the art by the integration of research and development projects (R&D) into day-to-day business, like for GIS, “4D”-databases, terrestrial GNSS surveying, high-end photogrammetry and InSAR remote sensing techniques, following national (DIN) and international standards (CEN, ISO). With the participation of Saarland’s federal ordnance survey, LVGL¹, the reformation of the traditional, current surveillance networks to a modern Multisensor - Referencestation Network (MSST Network) has been realized in spring 2022 by a GNSS- and InSAR-based ground movement cadastre (SaarBoBeKa). A close cooperation with the companies ALLSAT² and GEOTEC³ led to the development of an innovative time-variant network adjustment method for long time series of GNSS monitoring stations.

I. INTRODUCTION

During the centuries of underground hard coal mining activities in Germany local subsidence reached amounts of up to 25 meters. For the post-mining regions, the controlled slowly flooding of the underground mine buildings over a time span of several years will lead to some decimeters of uplift in the Ruhr Area, the Ibbenbueren Area and for the Saar Area (Rosner *et al.*, 2014).

Since autumn 2020 RAG and since March 2022 the ordnance survey of the Saarland (LVGL) run a common monitoring system of Multisensor - Referencestations (MSST) see (Spreckels and Engel, 2022).

The MSST combine a Double Corner Reflector (D-CR) for InSAR-monitoring, a GNSS station and levelling points to integrate it to official federal position- and height-reference systems, like LGLV’s innovative and new ground movement cadaster “*Saarlaendisches Bodenbewegungskataster SaarBoBeKa*” (SaarBoBeKa, 2022), see Figure 1.

First works on GNSS-networks started in 2014 when RAG and ALLSAT to set up a GNSS monitoring over one active longwall mining in the Ruhr Area. By and by the MSST-concept developed so that in december 2021 the GNSS- / MSST-monitoring concept of RAG could be realized in the Ibbenbueren Area (Figure 2). In 2022 this

concept will be implemented in the Ruhr Area (Figure 3).

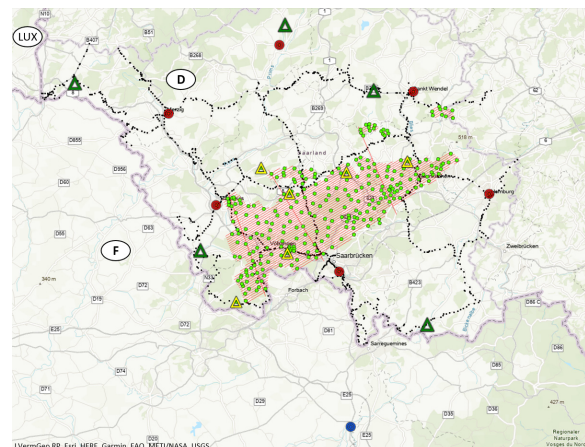

Figure 1. Monitoring concept of LVGL, OBA and RAG in the Saarland: LVGL-MSST (green triangles), RAG-MSST (yellow triangles), SAPOS GNSS stations (red circles), RGP-France GNSS station (blue circle), LN 2019 (black dots), aerial flight strips (red lines), GCP (green dots). Mapped area 90km x 70km. Image courtesy RAG.

MSST will provide robust, high accurate absolute coordinate measurement data within a single station e.g. for levelling, for GNSS measurements of ground

¹ LVGL: Landesamt für Vermessung, Geoinformation und Landentwicklung des Saarlands, Deutschland

² ALLSAT: ALLSAT GmbH – Die GNSS Spezialisten. Sokelantstr. 5, 30165 Hannover, Deutschland.

³ GEOTEC: GEOTEC – Geodaetische Technologien GmbH, Heinrich-Heine-Weg 69, 30880 Laatzen, Deutschland.

control points (GCP) and GNSS-positions of projection centers of aerial flights, for airborne laser scanning (ALS/LIDAR) as well as for UAV data. The D-CR serve as reference points in X-, C- and with large size, for L-band SAR-data of radar satellites.

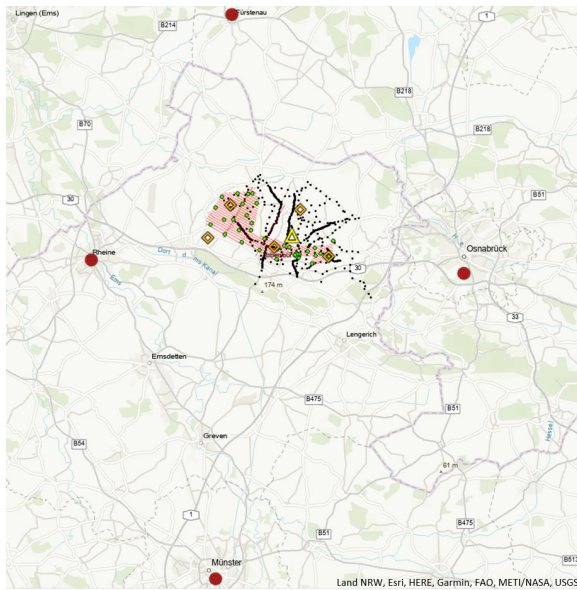

Figure 2. Monitoring concept of RAG for Ibbenbueren. MSST with DCR600 (yellow triangle), GNSS-stations (orange rhomb), SAPOS GNSS-stations (red circles), Levelling Points and LN 2019 (black dots), aerial flight strips (red lines), GCP (green dots). Mapped area 64 km x 65 km. Image courtesy RAG.

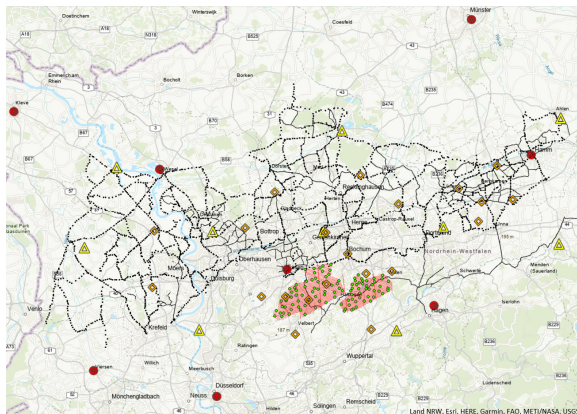

Figure 3. Monitoring concept of RAG in the Ruhr Area. Planned transportable MSST-stations (yellow triangles), GNSS-stations (orange rhomb), SAPOS GNSS-stations (red circles), LN 2020 (black dots), aerial flight strips (red lines), GCP (green dots). Mapped area 145km x 90km. Image courtesy RAG.

For about 150 years terrestrial levelling is the most accurate and precise measurement technique with the longest time series of height measurements in the Ruhr Area. So, leveling still is and will further on be one base for all ordinances of the mining authorities for the geometric monitoring of the earth surface.

In the 1990's GNSS techniques evolved but still do not reach the accuracy of levelling. Current large area surveying methods like aerial photogrammetry and ALS used in RAG's workflows e.g. for the early detection of sinkholes are connected to tie points measured by GNSS within the federal reference network of the German *Satellite Positioning Service (SAPOS)*⁴. Since 1999 RAG is using diverse InSAR techniques for the large area monitoring of mining induced ground movements (Strozzi *et al.*, 2001). These methods have a high inner accuracy but do need clearly detectable point-signals in the radar data, like from exactly defined D-CR of MSST, to connect and to combine SAR-data with the other monitoring methods. A short overview will be given in following:

A. Levelling

For the active mining regions of the Ruhr Area wide area levelling have been more or less regularly performed from 1873 on, bi-annually since 1948 for the region east of the river Rhine. The design of the levelling network changed over the time, following the active mining areas from the southern old mining regions at the river Ruhr northward towards the river Lippe. In the 1970ies the so called "Leitnivellement" (LN), federal high precision levelling campaigns of the survey authorities, have been implemented in NRW. In 2018 about 1.240 km of high precision levelling had been measured on about 2.300 points for the Ruhr Area (Boje *et al.*, 2008), 200 km of LN in the Saarland and 142 km LN for the Ibbenbueren Area. In future, LN will be performed in 5-year-cycle in NRW from 2025 on (Riecken *et al.*, 2019) and from 2024 on in the Saarland.

B. GNSS

In 2004 RAG introduced special transformation parameters for high precision GNSS measurements to harmonize own measurements from former diverse local reference systems in RAG's areas of responsibility (Spreckels 2003). Since 2014 the methods for GCP measurements of aerial image flights have been updated in R&D studies with ALLSAT to an absolute repeat precision of better than $\pm 1,5$ cm in position and height. For the GNSS time series new time-dependent dynamic network adjustments (DNA) of continuous GNSS monitoring data of reference stations have been developed for the program system PANDA⁵ within the R&D project "GNSS-Monitoringnetze" by GEOTEC (Niemeier and Tengen, 2022) and have successfully been implemented into ALLSAT's GNSS-Portal GLOMON⁶ (Schulz and Schäfer, 2022).

⁴ SAPOS: Satellitenpositionierungsdienst der deutschen Landesvermessung. <https://sapos.de>

⁵ PANDA: Programmsystem zur Ausgleichung von geodaetischen Netzen zur Deformationsanalyse. www.geotec-gmbh.de/en/panda/

⁶ GLOMON: System for GNSS monitoring www.global-monitoring.de

C. Aerial Photogrammetry

The Over RAG's near surface old mining areas annual aerial flights with onboard combined high-resolution aerial image cameras and ALS are performed since 2015 for the automated detection of sinkholes (Kipp *et al.*, 2022). Due to the flying altitude the cameras reach a ground sampling distance (GSD) of 3 cm to 4 cm and ALS records about 10 points/m². Here a very high repeat precision is needed: 10 cm of deviations on the ground have significantly to be detected between two flight campaigns. So the whole process of: GNSS - GCP measurements, positioning accuracy of the aerial images' projection centers, INS/IMU - navigation data for ALS and the aero-triangulation - has to happen with a cumulated absolute accuracy of better than ± 3 cm for the whole covariance propagation (Spreckels *et al.*, 2016).

D. Satellite-based radar interferometry (InSAR)

Since 1999 RAG follows and utilizes the evolving methods of SAR interferometry for the detection of mining induced surface movements. Beginning with Differential SAR interferometry (DInSAR), followed by Persistent Scatterer Interferometry (PSI) and current modern multi-orbit decomposition analyses from ascending and descending orbit data collected by current X-, C- and former L-Band radar satellites. Hereby larger areas than before can be monitored with the meanwhile commonly known potential and the limitations for the detection of surface movements *e.g.* in "Line-of-Sight" (LOS). The LOS measurements can be calculated to surface movements into vertical- and into east-west direction components with decomposition methods (Yin and Busch, 2018).

E. Multisensor-Referencestations (MSST)

For RAG it is mandatory to relate all measurement data at highest precision to be able to guide standards for the geometric monitoring in the near surface old mining areas and the post-mining regions that could be affected by the rise of the underground mine water level due to the controlled flooding of the former mine buildings. From 2006 on, together with the Institute of Geotechnical Engineering and Mine Surveying at the Clausthal University of Technology (IGMC), RAG installed different kinds of single corner reflectors (CR) over active mining areas in R&D projects for X-, C- and L-band descending orbit satellite data. The changes in position and height had been validated by levelling and static GNSS methods (Walter *et al.*, 2009).

Today, all the above from A. to D. listed measurement methods can be combined in one single station. A D-CR can be tailored in size according to his task as well as the kind of GNSS antennas to be mounted. All D-CR do have special marks and targets even for levelling measurements. From the early discussions to daily practice RAG has designed different prototypes that

have been realized in cooperation with LVGL and Allsat. For one MSST-design a patent is pending (Patent 2021).

The MSST shall serve as a reference for several decades. So, a robust station has been designed, with a solid reinforced concrete foundation of 2 m x 2 m x 2 m, an absolute calibrated chokering antenna and a 1 cm solid stainless steel-plate D-CR. The dimension of the size needs to fulfill the requirements: D-CR of 2 m in diameter with 1 m edge length is suitable for X-, C- and L-band (see Figure 4).



Figure 4. RAG's MSST for Saarland's SaarBoBeKa. Left: reinforced concrete foundation 2m x 2m x 2m, lightning rod, JAVAD RingAnt-G3T GNSS chokering antenna, D-CR $\varnothing 2,0$ m and levelling points in foundation and D-CR. Right: solar power supply, weather sensors, mobile radio antenna, equipment box. Image courtesy ALLSAT & RAG.

A 2 m D-CR can also be founded on a transportable platform and the GNSS-antenna can be mounted in the center or terrestrial measurement targets in the center and on the flanks of the D-CR (see Figure 5).

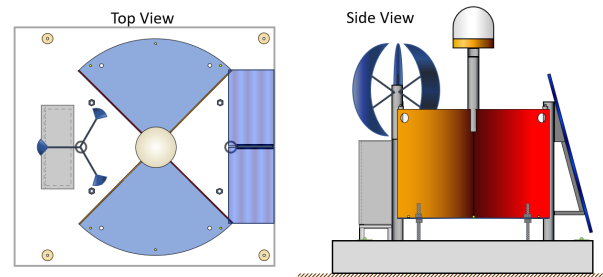

Figure 5. Top view and side view sketches of a fully equipped and self-supplying transportable MSST, $\varnothing 2,0$ m, to be installed in the Ruhr Area. Image courtesy RAG.

A smaller MSST, the so called DCR600 is now available from ALLSAT. It is a D-CR with 120 cm in diameter, a

centered GNSS antenna, 5/8" adapters for terrestrial targets and it has a mounting for common terrestrial pillars or tripods. It can easily be mounted and de-mounted for temporal projects in smaller regions or for a local object monitoring (see Figures 6 and 7).



Figure 6. DCR600, Ø1,2m with GNSS-Antenna and weather-sensors. Image courtesy ALLSAT & RAG.

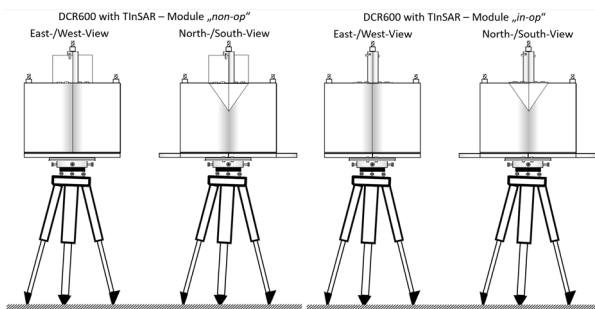

Figure 7. Sketch of the with TInSAR-module extended DCR600. From left to right: TInSAR unit "non-op": east/west view, north/south view, TInSAR unit "in-op": east/west view, north/south view. Image courtesy ALLSAT & RAG.

All MSST can additionally be equipped with weather-sensors. The data transfer can be guided via router to cellular networks or by LAN. The energy supply can be assigned to the power net, solar and/or wind energy.

Several not yet published analyses of LVGL, Allsat and RAG proved that there are no multipath effects from the D-CR to the GNSS antenna.

F. Guidance in "4D" – Database: GeoMonPlus (GMP)

In 2005 RAG implemented the first prototype of the GeoMon point-database set up by IGMC within a RAG R&D project (Kamphans *et al.*, 2008). GeoMon has now completely been overworked and brought to the current state of art (Bechert *et al.*, 2022). Herein, the

time stamp of the measurement is one of the essential main data classification criteria.

All the named surveying and remote sensing data can be georeferenced with most possible accuracy via GNSS, D-CR and levelling in one station - and therefore unambiguously guided in databases like GMP.

G. Standardization

These days in Germany there are several groups working on manuals and standards for using InSAR techniques in day-to-day business. The German Mine Surveyor Association (DMV)⁷ is currently working on a manual how to handle InSAR within the ordinances of the federal mining authorities and the daily work within the frame of the ground movement monitoring.

A working group of the German Adv⁸ is currently working on a manual how to handle InSAR within the tasks and ordinances of federal surveying authorities.

At least the German DIN standards working group NA 005-03-02 "Photogrammetry and Remote Sensing" is working on the new DIN standard 18740-9 "InSAR – Radar-Interferometry for ground movement detection" (Spreckels 2022). Here, one focus is set on how international standards are already available and have come into effect, like the standards of ISO/TC 211 "Geographic Information/Geomatics", ISO/TS 19159-3:2018 "Calibration and validation of SAR/InSAR sensors". The aim is, that all these standards can be coordinated with each other.

All of the topics above from A. to F. are parts of the discussions within the named working groups.

II. GNSS/MSST– CONCEPT IN RAG'S REGIONS

The following chapter will present the current state of the geometric monitoring in the hard coal post-mining regions Saar Area, Ruhr Area and Ibbenbueren.

A. Saarland

The entire post-mining region of RAG in the Saar Area to be monitored is about 1.500 km². For the near surface old mining regions about 225 steady marked GCP for combined aerial image flights with ALS have annually to be measured. More than 9.600 aerial images are recorded every year for 280 km² (see Figure 1).

For InSAR monitoring RAG has installed six MSST with solar and wind energy power supply, equipped with JAVAD RingAnt-G3T GNSS chokering antennas (see Figures 4 and Figure 8). The heavy concrete 2 m x 2 m x 2 m reinforced concrete foundation and the 2 m D-CR bear several levelling points.

LVGL has finished five nearly identical constructed MSST in March 2022, equipped with Leica AR25 chokering GNSS antennas, LAN or LTE connection and plugged to the power net (see Figure 9). LVGL performs

⁷ DMV: Deutscher Markscheider Verein, Arbeitskreis „Interferometrie“

⁸ Adv: Arbeitsgemeinschaft der Vermessungsverwaltungen Deutschlands – Arbeitskreis 6, Raumbezug.

the InSAR/PSI processing for the whole federal state of the Saarland, provides annually results to OBA and to RAG and publishes the results as open data in SaarBoBeKa (Spreckels and Engel, 2022).



Figure 8. RAG's MSST Stangenmuehle/Fenne, Saarland, LVGL nr. 6707 0 402 00, as to be seen in RAG's orthophoto at 3 cm GSD, aerial flight campaign at noon, April 25th, 2021. Mapped area 15 m x 14 m. Image courtesy RAG.



Figure 9. LVGL's MSST Felsberg for Saarland's SAARBOBEKA on a reinforced concrete foundation 2 m x 2 m x 2 m, Leica AR25 GNSS chokering antenna, D-CR Ø2,0m and levelling points in foundation and D-CR. Image courtesy LVGL.

B. Ruhr Area

In the Ruhr Area the entire post-mining region in RAG's responsibility to be monitored is about 7.000 km². Here MSST, GNSS, levelling, combined aerophotogrammetry and ALS flight campaigns and InSAR-methods will conduct the geometric surface movement monitoring.

The near surface old mining area is about 300 km², whereof the sinkhole affected old mining area in RAG's responsibility is about 140 km². Here about 100 steadily marked GCP for aerial image flights at 3 cm to 4 cm GSD have to be measured annually, see Figure 3.

For the whole post-mining region RAG will install ten transportable MSST in 2022, equipped with calibrated Leica AR25 GNSS chokering antennas, solar- and wind energy supply (see Figure 5). In total 21 further GNSS-stations with JAVAD RingAnt-G3T GNSS chokering antennas will be constructed, the first of them have been installed from 2014 on.

Here first evaluations concerning the "Dynamic Network Adjustment" (DNA) regarding time-variant approaches have been performed, so that for some SAPOS- and for RAG's GNSS-reference stations individual movement components could be detected with measurement data for more than two years (Niemeier and Tengen, 2022). See section III for more details.

C. Ibbenbueren

For the smaller Ibbenbueren near surface old mining area of about 50 km² there are 40 steadily marked GCP annually measured for the flight campaign with high resolution aerial images and ALS. Since 2021 the entire post-mining area of about 200 km² is supplied with one D-CR600 and additional five GNSS-stations, all equipped with Tallysman VP6000 antennas. For this region radar-interferometric multi-orbit decomposition analyses are performed with Sentinel-1A/B radar scenes from 2019 on.

III. GNSS NETWORKS

For the time of the post-mining era RAG further on operates within three different post-mining regions in Germany. Here the geometric monitoring affords regional reference networks for each area. The height reference is supplied by the elevation cadasters of Geobasis NRW and Saarland's LVGL. For GNSS measurements the German federal SAPOS network defines the reference for the positioning -and height-determination.

All of RAG's GNSS measurements are transmitted to ALLSAT's GLOMON portal and processed for the three post-mining regions.

A. Global Monitoring - GLOMON

GLOMON supports the monitoring for the detection of deformations or surface movements using GNSS and other sensors by an automatic processing of GNSS data for results with highest precision and accuracy in the range of a few mm. The SAPOS reference stations are the highest order of federal reference points and can be densified by further GNSS stations or MSST. Like in GMP (Bechert *et al.*, 2022) all 3D coordinates are created for each monitoring station with an exact time stamp, allowing the web-based visualization of time series. Within RAG's R&D project "GNSS-Monitoringnetze" a new innovative concept for the adjustment of time-variant coordinates, the "Dynamic Network Adjustment (DNA)", has been developed by GEOTEC and

implemented in GLOMON (see Schulz and Schäfer, 2022; Niemeier and Tengen, 2022).

B. The “Dynamic Network Adjustment (DNA)”

Since decades the discrepancy exists that geodesists monitor changes of the earth surface or for large engineering structures. The results are often presented in a suboptimal manner: In most cases, the variations of an object or an area are documented in coordinates for representative points with time stamps or with displacements rates like absolute values or velocities. In our days tightly clocked measurements from sensors deliver continuous data, but there is no complete concept to treat variations continuously within the coordinate approach. One of the new developments is the integration of the program system PANDA from GEOTEC into ALLSAT’s GLOMON portal which supports this innovative time-variant, dynamic network adjustment approach (DNA).

This DNA procedure modifies the approach of stable reference points for geodetic monitoring tasks, which has been valid for decades. The classic approach to such measurements is the assumption of a stable reference frame over a long period of time, based and fixed on a zero measurement. Local measurements are connected to higher-level, supposedly stable reference points, such as the first order SAPOS GNSS reference stations. But even these reference points can be affected by individual movements (see Figure 10).

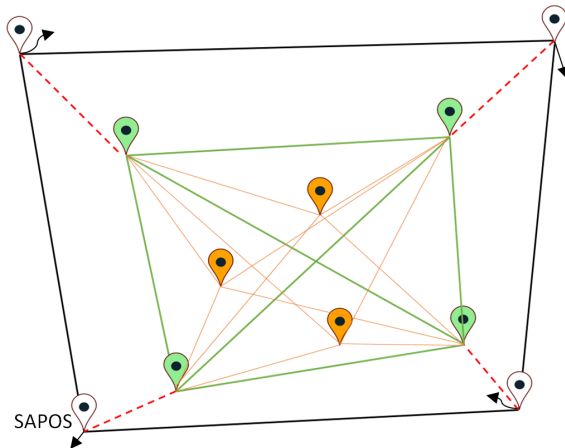

Figure 10. Stability and network hierarchy - first order SAPOS GNSS reference stations (black), GNSS reference stations (green), *e.g.* GCP for aerial flight campaigns (orange) (Spreckels *et al.*, 2016).

Conventionally regarded, reference points are assumed as stable by definition. But their real movement behavior will directly be projected onto the local measurements like *e.g.* tie point measurements on ground control points (GCP) for aerial image flight campaigns. To solve this problem in the new DNA approach, all GNSS stations are handed over to a deformation analysis after the post-processing and the network adjustment in order to detect displaced points. Now, the concept of time-invariant reference station

coordinates is reconsidered: this means that reference stations detected as displaced are not fundamentally excluded from the network evaluation, but their movement behavior is described by time-variant coordinates. With the introduction of movement models for reference stations, their movements are no longer projected onto local measurements or monitoring stations (see Figure 11). This information can be used in the areas of interest, *e.g.* for the optimization of existing movement and deformation models.

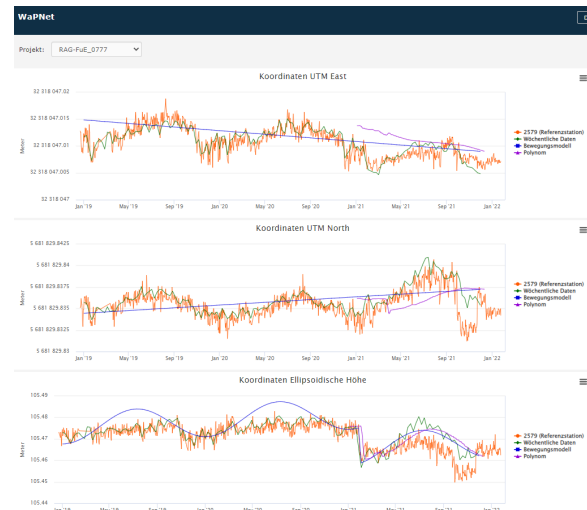

Figure 11. GLOMON time series for the SAPOS GNSS station no. 2579, from 01/2019 to 01/2022. Easting (top), northing (mid) and height (bottom): daily averages (orange). DNA: weekly averages (green), movement model (blue) and derived movement polynomial (purple). Image courtesy RAG & ALLSAT.

In this way, predictions about expected deformations can be made more reliable and can be applied for different specific measurement dates within the process chain of a workflow *e.g.* including different dates of aerial and UAV image flight campaigns and of their related GCP measurements (see Figures 12 and 13).

The aim of applying an individual movement behavior is to maintain reference points with slight movements as long as possible as reference points.

In case these points will be obtained as reference points, an identical stable and over the time equally balanced reference network configuration will be maintained as long as possible. This is a great advantage for a long-lasting geometric monitoring.

So, the advantage of obtaining the network configuration over a very much longer time is to keep the network parameters stable and robust. The strain and tension and gravity center of a special monitoring network will be kept for the comparison to former and future campaigns related on this network. The loss or change of the one or other reference point will cause more deviation to the network geometry over the time, that we can detect in recent time-invariant network adjustments.

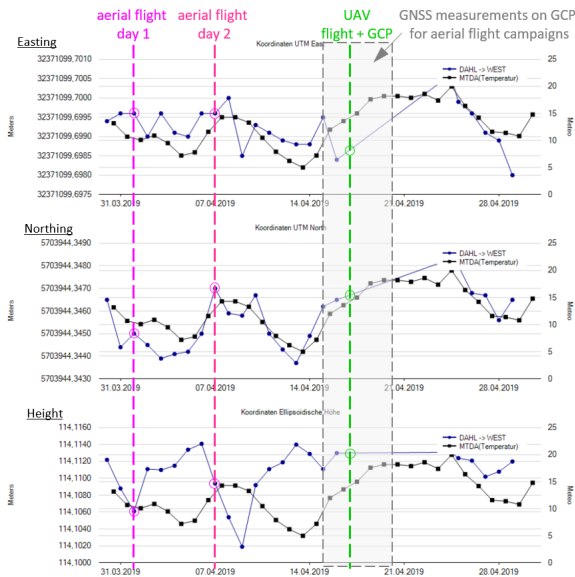

Figure 12. Time series for relative changes in easting (top), northing (mid) and height (bottom) of RAG's GNSS-reference station DAHL, overlain with data-recording dates for aerial image flights and GCP measurements (Spreckels *et al.*, 2016).

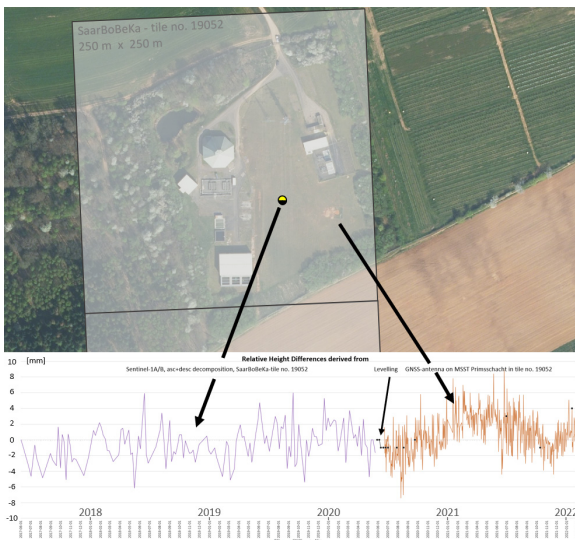

Figure 13. Time series (06/2017-02/2022) for relative vertical movements derived for a 250 m x 250 m tile, SaarBoBeKa - no. 19052, height difference spacing: 2 mm. RAG's levelling measurements (black dots). Decomposition (height component) of Sentinel-1A/B ascending and descending orbit (06/2017-06/2020) by LVGL (purple). GNSS time series (06/2020-02/2022) derived from RAG's MSST station Primsschacht, LVGL no. 6607 0 403 00 (orange). Mapped area 550 m x 330 m. Image courtesy LVGL and RAG.

It has to be taken into account, that the time series for the determination of an individual movement behaviour will take an observation time of at least two to three years for a significant estimation of long-term influences. With this DNA-approach the surveys for RAG's three mining regions are expected to be based on best estimated reference networks for the detection of ground movements and time series analyses. So, a reliable and robust coordinate reference will be established for all of RAG's remote sensing tasks and terrestrial survey of the earth surface as well as for

underground surveys like the 3D data capture of near surface openings (Kipp *et al.*, 2022).

IV. CONCLUSION AND OUTLOOK

Further work will focus on the improvement of the time-variant network adjustment with the integration of additional area wide data, like area-wide points *e.g.* from radar-interferometric PSI analyses that are available and soon be comparable to GNSS and levelling in the Saarland from LVGL's SaarBoBeKa (see Figure 13). To adapt all the terrestrial and remote sensing measurement data the needed interfaces between GLOMON and RAG's GMP "4D"-database will be developed as well as the data structure for the guidance of GNSS measurements, levelling, relative movements derived from PSI, on MSST and near GNSS-stations even with the possibility to adapt additional other sensor's data, *e.g.* from weather-sensors, in near future.

References

- Bechert, S., A. Schlienckamp, and V. Spreckels (2022). GeoMonPlus – Application for storage, allocation, exchange and visualization of historical and actual 4D-position-data within mining areas. In: *5th Joint International Symposium on Deformation Monitoring JISDM 2022*, Valencia, Spain, June 20-22, 2022, these proceedings.
- Boje, R., W. Gstirner, D. Schuler, and M. Spata (2008). Leitnivellements in Bodenbewegungsgebieten des Bergbaus – eine langjährige Kernaufgabe der Landesvermessung in Nordrhein-Westfalen. In: *Nachrichten aus dem öffentlichen Vermessungsdienst Nordrhein-Westfalen (NÖV)*, 3/2008, pp 33-42.
- Hager, S., and F. Wollnik (2016). Mine Surveying and Post-Mining Activities of RAG Aktiengesellschaft / Markscheidewesen und Altbergbau der RAG Aktiengesellschaft. In: *Mining Report Glückauf - Fachzeitschrift für Bergbau, Rohstoffe und Energie*, No. 3, 152. Jahrgang, Verlag Bergbau-Verwaltungsgesellschaft mbH, Herne, ISSN 2195-6529, June 2016, pp 224-232.
- Kamphans, K., D. Walter, W. Hanneman, W. Busch, V. Spreckels, and P. Vosen (2008). GIS-Einsatz im Monitoring bergbaubedingter Oberflächenbewegungen. In: *20. AGIT-Symposium Angewandte Geoinformatik, Salzburg, Austria*, Wichmann Verlag, ISBN 978-3-87907-464-8, July 2-4, 2008, pp 572-577.
- Kipp, A., A. Schlienckamp, and A. Ens (2022). Early detection, permanent monitoring and documentation of critical locations at the surface in mining areas. In: *5th Joint International Symposium on Deformation Monitoring JISDM 2022*, Valencia, Spain, June 20-22, 2022, these proceedings.
- Niemeier, W., and Tengen, D. (2022). Dynamic concepts to handle geodetic networks with continuous monitoring data in areas with ground movements. In: *5th Joint International Symposium on Deformation Monitoring JISDM 2022*, Valencia, Spain, June 20-22, 2022, these proceedings.
- Patent (2021). Referenzstation zur Nutzung in der großflächigen Bestimmung der Bewegung der Erdoberfläche in SAR-Anwendungen. Allsat GmbH, Hannover Germany, Spreckels, V. & M. Schulz. *Patent*

- application*, Deutsches Patent- und Markenamt, December 20, 2021, Az. 10 2021 131 933.1
- Riecken, J., B. Krickel, V. Gefeller, and P. Reifenrath (2019). Nutzung der Radarinterferometrie im geodaetischen Raumbezug. In: *Zeitschrift für Geodäsie, Geo-Information und Landmanagement (zfv)*, Vol. 144, issue 6, 2019, Wißner Verlag, DOI: 10.12902/zfv-0281-2019, pp 354-361.
- Rosner, P., M. Heitfeld, V. Spreckels, and P. Vosen (2014). Auswirkungen von Geländehebungen im Zuge des Grubenwasseranstiegs im Ruhrrevier. In: RuhrGeo Tag 2014, Bochum, Germany, March 27, 2014, pp 153-177.
- SaarBoBeKa (2022). Bodenbewegungskataster Saarland. URL:<https://geoportal.saarland.de/article/Bodenbewegungskataster/>. Last access: 2022-03-22.
- Schulz, M., and F. Schäfer (2022). GLOMON-Monitoringportal for storage, management, advanced processing and intelligent visualization of GNSS- and other sensors data. In: *5th Joint International Symposium on Deformation Monitoring JISDM 2022*, Valencia, Spain, June 20-22, 2022, these proceedings.
- Spreckels, V. (2003). Subsidence determination by different sensor types using standardized transformation parameters. In: *Joint ISPRS/EARSel Workshop "High Resolution Mapping from Space 2003"*, Oct. 6-8, 2003, Hannover, Germany, 6 pages.
- Spreckels, V. (2022). Status of the new German DIN standards project „InSAR – Radarinterferometry for the detection of ground movements“. In: *5th Joint International Symposium on Deformation Monitoring JISDM 2022*, Valencia, Spain, June 20-22, 2022, these proceedings.
- Spreckels, V., A. Schlienkamp, A. Greiwe, and L. Eberhardt (2016). Eignung von ALS, Aero- und UAS-Photogrammetrie zur Früherkennung und Erfassung von Tagesbrüchen. In: *36. Wissenschaftlich-Technische Jahrestagung der DGPF*, Band 25, Bern, Switzerland, June 7-9, 2016, ISSN 0942-2870, pp 97-112.
- Spreckels, V., and T. Engel (2022). Set-up and application of multisensor-referencestations (MSST) for levelling, GNSS and InSAR in the former mining regions Saarland and Ruhrgebiet within Germany. In: *5th Joint International Symposium on Deformation Monitoring JISDM 2022*, Valencia, Spain, June 20-22, 2022, these proceedings.
- Strozzi, T., U. Wegmueller, L. Tosi, G. Bitelli, and V. Spreckels (2001). Land Subsidence Monitoring with Differential SAR Interferometry. In: *Photogrammetric Engineering & Remote Sensing (PE&RS)*, Vol. 67, issue. 11, November 2001, pp 1261-1270.
- Walter, D., U. Wegmueller, V. Spreckels, D. Hannemann, and W. Busch (2009). Interferometric monitoring of an active underground mining field with high-resolution SAR sensors. In: *ISPRS Hannover Workshop 2009 - "High-Resolution Earth Imaging for Geospatial Information"*, Hannover, Germany, June 2-5, 2009, 6 pages.
- Yin, X., and W. Busch, (2018). Nutzung der Sentinel-1 Aufnahmekonfigurationen zur Ableitung von Bodenbewegungskomponenten im Rahmen eines radarinterferometrischen Bodenbewegungsmonitorings. In: *Tagungsband GeoMonitoring 2018*, Clausthal-Zellerfeld, Germany, March 1.-2., 2018, pp. 119-138. ISBN: 978-3-86948-627-7.