



UNIVERSIDAD
POLITECNICA
DE VALENCIA



Máster Universitario
en Tecnologías, Sistemas y
Redes de Comunicaciones

Low Complexity Iterative MIMO Receivers for DVB-NGH Using Soft MMSE Demapping and Quantized Log-Likelihood Ratios

Author: David E. Vargas Paredero

Director 1: David Gómez Barquero

Director 2: Gerald Matz

Director 3: Narcís Cardona Marcet

Start Date: 1/07/2011

Work Place: Mobile Communications Group of iTEAM and Communications Theory
Group of Institute of Telecommunications of Vienna University of Technology



UNIVERSIDAD
POLITECNICA
DE VALENCIA



Objectives — The main goal of the thesis is to develop a signal processing which exploits the benefits of iterative decoding for MIMO receivers of next generation of mobile TV standard, DVB-NGH but moreover significantly reduces the receiver complexity. The signal processing is based on MMSE equalization with a priori inputs and quantized log-likelihood ratios.

Methodology — The performance of the developed signal processing with reduced complexity is compared to the reference max-log MIMO demapper which provides performance close to optimal but with high computational complexity which scales exponentially with the number of transmit antennas. The simulations are carried under mobile vehicular NGH channel model with 60 km/h speed.

Theoretical developments — The concepts of MMSE equalization with a priori inputs have been first proposed for communication systems that send data over channels that suffer from ISI (Inter Symbols Interference) and require equalization [1] - [2], and in a multiuser scenario for CDMA systems [3]. In this thesis we adapt the MMSE with priors equalizer design to multi-stream soft interference cancellation followed by per-layer soft demapping in DVB-NGH MIMO systems.

Prototypes and lab tests — The developed MMSE equalizer and LLR quantization signal processing is included in the Instituto Telecomunicaciones y Aplicaciones Multimedia's (iTEAM) DVB-NGH simulation platform in Matlab language. The results obtained with the reference max-log MIMO demapper have been exhaustively validated with the simulation platforms of PANASONIC and LG inside the DVB-NGH standardization process.

Results — The signal processing algorithms developed in the thesis based on MMSE equalization with prior information and quantized LLRs significantly reduce the receiver complexity but are able to exploit the gain obtained with MIMO and iterative decoding. The complexity scales polynomially with the number of transmit antennas in comparison to the exponential grow for the reference max-log MIMO demapper. The developed signal processing, MIMO techniques and performance evaluation carried in this thesis have been deployed under the framework of the European Celtic project ENGINES, a project agreement between iTEAM and LG (South Korea) in MIMO topics, the DVB-NGH standardization process and a collaboration between Universidad Politécnic de Valencia and Vienna University of Technology.

Future work — Several issues and possible interesting extensions for future research: In this thesis we have studied the performance of a 2x2 MIMO system with 16QAM order constellation in each transmit antenna. Higher constellation orders are of interest (e.g. 64QAM in each transmit antenna). Detailed complexity analysis comparison between demappers. Efficient exchange of extrinsic information between MIMO demapper and channel decoder. LLR quantization design taking into account iterative process. On-the-fly quantizer design and finally the research done for MMSE equalizers could be extended to improve the estimates of real channel estimation.

Publications — The author of the thesis is actively participating in the MIMO task force of the DVB-NGH standardization process with 12 technical contributions on MIMO topics and collaborating closely with LG and PANASONIC. The results of this thesis have been presented in the DVB plenary meeting of the technical module. The author has participated in an article of Jornadas Telecom I+D 2011 on DVB-NGH technology. He is currently writing three articles on MIMO: IEEE Communications Magazine, book chapter in collaboration with LG for second edition of “Handbook of Mobile Broadcasting” of CRC Press and he is also working in a IEEE Transactions on Broadcasting in collaboration with members of TUW (Wien). The author has also participated in the redaction of a deliverable for European Celtic project ENGINES.

Abstract — DVB-NGH (*Digital Video Broadcasting - Next Generation Handheld*) is the next generation standard of mobile TV based on the second generation of terrestrial digital television DVB-T2 (Terrestrial 2nd Generation). The introduction of multi-antenna techniques (MIMO) is a key technology to provide a significant increase in system capacity and network coverage area. The gain obtained with MIMO can be further increased with the combination of iterative decoding (exchange of extrinsic information between channel decoder and MIMO demapper) but the combination of both techniques increases considerably the receiver complexity making in some cases its real implementation inaccessible. This thesis proposes a signal processing algorithm which exploits the benefits of iterative decoding for DVB-NGH MIMO receivers but moreover significantly reduces the receiver complexity. The signal processing is based on MMSE equalization with a priori inputs and quantized log-likelihood ratios. Finally, we provide performance simulation results under mobile vehicular NGH channel model with 60 km/h to show the potential of developed algorithm.

Author: David E. Vargas Paredero, email: davarpa@iteam.upv.es
Director 1: David Gómez Barquero, email: dagobar@iteam.upv.es
Director 1: Gerald Matz, email: gerald.matz@nt.tuwien.ac.at
Director 1: Narcís Cardona Marcet, email: ncardona@iteam.upv.es
Delivery Date: 09-11-11

INDEX

I. Introduction	4
I.1. Motivation.....	4
I.2. Objectives	5
II. Low complexity iterative MIMO receivers for DVB-NGH using soft MMSE demapping and quantized log-likelihood ratios	6
II.1. Benefits of Multiple Input Multiple Output Techniques (MIMO)	6
II.2. MIMO for DVB-NGH.....	7
II.3. MIMO demodulation and complexity	9
II.4. Iterative detection: MMSE with a priori inputs.....	10
II.5. LLR quantization.....	12
II.6 Low-complexity iterative DVB-NGH MIMO receiver.....	14
III. Simulation setup	15
III.1. DVB-NGH channel model.....	15
III.2. Simulation parameters.....	16
IV. Results	18
V. Conclusions and future work	25
V.I. Conclusions.....	25
V.II. Future work	26
Acknowledgments	27
References	28
Annex – list of contributions and publications	29

I. Introduction

I.1. Motivation

DVB-NGH (Next Generation Handheld) is the next generation of mobile TV broadcasting standard developed by the DVB project [4]. It is the mobile evolution of DVB-T2 (Terrestrial 2nd Generation) [5] and its deployment is motivated by the continuous grow of mobile multimedia services to handheld devices such tablets and smart-phones [6]. The main objective of DVB-NGH is to increase the coverage area and capacity network outperforming the existing mobile broadcasting standards DVB-H (Handheld) and DVB-SH (Satellite services to Handheld devices). DVB-T2 and therefore DVB-NGH, introduces the concept of Physical Layer Pipe (PLP) in order to support a per service configuration of transmission parameters, including modulation, coding and time interleaving. The utilization of multiple PLPs could in principle allow for the provision of services targeting different user cases, i.e. fixed, portable and mobile, in the same frequency channel. The main new additional characteristics of DVB-NGH compared to DVB-T2 are: use of SVC (Scalable Video Content) for efficient support for heterogeneous receiving devices and varying network conditions, TFS (Time Frequency Slicing) for increased capacity and/or coverage area, efficient time interleaving to exploit time diversity, RoHC (Robust Header Compression) to reduce the overhead due to signaling and encapsulation, additional satellite component for increased coverage area, improved signaling robustness compared to DVB-T2, efficient implementation of local services within SFN (Single Frequency Networks) and finally implementation of multi-antenna techniques (MIMO) for increased coverage area and/or capacity network.

The utilization of multi antenna techniques at both sides of the transmitter chain (MIMO) is a key technology that allows for significant increased system capacity and network coverage area. It is already included in fourth-generation (4G) cellular communication systems, e.g. *Worldwide Interoperability for Microwave Access* (WiMAX) and 3GPP's *Long-Term Evolution* (LTE), and internet wireless networks, e.g. *Wireless Local Area Networks* (WLAN), to cope with the increasing demand of high data rate services. DVB-NGH is the first world's broadcast system to include MIMO technology.

The gains achieved with MIMO can be further increased with the combination of iterative detection where the MIMO demapper and channel decoder exchange extrinsic information in an iterative fashion providing large gains. One big advantage of iterative demapping is that it only affects the receiver side and therefore it is not required to design of new transmissions system. The combination of MIMO and iterative decoding increases significantly the receiver performance. On the one hand, the MIMO demapping is one of most expensive operations at the receiver side. Optimal soft maximum a posteriori (MAP) MIMO demapping minimizes the error probability but at cost of high computational complexity which scales exponentially with the number of transmit

antennas. On the other, iterative decoding increases the complexity linearly with the number of iterations due to the repetition of channel decoder and MIMO demapping operations. Suboptimal MIMO demappers based in linear equalization vastly reduce the receiver complexity at cost of performance degradation. They apply a linear equalizer to the receive data which cancels the multi-stream interference transforming the MIMO detection problem into several independent SISO problems. Two very well known linear MIMO demappers are ZF (Zero Forcing) and MMSE (Minimum Mean Squared Error) [7] which scale the complexity polynomially with the number of transmit antennas.

During the iterative process soft information is exchanged from demapper to channel decoder and from channel decoder to demapper. This soft information is represented by log-likelihood ratios (LLRs) with reliable information of the transmitted bits. LLRs can take any real value and therefore have to be quantized to be represented with a finite number of bits in real implementations. Mobile devices such as handheld terminals are commonly memory constrained and it is desirable to represent the LLRs with as few bits as possible but without extreme performance degradations.

1.2. Objectives

The main objectives of this thesis are:

- Design of MMSE equalizer with a priori inputs in the DVB-NGH context to exploit the gains provided by iterative MIMO decoding but significantly reducing the receiver complexity.
- LLRs quantization after MIMO demapper for further approximation of a real DVB-NGH MIMO receiver implementation.
- Performance comparison of developed signal processing algorithm with reference max-log MIMO demapper under mobile vehicular NGH scenario with 60 km/h.

The rest of the thesis is structured as follows. Chapter II, describes the developed low-complexity iterative MIMO receiver for DVB-NGH using MMSE demapping and quantized LLRs. But before subsections II.1 to II.5 describe: benefits of MIMO technology, spatial multiplexing MIMO schemes chosen for the DVB-NGH base-line, MIMO demodulation and complexity, iterative decoding process together with the developed MMSE equalizer with a priori inputs and quantizer design chosen for the thesis. Section III sets the simulation environment, system parameters and channel model used for performance comparison of developed signal processing and reference max-log demapper. Simulation results are provided in section IV and finally section V draws conclusions and gives insights for future research.

II. Low Complexity Iterative MIMO Receivers for DVB-NGH Using Soft MMSE Demapping and Quantized Log-Likelihood Ratios

II.1. Benefits of Multiple Input Multiple Output Techniques (MIMO)

The implementation of multiple antennas at the transmitter and the receiver side is the only way to overcome the limitations of the Shannon capacity limit for single antenna transmission and reception (SISO) without any additional bandwidth or increased transmission power. A summary of the three benefits provided by MIMO (array gain, diversity gain and multiplexing gain) is illustrated in Figure 1. The *array gain* refers to the average increase in the received SNR (*Signal to Noise Ratio*) due to the coherent combining of the received signals at the receiver side. This results in a constant increase in terms of SNR only dependent in the antenna configuration. For co-polarized antennas, the gain is equal to 3 dB every time the number of antennas is doubled, with cross-polarized antennas the gain depends on the XPD (Cross Polarization Discrimination). In broadcast systems array gain is only available at the receiver side due to the lack of feedback channel between receiver and transmitter. *Spatial diversity gain* is achieved by averaging the fading across the propagation paths that exist between the transmit and receive antennas. If the fades experienced by each spatial path are sufficiently uncorrelated, the probability that all spatial channels are in a deep fade is lower than with single spatial path transmissions. It improves the slope of the error probability against SNR. Finally, MIMO can also increase the capacity of the system due to *multiplexing gain*, by transmitting independent data streams by each one of the transmit antennas.

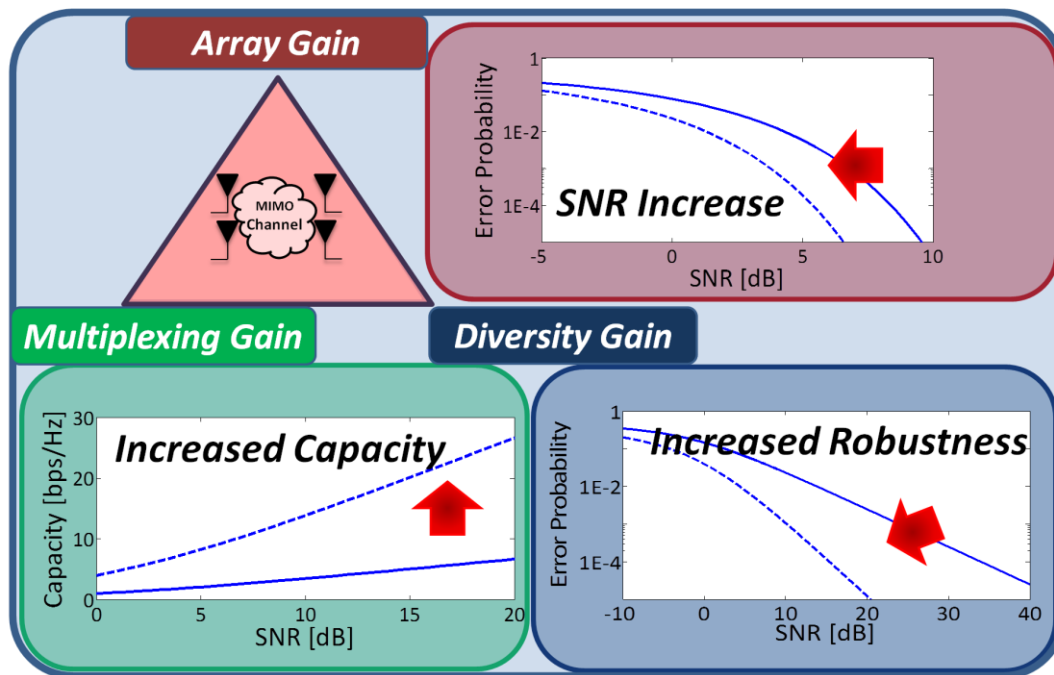

Fig. 1: Benefits in the utilization of multiple antenna MIMO techniques. Array gain which produces and average increase in the receive SNR, diversity gain which increases the resilience against fading, and multiplexing gain which increases the spectral efficiency of the network.

DVB-NGH is the first broadcast system to exploit all the degrees of freedom of the MIMO channel (array gain, diversity gain and multiplexing gain).

The different antenna configurations are defined by the number of antennas at the receiver and transmitter side. SISO (*Single Input Single Output*) has a single transmit antenna and a single receive antenna and none of the three MIMO benefits is exploited. SIMO (*Single Input Multiple Output*) has a single transmit antenna and multiple receive antennas. This is usually known as receiver diversity and there are two kinds of gains that result from the utilization of multiple receive antennas. On one hand, diversity gain is obtained by averaging fading signals across the different antenna paths. On the other hand, there is array gain due to the coherent combining of received signals. MISO (*Multiple Input Single Output*) has multiple transmit antennas and a single receive antenna. This is typically referred as transmit diversity and SFBC (*Space Frequency Block Code*) processes information symbols of adjacent subcarriers across the transmit antennas, so that they can be combined in reception in an optimum way. MIMO (*Multiple Input Multiple Output*) has multiple transmit antennas and multiple receive antennas. In addition to array and diversity gains, MIMO can be employed to provide multiplexing gain. It must be noted that SIMO provides array gain not available at MISO scheme due to the lack of feedback channel in broadcast systems.

Spatial diversity can be achieved with multiple co-polarized or cross-polarized antennas. In the former, a minimum distance between antennas is required to achieve uncorrelated fading. While co-polarized antennas at the received side can obtain important diversity gains in the case of vehicular reception, they are generally impractical in handset-based reception at UHF (*Ultra High Frequency*) frequencies, as the separation between antennas is far beyond the dimensions of typical handsets. On the other hand, cross-polarized antennas, which rely on polarization diversity, easily fit in this kind of receivers and therefore they are well suited for handset receivers in UHF range.

DVB-NGH distinguishes between MIMO rate 1 and MIMO rate 2 schemes. MIMO rate 1 schemes exploit the spatial diversity of the MIMO channel and are compatible with single transmit and single receive antennas but do not offer multiplexing gain. MIMO rate 2 schemes double the data transmission rate (multiplexing gain) but require the mandatory implementation of two transmit and two receive antennas. In the rest of the thesis we study MIMO rate 2 schemes due to exploit all the degrees of freedom of the MIMO channel.

II.2. MIMO for DVB-NGH

MIMO rate 2 codes increase the network capacity exploiting the three benefits of the MIMO channel, i.e. array, spatial diversity and multiplexing gains. Its implementation provides significant gains in the high SNR range but it is mandatory to include various antennas at both ends of the transmission chain. DVB-NGH adopts a novel technique known as eSM-PH (*enhanced Spatial Multiplexing – Phase Hopping*) which improves the performance of plain SM (*Spatial Multiplexing*).

Spatial multiplexing (SM) [8] provides both coverage and capacity gain. The incoming stream is divided in multiple independent streams which are modulated and directly fed to the different transmit antennas as it is shown in the left part of the Fig. 2.

Conventional spatial multiplexing can be improved applying a linear pre-coding before mapping the independent symbol streams to the transmit antennas. It increases the spatial diversity of the transmitted data. Enhanced spatial multiplexing (eSM) (Fig. 2) increases the system performance under correlated channels where non pre-coded SM decreases its resilience. The pre-coding applied by eSM maintains spatial diversity gain under correlated channels and multiplexing gain under spatially uncorrelated channels. The linear pre-coding mixes the modulated incoming streams by means of a rotation angle. This rotation angle has been numerically optimized by different spectral efficiencies and deliberated transmitted power imbalances. To imbalance the transmitted power between both co-located antennas can be useful to reduce the interference in adjacent channel systems and therefore eases the deployment of MIMO rate 2 for NGH. Expression (1) shows the general MIMO encoding matrix for MIMO rate 2 codes. The incoming symbols to be coded are denoted by s_1 and s_2 , and the coded symbols to be multiplexed to the different transmit antennas are denoted by x_1 and x_2 . The first matrix (left side of the expression) describes the phase-hopping term which will be explained latter. The second and the fourth matrices are employed to include in deliberated transmitted power imbalance between the two cross-polarized antennas. Finally the third matrix produces the mixing of the incoming streams by means of the rotation angle θ .

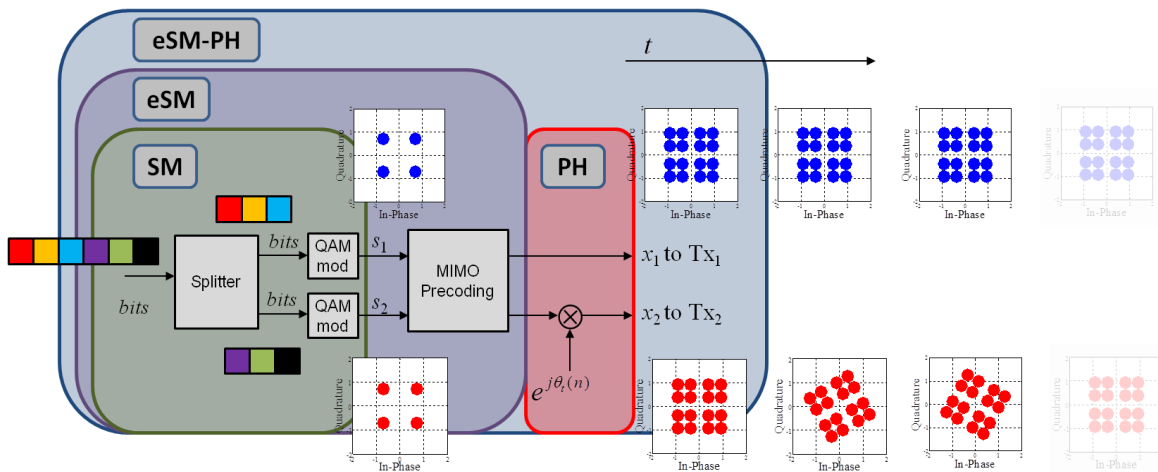

Fig. 2: Diagram of MIMO rate 2 techniques SM (*Spatial Multiplexing*), eSM (*enhanced Spatial Multiplexing*) and PH (*Phase Hopping*). SM divides the incoming stream in multiple independent modulated streams to be fed to the transmit antennas. eSM further applies a linear pre-coding for increased spatial diversity. PH changes the phase of the second stream in a periodic manner. The combination of eSM and PH, eSM-PH is the MIMO rate 2 code for NGH.

Spatial multiplexing schemes can be further enhanced with the implementation of a time variant phase rotation to the second transmitter before mapping the streams to the transmit antennas (Fig. 2), known as phase hopping (PH). The rotation phase period is defined by the parameter N defined

in expression (1) and it is set to 9. Phase hopping can be implemented with any pre-coded MIMO scheme as eSM. The combination of eSM with PH is called enhanced spatial multiplexing – phase hopping (eSM-PH), the chosen MIMO rate 2 scheme for DVB-NGH.

$$\begin{bmatrix} x_1 \\ x_2 \end{bmatrix} = \sqrt{2} \begin{bmatrix} 1 & 0 \\ 0 & e^{j\phi(k)} \end{bmatrix} \begin{bmatrix} \sqrt{\beta} & 0 \\ 0 & \sqrt{1-\beta} \end{bmatrix} \begin{bmatrix} \cos(\theta) & \sin(\theta) \\ \sin(\theta) & -\cos(\theta) \end{bmatrix} \begin{bmatrix} \sqrt{\alpha} & 0 \\ 0 & \sqrt{1-\alpha} \end{bmatrix} \begin{bmatrix} s_1 \\ s_2 \end{bmatrix}, \phi(k) = \frac{2\pi}{N}k, k = 0, \dots, N-1 \quad (1)$$

II.3. MIMO demodulation and complexity

The task of the demapper is to provide LLRs (*Log Likelihood Ratios*) to the channel decoder with reliability information of the transmitted code bits. The *optimum soft MAP (Maximum a posteriori) demapper* computes the LLR of the transmitted bit c_l with the received vector \mathbf{y} and the channel estimates \mathbf{H} with the following expression.

$$\Lambda_l = \log \frac{f(c_l = 1 | \mathbf{y}, \mathbf{H})}{f(c_l = 0 | \mathbf{y}, \mathbf{H})} = \ln \frac{\sum_{\mathbf{x} \in \chi_l^1} \exp\left(-\frac{\|\mathbf{y} - \mathbf{H}\mathbf{x}\|^2}{\sigma_w^2}\right)}{\sum_{\mathbf{x} \in \chi_l^0} \exp\left(-\frac{\|\mathbf{y} - \mathbf{H}\mathbf{x}\|^2}{\sigma_w^2}\right)} \quad (2)$$

Where σ_w^2 denotes the noise variance and χ_l^b denotes the set of transmit vectors for which c_l equals $b \in \{0, 1\}$. The computational complexity grows exponentially with the number of transmit antennas, being prohibitive even for small number of antennas. In the literature there are a vast number of algorithms and approximations to reduce the complexity. Max-log demapper applies the max-log approximation of (3) transforming (1) into (4) [9] with a small degradation penalty.

$$\log \sum_m \exp(a_m) \approx \max_m a_m \quad (3)$$

$$\tilde{\Lambda}_l = \frac{1}{\sigma_w^2} \left[\min_{\mathbf{x} \in \chi_l^1} \|\mathbf{y} - \mathbf{H}\mathbf{x}\|^2 - \min_{\mathbf{x} \in \chi_l^0} \|\mathbf{y} - \mathbf{H}\mathbf{x}\|^2 \right] \quad (4)$$

Max-log approximation eases receiver implementation due to logarithm and exponential computations are changed by minimum distances calculations. Still the complexity grows exponentially with the number of transmit antennas.

Non linear techniques like sphere decoding further reduce the complexity finding the most likely transmitted symbol from a subset of the original ML search. Significant reduction of the receiver complexity can be obtained with linear techniques like zero forcing (ZF) and minimum mean squared error (MMSE). They apply a linear equalizer to the receive data which cancels the multi-stream interference transforming the MIMO detection problem into several independent SISO problems. Zero forcing eliminates the multi-stream interference but enhances the noise degrading the performance. MMSE equalizer trades-off interference cancellation and noise

enhancement. The complexity of linear equalizer demappers scales polynomially with the number of transit antennas, significantly lower than max-log demapping.

II.4. Iterative detection: MMSE with a priori inputs.

Exploit of time, frequency and time diversity in combination with LDPC codes in BICM systems achieve spectral efficiencies very close to Shannon’s capacity limit theorem. Iterative detection reduces this gap even more. Extrinsic information is exchanged between demapper and channel decoder in an iterative manner [10]. The demapper computes extrinsic LLRs with the received vector of symbols and a priori information coming from the channel decoder. The computed extrinsic LLRs are de-interleaved to become a priori information to be fed to the channel decoder. After decoding operation the improved LLRs are used to extract the extrinsic information, which is interleaved and fed to the demapper closing the iteration loop as it is illustrated in Fig. 3. Each iteration improves the performance of the decoded stream until saturation point. After certain desired quality is achieved, the LLR decoder outputs are used for hard-decisions obtaining the final decoded bit stream.

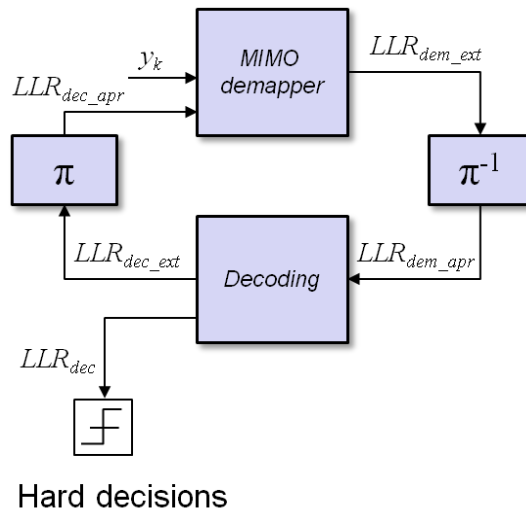

Fig. 3: Iterative exchange of extrinsic information between demapper and channel decoder

Iterative detection provides large gains at cost of higher computational complexity. The complexity increases linearly with the number of outer iterations due to the repetition of MIMO demapping and channel decoder operations, making in some cases inaccessible its real implementation. Design of number of iterations performed at the receiver (i.e. iterations of LDPC decoder and number of outer iterations) for efficient exchange of extrinsic information is out of the scope of this thesis.

MMSE with a priori inputs: As explained previous section, optimal MAP demapping requires high complexity due to it computes comparisons with all possible received signals. Lower complexity sub-optimal receivers based on linear equalization include zero-forcing receivers (ZF)

or minimum mean square error receivers (MMSE). Linear equalizers reduce multi-stream interference transforming the joint MIMO demapping problem into several independent SISO problems. Therefore the receiver complexity is significantly reduced scaling polynomially with the number of transmit antennas in comparison with the exponential grow of the reference max-log MIMO demapper.

Iterative MIMO demapping can exploit the complexity reductions offered by linear equalization but exploiting the gains provided by iterative decoding. The estimates of the MMSE equalization can be improved with the information coming from the channel decoder, i.e. MMSE equalization with a priori information. This approach has been proposed for communication systems that send data over channels that suffer from ISI (Inter Symbols Interference) and require equalization [1] - [2], and in a multiuser scenario for CDMA systems [3]. MMSE linear equalizer for non iterative schemes is illustrated in expression (5) where $\tilde{\mathbf{x}}$ is the estimated vector of transmitted symbols after linear equalization, \mathbf{y} is the vector of received symbols, \mathbf{H} is the MIMO channel matrix, σ_w^2 is the AWGN noise variance at the receiver and \mathbf{I} is the identity matrix.

$$\tilde{\mathbf{x}} = (\mathbf{H}^H \mathbf{H} + \sigma_w^2 \mathbf{I})^{-1} \mathbf{H}^H \mathbf{y} \quad (5)$$

Expression (5) can be generalized to take into account a priori knowledge from the channel decoder which is illustrated in expression (6).

$$\tilde{\mathbf{x}} = \bar{\mathbf{x}} + \text{Cov}(\mathbf{x}, \mathbf{y}) \text{Cov}(\mathbf{y}, \mathbf{y})^{-1} (\mathbf{y} - \bar{\mathbf{y}}) \quad (6)$$

Where:

$$\text{Cov}(\mathbf{x}, \mathbf{y}) = \text{Cov}(\mathbf{x}, \mathbf{x}) \mathbf{H}^H \quad (7)$$

$$\text{Cov}(\mathbf{y}, \mathbf{y}) = \mathbf{H} \text{Cov}(\mathbf{x}, \mathbf{x}) \mathbf{H}^H + \sigma_w^2 \mathbf{I} \quad (8)$$

$$\bar{\mathbf{y}} = \mathbf{H} \bar{\mathbf{x}} \quad (9)$$

The mean and variance of the transmitted vector \mathbf{x} is computed with the following expressions:

$$\bar{\mathbf{x}} = \sum_{\alpha_i \in \mathcal{X}} \alpha_i \cdot P(x = \alpha_i) \quad (10)$$

$$\text{Cov}(x, x) = \sum_{\alpha_i \in \mathcal{X}} (\alpha_i - \bar{\mathbf{x}})^2 \cdot P(x = \alpha_i) \quad (11)$$

Where the extrinsic bit probabilities are calculated from the extrinsic LLRs with the following relationships:

$$P(b = 0) = \frac{1}{1 + e^{LLR_{EXT}(b)}} \quad (12)$$

$$P(b = 1) = 1 - P(b = 0) \quad (13)$$

II.5. LLR quantization

Log-likelihood ratios computed by the MIMO demapper at the receiver side convey reliability information of the transmitted bits represented by any possible real value. In real receiver implementations LLRs have to be quantized with a finite number of bits before storage or post-processing of subsequent blocks. In memory constrained devices such as mobile handheld terminals it is desired to quantize each LLR with the minimum possible number of bits. The transformation from infinite resolution (i.e. non-quantized) to finite resolution (i.e. quantized) LLR representation introduces degradation in the system performance. In this subsection we describe the procedure for computing the quantizer parameters used in the developed DVB-NGH MIMO receiver.

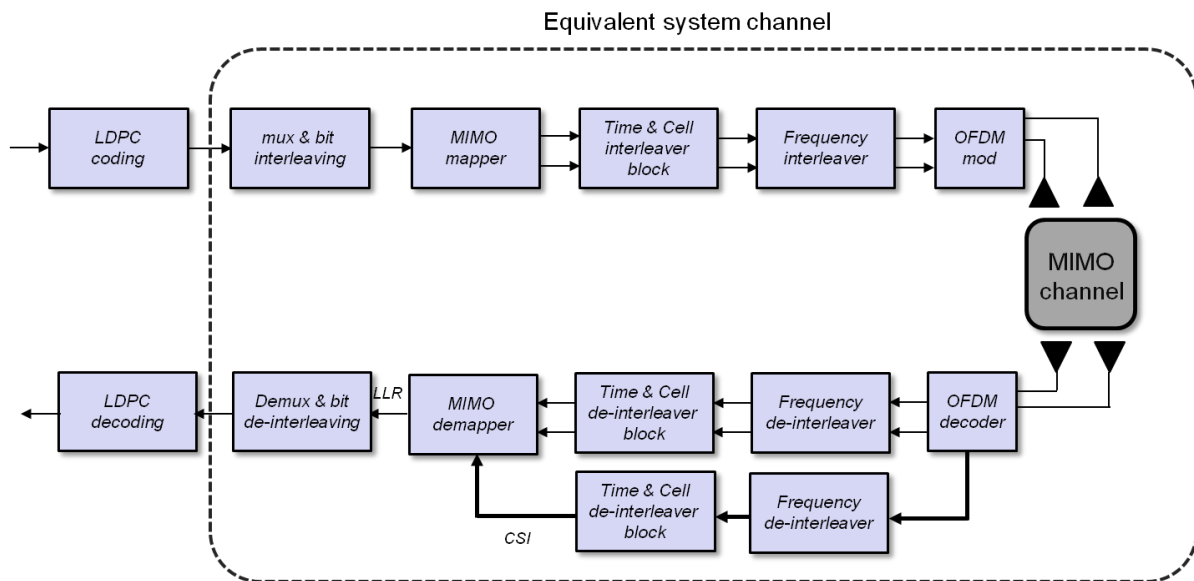

Fig. 4: DVB-NGH transmission-reception chain with equivalent system channel

The quantizer parameters are defined by the quantizer boundaries and reproducers. Our goal is to obtain a set of quantizer parameters which best describe the LLR distributions in the target scenario with reduced performance loss. First, the distributions of the LLR are numerically computed with Monte Carlo simulations for the different system configurations and channels. Here, we use the equivalent system channel illustrated in Fig. 4 for the quantizer design. It computes the LLR conditional probabilities of a transmitted bit being 0 or 1 between a code bit (at the output of the channel coder) and its corresponding LLR (at the input of the channel decoder). This approach was first proposed in [11] to study the system capacity and extended in [12] for code-independent performance comparison of different demappers. The LLR distributions change with different system channel configurations (e.g. MIMO demapping schemes) and with different channel scenarios (e.g. CNR at the receiver or reception environment), Fig. 5 illustrates the LLR distribution for the equivalent system channel of Fig.4 for two different CNRs under mobile vehicular NGH channel model with 60 km/h. Therefore different quantizer parameters are

calculated for each target CNR, system configuration and channel. Quantizer boundaries and reproducers are computed off-line and stored in look-up tables at the receiver. Then, during the reception, the receiver has to estimate the CNR in order to select the set of appropriate quantizer parameters. Quantizer parameters estimation can also be computed on-the-fly with the received data [13] but this approach is out of the scope of this thesis and is left for future work.

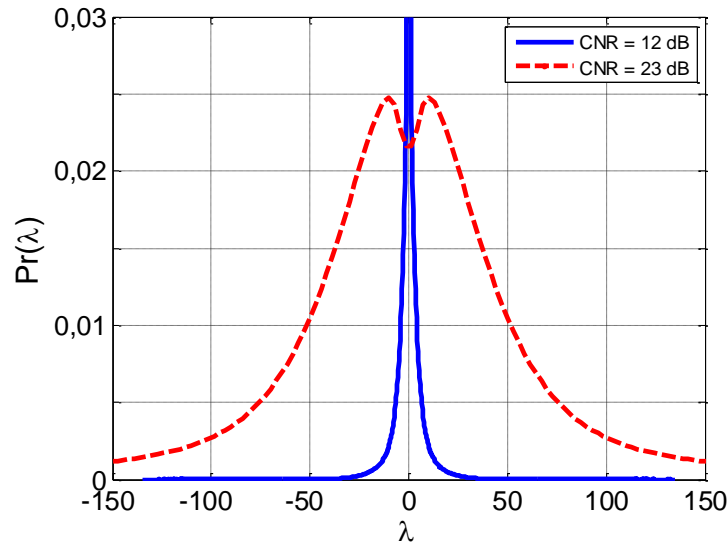

Fig. 5: LLR distribution for two different CNR values on mobile vehicular NGH channel with 60 km/h

With the LLR conditional probabilities, the quantizer boundaries and reproducers are computed by means of Information bottleneck method (IBM) [14]. This method numerically maximizes the mutual information between the transmitted bits and the quantized LLR for a fixed rate, i.e., fixed number of quantization levels. Fig. 6 illustrates the quantizer boundaries and reproducers for the unconditional LLR distribution of 14 dB of CNR with 6 quantization levels.

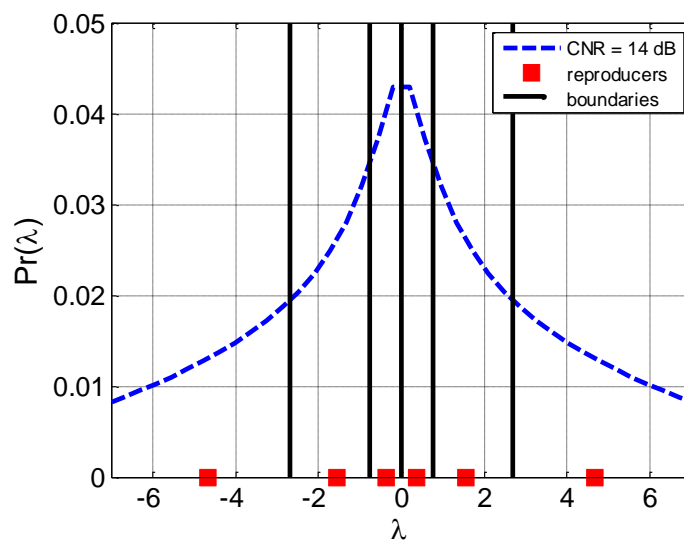

Fig. 6: Quantizer boundaries and reproducers calculated with Information Bottleneck method (IBM) under mobile vehicular NGH channel with 60 km/h

II.6 Low-complexity iterative DVB-NGH MIMO receiver

We now present the developed low-complexity iterative DVB-NGH MIMO receiver using MMSE demapping and quantized LLRs. The receiver block diagram is illustrated in Fig. 7.

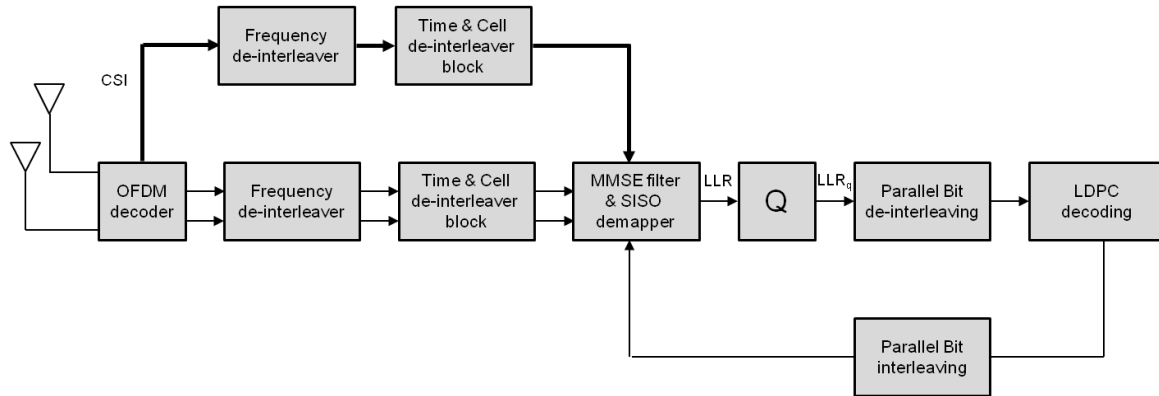

Fig. 7. Low Complexity iterative MIMO receiver for DVB-NGH using Soft MMSE demapping and quantized log-likelihood ratios

The two received signals are OFDM demodulated, removing the guard interval and transforming the signal from time to frequency domain. Then, the two received streams are independently frequency, cell and time de-interleaved to exploit frequency and time diversity respectively from the MIMO channel. We assume ideal channel estimation, i.e. perfect knowledge of the CSI (Channel State Information). As it is implemented with the received data streams, the MIMO channel estimates are de-interleaved to match the corresponding received symbols. The received data symbols, channel estimates and a priori information coming from the LDPC decoder are fed to the developed MMSE equalizer to provide estimates about the transmitted symbols. After linear equalization the corresponding LLRs of each data stream are independently calculated with 2 parallel max-log demappers. The computed LLRs are quantized, with the quantization parameters stored in a lookup table for the corresponding CNR, de-interleaved and transferred to the LDPC channel decoder. Finally, if iterative demapping is applied, the decoded LLRs are used to compute extrinsic information which is interleaved and fed back to the MMSE equalizer. Otherwise, if non-iterative demapping is implemented or the iterative process is finished, the sign of the LLRs after the LDPC decoder is used as final decoded bit stream.

III. Simulation setup

In this section we describe the selected system parameters and mobile channel model used in the simulations for performance evaluation of developed low-complexity DVB-NGH MIMO receiver.

III.1. DVB-NGH channel model

The MIMO channel model used during the standardization process was developed from a sounding campaign that took place in Helsinki in June 2010 [15]. The main objective was to obtain a 2x2 MIMO channel model (Fig. 8) in the UHF band representative of cross-polar MIMO propagation in order to evaluate the performance obtained by multiple antenna techniques in realistic scenarios. This measurement campaign was the first one with cross-polar antenna configuration in the UHF frequency range. In ideal conditions the MIMO channel is rich in scattering and all the spatial paths have uncorrelated fading signals leading to maximum channel capacity. However, in practice, fading between spatial paths experiments correlation due to insufficient scattering. Moreover in situations where the transmitter and the receiver have LOS (Line Of Sight) component, the fading is modeled by a Ricean distribution with a sum of a time-invariant fading component and a time-variant fading component. The power of both components is related by the Ricean K-factor. Spatial fading correlation and LOS component diminish the MIMO capacity [7] and both effects are included in the NGH MIMO channel model.

A wide range of reception conditions are included in the set of DVB-NGH channel models. Indoor and outdoor portable scenario with typical receiver velocities of 0 km/h and 3 km/h. Mobile vehicular outdoor scenario with receiver velocities of 60 km/h and 350 km/h. Finally, SFN (Single Frequency Network) scenarios are included with the reception from two or four transmitter sites in a SFN network.

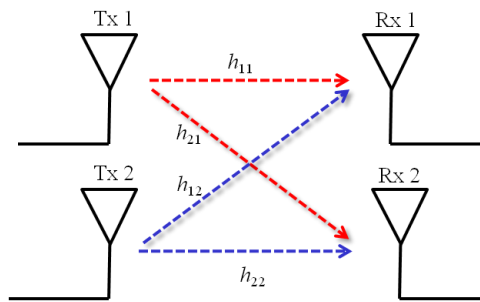

Figure 8: 2x2 MIMO system

Mobile vehicular scenario with receiver velocity of 60 km/h is the channel model used to evaluate the performance of the developed signal processing. Figure 9, illustrates the 8 taps PDP (Power Delay Profile) and the Doppler spectra characteristics. From both plots it can be seen the strong LOS component included in the model.

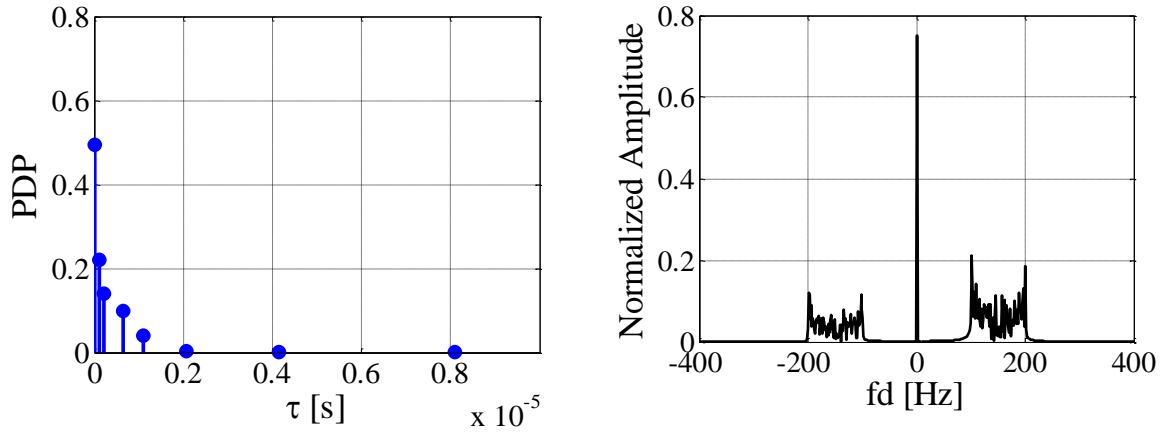

Figure 9. Power delay profile and Doppler spread spectrum for DVB-NGH portable outdoor channel model – Doppler spread of 400 Hz illustrated for visualization issues

III.2. Simulation parameters

Table 1 summarizes the system parameters selected for the performance evaluation simulations.

DVB-NGH simulation platform	
<i>FFT size</i>	4096 carriers
<i>Guard Interval</i>	1/4
<i>Memory size</i>	260 Kcells
<i>LDPC size</i>	16200
<i>Constellation order</i>	8 bpcu (16QAM+16QAM)
<i>Code Rates</i>	1/3, 8/15 and 11/15
<i>Num. iterations non iterative receiver</i>	1x50
<i>Num. iterations iterative receiver</i>	25x2
<i>QoS</i>	Frame Error Rate after BCH 10^{-2}

Table 1: System parameters

The simulated system employs a FFT size of 4096 carriers and guard interval of 1/4 to trade off network cell area and resilience against Doppler spread. DVB-NGH uses half the amount of memory allowed for DVB-T2, i.e., 260 Kcells, to due to more restrictive memory requirements for handheld devices. The LDPC size is 16200 bits, to reduce power consumption and complexity in comparison with 64800 bits LDPC code word length. The constellation order selected is 8 bpcu (bits per cell unit) which implies a 16QAM constellation in each transmit antenna. We have selected the lowest, medium and highest code rate available for MIMO transmissions in DVB-NGH. The selection on the number of iterations performed by the receiver has a crucial impact in the performance and complexity.

Non-iterative receiver – 1x50: In this case no iterative demapping is implemented and all the iterations are executed by the LDPC decoder, i.e. 50 iterations.

Iterative receiver – 25x2: For the iterative receiver, the maximum number of outer iterations, i.e., exchange of extrinsic information between LDPC decoder and MIMO demapper, is set to 25 whereas the LDPC decoder executes 2 inner iterations for every outer iteration. With this design, in

the scenario that the receiver has to perform the 25 outer iterations, it maintains the same complexity for the LDPC as for the non-iterative receiver case. When the codeword is correctly decoded the iterative process is stopped.

Finally the QoS (Quality of Service) selected is 1% of FER (Frame Error Rate) after BCH code.

IV. Results

In the next section simulation results are provided to analyze the performance of the developed low-complexity receiver for DVB-NGH. In the first section we provide a performance comparison between MMSE demapper with a priori inputs and max-log demapper for both single shot and iterative receivers (MMSE non-ID, MMSE ID, max-log non-ID, max-log ID). In the second part, performance results for designed quantizer with LLR quantization word-length of 2 and 3 bits are provided for both single shot and iterative receivers.

Demapper performance: Figure 10, illustrates performance simulation results for code rate 1/3. For single shot receivers MMSE demapper outperforms the max-log demapper by 0.15 dB. For the iterative receiver, max-log demapper outperforms MMSE by 0.2 dB. In both cases the performance of MMSE demapper is very similar to max-log but moreover the complexity is highly reduced. The iterative gain of our developed MMSE ID demapper compared to max-log non-ID demapper is 0.8 dB.

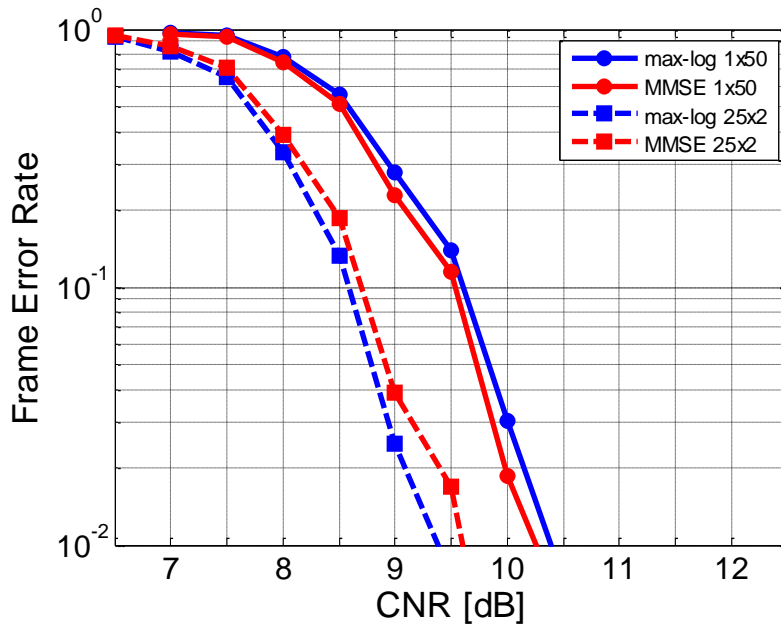

Fig. 10. MMSE and max-log demapper performance comparison for single shot and iterative receivers using 8 bpcu and code rate 1/3 in mobile vehicular DVB-NGH channel model with 60 km/h

Figure 11, shows results for code rate 8/15. In this case, MMSE demapper losses performance against max-log demapper for both cases, single shot and iterative receivers. For the former, loss is approximately by 0.4 dB and for the latter the performance loss is 0.5 dB. Still, the MMSE ID demapper outperforms max-log non-ID by 0.6 dB.

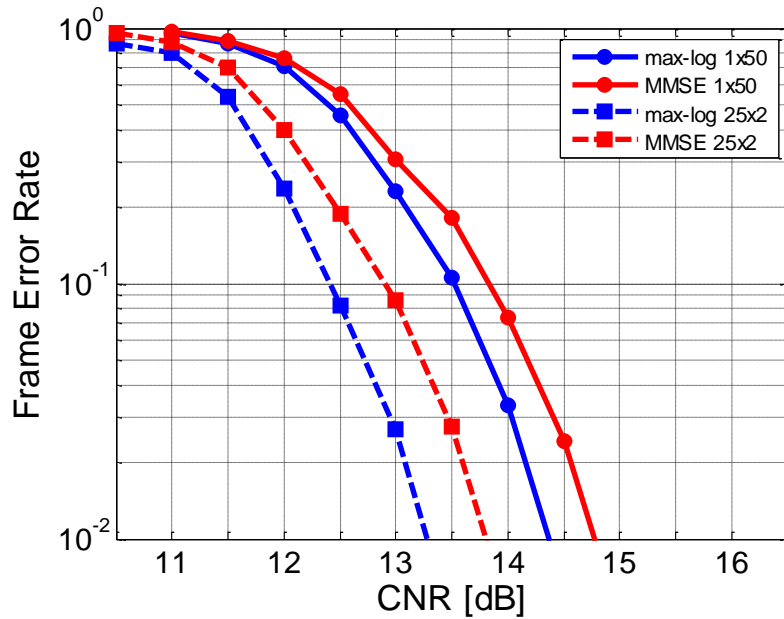

Fig.11. MMSE and max-log demapper performance comparison for single shot and iterative receivers using 8 bpcu and code rate 8/15 in mobile vehicular DVB-NGH channel model with 60 km/h

Concluding the performance comparison between demapper options, Fig. 12 shows results for code rate 11/15. In this case, the difference between MMSE demapper and max-log increases. For the non iterative case, MMSE non-ID demapper losses 1.2 dB against max-log non-ID and for the iterative case the loss of MMSE ID demapper compared to max-log ID is 1.9 dB but having similar performance to max-log non-ID.

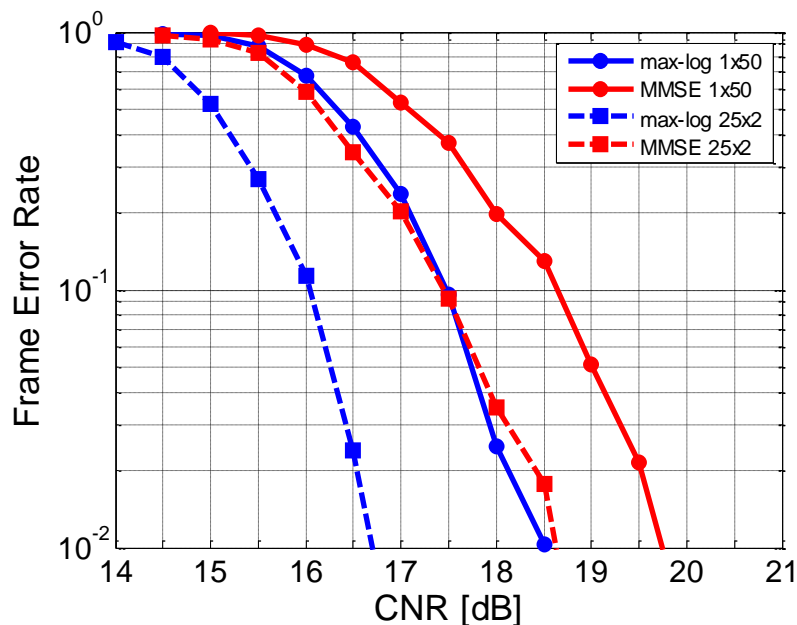

Fig.12. MMSE and max-log demapper performance comparison for single shot and iterative receivers using 8 bpcu and code rate 11/15 in mobile vehicular DVB-NGH channel model with 60 km/h

The developed MMSE demapper is able to exploit the benefits of iterative detection and moreover reduces the receiver complexity. For both, non-ID and ID receivers, soft MMSE

demapper has similar performance to max-log at low code rates, whereas at high rates MMSE demapper reduces its performance in comparison to max-log. This results are consistent with [16]. It is worth mentioning that the developed MMSE ID demapper outperforms or gives same performance than max-log non-ID demapper.

Next, we analyze the evolution of the FER with the number of outer iterations (feedback from LDPC decoder to MIMO demapper) for the two demappers under study. Figure 13 shows this evolution for code rate 1/3. The convergence of the error rate depends on the CNR available at the decoder input. For low CNR, increasing the number of iterations does not provide significant gain, e.g. 7 dB of Fig. 13. On the other hand for medium or high CNR values (e.g. 8.5 dB and 9.5 dB of Fig. 13), every outer iteration reduces the FER until saturation point, where feeding more information back to the demapper does not significantly improve the performance. This situation holds for both demappers and also for code rate 8/15 (Fig. 14). The number of outer iterations performed at the receiver is a flexible parameter which provides a trade-off between performance and complexity.

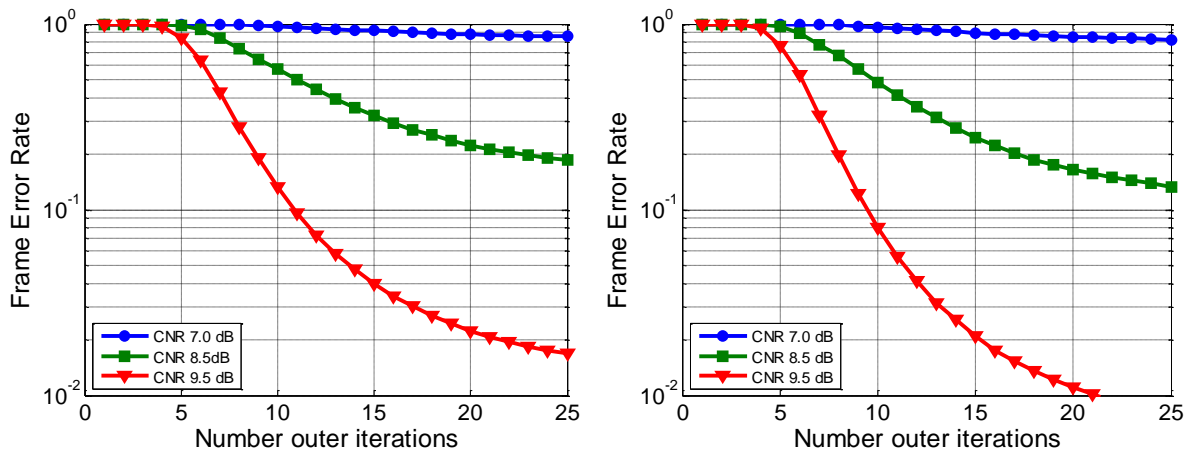

Fig.13. FER evolution with the number of outer iterations with MMSE (left) and max-log (right) demappers for 8 bpcu and code rate 1/3

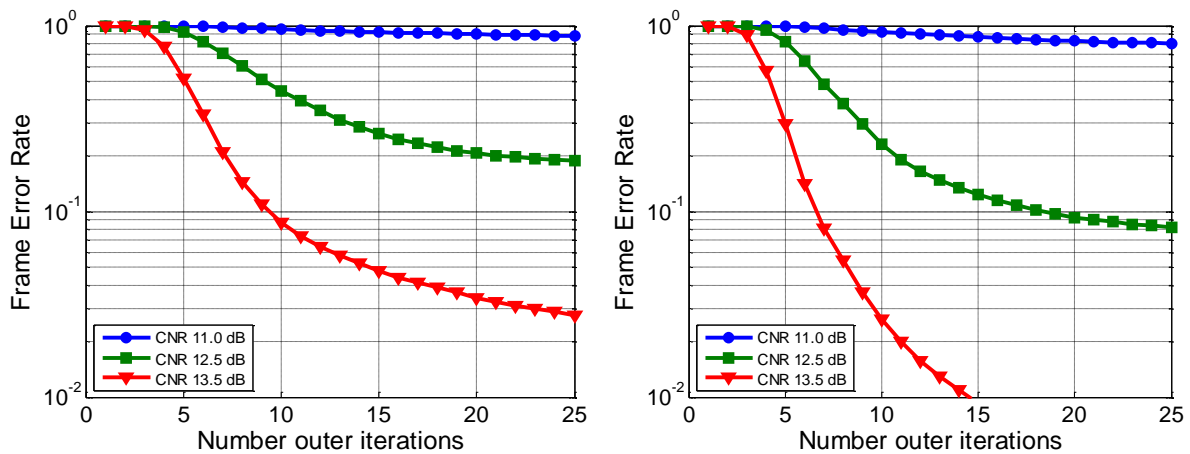

Fig.14. FER evolution with the number of outer iterations with MMSE (left) and max-log (right) demappers for 8 bpcu and code rate 8/15

LLR quantization performance: In the rest of the of the chapter, we show simulation results for LLR quantization word-lengths of 2 and 3 bits for single shot and iterative receivers. Figure 15 shows our results for the quantized DVB-NGH non-ID receiver for 8 bpcu and code rate 1/3. The gap between unquantized MMSE demapper and 2 bits quantizer word-length MMSE demapper is 1 dB whereas the loss with 3 bits quantizer length is only 0.35 dB. The results for unquantized max-log non-ID demapper are also illustrated for reference. In this case the performance of unquantized max-log demapper lies between unquantized MMSE and 3-bits quantized MMSE demappers.

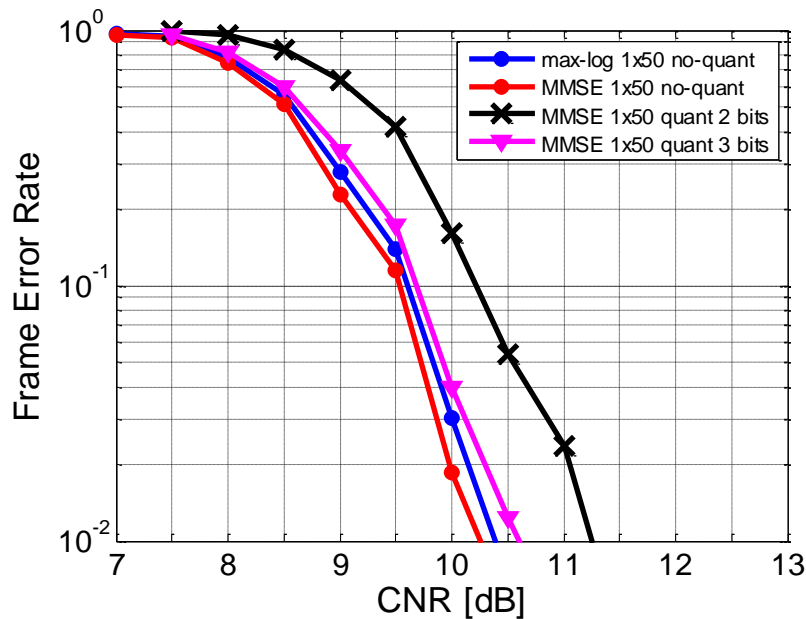

Fig.15. FER performance single shot DVB-NGH receivers for 8 bpcu and for a rate 1/3 with different LLR quantization word-lengths (2 and 3 bits)

Figure 16 shows results for 8 bpcu and code rate 1/3 but here we illustrate the performance of quantized MMSE ID demapper. The gap between unquantized MMSE demapper and 2 bits quantizer word-length MMSE demapper is 0.7 dB whereas the loss for 3 bits quantizer length is only 0.15 dB. In this case the degradation due to quantization is smaller than for non-ID, and both quantization word-lengths outperform unquantized max-log non-ID demapper.

Figure 17 shows our results for 8 bpcu and code rate 8/15 for non ID. The gap between unquantized MMSE demapper and 2 bits quantizer MMSE demappers is 0.86 dB whereas the loss with 3 bits quantizer length is 0.75 dB. In this case the best performance is given by the unquantized max-log non-ID demapper. Figure 18 also illustrates results for code rate 8/15 but in this case for the ID receiver. Here the performance loss with 2-bits quantization is 0.7 dB and for 3-bits quantization is 0.3 dB. Unquantized max-log non-ID demapper only outperforms MMSE ID demapper with 2 bits word-length quantization by 0.18 dB.

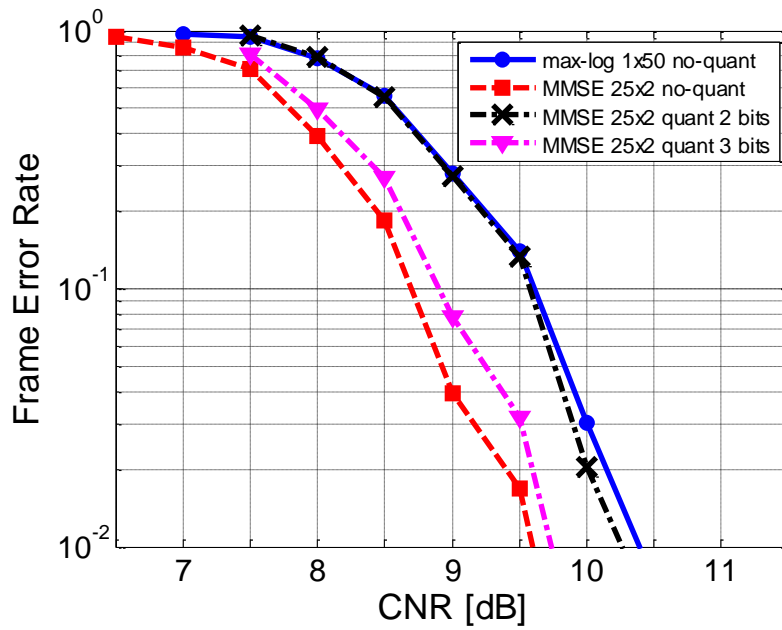

Fig. 16. FER performance iterative DVB-NGH receivers for 8 bpcu and for a rate 1/3 with different LLR quantization word-lengths (2 and 3 bits)

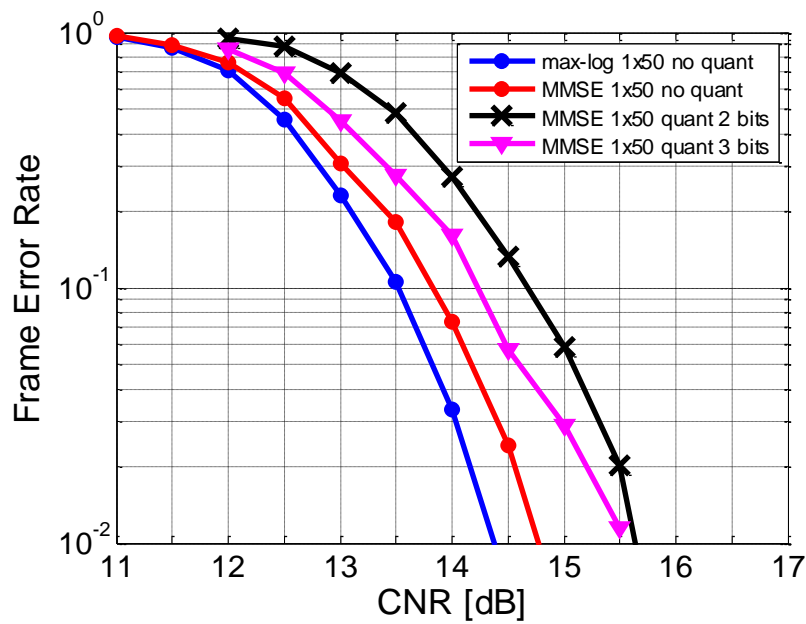

Fig. 17. FER performance single shot DVB-NGH receivers for 8 bpcu and for a rate 8/15 with different LLR quantization word-lengths (2 and 3 bits)

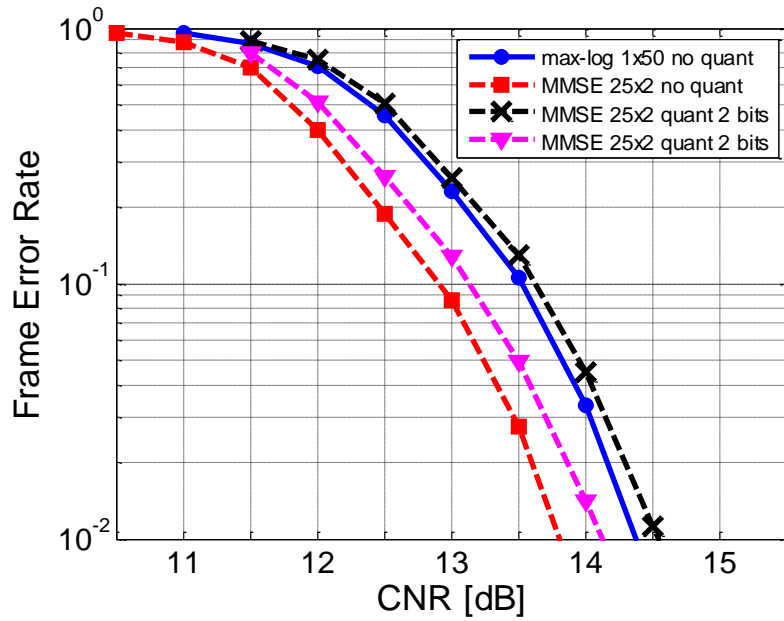

Fig. 18. FER performance iterative DVB-NHG receivers for 8 bpcu and for a rate 8/15 with different LLR quantization word-lengths (2 and 3 bits)

Finally, Fig 19 shows our results for 8 bpcu and code rate 11/15 for non ID. MMSE demapper with quantizer designs with 2-bits and 3 bits word-length representation have same performance and the difference compared to unquantized MMSE demapper is 0.96 dB. For high CNR values both curves converge from 19.5 dB due to reduced number of quantization levels is sufficient to represent the LLRs at high CNR range. Unquantized max-log non-ID demapper is clearly superior in this case outperforming both word-length quantizers by 1.2 dB. Similar situation is shown in Fig. 20 for the ID case. The performance loss due to quantization is 0.86 dB for both 2-bits and 3-bits word-length representation.

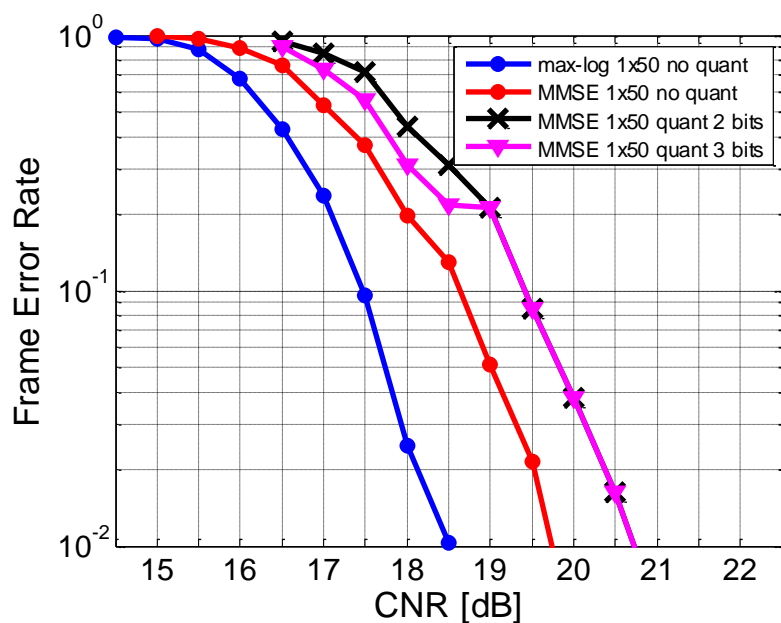

Fig. 19. FER performance single shot DVB-NHG receivers for 8 bpcu and for a rate 11/15 with different LLR quantization word-lengths (2 and 3 bits)

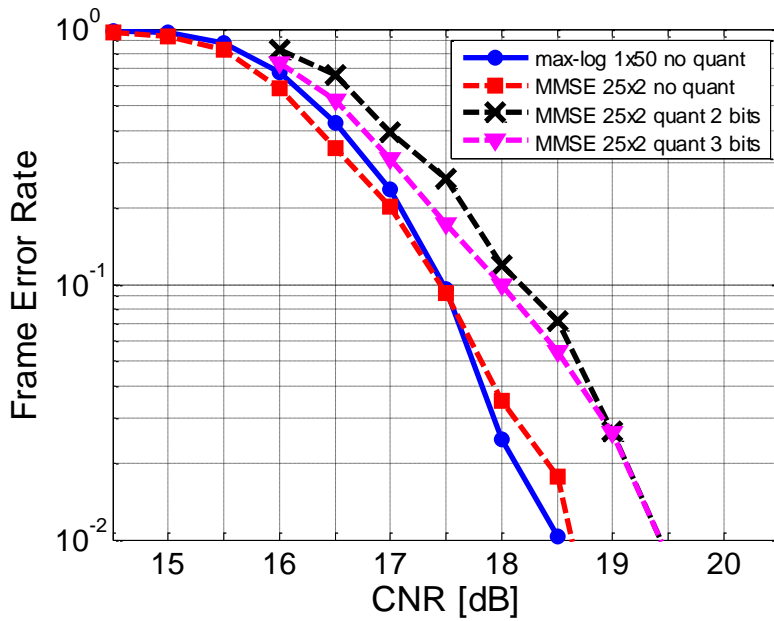

Fig. 20. FER performance iterative DVB-NGH receivers for 8 bpcu and for a rate 11/15 with different LLR quantization word-lengths (2 and 3 bits)

Through this section we have analyzed the performance of the DVB-NGH receiver with LLR quantization word-lengths of 2 and 3 bits for numerous code rates, non-ID and ID receiver under DVB-NGH mobile vehicular channel model with 60 km/h.

For 2-bits word-length case and non-ID receiver, the performance loss due to quantization for MMSE demapper is around 0.95 dB on average. In the case of ID the loss of quantized MMSE ID demapper is reduced to 0.75 dB on average.

For 3-bits word-length case and non-ID receiver, the performance loss due to quantization for MMSE demapper in the low rate regime (i.e. code rate 1/3) is 0.35 dB. As the rate increases the loss increases to 0.75 dB and 0.96 dB for code rates 8/15 and 11/15 respectively. In the case of ID the loss of quantized MMSE demapper for code rate 1/3 is reduced to 0.15 dB but as in the non-ID case the loss increases with the rate providing 0.3 dB and 0.86 dB of loss for code rates 8/15 and 11/15 respectively. The performance of 3-bit and 2-bit word-length quantizers converge at code rate 11/15 due to reduced number of levels are sufficient to represent the LLRs at high CNR values.

V. Conclusions and future Work

Finally we summarize the most important results obtained in our work and provide suggestions for further research.

V.I. Conclusions

Based on the results presented in the previous chapters we list the following conclusions:

Demapper performance: Iterative demapping provides significant gains for DVB-NGH MIMO receivers with max-log demapping. Simulation results under mobile vehicular NGH channel model with 60 km/h show gains up to 2 dB. However, the implementation of iterative MIMO demapping requires a high computational complexity which scales exponentially with the number of transmit antennas and linearly with the number of outer iterations.

The developed sub-optimal soft MMSE demapper with a priori inputs is able to exploit the benefits of iterative demapping providing gains up to 1.2 dB under simulated mobile scenario. Moreover, it significantly reduces the receiver complexity scaling polynomially with the number of transmit antennas and linearly with the number of outer iterations. Simulation results show for low code rates similar performance between soft MMSE demapper and max-log demapper for both non-iterative and iterative receivers. At medium and high code rates MMSE demapper losses performance in comparison to max-log demapper. However iterative soft MMSE demapper provides same or improved signal quality as compared to non-iterative max-log demapper for all simulated code rates.

LLR quantization: In a further approximation to a real implementation LLR quantization has been studied. The quantization has been numerically design for word-length representations of 2 and 3 bits. Simulation results under mobile scenario show maximum degradation due to quantization of 1 dB. The degradation for using 2-bits word-length representation with non iterative receiver is on average 0.95 dB and this loss is reduced to 0.75 dB if iterative demapping is implemented. In the case of 3-bits word-length representation case and non-ID receiver, the performance loss due to quantization for low code rate is 0.35 dB and the loss is reduced to 0.15 dB for iterative receiver. Here the degradation increases with the code rate having same performance than 2-bits word length representation for code rate 11/15. At high CNR vales reduced number of levels is sufficient to represent the LLRs and therefore both designs (i.e., 2 and 3 bits word-length quantizers) quantize with same number of levels.

V.II. *Future work*

Further development and possible extensions for further research are:

Demapper performance:

- In the current work 8 bpcu (16QAM + 16QAM), i.e., 16QAM constellation for each transmit antenna, has been evaluated, but other spectral efficiencies are of interest: 6 bpcu (QPSK + 16QAM), 10 bpcu (16QAM + 64QAM), and 12 bpcu (64QAM + 64QAM).
- Detailed complexity comparison of demapping options, i.e. max-log demapper and MMSE with priors demapper.
- Efficient exchange of extrinsic information between LDPC decoder and MIMO demapper (distribution of iterations at the MIMO demapper and at the decoder).

LLR quantization:

- In the current thesis only the LLRs coming from the demapper to the decoder have been quantized. In a further approximation of a real implementation the extrinsic information from the decoder to the demapper is also quantized and appropriate quantizer design has to be done.
- LLR quantizer design computation along outer iterations. In our current work the computation of the quantization values has been done considering only non-iterative structures. In order to consider iterative structures in the quantizer design two approaches could be followed. Estimation of the iterative gain by means of extrinsic information transfer (EXIT) charts. The second approach uses the same procedure for the quantizer design as for non-iterative receivers but including perfect a priori information at the MIMO demapper.
- On-the-fly design quantizers. The current LLR quantizer design has been optimized off-line by means of Monte Carlo simulations and different quantizer parameters have to be stored for every scenario and CNR. Other approach is to design the quantizer on-the-fly using the received data.

Channel estimation: A possible extension of this work is to include real channel estimation. The iterative structure could be used to improve estimates of the channel.

Acknowledgments

This M.Sc. thesis has been developed under the framework of the European Celtic project ENGINES (Enabling Next Generation Networks for Broadcast Services), the DVB-NGH standardization process and a project agreement between iTEAM and LG (South Korea) in MIMO topics.

First I would like to thank Dr. David Gómez-Barquero for his continuous support and guidance through the development of this thesis and my career. I want to thank Prof. Narcís Cardona for giving me the opportunity of being a member of his research group. I am also very grateful to Prof. Gerald Matz (Vienna University of Technology, Austria) for giving me the possibility of visiting his research group which I found a very valuable experience both professionally and personally. Thanks to Andreas Winkelbauer for enlightening discussions and for sharing his software about LLR quantization. Last but not least, I want to thank my family, my parents, sister and brother. They have always encouraged, guided and supported me through all my life, thank you.

References

- [1] C. Douillard, M. Jezequel, C. Berrou, A. Picart, P. Didier, and A. Glavieux, *Iterative correction of intersymbol interference: Turbo equalization*. European Trans. Telecomm., vol. 6, pp. 507–511, Sept.–Oct 1995.
- [2] R. Koetter, A. C. Singer, M. Tüchler, *Turbo equalization*, IEEE Signal Processing magazine, vol. 21, no. 1, pp. 67-80, January 2004.
- [3] X. Wang and H. Poor, *Iterative (turbo) soft interference cancellation and decoding for coded CDMA*, IEEE Trans. Commun., vol. 47, no. 7, pp. 1046–1061, 1999.
- [4] D. Gomez-Barquero, D. Vargas, P. Gomez, J. Llorca, C. Romero, J. Puig, J. Gimenez, J. Lopez, D. Gozalvez, N. Cardona, *DVB-NGH, la Nueva Generacion de Television Digital Movil.*, Jornadas Telecom I+D, Santander, Spain, 2011.
- [5] *Frame structure channel coding and modulation for a second generation digital terrestrial television broadcasting system (DVB-T2)*, ETSI Std. EN 302 755, Rev. 1.2.1, 2011.
- [6] *Cisco visual networking index: global mobile data traffic forecast update – 2010-2015*, White paper, February 2011
- [7] A. Paulraj, R. U. Nabar, and D. Gore, *Introduction to Space-Time Wireless Communications*. Cambridge (UK): Cambridge Univ. Press, 2003.
- [8] A. J. Paulraj, D. A. Gore, R. U. Nabar, and H. Bölcskei, *An overview of MIMO communications – A key to gigabit wireless*. Proceedings of the IEEE, vol. 92, no. 2, pp. 198–218, Feb. 2004.
- [9] S. H. Müller-Weinfurter, *Coding approaches for multiple antenna transmission in fast fading and OFDM*. IEEE Trans. Signal Processing, vol. 50, no. 10, pp. 2442–2450, Oct. 2002.
- [10] B. M. Hochwald and S. ten Brink, *Achieving near-capacity on a multiple-antenna channel*. IEEE Trans. Inf. Theory, vol. 51, no. 3, pp. 389–399, Mar. 2003.
- [11] W. Rave, *Quantization of log-likelihood ratios to maximize mutual information*. IEEE Signal Processing Letters, vol. 16, pp. 283-286, 2009.
- [12] C. Novak, P. Fertl, and G. Matz, *Quantization for soft-output demodulators in bit-interleaved coded modulation systems*. In Proc. of ISIT 2009, (Seoul, Korea), pp. 1070-1074, IEEE, June 2009.
- [13] C. Novak, *Design of multiuser and multi-antenna communication system*, Ph.D. dissertation, Vienna University of Technology, 2010.
- [14] N. Tishby, F. Pereira, and W. Bialek, *The information bottleneck method*. In Proc. of the 37-th Allerton Conference on Communication and Computation, 1999.
- [15] P. Moss et al., *DVB-NGH channel models*. DVB Technical Module, TMH0502, Nov. 2010.
- [16] P. Fertl, J. Jaldén, and G. Matz, *Capacity-based performance comparison of MIMO-BICM demodulators*. In Proc. IEEE SPAWC-2008, Recife, Brazil, July 2008, pp. 166–170.

Annex – List of contributions and publications

CONTRIBUTIONS TO STANDARDIZATION BODIES

DVB-NGH standardization process:

- **D. Vargas**, D. Gozávez and D. Gómez-Barquero, *MIMO simulations with new channel model*, TM-NGH547
- D. Gozávez, **D. Vargas** and D. Gómez-Barquero, *MIMO simulation results for DVB-NGH in the new channel model*, TM-NGH590
- **D. Vargas**, D. Gozávez and D. Gómez-Barquero, *Rate 2 MIMO simulation results*, TM-NGH696
- **D. Vargas**, D. Gozávez and D. Gómez-Barquero, *Rate 2 MIMO simulation results, round 2*, TM-NGH723
- D. Gozávez, **D. Vargas** and D. Gómez-Barquero, *MIMO simulation results for DVB-NGH, rate 2 codes*, TM-NGH761
- **D. Vargas**, D. Gozávez and D. Gómez-Barquero, —*Rate 2 Simulation Results, eSM and hSM performance comparison*, DVB TM-NGH816, standardization forum DVB-NGH, March 2011.
- **D. Vargas**, D. Gozávez and D. Gómez-Barquero, —*Simulation results with real channel estimation for NGH MIMO receivers*, DVB TM-NGH932, standardization forum DVB-NGH, June 2011.
- **D. Vargas**, D. Gozávez and D. Gómez-Barquero, —*Iterative detection for DVB-NGH MIMO eSM-PH receivers, simulation results*, DVB TM-NGH1168r1, standardization forum DVB-NGH, November 2011.
- **D. Vargas**, D. Gozávez and D. Gómez-Barquero, —*DVB-NGH MIMO ID with new QB permutations, cross-checking simulation results*, DVB TM-NGH1168r1, standardization forum DVB-NGH, November 2011.

CONTRIBUTIONS TO PUBLIC R&D PROJECTS

Celtic Project ENGINES

- *Interim report on MIMO concepts*, Technical report TR3.2, June 2011

PUBLICATIONS IN NATIONAL CONFERENCES

D. Gomez-Barquero, **D. Vargas**, P. Gomez, J. Llorca, C. Romero, J. Puig, J. Gimenez, J. Lopez, D. Gozalvez, N. Cardona, *DVB-NGH, la Nueva Generacion de Television Digital Movil.*, Jornadas Telecom I+D, Santander, Spain, 2011.

JOURNAL PAPERS

- **D. Vargas**, D. Gozávez and D. Gómez-Barquero, *MIMO for DVB-NGH, the next generation of mobile TV broadcasting*, IEEE communications magazine, to be submitted.
- **D. Vargas** et al., *Receiver implementation aspects for next generation of Mobile TV broadcasting, DVB-NGH*, IEEE transactions on broadcasting, to be submitted.

SCIENTIFIC BOOKS

D. Vargas, D. Gómez-Barquero, W. Suk, S. Moon, *Handbook of Mobile Broadcasting: chapter of MIMO for broadcasting systems*, 2nd Edition, CRC Press Editorial, to be submitted