

Energetic design and analysis of an industrial building in Horsens

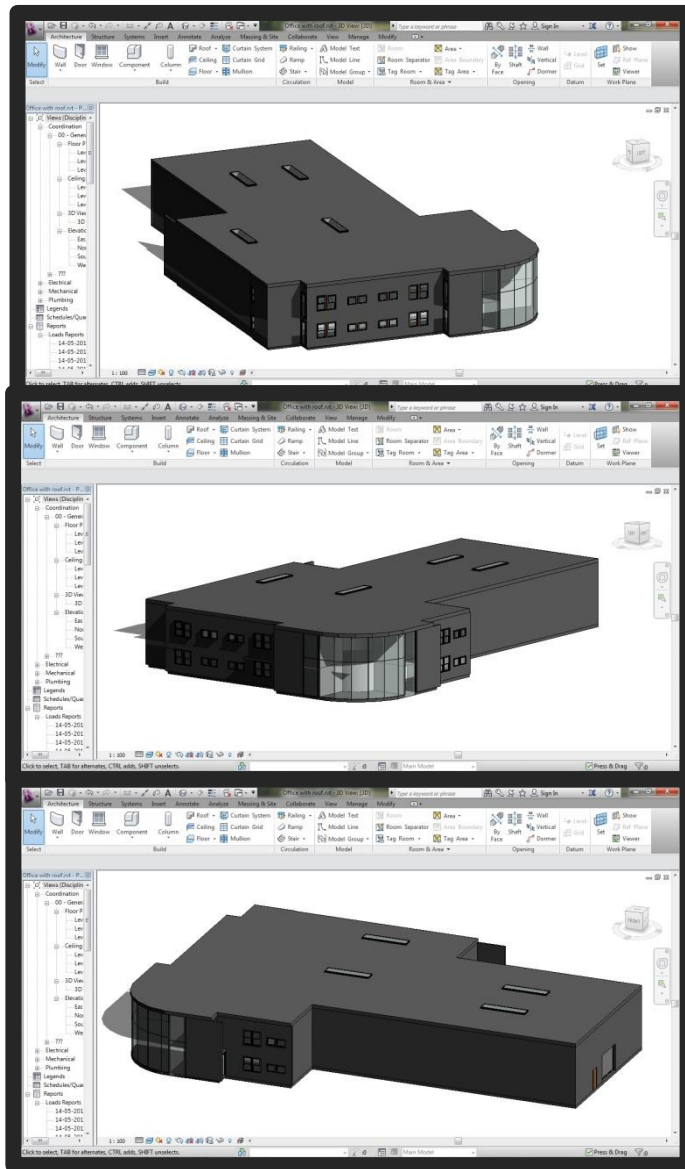

Group 23: Juan Francisco Gómez Reverte

Supervised by: Søren Alro Skovbo

10th June 2013

Contenido

Energetic design and analysis of an industrial building in Horsens	1
Methodology	2
Introduction	4
Building description	4
Location of the Building	5
Specific requirement and materials theory	6
<i>Building Physics</i>	12
<i>Heating by ventilation:</i>	24
ROTARY HEAT EXCHANGER	44
VENTILATOR	47
Storage area heating with radiators:	iError! Marcador no definido.
Fossil Boiler:	70
Seasonal thermal storage:	100
Electronic heating	101

Methodology

- ⇒ Describe the method that we have use for find all of our results
 -
- ⇒ Give the kind and sources that we have use
 - Trogisch – Planungshilfen Lüftungstechnik (Design Support Ventilation)
 - Ihle –Bader- Golla, Tabellenbuch Sanitär Heizung Klima/ Lüftung (Chart book)
 - Autodesk AutoCAD
 - Autodesk Revit 2013
 - BE10
 - SBI213
 - DS418
 - Jens Peder Pedersen, Ventilation & Indoor Climate
- ⇒ Include the details of the research process, and justify why we have choose this method.

Introduction

This study has for purpose to value and compare different energetic systems usually used in Europeans building construction. Currently, more the a half of the total energy production is spend for building's energetic demand. In valuation of the economic and environmental world context it's necessary to save the earth resources. There is several kind of strategies for try to save energy, the main aim here is to determine which are the more sustainable solutions to take care at the environment without losses too much of money. For find some solutions elements it's can be efficient to take a specific example. The adaptation of these results in some different countries and conditions will be discussed at the end. The building chooses in this rapport it's design for a wood company it must be situated in Denmark and take in count at the local requirements. It's particularly interesting because it's contains two main area the first one is an office and the second one is a storage place. That's why it's must to associate two different requirements for find the more suitable solution in this case. An economical study will be done also for find the commercial product which can be according at this specific need.

Building description

The picture on the right represents the ground floor plan of the building using in this study. The ground floor of the office area is about 390m² that makes ~ 780m² in both stories. The storing area of the building is about 770m². It's built in a steel structure. One suitable materials' envelope must to be finding for each part inside and outside.

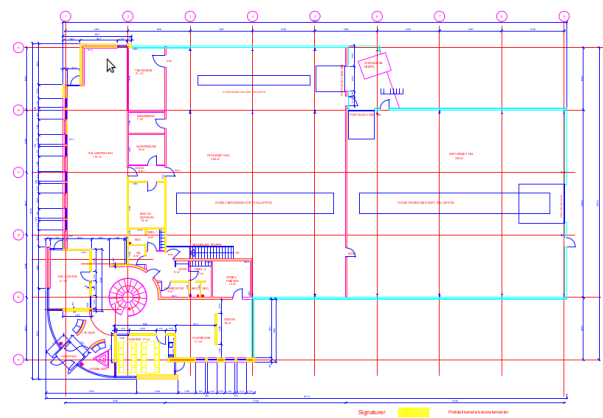

The office area is going to be developed to taking in account the comfort in all its rooms. And it must be according with the Danish employments requirements. The external walls are going to be thicker and will contain more insulation in order to avoid heat losses and create an airtight area. The first floor must to be done for receive many guest around 50 persons during some presentation. At the same time in the second floor many employers need to work in good conditions. The storing area will be used for agriculture products. There will be working around 15 persons. It's also divided in two parts: The first one is for the storage off the products principally wood straw and the second one is for store the agricultural machine.

Location of the Building

The Building is going to be located in Denmark. Specifically the place it will be in the outskirts of Horsens. The future utilization of this building can be generating some eventual noise. So, the place can't be situated just near at some residential houses. For the employers and guest accommodations the building must to be easily reachable with common transportations and have an area for park cars.



Fig. Localization in Denmark
CTE, Technical Code of Construction (Spain)

The climate conditions are cold in winter around 0°C and sweet in summer the temperature rarely exceed 25°C. In this place the energetic demand increase a lot during winter when the duration of the day is particularly short only 7 hours. The average speed of the wind is 15 km/h it's count in the heat calculation transfer.

This is the exact emplacement of the building:

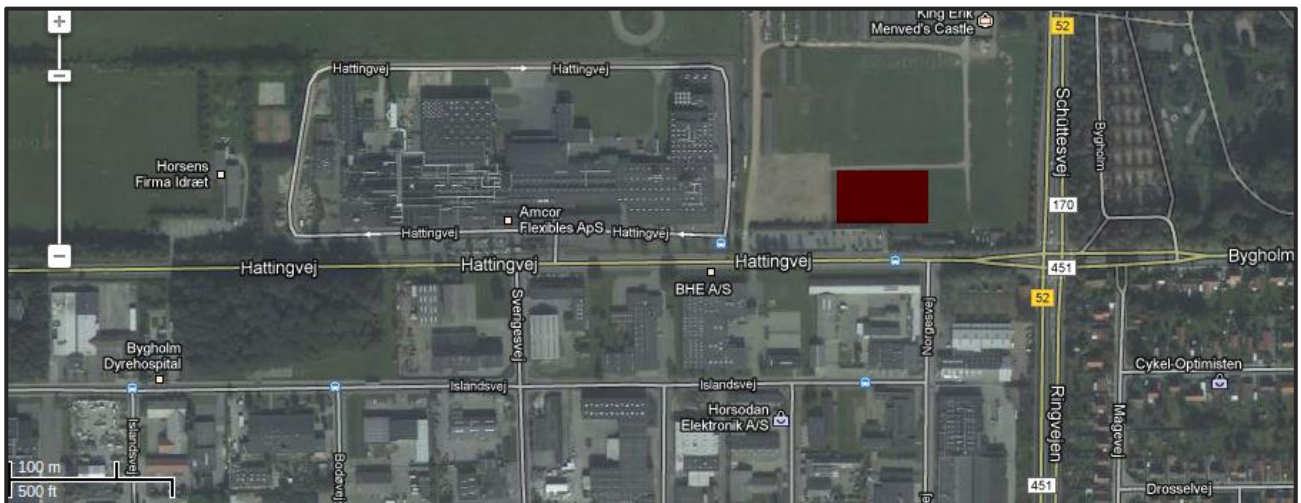

Fig. Localization in Horsens.
<https://maps.google.dk>

The terrain can be connected to the Danish electrical grid and district heating usually apply in Horsens. The sun insolation is around 1650 effective hours per years. The ground doesn't

required any specific treatment and the first airport is too much far for have any noises influences.

Specific requirement and materials theory

1. HEATING AND COOLING

The office heating requirements are:

The indoor temperature at summer might be $25^{\circ}\text{C} \pm 2^{\circ}\text{C}$, and in winter $20^{\circ}\text{C} \pm 1.5^{\circ}\text{C}$. The temperatures are measured at 1.5 meters height, in center of the rooms. Temperature variations may not exceed 2°C at any point of the office.

The storage heating requirements are:

The indoor temperature should be at a minimum of 15°C . Temperature variations may not exceed 4°C at any point of the area.

The heat losses and load (calculated afterwards) depending about the thermal factor of the materials. Some materials like wool, wood, hemp etc... they have a particularly low thermal factor, for determine heating isolation efficiency of one product the most relevant indication is it U-value. After valuation of the Danish climate the factory and the office don't need a cooling system.

2. HEALTH AND WET

In the office the health of the employer and guest it's really important. The risk of material has to be assessed to make sure that it can't have any bad impact on human health. It's particularly important to take about the heavy metals, pigments, halogen compounds. About the ventilation there must be a sufficient air exchange, but this may not result in traits feelings ($> 0,15$ m/s) .

In the factory it's very important to take care about the wet. The humidity can create some moistures who can undetermined the storage and the building structure. In a enclosure the wet can come by different way:

- infiltration and leakage of external water
- upwelling by the ground
- your daily use of habitat

The utilization of the building is going to create some wet in the office and in the storage

part (by sweating, by the storage materials etc...) After that when the atmosphere is saturate in water the condensation's phenomenon begins. This phenomenon carries at the formation of wet in water form that creates moistures particularly in winter. Because the quantity of wet for saturates the atmosphere depend about the temperature. In fact when the temperature is cold you need less wet for saturate the atmosphere. The relative humidity should be kept below 40% in winter, and below 60% in summer. For limit the wet and have a good air quality has two strategies the first one is to have a good system of ventilation where the air can circulate. The second one is to find some relevant materials (hygroscopic) for the building construction. It's also possible to put a vapor barrier like a special wall layer. For the choice of these materials the principal indication on the produce is the (μ) coefficient. It's represent the capacity of one material to resist at the humidity transportation (it should be multiply be the thickness).

3. HEARING

The acoustic in the office must be at least equivalent to Class A, according to DS490. The reverberation time in the room must not exceed 0.6 seconds. And the sound insulation should not exceed 32 dB between the rooms. The airport is far but it's important to take care about the noise product by the road circulation. The noise from installation and outside traffic may not exceed 30 dB anywhere in the office. We don't have any hearing requirement in the factory. The hearing isolation capacity depends about the materials' density.

4. LIGHT CONDITIONS

Natural sunshine has to be in any room without unnecessary shadows. There should be a daylight factor of min. 4% at all workspaces. Windows must have a light transmissions factor of minimum 0.62, and color rendering index of min. 0.92 (RA). Natural light should cover minimum 65% of the total light requirement in daytime. Artificial light must have a color rendering index of min. 95. With a relevant system of lighting, the estimation of the power consumption is around 5W / m² in the office and 4W/m² in the factory.

Materials solutions and European market

Sheep wool is a Eco-friendly product and particularly efficient for saving heating it's can be find in Europe. It's also possible to use wood wool produce by recycling but currently the market produce are less interesting. For this building it is used in a lot's of part (External office wall and roof and in the bulkhead between the office and the factory). So all of the black sheep wool will be buy in the same company at a price of 1.4€ (10,4 DKK) per kilogram.

OUTSIDE PART

A) External wall:

For the office part:

The wall will be principally constructed with sheep wood because it's particularly efficient and according with the natural product that is not useful because it's taken from black sheeps. The thickness of the sheep wool is 200mm. With an exterior little coating and the inside protection we have a global U-value of 0.1067 W/(m².K).

For the factory part:

The factory will be built with some sandwich panels particularly adapted for the agricultural storage. As it's indicating in this picture the U-value is adapted at the building. Furthermore it's have a particularly good corrosion resistance.



Panel type	Core thickness D	Width		Thickness of facings		Maximum length	Uvalue	Reaction to fire	Sound insulation value Rw
		Total	Modular	External	Internal				
	mm	mm	mm	mm	mm	mm	W/m ² K	dB	
SP ₂ CPU AGRIPRO	100/60	1083	1000	0.40	0.40	1200	0.33	B-s2,d0 Broof(t1)	≥24
	120/80						0.24		
	140/100						0.2		

Fig. Datas of ruukky.
pdf from ruukky product documentation

B) Roofs:

In the office part it's can be possible to install a green roof for follow an Eco-friendly way. It will be constituted by a growing medium and earth, a filter membrane, a drainage reservoir, a waterproofing membrane, the insulation, a reinforced concrete support and the steel structure. The insulation is done principally by sheep wool. The all for a U-value of 0,209W/(m².K). After valuation of each material the global price is around 300€ (2235 DKK) per square meter.

For the factory's roof use some sandwich panels according with the wall solution. This product is done by the same factory for a best management. As it's indicate in this picture the U-value is suitable the building requirement.

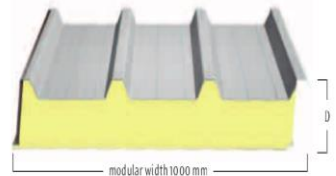

Panel type	Core thickness D	Width		Thickness of facings		Maximum length	Uvalue	Reaction to fire	Sound insulation value Rw
		Total	Modular	External	Internal				
	mm	mm	mm	mm	mm				mm
SP2B PU AGRIPRO	60	1120	1100	0.40	0.40	12000	0.33	B-s2,d0	≥24
	80						0.25		
	100						0.2		



Fig. Datas of ruukky. pdf from ruukky product documentation

All of the products done by Ruukki company (sandwich panels for the factory coat) can be negotiate at a price around 35 000€ (260 000 DKK).

C) For the entrance:

All of the windows must to be done with a triplet glasses. And their U-value of 1.11 W/(m².K) according with Velux Company product. Their price for the windows is expensive but it's a necessary investment for saving energy. The U-value of the door must to be around 0.7 W/(m².K) the more suitable solution is to use wood with one air film between two plywood.

INSIDE PART

Materials inside will be constituted in a large part by Fermacell. Take several products in the same company is particularly efficient for negotiate the price and manage the construction and product transportation. Furthermore Fermacell is a famous German company which guarantees a good quality and the proximity is acceptable. For all of their layer wall the residual humidity is between 1% and 1,5%. And the density is around 1200kg/m³. The important density of these materials permitted to have a good hearing isolation in all off the office according with requirements. After have taken a contact with this company the total price for all of the fermacell materials can be negotiated at a price around 25 000€ (290 000 DKK) including the transport from Germany.

A) Bulkhead in the office:

The Bulkhead in the office will be done with some wall's layer produce by Fermacell. The layer is constituted at 80% by gypsum and at 20% by paper fiber obtained by a method of recycling. The mixing is obtained only by using water. That's why it's a totally Eco-friendly product certified by the cologne Eco-institute. Furthermore it doesn't have any harmful substance for the heath in the composition. The noise attenuation is 34 ddb for a thickness of 12mm. The price per square meter is 11€ (82 DKK).

B) For the floor:

The product using for the floor isolation is quite similar it's product by farmacell to but is adapted for the floor. It's combined with a second layer glued constitute by a mixture of plaster and cellulose fiber. This system can be easily adapted for a underground heating. The noise attenuation is 41 ddb for the sound and 86 ddb for the impact for a thickness of 30mm. The price per square meter is 26€ (194 DKK).

C) Bulkhead between the office and the factory:

This wall which makes the separation between the factory and the office also need a good hearing isolation. The solution is to combine a fermacell layer in the office side combined with sheep wool. The price for the fermacell layer is the same. And the heat conductivity of the fermacell panels is: 0.04 W/ (m*K). And combine with the sheep wool the global U-value is: 0,2 W/(m².K). for a thickness of 20cm including the structure.

D) Bulkhead in the factory:

The requirements for this wall is really low we don't need a efficient hear or heat isolation. So to have a cheap price and a little thickness around 10cm the solution is to dress some upright each 30cm for support a mix of straw and slurry of earth shuttered. After let 3 weeks to dry it put the coating earth. For a maximal optimization about the wet a sealing film must to be add in the side where the wood are store. This kind of film is really cheap around 3€ (22 DKK) per m².

Building Physics

Thermal Conductivity (λ): if the property of one material to conduct the heat. The lowest the Thermal Conductivity of a material is, the highest is its insulating rates. It is measured in W/(m.K).

Thermal Resistance (R): of a material layer of a uniform thickness or a layered structure in the thermal steady state indicates the temperature difference between the isothermal surfaces on both sides of the structure divided by the heat flow density through the material layer .

$$R_x = \frac{d_x}{\lambda_x}$$

- **Surface thermal resistance**

R_{si} : Internal surface thermal Resistance

R_{se} : External surface thermal Resistance

R_{si} and R_{se} depends on how the flow goes through.

In walls it will be always the same value because the heat goes from inside to outside.

But for horizontal slabs there are different values depending on where is it located. If it is a roof, the heat flow goes upwards but if it is the first slab which has connection with foundations and ground, the flow will go downwards.



Flow's direction	R_{si} m ² .K/W	$R_{se}^{(1)}$ m ² .K/W	$R_{si} + R_{se}$ m ² .K/W
Vertical wall Horizontal flow 	0,13	0,04	0,17
Flow goes up Horizontal wall 	0,10	0,04	0,14
Flow goes down Horizontal wall 	0,17	0,04	0,21

Fig. Flow's direction depending on the slab
CTE, Technical Code of Construction (Spain)

Thermal Transmittance (U): indicates the heat flow density which permeates a building component in steady-state when the temperature difference between the environments on the different sides of the building component is the unit of temperature.

$$U = \frac{1}{R}$$

- **Homogeneous wall**

Thermal resistance is the sum up of all partial Resistances and the internal and external ones:

$$R = R_{si} + R_1 + R_2 + R_i + R_{se}$$

Thermal transmittance is the inverse of the Thermal Resistance, so we have: $U = \frac{1}{R}$

Partial Temperature takes in account the data of the materials which are located in between the one which is doing the calculation and the inside of the room: $t_{si} = t_i - \frac{\sum R_i}{R} (t_i - t_e)$

- **Non Homogeneous Wall**

Thermal resistance is calculated taking into account the Upper Limit Resistance and the Lower limit resistant: $R = \frac{R_U + R_L}{2}$

$$\text{Upper Limit Resistance } R_U = \frac{A}{\frac{A_a}{R_a} + \frac{A_b}{R_b} + \frac{A_i}{R_i}}$$

$$\text{Lower Limit Resistance } R_L = R_i + R_1 + R_2 + \dots + R_i + \dots + R_{se}$$

Next pages will show all the calculations for every kind of construction of the building. Constructing details are also available at the annex part of the report.

A) EXTERNALL WALL OFFICE AREA

1. Choose which is the direction of the flow

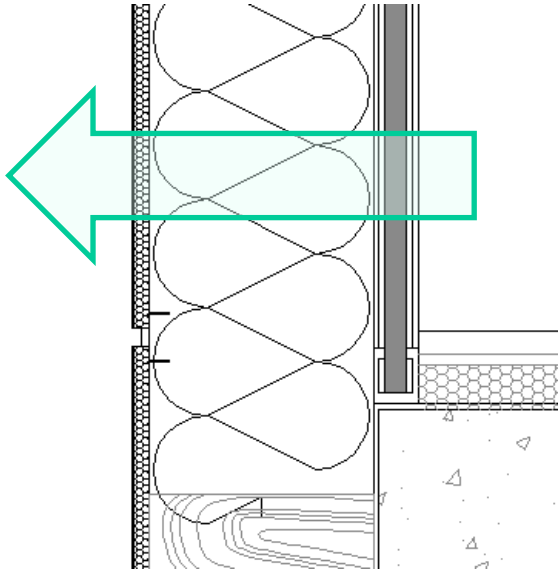

Flow's direction	R_{se} m ² .K/W	$R_{si}^{(0)}$ m ² .K/W	$R_{se} + R_{si}$ m ² .K/W
Vertical wall Horizontal flow	0,13	0,04	0,17
Flow goes up Horizontal wall	0,10	0,04	0,14
Flow goes down Horizontal wall	0,17	0,04	0,21

2. Calculate the Thermal Resistance and U-Value of the wall. As this wall has got a non-homogeneous layer it has to be calculated by Lower limit and Upper limit.

	R (m ² K /W)	A (m ²)	Total A (m ²)	%	R% (m ² K /W)	R ₃ (m ² K /W)
Timber Fr	1,000	0,041	0,470	0,088	0,088	4,180
Insulation	4,487	0,429		0,912	4,092	

Upper Limit	Total A (m ²)	A (m ²)	R (m ² K /W)	A/R	Ru (m ² K /W)
Timber	0,470	0,041	3,591	0,012	4,972
Insulation		0,559	6,732	0,083	

Lower Limit	Total A (m ²)	A (m ²)	R (m ² K /W)	A/R	Ra (m ² K /W)	RL (m ² K /W)
Timber	0,470	0,041	1,346	0,031	3,027	5,272
Insulation		0,559	4,487	0,125		

OFFICE WALL	d (m)	λ (W/mK)	R (m ² K /W)	U (W/ m ² K)
Lacquered Aluminium	0,0002	237,000	8,43882E-07	0,193
Polyurethane	0,0450	0,023	1,957	
Polyethylene	0,0002	0,550	0,000	
Timber Frames	0,1750	0,130	1,346	
Insulation: Sheep Wool	0,1750	0,039	4,487	
Gypsum board	0,0200	0,170	0,118	
Rsi			0,130	
Rse			0,040	
			5,172	

B) WINDOWS WALL PART OFFICE AREA

1. Choose which is the direction of the flow

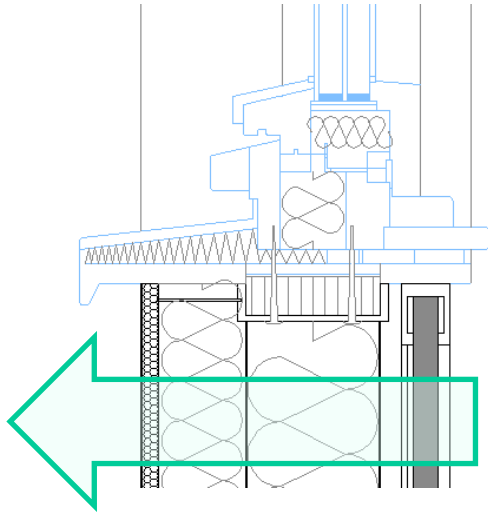

Flow's direction	R_{se} m ² .K/W	$R_{si}^{(0)}$ m ² .K/W	$R_{se} + R_{si}$ m ² .K/W
Vertical wall Horizontal flow	0,13	0,04	0,17
Flow goes up Horizontal wall	0,10	0,04	0,14
Flow goes down Horizontal wall	0,17	0,04	0,21

2. Calculate the Thermal Resistance and U-Value of the wall.

(d = Thickness of the layer)

	R (m ² K /W)	A (m ²)	Total A (m ²)	%	R% (m ² K /W)	R _s (m ² K /W)
Steel Profile	16,0000	0,003	0,600	0,005	0,084	0,123
Insulation	0,039	0,597		0,995	0,039	

Upper Limit	Total A (m ²)	A (m ²)	R (m ² K /W)	A/R	Ru (m ² K /W)
Steel Profile	0,600	0,003	2,257	0,001	6,663
Insulation		0,597	6,732	0,089	

Lower Limit	Total A (m ²)	A (m ²)	R (m ² K /W)	A/R	RX (m ² K /W)	RL (m ² K /W)
Steel Profile	0,600	0,003	0,013	0,251	1,562	3,806
Insulation		0,597	4,487	0,133		

WINDOWS STRUCTURE OFFICE	d (m)	λ (W/mK)	R (m ² K /W)	U (W/ m ² K)
Aluminium Lacado	0,0002	237,000	8,44E-07	0,200
Polyurethane	0,0450	0,023	1,957	
Polyethylene	0,0002	0,550	0,000	
Steel Profile	0,2000	16,000	0,013	
Insulation: Sheep Wool	0,1750	0,039	4,487	
Gypsum board	0,0200	0,170	0,118	
Rsi			0,130	
Rse			0,040	
			4,758	
			0,200	

c) WINDOWS and GLASS FAÇADE OFFICE AREA

1. Choose which is the direction of the flow

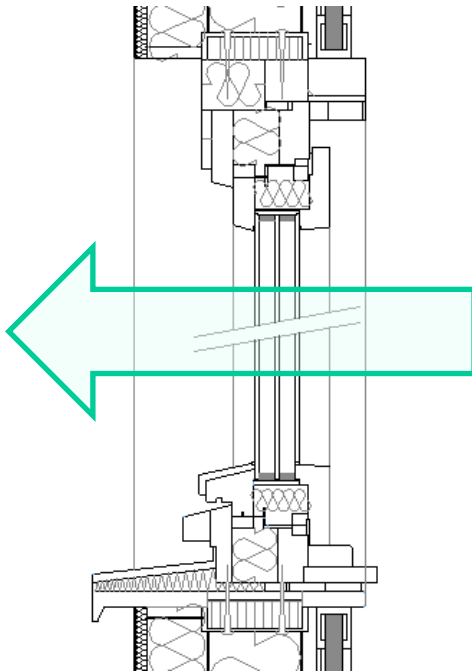

Flow's direction	R_{se} m ² .K/W	$R_{si}^{(0)}$ m ² .K/W	$R_{se} + R_{si}$ m ² .K/W
Vertical wall Horizontal flow	0,13	0,04	0,17
Flow goes up Horizontal wall	0,10	0,04	0,14
Flow goes down Horizontal wall	0,17	0,04	0,21

2. Choose which kind of glazing fits better to the weather conditions where the building is located. At the appendix it's possible to look at all the characteristics of the window because it has been calculated with an special program that allows mixing different kind of glasses and cavities.

Triple glazed windows perfect unit is 4 + 20 +4 + 20 +4 = **52mm**

Position	Product	Process	Thickness (nominal) mm	Weight kg/m ²
Glass 1	Pilkington Optitherm GS	Annealed	4	10
Cavity 1	Air		20	
Glass 2	Pilkington Optifloat Clear	Annealed	4	10
Cavity 2	Argon (90%)		20	
Glass 3	Pilkington Optitherm GS	Annealed	4	10
Product Code	4GS-20-4-20Ar-GS4		52	30

Sound Reduction	R_w dB (C;C _{tr})	NPD
Thermal Transmittance	W/m ² K	0.69

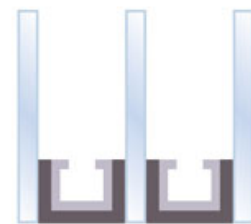
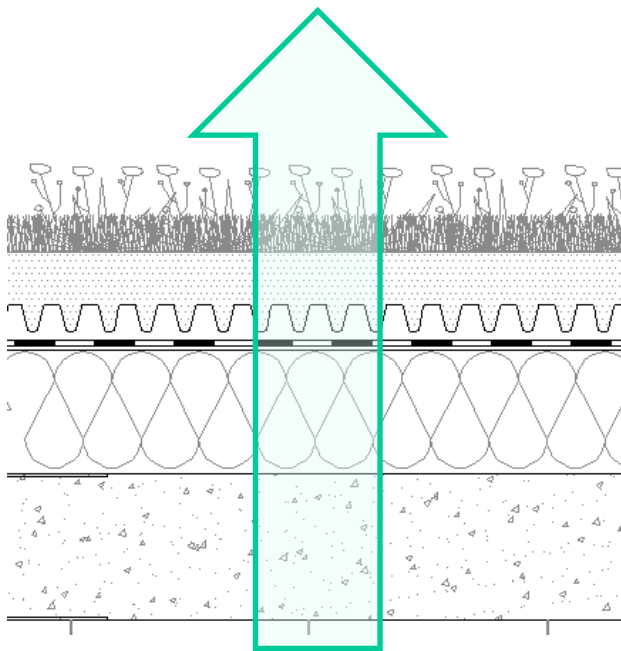

Fig. XX. Glass window choice
Pilkington

D) GREEN ROOF OFFICE AREA

1. Choose which is the direction of the flow



Flow's direction	R_{si} m ² .K/W	$R_{se}^{(1)}$ m ² .K/W	$R_{si} + R_{se}$ m ² .K/W
Vertical wall Horizontal flow	0,13	0,04	0,17
Flow goes up Horizontal wall	0,10	0,04	0,14
Flow goes down	0,17	0,04	0,21

2. Calculate the Thermal Resistance and U-Value of the roof.
(d = Thickness of the layer)

OFFICE ROOF	d (m)	λ (W/mK)	R (m ² K /W)	U (W/ m ² K)
Reinforced concret	0,300	1,630	0,184	
Insulation: Polyurethane	0,000	0,023	0,000	
Insulation: Sheep wool	0,175	0,039	4,487	
Geotextil layer	0,001	0,035	0,029	
Waterproof layer	0,001	0,029	0,034	
Drainage layer	0,070	0,950	0,074	
Rsi			0,100	
Rse			0,040	
			4,948	0,202

E) FIRST SLAB OFFICE AREA

1. Choose which is the direction of the flow

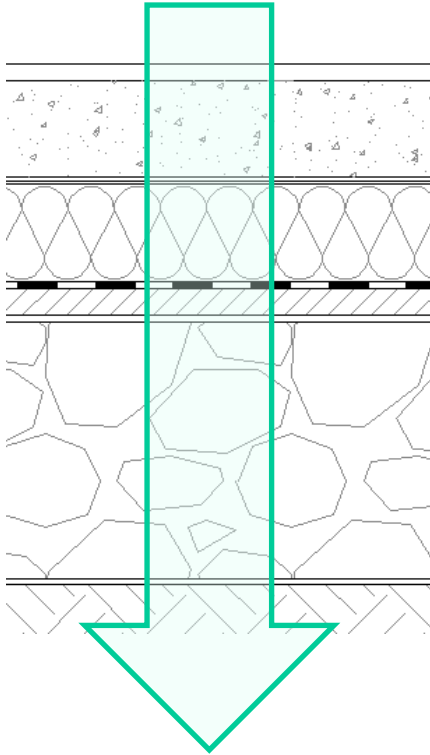

Flow's direction	R_{si} m ² .K/W	$R_{se}^{(1)}$ m ² .K/W	$R_{si} + R_{se}$ m ² .K/W
Vertical wall Horizontal flow	0,13	0,04	0,17
Flow goes up Horizontal wall	0,10	0,04	0,14
Flow goes down	0,17	0,04	0,21

2. Calculate the Thermal Resistance and U-Value of the slab
(d = Thickness of the layer)

OFFICE FOUNDATION	d (m)	λ (W/mK)	R (m ² K /W)	U (W/ m ² K)
Gravel	0,300	1,210	0,248	
Concrete	0,050	1,630	0,031	
Waterproof layer	0,001	0,029	0,034	
Insulation: Sheep Wool	0,175	0,039	4,487	
Geotextil layer	0,001	0,035	0,029	
Reinforced Concrete	0,200	1,630	0,123	
Rsi			0,170	
Rse			0,040	
			5,162	0,194

F) FIRST SLAB STORE AREA

1. Choose which is the direction of the flow

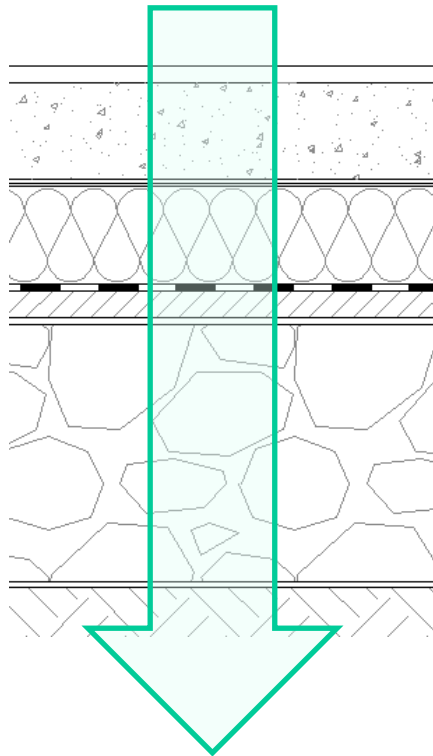

Flow's direction	R_{si} m ² .K/W	$R_{se}^{(0)}$ m ² .K/W	$R_{si} + R_{se}$ m ² .K/W
Vertical wall Horizontal flow	0,13	0,04	0,17
Flow goes up Horizontal wall	0,10	0,04	0,14
Flow goes down	0,17	0,04	0,21

2. Calculate the Thermal Resistance and U-Value of the slab
(d = Thickness of the layer)

STORAGE FOUNDATION	d (m)	λ (W/mK)	R (m ² K /W)	U (W/ m ² K)
Gravel	0,300	1,210	0,248	
Concrete	0,050	1,630	0,031	
Waterproof layer	0,001	0,029	0,034	
Insulation: Sheep Wool	0,175	0,039	4,487	
Geotextil layer	0,001	0,035	0,029	
Reinforced Concrete	0,200	1,630	0,123	
Rsi			0,170	
Rse			0,040	
			5,162	0,194

G) EXTERNAL WALL STORE AREA

1. Choose which is the direction of the flow

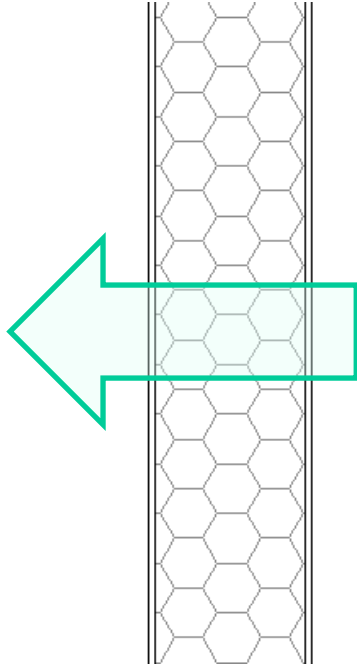

Flow's direction	R_{si} m ² .K/W	$R_{se}^{(h)}$ m ² .K/W	$R_{si} + R_{se}$ m ² .K/W
Vertical wall Horizontal flow	0,13	0,04	0,17
Flow goes up Horizontal wall	0,10	0,04	0,14
Flow goes down Horizontal wall	0,17	0,04	0,21

2. Calculate the Thermal Resistance and U-Value of the wall.
(d = Thickness of the layer)

STORAGE WALL	d (m)	λ (W/mK)	R (m ² K /W)	U (W/ m ² K)
Steel	0,0004	16,000	2,50E-05	
Glass Wool	0,1000	0,021	4,830	
Steel	0,0004	16,000	2,50E-05	
Rsi			0,130	
Rse			0,040	
			5,000	0,200

H) ROOF STORE AREA

1. Choose which is the direction of the flow

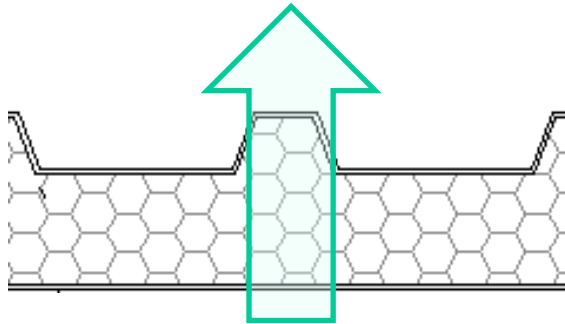

Flow's direction	R_{se} m ² .K/W	$R_{si}^{(0)}$ m ² .K/W	$R_{se} + R_{si}$ m ² .K/W
Vertical wall Horizontal flow	0,13	0,04	0,17
Flow goes up Horizontal wall	0,10	0,04	0,14
Flow goes down Horizontal wall	0,17	0,04	0,21

2. Calculate the Thermal Resistance and U-Value of the wall.
(d = Thickness of the layer)

STORAGE ROOF	d (m)	λ (W/mK)	R (m ² K /W)	U (W/ m ² K)
Steel	0,0004	16,000	2,50E-05	
Glass Wool	0,1000	0,021	4,830	
Steel	0,0004	16,000	2,50E-05	
Rsi			0,100	
Rse			0,040	
			4,970	0,201

Heating Systems

Heating by ventilation:

HVAC (heating, ventilation, and air conditioning) is a heating system usually used for medium to large industrial and office buildings. This system consisting to heat the air used for the ventilation.

VENTILATION FUNCTION

Ventilation could define like the technic that allow replace interior air of a local, considered inconvenient by lack of purity, insufficient temperature or too much moisture, for other with better characteristic.

Ventilation is the process of changing or replacing air in any space to provide high indoor air quality (to control temperature, replenish oxygen, or remove moisture, odors, smoke, heat, dust, airborne bacteria, and carbon dioxide). Ventilation is used to remove unpleasant smells and excessive moisture, introduce outside air, to keep interior building air circulation, and to prevent stagnation of the interior air.

Ventilation includes both the exchange of air to the outside as well as circulation of air within the building. It is one of the most important factors for maintaining acceptable indoor air quality in building.

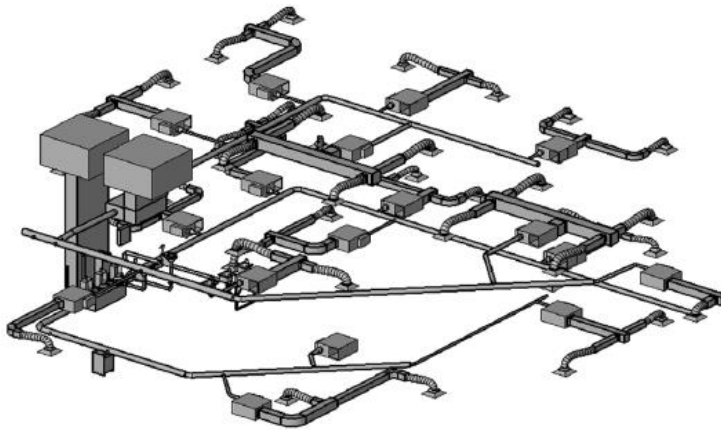

Fig. COMP Ventilation and indoor climate

TYPES OF VENTILATION

- **Over - pressure ventilation:** This kind of ventilation could be inflating air to the local getting a higher pressure than atmosphere, so air flow goes outward and in his movement takes the contaminants of the air.
- **Low pressure,** it get thank you a ventilator that extract the air from local, creating a low pressure compared with the atmospheric pressure. The air goes inside the local creating a good ventilation.
- **Mechanical or forced ventilation:** Through an air handling unit or direct injection to a space by a fan. A local exhaust fan can enhance infiltration or natural ventilation, thus increasing the ventilation air flow rate.
- **Natural ventilation** occurs when the air in a space is changed with outdoor air without the use of mechanical systems, such as a fan. Most often natural ventilation is assured through operable windows but it can also be achieved through temperature and pressure differences between spaces. Open windows or vents are not a good choice for ventilating a basement or other below ground structure. Allowing outside air into a cooler below ground space will cause problems with humidity and condensation

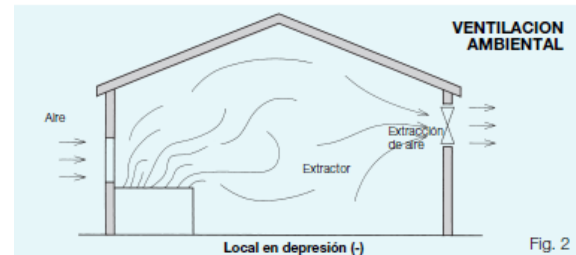
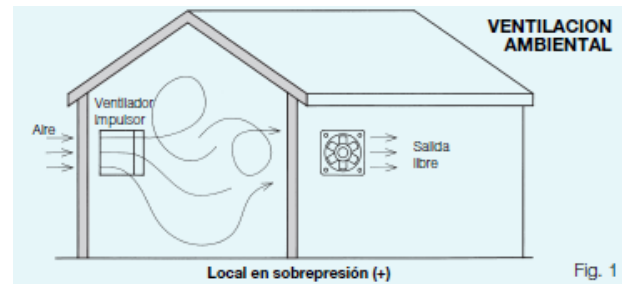

Fig. Types of ventilation. Ventilation manual. Soler&Palau

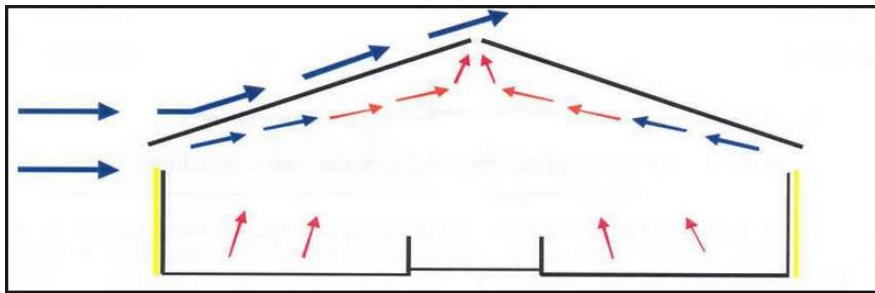

Fig. Natural ventilation from internet Soler & Palau

- **Hybrid ventilation:** utilizes both mechanical and natural ventilation processes. The mechanical and natural components may be used in conjunction with each other or separately at different times of day. The natural component, sometimes subject to unpredictable external weather conditions may not always be adequate to ventilate the desired space. The mechanical component is then used to increase the overall ventilation rate so that the desired internal conditions are met. Alternatively the mechanical component may be used as a control measure to regulate the natural ventilation process.

DESIGN CRITERIA FOR INDOOR ENVIRONMET

DS/CEN/CR 1752 – The design criteria for the indoor environment is intended to assist in providing an acceptable indoor environment for people in ventilated building. The indoor environment comprises the thermal environment, the air quality and the acoustic environment. Good ventilation provides a comfortable indoor environment with a low health risk for the occupants and uses a small amount of energy. Reducing the indoor sources of pollution and preferably adapting the ventilation rate to the actual demand are more important than increasing the outside airflow rate. DS/CEN/CR 1752 specifies three different categories of quality for the indoor environment, which can be chosen fulfilled, when a room is ventilated. Category A corresponds to a high level of expectation, Category B to a medium level of expectation and category C to a moderate level of expectation.

Type of building/space	Occupancy [pers./m ²]	Ventilation rate [l/s/m ²]		
		Category A	Category B	Category C
Single office	0,1	2,0	1,4	0,8
Landscaped office	0,07	1,7	1,2	0,7
Conference room	0,5	6,0	4,2	2,4
Auditorium	1,5	16,0	11,2	6,4
Restaurant	0,7	8,0	5,6	3,2
Classroom	0,5	6,0	4,2	2,4
Kindergarten	0,5	7,1	4,9	2,8
Department store	0,15	4,2	3,0	1,6

Table A.1 – COMP Ventilation and indoor climates - Design criteria for fresh air supply

“Ventilation stabi” states the following guiding air amounts for ventilation of different room categories.

Type of building/space	Ventilation rate [l/s/m ²] floor area	Ventilation rate [l/s]
Office		
Module office		15 – 20/person
Landscaped office		20/person
Conferenceroom		15 – 30/person
Management room		15/person
Auditorium		10 – 15/person
Staff canteen		15 – 20/person

Table A.2 – COMP Ventilation and indoor climate - Guiding air amounts (extract from ventilation stabi)

The ventilation system has to ensure a correct distribution of clean air input and stale air output in order to ensure an effective air changes in each room of the building. To assessment of the rato of ventilation in a given room, the table below can be used. This table shows the air change – how many times per hour the air in a room is changed.

Room	Air change times per hour
Accumulator room	4 - 8
Bath room	5 - 10
Bar room	10 - 15
Library	3 - 5
Safe-deposit box room	3 - 6
Dye-works	5 - 15
Shops	4 - 8
Meeting-halls	5 - 8
Garage with more than 4 cars	4
Garage with taxis, vans and busses	6
Cloakrooms	3 - 5
Hotel rooms	4 - 8
Offices	3 - 8
Kitchens (big), lower air change for small kitchens	10 - 30
Laboratories, physical	5 - 15
Laboratories, chemical	10 - 30
Storage rooms	1 - 2
Changing rooms	8 - 10
Operating room	4 - 8
Scullery	20 - 40
Restaurants	8 - 12
Classrooms	3 - 5
Spray-painting rooms	20 - 60
Department store	3 - 6
Foundries without extraction systems	10 - 20
Sickrooms	4 - 6
Toilets	5 - 15
Swimming baths	3 - 5
Laundries	5 - 15
Workshops	1 - 4

Tabel A.3 – COMP Ventilation and indoor climate – Air changes based on experience

№	m2	Pers/m2	Cat A	Air supply		Extractor		Air changes	
				m3/h	m3/s	m3/h	m3/s	v3	№
6	110	11	220	796,78	0,22133	788,4	0,219	297	6
7	21	2,1	42			151,2	0,042	56,7	8
8	7	0,7	14			25,2	0,007	18,9	2
9	10	1	20						
10	5	0,5	10						
11	15	1,5	30			16,56	0,0046	40,5	2
12	6	0,6	12			40	0,01111	16,2	15
13	3	0,3	6			40	0,01111	8,1	15
14	8	0,8	16						
15	4	0,4	8			40	0,01111	10,8	15
16	7	0,7	14			40	0,01111	18,9	15
17	12	1,2	24	86,4	0,024	86,4	0,024	0	2
18	87	8,7	174	706,4	0,19622	626,4	0,174	234,9	6
19	21	2,1	42	604,8	0,168	604,8	0,168	56,7	18
20									15
21	21	2,1	42	151,2	0,042	151,2	0,042	56,7	6
22	761	76,1	1522	5788,8	1,608	5524,12	1,53448	2068,2	4
23	18	1,8	36	129,6	0,036	129,6	0,036	48,6	6
24	18	1,8	36	129,6	0,036	129,6	0,036	48,6	6
25	18	1,8	36	388,8	0,108	388,8	0,108	48,6	8
26	4	0,4	8			40	0,01111	10,8	2
27	18	1,8	36			19,44	0,0054	48,6	2
28	43	4,3	86	308,88	0,0858	212,76	0,0591	116,1	2
29	3	0,3	6			40	0,01111	8,1	15
30	10	1	20						
31	4	0,4	8			40	0,01111	10,8	15
32	67	6,7	134	482,4	0,134	482,4	0,134	180,9	6
33	45	4,5	90	324	0,09	324	0,09	121,5	6
34	24	2,4	48	172,8	0,048	172,8	0,048	64,8	2
36	28	2,8	56	326,52	0,0907	283,2	0,07867	75,6	6

We have the target to use mechanical ventilation for our building, for this reason then we are going to have the same amount of supply air than extract air in order to prevent overpressure and under pressure.

Air pressure and changes in those pressures also affect the moisture and thermal behavior of building and construction, besides heat (temperature difference produces heat flow) and moisture (actual water vapor difference produces diffusion). Difference in air pressures is the motor which causes air to flow towards lower pressure; this air flow is called convection. The consequences of convection on structures are as follows:

- Air gets colder when flowing outwards. This may result in water vapor condensation in harmful quantities if dew point is met. This is typical in colder seasons.
- Air is warming up when flowing inward. This flow dries structures because the capacity to take moisture is increasing in the warmer air. This direction of flow is safe.

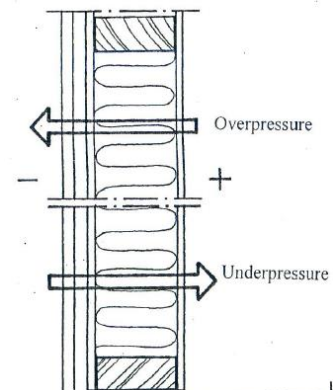

Over pressure and underpressure.
Class notes. Energy Efficiency.

DUCT DIMENSIONING

Once we know the needs of each room we proceed to calculate the duct dimension according to a good distribution in order to create a good indoor climate and don't create a bad flow of air doing the system ineffective.

The dimension of the ducts in the ventilation system is found in the following way:

Round

$$d_{round} = \sqrt{\frac{q \cdot 4}{v \cdot \pi}}$$

Square

$$w \cdot h = w/v$$

q: air amount in m^3/s

v: velocity of the air

At time to take the airspeed we have to consider that the movement of the air against the human skin produce a fresh feeling, although the supply air has the same temperature that the place where it goes

Air speed, name of speed, temperature feeling, graph of comfort feeling and right speed according to Beaufort table

FUERZA	m/s	Kn (nudos)	Km/h	English
F0	0 - 0.2	- de 1	0 - 2	calm
F1	0.3 - 1.5	1 - 3	2 - 6	light air
F2	1.6 - 3.3	4 - 6	7 - 11	light breeze
F3	3.4 - 5.4	7 - 10	12 - 19	gentle
F4	5.5 - 7.9	11 - 16	20 - 29	moderate
F5	8.0 - 10.7	17 - 21	30 - 39	fresh breeze

Airspeed agains persons	Temperature feeling
0,1 m/s	0° C
0,3 m/s	1° C
0,7 m/s	2° C
1 m/s	3° C
1,6 m/s	4° C
2,2 m/s	5° C
3 m/s	6° C
4,5 m/s	7° C
6,5 m/s	8° C

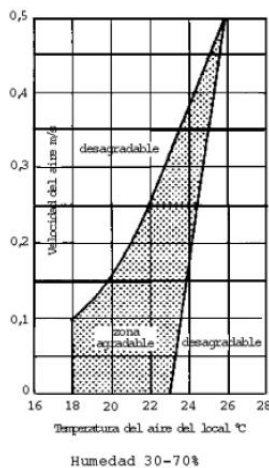

Uptake mouths	m/s
Hotels room	1,2 - 2
Comercial areas	3,0 - 4,0
Near to sitting people	2,0 - 3,0
Industrial area	5,0 - 10,0
Impulsion mouths	m/s
Hotels room	2,5 - 3
Homes	2,5 - 2,5
Office	2,5 - 4
Restaurants	5,0 - 7,0

With this study of velocities and their consequences in order to create comfort and a good quality of air.

Air velocity m/s	
Main duct	3
Branch duct	1,5
Connection duct	1,5

Once we have calculate the dimension of the duct we will choose the duct dimension according to some table of companies.

Cross-sectional area, A_c [m²]

b \ a	200	250	300	400	500	600	800	1000	1200	1400	1600	1800	2000	$A_c = a \times b$
100	0,02	0,03	0,03	0,04										
150	0,03	0,04	0,05	0,06	0,08	0,09								
200	0,04	0,05	0,06	0,08	0,10	0,12	0,16							
250		0,06	0,08	0,10	0,13	0,15	0,20	0,25						
			0,09	0,12	0,15	0,18	0,24	0,30	0,36					
				0,16	0,20	0,24	0,32	0,40	0,48	0,56	0,64			
500					0,25	0,30	0,40	0,50	0,60	0,70	0,80	0,90	1,00	
600						0,36	0,48	0,60	0,72	0,84	0,96	1,08	1,20	
800							0,64	0,80	0,96	1,12	1,28	1,44	1,60	
1000								1,00	1,20	1,40	1,60	1,80	2,00	
1200									1,44	1,68	1,92	2,16	2,40	
1400										1,96	2,24	2,52	2,80	
1600											2,56	2,88	3,20	
1800												3,24	3,60	
2000													4,00	

Lindab – Dimension of Rectangular ducts

Ød std nom	O nd m	A $\pi d^2/4$ m ²	t std mm	l std mm	ml std kg/m
63	0,198	0,003	0,5	3000	0,89
80	0,251	0,005	0,45	3000	0,91
100	0,314	0,008	0,45	3000	1,14
112	0,352	0,010	0,5	3000	1,42
125	0,393	0,012	0,45	3000	1,41
140	0,440	0,015	0,5	3000	1,76
150	0,471	0,018	0,5	3000	1,89
160	0,503	0,020	0,5	3000	2,02
180	0,565	0,025	0,5	3000	2,26
200	0,628	0,031	0,5	3000	2,56
224	0,704	0,039	0,6	3000	3,42
250 *	0,785	0,049	0,5	3000	3,18
280	0,880	0,062	0,55	3000	3,92
300 *	0,942	0,071	0,55	3000	4,20
315 *	0,990	0,078	0,55	3000	4,41
355 *	1,115	0,099	0,55	3000	4,96
400 *	1,257	0,126	0,55	3000	6,01
450 *	1,414	0,159	0,7	3000	8,60
500 *	1,571	0,196	0,7	3000	9,54
560 *	1,759	0,246	0,8	3000	12,2
600 *	1,885	0,283	0,7	3000	13,1
630 *	1,979	0,312	0,7	3000	12,0
710 *	2,231	0,396	0,8	3000	15,5
800 *	2,513	0,503	0,8	3000	17,4
900 *	2,827	0,636	0,9	3000	21,7
1000 *	3,142	0,785	0,9	3000	24,1
1120 *	3,519	0,985	0,9	3000	27,0
1250 *	3,927	1,227	0,9	3000	30,2
1400 *	4,398	1,539	1,25	2400	48,0
1500 *	4,712	1,767	1,25	2400	51,4
1600 *	5,027	2,011	1,25	2400	54,8

Lindab – Round ducts

For the insulation of the duct we will use AF/Armaflex. This insulation has a combination that gets a low u value and the engineered wall thickness of AF/Armaflex not only ensures reliable protection against condensation, but also meets the most stringent energy-saving regulations, contributing to an optimal energy efficiency of the installation.

► Unique combination of externally supervised properties:

- Euroclass B/B_L-s3,d0
- $\lambda_0 \text{ °C} \leq 0.033 \text{ W/(m} \cdot \text{K)}$
- $\mu \geq 10,000$

Duct insulation. Catalogue – AF/Armailes

Lindab – Dimension of Round ducts

DRAUGHT

Draught is an unwanted local cooling of the body caused by air movement and temperature. It is the most common cause for complaint in many ventilated spaces. A draught rating may be expressed as the percentage of people predicted to be bothered by draught.

$$Draught = (34 - t_a)(v - 0.05)^{0.62}(0.37 * v * t_u + 3.14)$$

$$Draught = (34 - 20)(0.18 - 0.05)^{0.62}(0.37 * 0.18 * 0.4 + 3.14) = 12.41\%$$

This model of draught applies to people with a thermal sensation for the whole body close to neutral. The risk of draught is lower for people feeling warmer than neutral and higher for people feeling cooler than neutral for the whole body. For people feeling warm in their body as a whole, an increased air movement will decrease the warm discomfort and will therefore normally be felt to be beneficial.

The permissible mean air velocity is given for three categories. The mean air velocity is a functional of local air temperature and turbulence intensity. The turbulence intensity may vary between 30% and 60% in spaces with mixing flow air distribution. In spaces with displacement ventilation or without mechanical ventilation, the turbulence intensity may be lower

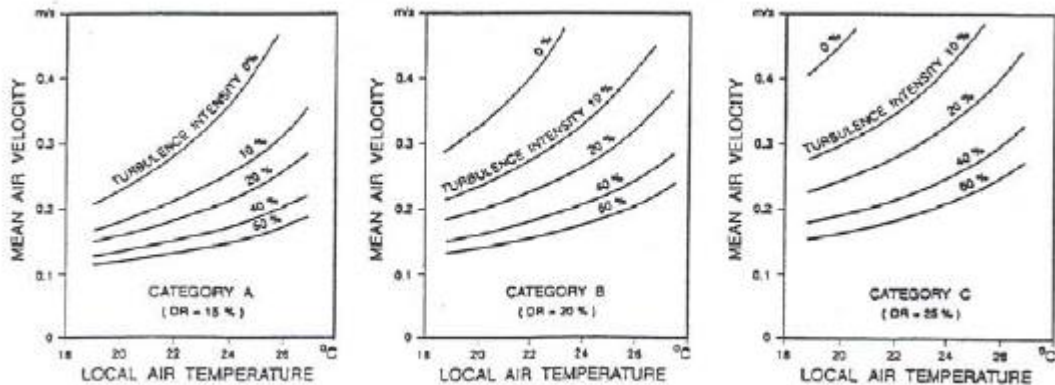

CR 1752. Draught- Turbulence %

DISTRIBUTION

GROUND FLOOR

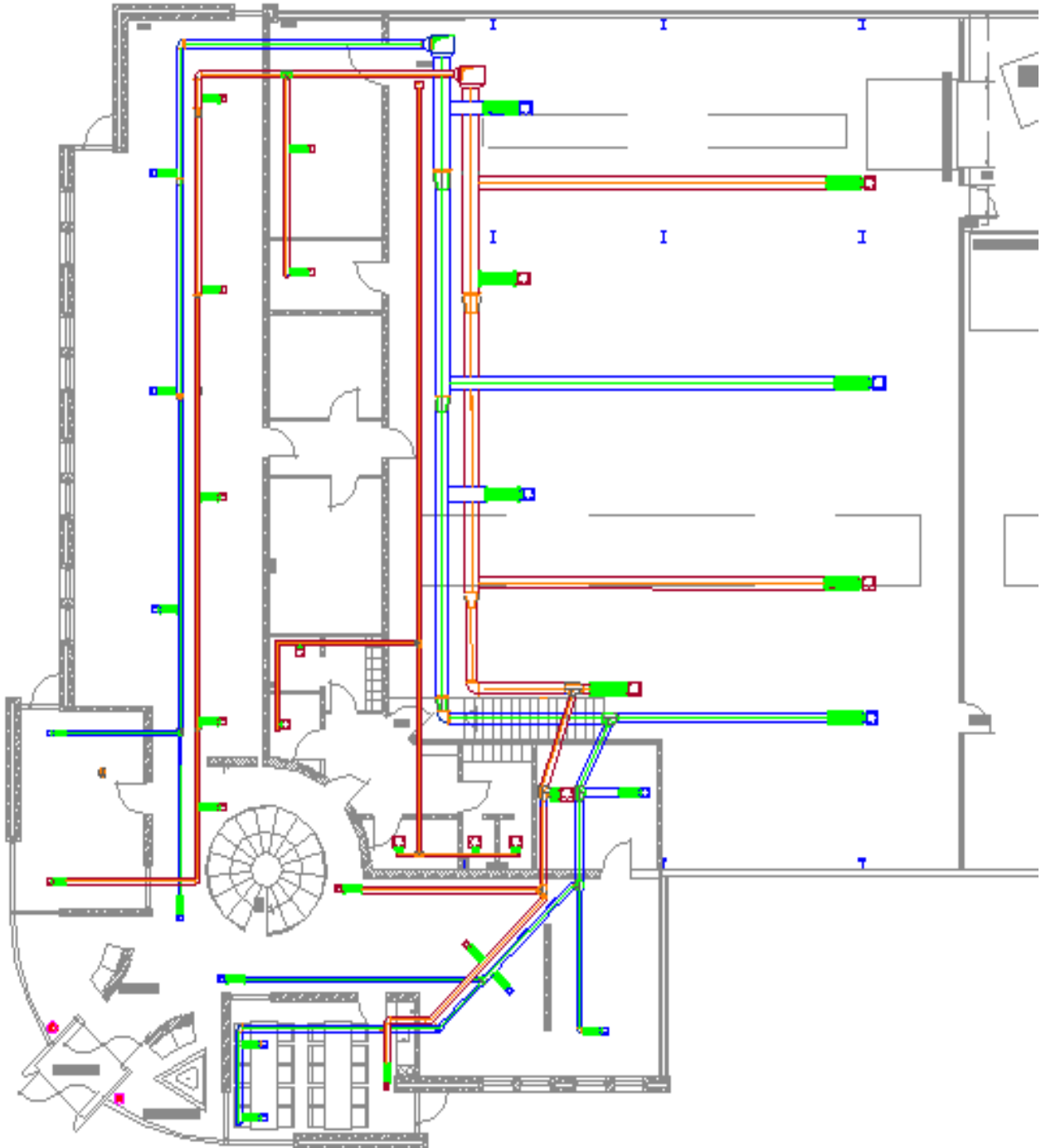

FIRST FLOOR

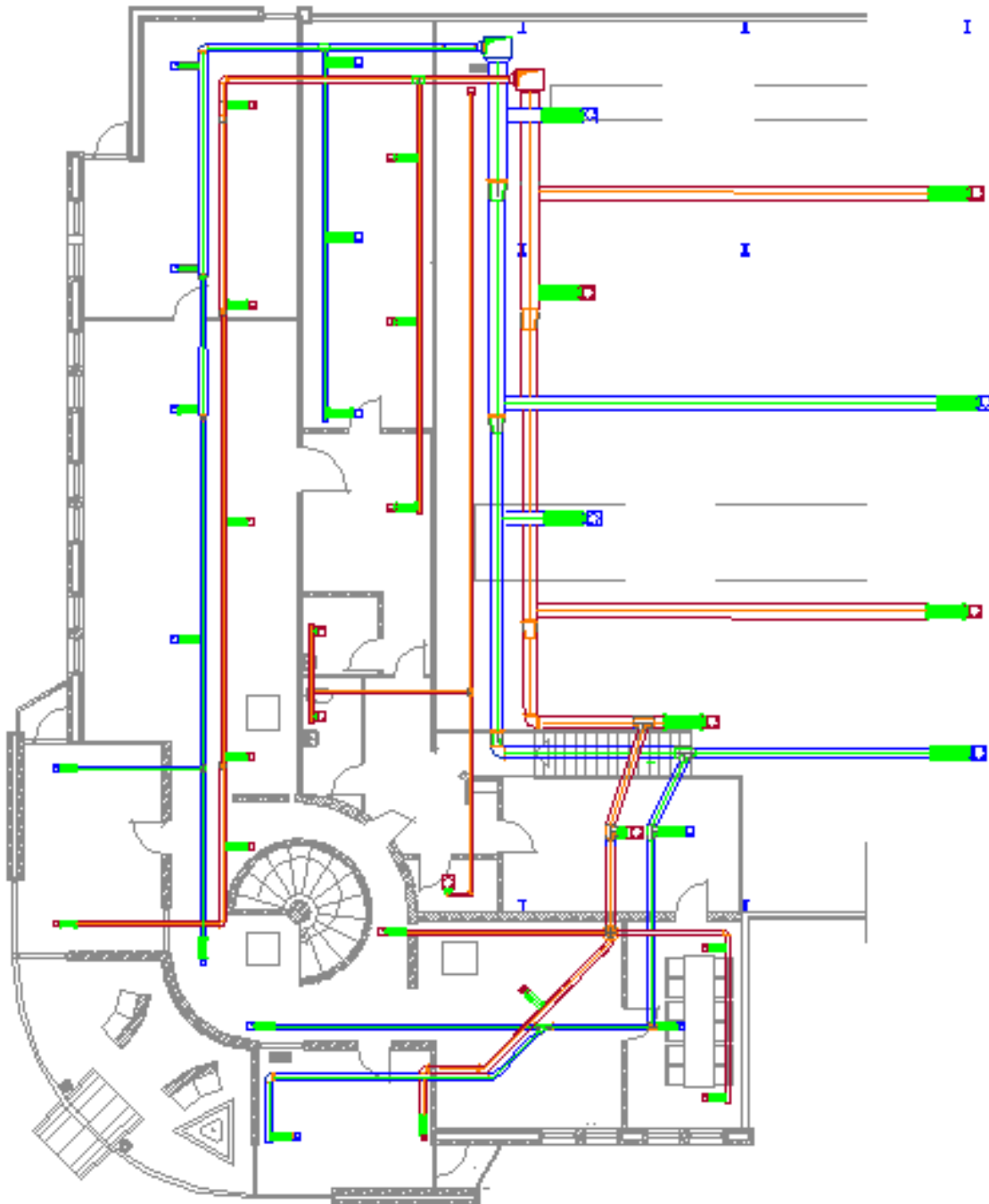

AIR SUPPLY GROUND FLOOR

	Q (m3/s)	m/s	square	b	a	round	Diametro	S(m2) square	S(m2) round	(m3/s) needed	m3/s duct square	m3/s round
A	0,312378	3	0,104126	250	400	0,364111	200	0,1	0,125664	1124,5608	1080	1357,1712
B	0,073776	1,5	0,049184	200	250	0,250246	130	0,05	0,05309304	265,5936	270	286,702416
C	0,238602	3	0,079534	200	400	0,318223	160	0,08	0,08042496	858,9672	864	868,589568
D	0,073776	1,5	0,049184	200	250	0,250246	140	0,05	0,06157536	265,5936	270	332,506944
E	0,164826	3	0,054942	250	250	0,264488	140	0,0625	0,06157536	593,3736	675	665,013888
F	0,073776	1,5	0,049184	200	250	0,250246	140	0,05	0,06157536	265,5936	270	332,506944
G	0,09105	3	0,03035	200	200	0,196578	100	0,04	0,031416	327,78	432	339,2928
H	0,04905	1,5	0,0327	200	200	0,204046	112	0,04	0,03940823	176,58	216	212,8044442
I	0,042	1,5	0,028	150	200	0,188814	100	0,03	0,031416	151,2	162	169,6464
J	2,18435	3	0,728117			0,962842	500		0,7854	7863,66		8482,32
K	0,4613	1,5	0,307533			0,62575	315		0,31172526	1660,68		1683,316404
L	1,72305	3	0,57435			0,855151	450		0,636174	6202,98		6870,6792
M	0,4613	1,5	0,307533			0,62575	315		0,31172526	1660,68		1683,316404
N	1,26175	3	0,420583			0,73178	400		0,502656	4542,3		5428,6848
Ñ	0,4613	1,5	0,307533			0,62575	315		0,31172526	1660,68		1683,316404
O	0,80045	3	0,266817			0,582856	300		0,282744	2881,62		3053,6352
P	0,4613	1,5	0,307533			0,62575	315		0,31172526	1660,68		1683,316404
Q	0,33915	3	0,11305	250	500	0,379393	200	0,125	0,125664	1220,94	1350	1357,1712
R	0,024	1,5	0,016	100	200	0,14273	80	0,02	0,02010624	86,4	108	108,573696
S	0,31515	3	0,10505	250	400	0,365723	200	0,1	0,125664	1134,54	1080	1357,1712
T	0,04905	1,5	0,0327	200	200	0,204046	112	0,04	0,03940823	176,58	216	212,8044442
U	0,04905	1,5	0,0327	200	200	0,204046	112	0,04	0,03940823	176,58	216	212,8044442
V	0,21705	3	0,07235	250	300	0,303511	160	0,075	0,08042496	781,38	810	868,589568
W	0,04905	1,5	0,0327	200	200	0,204046	125	0,04	0,0490875	176,58	216	265,0725
Y	0,168	3	0,056	250	250	0,267023	140	0,0625	0,06157536	604,8	675	665,013888
X	0,084	1,5	0,056	250	250	0,267023	140	0,0625	0,06157536	302,4	337,5	332,506944
Z	0,084	1,5	0,056	250	250	0,267023	140	0,0625	0,06157536	302,4	337,5	332,506944

AIR SUPPLY FIRST FLOOR

	Q (m ³ /s)	m/s	square	b	a	round	Diametro	S(m ²) square	S(m ²) round	(m ³ /s) needed	m ³ /s duct square	m ³ /s round
1	0,39135	3	0,13045	250	500	0,407546	224	0,125	0,157632922	1408,86	1350	1702,435553
2	0,086	3	0,028667	150	200	0,191048	100	0,03	0,031416	309,6	324	339,2928
3	0,0286	1,5	0,019067	100	200	0,155809	100	0,02	0,031416	102,96	108	169,6464
4	0,0572	3	0,019067	100	200	0,155809	80	0,02	0,02010624	205,92	216	217,147392
5	0,0286	1,5	0,019067	100	200	0,155809	80	0,02	0,02010624	102,96	108	108,573696
6	0,0286	3	0,009533	100	200	0,110173	63	0,02	0,01246901	102,96	216	134,6653123
8	0,30535	3	0,101783	250	400	0,359992	200	0,1	0,125664	1099,26	1080	1357,1712
9	0,045	1,5	0,03	150	250	0,195441	100	0,0375	0,031416	162	202,5	169,6464
10	0,26035	3	0,086783	250	400	0,332409	180	0,1	0,10178784	937,26	1080	1099,308672
11	0,045	1,5	0,03	150	250	0,195441	100	0,0375	0,031416	162	202,5	169,6464
12	0,21535	3	0,071783	250	300	0,30232	160	0,075	0,08042496	775,26	810	868,589568
13	0,067	1,5	0,044667	200	250	0,238477	125	0,05	0,0490875	241,2	270	265,0725
14	0,14835	3	0,04945	250	250	0,250921	140	0,0625	0,06157536	534,06	675	665,013888
15	0,067	1,5	0,044667	200	250	0,238477	125	0,05	0,0490875	241,2	270	265,0725
16	0,08135	3	0,027117	200	200	0,185812	100	0,04	0,031416	292,86	432	339,2928
17	0,04535	1,5	0,030233	200	200	0,196199	112	0,04	0,03940823	163,26	216	212,8044442
18	0,036	1,5	0,024	150	200	0,174808	100	0,03	0,031416	129,6	162	169,6464
19	0,23735	3	0,079117	250	250	0,317387	160	0,0625	0,08042496	854,46	675	868,589568
20	0,048	1,5	0,032	200	200	0,20185	112	0,04	0,03940823	172,8	216	212,8044442
21	0,18935	3	0,063117	250	250	0,283483	150	0,0625	0,070686	681,66	675	763,4088
22	0,022675	1,5	0,015117	100	200	0,138734	80	0,02	0,02010624	81,63	108	108,573696
23	0,108	1,5	0,072	250	300	0,302776	160	0,075	0,08042496	388,8	405	434,294784
24	0,058675	3	0,019558	150	150	0,157805	100	0,0225	0,031416	211,23	243	339,2928
25	0,022675	1,5	0,015117	100	200	0,138734	80	0,02	0,02010624	81,63	108	108,573696
26	0,036	1,5	0,024	150	200	0,174808	100	0,03	0,031416	129,6	162	169,6464

AIR EXHAUST GROUND FLOOR

	Q (m ³ /s)	m/s	square	b	a	round	Diameter	S(m ²)square	S(m ²)round	(m ³ /s) needed	3/s duct squ	m ³ /s round
1	0,362	3	0,121	250	300	0,332	200	0,075	0,125664	1303,2	810	1357,1712
2	0,054	3	0,018	100	200	0,151	150	0,02	0,070686	192,6	216	763,4088
3	0,042	1,5	0,028	150	200	0,183	180	0,03	0,10178784	151,2	162	549,65434
4	0,012	3	0,004	100	200	0,07	80	0,02	0,02010624	41,4	216	217,14739
5	0,007	1,5	0,005	100	200	0,077	100	0,02	0,031416	25,2	108	163,6464
6	0,005	1,5	0,003	100	200	0,062	80	0,02	0,02010624	16,2	108	108,5737
7	0,085	3	0,028	150	200	0,19	180	0,03	0,10178784	306	324	1039,3087
8	0,055	1,5	0,037	200	200	0,217	200	0,04	0,125664	199,71	216	678,5856
9	0,253	3	0,084	250	300	0,328	180	0,075	0,10178784	809,9	810	1039,3087
10	0,055	1,5	0,037	200	200	0,217	112	0,04	0,03340823	199,71	216	212,80444
11	0,197	3	0,066	250	300	0,289	150	0,075	0,070686	709,2	810	763,4088
12	0,055	1,5	0,037	200	200	0,217	112	0,04	0,03340823	199,71	216	212,80444
13	0,141	3	0,047	200	250	0,245	125	0,05	0,0430875	508,5	540	530,145
14	0,055	1,5	0,037	200	200	0,217	125	0,04	0,0430875	199,71	216	265,0725
15	0,086	3	0,029	150	200	0,19	100	0,03	0,031416	307,8	324	339,2928
16	0,044	1,5	0,029	150	200	0,192	100	0,03	0,031416	156,6	162	163,6464
17	0,042	1,5	0,028	150	200	0,189	100	0,03	0,031416	151,2	162	163,6464
18	2,548	3	0,849			1,04	550	0	0,950334	9173,88	0	10263,607
19	0,445	1,5	0,296			0,614	315	0	0,31172526	1600,92	0	1683,3164
20	2,104	3	0,701			0,945	500	0	0,7854	7572,96	0	8482,32
21	0,445	1,5	0,296			0,614	315	0	0,31172526	1600,92	0	1683,3164
22	1,659	3	0,553			0,839	450	0	0,636174	5972,04	0	6870,6792
23	0,445	1,5	0,296			0,614	315	0	0,31172526	1600,92	0	1683,3164
24	1,214	3	0,405			0,718	400	0	0,502656	4371,12	0	5428,6848
25	0,445	1,5	0,296			0,614	315	0	0,31172526	1600,92	0	1683,3164
26	0,323	3	0,108			0,37	200	0	0,125664	1161	0	1357,1712
27	0,024	1,5	0,016	100	200	0,143	80	0,02	0,02010624	86,4	108	108,5737
28	0,299	3	0,1			0,356	180	0	0,10178784	1074,6	0	1039,3087
29	0,044	1,5	0,029	150	200	0,192	100	0,03	0,031416	156,6	162	163,6464
30	0,044	1,5	0,029	150	200	0,192	100	0,03	0,031416	156,6	162	163,6464
31	0,222	3	0,074			0,307	160	0	0,08042496	797,4	0	868,58957
32	0,044	1,5	0,029	150	200	0,192	100	0,03	0,031416	156,6	162	163,6464
33	0,168	1,5	0,112			0,378	200	0	0,125664	604,8	0	678,5856
34	0,011	1,5	0,007	100	200	0,097	63	0,02	0,01246901	39,96	108	67,332656
35	0,011	1,5	0,007	100	200	0,097	63	0,02	0,01246901	39,96	108	67,332656
36	0,08	3	0,027	150	200	0,164	100	0,03	0,031416	288	324	339,2928
37	0,011	1,5	0,007	100	200	0,097	63	0,02	0,01246901	39,96	108	67,332656
38	0,011	1,5	0,007	100	200	0,097	63	0,02	0,01246901	39,96	108	67,332656
39	0,022	1,5	0,015	100	200	0,137	63	0,02	0,01246901	79,92	108	67,332656
40	0,08	3	0,027	150	200	0,164	100	0,03	0,031416	288	324	339,2928
41	0,16	3	0,053	250	250	0,261	140	0,0625	0,06157536	576	675	665,01389

AIR EXHAUST FIRST FLOOR

	Q (m3/s)	m/s	square	b	a	round	Diametro	S(m ²)square	S(m ²)round	(m3/s) needed	m3/s duct square	m3/s round
42	0,349	3	0,1163			0,3849	200	0	0,125664	1256,4	0	1357,1712
43	0,069	3	0,023	150	200	0,1711	100	0,03	0,031416	248,4	324	339,2928
44	0,0296	1,5	0,0197	100	200	0,1584	80	0,02	0,02010624	106,38	108	108,573696
45	0,035	3	0,0117	100	150	0,1219	63	0,015	0,01246901	126	162	134,6653123
46	0,0296	1,5	0,0197	100	200	0,1584	80	0,02	0,02010624	106,38	108	108,573696
47	0,0054	1,5	0,0036	100	200	0,0677	63	0,02	0,01246901	19,44	108	67,33265616
48	0,28	3	0,0933			0,3447	160	0	0,10178784	1008	0	1099,308672
49	0,045	1,5	0,03	150	200	0,1954	100	0,03	0,031416	162	162	169,6464
50	0,235	3	0,0783			0,3158	160	0	0,08042496	846	0	868,589568
51	0,045	1,5	0,03	150	200	0,1954	100	0,03	0,031416	162	162	169,6464
52	0,29	3	0,0967			0,3508	180	0	0,10178784	1044	0	1099,308672
53	0,067	1,5	0,0447	200	250	0,2385	125	0,05	0,0490875	241,2	270	265,0725
54	0,123	3	0,041	200	250	0,2285	125	0,05	0,0490875	442,8	540	530,145
55	0,067	1,5	0,0447	200	250	0,2385	125	0,05	0,0490875	241,2	270	265,0725
56	0,056	3	0,0187	100	200	0,1542	80	0,02	0,02010624	201,6	216	217,147392
57	0,0262	1,5	0,0175	100	200	0,1491	80	0,02	0,02010624	94,32	108	108,573696
58	0,036	1,5	0,024	150	200	0,1748	100	0,03	0,031416	129,6	162	169,6464
59	0,3524	3	0,1175			0,3867	200	0	0,125664	1268,64	0	1357,1712
60	0,048	1,5	0,032	200	200	0,2019	112	0,04	0,03940823	172,8	216	212,8044442
61	0,3044	3	0,1015			0,3594	180	0	0,10178784	1095,84	0	1099,308672
62	0,0262	1,5	0,0175	100	200	0,1491	80	0,02	0,02010624	94,32	108	108,573696
63	0,2782	3	0,0927			0,3436	180	0	0,10178784	1001,52	0	1099,308672
64	0,108	1,5	0,072	250	300	0,3028	160	0,075	0,08042496	388,8	405	434,294784
64,2	0,108	3	0,036	200	200	0,2141	112	0,04	0,03940823	388,8	432	425,6088883
65	0,0622	3	0,0207	150	200	0,1625	100	0,03	0,031416	223,92	324	339,2928
66	0,0262	1,5	0,0175	100	200	0,1491	80	0,02	0,02010624	94,32	108	108,573696
67	0,036	1,5	0,024	150	200	0,1748	100	0,03	0,031416	129,6	162	169,6464
68	0,011	1,5	0,0073	100	200	0,0966	80	0,02	0,02010624	39,6	108	108,573696
69	0,011	1,5	0,0073	100	200	0,0966	80	0,02	0,02010624	39,6	108	108,573696

HEAD LOSSES

When we have chosen the ducts we have to ensure that the duct dimension have a good section to transport necessary air amount needed in each room.

$$Caudal (m^3/h) = 3600 * v(m/s) * S(m^2)$$

Dynamic pressure is the pressure that accelerates the air flow since 0 to the regimen speed

$$P_d = v^2/16(mm cda).$$

Once the duct is able to transport the air amount we have to calculate the headloss. The air pressure need overcome the friction on a duct, this determine the energy spending of ventilator, is called head loss. It is calculated in base the lenght of the duct, its diametre, the density, the airspeed and the friction coefficient.

The calculation of head losses are done thank you the methods of coefficient "n". With this method we can know how much losses has each duct due to some accidents inside of the duct, changes of direction.

$$\Delta P = n * P_d(mm cda)$$

In that drawings attachments are show the n coefficient in the air flow for the duct, since his uptake to delivery. The ducts do not have to be always straight, they are composed by a lot of accidents in their journey, like changes of direction or chages of diameter. All of them create resistance against the flow causing head losses. To know the total resistance will be need calculate all the losses in all the duct and add them to the losses of the straight duct.

It is normal that we have to change the section of the duct, increasing or decreasing. When the changes are strong, it is possible know the coefficient of head loss in relation with the diametre and for the some graph. In case of a big diminution of the diameter the edge have a bid influence in the head losses.

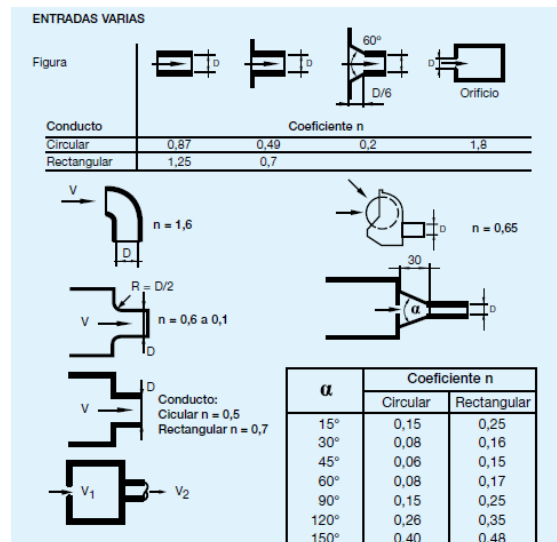

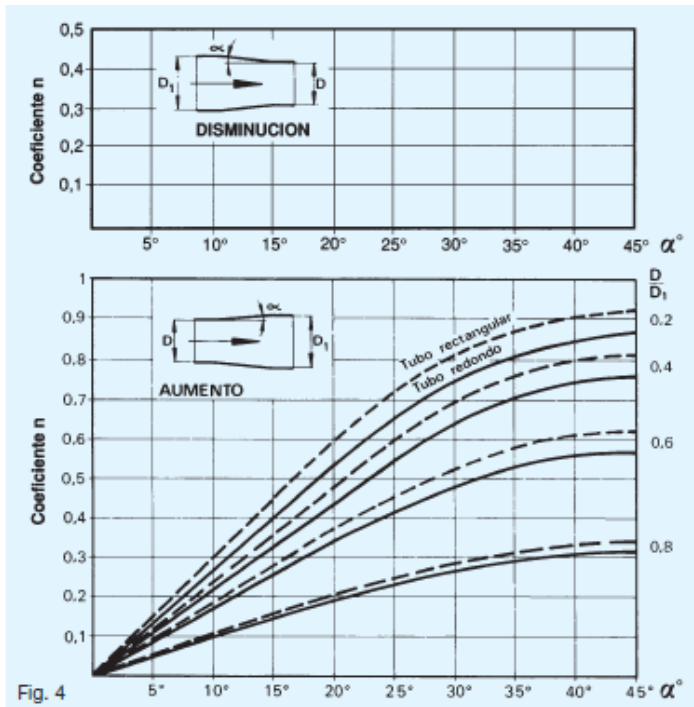

Coefficient n, headlosses calculation - Manual ventilación. Soler&Palau

Convergence and bifurcation of caudal

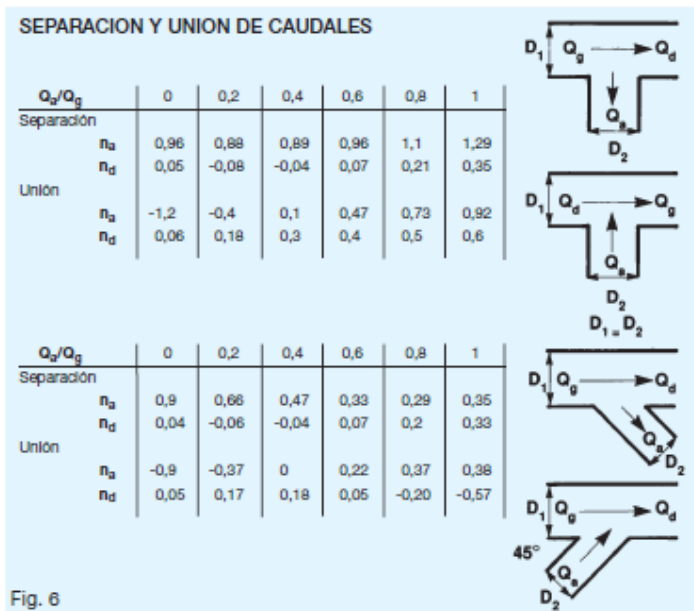

Coefficient n, headlosses - Manual ventilación. Soler&Palau

The dynamic pressure can be calculated since the caudal (m³/h) and the duct diameter (m), in the graph 1.2. With this data we can calculate de dynamic pressure in mmcda that we will need to apply the head loss formulation.

In rectangular ducts is needed equivalent diameter of a round that present the same head loss (graph 1.2)

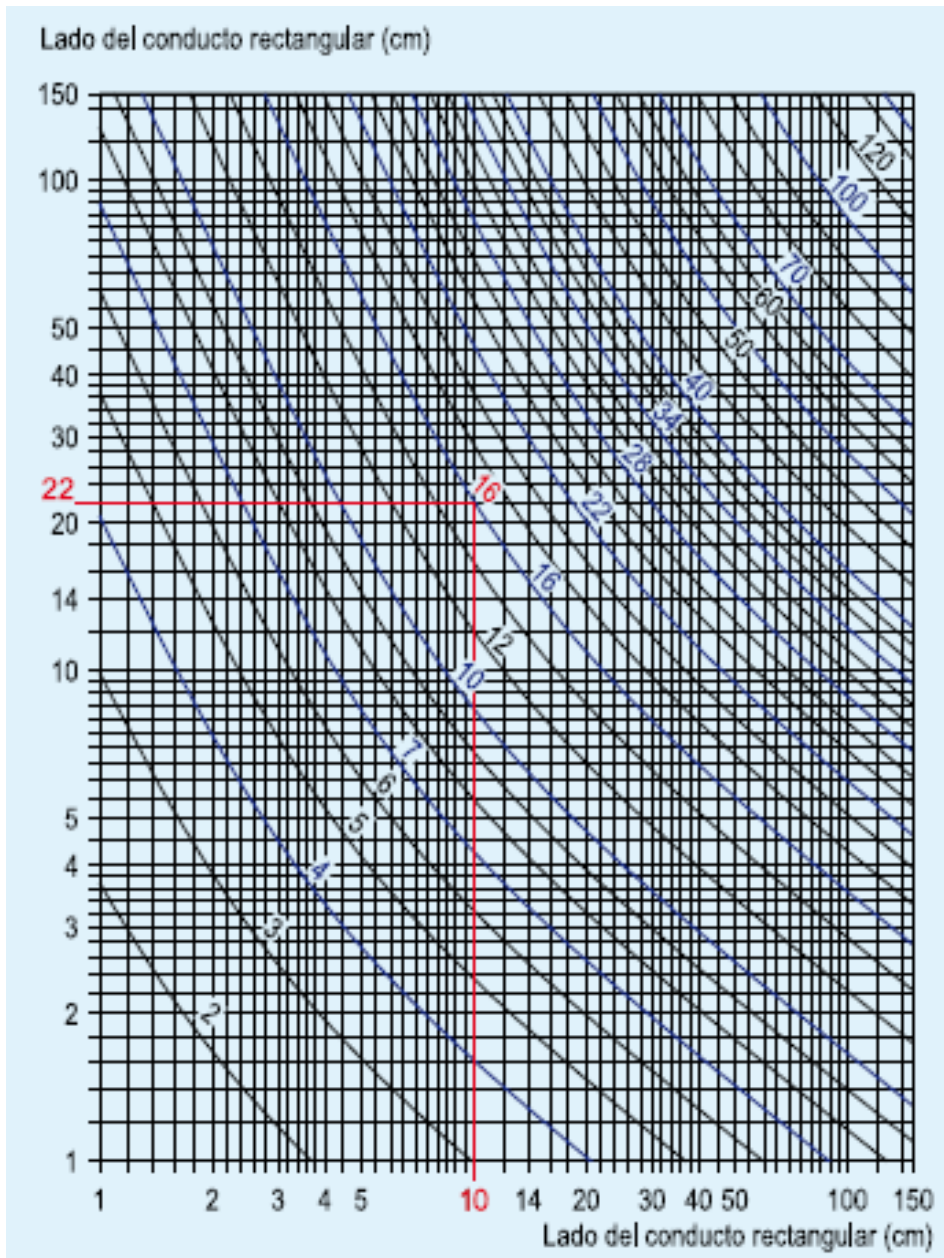

Equivalente diameter - Manual ventilación. Soler&Palau

In straight ducts the best form to calculate is use some graphs. We are going to use one of the with a friction coefficient of 0.2

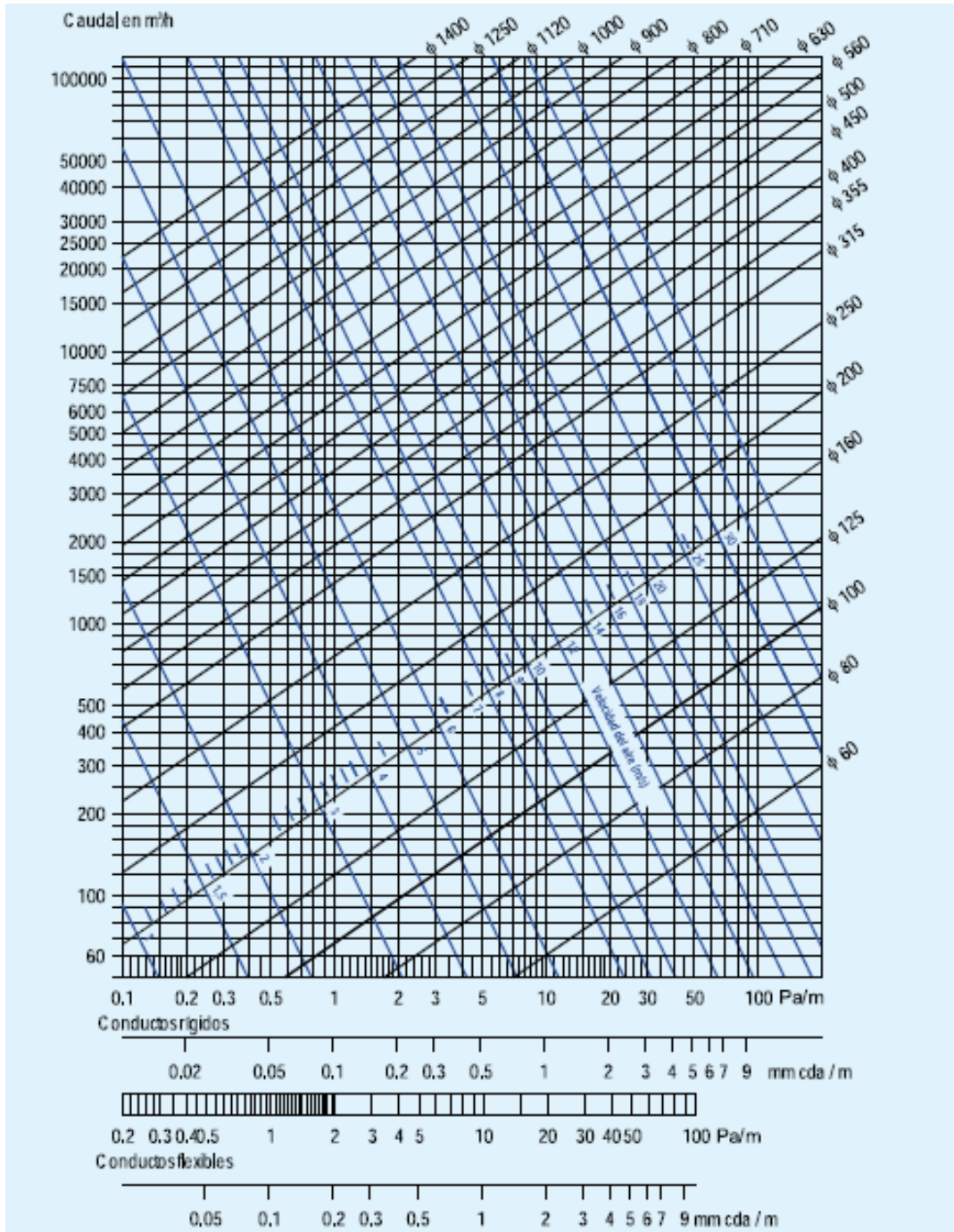

HEAD LOSSES. AIR SUPPLY

air supply	diam	caudal	v	Pa/m
A	200	1357	3	2,0517
B	130	286	1,5	2,36
C	160	868	3	2,696
D	140	332	1,5	0,8714
E	140	665	3	3,18
F	140	332	1,5	0,869
G	100	339	3	4,824
H	112	212	1,5	1,14
I	100	169	1,5	1,32
J	500	8482	3	0,6735
K	315	1683	1,5	0,321
L	450	6870	3	0,764
M	315	1683	1,5	0,3211
N	400	5428	3	0,8819
Ñ	315	1683	1,5	0,3215
O	300	3053	3	1,2502
P	315	1683	1,5	0,3215
Q	200	1357	3	2,05
R	80	108	1,5	1,7456
S	200	1357	3	2,05
T	112	212	1,5	1,147
U	112	212	1,5	1,147
V	160	868	3	2,694
W	125	268	1,5	1,012
Y	140	665	3	3,1925
X	140	332	1,5	0,87
Z	140	332	1,5	0,87

air supply	diam	caudal	v	Pa/m
1	224	1702	3	1,7854
2	100	339	3	4,82
3	100	169	1,5	1,32
4	80	217	3	6,37
5	80	108	1,5	1,74
6	63	164	3	10,25
8	200	1357	3	2
9	100	169	1,5	2,05
10	180	1099	3	2,33
11	100	169	1,5	1,326
12	160	868	3	2,7105
13	125	265	1,5	1,003
14	140	665	3	3,18
15	125	265	1,5	1,003
16	100	339	3	4,82
17	112	212	1,5	1,1466
18	100	169	1,5	1,321
19	160	868	3	2,69
20	112	212	1,5	1,146
21	150	763	3	2,919
22	80	108	1,5	2,7
23	160	434	1,5	0,737
24	100	339	3	4,824
25	80	108	1,5	1,7455
26	100	169	1,5	1,3211

HEAD LOSSES. EXHAUST AIR

Extraction	diam	caudal	v	pa/m	m	total
1	200	1357,2	3	2,05	2	4,1
2	150	763,41	3	2,921	2	7,522
3	180	549,65	1,5	0,6385	0,5	1,99
4	80	217,42	3	6,385	4	25,62
5	100	169,65	1,5	1,325	0,5	2,34
6	80	108,57	1,5	1,75	5	8,83
7	180	1099,3	3	2,33	5	11,73
8	200	678,59	1,5	0,56	0,5	0,36
9	180	1099,3	3	1,529	5	9,325
10	112	212,8	1,5	1,15	0,5	2,255
11	150	763,41	3	2,921	6	17,606
12	112	212,8	1,5	1,12	0,5	2,24
13	125	530,15	3	3,65	6	21,98
14	125	265,07	1,5	1	0,5	2,18
15	100	339,29	3	4,82	2	9,72
16	100	169,65	1,5	1,325	0,5	0,7425
17	100	169,65	1,5	1,325	4	6,98
18	550	1026,6	3	0,64	0,5	0,32
19	315	1683,3	1,5	321	10	3,211
20	500	8482,3	3	0,6732	3	2,01
21	315	1683,3	1,5	0,321	0,5	1,84
22	450	687,67	3	0,109	7	0,84
23	315	1683,3	1,5	0,321	10	4,89
24	400	5428,7	3	0,8815	7	9,37
25	315	1683,3	1,5	0,3213	11	3,61
26	200	1357,2	3	2,0505	3	7,83
27	80	108,57	1,5	1,7533	0,5	2,55
28	180	1099,3	3	2,3375	2	4,75
29	100	169,65	1,5	1,3253	2	4,33
30	100	169,65	1,5	1,3253	5	8,3
31	160	868,59	3	2,6975	3	9,77
32	100	169,65	1,5	1,325	3	5,655
33	200	678,59	1,5	0,5608	6	3,44
34	63	67,333	1,5	2,37	1	3,97
35	63	67,333	1,5	2,37	1	4,05
36	100	339,29	3	4,82	5	24,18
37	63	67,333	1,5	2,37	1	2,37
38	63	67,333	1,5	2,37	1	2,37
39	63	67,333	1,5	2,37	1	3,97
40	100	339,29	3	4,8278	5	27,33

Extraction	diam	caudal	v	pa/m	m	total
41	140	665,01	3	3,1808	0	0,08
42	200	1357,2	3	2,0505	2	4,101
43	100	339,3	3	4,828	2	11,256
44	80	108,57	1,5	1,7533	0,5	2,55
45	63	134,67	3	8,609	4	34,51
46	80	108,57	1,5	1,7533	0,5	2,55
47	63	67,333	1,5	2,37	5	11,93
48	180	1099,3	3	2,33	5	11,73
49	100	169,65	1,5	1,325	0,5	0,7425
50	160	868,59	3	2,697	5	15,46
51	100	169,65	1,5	1,3253	0,5	2,34
52	180	1099,3	3	2,33	6	14,06
53	125	265,07	1,5	1	0,5	2,18
54	125	530,15	3	3,659	6	22,034
55	125	265,07	1,5	2,33	0,5	2,845
56	80	217,15	3	6,3785	2	12,837
57	80	108,57	1,5	1,7533	0,5	0,95
58	100	169,65	1,5	1,325	4	6,98
59	200	1357,2	3	2,0505	2	4,101
60	112	212,8	1,5	1,1503	0,5	2,25
61	180	1099,3	3	2,3375	2	4,75
62	80	108,57	1,5	1,7533	5	10,4
63	180	1099,3	3	2,33	2	4,74
64	160	434,29	1,5	0,7363	2	3,15
64,2	112	425,61	3	4,1933	3	14,25
65	100	339,28	3	4,8303	2	11,34
66	80	108,57	1,5	1,7533	0,5	2,55
67	100	169,65	1,5	1,3253	4	5,381
68	80	108,57	1,5	1,7325	5	8,66
69	80	108,57	1,5	1,7533	4	11,81

ROTARY HEAT EXCHANGER

In most industrial and commercial building and institutions the indoor climate is often bad because of too high temperatures that are due to the large quantities of heat, which is given off from electric equipment in the building and from solar radiation. Furthermore the air is polluted with CO₂ given off from the people in the building.

Therefore the air quality has highest priority, when new building is made or a building is renovated. The last year's research shows clearly that it is worth taking care of a good indoor climate, like an element in securing effective and content employees. When still many places with bad indoor climate are found, the explanation can maybe be, that you do not know, which demands you have to make, and furthermore it may be difficult to see through, what you need in order to get a good indoor climate. With a good indoor climate you will be fit all day and by that obtain bigger work efficiency. It is consequently not a law of nature that you have to be worn out at 3 in the afternoon.

The first, you have to realize during the projecting, is, how, the individual room, which have to be ventilated, are used. For office ventilation heat recovering should always be used for energy saving reason. By this you get a good control over the air, which is extract and the air, which is let in. The inlet air is at the same time filtered, so that you can avoid particles such as pollen, soot and other traffic-dust.

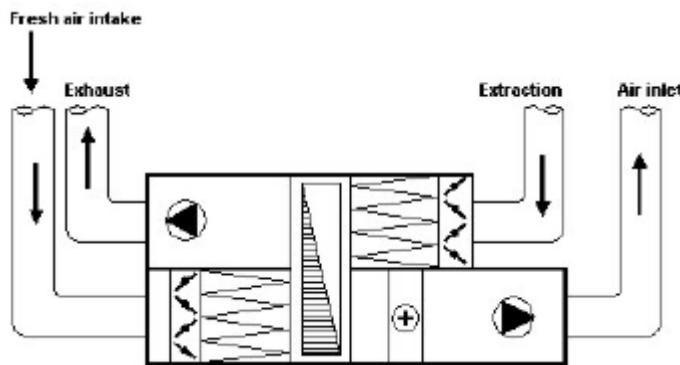

Rotary heat exchange recovery. COMP- Ventilation system heat recovery

In rotary heat exchangers heat and moisture is led from the exhaust air to the rotor, where it is accumulated and thereby transmitted to the fresh air. A system with rotary heat exchanger has a high temperature efficiency of about 85%. Systems with rotary are not suitable for rooms with big pollution of the indoor air.

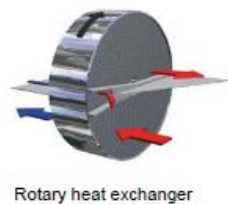

Rotary heat exchanger

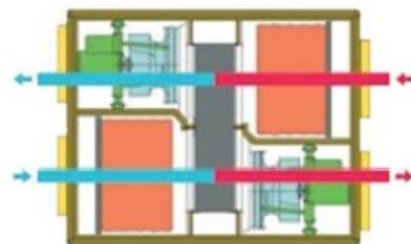

System with rotary heat exchanger

Rotary heat exchange recovery. COMP- Ventilation system heat recovery

The price of this rotary heat exchanger is around 5468,31 €/u

Catalogue of product – Exhausto company

VEX280-1

1. AIR HANDLING UNIT DATA

Air handling unit data	
Min. airflow	1730 m ³ /h
Max. airflow	14800 m ³ /h
Power consumption	11,3 kW
Electrical Supply	3 x 400 V + N + PE 50 Hz
Max. phase current	28,3 A
Weight of operational air handling unit	1070 kg
Weight of air handling unit for transport	Fan sections: 2 x 236 kg, Rotor section: 221 kg
Motor data (per unit):	
Voltage (delta/star)	3 x 230 V / 400V
Current (delta/star)	3 x 10,6 A / 6,1 A
Power supplied	3,0 kW
CEMEP-class	EFF1
Rotor pinion - stepper motor:	
Voltage	230 V
Phase current	0,2 A
Power consumption	45 W
Overcurrent protection	Built in
Control (built in rotation monitor)	Infinitely variable from 0 to 10 rpm on the rotor

It is evident that keep the ventilation system in their maximum caudal in a constant way supposed an important energy expenditure, in the consumption of the ventilator like in the consumption to warm or cooling the inside air. For this reason is recommended design systems conform to the occupation and to the level of pollution (co2, temperature,...). For this reasons Demand controlled ventilation (DCV) and a installation of intelligent system composed by ventilators of low consumption, electronic and mechanic elements (control elements, speed regulators, presence detectors, Co2 sensors, temperature, moisture, pressure) that in all the moments are controlling the use of enough energy to ensure a correct ventilation. That meant an important energy savings in the lifecycle of the installation. DCV can apply to multi zone and just in one zone:

- **Multi zone:** the space to ventilate is composed by several areas, compartmentalized, that need different acts of individual ventilation
- **One zone:** the space to ventilate is composed by one opened area, without diffusers that need a homogeneous act of ventilation

The system will be designs in function of the maximum demand in case of all the rooms are occupied. Determine the pressure that is generated in the system with this regimen worked for maximum ventilation. Each room would keep a minimum of ventilation to ensure the environment conditions. The system will be put on operation thank you a Timer or manual form. When de presence detector detects one person in the room, this system will emit a command to the Aspiration mouth that would open, that generate an imbalance in the pressure, that will be detected by the pressure sensor that will send a command to regulation elements which in turn acts over the ventilator, adapting the speed to restore the pressure of the system. Each input or output of all the rooms would be identified for the presence detectors that interact in the system.



Demand control ventilation. Manual de ventilacion – Manuel Escoda

VENTILATOR

The ventilator are rotating machines able to move a determinate mass of air, with a certain pressure, enough to overcome the head losses that will be produce in the ducts. They are composed by:

- Rotary elements: the rotary elements are the piece of the ventilator that turns around itself axis. Could be propeller if the output direction of the air is parallel to the ventilator axis. We will call it impeller if the output direction of the air is perpendicular to ventilator axis.
- Support
- Pump

The ventilators can be drivers or extractors and they have as target the movement of the air flow.

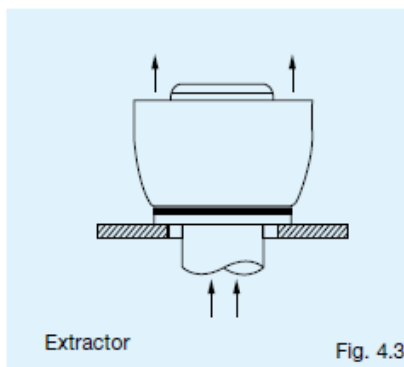
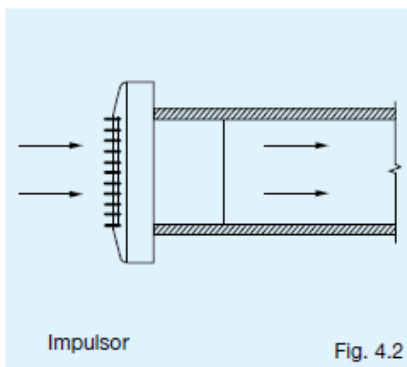

Ventilators types. Manual de ventilacion – Soler & Palau

Fan characteristic curve depend fan only, and can only vary if the fan runs at a different rotational speed. It can be accepted that the characteristic curve is completely independent of duct system that engages. However, considering a moving fan may run different flows and communicating different pressures, so that all possible points of operation shall be represented on the curve. We can easily find the operating point of a fan simply superimposing the characteristic curves and strong fan duct. You can see that the loss of a driving load varies proportionally with the square of the flow, so to find the feature found resistant and once the initial pressure drop given flow rate enough to superimpose a second flow rate to find a second

point of the resistant feature. Uniting all point found will represent the characteristic studied resistant installation. The intersection between the curve and the characteristic fan dle resistant installation or give us the working point.

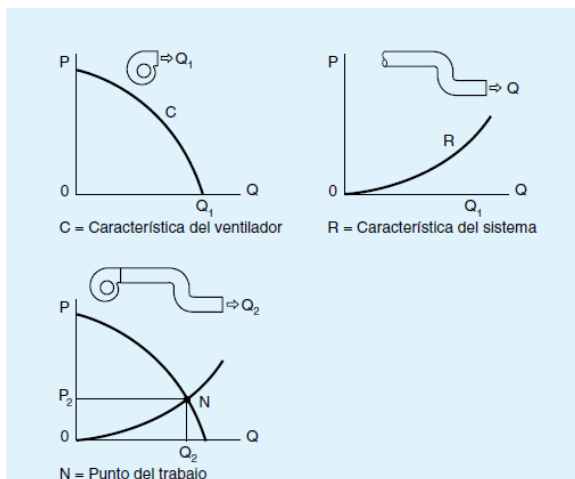

Characteristic curve. Manual de ventilacion – Soler & Palau

Characteristic curves of the fans follow certain laws called laws of the fans, which determines how they vary flow, pressure and power absorbed by the fan by varying operating conditions.

- We are going to use in our system this ventilator

Modelo			Velocidad (r/min)	Intensidad máxima admisible (A)			Potencia instalada (kW)	Caudal máximo (m³/h)	Nivel presión sonora dB(A)	Peso aprox. (Kg)	
				230V	400V	690V				HCH	HCT
HCH	HCT	45-4T-0,5	1450	2,07	1,20	0,37	7100	68	15	24	
HCH	HCT	45-4M-0,5	1450	3,10		0,37	7100	68	15	24	
HCH			950	1,47	0,85	0,25	4750	55	14		
HCH			950	1,30		0,25	4750	55	15		
	HCT	50-4T-0,75	1450	3,00	1,73	0,55	10300	70		28	
HCH	HFT	HCT 56-4T-0,75	1450	3,12	1,80	0,55	11000	72	21	33	

Ventilator. Catalogue of products – HCH HFT HCT SODECA

Now we are going to check if we fulfill the ventilation laws. To do that, we are going to take two duct of our system with their characteristic of caudal, pressure and rpm.

O – 0.08004 m³/s 2881.62 m³/h 11.6016 mmca 405.66 rpm

J – 2.18435 m³/s 7863.66m³/h 4.041 mmca 1107.02 rpm

$$Q_2 = Q_1 \left(\frac{n_2}{n_1} \right)$$

$$Q_2 = Q_1 \left(\frac{n_2}{n_1} \right) = 2881.62 * \frac{1107.02}{405.66} = 7863.66 \frac{m^3}{h}$$

$$P_2 = P_1 \left(\frac{n_2}{n_1} \right)^2$$

$$P_2 = P_1 \left(\frac{n_2}{n_1} \right)^2 = 4.041 * \left(\frac{1107.02}{405.66} \right)^2 = 11.02 \text{ mmca}$$

By varying the flow or system power check that the results are proportional remain at all times within our fan characteristic curve.

Each fan associate involves some noise; sound pressure level is measured in decibels. The decibel is a figure number on a logarithmic scaling in which the sound pressure is related to another reference measure. This reference is used to handle calculation comfortable units. With the characteristics of each fan is given the number of decibels also produced its operation, that we see that is below the established limits. To calculate the noise through pipelines, such as air-conditioning facilities, must start from the fan sound power and attenuation occurring along driving.

ENERGY CONSUMPTION VENTILATION

$$Q_v = \rho * c * q_v * t_1 * t_2 * T_d(1 - \eta)$$

Month starting	HDD	% Estimated
01/06/2012	191	0
01/07/2012	105	0
01/08/2012	97	6
01/09/2012	275	0
01/10/2012	354	0
01/11/2012	424	3
01/12/2012	656	0
01/01/2013	600	0
01/02/2013	568	0
01/03/2013	662	0
01/04/2013	422	0
01/05/2013	214	0

	Td	air supply	ρ	c	t1	t2		Qv inlet
September	275	2,88	1,2	1	0,4167	0,7142	0,85	42,42687
October	354	2,88	1,2	1	0,4167	0,7142	0,85	54,61496
November	424	2,88	1,2	1	0,4167	0,7142	0,85	65,41453
December	656	2,88	1,2	1	0,4167	0,7142	0,85	101,2074
January	600	2,88	1,2	1	0,4167	0,7142	0,85	92,56772
February	568	2,88	1,2	1	0,4167	0,7142	0,85	87,63078
March	662	2,88	1,2	1	0,4167	0,7142	0,85	102,1331
April	422	2,88	1,2	1	0,4167	0,7142	0,85	65,10597
May	214	2,88	1,2	1	0,4167	0,7142	0,85	33,01582
June	191	2,88	1,2	1	0,4167	0,7142	0,85	29,46739
July	105	2,88	1,2	1	0,4167	0,7142	0,85	16,19935
August	97	2,88	1,2	1	0,4167	0,7142	0,85	14,96512
								704,7489

Heating by under floor heating

The under floor heating is a heating system that consists in some pipe circuits that let hot water pass through it and its heat is transferred upwards. Radiant heating is a really efficient system because it eliminates duct losses than can be in other kind of heating systems. It needs less temperature than others systems like radiators and this fact helps the electricity bill of houses or other buildings decrease.

This system is the one that is more similar to the ideal one. This is possible to check with the temperature curve for each one:

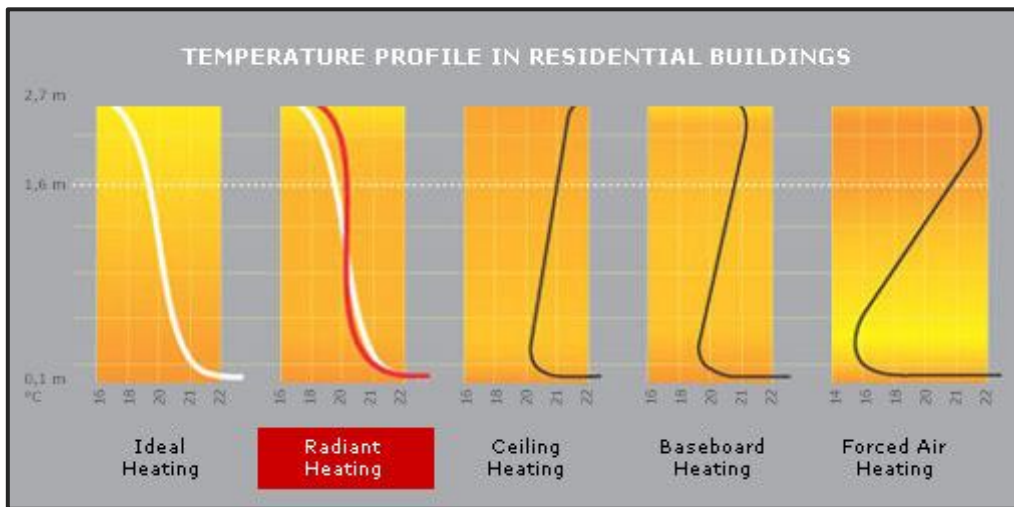

Fig. 1. Different curves of heatig systems
<http://haser.tinymogul.com>

As it is shown, the one which losses less heating and the one that fits better to the most efficient and ideal is the Under floor heating.



Fig. X. Picture of how will be the different circuits in Hall (22.1) area
www.eurofast.ie

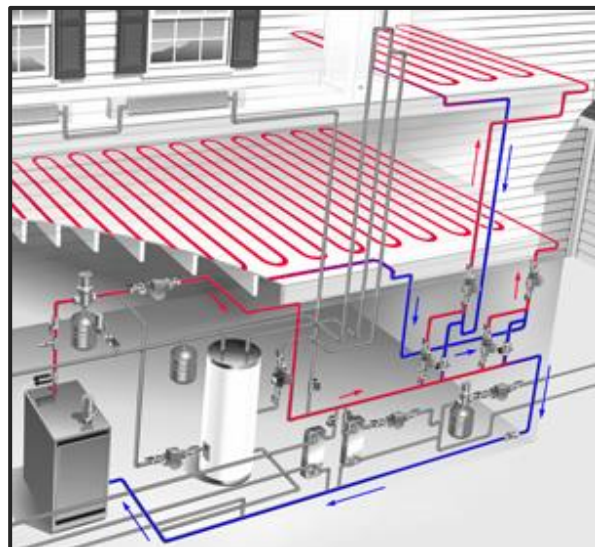

Fig. 1. Underfloor heating instalattion
<http://haser.tinymogul.com>

BENEFITS:

Healthy system: Floor heating doesn't produce as much airborne dust as radiators or convection systems. For people who suffer asthma or other allergies this is a point to take in account when choosing the heating system.

Little maintenance: As the system is always fixed and there are no moving parts, there are little possibilities that something goes wrong. If it is correctly installed, pressure testing of the pipes will be one of the maintenance that can be checked each time. As a conclusion, there are no regular maintenance costs.

Possibility to combine with Heat Pumps easily: Concentrated heat can be delivered by a Heat Pump to provide domestic hot water up to 60°C while feeding the floor heating system at a lower efficient temperature. Usually, under floor Heating systems are designed to optimise the efficiency of heat pumps. So not only is the existing renewable energy heating system more efficient overall, it is delivering a constant, controlled heat and can help reduce running costs and the building's carbon footprint at the same time.

Comfort: Under floor heating heats the whole floor area you in which the pipes go through. This generates the opposite heat cycle to that of conventional heat sources and results in warm feet and consistent room temperatures. Compared to conventional radiators, an under floor heating system generates more radiant heat and thermal inertia as opposed to convective heat.

Available in all designs: There is always the flexibility to locate all the furniture where it is wished, suiting all needs. Otherwise, with radiators system there can be always difficulties when thinking the distribution of rooms or offices.

Particular controls: The floor heating system gives the chance to control individual rooms with one thermostat in each. Thermostats can be programmed to get the demands of a specific area instead of wasting unnecessary energy in areas of the building which are not used as much as others.

Long life expectancy: The system can be useful from 50 to 100 years and

TYPE OF CIRCUITS:

There are many type of circuits that can be design for the underfloor heating of a building but these three are the most common ones:



Zig-Zag: The pipe goes and come starting from one side of the room and ending on the other side. The problem of this circuit is that it heats more the first half of the area than the rest of the room.

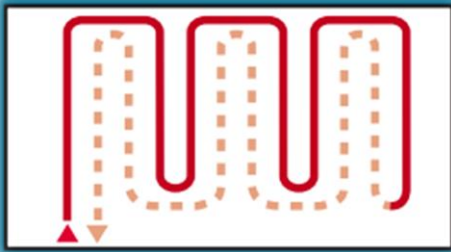

U: It is the same shape as Zig Zag but it returns doing the same circuit so the temperature is going to be more equal in all the room.

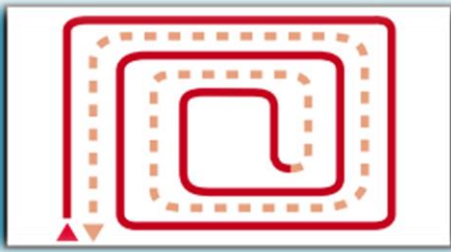

Spiral: The pipe starts passing through all the perimeter of the area and then repeats the same covering all the area and returns.

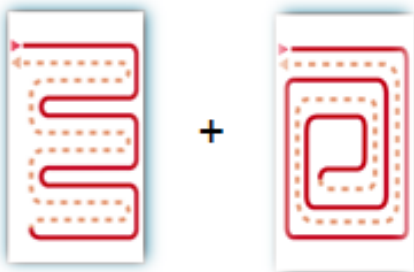

Mix of spiral + U: The pipe first go through all the perimeter of the room and then starts doing U circuit until it finished. This is the most efficient in some cases because the hottest water passes near by the coldest parts which are usually walls.

Fig. 1. Kind of under floor heating circuits Installations Subject from home University (UPC)

COMPARISING:

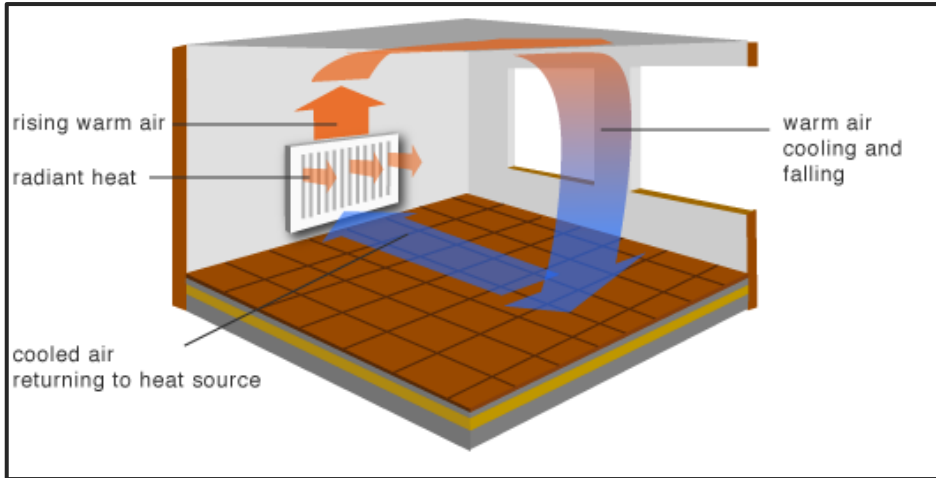

Radiators:

The warm air circulation is going up to the ceiling and then goes down again but its temperature is lower so the efficiency is not so high.

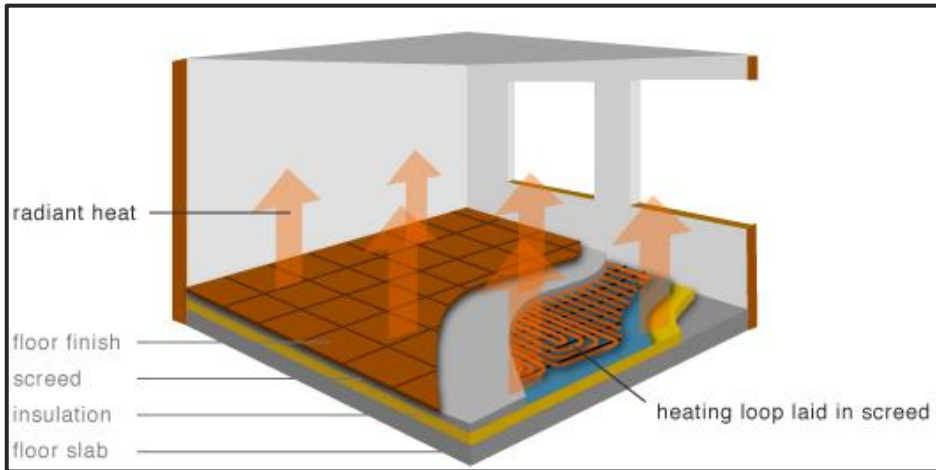

Underfloor heating:

The warm air circulation is going up to the ceiling and then goes down again but its temperature is lower so the efficiency is not so high.

Fig. 2. Comparising radiators and floor heating system

www.greenspec.co.uk

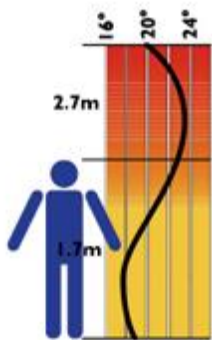

Radiators Curve:

As the picture shows, the warmest area is located on the top of the room so this heating system doesn't take the most of itself.

Fig. 2. Radiators and Floor heating curve

www.greenspec.co.uk

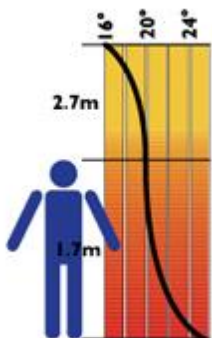

Underfloor Heating Curve:

The warmest part of the room is located in the middle down part of the area. Then it starts decreasing until the ceiling.

CALCULATIONS

In order to know how many meters of piping the system will need there must be done some calculations or check some information before:

- m² of each area that needs to be heated
- Separation between pipes
- Distances from each room until the technical room where the heat pump will be
- Distances from each room until the downpipe
-

The maximum length of the circuit can be 100 meters. So if the result it's more than this it will be divided in more than one circuit. Sometimes it can have 120 meters; sometimes it depends on the company.

For understanding the calculations in tables:

- **e**: space between the pipes. It will be taken 0,30m for all the system
- **l_r**: meters of piping in each room. It is calculated dividing the area of the room by the separation between piping.
- **D_{tr}**: distance between the room which is being calculated and the technical room
- **D_f**: distance of the up pipe
- **D_c**: distance from the up pipe to the room
- **D**: sums up of all D Values (D_c and D_f are multiplied by 2)
- **L**: total length of the circuit

Afterwards there has to be calculated the flow of water (in l/s) that will go through all the piping system.

For these calculations it will be needed:

- **Q**: The energy power of each room in Kcal/h
- **M**: flow. Units: l/h
- **C_p**: Specific heat of the water (1 cal/g K)
- **Δt**: variation of the temperature that comes and that goes out (10 °C)

$$M = \frac{Q}{c_p \cdot \Delta t}$$

For knowing the pressure loss of each piping it is necessary to look at the table that it is possible to find in the appendix pages. Checking the flow and the dimension of the pipe it is possible to know the pressure loss.

PIPING LENGTHS CALCULATIONS

Groundfloor Rooms	# Room	Area (m ²)	e (m)	l ₁ (m)	dtr (m)	df (m)	dc (m)	D (m)	L (m)	Num. Of Circuits	Total L (m)	Each circuit (m)
Office	6	110	0,3	366,7	13	0	0	0	366,7	4	366,7	91,7
Technical Equipment	7	21	-	-	2	3	0	6	-	-	-	
Storage	8	7	0,3	23,3	4	0	0	0	23,3	1	23,3	
Storage	9	10	0,3	33,3	6	0	0	0	33,3	1	33,3	
Corridor	10	5	0,3	16,7	10	0	1	2	18,7	1	18,7	
Copy	11	15	0,3	50,0	11	0	3	6	56,0	1	56,0	
Changin Room	12	6	0,3	20,0	13	0	1	2	22,0	1	22,0	
WC	13	3	0,3	10,0	15	3	0	6	16,0	1	16,0	
Cloak Room	14	8	0,3	26,7	17	0	1	2	28,7	1	28,7	
WC	15	4	0,3	13,3	19	3	0	6	19,3	1	19,3	
Changin Room	16	7	0,3	23,3	20	0	1	2	25,3	1	25,3	
Storage	17	12	0,3	40,0	22	0	2	4	44,0	1	44,0	
Forum	18	75	0,3	250,0	20	0	1	2	252,0	3	258,0	86,0
Canteen	19	21	0,3	70,0	20	0	3	6	76,0	1	76,0	
Entrance	20	20	0,3	66,7	20	0	4	8	74,7	1	74,7	
Boss Office2	21	21	0,3	70,0	19	0	3	6	76,0	1	76,0	
Hall	22.1	383	0,3	1276,7	15	0	2	4	1280,7	13	1280,7	98,5
Amount of underfloor heating pipes (Lineal meters)											2052,0	

1st Floor	1st F Rooms	Area (m ²)	e (m)	l ₁ (m)	dtr (m)	df (m)	dc (m)	D (m)	L (m)	Num. Of Circuits	Total L (m)	Each circuit (m)
Boss Office 3	23	18	0,3	60,0	19	0	3	6	66,0	1	66,0	
Boss Office 4	24	18	0,3	60,0	23	0	3	6	66,0	1	66,0	
Meeting Room	25	18	0,3	60,0	27	0	4	8	68,0	1	68,0	
Cleaning	26	4	0,3	13,3	5	0	1	2	15,3	1	15,3	
Storage	27	18	0,3	60,0	2	0	2	4	64,0	1	64,0	
Office	28	43	0,3	143,3	0	0	1	2	145,3	2	145,3	72,7
WC	29	3	0,3	10,0	18	0	0	0	10,0	1	10,0	
Cloak Room	30	10	0,3	33,3	17	0	1	2	35,3	1	35,3	
WC	31	4	0,3	13,3	7	0	0	0	13,3	1	13,3	
Office	32	67	0,3	223,3	4	0	2	4	227,3	2	227,3	113,7
Office	33	45	0,3	150,0	1	0	1	2	152,0	2	152,0	76,0
Storage	34	24	0,3	80,0	25	0	2	4	84,0	1	84,0	
Office	36	28	0,3	93,3	21	0	1	2	95,3	1	95,3	
Forum	37	41	0,3	136,7	15	0	2	4	140,7	2	140,7	70,3
Amount of underfloor heating pipes (Lineal meters)											1182,7	
Amount of ALL underfloor heating pipes (Lineal meters)											3234,7	

FLOW CALCULATIONS

FLOW CALCULATIONS - First Floor							
# Room	Energy Demand	Energy Demand (Kcal/h)	Flow (l/h)	Flow (l/s)	dtr (m)	ø (mm)	Pressure Loss (Kpa/m)
6	2829	2432,5	243,25	0,0676	13	16	0,35
7	478	411,0	-	-	2	-	
8	40	34,4	3,44	0,0010	4	16	0
9	44	37,8	3,78	0,0011	6	16	0
10	32	27,5	2,75	0,0008	10	16	0
11	63	54,2	5,42	0,0015	11	16	0
12	318	273,4	27,34	0,0076	13	16	0,01
13	11	9,5	0,95	0,0003	15	16	0
14	46	39,6	3,96	0,0011	17	16	0
15	13	11,2	1,12	0,0003	19	16	0
16	384	330,2	33,02	0,0092	20	16	0,015
17	69	59,3	5,93	0,0016	22	16	0
18	1086	933,8	93,38	0,0259	20	16	0,065
19	1072	921,8	92,18	0,0256	20	16	0,063
20	2617	2250,2	225,02	0,0625	20	16	0,034
21	730	627,7	62,77	0,0174	19	16	0,035
22.1	20759	17849,5	1784,95	0,4958	15	16	0,2
Total but 22.1	9354	8043,0	804,30	0,2234			0,537

FLOW CALCULATIONS - Groundfloor							
# Room	Energy Demand	Energy Demand	Flow (l/h)	Flow (l/s)	dtr (m)	ø (mm)	Pressure Loss (Kpa/m)
23	730	627,7	62,77	0,0174	19	16	0,035
24	712	612,2	61,22	0,0170	23	16	0,035
25	636	546,9	54,69	0,0152	27	16	0,029
26	47	40,4	4,04	0,0011	5	16	0,002
27	232	199,5	19,95	0,0055	2	16	0,005
28	1098	944,1	94,41	0,0262	0	16	0,065
29	35	30,1	3,01	0,0008	18	16	0,000
30	141	121,2	12,12	0,0034	17	16	0,000
31	98	84,3	8,43	0,0023	7	16	0,000
32	1881	1617,4	161,74	0,0449	4	16	0,180
33	1258	1081,7	108,17	0,0300	1	16	0,083
34	344	295,8	29,58	0,0082	25	16	0,010
36	749	644,0	64,40	0,0179	21	16	0,040
37	441	379,2	37,92	0,0105	15	16	0,015
Total	8402	7224,4	722,4420	0,2007			0,499

Total	Office side	17756	15267,41	1526,7	0,4241		1,036
	Hall side	20759,0	17849,53	1785,0	0,4958		0,2
Total	All Areas	38515,0	33116,94	3311,7	0,9199		1,236

FLOW (m³/h)	3,31
--------------------	------

PUMP

Once the calculations are all right, there has to be chosen the pump that will do that this system works.

As it is known by the previous calculations, the flow that this building need is 3.310 l/h so one bomb that could fit for it is the one here below. Usually it is better to take a pump that has a marge and it doesn't fit exactly. This is because if there are some mistakes when the lengths of the pipes have been calculated it will be able to add more meters without problems.

The water bomb can reach to pump until 3.600 l/h so if there was the need to add some other circuit it could fit

Altura edificio Height of building Hateur immeuble (m)	Caudal Flow Débit (l/h)	Modelo Model Modèle	Bomba Pump Pompe	Volúmen depósito Tank volume Volume réservoir		Potencia Power Puissance (CV)
				Membrana Membrane	Galvanizado Galvanized Galvanisé	
10	3600	GDB-VIENA 5.3 T	VIENA 5.3 T	25 - 250	100 - 750	0,8 + 0,8
		GDB-100 T	HT-100	25 - 250	100 - 750	1 + 1
		GDB-ROMA 5.4 T	ROMA 5.4 T	25 - 250	100 - 750	1 + 1
15	3600	GDB-VIENA 5.4 T	VIENA 5.4 T	25 - 250	100 - 750	1 + 1
		GDB-ROMA 5.5 T	ROMA 5.5 T	25 - 250	100 - 750	1,3 + 1,3
20	3600	GDB-VIENA 5.5 T	VIENA 5.5 T	25 - 250	100 - 750	1,2 + 1,2
		GDB-ROMA 5.5 T	ROMA 5.5 T	25 - 250	100 - 750	1,3 + 1,3
25	3600	GDB-VIENA 5.5 T	VIENA 5.5 T	25 - 250	100 - 750	1,2 + 1,2
		GDB-200 T	HT-200	25 - 250	100 - 750	2 + 2
30	3600	GDB-200 T	HT-200	25 - 250	100 - 750	2 + 2
		GDB-BARI 10.5 T	BARI 10.5 T	25 - 250	100 - 750	2 + 2
40	3600	GDB-BARI 10.6 T	BARI 10.6 T	25 - 250	100 - 750	3 + 3
		GDB-ROMA 10.6 T	ROMA 10.6 T	25 - 250	100 - 750	3 + 3



Fig. X. Pump's catalogue
www.bombashasa.com

BUDGET

The price of the underfloor piping installation has been taken in the official Danish website of ML-Byg. And the price includes the installation of the system as well.

BUDGET - Groundfloor							
# Room	Area (m ²)	Total L (m)	Price of m ² (Dkk/m ²)	Price (Dkk)	Thermostat controller	Unit Price	Room Price (Dkk)
6	110	16,0	267	kr. 29.370	Yes	kr. 700	kr. 30.070
7	21	-	267	kr. -	-	kr. 700	kr. -
8	7	8,0	267	kr. 1.869	Yes	kr. 700	kr. 2.569
9	10	9,0	267	kr. 2.670	Yes	kr. 700	kr. 3.370
10	5	10,0	267	kr. 1.335	-	kr. 700	kr. 1.335
11	15	11,0	267	kr. 4.005	-	kr. 700	kr. 4.005
12	6	12,0	267	kr. 1.602	Yes	kr. 700	kr. 2.302
13	3	13,0	267	kr. 801	-	kr. 700	kr. 801
14	8	14,0	267	kr. 2.136	-	kr. 700	kr. 2.136
15	4	15,0	267	kr. 1.068	-	kr. 700	kr. 1.068
16	7	16,0	267	kr. 1.869	Yes	kr. 700	kr. 2.569
17	12	17,0	267	kr. 3.204	Yes	kr. 700	kr. 3.904
18	75	18,0	267	kr. 20.025	Yes	kr. 700	kr. 20.725
19	21	19,0	267	kr. 5.607	Yes	kr. 700	kr. 6.307
20	20	20,0	267	kr. 5.340	Yes	kr. 700	kr. 6.040
21	21	21,0	267	kr. 5.607	Yes	kr. 700	kr. 6.307
22.1	383	22.1	267	kr. 102.261	Yes	kr. 700	kr. 102.961
Price							kr. 196.469

BUDGET - First Floor							
# Room	Area (m ²)	Total L (m)	Price of m ² (Dkk/m ²)	Price (Dkk)	Thermostat controller	Unit Price	Room Price (Dkk)
23	18	66	267	kr. 4.806	Yes	kr. 700	kr. 5.506
24	18	66,0	267	kr. 4.806	Yes	kr. 700	kr. 5.506
25	18	68,0	267	kr. 4.806	Yes	kr. 700	kr. 5.506
26	4	15,3	267	kr. 1.068	-	-	kr. 1.068
27	18	64,0	267	kr. 4.806	Yes	kr. 700	kr. 5.506
28	43	145,3	267	kr. 11.481	Yes	kr. 700	kr. 12.181
29	3	10,0	267	kr. 801	-	-	kr. 801
30	10	35,3	267	kr. 2.670	-	-	kr. 2.670
31	4	13,3	267	kr. 1.068	-	-	kr. 1.068
32	67	227,3	267	kr. 17.889	Yes	kr. 700	kr. 18.589
33	45	152,0	267	kr. 12.015	Yes	kr. 700	kr. 12.715
34	24	84,0	267	kr. 6.408	Yes	kr. 700	kr. 7.108
36	28	95,3	267	kr. 7.476	Yes	kr. 700	kr. 8.176
37	41	140,7	267	kr. 10.947	Yes	kr. 700	kr. 11.647
Price							kr. 98.047

Budget	Floor	Area	Quantity	Units	U Price	Total
Underfloor Piping System	1st Floor	341	1048	m ²	267	kr. 279.816
	Groundfloor	707				
Thermostat controllers	1st Floor	10	21	Units	700	kr. 14.700,0
	Groundfloor	11				
Heat pump	1st Floor	-	2	Units	112180	kr. 224.360,0
	Groundfloor	-				
TOTAL						kr. 518.876,0

Heating by radiator:

This is obviously the most widespread way for the heating. The working principle is simple consisting to circulate some hot water in radiator (usually a grid of pipeline condensed and put in the heat rooms).

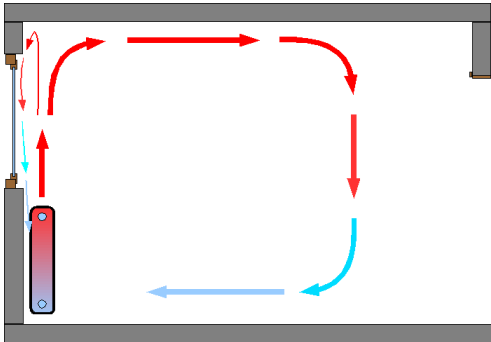

For designing the radiator system we would have chosen to have radiators with a big surface, especially in rooms with many windows. If possible the radiators should be located under the window to prevent falling of cold air. The big surfaces provide also heat radiation which is comfortable and necessary to balance the cold radiation of the windows.

The chosen piping system is the “Tichelmann” system. This system has for each radiator a similar length of the sum of supply and return pipe. This prevents hydraulic problems. During the dimensioning process of the pipes we also noted the pressure loss in each pipe segment. This way the pressure loss for the way from the heat distribution to each radiator can be summed up and the justification of each thermostatic valve can be chosen easily.

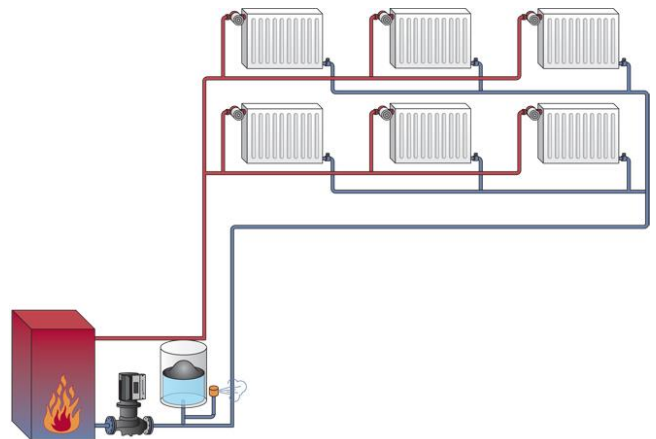

A) Advantages and drawbacks:

- Low investment costs
- Easy installation and the maintenance
- Carpets can be chosen without losing efficiency like it would be with the under floor heating
- Radiators might disturb design plans of rooms
- Furniture can/ should not be put in front of them

B) Calculations:

Pipe system: For the dimensioning of the pipes an average pressure loss of 100Pa/m is focused. Each pipe segment has been dimensioned by its heat flow (which implicates the volume flow) which is necessary to provide the following radiators with heat and a pressure loss table of copper pipes.

Size	€/m	DKK	90° - curve:	Size	€	DKK	T-part:	Size	€	DKK
DN10	5,49	41,18		DN10	2,01	15,08		DN10	2,86	21,45
DN12	6,47	48,53		DN12	1,86	13,95		DN12	2,75	20,63
DN15	7,52	56,40		DN15	2,38	17,85		DN15	3,73	27,98
DN20	10,34	77,55		DN20	3,05	22,88		DN20	4,76	35,70
DN25	12,9	96,75		DN25	6,02	45,15		DN25	9,08	68,10
DN32	13,02	97,65		DN32	12,72	95,40		DN32	15,92	119,40

Prepared with the prizes of www.derhandwerksmeister.com

DN	DN10	DN12	DN15	DN20	DN25	DN32	
length (m)	76,25	61,25	54,26	141,36	90,54	73,2	
prize (€)	418,61	336,26	351,06	1063,03	936,18	953,06	
prize (DKK)	3139,59	2521,97	2632,97	7972,70	7021,38	7147,98	30436,59

90° -arc	DN 10	DN 12	DN 15	DN 20	DN25	DN32	
pieces	69	10	14	26	15	15	
prize (€)	138,69	18,60	33,32	79,30	90,30	190,80	
prize (DKK)	1040,18	139,50	249,90	594,75	677,25	1431,00	4132,58

T-part	DN 10	DN 12	DN 15	DN 20	DN25	DN32	
pieces	47	5	2	8	0	2	
prize (€)	134,42	13,75	7,46	38,08	0,00	31,84	
prize (DKK)	1008,15	103,13	55,95	285,60	0,00	238,80	1691,63

Summed up the prize of the pipes with

Pumps:

The system consists of 3 circles with one pump each. We chose the Danish company Grundfos which produces high efficiency pumps which are worldwide in use. Two Grundfos ALPHA2 15-40 130 supply the office area.

2x1795DKK

The storage area is supplied with a Grundfos ALPHA2 15-60 130.

1x2107DKK

STORAGE AREA

For the storage area we chose ceiling radiating plates. These plates give normal heat to the room by convection of the air but also send infrared radiation on people, goods and machines in the room. This increases the temperature on the surface area and gives a comfortable feeling to the working people in the area. The plates consist of steel pipes with steel sheets in between. Normal heating water is circulating through the plates. Depending on the temperature of the water it is important to keep a certain distance between the plates and the ground with goods and people.

Ceiling radiating plates:

1: Head loss: 20759W

2: Direction: West – East oriented: 17,25m internal length -> L= 15,25m long plates possible

3: Total panel length: **68m (4x 15,25m + 1x 7m)**

4: Mounting height: **5,5m**

5: Amount of panels: P= 5,5m
W= 1,4m

6: $q_{/m} = \Phi_{HL} / L_{tot}$
 $q_{/m} = 20759W / 68m$
 $q_{/m} = 305,28W/m$

7: $\Delta t = ((55^{\circ}C - 45^{\circ}C) / 2) - 12^{\circ}C$
 $\Delta t = 35K$

Following the manufacturers' document we have to choose type 105000 and get with $\Delta t = 35K$ 307W/m which is in total enough to supply the calculated heat demand ($307W/m * 68m = 20876W$).

Storage area of the factory:

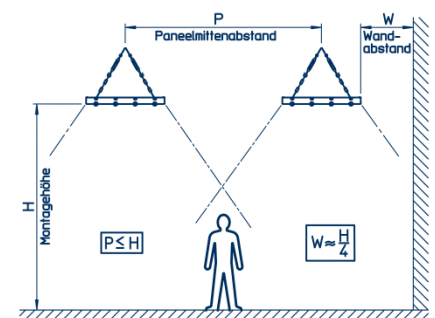
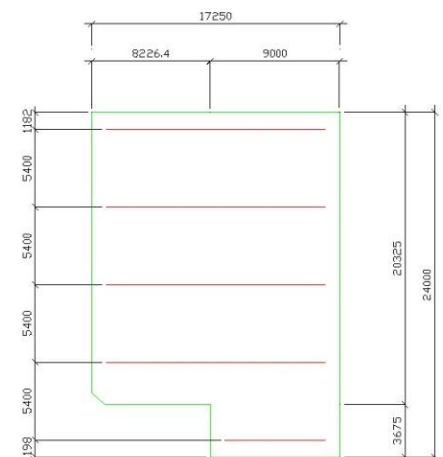

Galaxis Deckenstrahlplatte Type 1050:

Wide:	1050mm
Amount of pipes:	7
Heat power:	307W/M (with $\Delta t = 34K$)
Water volume inside:	3,44l/m
Mass:	24,00kg/m

Alternative heating of the storage area:

A possible alternative to heat the storage area would be to use infrared radiating tubes or fan coils. The infrared radiating tubes create, as the name says, infrared radiation. The tubes are made of steel pipes in which in general gas is burned and the flame is blown into the pipe by a ventilator. Manufacturers offer bright and dark versions. The not glowing dark versions use a lower temperature (between 300 and 650°C tube surface temperature) and by that the risk of fire is lower. The orange shining version works with a higher surface temperature and creates by this a higher radiation.

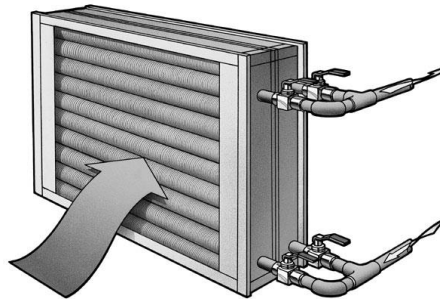

www.baulinks.de Schulte Dark infrared tube radiator

www.Armstronginternational.com heating coil

The fan coil would be another solution for the hall. In this case hot water is delivered to heating coils which are mounted under the ceiling of the hall. With an extra fan air is blown through the coil to heat the hall. Especially if there is a high air change in the hall this system requires a lot of energy.

For the reason of fire protection and the possibility to store goods also in a high rack it makes sense to choose a low temperature system which is based on radiation, also to have a higher comfort for the working people.

CHANGES IN WALLS U-VALUES

EXTERNAL WALL OFFICE AREA

1. Choose which is the direction of the flow

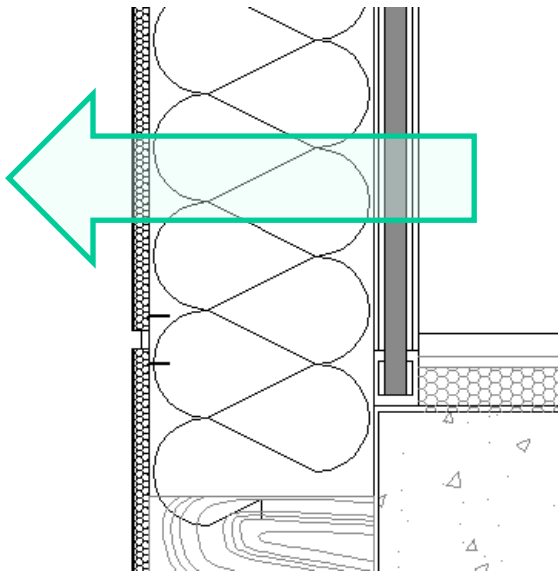

Flow's direction	R_{si} m ² .K/W	$R_{se}^{(0)}$ m ² .K/W	$R_{si} + R_{se}$ m ² .K/W
Vertical wall Horizontal flow	0,13	0,04	0,17
Flow goes up Horizontal wall	0,10	0,04	0,14
Flow goes down Horizontal wall	0,17	0,04	0,21

2. Calculate the Thermal Resistance and U-Value of the wall. As this wall has got a non-homogeneous layer it has to be calculated by Lower limit and Upper limit.

In order to have a better U-Value, it has been added 25 mm of insulation.

	R (m ² K /W)	A (m ²)	Total A (m ²)	%	R% (m ² K /W)	R _s (m ² K /W)
Timber Fr	1,000	0,041	0,600	0,069	0,069	4,843
Insulation	5,128	0,559		0,931	4,774	

Upper Limit	Total A (m ²)	A (m ²)	R (m ² K /W)	A/R	Ru (m ² K /W)
Timber	0,600	0,041	3,783	0,011	6,920
Insulation		0,559	7,373	0,076	

Lower Limit	Total A (m ²)	A (m ²)	R (m ² K /W)	A/R	Ra (m ² K /W)	RL (m ² K /W)
Timber	0,600	0,041	1,538	0,027	4,417	6,662
Insulation		0,559	5,128	0,109		

OFFICE WALL	d (m)	λ (W/mK)	R (m ² K /W)	U (W/ m ² K)
Lacquered Aluminium	0,0002	237,000	8,43882E-07	0,148
Polyurethane	0,0450	0,023	1,957	
Polyethylene	0,0002	0,550	0,000	
Timber Frames	0,2000	0,130	1,538	
Insulation: Sheep Wool	0,2000	0,039	5,128	
Gypsum board	0,0200	0,170	0,118	
Rsi			0,130	
Rse			0,040	
			6,748	

GREEN ROOF OFFICE AREA

1. Choose which is the direction of the flow

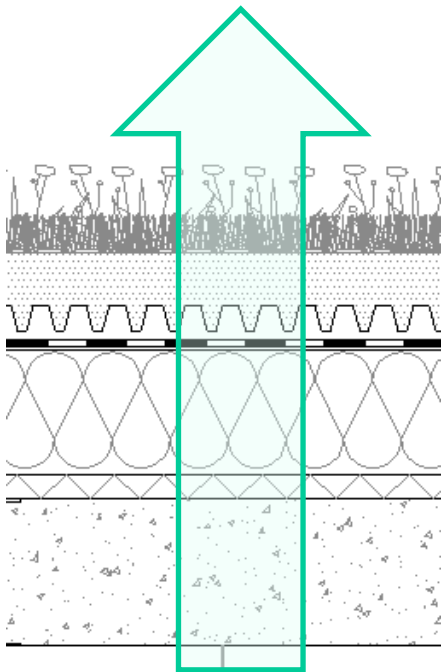

Flow's direction	R_{se} m ² .K/W	$R_{si}^{(0)}$ m ² .K/W	$R_{se} + R_{si}$ m ² .K/W
Vertical wall Horizontal flow	0,13	0,04	0,17
Flow goes up Horizontal wall	0,10	0,04	0,14
Flow goes down	0,17	0,04	0,21

2. Calculate the Thermal Resistance and U-Value of the roof.
(d = Thickness of the layer)

In order to get better U-Value on the green roof it has been added a 50 mm layer of Polyurethane and the thickness of the sheep wool insulation is changed to 250 mm.

OFFICE ROOF	d (m)	λ (W/mK)	R (m ² K /W)	U (W/ m ² K)
Reinforced concret	0,300	1,630	0,184	
Insulation: Polyurethane	0,050	0,023	2,174	
Insulation: Sheep wool	0,250	0,039	6,410	
Geotextil layer	0,001	0,035	0,029	
Waterproof layer	0,001	0,029	0,034	
Drainage layer	0,070	0,950	0,074	
Rsi			0,100	
Rse			0,040	
			9,045	0,111

FIRST SLAB OFFICE AREA

1. Choose which is the direction of the flow

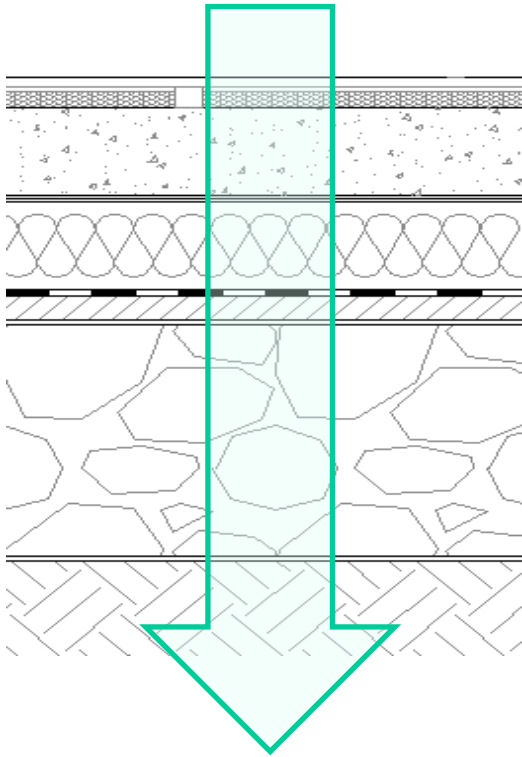

Flow's direction	R_{se} m ² .K/W	$R_{si}^{(0)}$ m ² .K/W	$R_{se} + R_{si}$ m ² .K/W
Vertical wall Horizontal flow	0,13	0,04	0,17
Flow goes up Horizontal wall	0,10	0,04	0,14
Flow goes down	0,17	0,04	0,21

2. It has been added a wooden finishing with insulation and the insulation layer is now 200 mm instead of 175 and that allows getting better U-Value as the table shows.

FOUNDATION	d (m)	λ (W/mK)	R (m ² K /W)	U (W/ m ² K)
Gravel	0,300	1,210	0,248	
Concrete	0,050	1,630	0,031	
Waterproof layer	0,001	0,029	0,034	
Insulation: Sheep Wool	0,200	0,039	5,128	
Geotextil layer	0,001	0,035	0,029	
Reinforced Concrete	0,200	1,630	0,123	
Polyurethane	0,040	0,023	1,739	
Rsi			0,170	
Rse			0,040	
			7,542	

FIRST SLAB STORE AREA

1. Choose which is the direction of the flow

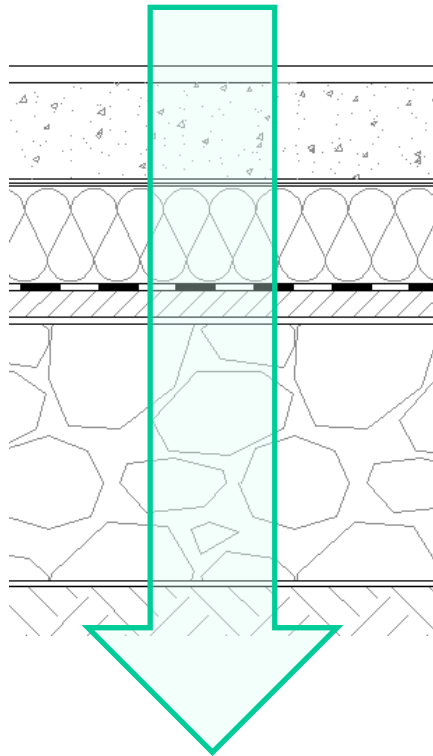

Flow's direction	R_{si} m ² .K/W	$R_{se}^{(1)}$ m ² .K/W	$R_{si} + R_{se}$ m ² .K/W
Vertical wall Horizontal flow	0,13	0,04	0,17
Flow goes up Horizontal wall	0,10	0,04	0,14
Flow goes down	0,17	0,04	0,21

As the table shows increasing the thickness of the insulation layer it could have had better U-Value.

FIRST SLAB OFFICE AREA

1. Choose which is the direction of the flow

STORAGE FOUNDATION	d (m)	λ (W/mK)	R (m ² K /W)	U (W/ m ² K)
Gravel	0,300	1,210	0,248	
Concrete	0,050	1,630	0,031	
Waterproof layer	0,001	0,029	0,034	
Insulation: Sheep Wool	0,200	0,039	5,128	
Geotextil layer	0,001	0,035	0,029	
Reinforced Concrete	0,200	1,630	0,123	
Rsi			0,170	
Rse			0,040	
			5,803	0,172

Electricity requirements:

After had taken in count at the light requirement and put a suitable system of lightening in each rooms, the total requirement in electricity use for lightening is value at 22700 kW per year in the office. So, 28,2 kWh/m² per year. And after do the same in the storage the total requirement is value at 8900 kW per year. So,11,7 kWh/m² per year. The total annual consumption is 31600kWh per year.

The office part has an additional electric consumption because of the electric staff like 35 computers for the employer, 12 printers, 11 screens, all of the tools for using in a canteen etc... The calculation for this consumption is done for the average time of the tools utilization. Example one computer is use around 8 hours by day at a power about P=144W only the fridge is used all time including the night with an average power of P=175W. Finally after add all of the electronic tools consumption the annual energetic demand for this is 94823kWh. So, 117,8kWh/m² per year. The additional electricity in the storage part is negligible.

So the **global specific electric demand is about 126423 kWh per year** for all of the building. The picture on the right come from the BE10 program and represents the energetic requirement in the office part in kWh/m². As it's possible to see on it this demand can increase depending about the energetic system which will find.

Selected electricity requirements	
Lighting	28,2
Heating of rooms	0,0
Heating of DHW	0,0
Heat pump	0,0
Ventilators	0,0
Pumps	0,0
Cooling	0,0
Total el. consumption	146,0

Energy sources

District heating

Definition of DH

DH distributes heat generated in a centralized location for residential and commercial heating requirements. It can reduce capital cost and increase energy efficiency. Instead of having lots of little plant spaces for all of the different buildings or apartments, there is just one plant space in a central location.

District heating plants can provide higher efficiencies and better pollution control than localized boilers.

PRODUCTION of DH

Heat is usually produced in a cogeneration plant (Combined heat and power, CHP) or in a heat only boiler station. The CHP generates heat and electricity simultaneously. The combination of CHP and District Heating (DH) is very energy efficient. A normal thermal power station wastes the amount of energy heat that is dissipated to the environment. The CHP recovers the heat and can reach total energy efficiency beyond 90%.

Other heat sources for district heating systems:

- Geothermal heat
- Solar power
- Surplus heat from industrial processes
- Nuclear power.

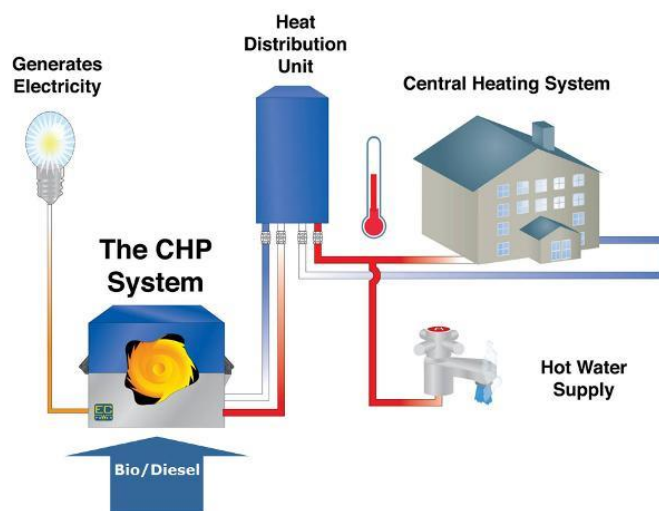

Fig. CHP System
www.proenviro.com

How does the heat get to the buildings?

After generating, the heat is distributed to the all customer (single family houses, industrial buildings, offices...) via a network of insulated pipes.

DH systems consist of go and return lines. Normally all piping is installed underground and the liquid they usually contain is water. Sometimes steam can be used as well.



Fig. Insulated Pipes
www.ecomerchant.co.uk

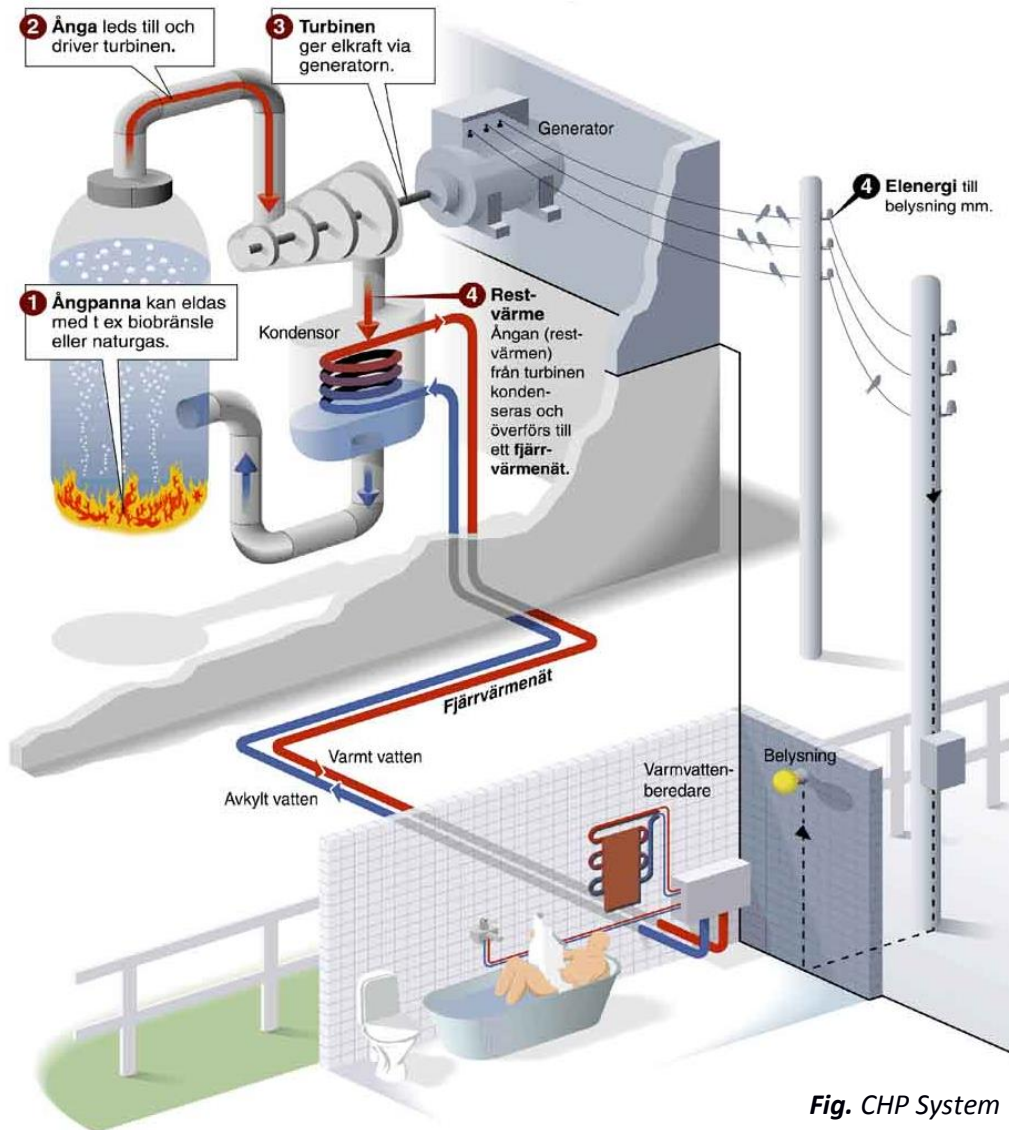

Fig. CHP System
www.proenviro.com

The heat network is connected to the central heating of the dwellings by heat exchangers. The water (or the steam) used in the district heating system is not mixed with the water of the central heating system of the building. District heating system is a closed circuit. It just heats each one of the heating systems of each building that it serves.

OFFICE AND STORE AREA OF THE BUILDING

District Heating Conditions in Horsens:

FEES		Price excl. VAT	25% VAT	Price incl. VAT
Lack of cooling **	Kr	7.50		7.50
Reminder	Kr	100.00		100.00
Closing Announcement	Kr	100.00		100.00
Collection Announcement	Kr	100.00		100.00
Closing Visit	Kr	375.00	93.75	468.75
Reopening during normal working hours	Kr	375.00		375.00
Attachment exiting	Kr	330.00		330.00
Fee for non-reading	Kr	65.00		65.00
Moving Statement	Kr	65.00	16.25	81.25
Printing the bill copy	Kr	35.00	8.75	43.75

** Per. lack of X consumed MWh

Fig. 1. Price of the DH in Horsens
<http://www.horsensvarmevaerk.dk/priser/>

PRICES		Price excl. Moms	25% VAT	Price incl. Moms
Heat after reading per second. MWh	Kr	530.00	132.50	662.50
Meter Rent	Kr	410.00	102.50	512.50
Fixed contribution	0-115 m ²	Kr	17.50	4.38 21.88 per. m ²
	116 to 230 m ²	Kr	16.00	4.00 20.00 per. m ²
	231 to 400 m ²	Kr	14.50	3.63 18.13 per. m ²
	401-4000 m ²	Kr	13.00	3.25 16.25 per. m ²
	Over 4000 m ²	Kr	11.75	2.94 14.69 per. m ²

Fig. 1. Price of the DH in Horsens
<http://www.horsensvarmevaerk.dk/priser/>

DH	Energy demand	Day (10h)	Month (22 days)	Year (12 months)	Price of 1MWh (Dkk)	Price
Wh	38.993	389.930	8.578.460	102.941.520		
MWh	0,039	0,39	8,6	102,94	kr. 663	kr. 68.199

Fossil Boiler

DOMESTIC HOT WATER PRODUCTION

First of all I decided to produce the domestic hot water independent of the heating boiler. The reason for this decision is that in offices the consumption of domestic hot water is not very high.

This could cause hygienic problems with legionella. A way to avoid hygienic problems would be to have a long circle with a circulation pump to provide the hot water quickly and keeps the water flowing. The chosen solution includes a continuous hot water heater for the canteen and a continuous hot water heater with 30 liter storage for the showers and toilets. The heater – storage combination can be mounted outside of the office area in the storage wall and supply ground and first floor with short ways.

The chosen models are:

Vaillant miniVED H 3/1N	2,0l/min	3,5kW	95€/ 712,50DKK
Vaillant VEN/H 30/2	30 liter	2kW	453,50€/ 3401,25DKK

Pictures by: www.Vaillant.de



GAS CONDENSING BOILER

To provide the office area and storage with the necessary energy we could also use a gas condensing boiler. Condensing boilers have an increased efficiency in comparison with non-condensing boilers because they also extract the heat which is stored in the water which is gaseous after the burning process and condense it. For this process low system temperatures are necessary which we have with 55/45.

The head loss of the building is 38.993W. The chosen boiler would be by the manufacturer BUDERUS.

The chosen model would be the **Logamax plus GB162 45kW**.

Boiler size	GB162-45
Power (kW)	9,6-44,9
Hot water temperatur (°C)	Up to 85
Efficiency with 40/30°C (%) Hs/Hi	Up to 99,5/ up to 110,5
Efficiency with 75/60°C (%) Hs/Hi	Up to 96,4/ up to 107
Height (mm)	695
Width (mm)	520
Depth (mm)	465+6
Electrical consumption max/ average (W)	76/ 53
Mass (kg)	45



Prize 4025€ // 30.187,50DKK
(Information and picture by www.buderus.de)

Photovoltaic Panels:

Photovoltaic panel is a special system in this project because it's the only energy source which can produce energy in electric form. Currently, electricity production and storage raise global environmental and security problem. However this system is sometimes used in building construction. That why it's particularly important to know the sustainability of this system and to determine if it can be a relevant solution.

A) Photo-voltaic system:

The photovoltaic cell is the basic electronic component, using the photoelectric effect. Individual cells can change in sizes and power. Typically, one cell can only produce around 1 or 2 watts. To increase power output, individual cells are connected together to make a panel. Photovoltaic cells that compose a solar panel are made of silicon (Si) from quartz. Silicon is used as a semiconductor in solar panels. **Silicon must be pure at 99.9999%** to be used for photovoltaic cells. This level of silicon purity is obtained at a temperature of 1500 ° in an adiabatic enclosure to avoid any pollution. This process is complex and requires a big energetic consumption. This silicon block is cut into thin slices « wafers » with diamond saws and chemically treated with acid to remove surface impurities. Costs decrease with the thickness of its "wafers". There are different kinds of silicon to produce the cells like mono crystalline silicon, multi-crystalline, multi-junction tandem, amorphous cells combined with hydrogen gas (SiH4). So the precise composition of silicon depends on the supplier.

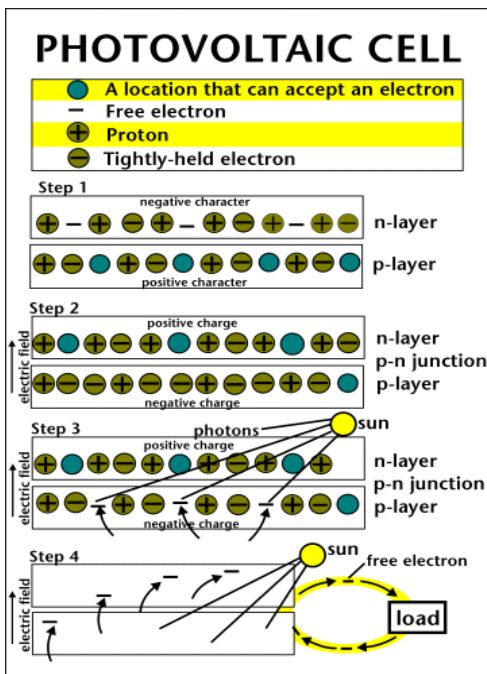

Sunlight is composed of photons, little particles of light energy. These photons contain various amounts of energy corresponding to the different wavelengths of the light spectrum. When photons strike a photovoltaic cell, they may be reflected, pass right through, or be absorbed depending on the wave length. Only the photons that are absorbed provide energy to generate electricity. When the electrons leave their position, holes are formed. When many electrons, each carrying a negative charge, travel toward the front surface of the cell, the resulting imbalance of charge between the cell's front and back surfaces creates a voltage potential like the negative and positive terminals of a battery. When the two surfaces are connected in series with a load, such as an appliance, electricity then flows in a close loop.

Fig. Photovoltaic cells.

<http://www.renergie.be>

The electrical current produced by this system is a continuous current of electricity.

It's important to notice that because the electrical current in global network is alternating more specifically given by a sinusoidal signal. In Denmark, signal frequency is 50Hz and this process permits to decrease a lot energy losses.

The schema on the right represents the usual working for photovoltaic system. There is no need to install a storage system with some batteries. And it is also possible to send all the electricity production to the network. The strategy depends on the building location, the country accommodation and the price of sending. At any case, it is necessary to use an inverter to convert the continuous current to an alternative electric current of 230V and 50Hz. The current yield of a photovoltaic inverter is around 96%. The price of the inverter represents more or less 15% of the global price of a photovoltaic installation.

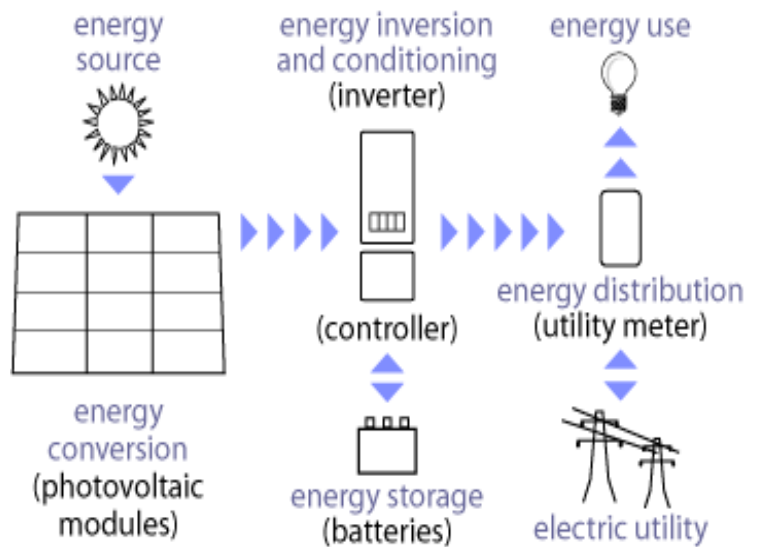

Fig. 4. Solar cells working system.

<http://www.renergie.be>

For the security of the electric system, it is also necessary to put a DC current interrupter between photovoltaic modules and the inverter, and of course a circuit breaker after the inverter. But the prices of these components are negligible in this kind of installation.

Currently the most utilizing kind of photovoltaic panels are made in crystalline silicon because these have for instance the best yield around. It exist two global different kinds of panels done in crystalline silicon the first one is polycrystalline and the second one is mono-crystalline. Mono-crystalline cell have the best yield between 13% and 17% but they have also the most expensive investment price. These cells are generally octagonal and a dark uniform color. Polycrystalline have a yield of 11 to 15%, but the cost of production is lower than mono-crystalline cells. They are rectangular in shape and are blue. It's also possible to use amorphous cell (cell in very dark gray) their investment price are quiet cheap but their yield are 2 or three time less good between 5% and 8%. Usually this kind or cells are more use when the support has some specific requirement and when the adaptation for the other cell is not easy.

B) Advantages and drawback:

The price and commercialization:

In the market the photovoltaic energy price is really the most expensive. According to a report made by the General Inspectorate of Finance (IGF) of August 2010: the difference between the purchase price (between 414 and 580 euros per MWh early 2010) and the market price (56 euros per MWh) is funded by electricity consumers. In Europe the sending price is between 7 and 10 times more expensive than the price of some other electricity.

The independence:

A building normal utilization required energy, this energy can be in an electric form or in a heating form. But an important part of the building energetic requirement must to be done by an electrical form. It's the specific electricity and for this building it represent --% of the total energy demand. With photovoltaic system used for the building consumption it's possible to create some independent structure which can work without connection to network energetically distribution. So it's can be efficient when the landscape or the distance make the connection to the grid difficult.

The reliability:

The production of electricity depends about the weather so, in Denmark it's possible to give an approximation of energy consumption by year but it's impossible to calculate exactly the quantity of energy production. It's an important drawback because the sender can't give the exact time when the investment comes back.

Effects of Weather:

The performance of all solar systems is dependent upon sunlight. Climate conditions, such as clouds or fog, have a significant effect on the production of solar energy. This will directly affect your power output. Most modern panels have around 10% efficient in converting sunlight, meaning that only 10% of the energy that hits the panel is converted into electricity. Many researches are following to increase this efficiency at 20%.

Problem about the storage:

Actually the storage of electricity is an important problem. Even if some systems already exist like battery, pile or accumulator their efficiency is really low (they can store a little quantity of energy with a lot of energy losses). For this building stock some electric production is absolutely not relevant. Firstly because in this case there is possible to connect the building at the network grid and there is not specifically expensive. Secondly because the quantity of energy that need to store is really important. So the energy losses in the storage system will be also important. To finish the current systems for store the electric energy are particularly polluting and not without some security risk.

C) Valuation of environmental impact:

Popularly photovoltaic is classified like an eco-friendly energy systems because it's used a renewable energy. In opposition of fossil energy or nuclear solar resource is unlimited and don't produce any pollution during the process to transform it in electrical form. However the environmental impact of this process is not negligible. Indeed the production and the waste management of the materials which can take this energy raise some problems.

Photovoltaic panels have life duration between 20 and 25 year and it's product an important quantity of chemical waste. Currently it's extremely difficult and require some of energy to separate the photovoltaic components and recycle one part of it. Furthermore it's contain some component that for instance scientists don't know any systems of recycling. The recycling goal for 2020 is to take back 65% of all photovoltaic panels sending for recycling 85% of each panel. About the life duration of an inverter is between 8 and 10 year and the recycling still also a problem.

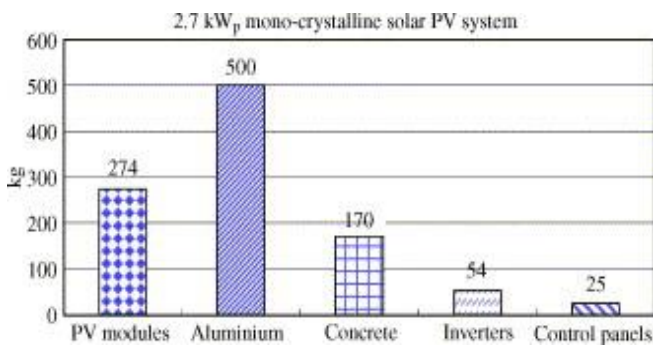

As it's indicate in the diagram on the left photovoltaic panels used a lot of aluminum thereby some dangerous products like plumb and bromine. The production of aluminum is very energy consuming and generates emissions of sulfur hexafluoride or SF6 gas greenhouse warming (coefficient of 22,200 against 1 for CO2) high power.

Fig. 4. Photovoltaic cells composition. <http://www.econologie.info>

Fig. Solar cells cycle. <http://www.energysavingtrust.uk>

Solar cells Life cycle:

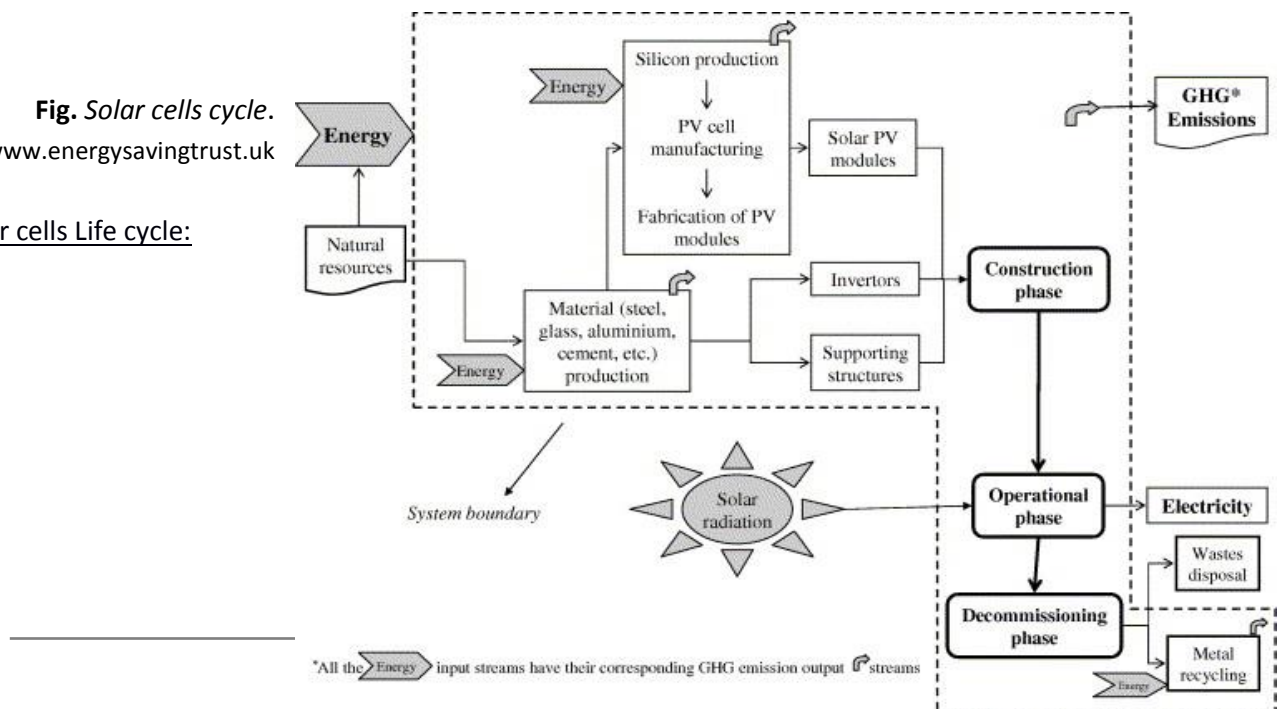

A current photovoltaic panel need 3 year for give back the energy spending during its production. So then returns between 7 and 8 times the energy required for its manufacture. But these numbers don't take in count the energy losses in the inverter and the storage problem.

The **carbon footprint of a complete photovoltaic system is valued at approximately 84g CO2 kWh**. This is an average of 13 studies make for different kind of photovoltaic cells. This number is quite important because of the complicate process for produce the silicon block.

This is different valuation of the CO2 production per kWh of electric energy for different system of production. There is done by agency of environment and energy management in France. That is for make a comparison and has a global idea about the environmental efficiency.

Production of CO2 for different systems of energy production:

Systems of production:	hydraulic	nuclear	Wind turbine	photovoltaic	natural gas	fuel	coal
Gram of CO2 per kWh	4	6	3 to 22	60 to 150	883	891	978

In several countries photovoltaic is used like a totally eco-friendly system and permit to obtain more easily some certification like BREEM or LEAD. But usually they don't take in count the pollution given by during the production and the wastes management. And they don't value the quantity of waste per energy production.

D) Calculation:

In any way the production of electric energy is expensive and come with some important repercussion for the environment. That why there is really not sustainable to use electricity for heating. For this building even if some solar cell will be installing their production will be used only for the electric requirement and not for the heating production. So, the additional electric production will be selling on the common grid and the heating system will be separate. But the photovoltaic system must to produce at least the same quantity of energy that the electric requirement of the building. It's important to specify that is not necessarily the electricity spending in the system. Because it's impossible to manage the electric production.

For find the most sustainable system the BE10 can be an important help for see the electric demand supply by the solar cell. And for see the variation of energetic production in comparison to the variation of panels' size. But the study about the commercialization of the solar cell and the market price of energy is at least as important for find the more profitable system and give some relevant result about the efficiency of solar panels in this case. Because the BE10 don't give any price and if we look only at the

quantity of energy product after buy the system it's obviously going to give some over dimensioned results.

In Denmark, home to some of the highest electricity rates in Europe, the existing net-metering rules offer a generous return. According to PV industry PHOTON, consumers pay 2.20DKK per kilowatt-hour for electricity in Denmark, with taxes accounting for 1.60 DKK of the total. So this building has specific electric consumption about 126423kWh per year. So without photovoltaic production, the cost for supply the specific electric demand during one year is: 278130 DKK.

PV system owners do not pay tax on the electricity generated by their rooftop arrays, which results in a subsidy of 1.60 per kWh for the electricity produce by solar cell and use in the building consumption. For electricity exported the grid, PV system owners would receive 1.30 DKK per kWh in 2013. But to account for falling PV module prices, this rate would fall to 1.17 DKK in 2014 and about 1.00 DKK in 2015. After 10 years, the rate would be down to about 0.60 DKK per kWh. For the do calculation the price using is 1.17 because the contract about photovoltaic will be done in 2015 and even if the price change after it's forbidden to break a contra. Usually the time of theses contract are around 20 years. So these calculations are done for duration of 20 years. After that in a normal case solar panel will still produce some energy but it's truly difficult to predict how much because their productivity will be decrease and impossible to say the future price of selling. PV system owners would get the full price 2.20 DKK for all electricity used when the photovoltaic system don't supply the demand in the building (for example during the night and dark day).

The final product selected is selling by the company JP .lec (in France) and the product reference is HP12-140. It use mono-crystalline cells and it's have a maximal power of 140Wc. The unity Wc is a unity use specially for photovoltaic calculation it's represent the maximum power in diagram tension/current, a solar irradiation at 1000 and the cell temperature at 25' all of this calculate for one decimeter scare. Each panel has a size of 0, 8613. Each panel has a price of 3640 DKK all of the taxes include. The efficiency of all of this system is about 88% with an inverter efficiency of 96%.

With the BE10 for give some information about the energetic production by scare meters of this solar cell adapted on this building and the Danish energetic market the final calculation of the solar panel suitable size is about 92m2 of area (107 of these panels). So the first investment for the entire installation including the fixation the cable and the inverter is normally 398565 DKK but it's can be negotiable because it's buy on the same company. For this installation the global annual production is around 134426,5 so it's according with the requirement to produce more electricity than spend. But production and spending are not done in the same time particularly in Denmark.

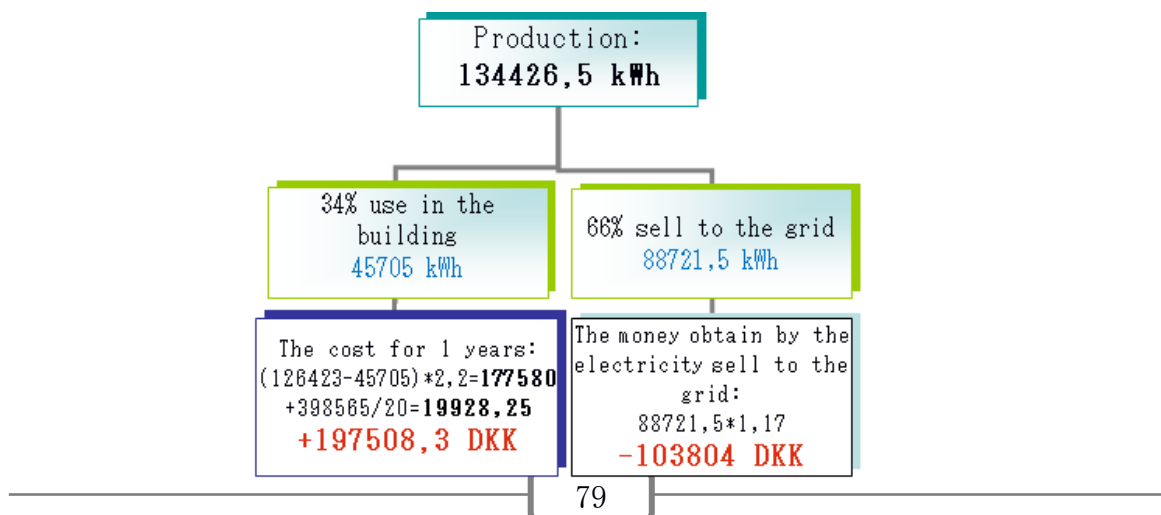

So for this study on 20 years the diagram make on the right explain the way of calculations. The final result is: **the annual money spend in electricity with a photovoltaic system is about 93704,3 DKK instead of 278130 DKK.** So with this calculation it's look like really more efficient to use solar cells. But this price must to increase a little bit because of the price of the installation and maintenance which is currently impossible to value.

Heat pump

The principle of the heat pump was known since the 19th century. But at the beginning it was mainly used for cold production such as in a fridge. In European building construction, this technology began to be really used for heating production during the 70s. Currently it knows important development because of the energy price and environmental issues.

A/ Heat pump system:

General system:

A heat pump is a device that transfers heat energy from a heat source to a heat sink against a temperature gradient. Heat pumps are designed to move thermal energy opposite the direction of spontaneous heat flow. A heat pump uses some amount of external high-grade energy to accomplish the desired transfer of thermal energy from heat source to heat sink.

The general working is to use a refrigerant fluid for through a thermodynamically cycle which the purpose is to looks like as much as it's possible to the Carnot cycle. The working fluid, in its gaseous state, is pressurized and circulated through the system by a compressor. On the discharge side of the compressor, the now hot and highly pressurized vapor is cooled in a heat exchanger, called a condenser, until it condenses into a high pressure, moderate temperature liquid. The condensed refrigerant then passes through a pressure-lowering device also called a metering device. This may be an expansion valve, capillary tube, or possibly a work-extracting device such as a turbine. Then the low pressured liquid refrigerant enters another heat exchanger, the evaporator, where the fluid absorbs heat and boils. Next the refrigerant returns to the compressor and the cycle is repeated

In the condenser, the energy produced during the evaporation and the thermal energy of compression are transmitted to the water. This water can then be used to heat the home like it represented in the picture on the right by the heat source which gain energy. The cold source is usually the ground but it can be the air. It's important to notice that this system require some additional electricity for

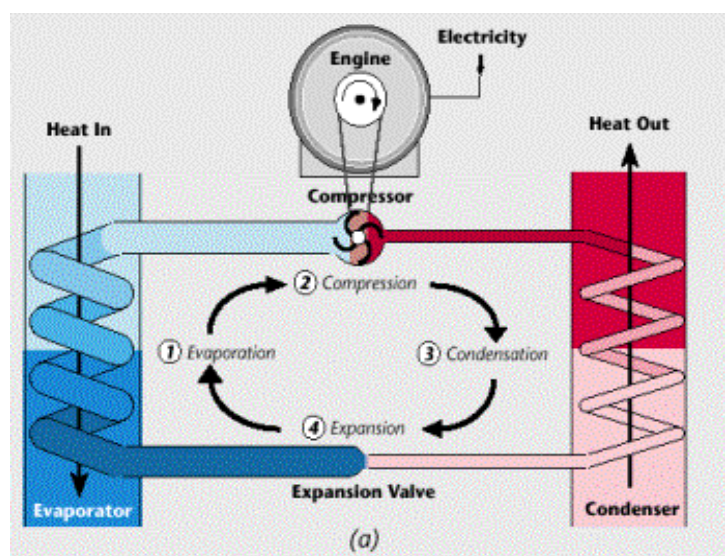

Fig. 4. Heat pump principle.
<http://www.futura-science.com>

supply the compressor.

Specification for different heat pump systems:

Ground Source:

Ground heat pumps harness the stored solar energy from just beneath the ground, via a horizontal collector loop which is located at a depth of approximate one meter below ground level and at a distance of approximately 75m apart. It's an ideal system for larger plots of land, with the exact area required being dependent upon the capacity of the soil in the specific location.

Specific advantages:

- The coil in the ground maintains an even temperature throughout the year
- no drilling needed
- lower installation costs
- Permit passive cooling



Fig. 4. Heat pump principle.
Pdf thermal energy storage

Bedrock sources:

A bedrock heat pump harnesses stored solar energy from the bedrock via a ground collector installed in one or more vertical boreholes, which can be up to 200 meters deep, the energy can then be used to provide space heating and hot water. This method of energy collection is ideal if the plot size is limited or if the minimal impact on the plot is required, for larger installations where high levels of heat extraction are required multiple boreholes can be installed.

Specific advantages:

- The hole in the rock maintains an even temperature throughout the year
- No large plot required
- Permits passive cooling
- Suitable for all building types; large and small



Fig. 4. Heat pump principle.
Pdf thermal energy storage

Air sources:

With an air source heat pump there is no need to dig, drill or have a large plot of land. Instead, the energy is collected directly from the surrounding air using an externally located air module. This can be located up to 30 meters from the outside of the building and is then linked to heat pump unit which is located indoors for maximum efficiency.

Specific advantages:

- No heat losses - heat pump unit is inside, only air unit is outside
- Lower investment costs
- no impact on the ground or on the plot



Fig. 4. Heat pump air.

Sometimes it's also possible to see some heat pumps which use

groundwater table but requirements are about the localization are really important. That's why this technology stay rarely apply In this case the grown is not appropriate to do it.

B) Advantages and drawback:

Efficiency:

The efficiency could be different between installations because it depends about the chosen system. Usually heat pump productivity is really important but the price of the first investment can be also very expensive.

Reversibility:

A heat pump can also be used for cooling production. This feature is particularly interesting in a lot of countries because cooling needs a lot of energy. In this case in Denmark, this building doesn't need cooling. Therefore it is interesting to know that but not useful here.

Specific requirements:

Usually these kinds of system are more suitable for an underfloor heating. It can be used with traditional radiator heating if radiators are big enough to not decrease the efficiency. This problem can increase a lot the price of the first investment. The building location must be suitable for different kind of heat pump system. Most particularly if it use horizontal collector. If the heating is done by air sources

C/ environmental impact:

Heat pumps operate without combustion, thus avoiding any local pollution. Heating using a heat pump allows for example to reduce CO₂ emissions. That's why it's usually sold as an eco-friendly source. The exact production of CO₂ emissions changes between different kinds of pumps. Usually studies for find the CO₂ emission produced by heat pump system are conflicting. This is because the main production of CO₂ in heat pumps' utilization is generated by the quantity of electricity used to supply the condenser. So this production depends about electric energy sources used (refer to the table in photovoltaic part about the quantity of CO₂ produce per kWh for different sources). However refrigerant liquids used in the closed circuit produce also a no negligible quantity of greenhouse gases by indirect way. This quantity depends about the kind of fluid used. Each liquid refrigerant is controlled and its impact on the greenhouses is indicate by the **TEWI (Total Equivalent Warming Impact).**

D/ Calculation:

Methods used to find the most suitable and precise system consists in realizing some test of all values in the BE10 program. The usual process to do it is by dichotomy. It will be often use in that case. An economical and a commercial study are done simultaneously to compare price and quantity of energy given by each system. The valuation of hot water consumption is estimated at 70840L per year. Utilization of heat pump gives an additional consumption of electricity and hot water as it notice on the picture. It's important to precise that heat and electric consumption will be change after.

Contribution to energy requirement		Net requirement	
Heat	6,5	Room heating	6,5
El. for operation of bulding	29,6	Domestic hot water	5,4
Excessive in rooms	17,8	Cooling	0,0
Selected electricity requirements		Heat loss from installations	
Lighting	28,2	Room heating	0,0
Heating of rooms	0,0	Domestic hot water	0,8
Heating of DHW	0,0	Output from special sources	
Heat pump	1,4	Solar heat	0,0
Ventilators	0,0	Heat pump	5,4
Pumps	0,0	Solar cells	0,0
Cooling	0,0	Wind mills	0,0
Total el. consumption	43,7		

The plot sell with the building is quiet important and don't have any special requirement, so it's possible to install the heat pump which use the ground source. But the system of heating by ventilation that it find before can be only adapted with an air sources or the investment cost will be increase a lot.

a/ Heat pump used only for hot water system and for duo system:

Here the most adapted solution is to choose a boiler which can product all the hot water requirement. In fact used a combined system only for supply a little quantity of energy is not really relevant. Because of the price of the installations and leaks.

After do the test with the BE10 the conclusion is: Use a heat pump only for supply the hot water requirement is absolutely not relevant. Because the demand of hot water is really not enough for justify a heat pump utility. And in any way in the commerce it's impossible to find heat pump with this lower features.

Description: Heat pump for hot water sytem

Heat pump Type: DHW, Share of floor area, -: 0

Hot-water tank: Volume 204 litres

Room heating: 0, DHW: 0,4

0, 3, 0

Test temperatures, °C: Cold side 7, Warm side 55

Earth hose, Venting, Room air

0, 0

0, 0

Nominal effect, kW

Nominal COP, -, Incl. of pumps, ventilators and automatics

Rel. COP at 50% load, -

Cold side: Earth hose, Vent, Outdoor air or Other source

Warm side: Room air, Air supply or Heating plant

Special auxiliary tool, W, not included in nominal COP

Automatics, stand-by, W, (constant service)

The picture on the right represents the eventual heat pump system which can supply the entire hot water requirement.

All of the hot water consumption can be produce with a heat pump at a nominal effect of 0,4 kW. Or the minimal nominal effect for a heat pump what is possible to find is about a heat pump air/water and it's 0,7. For sure it's possible to oversize the system but the losses will be particularly important and the system will be inefficient.

Duo system is often use in heat pumps installation. It's a simple system which uses two different heat pumps the first one for the heating and the second one for the hot water consumption. So it's evident that this system is not adapted if the strategy to use heat pump only for hot water consumption is not adapted.

b/ Combined system for hot water and heating system:

Use a combine system in this case will be particularly not efficient. Firstly because hot water's requirement are too low. Secondly because it's really difficult to use the same heat pump in air system and in a water system. So even if energetics' calculations with the BE10 are satisfactory. The cost of the installation will increase a lot for almost the same quantity of energetic production.

c/ Heat pump used only for heating system:

The main principle of heat pump working is to use one difference of temperatures between two places. So more this difference is important and more the efficiency of the heat pump increase. That why in this case it will be more efficient to use this technology in the office part than on the storage part where the heating requirement is only fixed at 15°C.

The commercial product which can supply the most important part of energy is the DC FFQ four voice and it's produced by the company Daikin. On the picture on the right represent the test make this product on the BE10. Some data about ventilation had taken in the ventilation part (such as air flow and air supply temperature). The temperature of the cold side is not constant, so this is an average temperature of months which heating is require in Horsens.

In this case the quantity of energy supply by this pump system is 8,2 kWh per year per m² of area. It's represent **71,93% of the total heat energy** according with the final result find for the

heat energy in the office area. The heating final energy demand is 11,7kWh per year per meter scare of area (9418kWh per year). The totale price for the Daikin produce is 12422,5 DKK.

So this system it's only a supply system and like solar panels it's combine with district heating. In Horsens one MWh of heat energy produce by district heating is 663 DKK according with the result in district heating part to the report. In this case the heat energy consumption is 9418kWh per year for the office area.

Description		Heat pump for heating by ventilation	
Heat pump		Hot-water tank	
Type	Share of floor area, -	Volume 200 litres	
Room heatin	0		
Room heating		DHW	
5,8	0	Nominal effect, kW	
3,4	0	Nominal COP, -, Incl. of pumps, ventilators and automatics	
1,2	0	Rel. COP at 50% load, -	
Test temperatures, °C			
0	0	Cold side	
20	0	Warm side	
Venting	Earth hose	Cold side: Earth hose, Vent, Outdoor air or Other source	
Air supply		Warm side: Room air, Air supply or Heating plant	
0	0	Special auxiliary tool, W, not included in nominal COP	
50	0	Automatics, stand-by, W, (constant service)	
Heat pumps connected with ventilation			
0,82	0	Temp. Efficiency for HRV before heat pump, -	
20		Dim. air supply temperature, °C	
0,14	0	Air flow, m³/s	

So with district heating the global cost for the heating is 6244 DKK per year. **With a heat pump combined the price for the heat energy per year is 4850 DKK.** For this price money spend for the district heating part of consumption is 1752 DKK, money spend for the heat pump installation is 621 DKK and money spend for the additional electric consumption is 2470 DKK . This is calculated for duration of 20 year because the guaranty of the heat pump is 20 years and the life duration of air/air heat pump is generally between 20 and 25 years. The price for the heat pump maintenance and the fluctuation of the district heating price was not taking in count. So with this **heat pump system the money saves by year after 20 years of utilization is about 1391 DKK.** The storage part still used district heating so the price don't change.

For comparison if it used electricity for primary system the cost for heating the office by year increases at 16010 DKK. And if it used electricity combine with heat pump the cost is 6953 DKK. So in this case money saves by year is 9057 DKK.

Biomass Boiler:

Biomass heating is a bioenergy usually considerate like a renewable energy. The oil price significantly increases since 2003 and consequent price increases for natural gas and coal have increased the value of biomass for heat generation. Forest renderings, agricultural waste, and crops grown specifically for energy production become as competitive as the prices of energy dense fossil fuels rise. The use of Biomass in heating systems has a use in many different types of buildings, and all have different uses.

A/ Biomass boiler system:

Biomass heating consists to use the energy product by the burning of some organic components (natural components). Currently the materials using for the biomass combustion are classify in three groups: Lignocellulose biomass (cellulose and lignin), biomass carbohydrate-rich carbohydrate substances and the oleaginous biomass rich in lipids. But for a heating system in a building only the first one can be suitable the other are more use for biofuels or electricity production. In a building biomass boilers operate as conventional boilers but replacing fossil fuels with natural fuels such as: Wood (chips, pellets, chips wood), waste produce by animals farming and crop waste with high energy.

The working of a biomass boiler and a traditional boiler is similar, fuel is burned in the combustion chamber and produce energy in a heat form. The residual heat from a biomass unit varies greatly depending on the boiler design and the thermal mass of the combustion chamber. Light weight, fast response boilers require only 10ltr/kW, while industrial wet wood units with very high thermal mass require 40ltr/kW.

Buffer tanks, sometimes referred to as 'thermal stores' are crucial for the efficient operation of all biomass boilers where the system loading fluctuates rapidly, or the volume of water in the complete hydraulic system is relatively small. Using a suitably sized buffer vessel prevents rapid cycling of the boiler when the loading is below the minimum boiler output.

B/ Advantages and drawback:

Energy manageable:

It exist three kinds of energetic production. Firstly energy sources which produce some energy sometimes but it's predict when and to control the production like wind turbin or solar-panels. After energy sources which produce the same quantity of energy all time like nuclear power. And the last one is energy sources which can produce some electricity when it necessary. A biomass boiler use for heating a building is one of the last category. This feature is particularly important because it's doesn't require any storage. This kind of energy sources can be particularly efficient for replace the energy sources that the production is difficult to manage.

The fuel management:

After the installation of the biomass boiler it necessary to pay for the fuel. So, the benefit can change with the price fluctuation of fuel which it's use. Furthermore this system require a special area for store the fuel.

C/ environmental impact:

On a large scale, the use of biomass takes agricultural land out of food production, reduces the carbon sequestration capacity of forests, and extracts nutrients from the soil. Combustion of biomass creates air pollutants and adds significant quantities of carbon to the atmosphere that may not be returned to the soil for many decades. Using biomass as a fuel produces air pollution in the form of carbon monoxide, NO (nitrogen oxides), VOCs (volatile organic compounds), particulates and other pollutants, in some cases at levels above those from traditional fuel sources such as coal or natural gas. In 2009 a Swedish study of the giant brown haze that periodically covers large areas in South Asia determined that it had been principally produced by biomass burning and to a lesser extent by fossil-fuel burning. Researchers measured a significant concentration of ^{14}C , which is associated with recent plant life rather than with fossil fuels.

Biomass has a truly important footprint. On combustion, the carbon from biomass is released into the atmosphere as carbon dioxide (CO_2). The amount of carbon stored in dry wood is approximately 50% by weight. When a tree's carbon is released into the atmosphere in a single pulse, it contributes to climate change much more than woodland timber rotting slowly over decades. Current studies indicate that "even after 50 years the forest has not recovered to its initial carbon storage" and "the optimal strategy is likely to be protection of the standing forest". When from agricultural sources, plant matter used as a fuel can be replaced by planting for new growth. When the biomass is from forests, the time to recapture the carbon stored is generally

longer, and the carbon storage capacity of the forest may be reduced overall if destructive forestry techniques are employed. Furthermore woods often come from the Amazonian forest so the transportation product CO2 emissions and it's destroyed the local environment.

D/ Calculation:

The method use for find the most suitable and precise system is to make a rang of all value in the BE10 program. At the same time a economical and commercial study will be done for compare the price and the quantity of energy gave by each systems. The valuation of the hot water consumption is estimate at 70840L per year for the storage and the office part of the building. And the additional heat energy to supply only the hot water heating is 3703kWh per year it represent 11,6 of the global heat energy consumption.

a/ Biomass boiler use only for the hot water system:

Here the most adapted solution is to choose a boiler which can product hall of the hot water requirement. Because install another system only for supply a quiet little quantities of energy is not really relevant. Furthermore a boiler can produce energy more or less in accordance with demand. So a good system of storage can permit to improve the efficiency but the quantity of energy losses during the storage time will be truly less important than with a system which the energetic production can't be manage.

Just on the right it's expose theoretical features of a biomass boiler used for supply only hot water requirement. The most suitable product find for supply this demand is refer by Quadralis PPA 8 in the company De Dietrich. The nominal effect of this product range between 2kW and 8kW but the full efficiency is only at 0,91. For the storage the maximal size of wood log is 330 mm.

Description				Boiler for hot water production			
Fuel				Biomass Oil, Gas or Biomass fuel			
Heat performance							
No. of boilers	Nominal effect, kW	Share of nom. eff. to DHW production, -					
1	3,2	1					
Nominal efficiencies							
Load, -	Efficiency, -	Boiler temp., °C	Correction, - /°C				
1	0,95	70	0,001 Full load				
0,3	0,81	35	0,003 Partial load				
Idle loss							
Load, -	Loss factor, -	Share for room, -	Temp. dif, °C				
0	0,01	0,5	30				
Operating							
60	Boiler temp., min, °C	0	Temp.factor, b for setup room				
100	Fan etc., W	5	El for automatics, W				

The wood consumption is 0,45kg/h at a power of 2kWh and 1,85kg/h at a power of 8kg/h. The price for this system is about 8000 DKK for the first investment and after the money spends for wood is about 500DKK by years for a wood consumption of 6840gram of wood. This is calculated for an average power of 3,5kWh and the result can change a little because it's depend of the wood quality. The starting consume also some additional electricity but with this product it's negligible.

To compare, price for supply the hot water system in this building with the fossil fuel boiler find by Carlo is really more attractive than this one.

b/ Biomass boiler use only for the heating system:

Heating requirement take in count in this study now are 9418kWh per year for the office area for be according with the part about heat pump. And it can be around 22500kWh in the storage part. The maximum power that our heating system can manage in a good way is 45kWh.

The most suitable product find in the market is referred by: ZEUS PYRO 42 and it's produce by the French company "eneove solair & bois". The picture on the right represents my test with this product in the BE10 program. It had done with the product's data. The maximum power is 44kW so even if it use with the maximum power it can be deliver by the system. The maximal size of the wood log is 550mm and the buffer tank capacity is 7L.

Description				Boiler for heating only			
Fuel				Biomass Oil, Gas or Biomass fuel			
Heat performance							
No. of boilers	Nominal effect, kW	Share of nom. eff. to DHW production, -					
1	42	0					
Nominal efficiencies							
Load, -	Efficiency, -	Boiler temp., °C	Correction, - /°C				
1	0,90	70	0,001 Full load				
0,3	0,82	60	0,003 Partial load				
Idle loss							
Load, -	Loss factor, -	Share for room, -	Temp. dif, °C				
0	0,01	0,5	30				
Operating							
60	Boiler temp., min, °C	0	Temp.factor, b for setup room				
100	Fan etc., W	5	El for automatics, W				

The first investment for this biomass boiler is 22940 and the wood consumption is about 10,5g/h depends about the wood. The building is heat 10h per day during around 250 days. So the annual consumption is around 26250g for a price about 1460 DKK per years.

So after 20 year of utilization (for be according with other systems) **the average cost spend by year is about 2610 DKK** instead of 21161 DKK by district heating and 54260 DKK by electricity. But the life duration of a biomass boiler is usually not as long as the duration life of a heap pump

for example and the maintenance costs are more expensive. This biomass boiler is guaranteed by his company only 30 months.

c/ Combined system for hot water and heating system:

The cheapest boiler system find in the market which can supply our consumption is also afford by the company “eneove solaire & bois” and contains data on the next picture. But the investment price stays very important 38480 DKK. It’s more than the first and the second add. It’s difficult to explain why because the efficiency 48,7 is suitable. Perhaps it’s because it had one buffer tank of 7L and another buffer tank of 25L include in the same boiler. Or perhaps it’s only because of commercial speculation. Any way this system is not yield compare at others combine.

Description					Boiler combined				
Fuel					Biomass <input type="button" value="▼"/> Oil, Gas or Biomass fuel				
Heat performance									
No. of boilers		Nominal effect, kW		Share of nom. eff. to DHW production, -					
1		48,7		0,15					
Nominal efficiencies									
Load, -		Efficiency, -		Boiler temp., °C		Correction, - /°C			
1		0,88		70		0,001 Full load			
0,3		0,80		60		0,003 Partial load			
Idle loss									
Load, -		Loss factor, -		Share for room, -		Temp. dif, °C			
0		0,01		0,5		30			
Operating									
50		Boiler temp., min, °C			0		Temp.factor, b for setup room		
100		Fan etc., W			5		El for automatics, W		

Solar Panels:

Usually solar panels are now much more efficient and cost effective than photo-voltaic system but it's produce only heat energy. Solar panels can have three different utilizations in building construction: heating the water for consumption, heating room system and a combine system. These systems comprise several innovations and many mature renewable energy technologies that have been well established for many years.

A/ Solar-Panels system:

There are two main types of solar panels systems:

-Direct system:

Direct or open loop systems circulate potable water through the collectors. They are relatively cheap. But usually it can be used only for a hot water system. And they often need some special installation against overheated and more particularly against freeze. Until the advent of freeze-tolerant solar collectors, they were not considered suitable for cold climates since, in the event of the collector being damaged by a freeze, pressurized water lines will force water to gush from the freeze-damaged collector until the problem is noticed and rectified. Currently this kind of installation stays more use in the south countries.

-Indirect system:

It's a closed loop systems use a heat exchanger that separates the potable water from the fluid, known as the "heat-transfer fluid" (HTF), that circulates through the collector. The two most common HTFs are water and an antifreeze/water mix that typically uses non-toxic propylene glycol. After being heated in the panels, the HTF travels to the heat exchanger, where its heat is transferred to the potable water. Generally a little bit more expensive but the same solar panels can use for heating and hot water production (in two separate storage space).

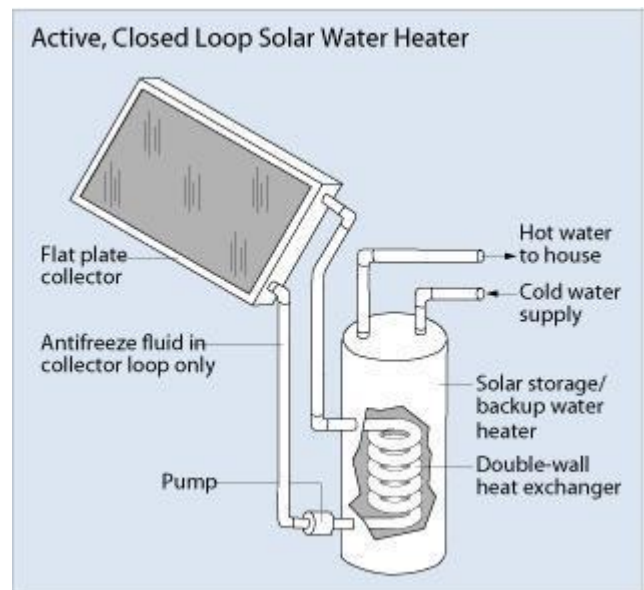

Fig. 4. Solar Panels system

<http://www.renergie.be>

This different kind of systems can be passive or active. Passive systems rely on heat-driven convection or heat pipes to circulate water or heating fluid in the system. Passive solar water heating systems cost less and have extremely low or no maintenance, but the efficiency of a passive system is significantly lower than that of an active system, and overheating and freezing are major concerns. Active systems use one or more pumps to circulate water and/or heating fluid in the system. So, in an active system the placement of storage tank don't raise any problems whereas in a passive system.

It's also possible to have some heat collectors with air. There are constituted by an important glasses area. The sun shines on the collector glass, which being transparent to the wavelength of visible radiation allows transferring the greater part of the energy. Air is heating by greenhouse effect.

B/ Advantages and drawback:

Specials installation requirement:

- Usually these kind of installation require a suitable building architecture.
- A security system must be installing to avoid any risk of burns.
- For several case there is necessary to add some systems against freeze.

Efficiency and installation cost:

Usually solar-panels installations and first investment are ones of the more cheap kind of energetic systems. But the quantity of the energy production depends about the location. In tropical places the insulation can be relatively high, e.g. 7 kWh/m² per day, whereas the insulation can be much lower in temperate areas where the days are shorter in winter, e.g. 3.2 kWh/m² per day. In Denmark these systems can save around 300 kWh per year per square meter of sensors. But as photovoltaic systems it's difficult to predict the quantity of energetic production.

The dependence:

Even if the yield of these systems is really good for the quantity of energy production they can not supply all of the energetic demand particularly in north countries like Denmark. They must be combined with an other system like an heat pump or a boiler and it's increasing a lot the first investment.

C/ Valuation of environmental impact:

Active solar thermal systems that use mains electricity to pump the fluid through the panels are called 'low carbon solar'. In most systems the pumping cancels the energy savings by about 8% and the carbon savings of the solar by about 20%. The carbon footprint of such household systems varies substantially, depending on whether electricity or other fuels such as natural gas are being displaced by the use of solar. Except where a high proportion of electricity is already generated by non-fossil fuel means, natural gas, a common water heating fuel, in many countries, has typically only about 40% of the carbon intensity of mains electricity per unit of energy delivered. The energy used in manufacturing is recovered within the first two to three years of use of the SWH (Solar water heating) system through heat captured by the equipment according to this southern European study. Moving further north into colder, less sunny climates, the energy payback time of a solar water heating system in a UK climate is reported as only 2 years.

Exposed to radiation from the sun (ultraviolet, infrared ...) and weather, solar panels materials degrade gradually. It is believed that this type of solar panel can function optimally twenty years. An important part of solar panels production is located in Italy. The production of a test SWH system in Italy produced about 700 kg of CO₂, with all the components of manufacture, use and disposal contributing small parts towards this. Maintenance was identified as an emissions-costly activity when the heat transfer fluid was periodically replaced.

In summary, the energy and emissions cost of a SWH system forms a small part of the life cycle cost and can be recovered fairly rapidly during use of the equipment. Their environmental impacts can be reduced further by sustainable materials sourcing, using non-mains circulation, by reusing existing hot water stores and, in cold climates, by eliminating antifreeze replacement visits.

D/Calculation:

The method use for find the most suitable and precise system is to use some standard calculations for have a models and after make a **rang of all value in the BE10** program for find the most suitable system. At the same time an economical and commercial study will be done for compare the price and the quantity of energy given by each system. As it say before solar-panels can't supply all of the energetic demand. And the purpose is to compare only the efficiency of solar-panels. That's why for do the comparison the part of energy which is not provide by solar-panels will be provide by district heating. Because it's usually use in Denmark and adapted at this location in Horsens.

The valuation of the **hot water consumption is estimate at 70840L per year** for the storage and the office part of the building. This valuation taking in count at the bathroom, the canteen and the cleaning. The storage tank using for keep the heat energy will be situated in the available floor and the solar panels will be situated on the storage part. That's why the length of the pipeline which leaks these is **16m and the diameter is 22cm**. It's complicate to find the exact losses associated at this pipeline because it's depend about the external temperature of the pipeline and this temperature is not the same in winter and in summer particularly in the storage part. For decrease the losses it should be really efficient to put an additional insulation round the pipeline and for be Eco-friendly the insulation will be done with wood wool make by recycling for a thickness about 5cm. The final estimation of losses after take in count of the specials losses give in the outlet of solar-panels, entrance in the storage tank and in corners are around **0,2W/(m*K)**. According with the building localization the Horizon cutoff is around 10 ' and the angle factor is valuate at 0,98'.

In the picture on the right it's notice the office heating requirement and all of the domestic hot water consumption in kWh per meter scare of area per years. Solar panels global installation adds a consumption of hot water around 0,8kWh/m2 per year because of the losses in the pipeline and in the storage tank. But the value about heating have change many time and for be accorded with the others parts I use that

Net requirement	
Room heating	9,9
Domestic hot water	5,4
Cooling	0,0
Heat loss from installations	
Room heating	0,0
Domestic hot water	0,8

the global heating requirement take in count in this study now are 9418kWh per year for the office area and around 22500kWh in the storage part. However the data about the hot water consumption is the good one (4,6 for the normal hot water requirement and 0,8the specific requirement obtain because of this system) . So the annual energy used for the hot water

consumption is 4347kWh.

a/ Solar- panels use only for the hot water system:

The first approximation for this kind of company building is to use 0.8m² of solar-panels per employer for a first approximation about 20m² of area. The usual slope is around 40°. At the beginning the storage tank must be over-dimensioned. Its suitable size will be found after the other results such as the appropriate slope, horizon cutoff, panels size, system efficiency etc...

The best solution here for saving money is to install a system which produces the entire hot water requirement. Because the hot water requirements are not too important and because installing another system or using district heating to supply a little quantity of energy is not really sustainable. But solar-panels particularly in Denmark don't produce all the time the same quantity of energy. So it should be efficient to find an important and suitable system of storage. I precise that the quantities of energetic production losses risk being important.

The slope which gives the best results is 47' of difference with the horizontal plan. This result will be taken for all of the solar panels calculation. For the hot water requirement the exact value of solar panels that we need is 23,2 for all of the consumption. According to that the most efficient size of the tank is 786L.

Observation: This number is quite important. The 10m² first square meters of solar panels have a good productivity but after that the efficiency of the system decreases a lot. For example with 5m² of solar panel the heat production for hot water is 3kWh/m² per year instead of 3.4kWh/m² per year if the solar panels have a size of 6m². So the extra square meter between 5 and 6 produces 0.4kWh/m² in addition. But now if we compare in the same way the energetic production for the last square meter at 21,2 to 23,2 it's around 0,1. So the last square meter used for the completed requirement produces less than 0,05kWh/m² per year. This explains why the m² of solar panels required for all of the hot water consumption is important.

b/ Solar-Panels use only for the heating system:

For the heating consumption it's for sure really difficult or impossible to supply all of the consumption. But it should be really interesting to compare the quantity of energetic production if the same system is used to supply the heating production instead of the hot water production. That's why the same solar panels will be used for both studies.

Observation: The result of using solar panels only for the heating consumption is not really efficient. Even if the size of the tank increases by 100L the energetic production for the same panels is divided by around 2. This system produces only 2.5 kWh/m² per year instead of 5.4 if it is used for the hot water consumption in the office and after taking into account the storage demand it's around 4,4kWh/m².

The commercial product finding which be the most adapted (In valuation of the quantity of energy product, the price of the first investment and the duration of this system) is the solar-panels EURO C20 KP 2160. The exact size of the panels is 23,5m² the size of the tank is 800. The picture just after represent the BE10 data used for calculates the energetic part supply by this product.

Description		Use solar panels for all of the hot water consumption	
Type	DHW	Domestic hot water, Room heating or Combined	
Solar collector			
<input type="text" value="23,5"/>	Total collector area, m ²	<input type="text" value="800"/>	Tank volume, litres
<input type="text" value="0,85"/>	Solar col. start eff., -	(From domestic hot water)	
<input type="text" value="3,5"/>	1. order coefficient of heat loss a1, W/(m ² K)		
<input type="text" value="0"/>	2. order coefficient of heat loss a2, W/(m ² K ²)		
<input type="text" value="0,98"/>	Angle factor, -		
Solar collector pipe			
<input type="text" value="16"/>	Length, m		
<input type="text" value="0,2"/>	Heat loss, W/(m K)		
<input type="text" value="0,8"/>	Heat exchanger efficiency, -		
El-consumption, pump and regulation			
<input type="text" value="50"/>	Pump in solar collector circuit, W		
<input type="text" value="5"/>	Automatics, stand-by, W		
Orientation and shadows			
<input type="text" value="S"/>	Orientation, S, SE, E ..., or deg., S=180		
<input type="text" value="47"/>	Slope, °, vertical=90		
<input type="text" value="10"/>	Horizon cutoff, °		
<input type="text" value="0"/>	Shadow, ° Left	<input type="text" value="0"/>	Shadow, ° Right

Final prices calculations for hot water:

For primary energy: The energy supply by solar panels is 4247 kWh/m² per year. It represents 12% of the total heating demand. So district heating still supply 88% of the total and the price for that is 2536 DKK per year. And all of the hot water requirement.

For energy supply: The first investment for all of the installation including panels, tanks the system of regulation and fixation is: 9 340€.

As it say in the environmental part solar panels can optimally work during at least 20 years and for do good comparison energies prices are going to be calculated after 20 years of utilization. The **average cost spend by year is about 467 DKK with this installation instead of 2882 DKK if it**

use only district heating.

Final prices calculations for heating:

For primary energy: The energy supply by solar panels is 3541,8 kWh/m² per year. It represents 9,8% of the total heating demand. So district heating still supply 90,2% of the total and the price for that is 19087 DKK per year.

For energy supply: The first investment for all of the installation including panels, tanks the system of regulation and fixation is: 9 340€.

The average **cost spend by year is about 19554 DKK** with this installation instead of 21161 DKK if it use only district heating after 20 years of utilization. And **each year this system saves about 1607 DKK of money**

c/ Combined system for hot water and heating system:

The first approximation for this kind of company building is to use 1.5m² of solar-panels per employer for a first approximation about 50m² of area. At the beginning (for find some relevant results about solar-panels' features) the storage tank must be over-dimensioned. Just for give one indication the system used before produce 6,1 kWh/m² per year. So it's a better production for sure but the investment price is more important in combined system. So it's will be more interesting to compare the price in the commercial market before for find some suitable systems and value after their real productivity.

After had rand the value in the BE10 program the most suitable slop find is 47°. The commercial product finding which be the most adapted (In valuation of the quantity of energy product, the price of the first investment and the duration of this system) is the solar-panels EURO C20 RF 2880/2. The exact size of the panels is 31,3m² the most suitable size for the tank find by the BE10 is: So the final size tank is 1000.

Observation: The valuation of the commercial price is not based on the quantity of energetic production but more on the market speculation and commercials proposition. That why even if this system is the system which have the most cheap price in comparison to the productivity it's not (in a theoretical way) the most suitable system when we look at the number of meter scare for the quantity of production.

On the picture it is all of the final data put in the BE10 program for do the calculations and the final result give with this program. So, the energy consumption in the office area is 5,8kWh/m² per year (4669kWh per year). With the storage part this result increase about 6,4 kWh/m² per year. So the **global annual energy supply by this product is 5152kWh per year.**

Description

Type Domestic hot water, Room heating or Combined

Solar collector

Total collector area, m² Tank volume, litres

Solar col. start eff., - (From domestic hot water)

1. order coefficient of heat loss a1, W/(m² K)

2. order coefficient of heat loss a2, W/(m² K²)

Angle factor, -

Solar collector pipe

Length, m

Heat loss, W/(m K)

Heat exchanger efficiency, -

El-consumption, pump and regulation

Pump in solar collector circuit, W

Automatics, stand-by, W

Orientation and shadows

Orientation, S, SE, E ..., or deg., S=180

Slope, °, vertical=90

Horizon cutoff, °

Shadow, ° Left Shadow, ° Right

Final prices calculations for combined system

For primary energy: The energy supply by solar panels represents 14,2% of the total heating demand. So district heating still supply 85,8% of the total and the price for that is 18154 DKK per year.

For energy supply: The first investment for all of the installation including panels, tanks the system of regulation and fixation is: 10240 DKK.

The **average cost spend by year is about 22199 DKK** with this installation instead of 24043 DKK if it use only district heating after 20 years of utilization. **And each year this system saves 1844 DKK of money.**

Seasonal thermal storage:

Another interesting solution for the building would be a seasonal storage system.

The German company isocal invented a system in collaboration with the company Viessmann which is not spread so far but has from my point of view a high potential in the future.

The system bases on the phase change of water to ice, a heat pump and a solar -air absorber.

Function:

During the heating phase the heat pump extracts energy from the water in the storage which is located outside of the building underground. By the time the ice starts to freeze (this process gives extra 332kJ/Kg). The extracted heat can then be used to heat the building. During the summer/cooling phase the created ice can be used to cool the building. In the chosen case of ventilation a cooling coil could just be integrated in the air handling unit. In addition to that a solar collector and air collector can be used to heat up the storage again. The solar collector can also fulfill the demand of hot domestic water during the summer.

Advantages:

- Independent system especially if the electricity is produced by photovoltaic panels
- It can cool without having chillers and waste heat
- In comparison to geothermal energy it is independent of the type of ground
- Not expected groundwater flow or other risks of geothermal systems don't influence the storage
- If also the electricity for the whole equipment is produced environmentally friendly it might be the most environmental friendly system on the market

Drawbacks:

- In comparison to district heating and normal boilers the investment costs are higher
- Outside space is needed for placing the storage (which shouldn't be a problem in our case)
- The technology is not very old and there might be unexpected problems

A comparable example: (By isocal.de)

An office building with a dwelling in south Germany

Head loss: 40kW

Cooling demand: 17kW

A funeral parlor wants to have a building with operation costs as low as possible. The storage system is a modified water storage located under a garage which is offered by the prefabricated garage manufacturer Zapf (www.garagen-welt.de). Under the garage is the 38.000l ice-water storage and on the main building are 36m² solar air collectors. The collector extracts also much energy from the air, this way it can work during the day but also during the night. Furthermore it is not visible from the street because the pipes are horizontal on the roof. Finally the heat pump is a 40kW gas absorption model.



Electronic heating

There are different possibilities to use electric heating:

One would be to have a heater spiral in a water containing radiator. The water can store the thermal energy for some time. Possible as well is to have under floor heating by electricity.

Another possibility is to have heat storing plates. These plates are made of a material that can store thermal energy for a long time. This offers the possibility to heat up the material during night when the electricity prices are lower and give the heat to the room during the day. Depending on the heating demand a fan can blow room air through the heat emitting material.

Advantages:

- No storage room for fuels
- Low investment costs
- Low or even no maintenance costs

Disadvantages:

- High operation costs
- Not everywhere allowed
- Cool storage in the evening (especially problematic for under floor heating)
- The efficiency depends in the end on the way the electricity was produced (which is often not very efficient)



www.aeg-haustechnik.de

For the reason that we wanted to choose an environmentally friendly and efficient system that offers a good indoor climate we don't choose a form of electrical heating. Main reasons are the high operation costs and that it is hard to get a good certification for a building with electric heating. It was also not possible to find a system based on electrical heating which is suitable for the storage area.

Feedback / reflection:

ANNEX

DOCUMENTS

ANNEX UNDERFLOOR

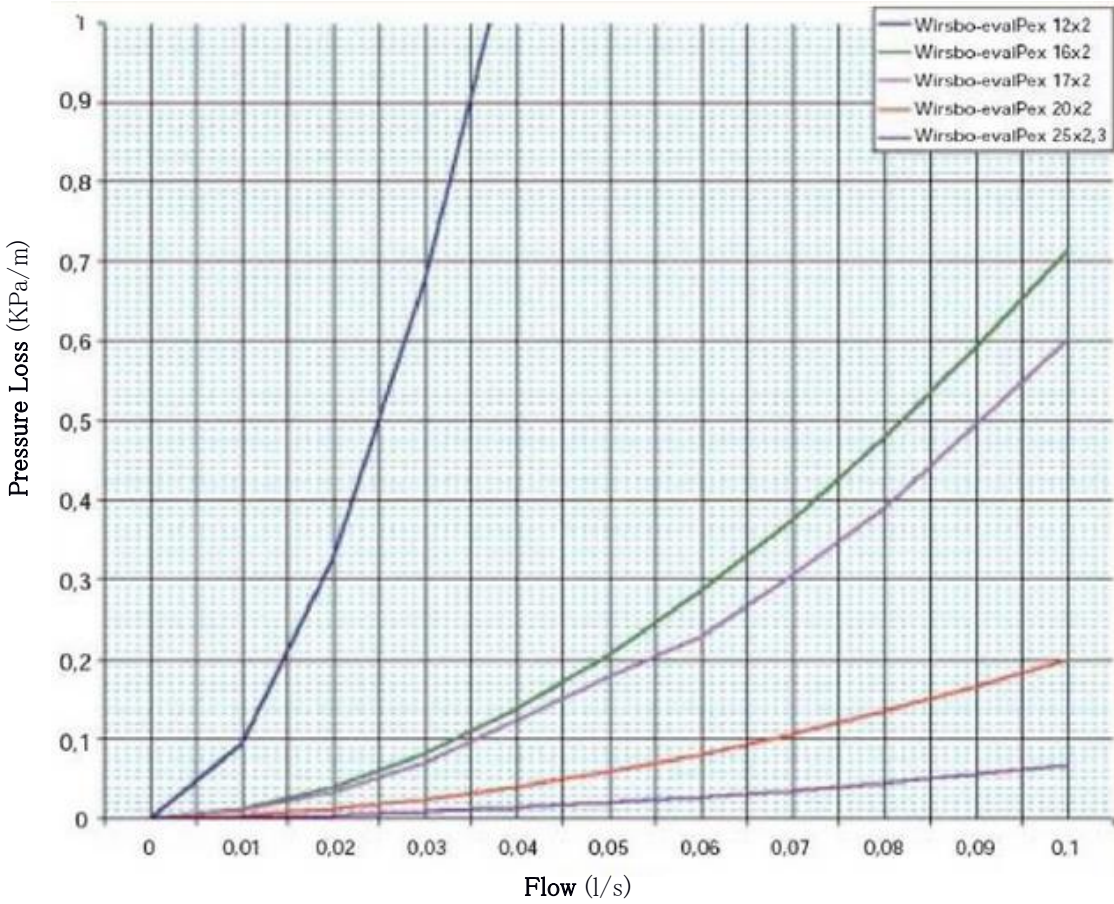

Fig. X. Graphics of the pressure losses depending on the flow
<http://es.scribd.com/doc/75858772/Metodo-Calculo-Calefaccion-Suelo->

ML - BYG
TIL DIG DER ØNSKER KVALITET

FORSIDE SPØRGSMÅL - RIS & ROS KONTAKT

Areas of expertise

- First halls
- Granite
- Floor Sanding
- Bricklayer
- Wrought Chamber
- Tagrenovering
- Carpentry / Joinery
- Velux
- Windows & Doors
- HVAC / Plumbing

Service	Price
Floor heating	
Underfloor Pex 20mm pipe. Rate. square meters excl. VAT incl. labor and materials.	267,00 DKK
Underfloor electric. Rate. square meters excl. VAT incl. labor and materials.	366,00 DKK
Thermostat control Price. paragraph. excl. VAT	700,00 DKK

Fig. X. Dainsh price of district heatingsystem
ML-BYG

ANNEX

Floor temp °C	Power W/m ²	Pipe Spacing cm	Pipe Density m/m ²	Circuit Length m	Max Circuit Area m ²	Heat Output W	Water Volume ltrs/hr	Pressure Drop mbar
Flow temperature 50°C Return Temperature 40°C								
25.7	75	30	3.3	60	18	1350	116	50
				80	24	1800	144	97
				100	30	2250	194	204
				115*	35	2625	226	306
26.5	87	20	5	80	16	1392	120	71
				100	20	1740	150	130
				120	24	2088	180	215
				200*	27	2349	202	295
27.1	97	10	10	100	10	970	83	47
				140	14	1358	117	119
				180	18	1746	150	235
				200*	20	1940	167	314
Flow temperature 55°C Return Temperature 45°C								
26.7	91	30	3.3	40	12	1092	94	23
				60	18	1628	141	70
				80	24	2184	188	155
				100*	30	2730	235	285
27.7	106	20	5	60	12	1272	109	45
				80	16	1696	146	100
				100	20	2120	182	183
				120*	24	2544	182	183
28.5	118	10	10	100	10	1180	102	67
				120	12	1416	122	109
				150	15	1770	152	200
				170*	17	2006	173	284

* maximum acceptable heating circuit lengths including pipe 'tails' to the manifold.