

Aerospace Technology

(Aerospace Engineering Degree)

Andrés Tiseira
David Blanco-Rodríguez
Marcos Carreres
Pablo Fajardo

APUNTES

UNIVERSITAT POLITÈCNICA DE VALÈNCIA

Collection Notes

Aerospace Technology
Aerospace engineering degree

Andrés Tiseira
David Blanco-Rodríguez
Marcos Carreres
Pablo Fajardo

EDITORIAL
UNIVERSITAT POLITÈCNICA DE VALÈNCIA

Collection notes

© Andrés Tiseira
David Blanco-Rodríguez
Marcos Carreres
Pablo Fajardo

© 2013, of this edition: Editorial Universitat Politècnica de València
<http://www.lalibreria.upv.es>

Ref.: 4068_03_01_01 (printed version)
Ref.: 6153_01_01_01 (electronic version)

Any unauthorized copying, distribution, marketing, editing, and in general any other exploitation, for whatever reason, of this piece of work or any part thereof, is strictly prohibited without the authors' expressed and written permission.



INDEX

Aircraft

1. Design Concepts.....	1
Civil aircraft	2
Military aircraft	5
Aircraft design.....	7
2. Architecture.....	13
Fuselage stresses	14
Monocoque and Reinforced Monocoque fuselages	16
Semi-monocoque fuselage.....	17
Geodesic fuselage.....	18
Warren and Pratt fuselages	19
Pressurized fuselages	20
Fuselage Components.....	21
Examples	23
Wing structural components.....	25
3. Fundamentals of Flight.....	31
Introduction to the aerodynamic airfoil	32
Definition of lift and drag over an airfoil.....	35
Airfoil characterization.....	40
High lift devices.....	48
Wing (definition and parameters)	51
Aerodynamic elements in wings.....	63
4. Aircraft Systems	69
Landing Gear	70
Fuel	75
Hydraulic System	83



Annex: Cabin conditioning system.....	88
5. Rotorcraft. General Concepts	93
Diverse aircraft	94
V/STOL aircraft and rotorcraft.....	94
Classification of rotorcraft.....	103
Comparison with other aircraft	105
Future of the V/STOL aircraft.....	107
6. Rotorcraft Aerodynamics	111
The development of the helicopter	112
Aerodynamic complexity	115
Helicopter flight dynamics.....	119
Helicopter architecture	119
Main design parameters in helicopters	132
7. Missiles.....	135
Missiles Classification	136
General Description	143
Control and Guidance System	144
Spacecraft	
8. Space Vehicles.....	151
Introduction	152
Subsystems	153
Typology	155
Interplanetary Spacecraft	155
Launch vehicles	163
Space stations.....	173
References	177

Aircraft

1. Design Concepts

- **Civil aircraft**
- **Military aircraft**
- **Aircraft design**

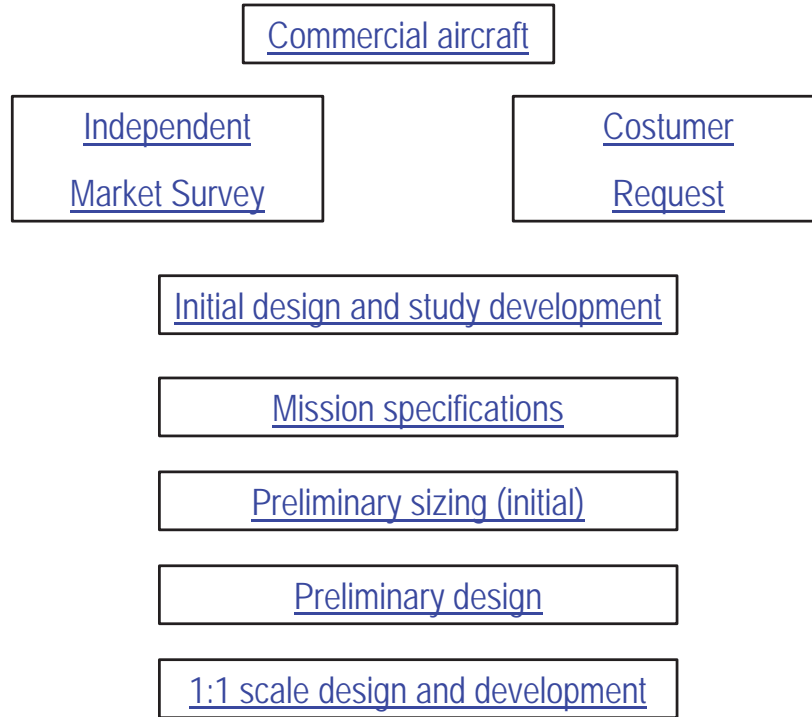

PBY-5A Catalina



Constellation



B-747



B-777



A-340



Il-62



MD-80



Beech Starship 1



P-180



CBA-123

A-300
BelugaB-50 (377
model) Guppy

Military aircraft

Specifications, operational requirement, military identity

Manufacturer identity, military necessity

Initial design and study development

Mission specification, depending on the task to be done

Preliminary sizing (initial)

Preliminary design

1:1 scale design and Development



Panavia Tornado (variable-sweep wing)



Grumman F-14 (Tomcat)





SAAB JAS 39 Gripen

IAI Lavi



Rafale (Dassault)

Eurofighter
Typhoon

- **Design approach: System of different topics which are linked together and constitute an iterative procedure**

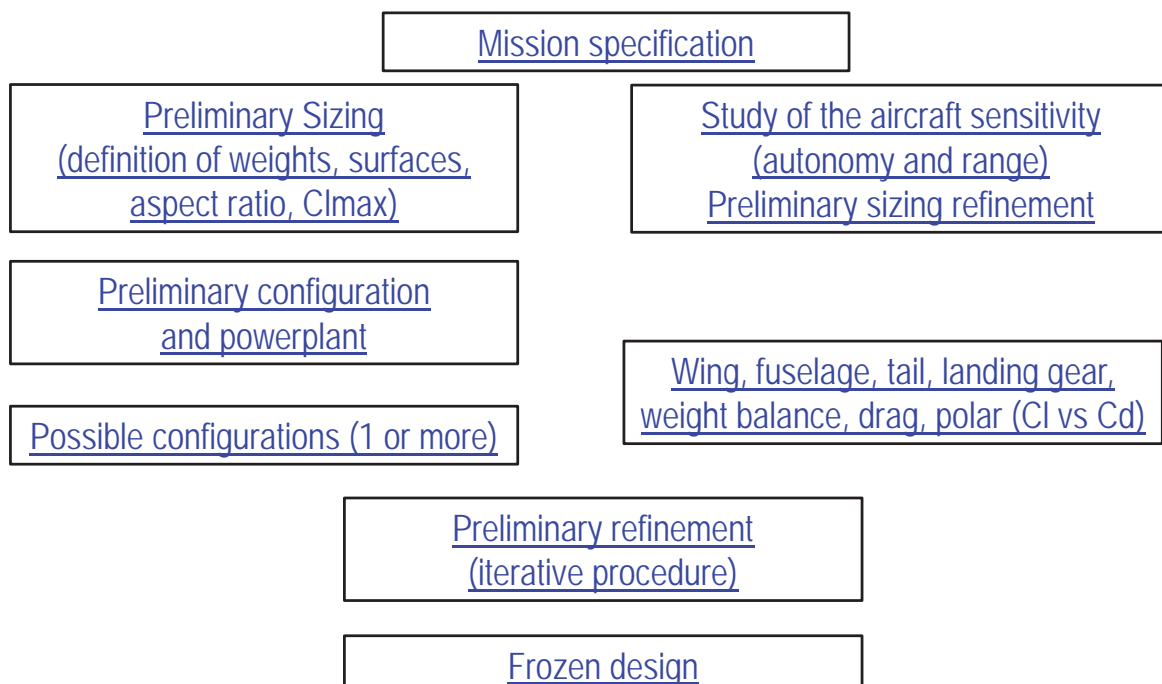

Preliminary refinement (iterative system)

Must take into account:

Wing limits

Fuselage and empennage

Aircraft weight balance

Polar

Flaps effect (and every high-lift device)

Stability and control

Structural limit

Landing devices

➤ **Examples of ideas applicable to the design**



Lockheed F-104 Starfighter
ZELL (Zero-length launch) aided with
rockets. The airplane had to be light
and with a high acceleration.

Evolution of the F-104, the
tail was modified due to
vibration issues



➤ Aircraft classification depending on their mission and requirements

1. Homebuilt propeller
2. Single engine propeller
3. Twin engine propeller
4. Agricultural airplane
5. Business jet
6. Regional turbopropeller
7. Transport jets
8. Military trainers, transport, patrol, refueling, search and rescue
9. Military fighters and bombers
10. Hydroplanes
11. Supersonic cruise airplanes
12. Rotating wing aircraft

➤ General design



- **Each of the different kinds of aircraft that can be designed respond to 6 general variables with regards to their design.**

Following the preliminary design of an aircraft, its components can be broken down so that each part of it can be explained.

- 1.Design (approximate shape of the aircraft)
- 2.Structure material (kinds of materials to use)
- 3.Physical method (calculations)
- 4.Mechanism (every movable system the aircraft needs to be operated)
- 5.Function (what it was conceived for)
- 6.Location (place in which it must commonly operate)

Preliminary Sizing
(definition of weights, surfaces, aspect ratio, C_{lmax})

The maximum weight of the aircraft at take-off is W_{TO} (take-off weight):

$$W_{TO} = W_{OE} + W_F + W_{PL}$$

W_{OE} operating empty weight of the aircraft

W_F fuel weight

W_{PL} payload weight (all the weight it can carry)

Where:

$$W_{OE} = W_E + W_{TFO} + W_{CREW}$$

W_E empty weight

W_{TFO} trapped fuel and oil weight

W_{CREW} operating crew weight

The empty weight of the aircraft can in turn be divided in:

$$W_E = W_{ME} + W_{FEQ}$$

W_{ME} manufacturer's empty weight (aircraft structure, wings and fuselage)

W_{FEQ} fixed equipment weight

The fixed equipment can be divided into:

1. Avionics equipment
2. A/C equipment
3. Radar
4. APU
5. Interior finishes and systems
6. Other equipment depending on version and mission
7. Landing gear

According to the definitions made so far, **the following topics will be studied in the Lessons 1 to 6 dedicated to Aircraft:**

- 2. Architecture (structures, fuselages and wings)
- 3. Fundamentals of flight (aerodynamics, stability)
- 4. Systems (landing gear, avionics and equipment)

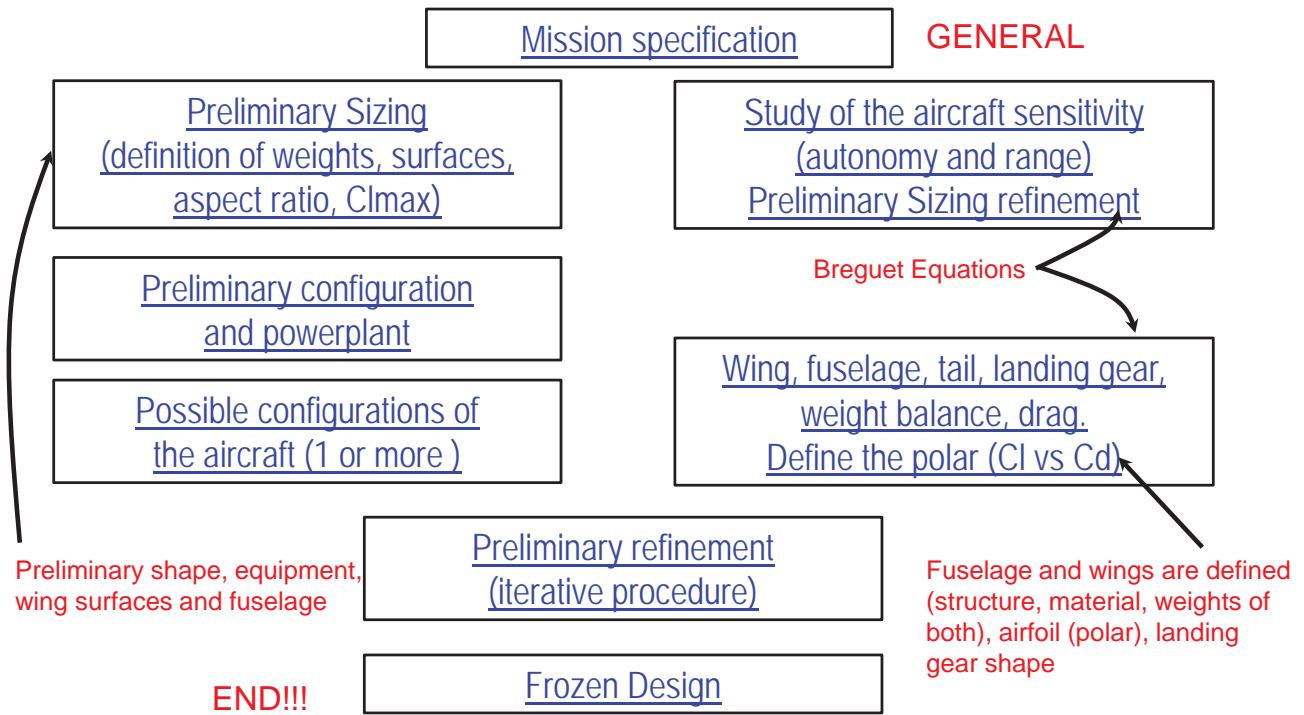

Aircraft

2. Architecture

Classification and main characteristics of the fuselage structures Wing structural components

- **Fuselage stresses**
- **Monocoque and Reinforced Monocoque fuselages**
- **Semi-monocoque fuselage**
- **Geodesic fuselage**
- **Warren and Pratt fuselages**
- **Pressurized fuselages**
- **Fuselage Components**
- **Examples**
- **Wing structural components**

➤ Analysis



Tensile
(tracción/axil)



Shear
(corte/cizalladura)



Compression



Torsion



Bending
(flexión)

- Structural components are subject to these stresses and their combinations.
- Compression and shear may lead to buckling (*pandeo*).

➤ Elastic modulus (módulo elástico):

If a force is applied on a structural element, this element will change its length. The change in length is proportional to the change in force (at least until a certain value). This relation is known as the Hooke's law.

If we consider stress (esfuerzo) instead of force and strain (deformación) instead of length change, this relation becomes more important. The stress on an element is not related to its material, but this is not true with respect to the strain. Different materials enlarge themselves in a different way when they are subject to the different load (carga). Thus, the relation between stress and strain, as given by the Hooke's law, is an important method to identify the material characteristics. This is the so-called elastic modulus or Young modulus.

$$E = \frac{\sigma}{\varepsilon} = \frac{F/A}{\Delta L/L}$$

- E: Young modulus (elastic modulus)
- σ : stress (force per unit of area)
- ε : strain (deformation)

➤ Stress-strain curve

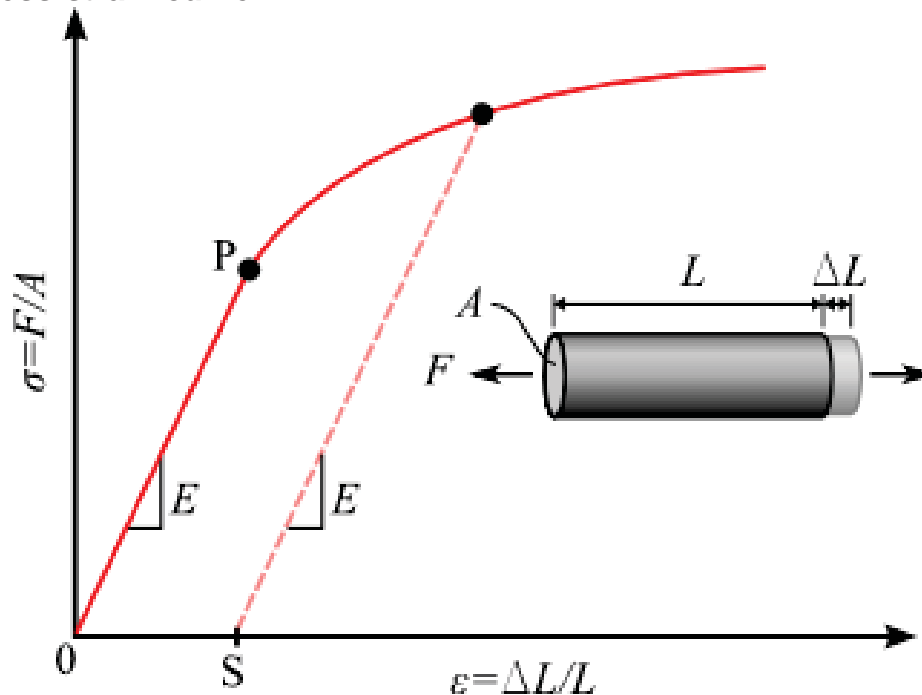

➤ Elastic material: Hooke's law

The **Hooke's law** is applied **from 0 to the point "P"**, called "proportionality limit". Up to point "P", if the load is increased, the deformation is proportionally higher. In the region previous to the proportionality limit, (also called "elastic limit"), if the load is removed the stress comes back to zero along the same line: **the material is elastic.**

➤ Plastic state

When the stress exceeds the elastic limit, the material is in **plastic state**. In this state, if the load is removed, the curve will not return to 0 but to the point "S" instead.

In this point "S" there is no stress, but an increase in length is kept. This increase in length is called permanent deformation.

➤ Design objective

Structure designers make sure that the stress levels of their structures will be kept under the elastic limit. Another concept is the so-called maximum yield stress, which is the stress level associated to breakage of the material. This is normally cited as a requirement when a material is ordered.

The aim of the aerospace engineer in his design is to never reach this limit, keeping the deformation as a last resort, in order to ensure a safety return to ground should any emergency happen.

It is a structure with a resistant skin (recubrimiento) that collaborates with the rest of the aircraft to provide resistance. It consists of an empty shell (casco/cáscara) without any transversal or longitudinal elements. It can also be a fuselage formed by several rings linked by this shell (reinforced).

The word “monocoque” means “shell or simple flat curve without reinforcement”. This structure has replaced the reticulated structures due to the higher stability achieved by using the resistant skin. Nowadays it is only used in those cases where no openings (i.e. windows) are needed or where those openings are only a few and small, so that the stress distribution is more uniform.

When it is employed, it is made of light alloys. Thus, its cross-section can be increased without additional weight, enhancing the stability of the body under the loads that are acting on the fuselage.

In short, it is a light structure but it is difficult to build and repair and it imposes several limitations to the design.

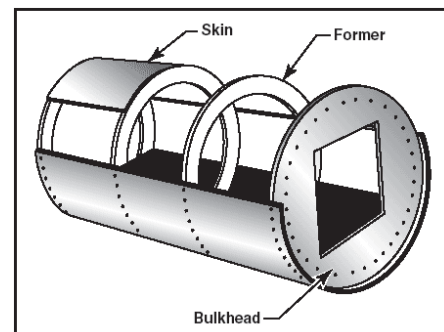
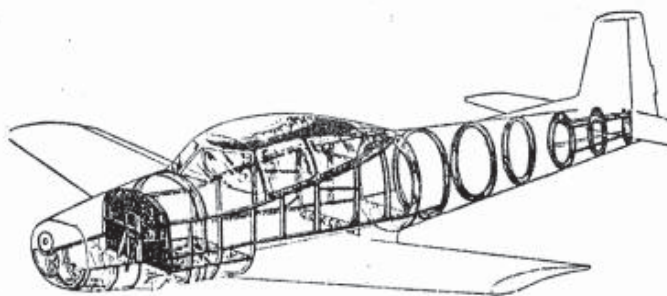

➤ Reinforced Monocoque Fuselage

The shell is reinforced by vertical rings (former rings or frames / *cuadernas*). As the skin can absorb the tensile stresses but not the compression ones (which easily lead to deformations), angular profiles of several shapes are added.



SZD-30

Reinforced monocoque glider (Wooden frames reinforced with fiberglass). The tail and movable surfaces are made of cloth.

In addition to the former rings or frames, there are longitudinal elements to reinforce the structure: stringers and longerons (*largueros o larguerillos*).

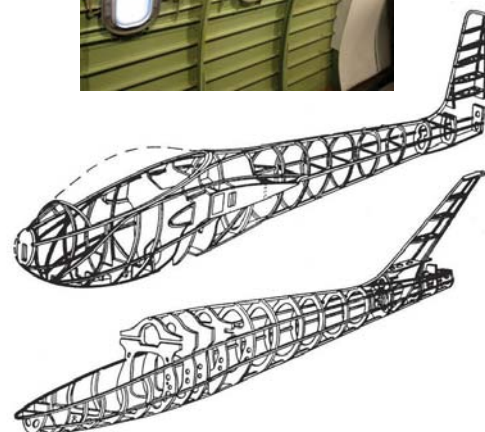

It is a reticulated structure based on the minimum length lines over a curved surface. Therefore, every tensile stress that tends to flatten the surface is balanced by a compression stress. Since the elements are interconnected, the structure is balanced in every intersection: the torsional load on each one cancels out that on the other: the longitudinal elements will be subject to tensile stresses whereas the transversal ones will work under compression stress.

If a load is applied on the rectangle ABCD, AC will be under compression. This will increase its curvature, but at the same time a tensile stress will appear on BD, which will try to straighten AC.

Since AC and BD are joined at their center, both forces are opposed to each other and the loads are annulled: the balance is achieved.

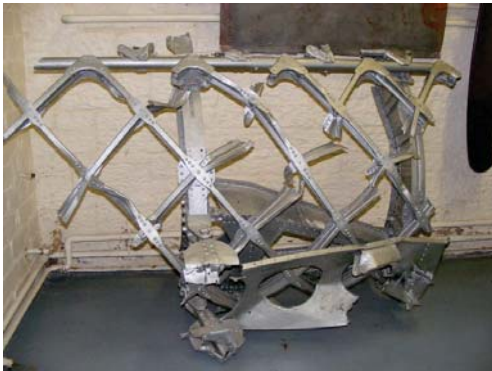
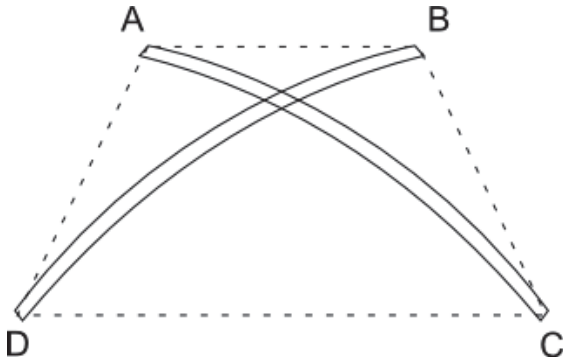

The geodesic structure made it possible to obtain the maximum structural strength with the minimum weight possible.

Problem: very slow to be built

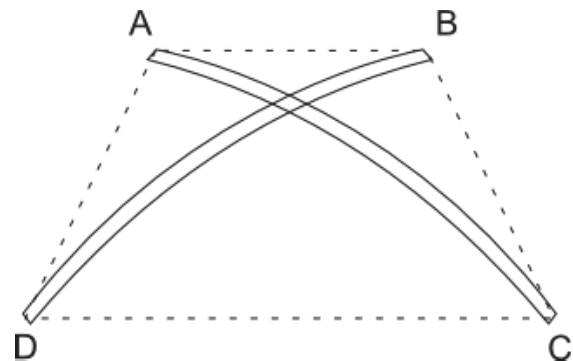
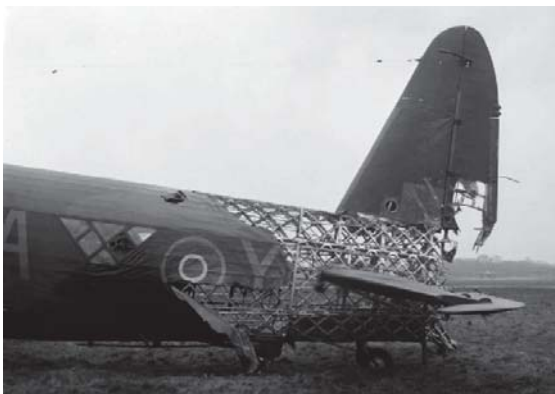

➤ Reticulated fuselages of non-resistant covering:

The shell does not work with the structure in order to resist the loads acting on the fuselage. There are two main solutions: Pratt and Warren

In both cases, the structure must consist at least of four main longerons, that usually extend all over the fuselage.

➤ Pratt Structure

The four longerons are interconnected by vertical and diagonal elements. The diagonal ones only work under tensile stresses and they are called truts.

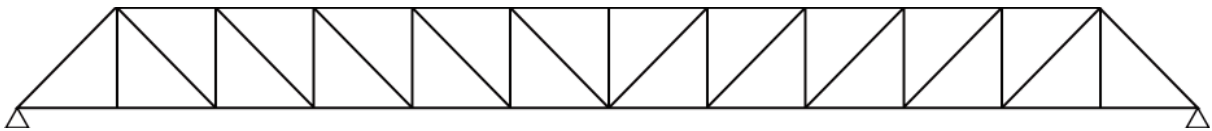

➤ Warren Structure

It is stiffer than the Pratt one. Its main characteristics are that it prescind from the elements incapable of working under compression and it is very good under torsion stresses.

The four main longerons are interconnected only by diagonal elements, which are able to work under both tensile and compression stresses. Therefore, the previous struts are replaced by tubes. Under a certain load, some elements are subject to tensile stress and the others to compression stress. If the load is inverted, the role of the elements is inverted too.

Usually the longerons and the diagonal elements are welded tubes made of chrome molybdenum steel. In some cases they are bolted profiles of steel or light alloys.

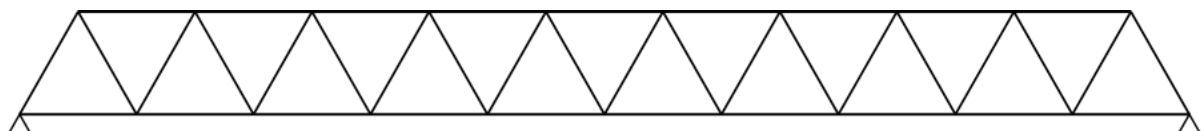

When pressurization is included (to maintain a constant pressure inside the fuselage that allows the passengers and the crew to operate normally without affecting their vital functions), an extra load appears on the fuselage: the internal overpressure. Thus, the fuselage starts behaving as a pressure vessel. Even when the pressure difference is low, the resulting forces are very high since the affected area is also very high.

Concentrated tangential forces appear on the frames. They are added to the bending stress acting on the skin and tend to deform the surface, which makes it lose its aerodynamic shape.

In order to solve this problem, “floating” shells are used, so that the unions between frames and shells preserve their shear resistance. Therefore, the shell can expand uniformly under the action of the internal pressure. In the pressurized fuselages special attention must be given to:

- a) Seal fatigue due to the pressure fluctuation.
- b) Air bleed valves.
- c) Door openings, closures, fasteners and covers.
- d) The pressure on the windows glass.
- e) Structure free of failure in order to avoid decompression.

➤ Pressurized aircraft

The inner pressure is higher than the outer pressure. Thus, the fuselage expands as if it were a balloon. Its structure, with frames and longerons, together with the shell metal, is the only thing that prevents the fuselage from collapsing.

The windows of the passenger cabin consist of several layers of glass. However, they are still the weakest point of the airplane structure, and that is the reason why the designers try to keep them as small as possible. In addition, any discontinuity in a metallic surface is a possible origin of corrosion. Therefore, if the window perimeter is reduced, the potential corrosion zone is reduced.

➤ Non-pressurized aircraft

The problem of the structural resistance is less important: the fuselage does not need to bear the pressure difference. Thus, bigger windows can be installed. In fact, some models have been modified in order to further enlarge them.

With regards to the windows of the pilot cabin, they are regulated by the aeronautical authorities, which demand a minimum viewing angle outside the plane. In addition, in some cases they demand that some windows can be opened and used as an emergency exit for the pilots.

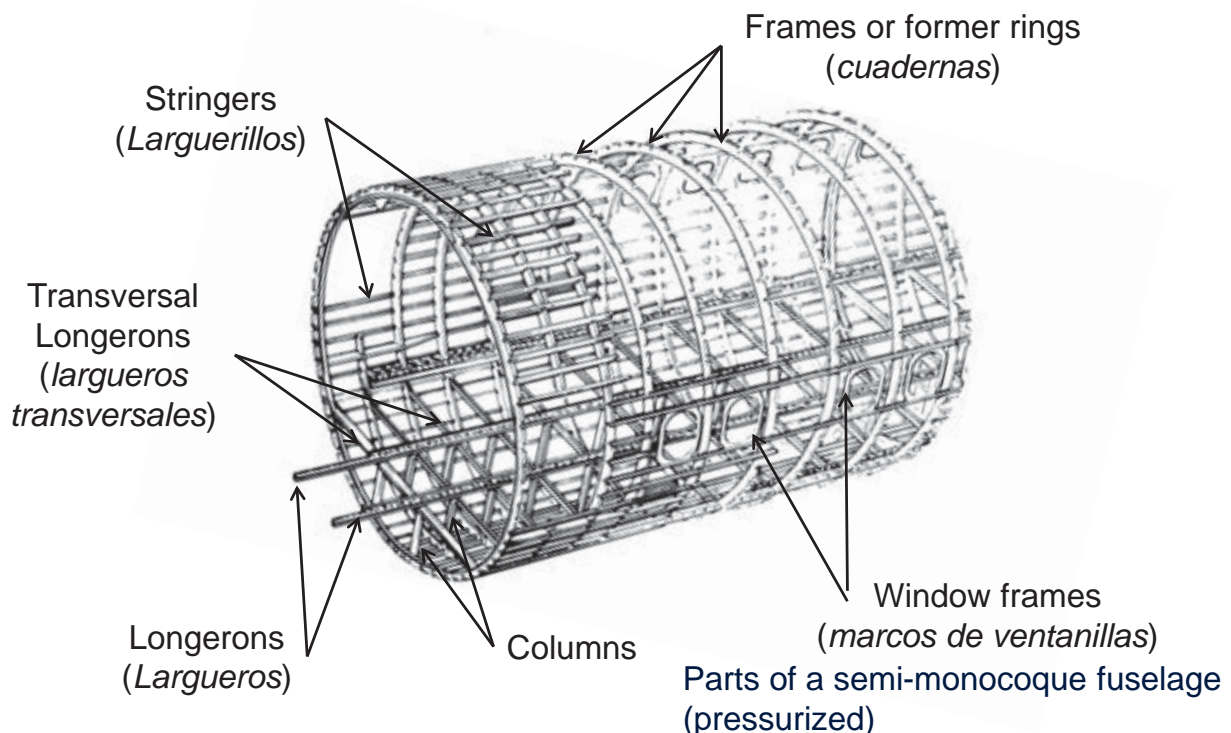

➤ Semi-monocoque typical structure

It is a resistant thin-walled tube made of aluminum alloys, stiffened transversally via frames and bulkheads and stiffened longitudinally via stringers and longerons.

- **Frames (cuadernas):** transversal structural elements that give its circular shape to the section and prevent the instability of the stringers.
- **Stringers (larguerillos):** longitudinal structural elements. They bear tensile and compression stresses and distribute the bending loads, but they principally prevent the shell from buckling.
- **Longerons (largueros):** bigger longitudinal elements that bear bending stresses and distribute axial loads. They do not always exist.
- **Skin (revestimiento):** bears most of the tensile, compression and torsion stresses. Due to its strong curvature it bears the compression and shear stresses better than the wings. It keeps the cabin pressure.
- **Pressure bulkheads (mamparos de presión):** they close the cylinder in its forward and aft sections, ensuring the pressurization. They have a skullcap shape where possible.
- **Flat bulkheads (mamparos de división):** Structural planes in stress concentration zones (engine pylons, landing gear, wings, tail surfaces...)

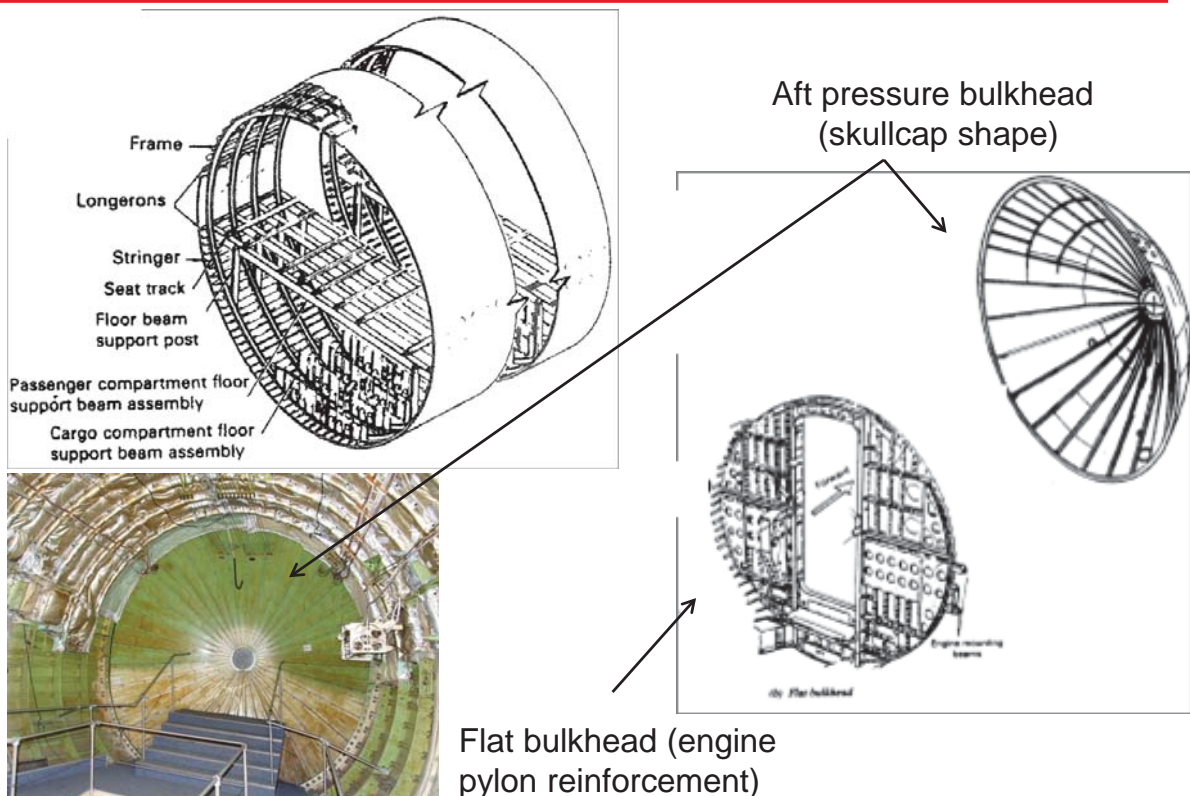

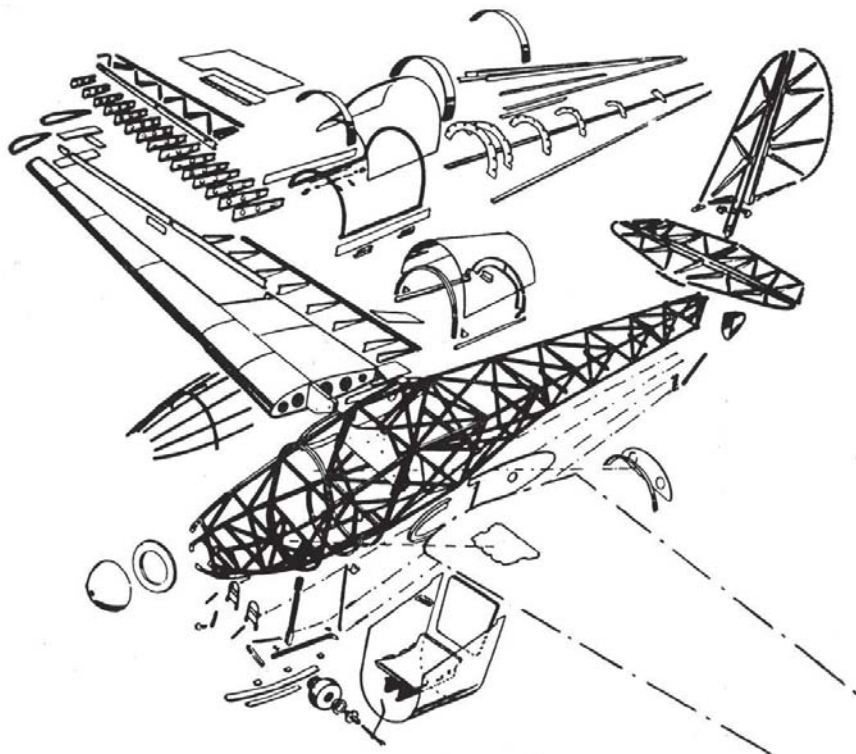
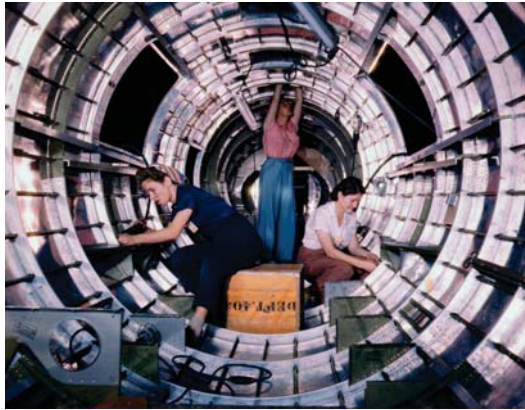
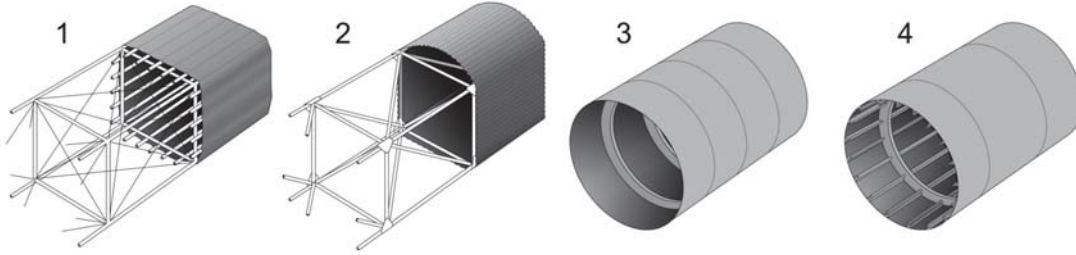

CAC CA-6 Wackett

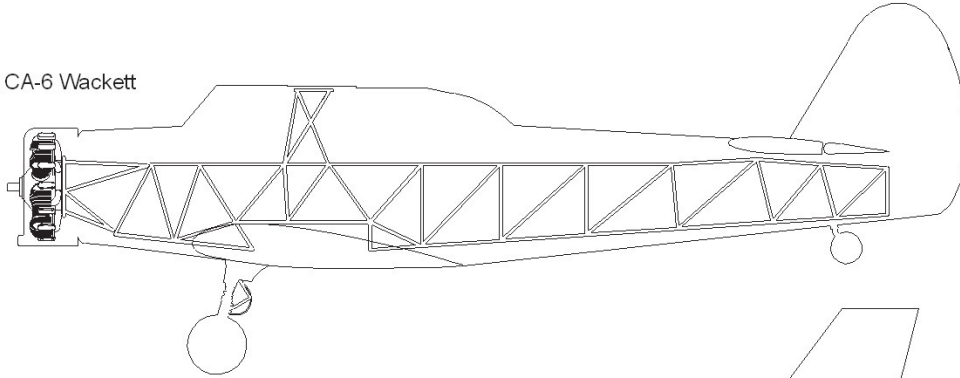
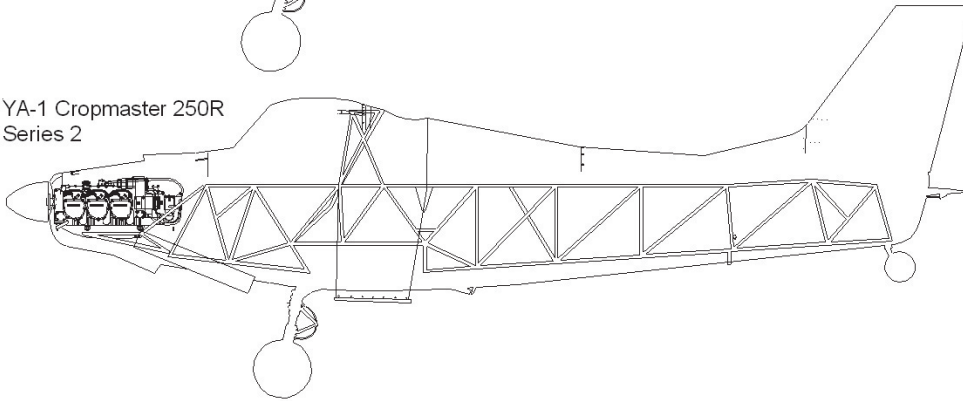
YA-1 Cropmaster 250R
Series 2

Piper PA-18



- **Depending on the function of each component, it can be classified as main or secondary.**

Main components

- Spars (largueros)
- Ribs (costillas)
- Skin (revestimiento)
- Fittings (herrajes)

Secondary components

- False ribs
- Stringers (larguerillos)
- Reinforcements (refuerzos)

- **Spars (largueros):** Beams that extend along the wing. They are the main support component of the structure. They bear the bending and torsion stresses.
- **Ribs (costillas):** Transversal stiffening elements. They give shape to the airfoil and transmit the loads on the skin to the spars.
- **Skin (revestimiento):** Its function is to give the aerodynamic shape to the wing and keep it along the wingspan. It can also contribute to its structural resistance.
- **Fittings (herrajes):** Metal components used to join certain sections of the wing. The wing structural resistance depends highly on their calculation. They bear stresses, vibrations and deflections.
- **Stringers (larguerillos):** Longitudinal members of the wings that transmit the load from the skin to the ribs.
- **Web (placa o alma):** Thin plate that, together with reinforcements, supplies a great resistance to shear.

- The function of the wing is to provide lift and bear loads. Thus, its shape and structure must behave as a beam able to resist stresses. Some of these stresses are due to:

Aerodynamic loads (lift and drag).

Loads due to the engine thrust.

Reaction force due to the landing gear.

Stresses due to the deflection of the high lift devices.

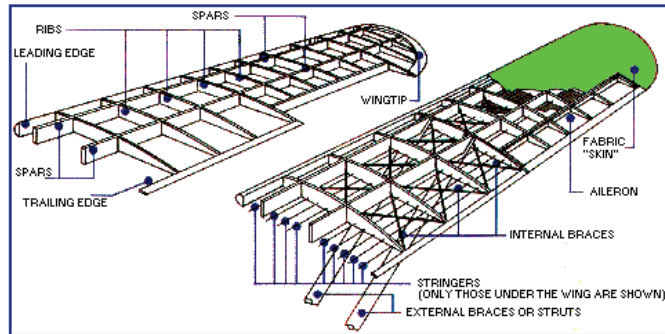
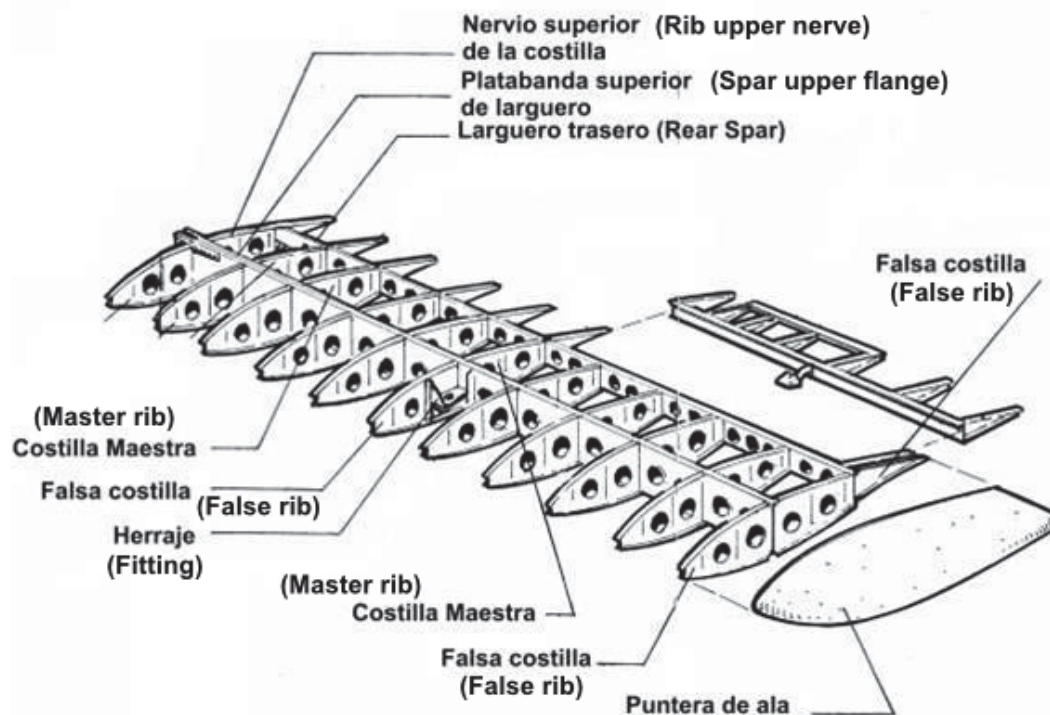

Figure 1-5 Wood-and-fabric-type wing structure



➤ Spars

The forces beared by the wing vary along its span. Thus, the spars can have a variable section along the wingspan, reducing the structural weight.

The shape of the transversal section of the spar depends on the airfoil shape, its height, the resistance demanded and the material employed.

- **Rectangular section:** It is solid, economic and simple.
- **I Section:** It possesses an upper and a lower flange joined by the web.
- **C section:** It bears the stresses better than the rectangular section. However, it is unstable to shear loads. It is only used as an auxiliar spar.
- **Double T section:** It has a good resistance to bending stresses and it is light.
- **Composed I Section:** The upper and lower flanges are made of the same material, whereas the web is made of a different material and it is joined to the flanges by means of riveting.



➤ Frame Spars (Largueros de armadura)

The two flanges are joined through vertical and/or diagonal elements that can be riveted, screwed or welded. These elements constitute the spar web.

➤ Filled Web Spars (Largueros de alma llena)

The flanges are joined through a plate that constitutes the web. If it is very high, it must include vertical reinforcements in order to increase the plate stability.

Several holes are normally made to the web to reduce its weight, make it easier to access the wing for maintenance tasks and to pass wires and pipes through it.

The holes must allow a closed hand to pass through them. Thus, their diameter must not be lower than 120 mm.

During normal flight, the upper flange works under compression stresses, whereas the inner one works under thensile stresses and the web under shear stresses.

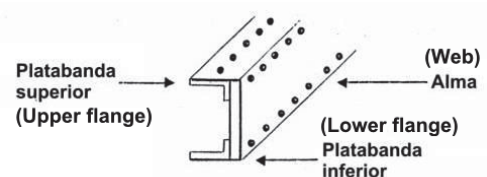
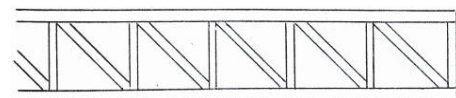

➤ Ribs (Costillas)

Their functions are:

1. To keep the airfoil shape.
2. To transmit the aerodynamic forces to the spars.
3. To distribute the loads to the spars.
4. To stabilize the wing against the stresses.
5. To close the wing cells.
6. To keep the separation between spars.
7. To provide joining points for other components (landing gear).
8. To create barriers in the fuel tanks.

➤ Ribs (Costillas)

Classification depending on their function

- **Compression ribs:** They join the spars. They transmit and distribute the stresses on the spars. They are placed where local stresses are produced. They are not necessarily distributed in a perpendicular way, they can also be placed diagonally.
- **Master ribs:** They keep the distance between the spars and give stiffness to the elements.
- **Common ribs:** They are not as strong. Their duty is to keep the airfoil shape and transmit the inner forces to the spars, distributing these forces in different parts of the spars.
- **False ribs:** They only keep the skin shape. They are placed between the spar and the leading edge and also between the spar and the trailing edge.

➤ Rib parts

- Upper nerve (Nervio superior)
- Lower nerve (Nervio inferior)
- Web (Alma). If it is made of metal it uses to be manufactured by pressing (prensado): it provides stiffness against vertical and diagonal deformations.

➤ Rib location

They are perpendicular to the spars. The separation between them depends on the following factors:

- A) Aircraft speed
- B) Wing load
- C) Rib manufacturing
- D) Covering
- E) Airfoil shape

➤ Coating/skin (Revestimiento)

The skin or coating provides an aerodynamic shape to the wing in order to achieve the best performance. It is part of the wing and there are two kinds of coating:

- Non resistant or Passive (cloth)
- Resistant or Active (metallic)

➤ Resistant or Active Coating

It helps to bear the tensile, compressive, bending, torsion and shear stresses. Thus, it contributes to the structural resistance and makes it possible to remove some reinforcement pieces, obtaining stronger and lighter structures.

The contribution of the coating to the bending resistance of the wing depends on its wrinkling level and its elastic modulus (the property of the bodies to recover their original shape when the external forces responsible for its deformation disappear).

The tensile stresses do not offer more difficulties no matter how thin the plates are. In order to resist compression stresses, the plates are reinforced via Y or Z profiles or with corrugated sheets fixed to their lower part. The shear stresses are resisted without deformations if the plate is thick enough.

The coating is fixed to the wing structure by riveting. The rivets must be sunk head rivets (remaches de cabeza hundida) in order to add the minimum drag.

Aircraft

3. Fundamentals of flight

Airfoil theory, Airfoil definition, Wing Types, Wing main characteristics

- Introduction to the aerodynamic airfoil
- Definition of lift and drag over an airfoil
- Airfoil characterization
- High lift devices
- Wing (definition and parameters)
- Aerodynamic elements in wings

➤ **Lift and drag of an aerodynamic body**

The drag is the force that opposes the advance of a body within a liquid or gas stream. This force can be reduced depending on the geometry of the body. The lesser the perturbation the body generates on the fluid, the lesser the opposition to the body advance will be.

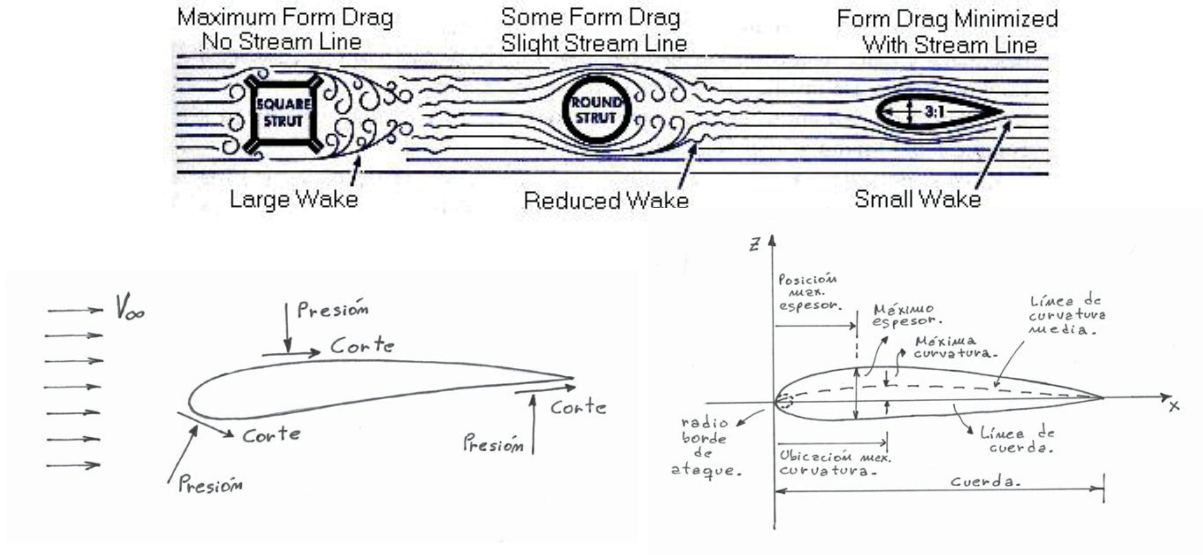

➤ **Definition of an airfoil's geometry**

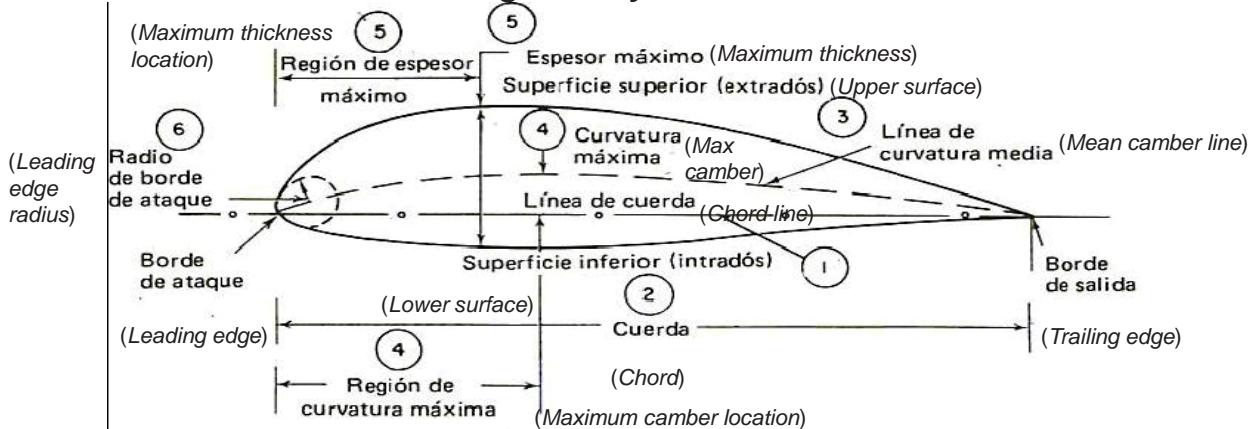

The geometry of an airfoil can be defined through four main variables:

- 1. **Configuration of the mean camber line.** If this line coincides with the chord line, the airfoil is symmetric. In symmetric airfoils, the upper and lower surfaces have the same shape and their distance to the chord line is identical.
- 2. **Thickness.**
- 3. **Location of the maximum thickness.**
- 4. **Leading edge radius.**

➤ Airfoil's definition

Most of the **airfoil development in the USA was performed from 1929** by NACA (*National Advisory Committee for Aeronautics*), which was the **precursor** of the **NASA** (*National Aeronautics and Space Administration*). Their airfoils are defined by a series of numbers that describe their geometry.

The first series studied were called "**4-digit**". The first digit gives the maximum camber as a percentage of the chord; the second one shows the distance of the maximum camber from the leading edge in tens of the chord, and the two last digits give the maximum thickness as a percentage of the chord.

Further development brought the "**five-digit series**" and the "**1-series**". With the **arrival of the high velocities, the "6-series and 7-series" were defined**. They are the result of a displacement of the maximum thickness point towards the rear part of the airfoil and a reduction of the leading edge radius. Two main results are obtained from this design. First, the minimum pressure point is displaced towards the trailing edge, increasing the distance from the leading edge in which there is laminar flow and thus reducing drag. Second, the Mach's critical number increases, making it possible for the aircraft to reach higher velocities without the appearance of compressibility problems.

In the "**6-series**", the first digit shows the series (it is always a 6), the second one the position of the minimum pressure area in tens of the chord, the third one represents the design lift coefficient in tens and the two last digits give the maximum thickness as a percentage of the chord.

➤ Airfoil's definition

NACA 4-digit Series

- They are based in geometric criteria: with the digits of the maximum camber, X_{cmax} , and the maximum thickness, t , respectively.
- The four digits define:
 - The first digit has a geometric sense and it indicates the maximum camber (C_{max}) as a percentage (%) of the chord, thus providing the maximum camber.
 - The second digit bears a geometric sense too, and it shows its position, i.e., the distance from the leading edge to the position of the maximum camber X_{cmax} , in tens of the chord.
 - The two last digits indicate the maximum relative thickness as a percentage (%) of the chord.
- The airfoil is obtained via two tangent parabolas in the point of maximum camber.
- Examples: NACA 0015, NACA 2412

➤ Airfoil's definition

The **NACA 5-digit** series describes much more complex airfoils:

- 1st digit: 20/3 of the ideal (or design) lift coefficient (C_{li}). In other words, when the 1st digit is multiplied by 0.15, it gives the airfoil lift coefficient.
- 2nd and 3rd digits: they designate the double of the position of the maximum camber from the leading edge, as a % of the chord.
- 4th and 5th digits: maximum thickness as a % of the chord.

• NACA 12345 Airfoil

- Lift coefficient $C_l = 0.15$ (because $0.15/0.15 = 1$).
- Maximum camber position $0.115 c$ from the leading edge ($0.23/2 = 0.115$)
- Maximum thickness = $0.45 c$
 - »The airfoil 12345 is just an example. Due to the fact that most “5-digit” series airfoils present a default position of 15% of the chord for the maximum camber, most of them are X30YY.
 - »X will be $X \cdot 0.15 = \text{max lift coefficient of the airfoil}$.
 - »YY will be the maximum distance between the upper and the lower surfaces as % of the chord

➤ Airfoil's definition

Different airfoils depending on their family

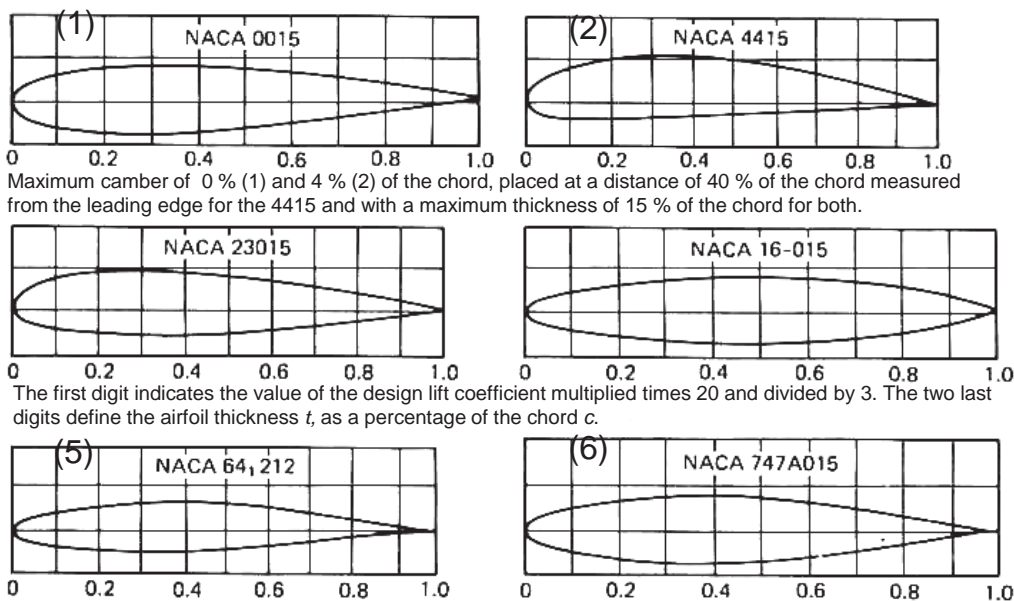

–Perfiles NACA (datos NACA).

The first digit indicates the series and the second one the position of the minimum pressure in tens of the chord. The third digit represents the lift coefficient (in tens) and the two last digits define the maximum thickness as a percentage of the chord.

PERFIL SIMÉTRICO. ÁNGULO DE ATAQUE POSITIVO



Circulation of a fluid around a cylinder. The movement of the cylinder generates a variation in the streamlines around the airfoil (chord = thickness). This variation implies a different behavior of the local pressure in the upper and lower parts of the cylinder.

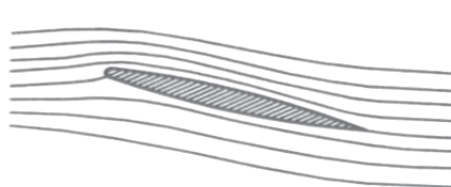

Streamlines around an airfoil (their behavior is translated into pressure forces around it)

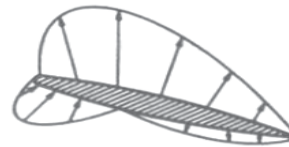

Scheme of the pressure behavior

The continuous variation of the airfoil angle with respect to the streamlines enhances the phenomenon of deviation of the streamlines around the airfoil, thus increasing the pressure difference between the lower and higher surfaces.

Therefore, **the resulting force of this pressure difference, the lift**, varies with the airfoil operation. The streamlines vary with the angle in which the airfoil faces them. But this effect also implies an increase in drag, induced by the eddies that are generated by **the detachment of the streamlines over the surface, boundary layer**. The pressure distributions in both airfoil faces are modified originating different lift levels, but there is also a change of the streamlines that increases the drag when the angle of attack is increased.

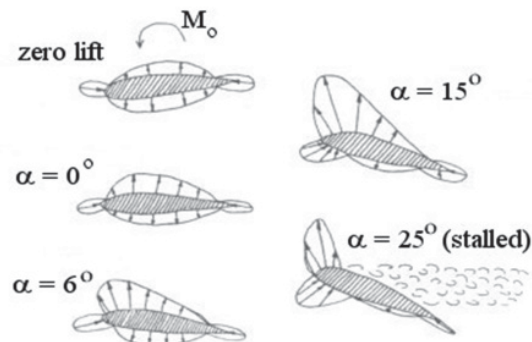
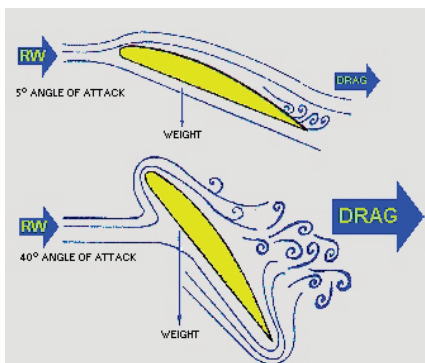

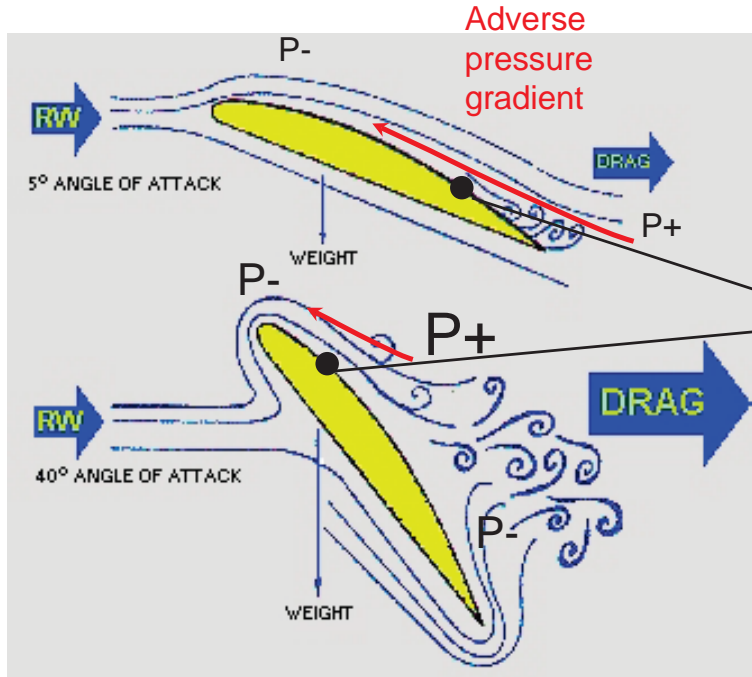

Adverse pressure gradient

Evolution of the deattachment point (due to the action of the adverse pressure gradient that moves towards the leading edge) with the angle of attack

➤ Behavior of the center of pressure

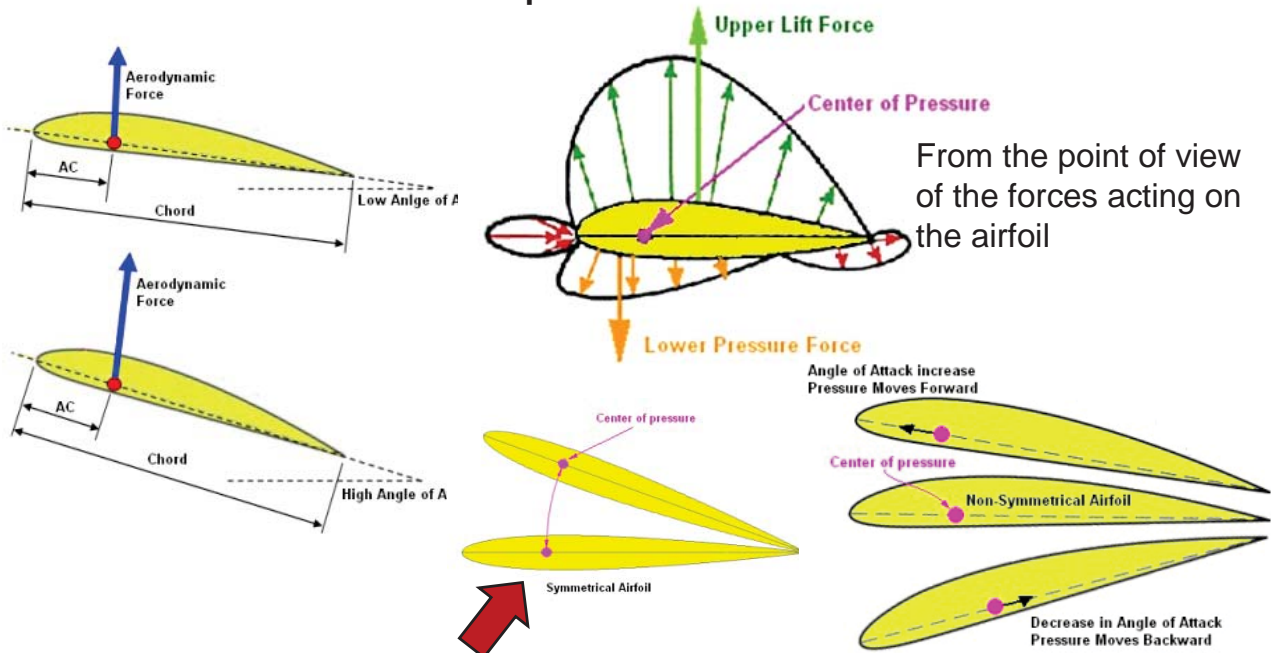

From the point of view of the forces acting on the airfoil

Watch out!! In a symmetrical airfoil the center of pressure does not change

Due to the lift production, there is an operational point which leads to a maximum of that force. In terms of lift coefficient C_L , it is defined as the maximum lift coefficient of the airfoil.

$C_{L_{max}}$ depends on several factors, the most important one being the viscosity phenomenon. Increasing the angle of attack leads to detachments of the flow over the airfoil. This detachment depends on the angle of attack itself and the airfoil geometry. If a 3D wing is considered, it also depends on the aspect ratio, the thickness of each section and the different airfoils that might shape it. (taper ratio and sweep)

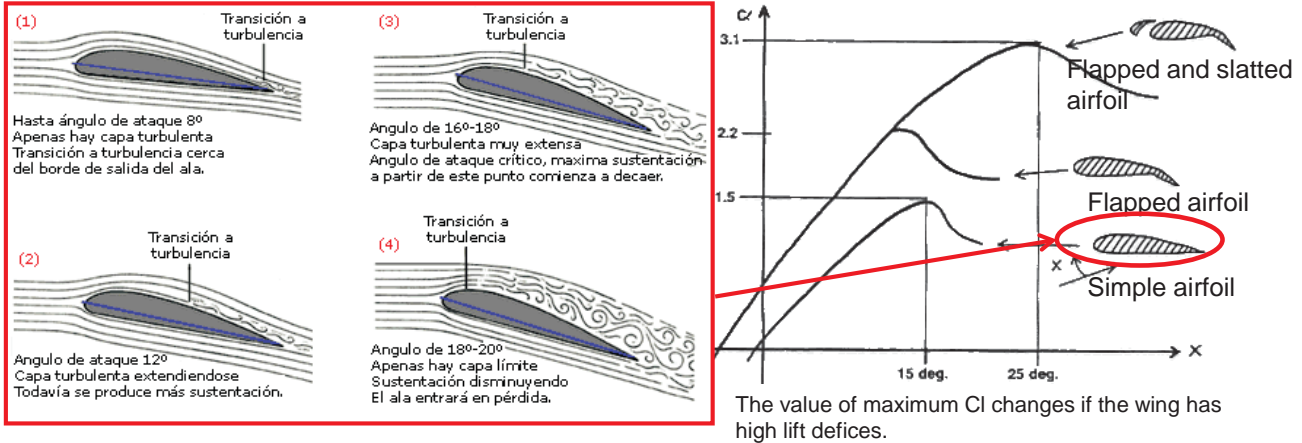

The value of maximum C_L changes if the wing has high lift devices.

➤ Increase in drag due to compressibility effects

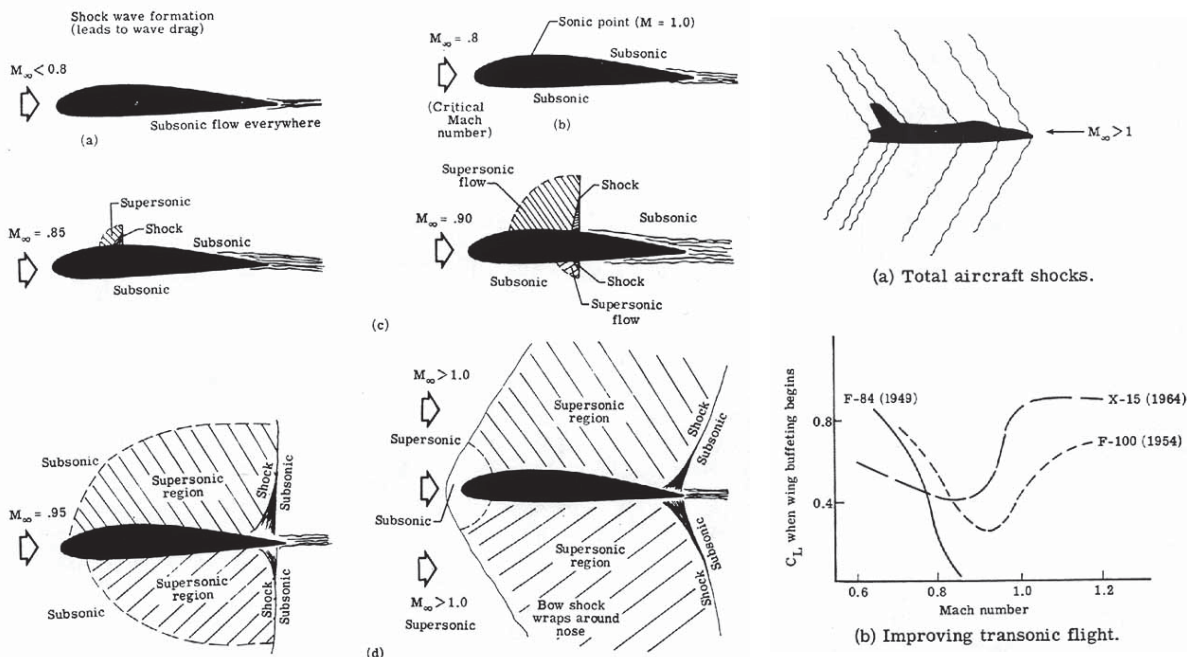

➤ Adaptation of the airfoil geometry to the compressibility effects

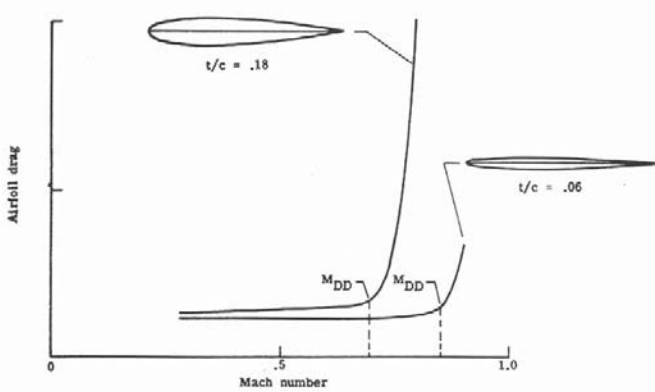

The critical Mach number for an airfoil with a high t/c ratio is lower than that of a low t/c ratio. The critical Mach number is defined as the Mach number where a huge increase in drag occurs. From this point, the drag grows exponentially. These slides give some charts to define its value depending on the wing geometry that is imposed.

In order to improve the value of the critical Mach number, and trying to reach sonic conditions (even though this is difficult for the time being, Mach 0.98), the designers decrease their t/c ratio, and a small camber is generated in order to stabilize the turbulent boundary layer in the trailing edge, thus forcing the generated shock wave to have weak energies and a small influence on the airfoil performance.

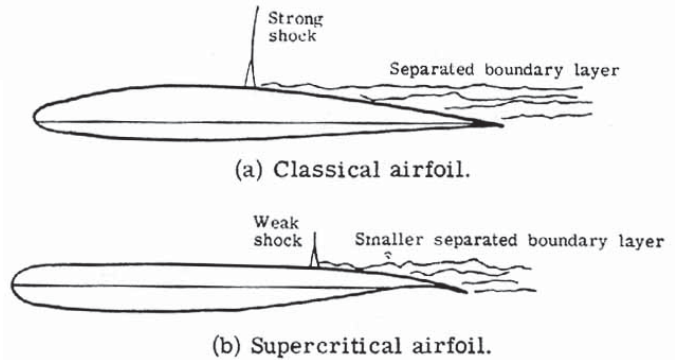

➤ Adaptation of the airfoil geometry to the compressibility effects

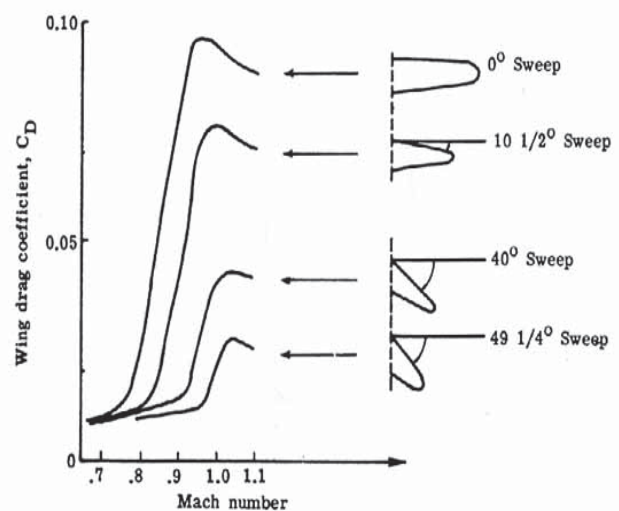
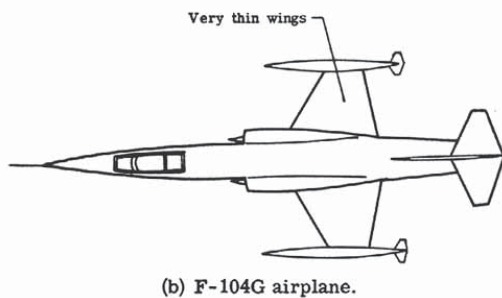
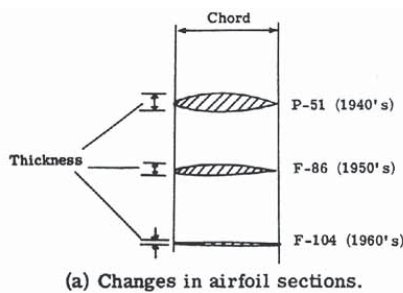

t/c ratio, it is reduced as the cruise speed approaches or surpasses the speed of sound.

The wings are adapted as the airfoils in order to generate lift in conditions of extreme compressibility. The sweep angle is increased as we reach higher speeds. After surpassing the sound barrier, these must be inside the so-called Mach cone.

➤ Aircraft of the previous chart

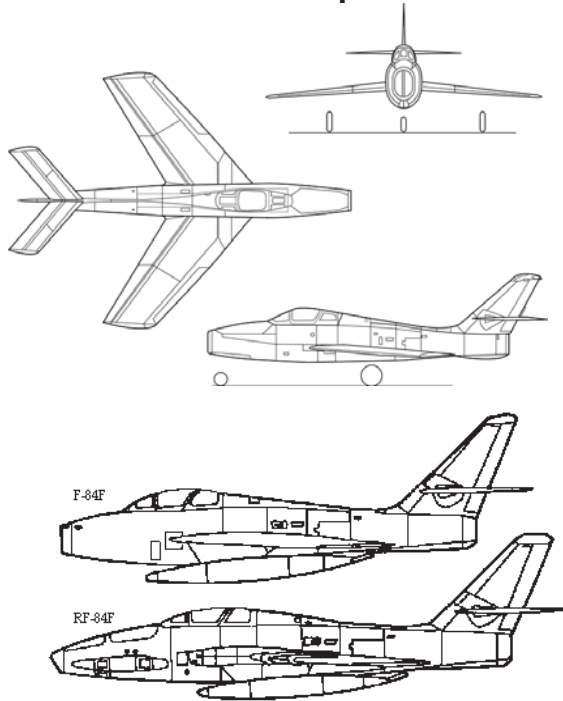

Republic F-84

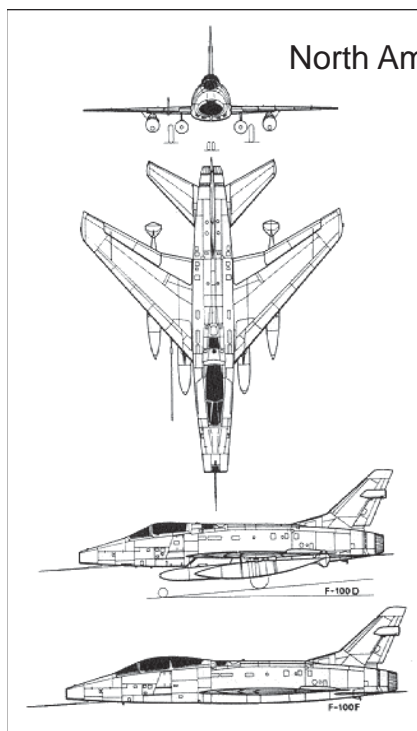

North American F-100



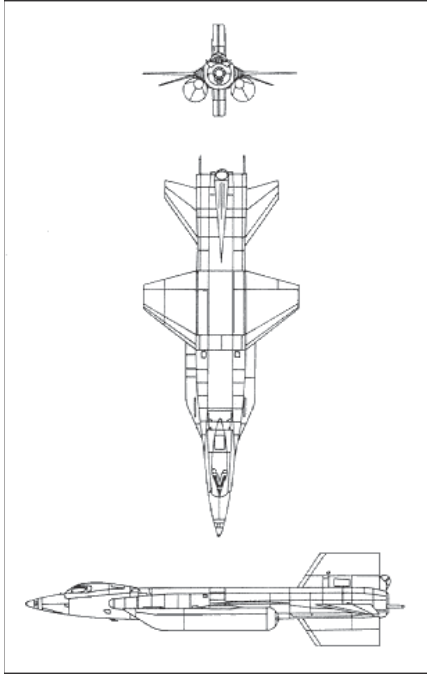

North American X-15



<http://airvoila.com/el-north-american-x-15/>

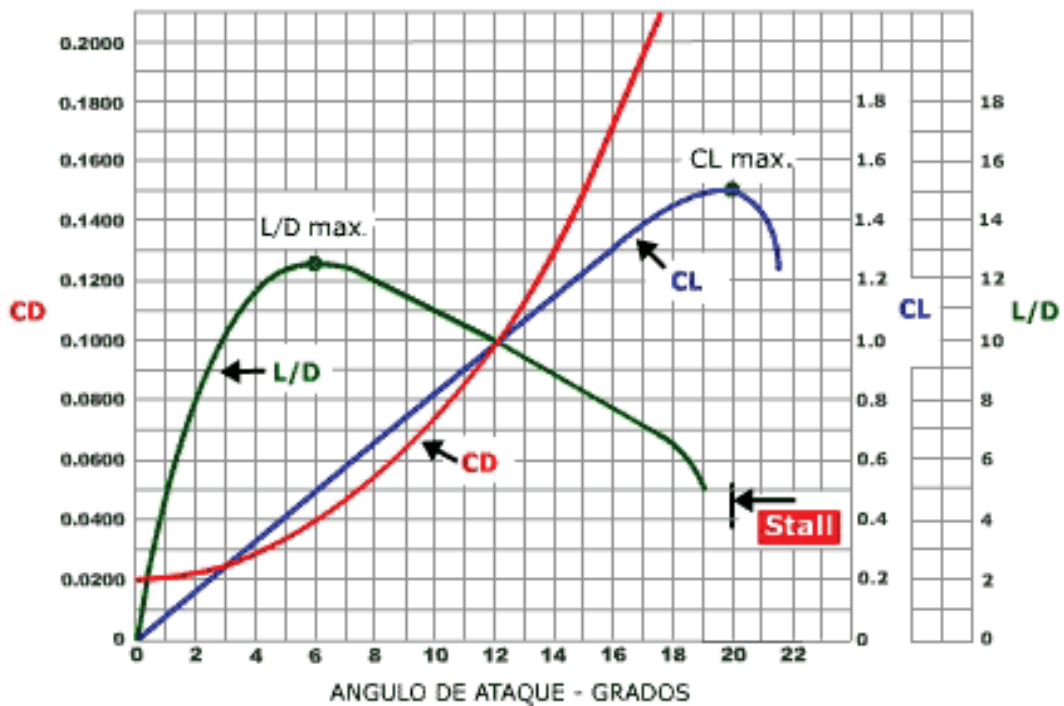

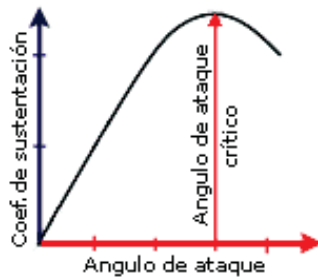

Critical angle of attack:

It is the value of the angle of attack from which the lift starts to decrease due to the separation of the streamlines. Beyond this point there is a quick transition to the total loss of lift, since the rapid growth of the adverse pressure gradient.

$$L = \frac{1}{2} \rho V^2 S c_L$$

L = lift

$\frac{1}{2} \rho V^2$ = dynamic pressure

S = wing surface

c_L = lift coefficient

➤ Drag and Polar of the aircraft

The drag coefficient depends on several factors to be taken into account: lift coefficient, Mach number, Reynolds number, configuration, etc.

The polar of the aircraft is defined by a parabolic curve which has three important parameters to be determined: C_{d0} , C_d and C_l .

These three parameters are defined by the aircraft shape, its wings shape, the airfoil choice, etc.

C_{lmax} is around 1.5 (order of magnitude). Higher values are not considered unless high lift devices are included. Negative values do not make sense (draw C_l vs C_d curve)

C_l can be defined as:

$$c_L = \frac{W}{\frac{1}{2} \rho V^2 S}$$

$$c_L = \frac{W}{\frac{1}{2} \gamma P M^2 S}$$

➤ Polar of the aircraft

The drag depends on:

- **Pressure (D'Alembert's paradox):** Due to the effect of the eddies, the low pressure tends to “suck” or “hold” the aircraft; boundary layer (laminar or turbulent)
- **Friction:** higher in turbulent conditions, as the flow “sticks” more to the aircraft skin.
- **Induced:** It consists of two terms; Roskam uses only one.
- **Parasitic:** friction without taking into account the one provoked by the presence of eddies.
- **Wave:** close to supersonic velocities.
- **Interference:** due to the presence of an element close to another one over the fuselage.
- **Base:** it usually happens at the fuselage tail cone due to the detachment of the boundary layer.

➤ Polar of the aircraft

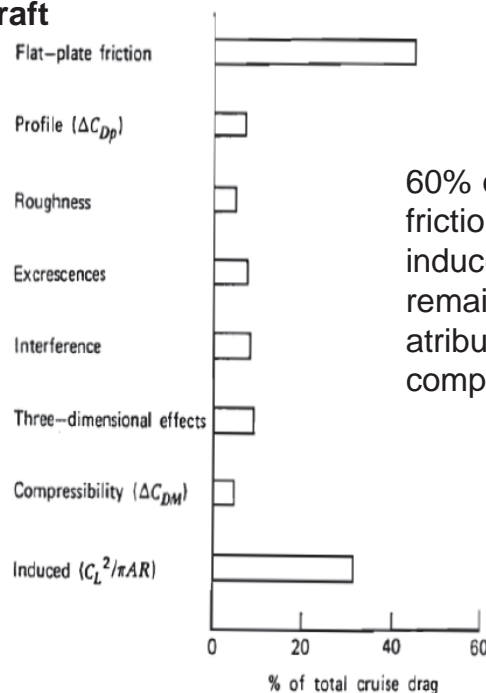

60% of the drag is caused by friction, whereas 35% will be induced drag and the remaining 5% can be attributed to the other components.

Typical drag buildup for jet transport.

➤ **Polar of the aircraft**

The friction drag (parasite drag) is known as the drag in which the lift is zero.

For uncambered wings, it is the drag minimum value.

Methods to estimate C_{D_0} :

1. Method of the equivalent friction surface.
2. Method of the flat plate coefficient.

The value of C_{D_0} depends on the elements of the aircraft and it has nothing to do with the lift. It includes the friction drag and the drag due to the shape of the components. For a better approach the interactions must also be taken into account.

➤ **Polar of the aircraft**

Flat plate analogy. Let us consider a flat plate of span b and chord c . With a 0° angle of attack it does not generate lift, but it generates drag. This can be evaluated as:

$$D = \frac{1}{2} \rho V^2 S_{wet} C_f \quad \text{where} \quad S_{wet} = 2bc$$

The friction coefficient C_f depends on the Reynolds number and the Mach number. Its value changes according to the flow regime (laminar or turbulent). Therefore, two expressions must be taken into account:

$$C_f = \frac{1.328}{\sqrt{Re}} \quad \text{and} \quad C_f = \frac{0.455}{(\log_{10} Re)^{2.58} (1 + 0.144M^2)^{0.65}} \quad \text{where} \quad Re = \frac{\rho Vc}{\mu}$$

It must also be taken into account that the rugosity of the surfaces also influence the Reynolds number. Therefore, the Reynolds number to be used in the equations must be the lowest of the two following values:

➤ **Polar of the aircraft**

- $$Re = \frac{\rho Vc}{\mu} \quad Re = \frac{Vc}{\nu}$$
1. The flight Reynolds number:
 2. A cutoff Reynolds number related to the viscosity of the flat plate, whose surface finish is not perfect. Thus, the Reynolds number is corrected by a commonly called surface rugosity factor which, for commercial aircraft, uses to take values around $20 \cdot 10^{-6}$ m. The cutoff Reynolds number also depends on the flight velocity.

Subsonic $Re_{cutoff} = 38.21 \left(\frac{c}{k} \right)^{1.053}$

Transonic or Supersonic $Re_{cutoff} = 44.62 \left(\frac{c}{k} \right)^{1.053} M^{1.16}$

Surface	k (ft)
Camouflage paint on aluminum	3.33×10^{-5}
Smooth paint	2.08×10^{-5}
Production sheet metal	1.33×10^{-5}
Polished sheet metal	0.50×10^{-5}
Smooth molded composite	0.17×10^{-5}

Airplane Configuration	C_f Range at Low Mach Numbers
Propeller driven, fixed gear	0.008–0.010
Propeller driven, retractable gear	0.0045–0.007
Jet propelled, engines pod-mounted	0.0035–0.0045
Jet propelled, engines internal	0.0030–0.0035

➤ **Polar of the aircraft**



Change in friction depending on the flow regime (laminar or turbulent)

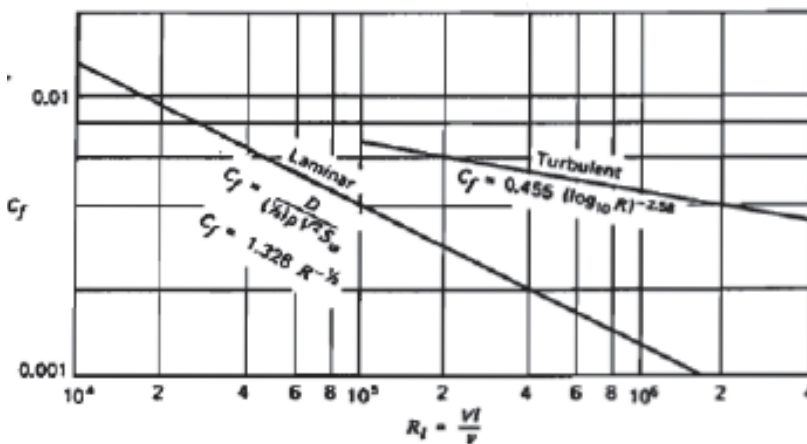

The friction coefficient decreases when the Reynolds number increases.

The friction coefficient for a commercial aircraft usually takes values around 0.003 and 0.004. These values become lower if the aircraft is bigger and flies at higher velocities.

➤ Polar of the aircraft

If the flat plate was given a volume, this would have a so-called shape factor (FF). Thus, the drag equation would be:

$$D = \frac{1}{2} \rho V^2 S_{wet} C_f FF$$

FF takes values from 1 to 1.35.

Now, if we want to obtain the drag of a whole aircraft, we must include the coefficients applicable to each component of the aircraft and define a reference surface in order to know how important the contribution of the component is.

Reference surface: the WING

The interference drag, determined by the factor FI, must also be added. This factor will take values very close to 1 unless some components are really close to the each other. Thus, the equation is

$$D = \frac{1}{2} \rho V^2 S_{wet} C_f FF \cdot FI$$

Summing the contribution of each surface will give the value of Cd0, together with the reference surface (the wing).

➤ Polar of the aircraft

Interference factor (FI)

- Nacelle FI=1.5
- Wing without nacelle FI=1.25
- Tails FI=1.02..

Miscellaneous drag

- External fuel tanks

Drag due to leaks & protuberances

- Antennas, doors, edges, fairings of the high lift devices, manufacturing deficiencies...

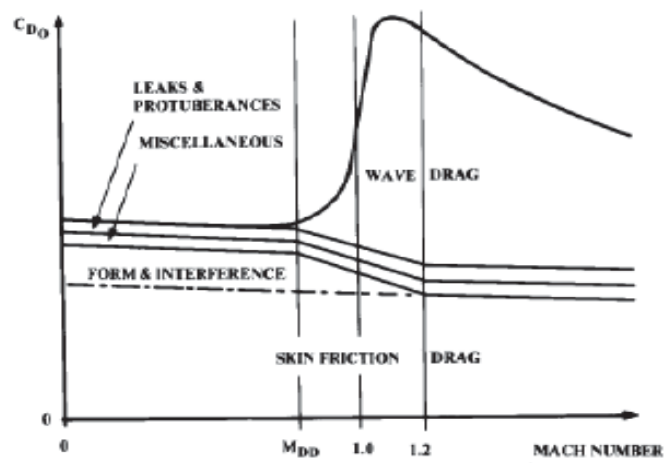

Fig. 12.30 Complete parasite drag vs Mach number.

➤ Polar of the aircraft

Ways to estimate Cd0:

$$FF = \left(1 + \frac{60}{f^3} + \frac{f}{400} \right) \quad \text{Fuselage and cabin} \quad f = \frac{l}{d} = \frac{l}{\sqrt{(4/\pi) A_{\max}}}$$

$$FF = \left[1 + \frac{0.6}{(x/c)_m} \left(\frac{t}{c} \right) + 100 \left(\frac{t}{c} \right)^4 \right] \left[1.34 M^{0.18} (\cos \Lambda_m)^{0.28} \right] \quad \text{Wing, stabilizer and tail}$$

(where x is the maximum thickness)

$$FF = 1 + \frac{0.35}{f} \quad \text{Engine and external accessories}$$

$$(C_{D_0})_{\text{subsonic}} = \frac{\sum (C_{f_c} FF_c Q_c S_{wet_c})}{S_{ref}} + C_{D_{misc}} + C_{D_{L\&P}}$$

Final expression for Cd0 assuming FI = 1

➤ Polar of the aircraft

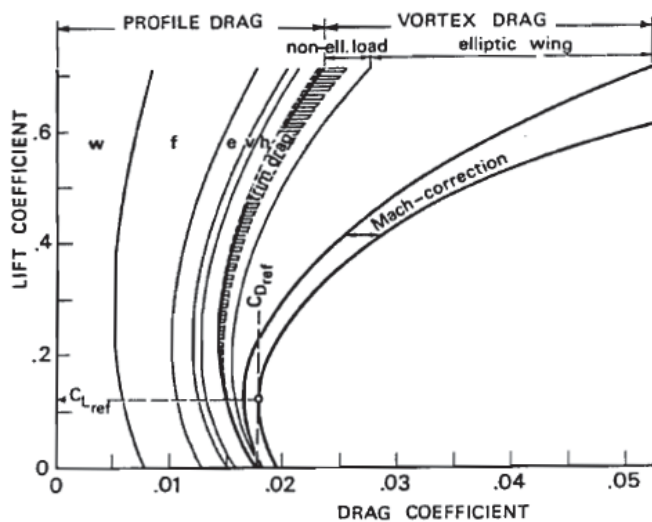

Breaking up the drag into the different components it can be seen that the summation generates a higher curvature of the polar.

Fig. 11-2. Drag buildup by analysis (w = wing; f = fuselage; e = engine installation; v = vertical tailplane; h = horizontal tailplane)

➤ Polar of the aircraft

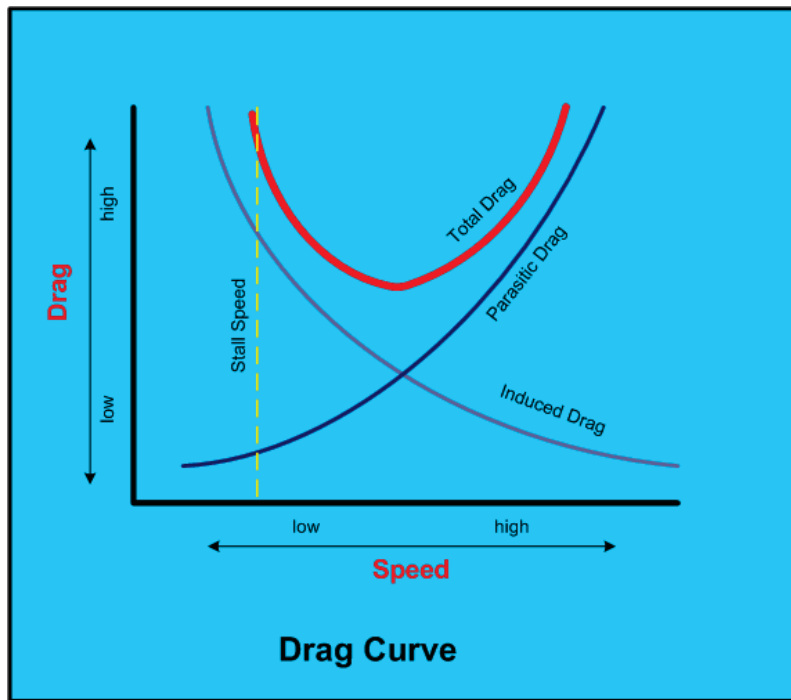

➤ Leading edge high lift devices

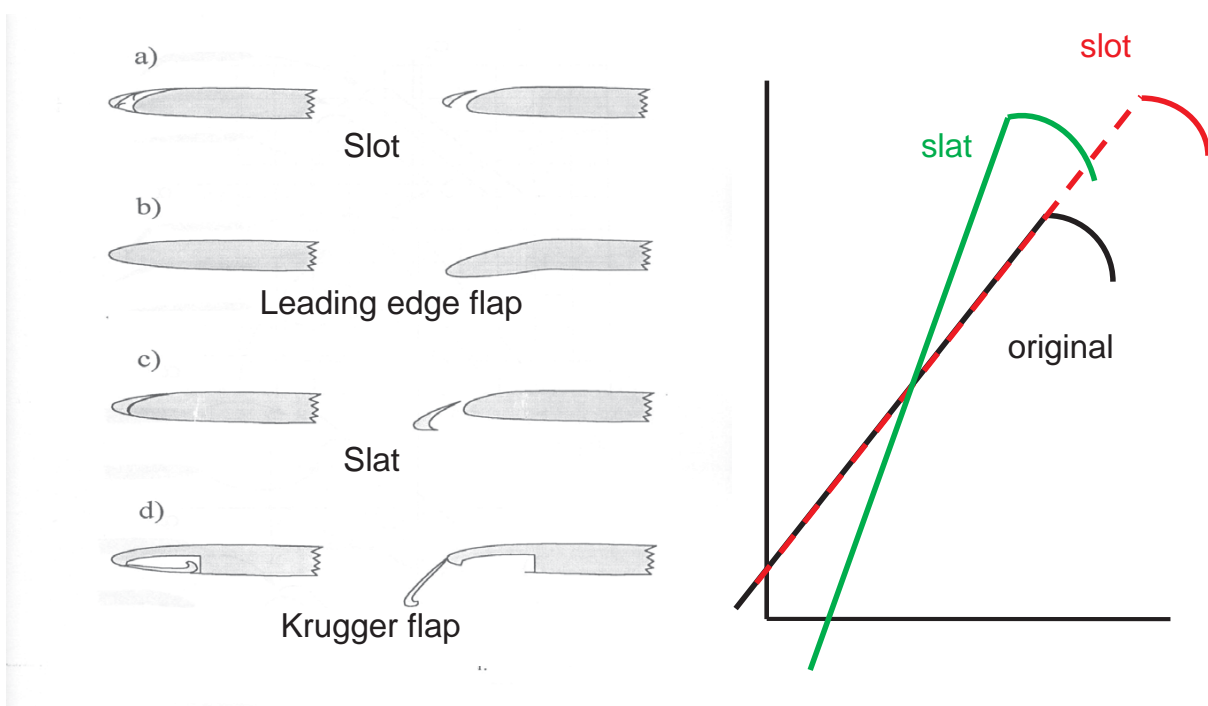

➤ Trailing edge high lift devices

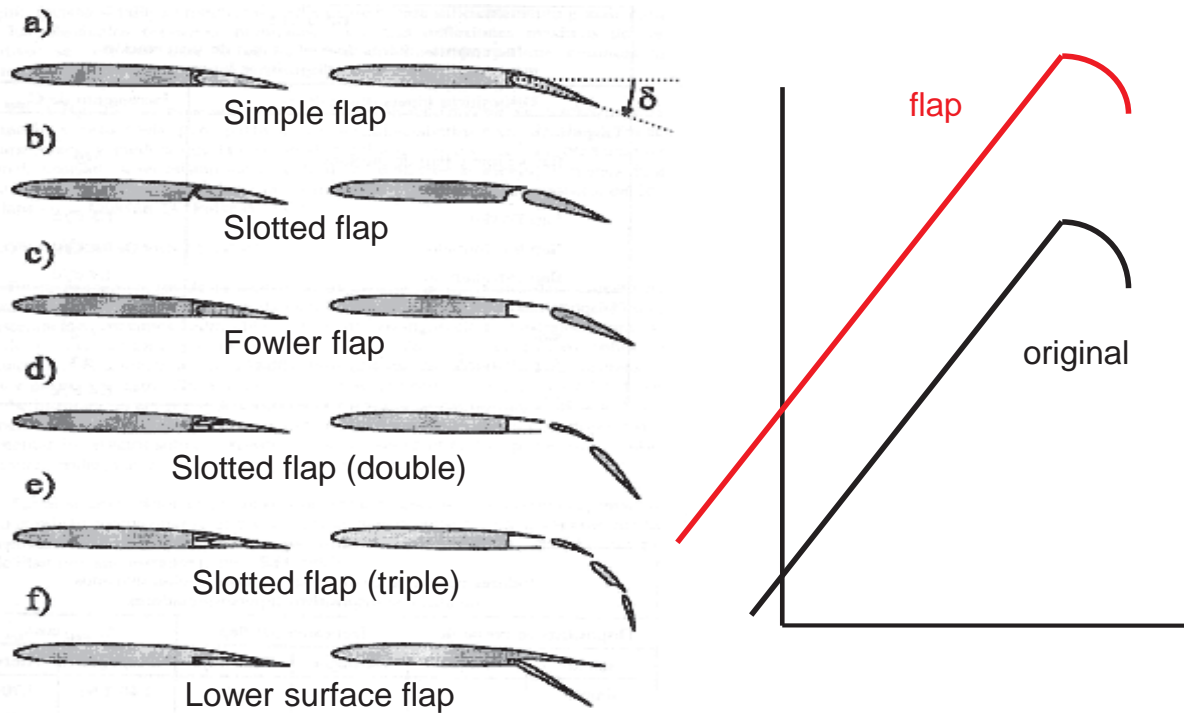

➤ Trailing edge high lift devices

Commercial aircraft actuators that make it possible for the flap to descend. They are commonly hydraulic, but there are also some pulley-driven.

Flap Geometry

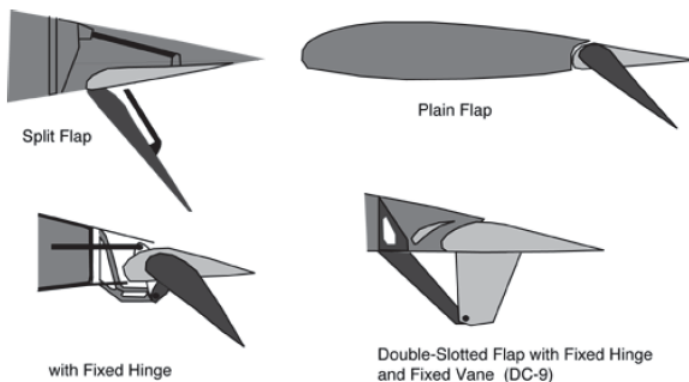

737 wing with a double flap, not totally extended



Operation of the device that activates the flap depending on its class

➤ Trailing edge high lift devices

Hydraulic mechanism of a double-slotted flap with a slide mechanism (a wheel where the flap arm and the bar that joins it to the wing are articulated). The system belongs to a DC-9, father of the MD-80, 82, 83, 87 and 88 and Boeing 717 families.

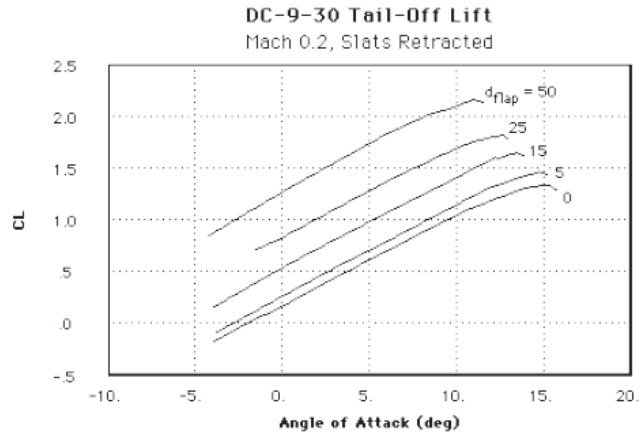
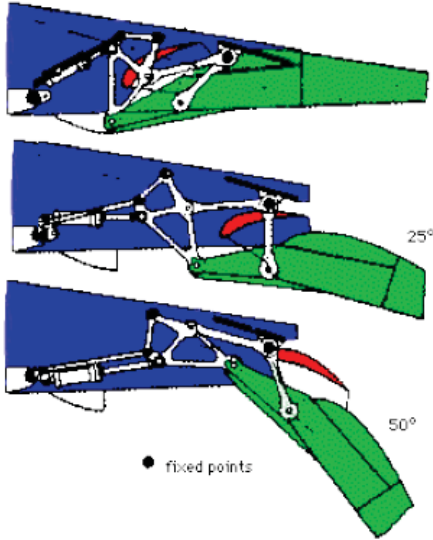

The figure shows the lift difference (for the DC-9 wing) without flaps and with several deflection angles for the flaps (from 0° to 50°)

➤ Leading edge high lift devices

Hydraulic mechanism of a slat system for a DC-9 or MD-80.

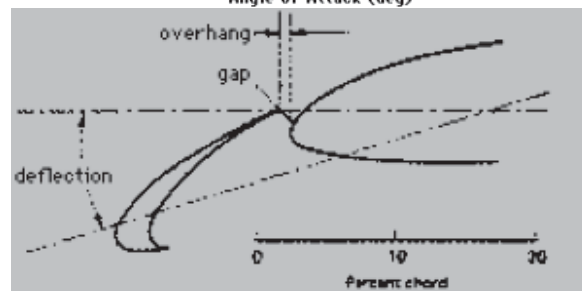
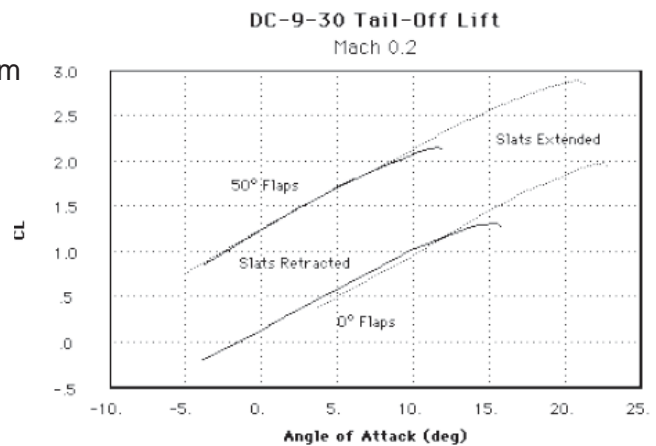
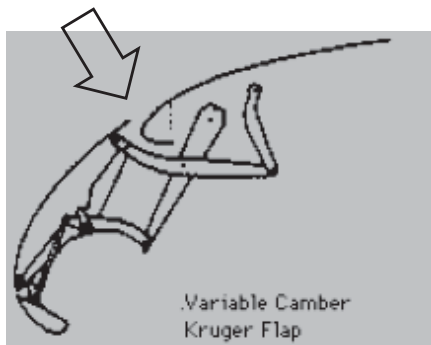
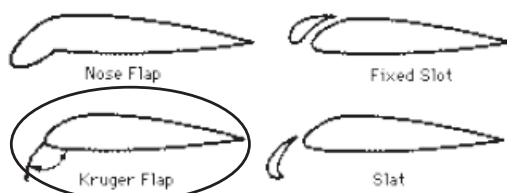

➤ **Leading edge and trailing edge high lift devices together**

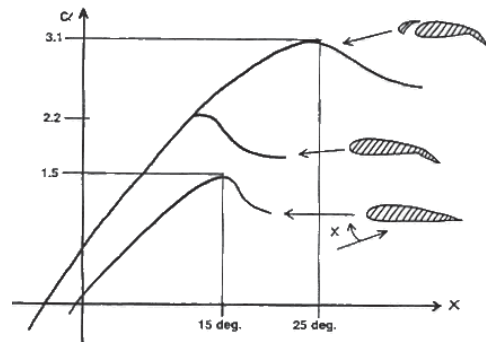
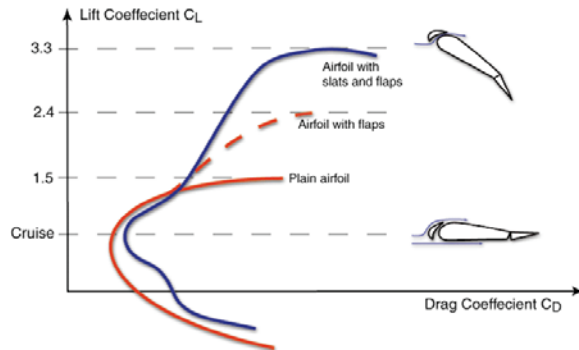
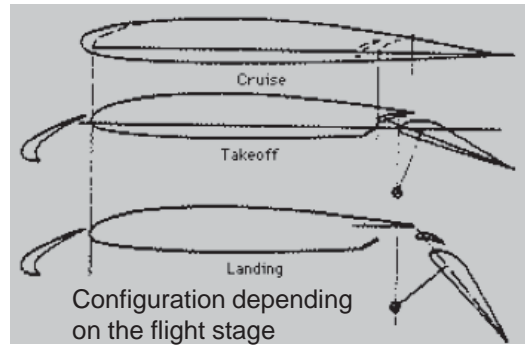
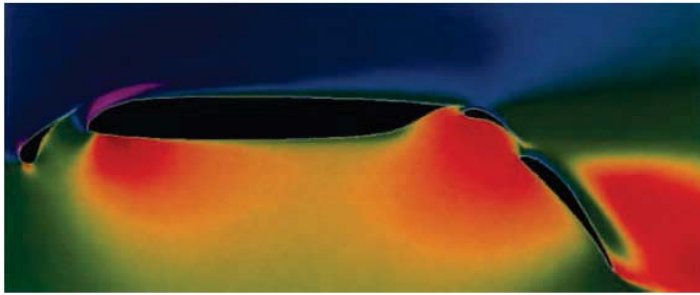

➤ **Leading edge and trailing edge high lift devices together**

Quick take-off and short landing aircraft. Due to its high t/c it cannot fly fast.

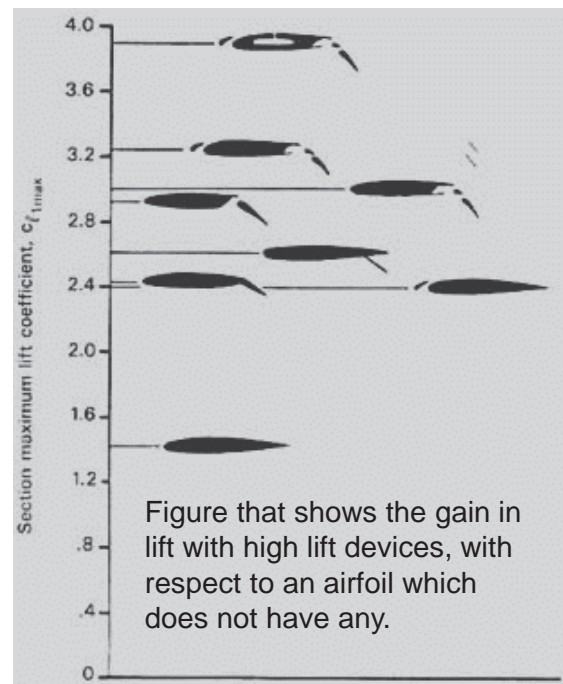
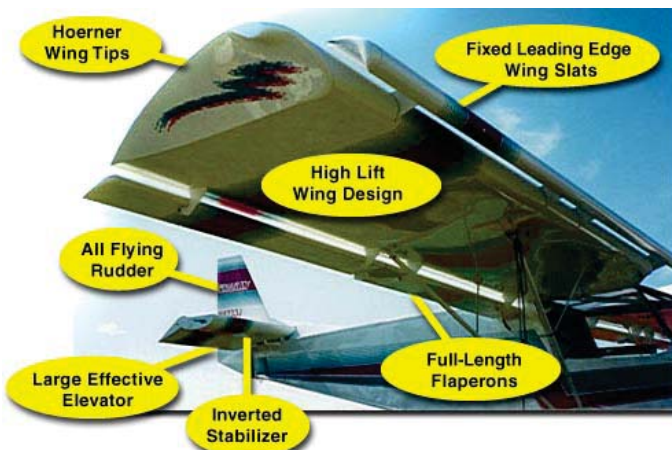

- Example of a suction gadget, as a high lift device. There are several designs.

A QUIETER LANDING

Flaps produce extra lift during the slow-down before landing, but lead to noisy vibrations. "Boundary layer ingestion" draws turbulent air into the wing, maintaining the lift without producing extra noise

During landing, the smooth airflow can separate from the wing surface, creating turbulence and reducing lift

Sucking air through holes in the wing can keep the air flowing smoothly, around the wing, maintaining lift

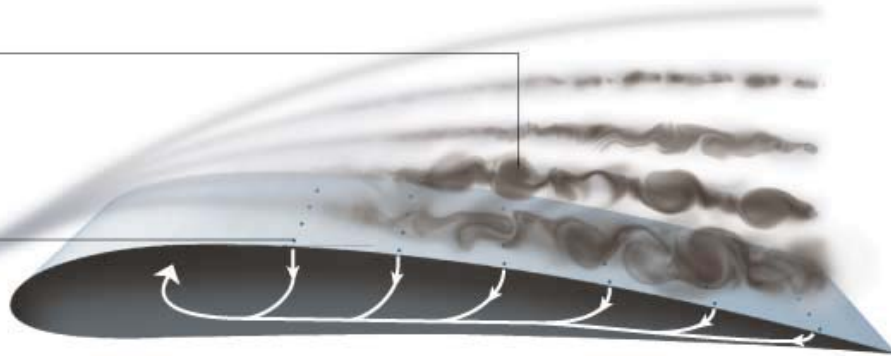

- Geometric parameters of the wing

The wing, tail planes, etc. can be obtained by distributing the airfoils along the span in different combinations. They will then work as lifting surfaces. When we deal just with airfoils, the flow is 2-dimensional, but if we consider the wing as a distribution of different airfoils along the span, the flow will be 3-dimensional in general.

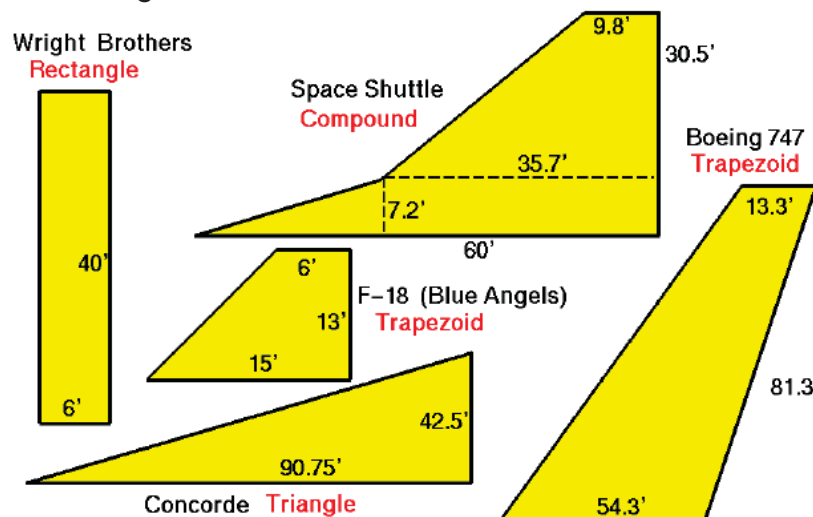

➤ The aerodynamic center

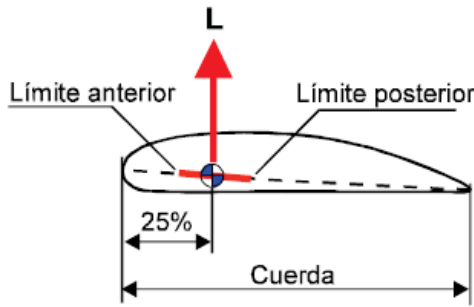

The aerodynamic center is the imaginary point in which the lift force is considered to be applied. It is taken on the aerodynamic chord, at a distance of approximately 25% of the chord from the leading edge. It is expressed in terms of percentage of the aerodynamic chord. It has certain limits of displacement, which are defined in the aircraft Flight Handbook.

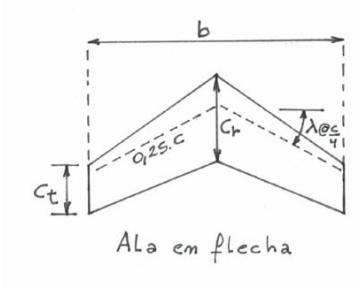

Swept wing

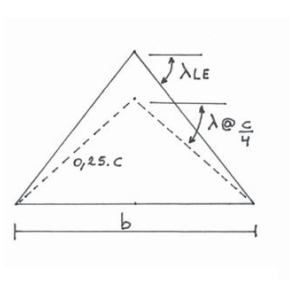

Delta wing

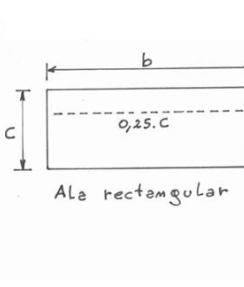

Rectangular wing

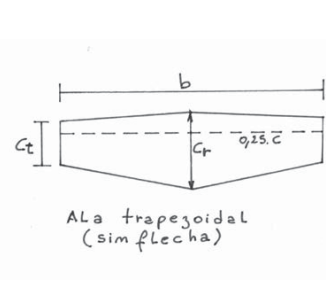

Trapezoidal wing

➤ Aerodynamic center and momentum of the wing on the center of mass

Mean aerodynamic chord (m.a.c.)

It is employed together with S (wing surface) to nondimensionalize the pitching moments (*momentos de balanceo*). In consequence, the mean aerodynamic chord is a mean chord that, multiplied by the surface mean momentum coefficient, the dynamic pressure and the wing surface gives the whole momentum of the wing as a result:

$$M_{wing} = (m.a.c.) (C_{\bar{M}}) qS; \quad q = \frac{1}{2} \rho V^2$$

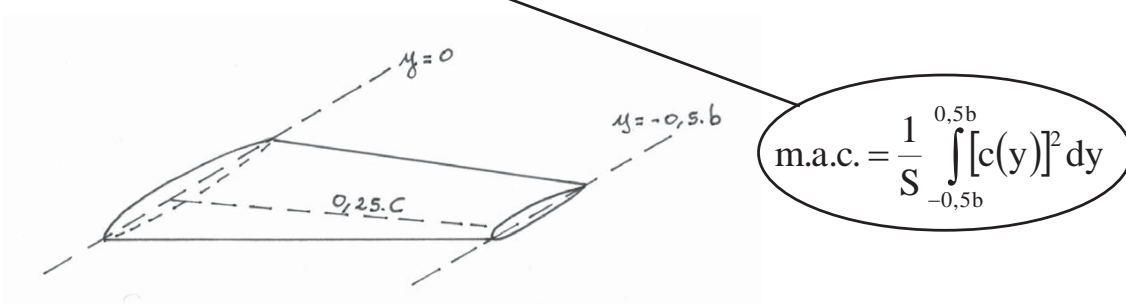

- **Wingspan (Envergadura alar):** b .- It is the distance from wingtip to wingtip.
- **Wing surface (Superficie alar):** S .- The surface of the wings, including the part of the wing that can be covered by the fuselage or engine nacelles, as if these elements did not exist.
- **Mean chord (Cuerda media):** c .- The airfoils that constitute the wing use to be different along its span, and usually their chords are gradually shortened from the root to the tips. The mean chord is defined as the chord that, multiplied by the wingspan, equals the wing surface:

$$S = c \cdot b$$

$$c = \frac{S}{b}$$

- **Taper ratio (Estrechamiento):** λ .- It is defined as:
Where c_{root} is the airfoil chord in the root and c_{tip} is the airfoil chord in the tip.

$$\lambda = \frac{c_{tip}}{c_{root}}$$

- **Aspect ratio (Alargamiento):** A .- It is the relation between the wingspan and the mean chord:
It varies from 3 or 4 in very fast aircraft to 20 or 30 in some gliders. The DC-9 has an AR of 9.44, the Boeing 727 AR is 7.2 and that of the Boeing 747 is 6.96.

$$A = \frac{b}{c} \quad \text{or} \quad A = \frac{b^2}{S}$$

- **25% chord line (Línea del 25% de la cuerda).**- It is the chord that would be obtained if all the points along the span located at 25% of the chord (from the leading edge) were joined.

- **Sweep (flecha):** ϕ .- It is the angle defined by the 25% chord line and a perpendicular line to the aircraft longitudinal axis. If the wing is not tapered, this angle is the same as the one formed by the wing leading edge and the perpendicular line to the aircraft longitudinal axis. The sweep can be onwards or backwards. In modern commercial turbojets its value is somewhere between 30° and 40° of backward sweep: 30° the B-52, 32° the B-727 and 37.5° the B-747.

- **Mean aerodynamic chord (Cuerda media aerodinámica):** MAC.- It is the chord that would have a rectangular (taper ratio equal to 1) and unswept wing that produces the same momentum and lift of the original wing.

The position of the mean aerodynamic chord with respect to the aircraft longitudinal axis can be obtained via the appropriate mathematical expressions or geometrically. Its position is important with regards to longitudinal stability.

- **Dihedral angle (Diedro):** It is the angle defined by the intersection of the two wing planes, and it has a important influence on the aircraft lateral stability.

- **Torsion:** it can be geometric or aerodynamic.

–The **geometric torsion** consists of having a different angle of attack for each of the airfoils that compose the wing, giving the section in the tip a lower angle of attack with respect to the angle of attack of the root. This torsion, a relative twist of the chords, is usually gradual from the root to the tip of the wing.

–The **aerodynamic torsion** is achieved with different airfoils along the wingspan, so that the angle of zero lift varies for the different airfoils that compose the wing. The effect is the same that can be obtained with the geometric torsion. A way of obtaining the aerodynamic torsion is increasing the camber of the airfoils in a progressive way from the root to the tip, so that the value of C_{lmax} (maximum lift coefficient) is increased in the tips.

The global aerodynamic features of an aircraft wing can be summarized in the following functions:

$$C_L = C_L(\alpha)$$

$$C_D = C_D(C_L)$$

$$C_m = C_m(C_L)$$

These three functions can be plotted as follows:

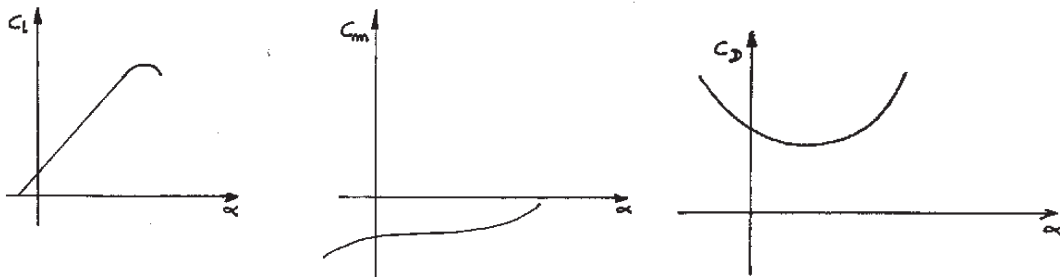

➤ Parabolic drag polar

The parabolic drag polar is an approximate analytical expression of the drag polar of the aircraft. It is useful in order to obtain an analytical function to determine certain points of C_L and C_m .

The function is obtained from an equation of the type: $y = a + b.x^2$ given by the drag:

$$C_D = C_{D_0} + \frac{C_L^2}{\pi A Re}$$

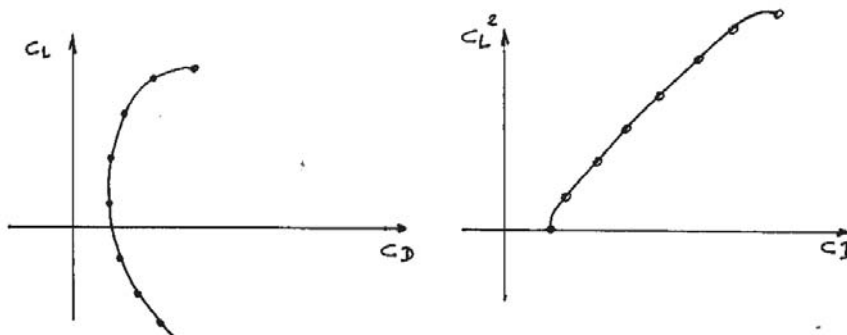

Taking the previous figure for $C_i > 0$, a curve which is similar to a straight line can be obtained.

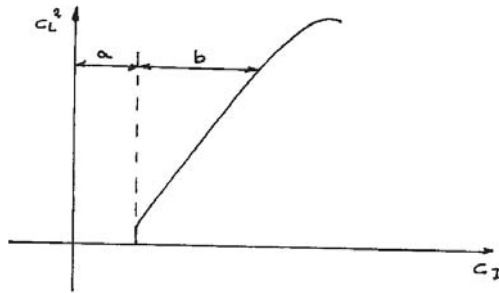

$$y = a + b \cdot x^2$$

$$a = C_{D_0}$$

$$b = \frac{1}{\pi \cdot AR \cdot e}$$

The **value of C_{D_0}** can be obtained from similar aircraft to the one to be designed. This parameter represents the drag provided by the aircraft body together with the wings when no lift is generated. The value is usually between 0.014 and 0.04 for the different kinds of aircraft.

In order to draw the drag polar, the aircraft must be considered as a whole. A value of C_{D_0} can be assumed at first, with the typical values of similar aircraft.

In the calculations of the **induced resistance**:

$$\frac{C_L^2}{\pi \cdot AR}$$

The value of AR has to be corrected when the wing is not elliptical. This is where the so-called **OSWALD factor** is introduced. Report NACA 408 (1932).

A first relation is the following one:

$$C_{Di} = \frac{C_L^2}{\pi AR} (1 + \delta) \quad \text{(Page 74 Perkins, Page 191 Mc Cormick.)}$$

δ represents the correction due to the wing planform or, in other words, the increase in induced drag with respect of the optimum planform (elliptical).

The other expression of the coefficient to correct the deviation from the elliptical lift is obtained in the following way:

$$C_D = C_{D_0} + K \cdot C_L^2$$

$$C_D = C_{D_0} + \frac{C_L^2}{\pi AR} (1 + \delta)$$

$$C_D = C_{D_0} + \frac{C_L^2}{\pi ARe}$$

where

$$e = \frac{1}{1 + \delta}$$

is defined as the Oswald coefficient

➤ Wingspan

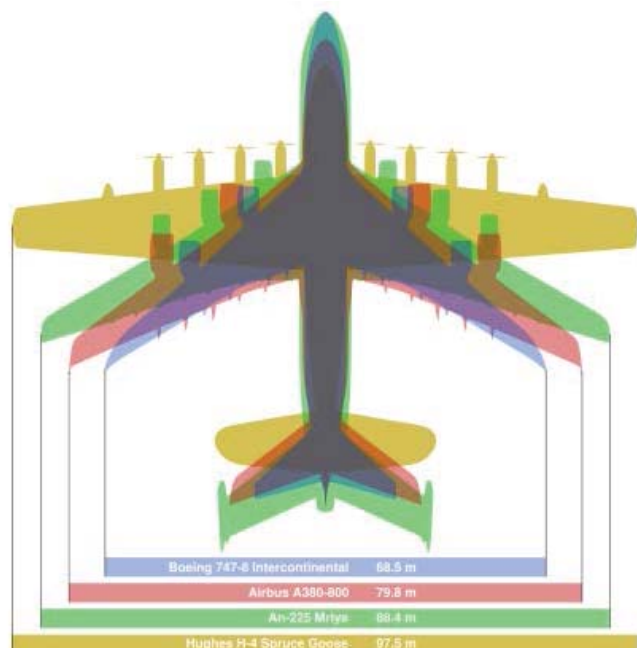
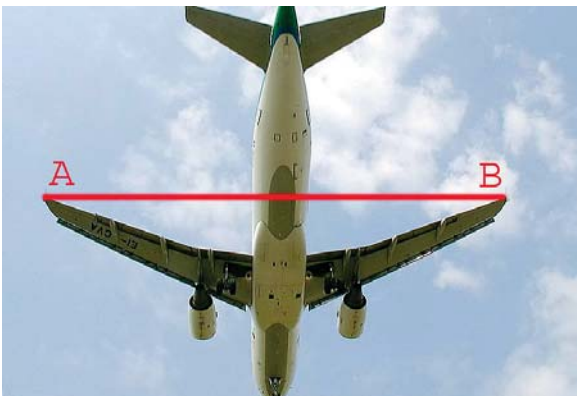

➤ Wing surfaces

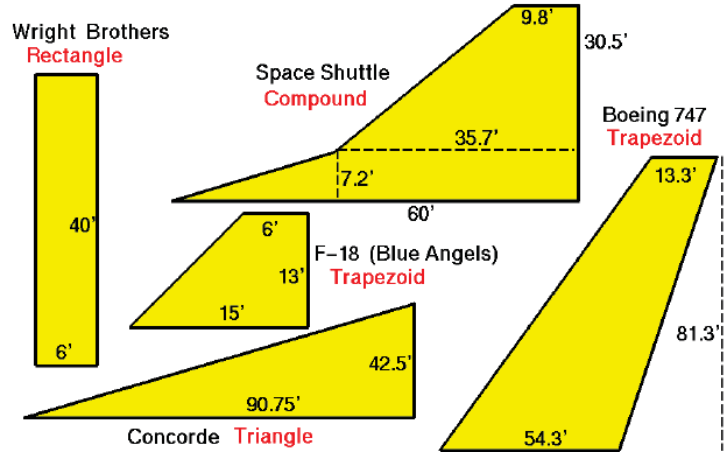
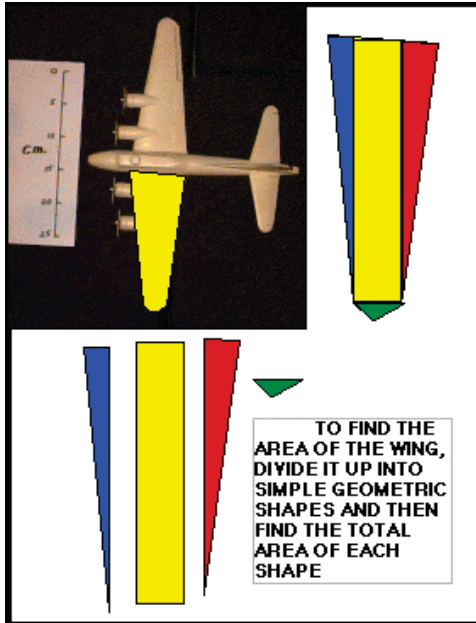

➤ Aspect ratio (*alargamiento*)

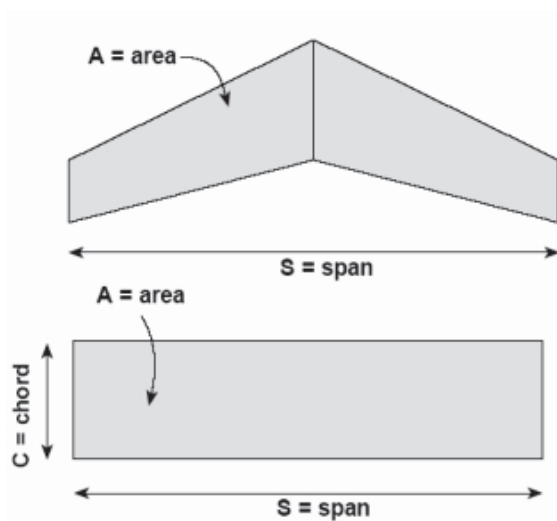

In general:
 $A.R. = \frac{S^2}{A}$

for rectangular wing:
 $A.R. = \frac{S^2}{A} = \frac{S^2}{SC} = \frac{S}{C}$

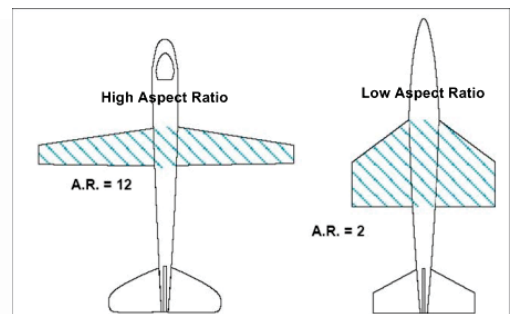

A higher AR improves the efficiency and ground effect, but it increases the bending moment and gives roll and aeroelasticity problems.

➤ Trapezoidal wing:

Surface, aspect ratio (*alargamiento*), sweep (*flecha*), 25% of the chord line, taper ratio (*estrechamiento*).

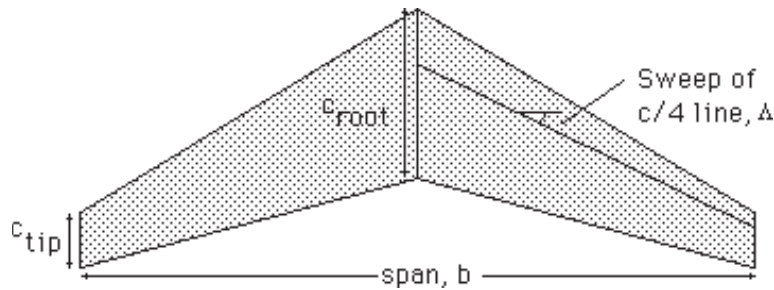

S = wing area

$$AR = \text{aspect ratio} = \frac{b^2}{S} = \frac{b}{c}$$

$$\lambda = \text{taper ratio} = \frac{c_{\text{tip}}}{c_{\text{root}}}$$

Δ = sweep of c/4 line

➤ Mean Aerodynamic Chord (*cuerda media aerodinámica*)

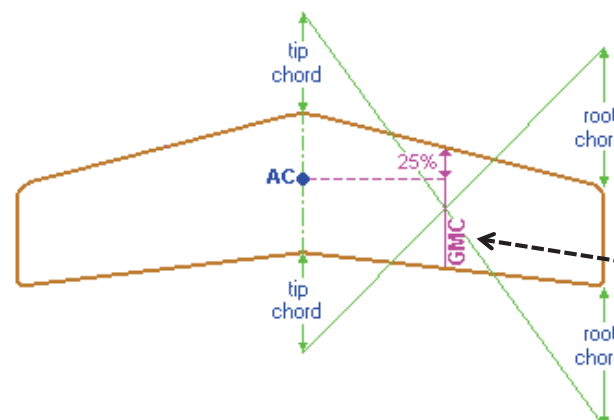
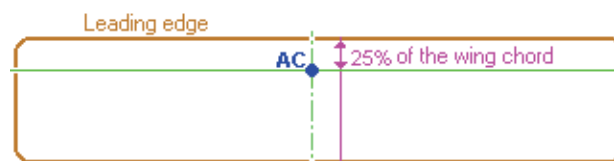

**Mean
Aerodynamic
Chord
(obtained
geometrically)**

➤ Effects of the design: Span (*envergadura*)

1. The optimum is quite flat and one must stretch the span a great deal to reach the actual optimum.
2. Concerns about wing bending as it affects stability and flutter mount as span is increased.
3. The cost of the wing itself increases as the structural weight increases. This must be included so that we do not spend 10% more on the wing in order to save .001% in fuel consumption.
4. The volume of the wing in which fuel can be stored is reduced.
5. It is more difficult to locate the main landing gear at the root of the wing.
6. The Reynolds number of wing sections is reduced, increasing parasite drag and reducing maximum lift capability.

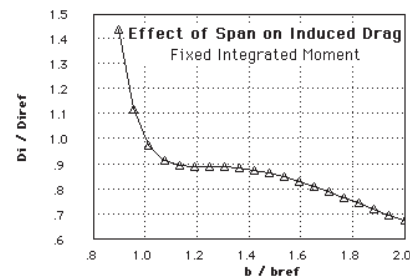

➤ Effects of the design: Wing surface (*superficie alar*)

1. Cruise drag
2. Stalling speed / field length requirements
3. Wing structural weight
4. Fuel volume

These considerations often lead to a wing with the smallest area allowed by the constraints. But this is not always true; sometimes the wing area must be increased to obtain a reasonable C_L at the selected cruise conditions.

Selecting cruise conditions is also an integral part of the wing design process. It should not be dictated a priori because the wing design parameters will be strongly affected by the selection, and an appropriate selection cannot be made without knowing some of these parameters. But the wing designer does not have complete freedom to choose these, either. Cruise altitude affects the fuselage structural design and the engine performance as well as the aircraft aerodynamics. The best C_L for the wing is not the best for the aircraft as a whole. An example of this is seen by considering a fixed C_L , fixed Mach design. If we fly higher, the wing area must be increased by the wing drag is nearly constant. The fuselage drag decreases, though; so we can minimize drag by flying very high with very large wings. This is not feasible because of considerations such as engine performance.

➤ Effects of the design: Thickness (*espesor*)

1. The distribution of thickness from wing root to tip is selected as follows: We would like to make the t/c as large as possible to reduce wing weight (thereby permitting larger span, for example).
2. Greater t/c tends to increase $C_{L_{max}}$ up to a point, depending on the high lift system, but gains above about 12% are small if there at all.
3. Greater t/c increases fuel volume and wing stiffness.
4. Increasing t/c increases drag slightly by increasing the velocities and the adversity of the pressure gradients.
5. The main trouble with thick airfoils at high speeds is the transonic drag rise which limits the speed and C_L at which the airplane may fly efficiently.

➤ Effects of the design: Sweep (*flecha*)

Wing sweep is chosen almost exclusively for its desirable effect on transonic wave drag. (Sometimes for other reasons such as a c.g. problem or to move winglets back for greater directional stability.)

1. It permits higher cruise Mach number, or greater thickness or C_L at a given Mach number without drag divergence.
2. It increases the additional loading at the tip and causes spanwise boundary layer flow, exacerbating the problem of tip stall and either reducing $C_{L_{max}}$ or increasing the required taper ratio for good stall.
3. It increases the structural weight - both because of the increased tip loading, and because of the increased structural span.
4. It stabilizes the wing aeroelastically but is destabilizing to the airplane.
5. Too much sweep makes it difficult to accommodate the main gear in the wing.

➤ Effects of the design: Taper ratio (*Estrechamiento*)

The wing taper ratio (or in general, the planform shape) is determined from the following considerations: The planform shape should not give rise to an additional lift distribution that is so far from elliptical that the required twist for low cruise drag results in large off-design penalties.

1. The chord distribution should be such that with the cruise lift distribution, the distribution of lift coefficient is compatible with the section performance. Avoid high C_l 's which may lead to buffet or drag rise or separation.
2. The chord distribution should produce an additional load distribution which is compatible with the high lift system and desired stalling characteristics.
3. Lower taper ratios lead to lower wing weight.
4. Lower taper ratios result in increased fuel volume.
5. The tip chord should not be too small as Reynolds number effects cause reduced C_l capability.
6. Larger root chords more easily accommodate landing gear.

➤ Propagation of the stall due to maneuvering or high angle of attack

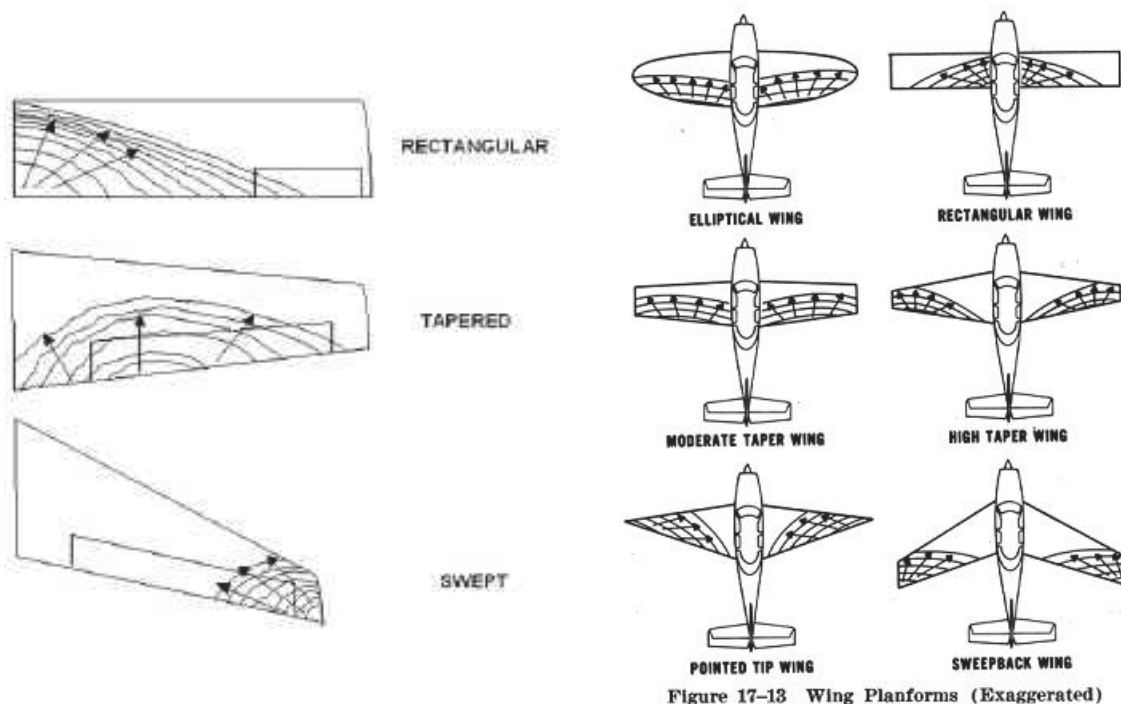

➤ Dihedral angle

If we face the aircraft, it is the “V” shape angle defined by the wings with respect to the horizon.

The dihedral angle may be positive, neutral or negative. If we place the arms in cross, we have neutral dihedral, if we lift them they have positive dihedral, and if we lower them they have negative dihedral. The dihedral gives more stability to the aircraft during the flight, depending on the location of the wings with respect to the winds.

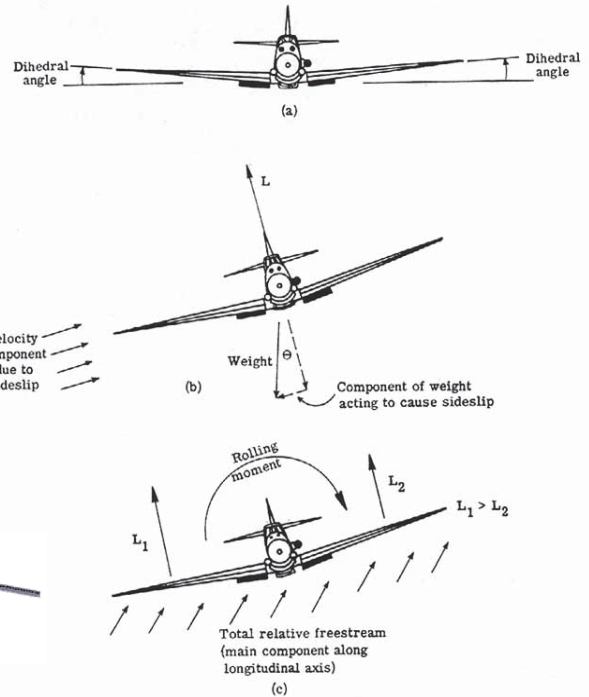
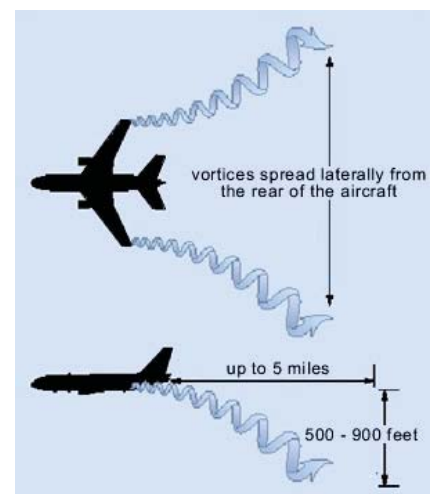
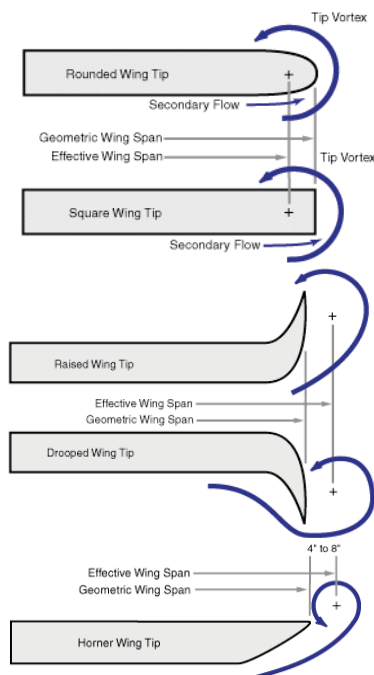
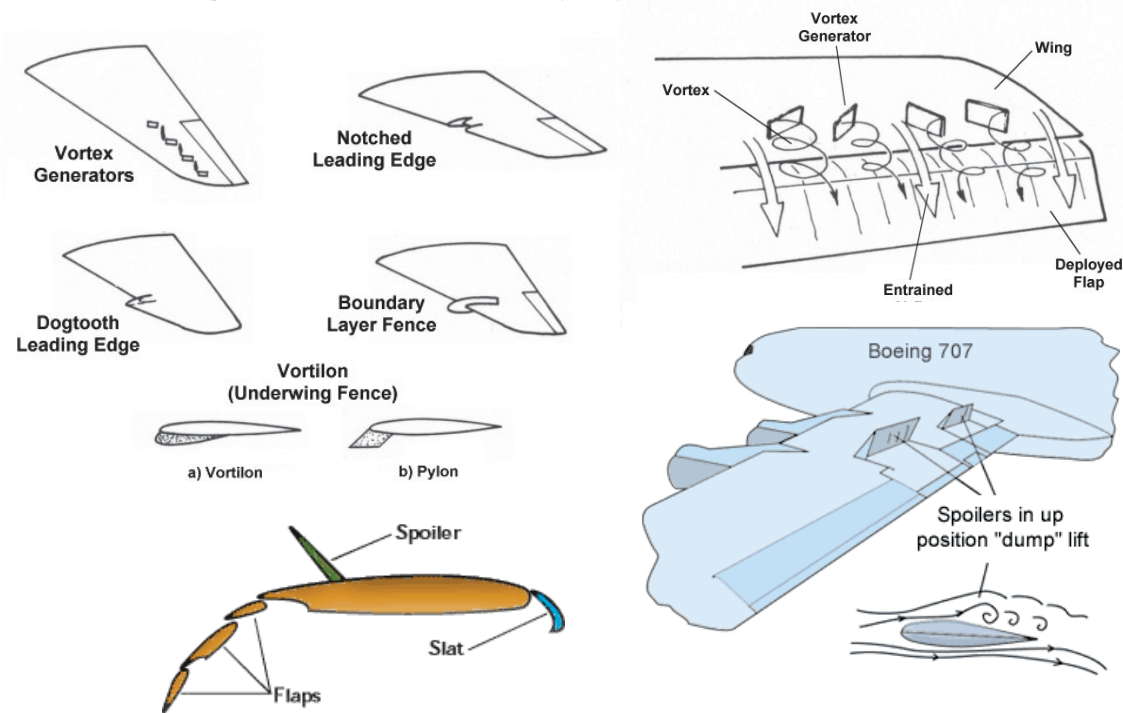

Fig.1.4.4 - Angulos diedros.

➤ Shapes of the wingtips, devices to reduce the induced drag



➤ Vortex generators or boundary layer control



➤ Spoilers

Balance via spoilers or roll thanks to the use of spoilers

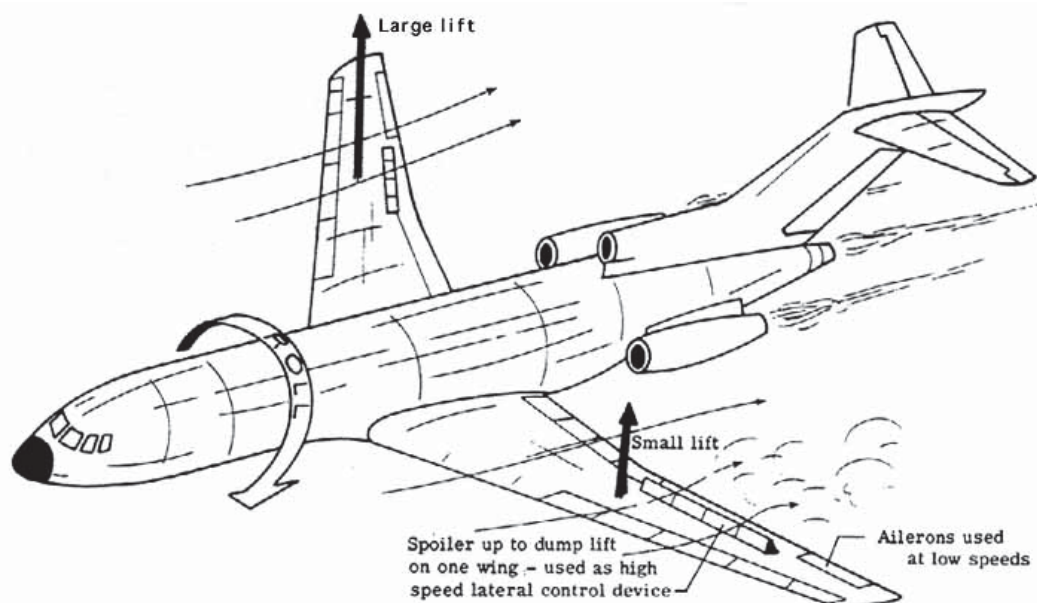

➤ **Boundary layer control devices and vortex generators**



Photographer: Brian Lockett
Goleta Air & Space Museum



➤ **Tails, rudder (*timón de profundidad*) and rear stabilizers**

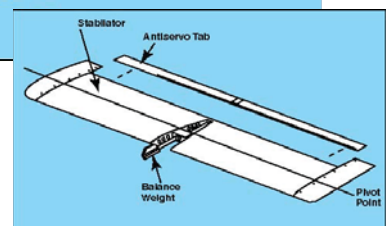
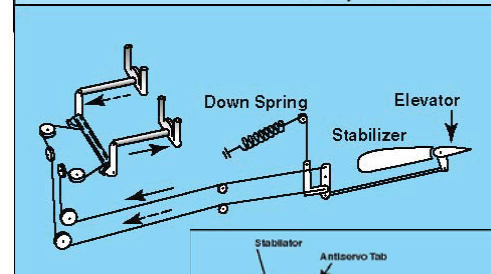
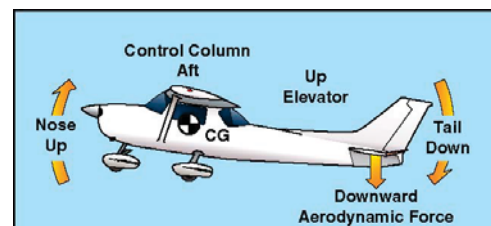
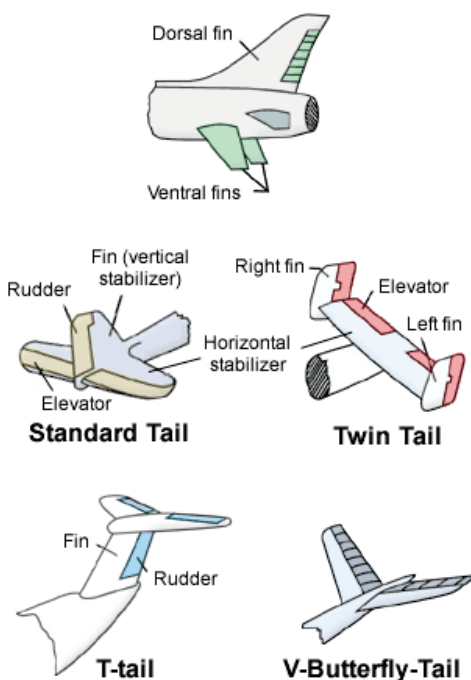
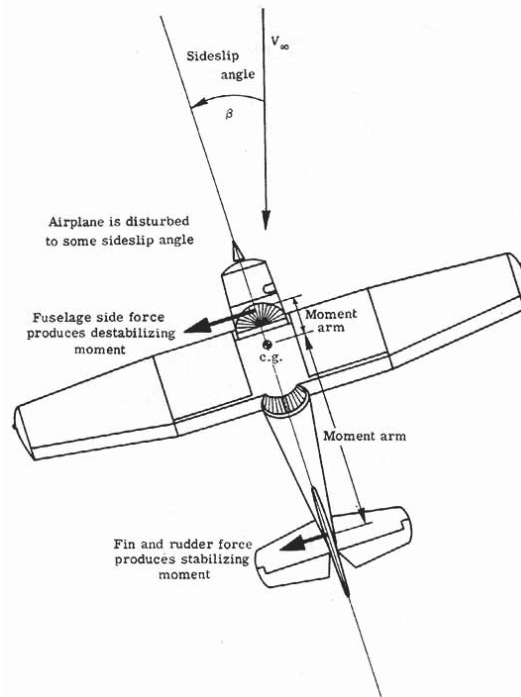
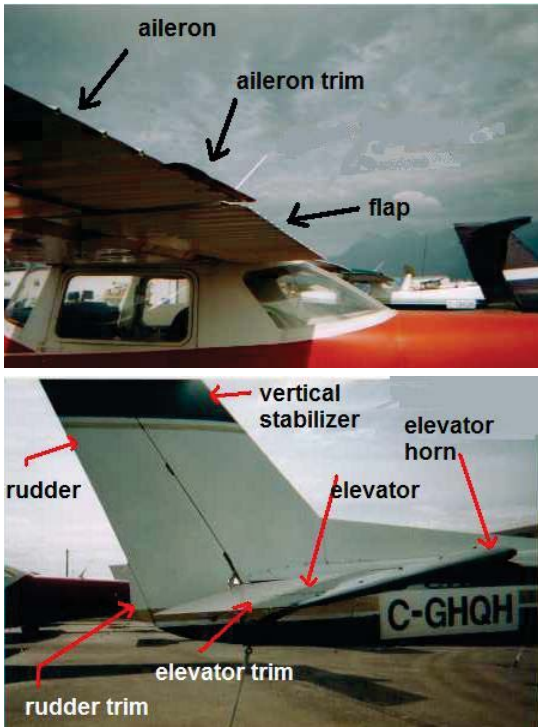

Figure 4-9. The stabilizer is a one-piece horizontal tail surface that pivots up and down about a central hinge point.

➤ Complete systems in wings and tails for the stable flight of an aircraft



➤ Alternative control systems

F-4 Phantom all-moving control surfaces

Fighters move all the surface

F-14A Tomcat

X-15 and Space Shuttle thanks to little rockets

(a) X-15 reaction controls.

Harrier thanks to bled air from the compressor

(b) Space Shuttle reaction controls.

Flight Control Surfaces

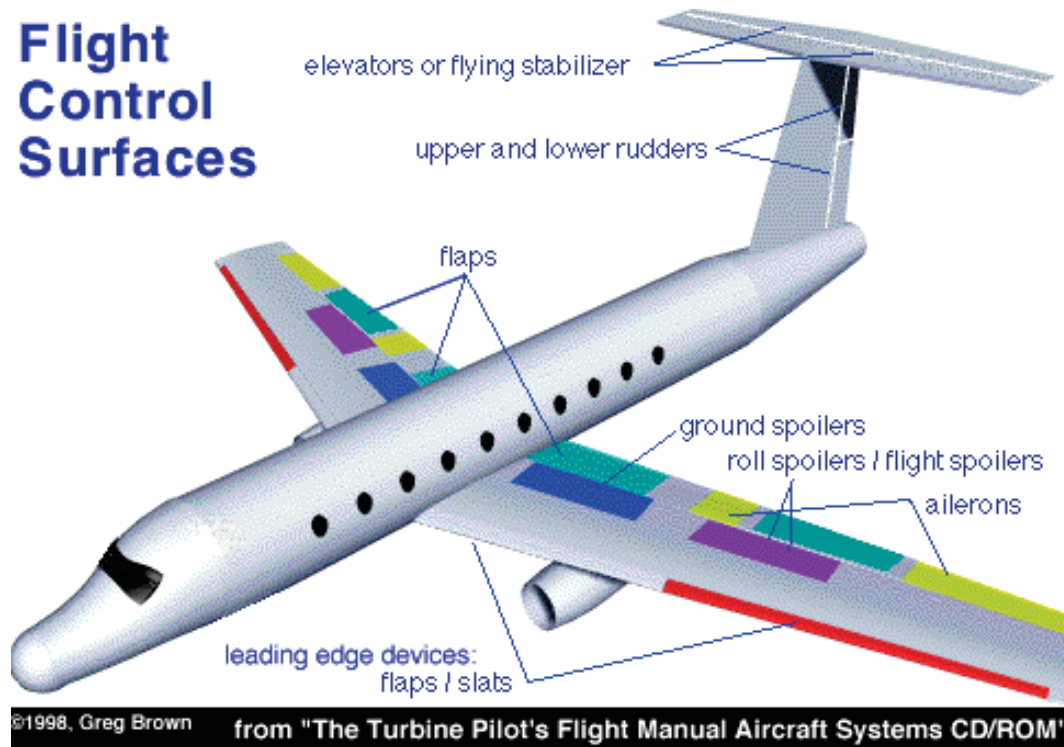

➤ Conclusion: all the mobile systems of an aircraft to control the flight

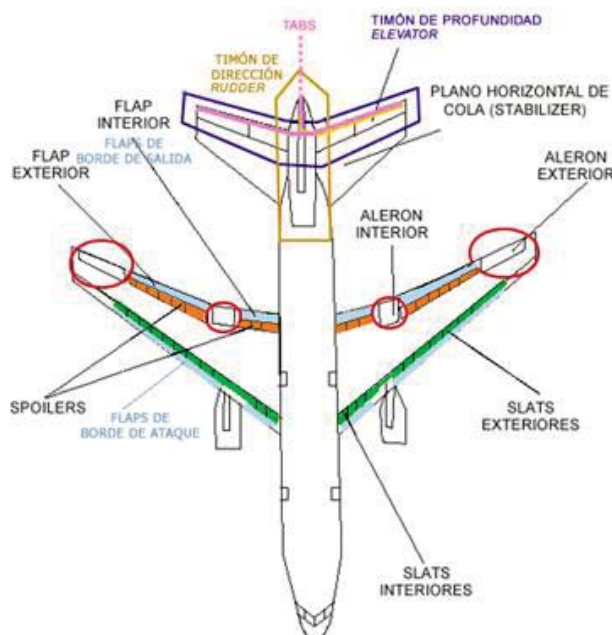

Aircraft

4 Aircraft Systems

Landing Gear, Fuel, Hydraulic System. (ANNEX) Air conditioning

- Landing Gear
- Fuel
- Hydraulic System
- Annex: Cabin conditioning system

- **They are classified in two main groups:**
 - **Conventional:** the main wheels are located in the wings and the fuselage, whereas the third support (wheel or skid) is located in the tail.
 - **Tricycle:** the main train is located in the same way as the conventional landing gear, but the third support is located at the front part (nose) of the aircraft. This last support is the one that includes the direction control device.
- **In addition, the landing gears can be divided as:**
 - **Fixed:** those ones that lack a retraction movement to be hidden within a compartment located in the wing or engines.
 - **Retractable:** those ones that possess a device to be stored within some cavity in the aircraft.

The conventional landing gears do not use to be retractable, except for some exceptions.

The figures highlight the differences among the conventional landing gear (tail wheel configuration) and the tricycle. Special attention must be given to the CG and its position with respect to the main gear.

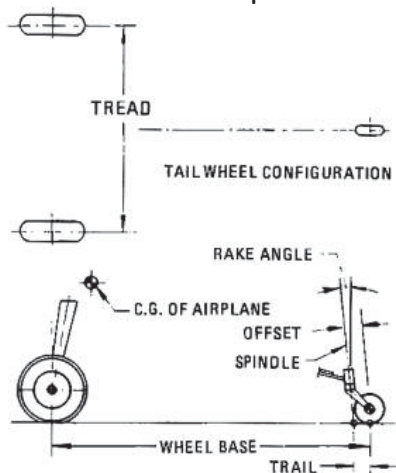

Conventional landing gear

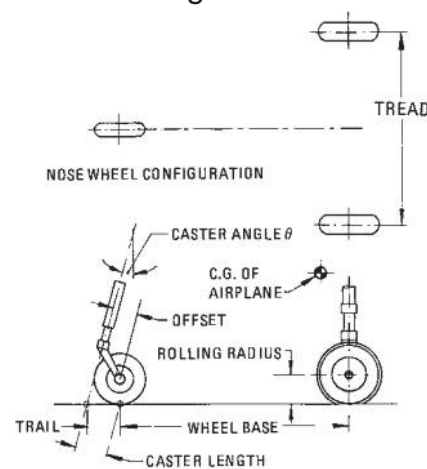

Tricycle landing gear

The so-called “tread” distance is important, as it defines the category of the runways in the airports. In letters, for instance 3B, 4E, 4F.



↑ Luscombe

Pilatus PC-6 ↓



Examples of conventional landing gears



Cessna 150

Commercial aircraft use to have several “buggies” in their rear part to better distribute the force of the impact on the runway without suffering any damage.

Examples of tricycle landing gears

A-380



➤ Description of the conventional landing gear

The conventional landing gear is constituted by two landing struts beneath the wing or fuselage (near the position of the wing) and a tail wheel or skid.

This kind of landing gear has several inconvenients, which are:

- It does not allow a good visibility to the pilot.
- To take-off, the empennage has to produce a certain lift so that the aircraft reaches a horizontal position or the tail wheel gets to the air.
- During the landing, there is a certain risk that a bad braking can turn over (or completely turn around) the aircraft. Thus, when it lands, it does so through two points: the two front struts.

The direction is controlled through the tail wheel or skid, commanded by wires. It can also be controlled by applying the brake in one of the two main struts and demanding thrust (in the case of a two-engine aircraft) to the engine that is opposed to the strut where the brake was applied.

➤ Description of the tricycle landing gear

The tricycle landing gear is constituted by two main struts beneath the wing or the fuselage and a strut at the nose of the aircraft. The nose strut has a direction control device.

The tricycle landing gear has the same mission as the conventional one, but it offers more advantages:

- The landing technique allows to place the aircraft on ground in a horizontal position, avoiding danger of slippery even when the brakes are applied during landing.
- The stability that the tricycle landing gear provides when landing with tailwind or crosswind. This is due to the position of the center of gravity, in front of the main wheels, that allows to travel in a straight line during the take-off and landing. This conditions is specially important for the aircraft that must land in short runways with crosswind.

➤ **Tandem landing gear**

In addition to the conventional and the tricycle landing gears, the tandem landing gear also exists. They are only used in a few aircraft and have the same advantages of the tricycle landing gears, but they only operate in prepared runways. Examples: B-52 or B-47.

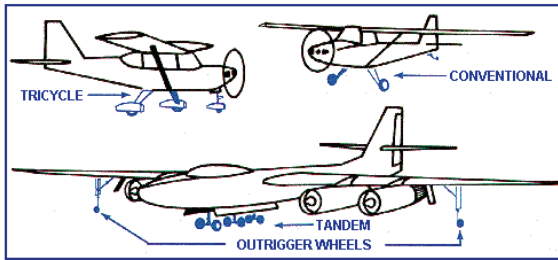
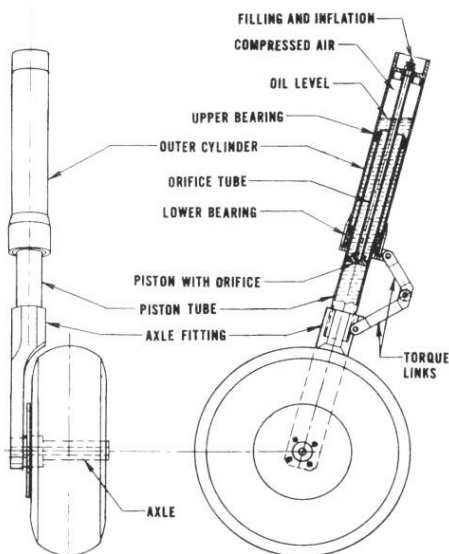

Figure 1-8 Three basic types of landing gear arrangements



➤ **For the damping (shock absorption), the landing gears use different strategies. The pneumatic piston system can be highlighted among them.**



Oleo-Pneumatic Shock Absorber Components - (Main Gear of the Ryson St-100 Motorglider)

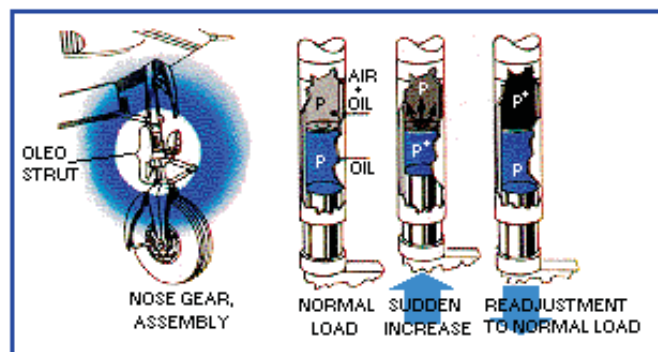
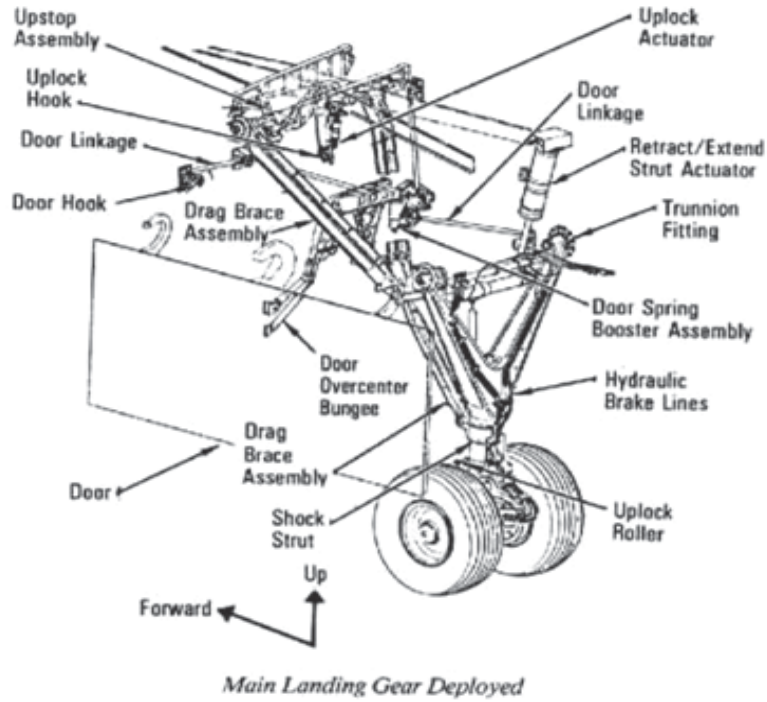
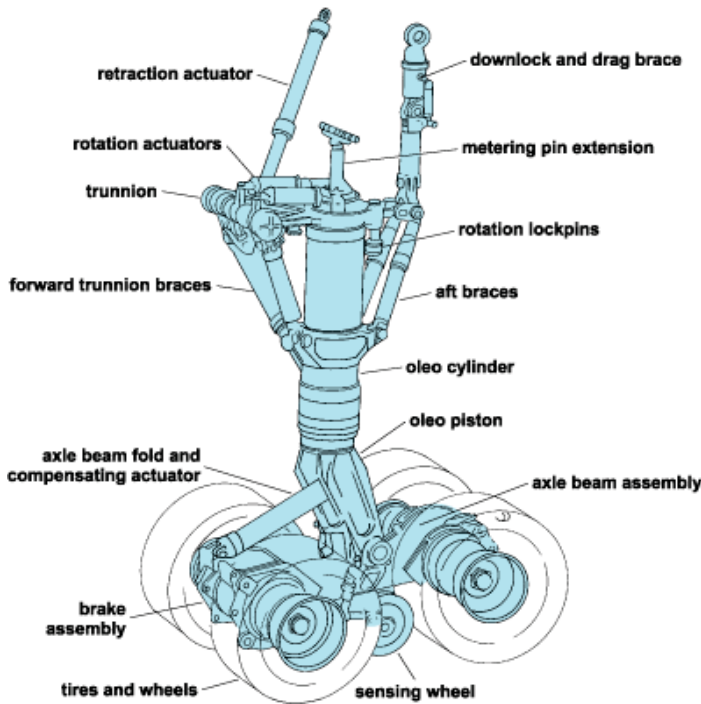

Figure 1-9 The function of an oleo strut.

➤ Retraction system of a nose landing gear



➤ Retraction system of a rear landing gear



- The function of the landing gear is not only to support the aircraft on ground, but also to avoid any deviation and bear the loads in the lateral sense.

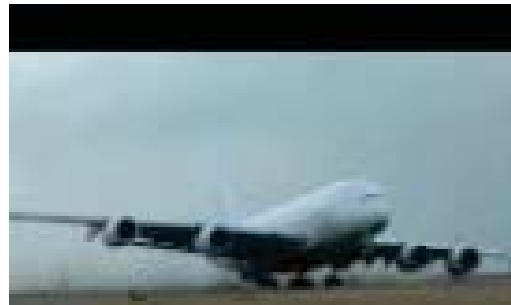
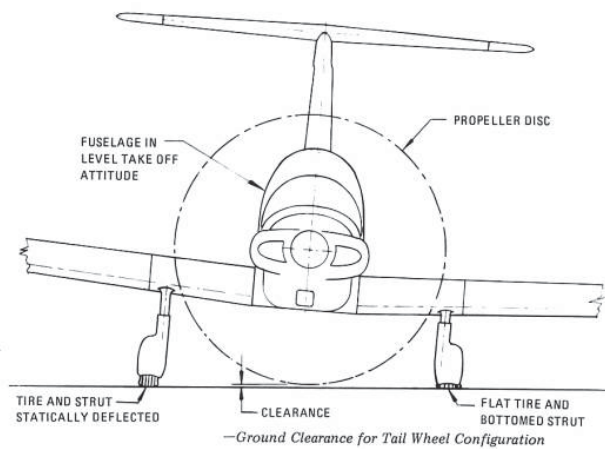

<http://www.youtube.com/watch?v=wXpjBxD0Rhq&NR=1>

<http://www.youtube.com/watch?v=UocxPoUUnIQ>

- The fuel tanks of an aircraft are divided among main tanks and auxiliary tanks. There can also exist the so-called "trim tanks".

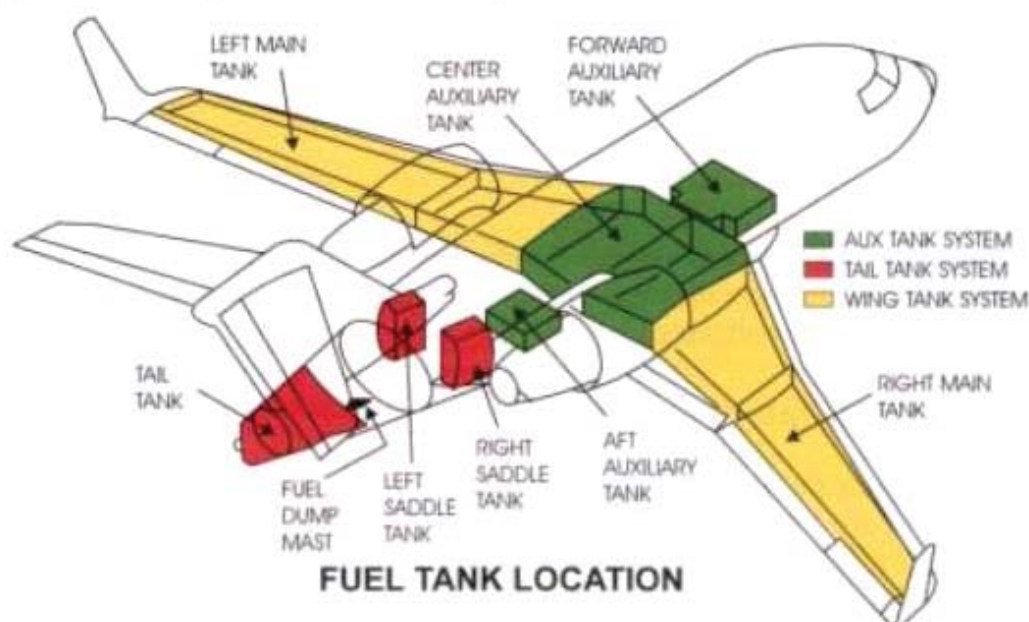

- The fuel feeds the main engines and the APU

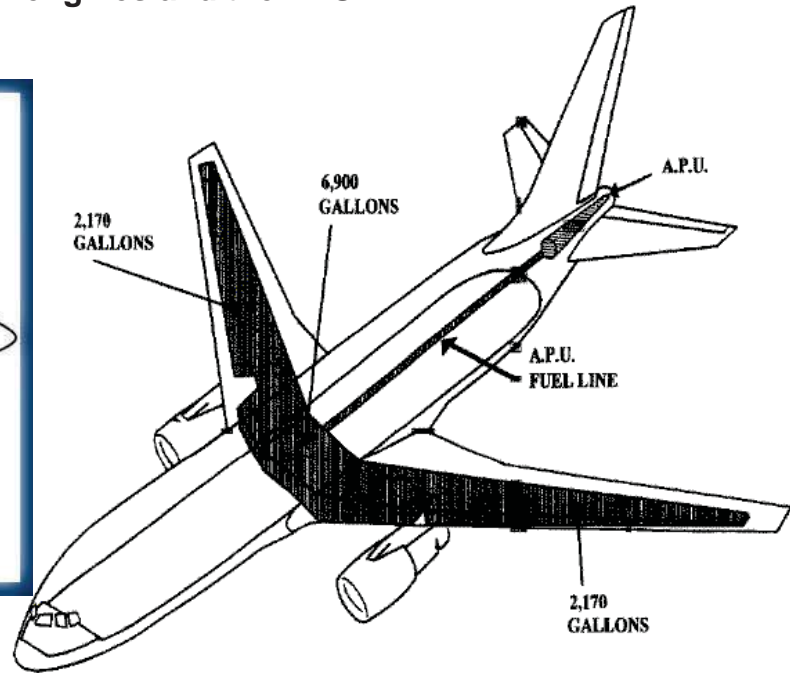
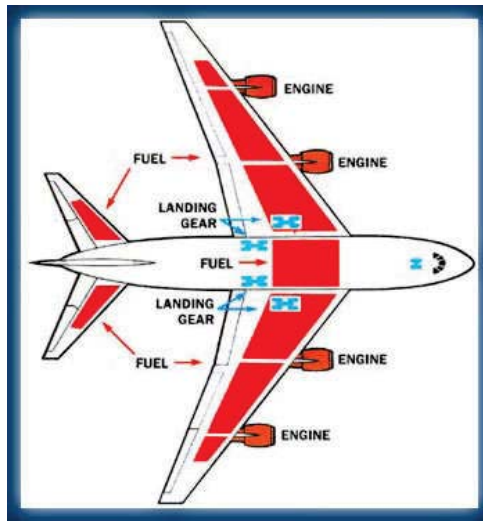

- Name of the tanks (the quantity depends on the aircraft model)

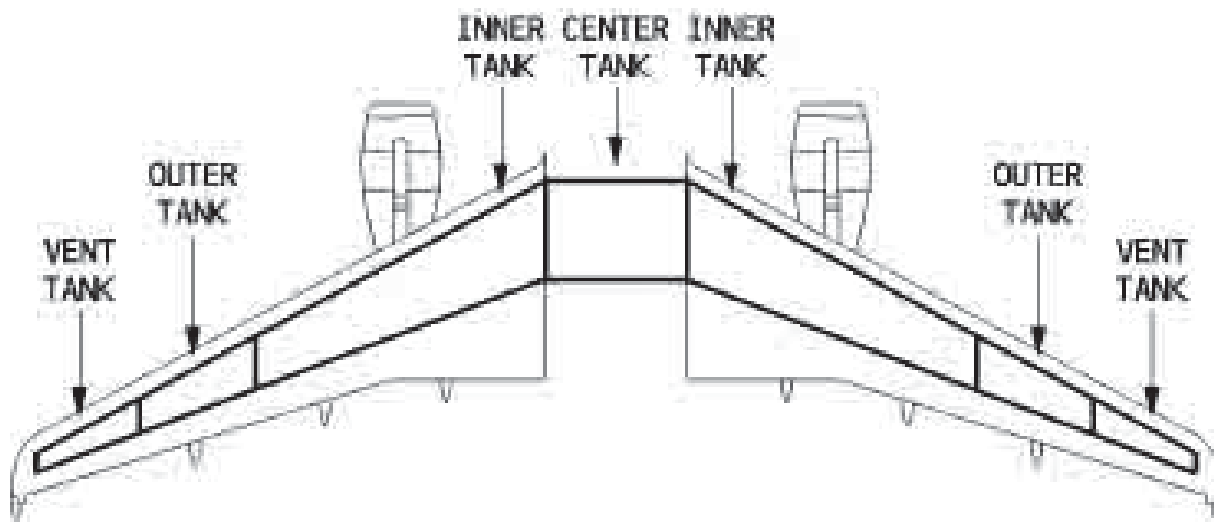

Distribution of the fuel tanks located in the wings and part of the fuselage of an Airbus A-320

➤ Distribution of the fuel through pumps and ducts

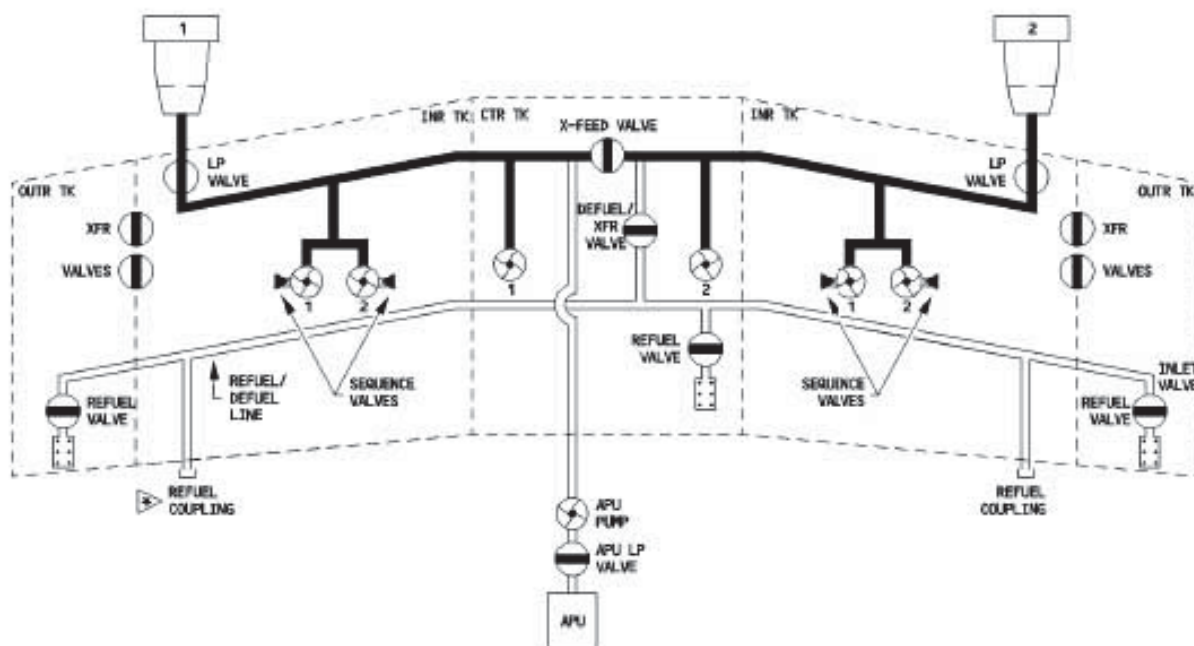

➤ Fuel system in the EFIS (Electronic Flight Instrument System) (pilot screen)



The fighter aircraft have small space to locate the fuel. In order to increase their autonomy or range several external tanks can be added, depending on the payload capacity of the aircraft. The tanks are designed according to the kind of aircraft where they are to be added, so that they do not disturb the dynamic field nor the maneuvering capacity of the aircraft.

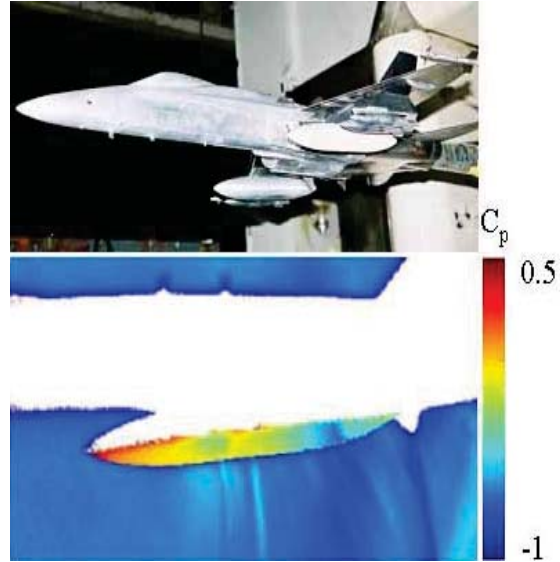
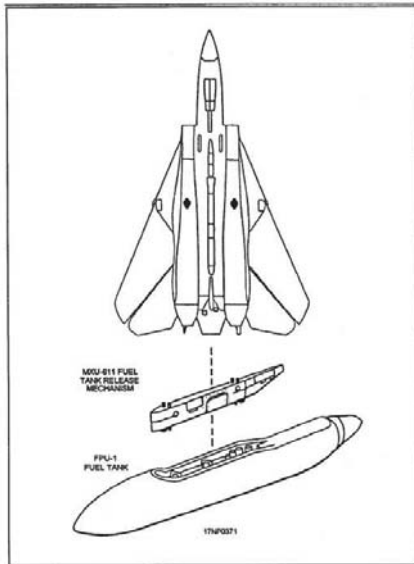

In modern aircraft, in order to increase the load capacity, the fuel tanks are located within the fuselage. There may be several tanks linked together through ducts where the fuel transfer is done through the opening and closing of valves and pressure differences.

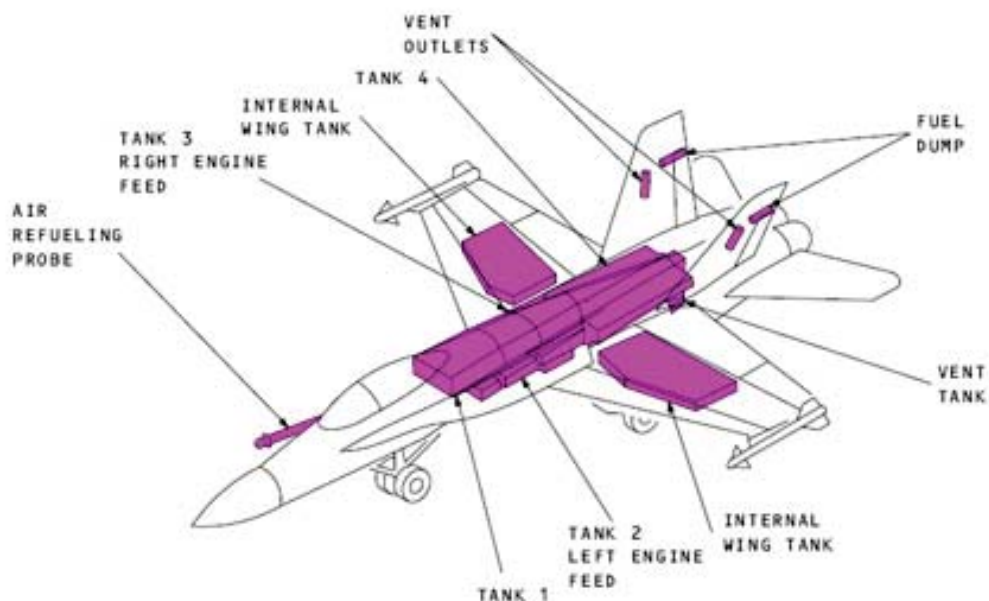

➤ Fuel Movement of the F-18 fighter

The procedure is similar for other aircraft

- The fuel proportion between tanks 1 and 4 is such that it always keeps the center of gravity in the prescriptive place. For this purpose, the fuel is transferred in a controlled way from the tanks 1 and 4 to the tanks 2 and 3 (the ones that feed the engines).
- If the system is not able to maintain the CG within limits for any reason, an alarm is activated unless the air refueling probe is open or the fuel level in tank 4 is under 450 pounds.
- The fuel transfer is normally accomplished through a couple of pumps. If one of them fails, the transfer capacity is not lost. In the case that both of them fail, tanks 2 and 3 can still be fed thanks to the gravity, due to the fact that both tanks are at different heights. In this moment, it may be necessary for the pilot to execute some manouvers in order to facilitate the transfer.
- In manouvers with negative g's, the fuel transfer from tanks 1/4 to tanks 2/3 is automatically closed.
- All tanks are pressurized, including the external ones.
- If the aircraft is on ground or the refueling probe is open, the external deposits are depressurized. The tank depressurization can also be forced manually.
- All the tanks, except for tanks 2 and 3, can be unloaded thanks to an exit at the tip of the vertical stabilizers (fuel dump). On the other hand, the internal tanks are connected to the exterior to ventilate and allow the gases to leave the tank. The external tanks have their own ventilation slots.

➤ Movement of the center of gravity

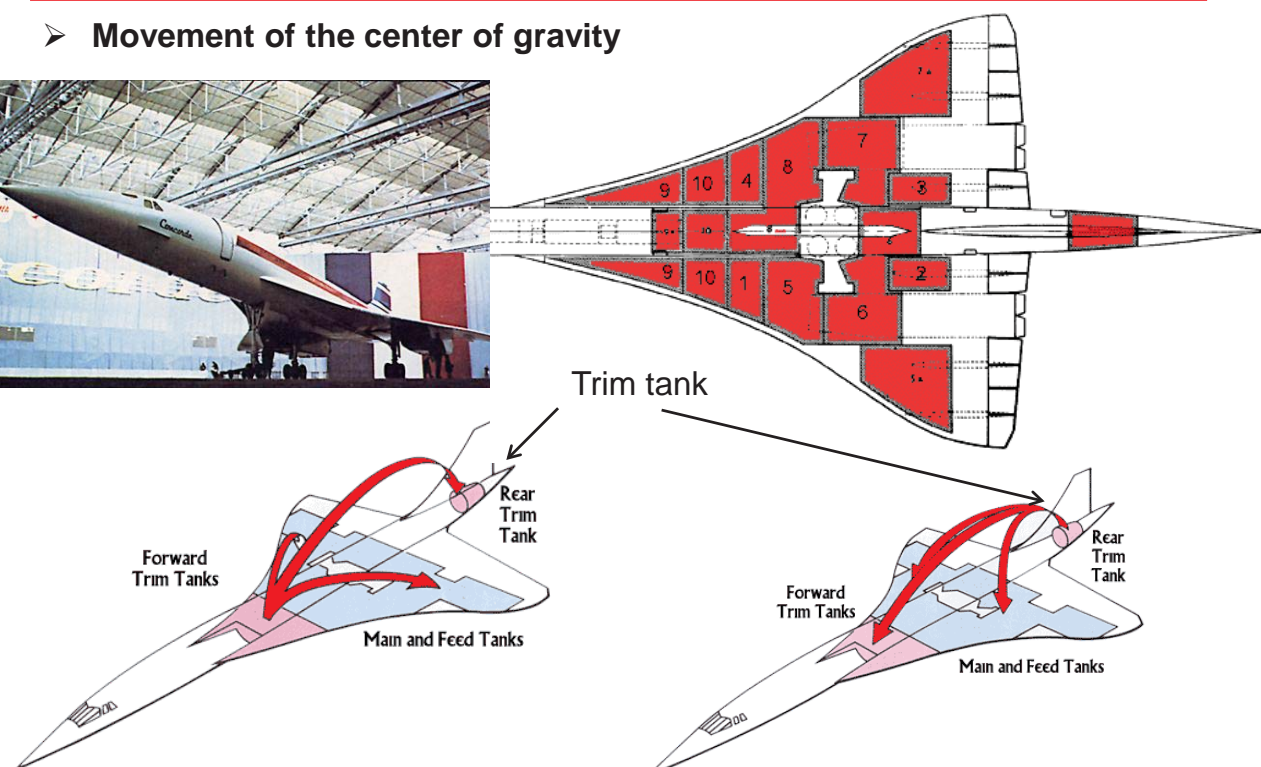

➤ **Tanker aircraft**

The fuel for other aircraft is located inside the fuselage.
The pumps can be run through wind turbines.

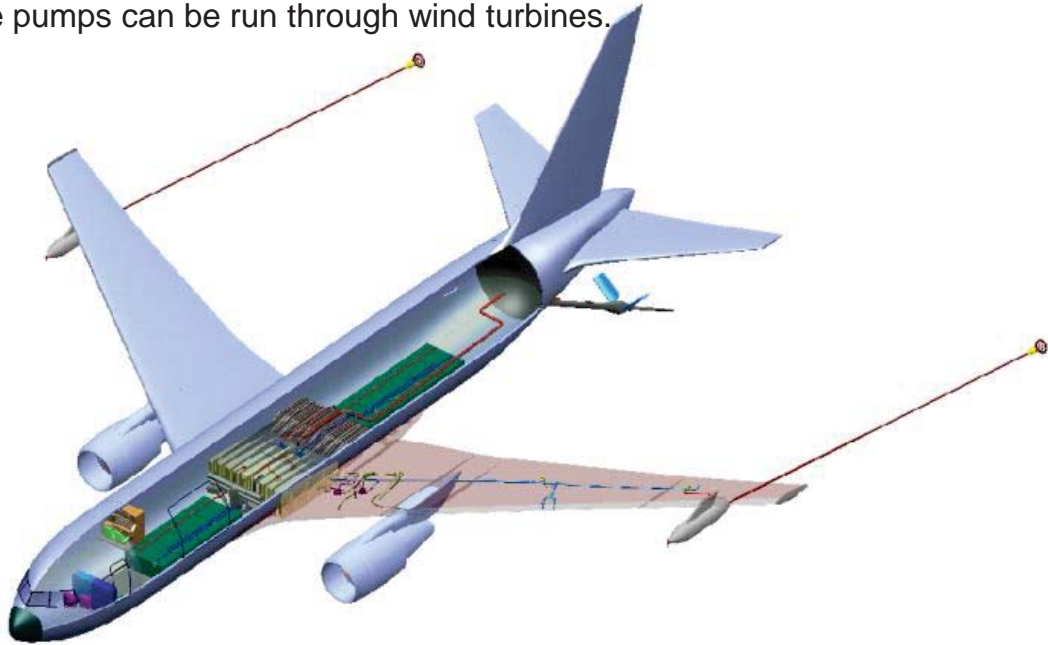

➤ **Fuel tanks at wings and wingtips**

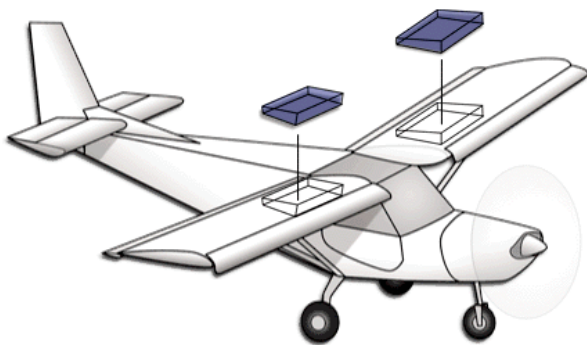

➤ Carburetor system in a piston engine aircraft

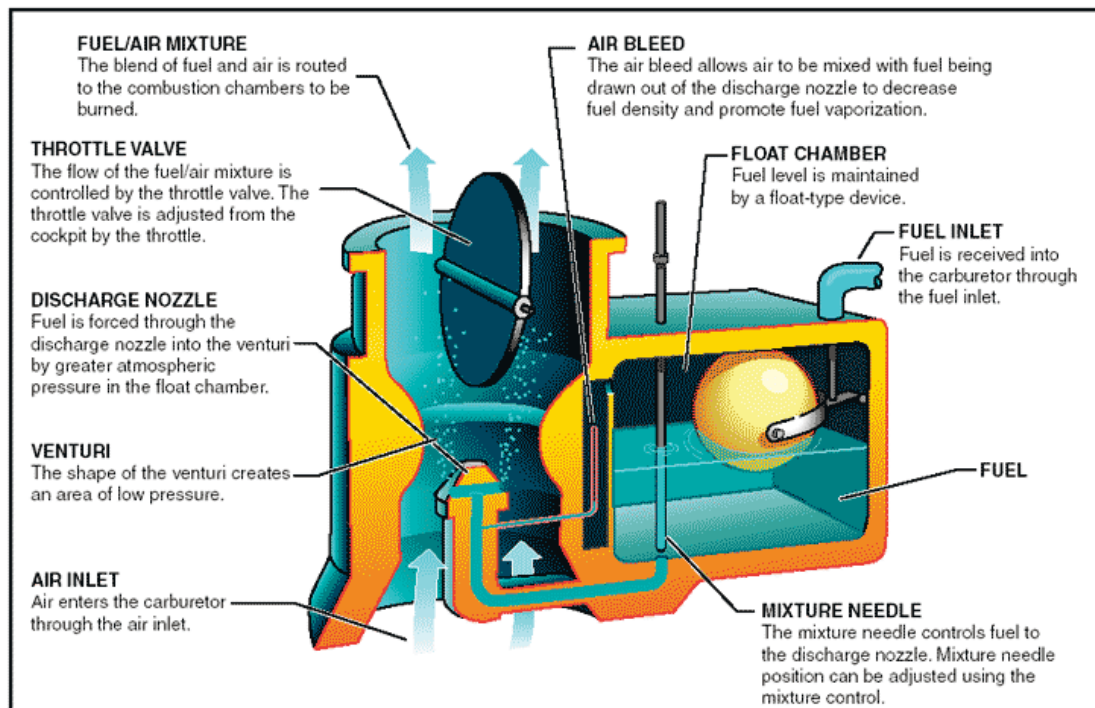

➤ Carburetor system in a piston engine aircraft

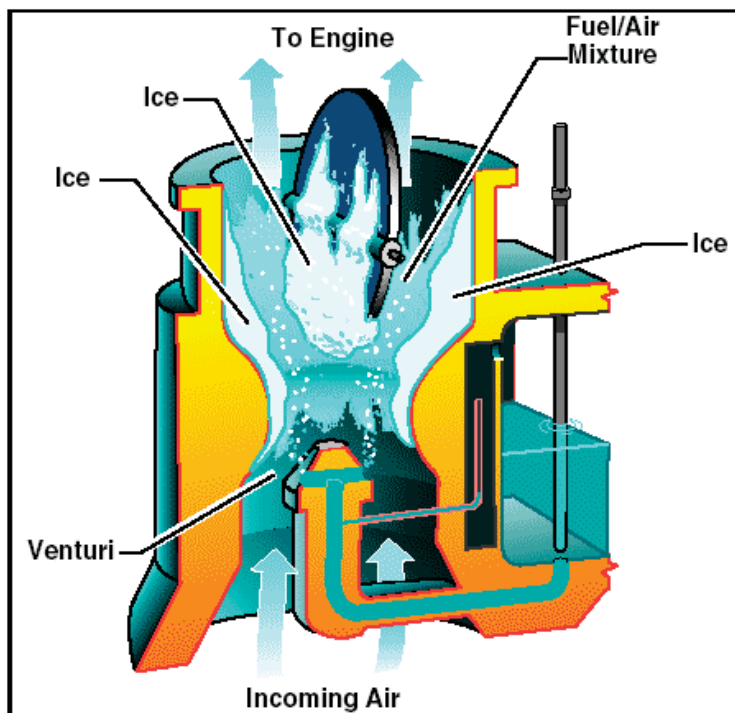

Reducing the air pressure together with the fuel vaporization contributes to decrease the temperature in the carburetor. This favors ice formation in some parts of the carburetor that reduce the volumetric flow rate to the cylinders and thus makes the engine lose power. The air can lose up to 70% of its temperature, but this percentage depends on the atmosphere humidity.

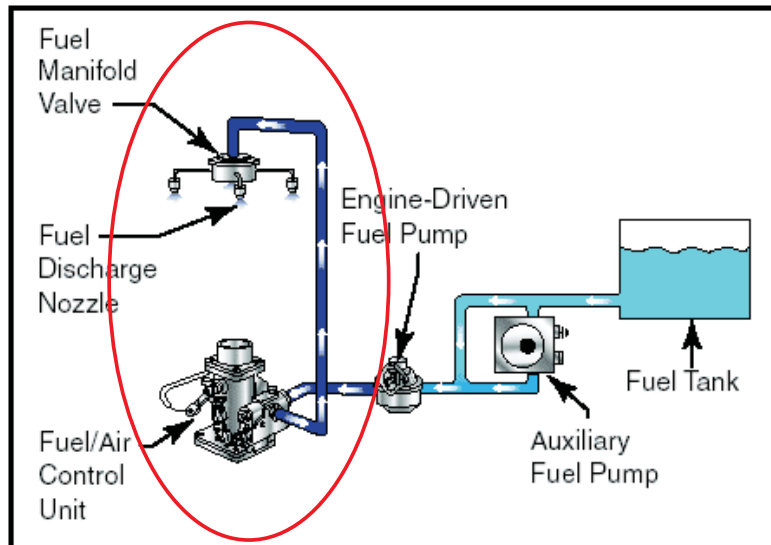

This system is replaced by one of direct injection in the cylinder (single point system or common-rail).

➤ Direct injection common-rail systems (DICR)

Piston driven aircraft have replaced their carburetor systems by DICR systems in the past few years. This has stimulated the introduction of diesel engines in modern civil aviation.

Advantages of an injection system:

- Reduction of the fuel vaporization.
- Better volumetric flow rate control
- Faster transient responses.
- Accuracy in the mixture
- Better distribution of the fuel inside the cylinder.
- Easy to turn on at low temperatures.

Disadvantages:

- More difficult to be switched on with high engine temperatures.
- Problems with the residual vapors in the cylinder when taxiing along the runway in very hot days.

- **Any hydraulic system is based on Pascal's law, which establishes that the force of a liquid over a surface is exerted in a perpendicular way to it.**

Usage: Every hydraulic system is a device that can deliver a huge force in a fast way, in order to move different elements of the aircraft.

The system is applied to move:

- Brakes
- Landing gear
- Flight control movable surfaces
- Flaps, slats, spoilers, etc...
- Movement of the propeller blades

- **The hydraulic fluids nowadays employed in aeronautics are two:**
 - Non-flammable synthetic fluids (SPERRY) (big aircraft).
 - Petrol based fluids (MIL-H-5606 and MIL-H-6083) (small aircraft)
- **Oleo strut: this kind of shock absorber strut is similar to the previous one but it consists of a cylinder, a hollow piston and a free piston that leans on a spring that replaces the gas.**

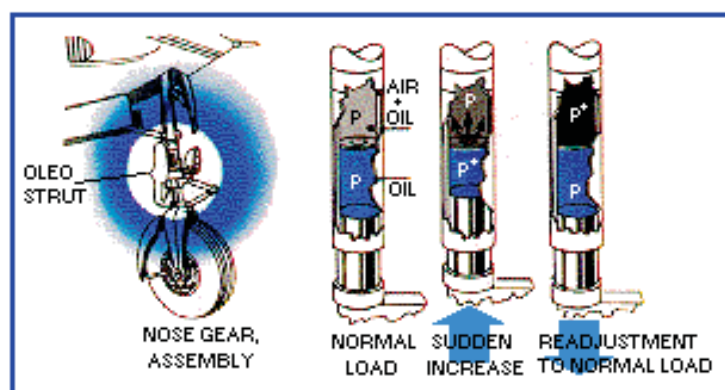

➤ The baseline hydraulic system

It consists of a reservoir, the pump (either manual, electric or engine driven), a filter to keep the valve fluid clean, the selector valve to control the flow direction, the relief valve to lighten the pressure excess and an actuator.

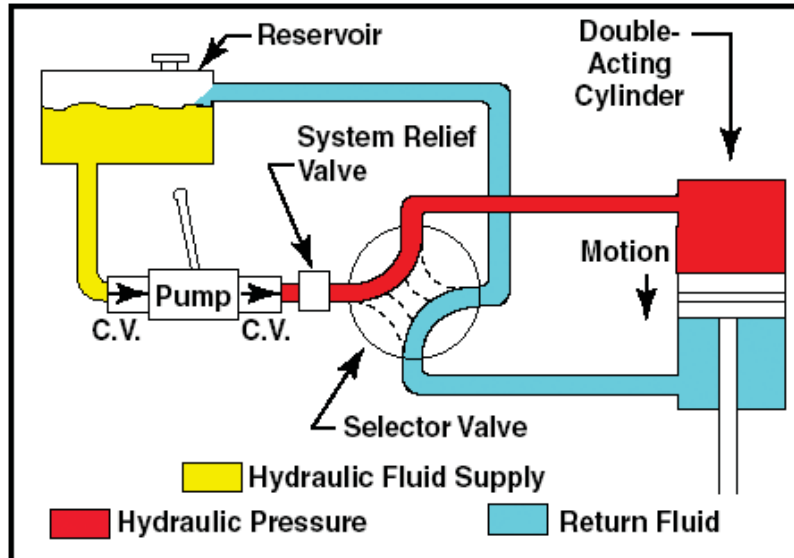

➤ Hydraulic system for flaps and slats movement

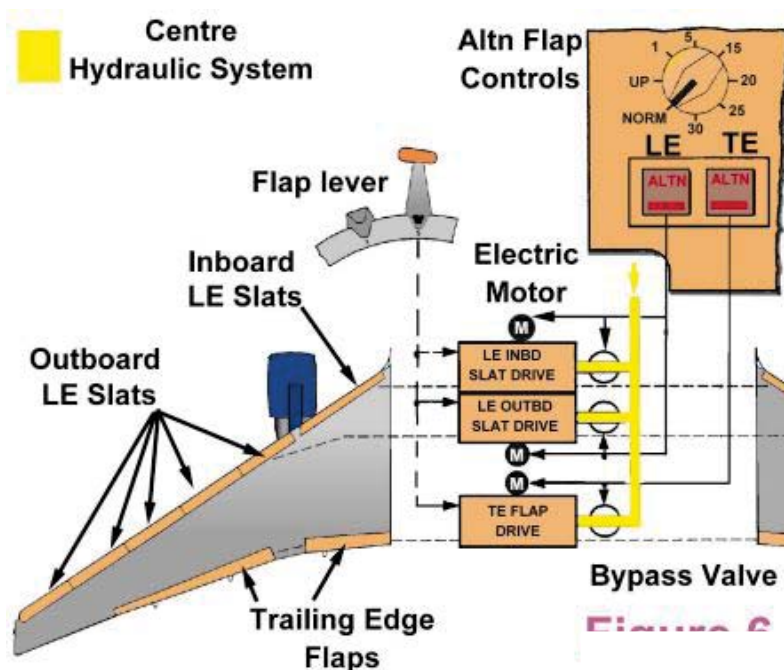

The flaps and slats movement is produced thanks to the hydraulic system that actuates on the piston that moves the opening mechanism of the elements.

➤ **Extended flaps and spoilers**

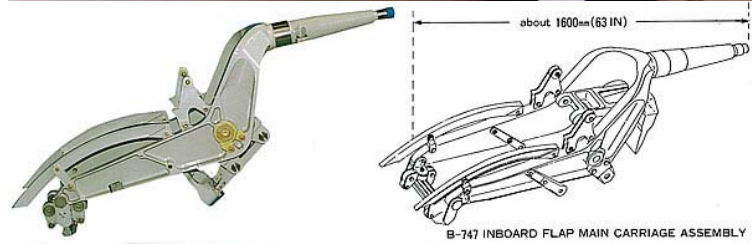

B-747 INBOARD FLAP MAIN CARRIAGE ASSEMBLY

➤ **Extended flap**

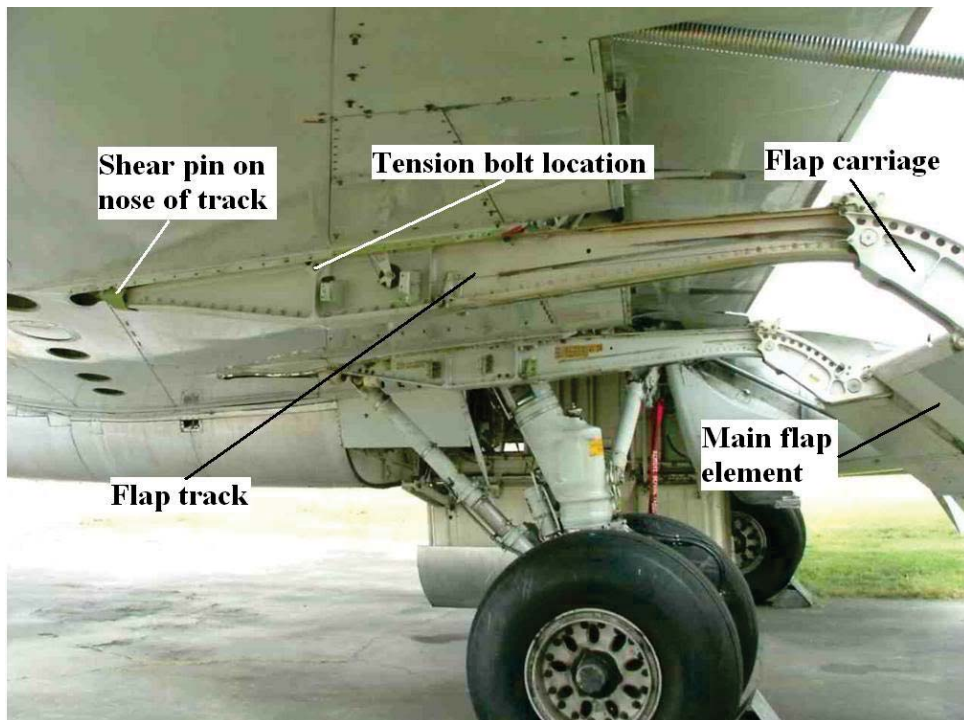

➤ Landing gear

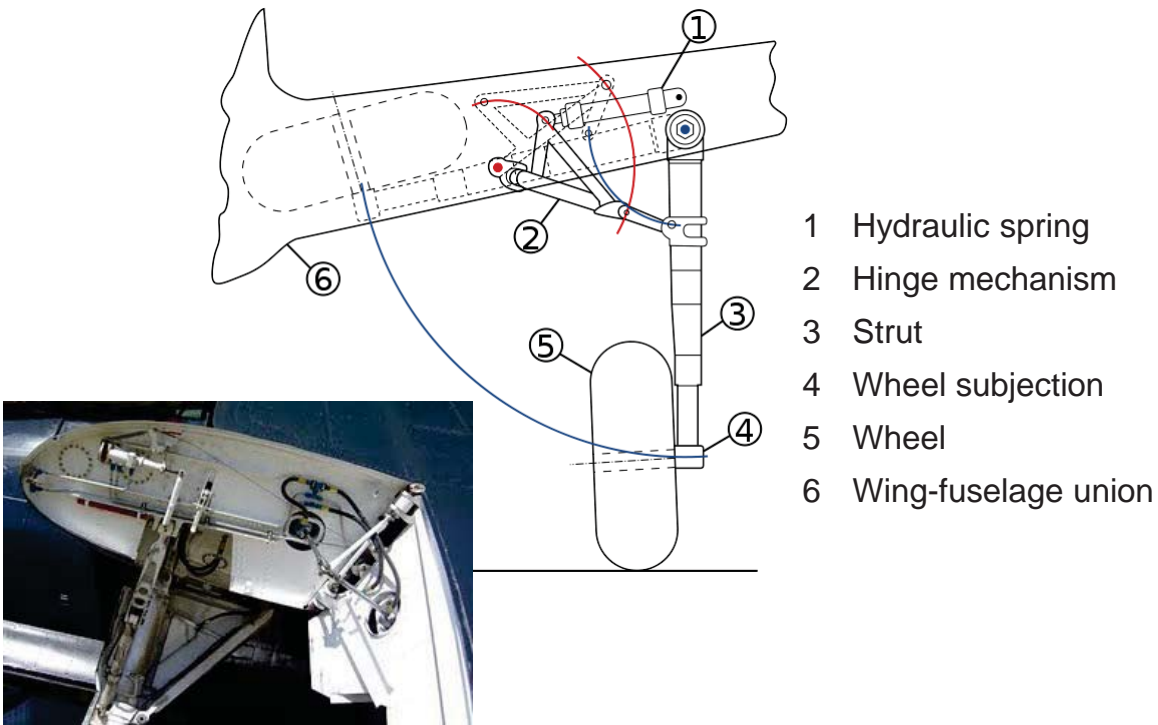

- 1 Hydraulic spring
- 2 Hinge mechanism
- 3 Strut
- 4 Wheel subjection
- 5 Wheel
- 6 Wing-fuselage union

➤ Landing gear

1. Actuador de retracción
2. bloqueo y brazo resistente
3. actuador de rotación
4. medida de extensión
5. pilar
6. cilindro de aceite
7. aceite pistón
8. viga del eje

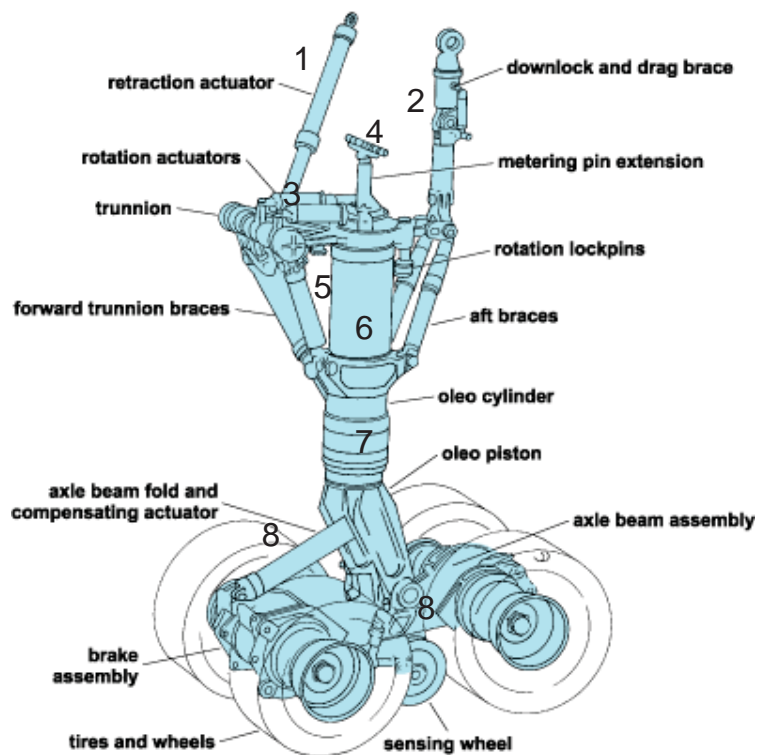

➤ Braking system

Hydraulic Braking System

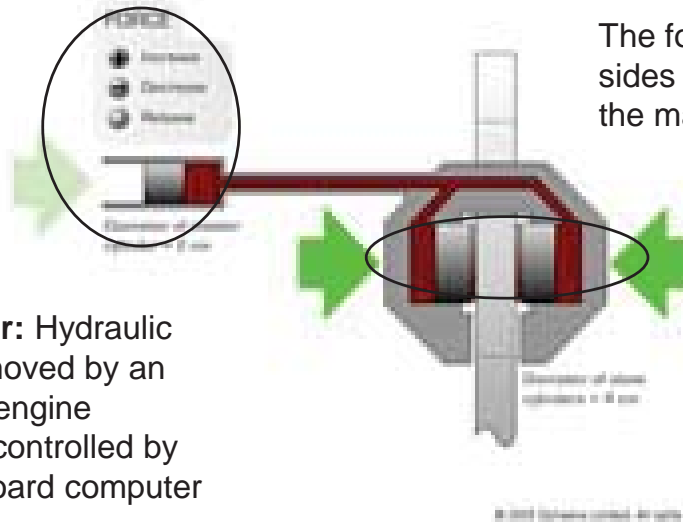

The force is applied at both sides of the disc brakes of the main gear.

Actuator: Hydraulic piston moved by an electric engine (servo) controlled by the onboard computer

➤ Rudder system

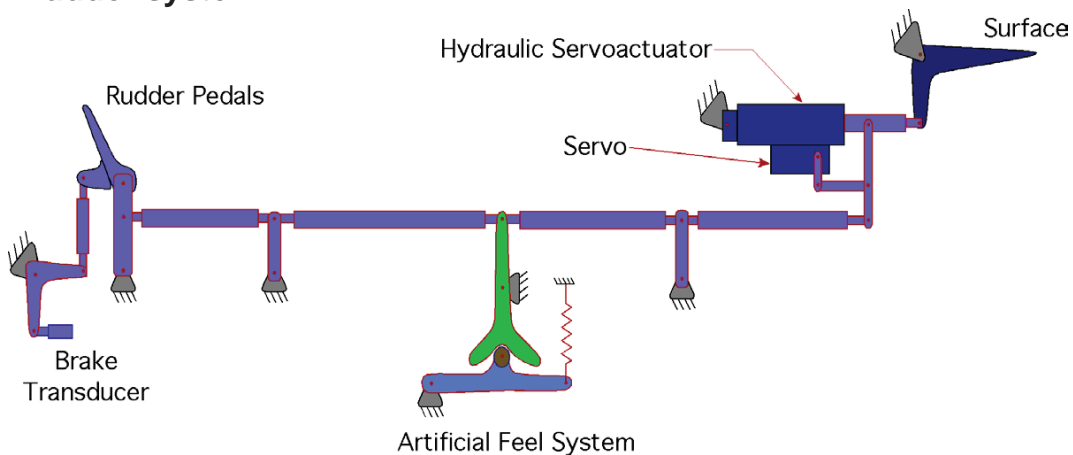

The figure shows a rudder with cranks and pushrods to connect the rudder pedals to the hydraulic servoactuator. The cranks and pushrods form four sets of bars. The artificial feel system consists of a spring cam set that produces a response force for the pilot. The wires have less stiffness than this kind of systems.

- **Keeping a comfortable cabin atmosphere for the passengers and crew in a commercial aircraft at 40,000 ft (12,000 m), facing exterior temperatures up to -60°C as well as the lack of humidity is very challenging. This requires the control of several variables such as: wind temperature, humidity, pressure, air quality control.**
- **The only air source available for the cabin conditioning is the hot pressurized air extracted from the engines. However, there are some limitations with regard to the quantity of air that can be extracted in the different stages of the flight, since the main objective of the air flowing through the engine is not the cabin conditioning but the propulsion. Thus, only a small part of the air mass flow must be bled.**

- **The cooling and air conditioning units for large aircraft are generally located in the wings. In smaller aircraft, these units can be within the aircraft body. Depending on its size, the aircraft has one or more air conditioning units.**
- **Due to FAA (Federal Aviation Administration) regulations, the cabin pressure at the maximum cruise altitude must not be less than that one equivalent to the exterior pressure at an altitude of 8,000 ft (2,500 m). In addition to the passenger comfort and temperature control, the air conditioning system controls the cabin pressurization, the air mass flow and its filtering.**

➤ The cooling systems employed in aviation are:

- **Air cycle system.** Based on the principle of heat suppression by transforming the heat energy in mechanical work. This system is employed in commercial aircraft, military carriers and fighter aircraft. It works with the air extracted from the jet engine compressor. This hot and compressed air is employed for cooling, calefaction and even cabin pressurization.
- **Steam cycle system.** It is more limited than the previous one since it only provides air cooling. It works through the evaporation of a coolant (refrigerante) in a unit very similar to that one used in the automotive industry. This system is generally used in low altitude and short distance flights.

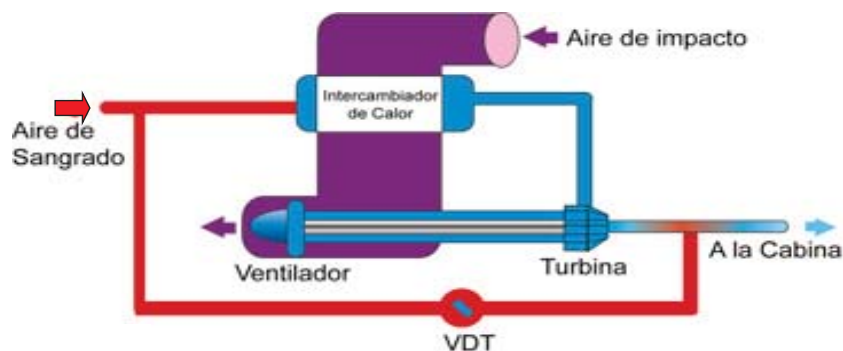

- An impact air duct linked to a gate located on the outer surface of the aircraft
- A heat exchanger
- The cooling turbine set consists of an aspirator fan and a turbine wheel, linked together through an axis. The turbine moves the fan except when the aircraft is on ground, where there is no impact air stream. In that case, the fan is moved by an electrical motor that keeps the air circulation.

- The cabin air temperature is controlled by the position of the TDV (Thermal Discharge Valve). The pilot has a control to choose the valve position, but normally the system works automatically in order to regulate the cabin temperature to a previously established value.
- If the valve is wide open, heat is sent to the cabin. This would be the typical working state of the unit in a cruise flight at a high altitude, where the aircraft experiences huge heat losses and the cabin needs calefaction.
- If the valve is mostly closed, the air coming from the unit is cold because it has mixed a small amount of hot air coming from the TDV duct. This would be the flight stage at low altitude where it is usually necessary to introduce a big amount of cold air to the cabin, so that the TDV tends to set at more closed positions.

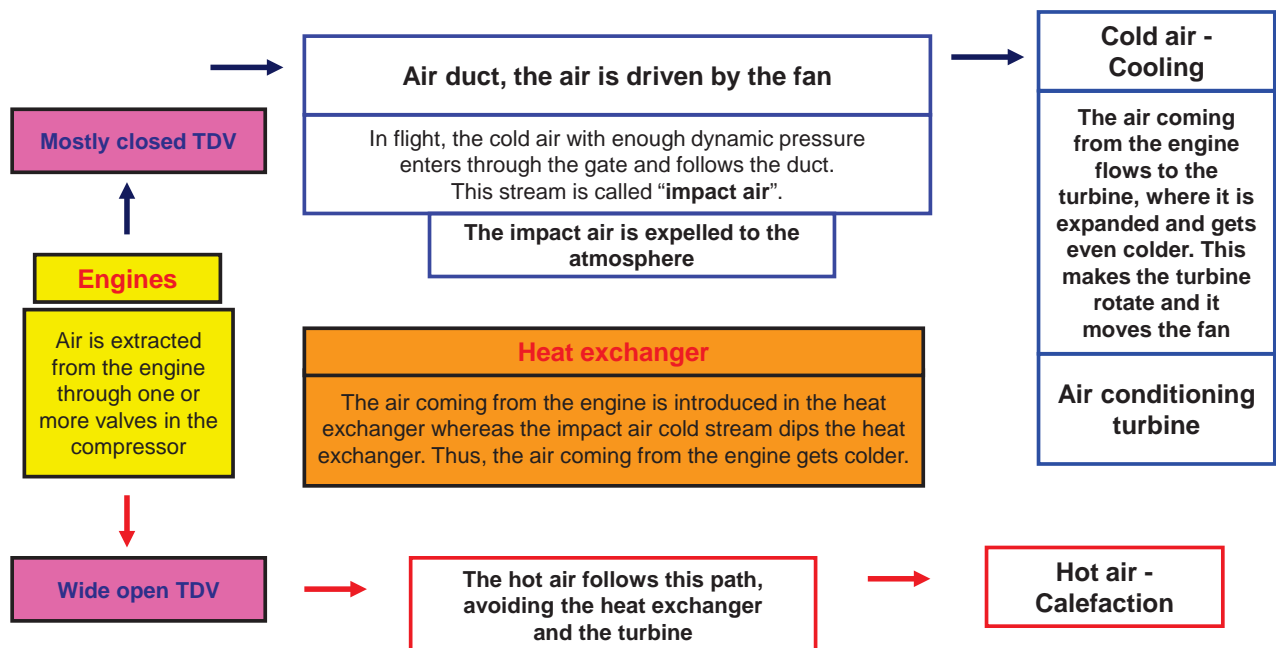

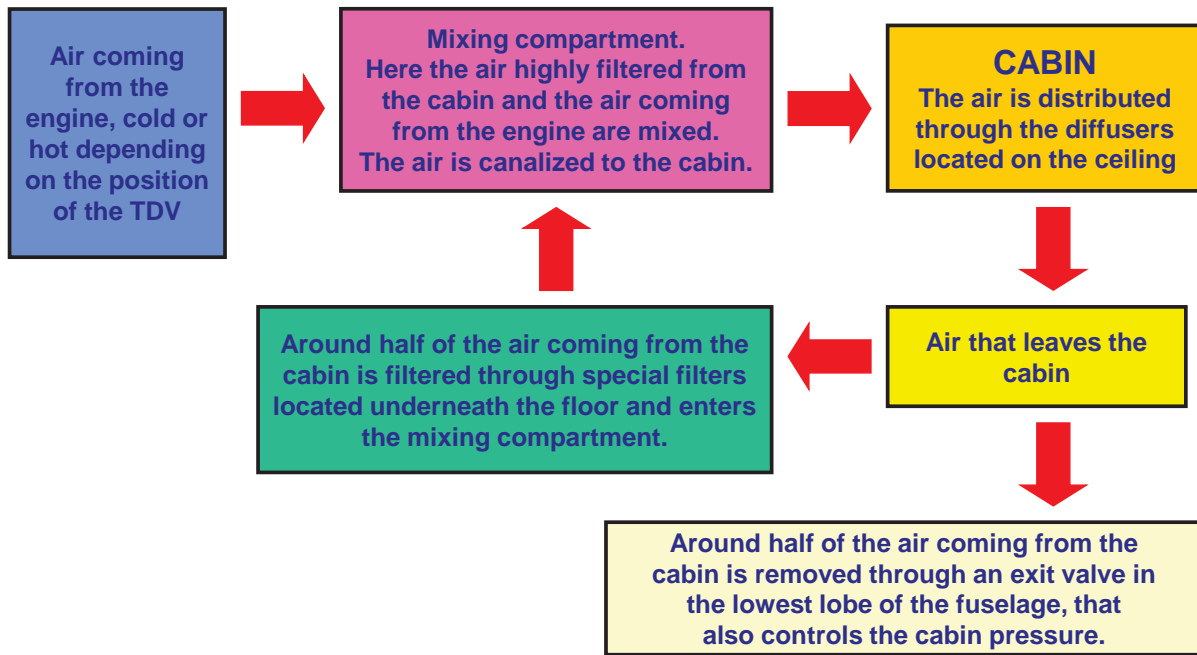

- The cabin has a huge air exchange. All the air in the cabin is replaced by the incoming mixture of exterior air and filtered air during intervals from only 2 to 3 minutes, depending on the aircraft size. This means 20 to 30 total cabin air exchanges per hour.



➤ **Kinds of heat exchangers:**

- **Plates:** Set of corrugated metal plates (stainless steel, titanium, etc.) placed inside a frame. The plates sealing is done through joints, or they can be welded.
- **Tubulars:** Bundle of corrugated or non-corrugated tubes, manufactured in diverse materials. The bundle of tubes is placed inside a housing to allow the exchange with the fluid to be heated or cooled.
- **Finned tube:** It consists of a tube or bundle of tubes where different fins are welded. These fins have different sizes and thicknesses in order to allow the exchange between fluids and gases.
- **Scraped surface:** Very similar to the tubular one, with the peculiarity that it has an helical mechanical device inside the tube that allows a fluid to go through it.

➤ **Heat exchangers**



Tubular heat exchangers

JAMCO heat exchangers



Finned tube heat exchangers



Aircraft

5 Rotorcraft. General Concepts

- **Diverse aircraft**
- **V/STOL aircraft and rotorcraft**
- **Classification of rotorcraft**
- **Comparison with other aircraft**
- **Future of the V/STOL aircraft**

- VTOL (Vertical Take Off and Landing)
- STOL (Short Take Off and Landing)
- GEV (Ground Effect Vehicle)
- Hydrofoils

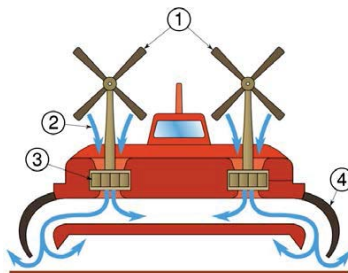

5. Rotorcraft

3



- A VTOL (Vertical Takeoff and Landing) aircraft is that one that can vertically takeoff and land, but it exhibits similar forward flight performance (actuaciones) compared to the fixed wing aircraft.
- The STOL (Short Takeoff and Landing) aircraft are those ones able to overcome an obstacle of a certain height h , after a short takeoff distance d . There exist different criteria for the values of h and d , but the most accepted ones are $h = 50$ ft and $d = 500$ ft.
- Rotorcraft: Aircraft in which all or part of the lift force required in flight is obtained through one or more rotors.

5. Rotorcraft

4



- **Same powerplant for takeoff, landing and cruise**
 - Tilt Shaft/Rotor (orientable shaft/rotor)

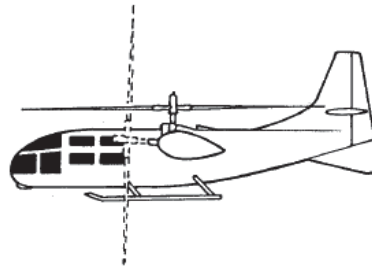

Transcendental Model G1 (1954)



Bell XV-3 (1955)



- **Same powerplant for takeoff, landing and cruise**
 - Tilt Prop (orientable propeller)

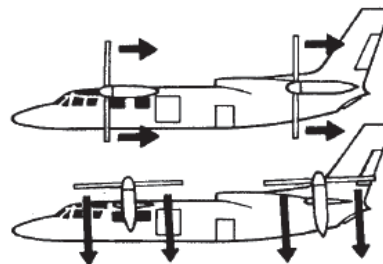

Curtiss-Wright X-100 (1959)



Curtiss-Wright X-19 (1963)



- Same powerplant for takeoff, landing and cruise
 - Tilt Duct (propeller with orientable diffuser)

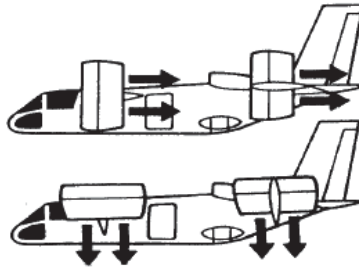

Doak 16 VZ-4 (1957)

Bell X-22A (1966)

Nord 500 Cadet (1968)

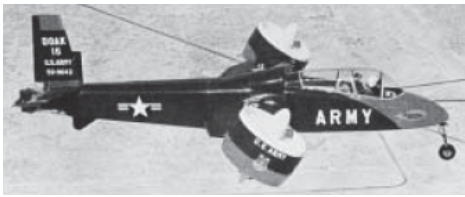

- Same powerplant for takeoff, landing and cruise
 - Tilt Wing (orientable wing)

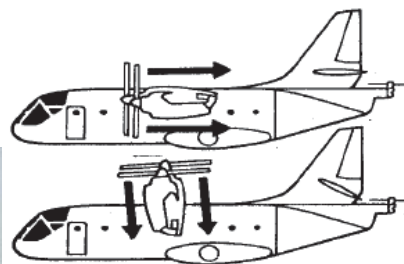

Vertol 76 VZ-2 (1957)

Hiller X-18 (1958)



LTV-Hiller-Ryan XC-142 (1964)

Canadair CL-84 Dynavert (1965)



- **Same powerplant for takeoff, landing and cruise**
 - Tilt Rotor (orientable rotor-engine)

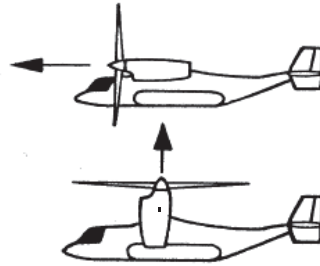

Bell XV-15 (1977)



Boeing-Bell X-22 Osprey (1985)



- **Same powerplant for takeoff, landing and cruise**
 - Tilt Jet (orientable jet)

Bell 65 Air Test Vehicle (ATV)



- **Same powerplant for takeoff, landing and cruise**
 - Deflected Slipstream. Coanda effect

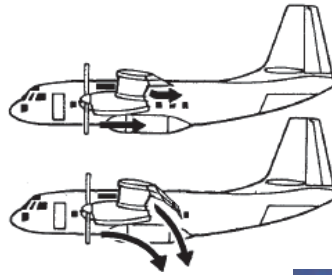

Robertson VTOL (1956)

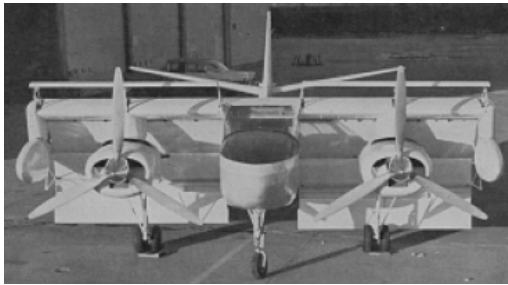

Ryan 92 VZ-3 Vertiplane (1959)



- **Same powerplant for takeoff, landing and cruise**
 - Vectored Thrust

Bell X-14 (1957)

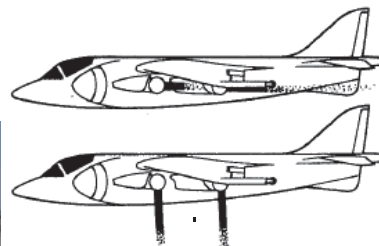

Yakovlev Yak-36 Freehand (1963)



Hawker P.1127 Kestrel (1960)



Boeing X-32B (2001)



British Aerospace/Boeing Harrier (1966)



➤ Same powerplant for takeoff, landing and cruise

- Tail Sitters

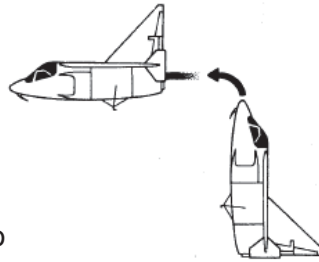

Snecma C450 Coléoptère (1959)

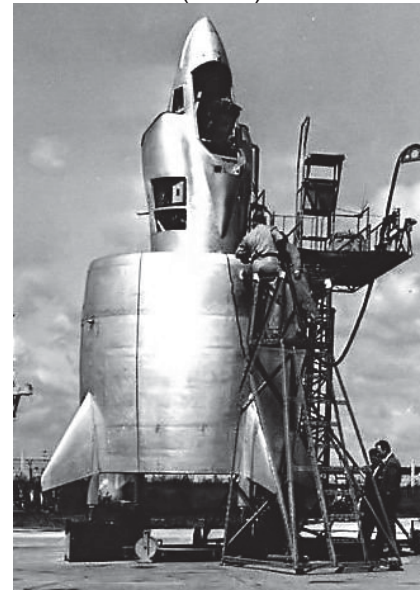

Lockheed XFV-1 (1954) Convair XFV-1 Pogo (1954)



Ryan X-13 Vertijet (1955)



➤ Different powerplants for fixed point flight (takeoff and landing) and cruise.

- Lift+Cruise

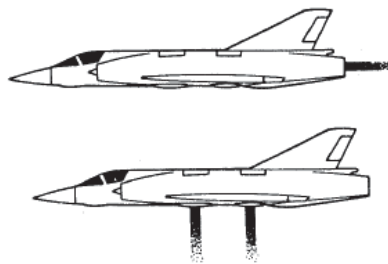

Dassault Balzac V (1962)



Short SC1

Dassault Mirage III V (1965)



➤ **Different powerplants for fixed point flight (takeoff and landing) and cruise.**

- Lift+Lift/Cruise

Dornier DO31 (1967)

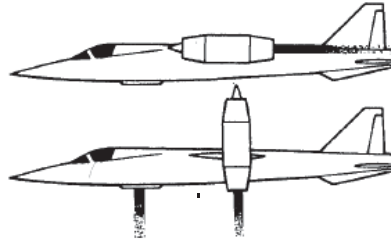

Yakovlev Yak-38 Forger (1972)



Lockheed XV-4B Hummingbird II (1964)



EWR VJ101C (1963)



Yakovlev Yak-141 Freestyle (1972)



VFW VAK 191B (1971)



➤ **Different powerplants for fixed point flight (takeoff and landing) and cruise.**

- Tip Jet

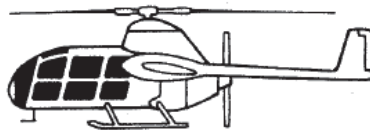

McDonnell XV-1 (1954)



Fairey Rotodyne (1957)



➤ Enhanced propulsion in fixed point flight (takeoff and landing)

- Ejector

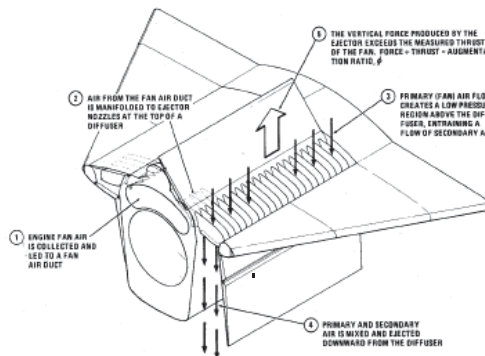

Lockheed XV-4A Hummingbird (1962)



Rockwell XTV-12A (1974)



➤ Enhanced propulsion in fixed point flight (takeoff and landing)

- Fan

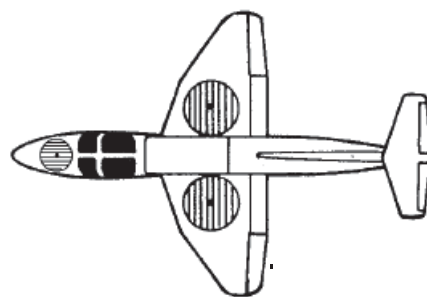

GE-Ryan XV-5A Vertifan (1964)



Vanguard Omniplane (1962)



Lockheed Martin X-35 (1993)



➤ Enhanced propulsion in fixed point flight (takeoff and landing)

- Rotor

Piasecki 16H-1 Pathfinder (1962)

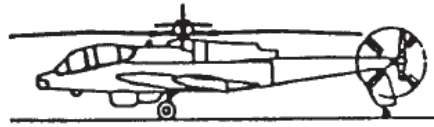

Kamov Ka-22 Vintokryl 'Hoop' (1960)



Lockheed AH-56 Cheyenne (1967)



➤ VSTOL Aircraft Classification

Conceptual demonstrators of the Joint Strike Fighter Programme
Aircraft that have been operated

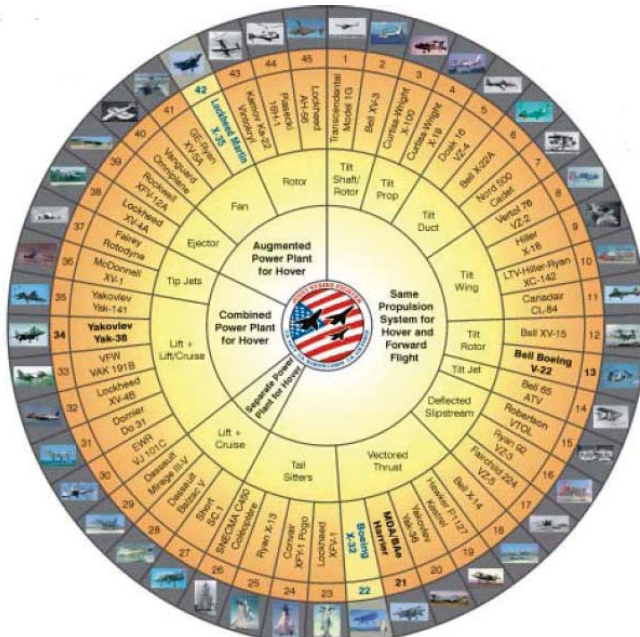

<http://www.vstol.org/>

➤ A particular case: the Helicopter

We consider it a VTOL, although it is a special case as it has limitations in forward flight, attending to its cruise speed when compared to the fixed wing aircraft.

➤ Features:

- The best in fixed point and steady flight
- Acceptable performance in forward flight. Stall at high V
- Autorotation

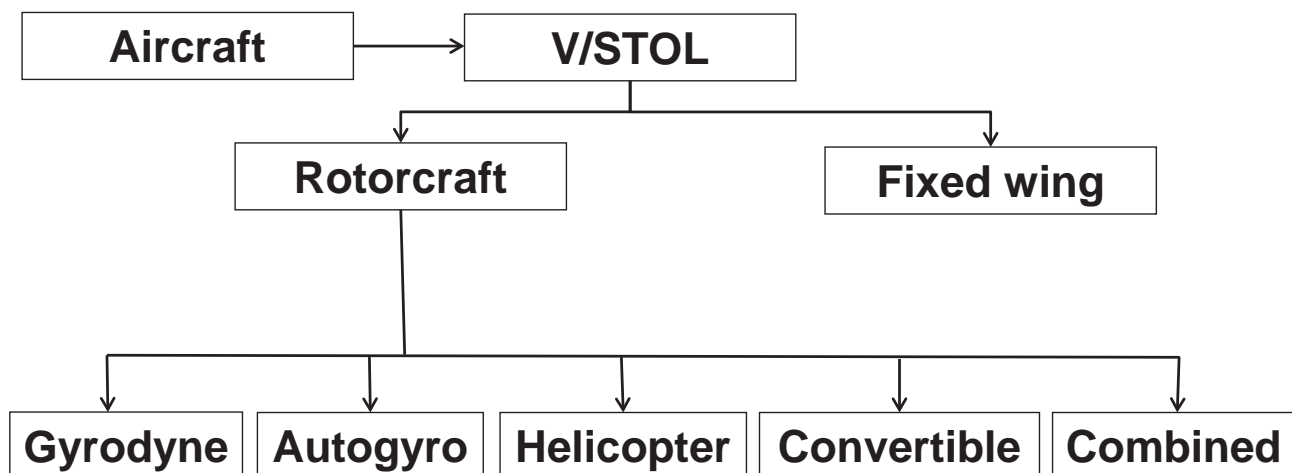

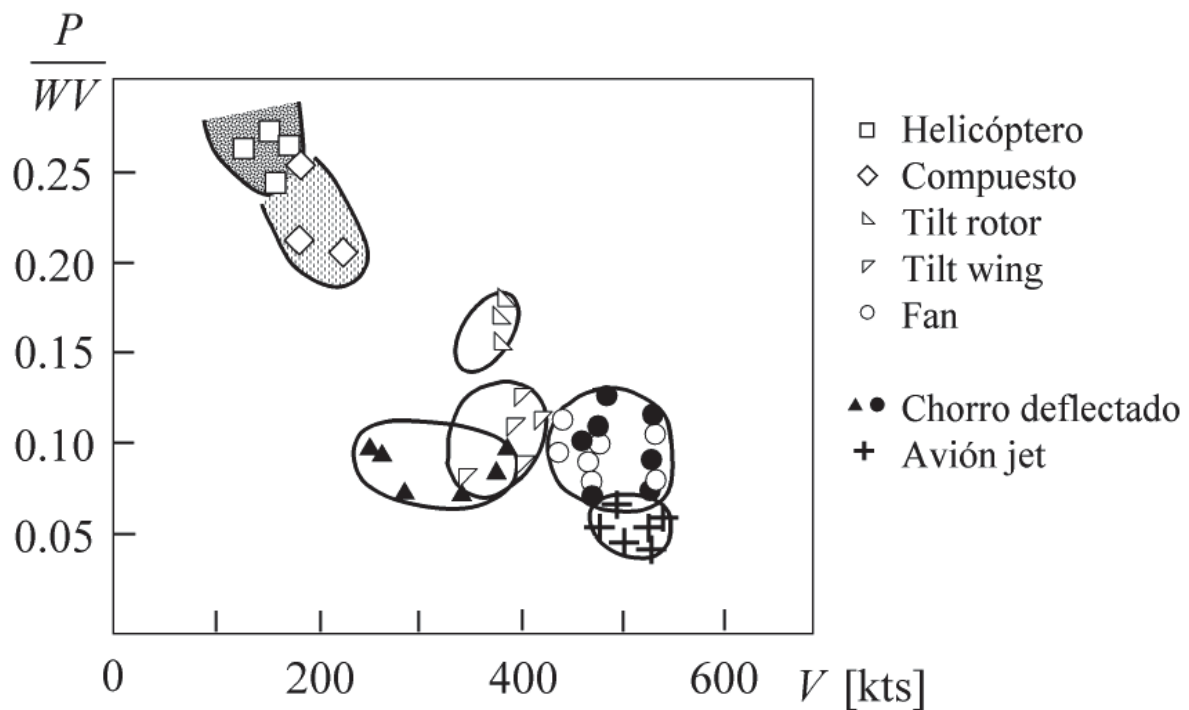
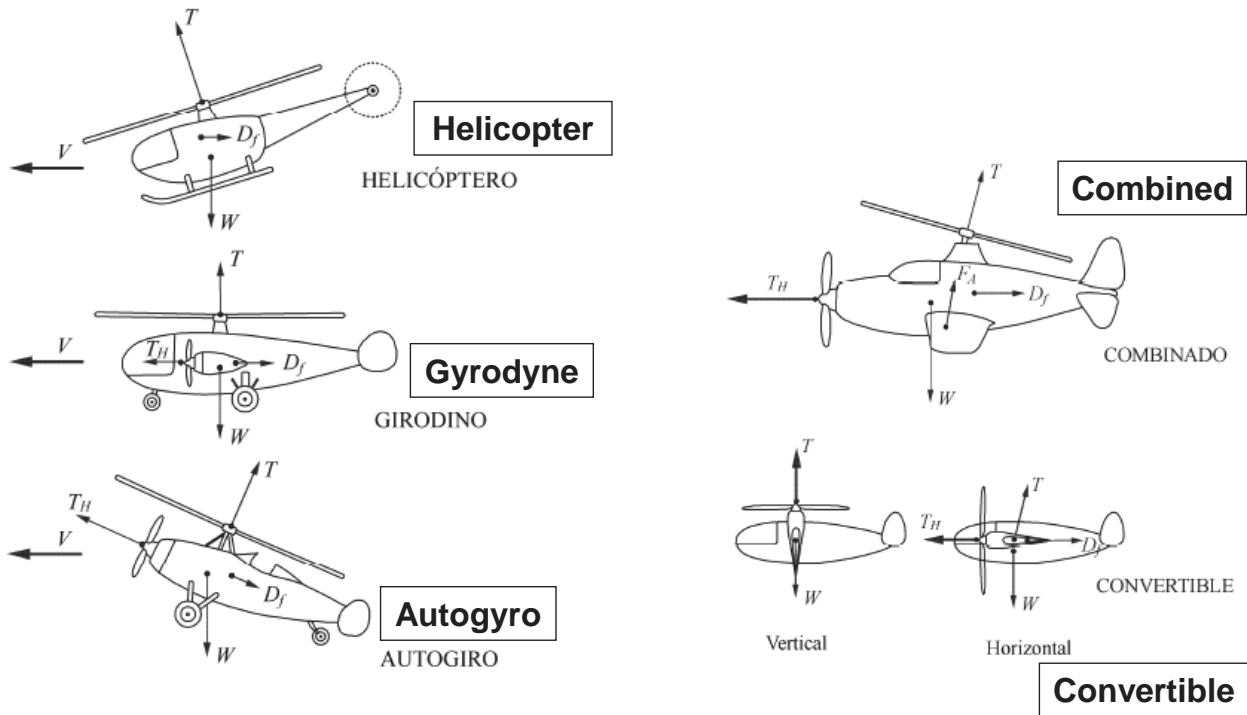

➤ Von Karman-Gabrielli diagram.

W is the vehicle weight, P the power and V the cruise velocity.

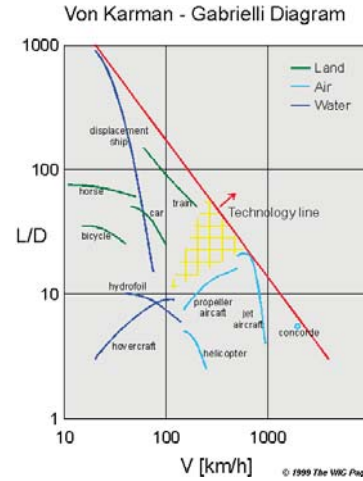
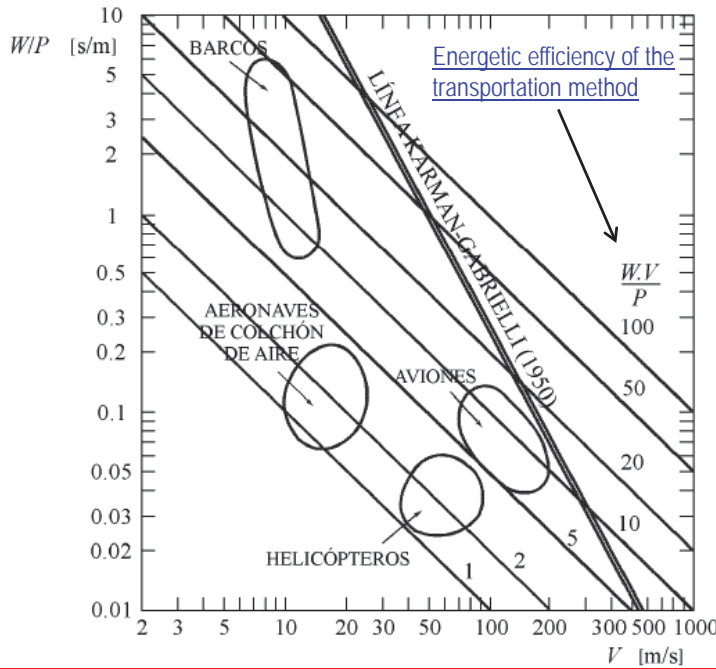

➤ Characteristic range: distance that the vehicle could travel with a quantity of fuel equal to its weight.

Alcance característico R [millas]

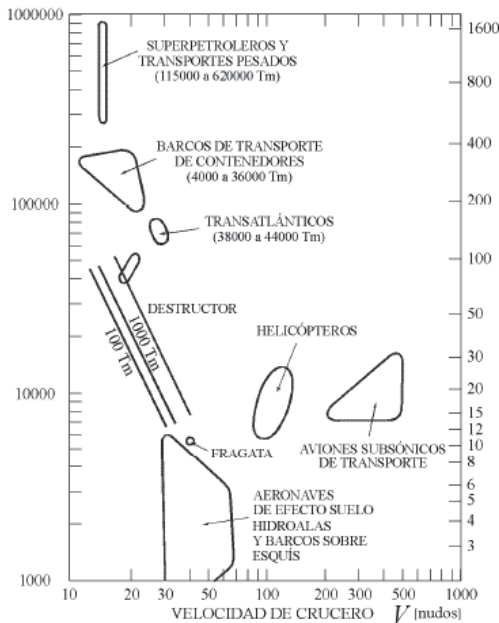

Characteristic range as a function of the cruise speed

➤ Variation of the thrust/power ratio with respect to the disk loading

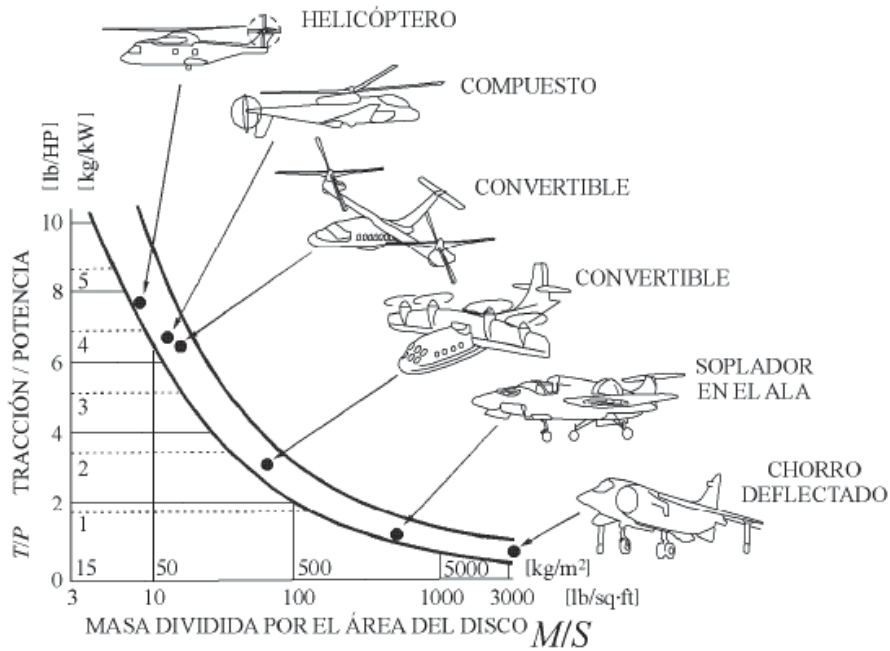

➤ Flight envelope for different aircraft
(Altitude – Flight speed chart)

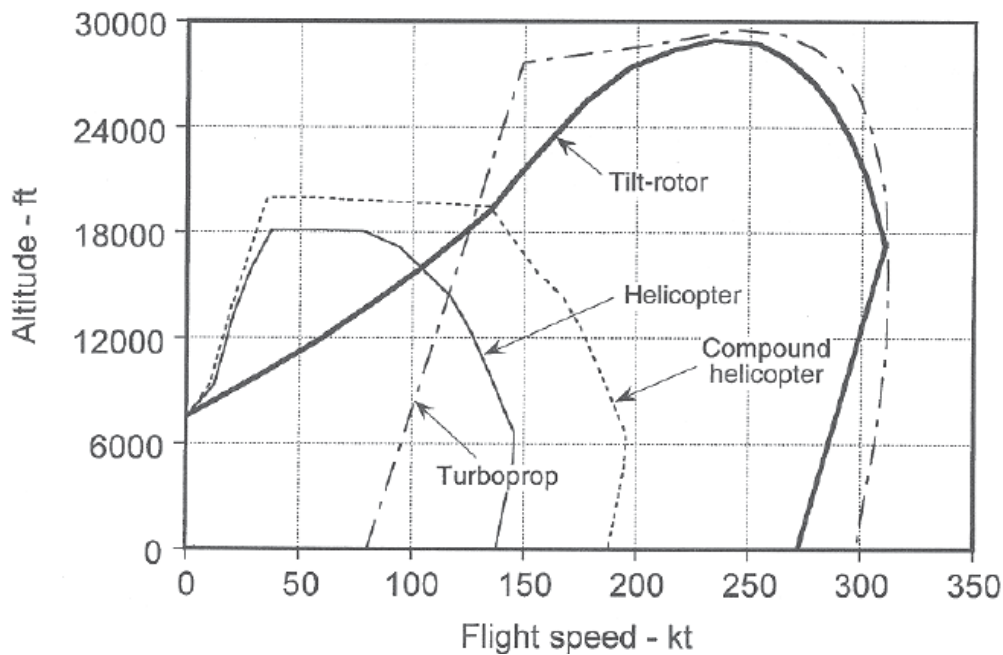

➤ Power curve

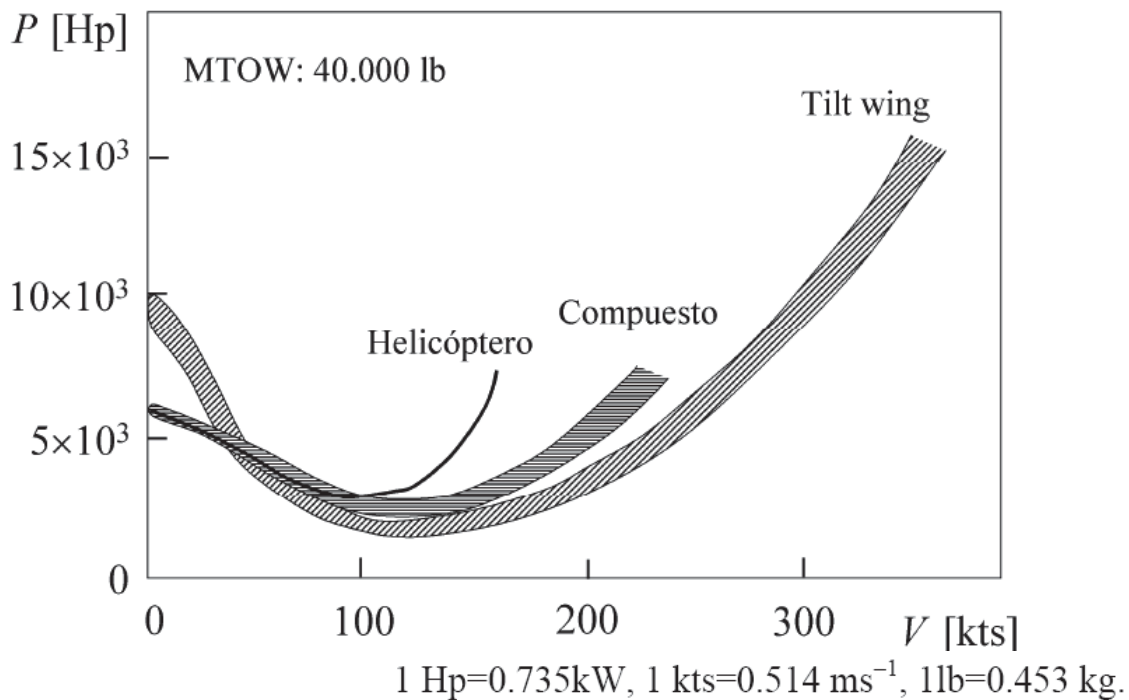

- Multiple options have been evaluated, some more seriously than others.
- Problems in the transition.
- It is required to enhance the reliability of the driving and mechanical systems.
- Appropriate powerplant.
- Limitations of the volume that is available for the powerplant.
- Stability and control problems.
- Vibrations.
- Funding.

- **Trends of the future helicopters**
- **Structural materials.**
- **Rotorheads. Flexible elements.**
- **Blades. Composite materials. Variable planform.**
- **Control system. Fly by wire. Increase in reliability.**
- **Turboshaft engines.**
- **Cabin instruments. EFIS new generation and multifunction MFD screens. Better flexibility and reliability.**

Joint Strike Fighter



Lockheed Martin X-35

Tilt Rotor



Bell Boeing V-22

Bell Agusta 609



Aircraft

6 Rotorcraft Aerodynamics. Definitions and aerodynamic forces

6. Rotorcraft Aerodynamics

1



Index

- **The development of the helicopter**
- **Aerodynamic complexity**
- **Helicopter flight dynamics**
- **Helicopter architecture**
- **Main design parameters in helicopters**

6. Rotorcraft Aerodynamics

2



- **The idea of using rotating wings arose before the fixed wing concept**
- **Critical points in the development of the helicopter**
 - To understand the aerodynamics of the vertical flight. First developments in 1920s.
 - Necessity of having an appropriate powerplant. Internal combustion engine, at the beginning of the 20th century.
 - To minimize the structural and engine weight. Weight-power ratio. Usage of aluminum.
 - To solve the problem of the reaction torque introduced by the main rotor. Double rotor (coaxial or side-to-side). Anti-torque rotor (Sikorsky).
 - Adequate controlability and stability. Asymmetry in the blades aerodynamics. Introduction of joints (Cierva, Breguet and others). Cyclic pitch control.
 - To solve vibrations problems. Dynamics and aero stability of the rotors.

- **Historical milestones**
 - Chinese toys 400 b.C.
 - Leonardo da Vinci 1483 (aerial screw)
 - Mikhail Lomonosov 1754
 - Launoy y Bienvenu 1738
 - Sir George Cayley 1790 (aerial carriage)
 - Horatio Phillips 1840 (motorized model)
 - Ponton d'Amecourt 1860 invents the name
 - Wilhelm von Achenbach 1874 uses anti-torque rotor
 - Thomas Alva Edison 1880
 - Rankine and Froude. 1865-1889. Momentum Theory (Disk Actuator Theory)
 - Development of reciprocating engines.
 - Drzewiecky: Precursor of the Blade Element Theory (BET).
 - Paul Cornu 1907. First manned flight (4 years after the Wright brothers).

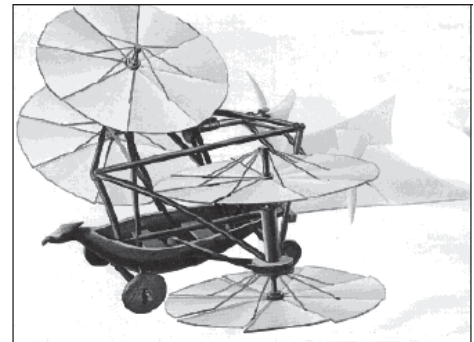

➤ **Historical milestones**

- Louis and Jacques Breguet 1907. Methodize experiments. Advance in the theory.
- Igor Ivanovitch Sikorsky and Boris Yur'ev 1910. Cyclic pitch control.
- Joukowski. 1910. Vortex theory.
- Jen C. Ellehammer 1914. Coaxial helicopter
- Stephan Petroczy 1917-1929. Coaxial
- Theodore von Kármán. 1917 Scientific experiments
- William F. Durand. 1920. Scientific experiments
- H. Glauert, E. Pistolesi and S. Kawada. 1922-1926. First applications of the Vortex Theory.
- Betz, Goldstein, Prandtl. 1927. Integration of the optimum wake.
- de la Cierva and Southwell 1921-1926. Establish and solve the flapping equation (fully articulated rotor).

➤ **Historical milestones**

- Raul Pescara 1922
- Juan de la Cierva (Renard 1904, Breguet, 1908). 1923 Oscillation articulation C4.

➤ **Important successes**

- Louis Breguet and Rene Dorand: 1930-1935 Control, swashplate.
- Heinrich Focke 1933
- Antoine Flettner Colibrí. 1940.
- Igor Sikorsky 1938

➤ **First machines in production**

- Sikorsky's R-4 and R-5 1941
- Cierva-Wier (W-9). 1944. Anti-torque jet.
- Piaseky 1945, first tandem helicopter.
- Arthur Young. Airworthiness certificate Bell Model 47. 1957
- Loewi 1950. Bidimensional linearized unsteady theory for the problem of the wake that comes back, following the steps established previously for the case of a straight wake by Theodorsen, Sears, Lomax or Jones..
- Flight mechanics, 1950 stability.
- Gyrodino.
- Kaman K-225 -1955. Turboshaft.
- 1970, 1980... Aerodynamic models based on the vortex theory, by Langrebe, Kokurec and Leishman.



➤ **Until today...**

- Hess, Caradona and Morino.1980... boost the potential models. The models based on the vorticity transport equation, specially indicated for the lifting problem, are developed by R. Brown. Applications of the simplified Navier-Stokes Equations (LES, RANS).
- The development of this technology has made it possible to establish the takeoff weight record in 100.000 kg with the tandem helicopter Mil V-12. In 1986 the velocity record was established in 400.55 km/h with a Westland Lynx helicopter modified with special blades (British Experimental Rotor Programme (BERP)).
- 2000... Studies of non-linear stability of the aircraft or rotor based in bifurcation methods are growing nowadays thanks to authors such as Basset or Prasat.

➤ **Until today...**

- 2000... Methods of multiobjective optimization are breaking into scene thanks to the work of authors such as R. Celi.
- The integration of dynamic, structural and aerodynamic advanced models is nowadays in what we could consider as the state of the art. The combination of advanced aerodynamic models in simulations of flight mechanics, require hybridization techniques, which consist in dividing the flow field within regions where different precision is required, in order to reduce the computational time to acceptable levels.
- In 2005 the altitude record in fixed point flight was established by an Ecureuil/AStar AS 350 B3, which was landed on the Mount Everest summit at 8.850 m.

- **The velocity field over the airfoils varies due to the rotation. Dependance on r and ψ .**

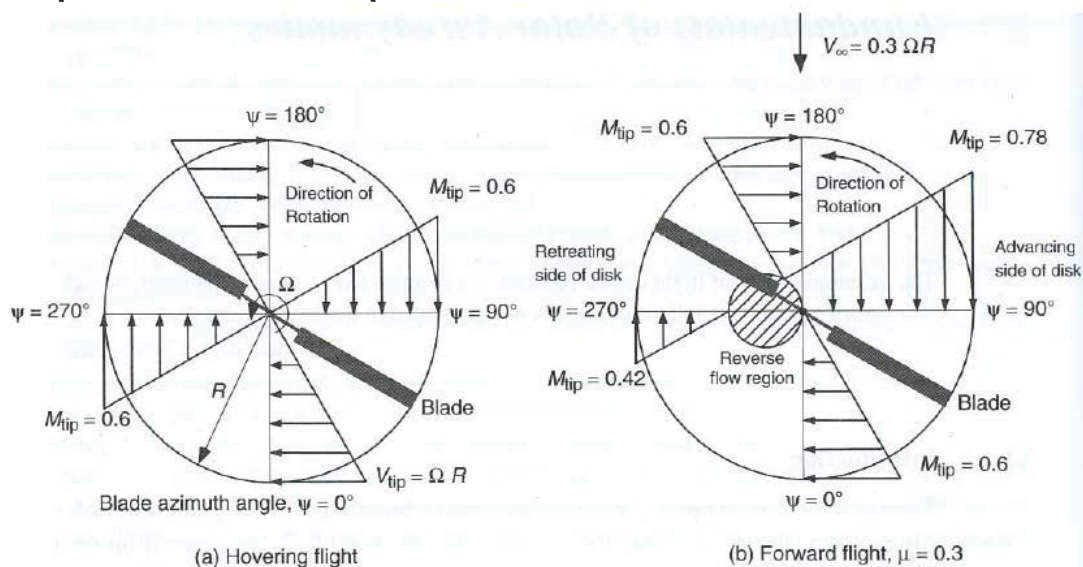

Field of U_T tangential velocities, for a situation of fixed point flight (a) and flight in the plane of the disk (b). *Leishman, J. G., Principles of Helicopter Aerodynamics, Cambridge aerospace series. Cambridge University Press, Cambridge, 2000.*

➤ Definition of the angles of the blades of a helicopter:

The rotor acts in a helical shape. Its union with the rotorhead is not rigid, but articulated.

Thanks to the articulation, the different movements can be imposed:

- **Flap angle:** over the disk plane one blade moves up and the other moves down.
- **Lag angle:** variation of the angle in the forward movement of the blade
- **Pitch angle:** variation of the angle of the blade in the longitudinal way
- **Coning angle:** variation of the angle normal to the rotor axis (V)

➤ The problem gets more complicated...

- Maneuvering in flight.
- Movement of the blades as a rigid body: lagging and drag articulations.
- Flexibility of the blade structure.
- Interaction with the rest of the helicopter structure and with the own vortices de-attached from a previous blade.

➤ Necessity of coupling the aerodynamic, mechanical and structural problems: aero-mechanics and aero elasticity.

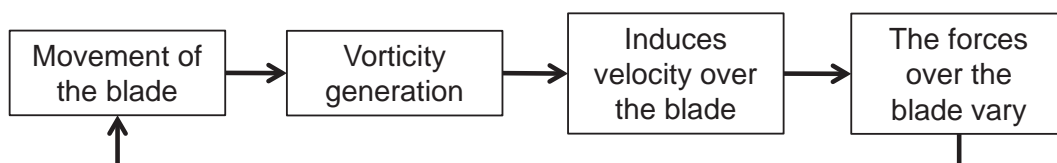

➤ **Aerodynamic complex phenomena**

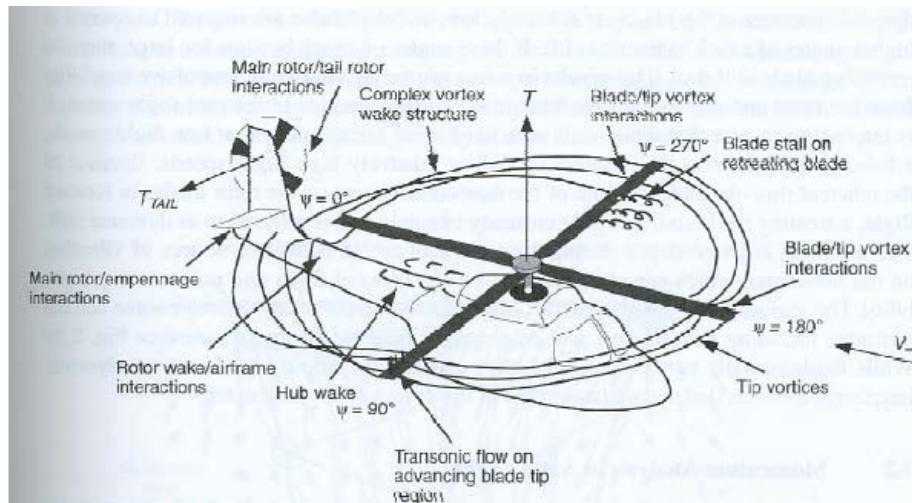

Scheme of the complex aerodynamic phenomena that take place in a helicopter rotor in forward flight: **rotor-antitorque rotor interaction, wake configuration, blade-vortex interaction, stall of the retreating zone, transonic flow on the blade tip, fuselage interaction.** *Leishman, J. G., Principles of Helicopter Aerodynamics.*

➤ **Aerodynamic analysis: to know the vorticity distribution**

The wake of the rotors is shaped by vorticity surfaces and eddies filaments

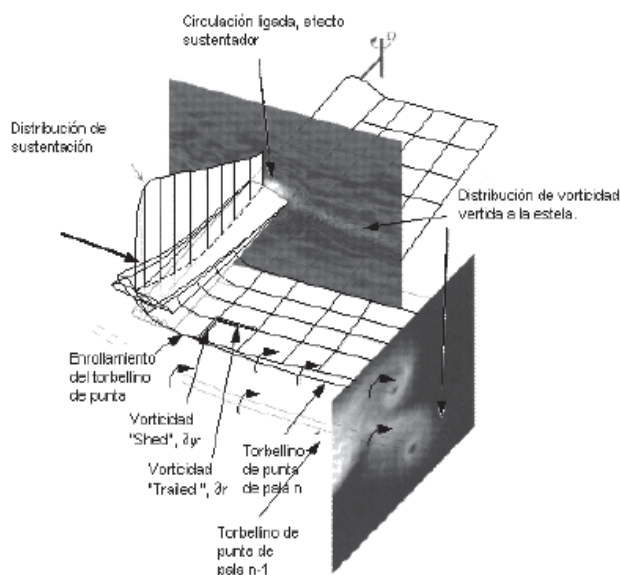

Vorticity:

- "Shed" (vorticity transversal to the U_T velocity) azimuthal variations of the circulation.
- "Trailed" radial variations of the linked circulation distribution.

Blade tip vortex (eddy): it is the vorticity structure that influences the induced velocity in the wake in a more important way.

Leishman, J. G., Principles of Helicopter Aerodynamics.

➤ Wake in ascendant flight

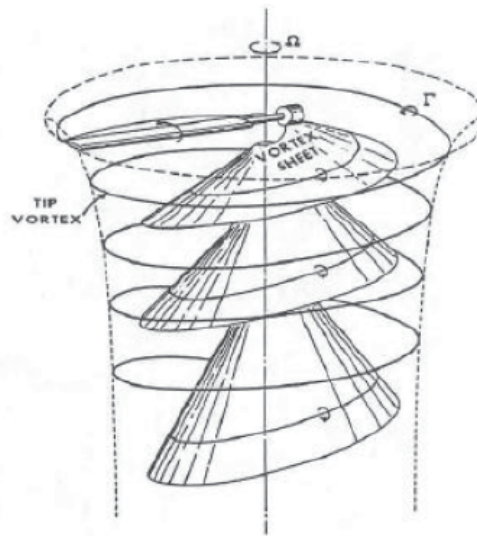

Scheme of the wake of a single blade rotor in ascendant flight. The tip vortex and the intermediate vorticity surface can be observed.

➤ Importance of the wake. Induced velocity.

- Generation of lift associated to the circulation distribution linked to it (it will vary with the radial and azimuthal position).
- Variations of circulation are associated to a generation of vorticity in the wake (Lanchester-Prandtl wing theory) being very intense in the blade tip (blade tip vortex).
- The vorticity structures induce velocity in all the flow field.
- The airfoil will not “see” ωr , v_i will also need to be considered.

➤ Key of the aerodynamic problem: determine v_i .

- Momentum Theory (Disk Actuator Theory)
- Vortex theories (like the Lanchester-Prandtl wing theory)
- Direct simulation of the Euler and N-S equations.

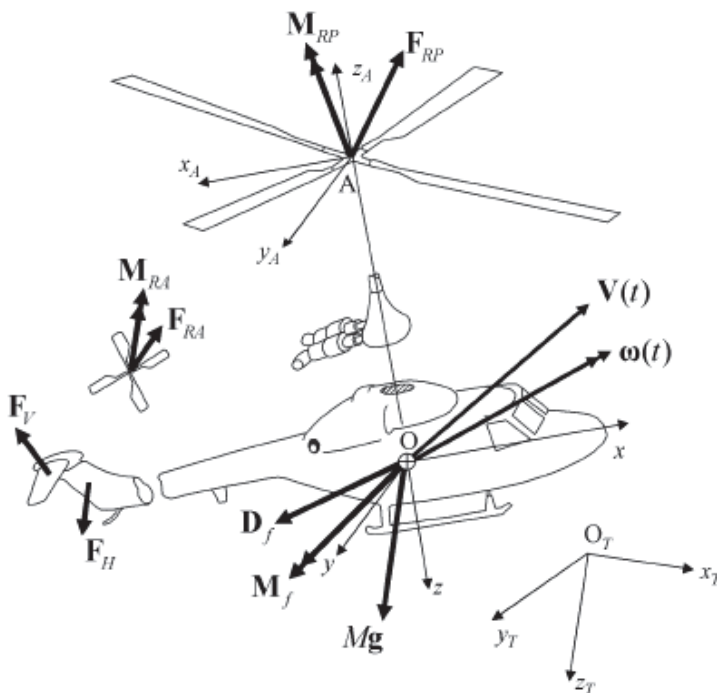

Main forces and moments:

- Main rotor
- Anti-torque rotor
- Fuselage
- Stabilizers

Forces and moments that intervene in the helicopter dynamics. *Padfield, G. D., Helicopter Flight Dynamics. Blackwell Scientific Oxford, 1996.*

➤ Components

- Structure or cell
- Main rotor or rotors
- Control system
- Anti-torque system
- Dragging system (Sistema de arrastre) (powerplant)
- Other systems:
 - Hydraulics, help in the control.
 - Fuel.
 - Electrics, A/C and/or D/C generators.
 - Lubrication (gearboxes)
 - Flight instruments, navigation.
 - Ventilation and air conditioning.
 - Fire protection systems.
 - Lighting (internal and external)
 - Accessories: crane, hook, stretchers, fixed landing gear...

➤ **Components**

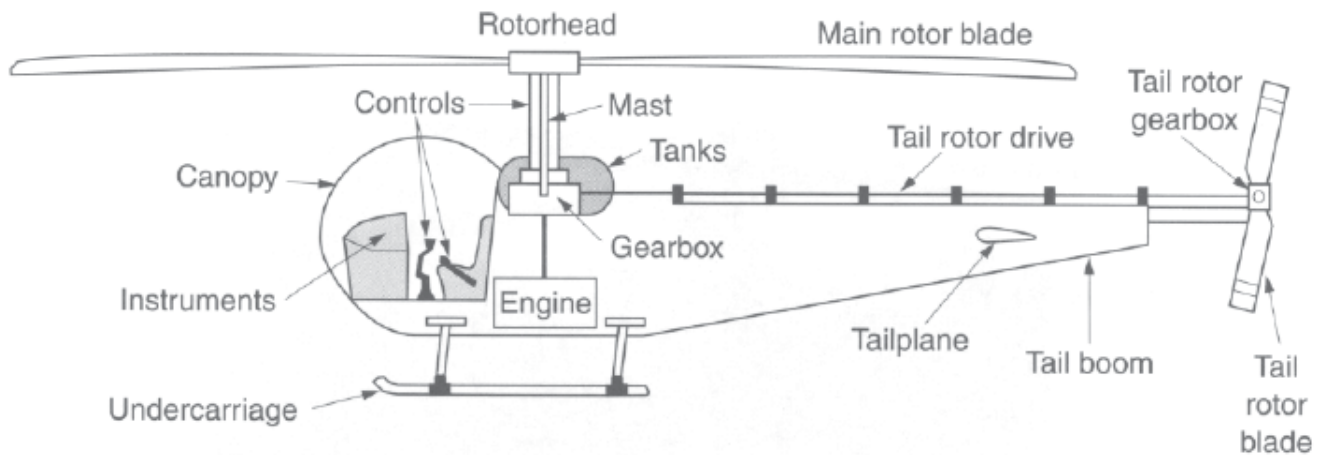

➤ **Structure or cell:**

- Fuselage
- Tailcone
- Landing gear
- Engine and transmission cowlings

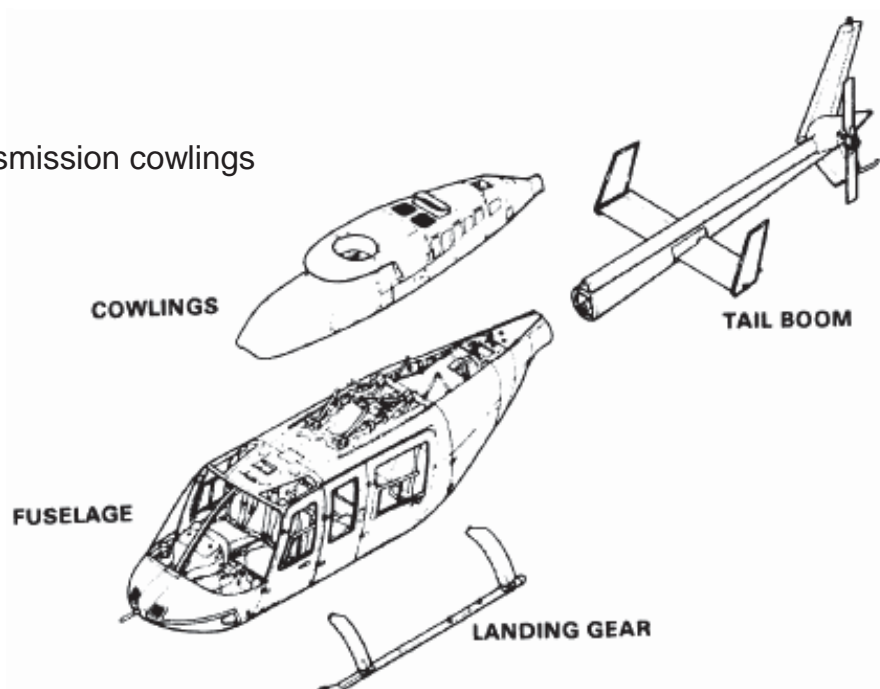

➤ Fuselage:

- Place for the helicopter crew and payload.
- Structure: usually semimonocoque.
- Some transparencies are needed (visibility), as well as access doors.

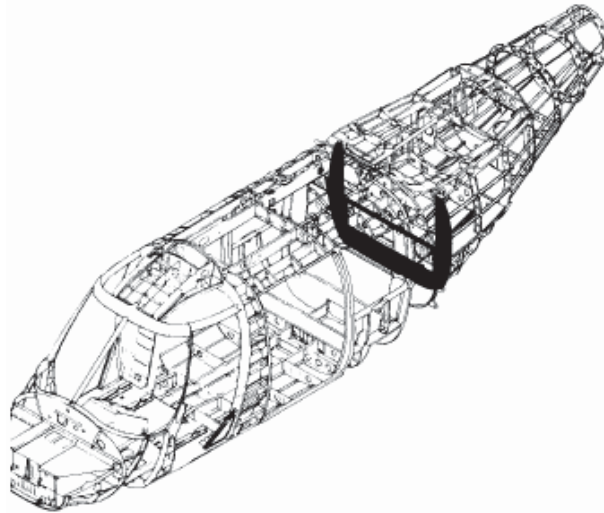

➤ Main rotor or rotors

Parts: rotorhead (joint element to the axis) and blade (rotating wing) with its aerodynamic airfoil generate lift.

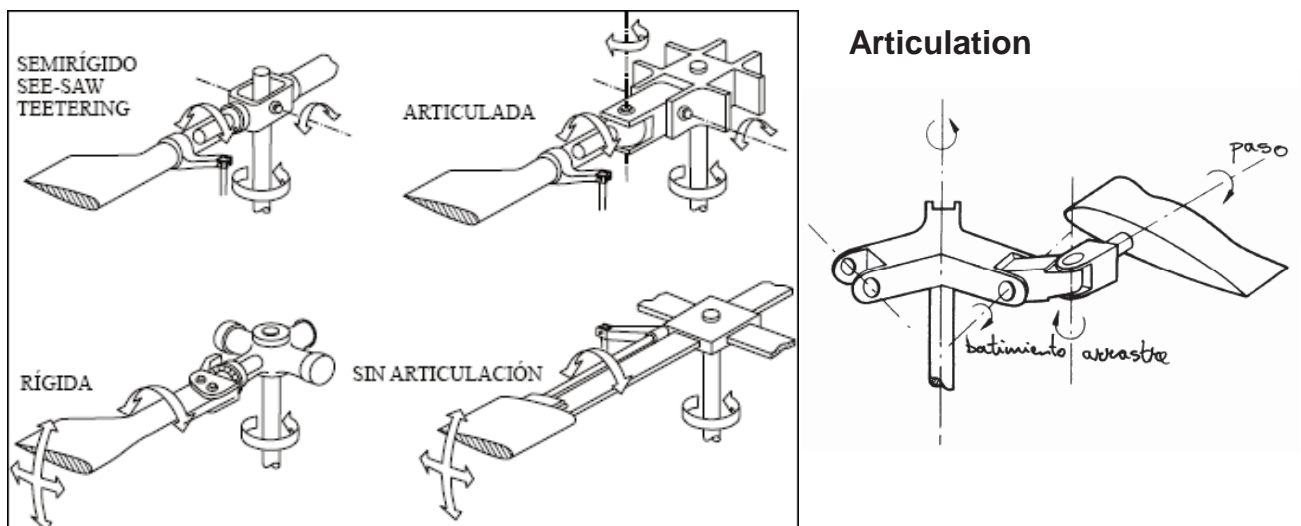

➤ Control system

- Control in altitude, roll, pitch and yaw.
- Necessity of changing the pitching angle (θ) of the blades.
- The blade pitch is varied in a general way (collective) or cyclic for altitude, pitch and roll.
- The yaw movement is controlled by the anti-torque.

Problem

- Necessity of communicating a fixed part (pilot controls), with a movable part (blades). Different systems.

Pilot controls

- Cyclic stick
- Collective lever
- Pedals

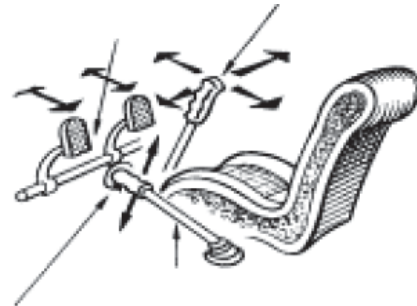

➤ Control system: Collective lever

- Placed at the left of the pilot, it controls the vertical displacement of the helicopter.
- It modifies the pitching angle of the blades, thus controlling the lift of the main rotor.
- It is used in combination with the throttle, which is usually placed at the end of the collective lever. Automatic regulation to keep the rpm.



©2000 HowStuffWorks

➤ Control system: Cyclic stick

- Placed in front of the pilot, it provides longitudinal and lateral control.
- The stick is pushed in the sense of the movement.
- It usually has a trim device for compensated flight.



➤ Control system

➤ Problem of the cyclic blade pitch control: We need a system capable of tilting the rotor plane.

- Independent of the cyclic variations needed due to the asymmetry of lift.
- Initially (autogyros) the whole axis was tilted. Gyroscope.
- Usual systems: swash plate and spider-system control

➤ Control system: Swash plate

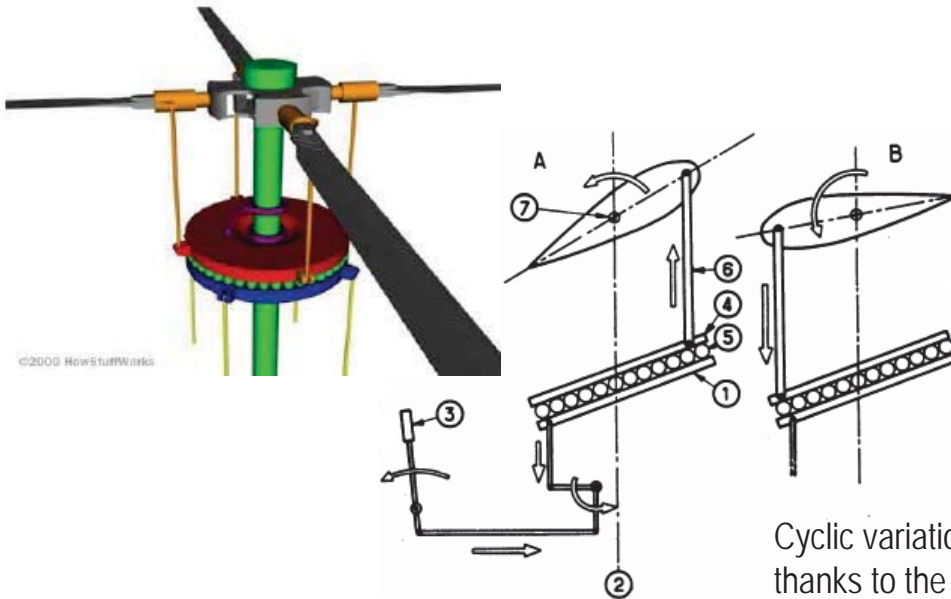

Cyclic variation of the pitch angle, thanks to the disk, which rotates solidary with all the blades.

➤ Control system: “spider” system

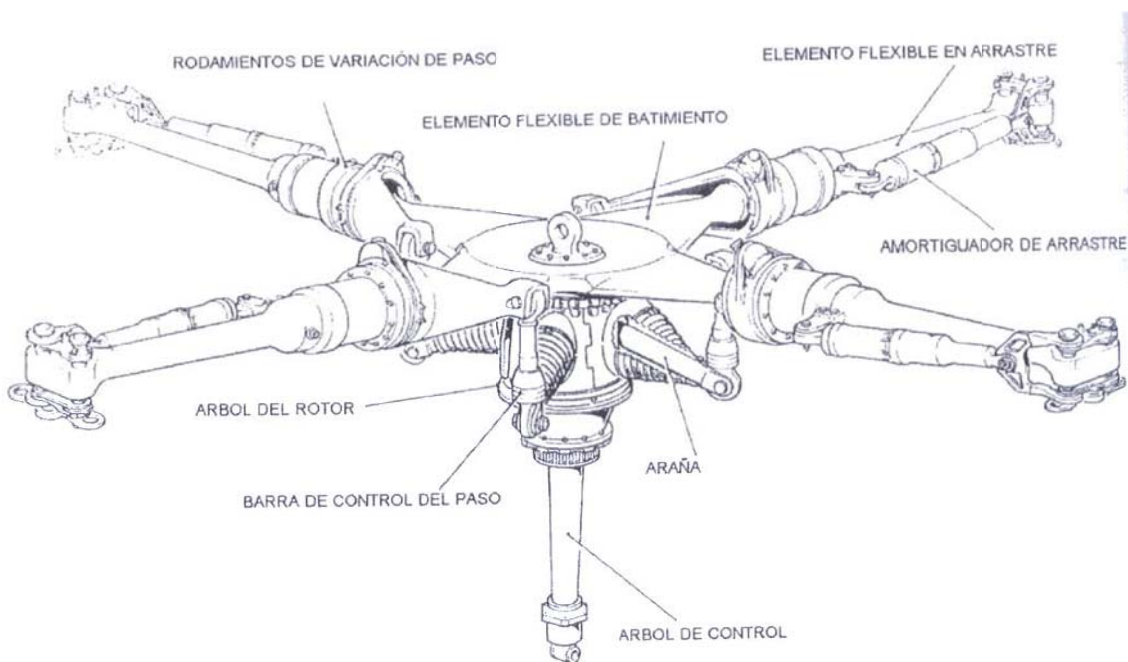

➤ Control system: Pedals

- Provide with yaw or directional control
- They work modifying the thrust of the tail rotor or anti-torque available device.
- They are linked to the anti-torque through a transmission mechanism.
- The pedal must be stepped in the required direction.



➤ Anti-torque system

- Necessary in helicopters with a single rotor
- In the case of two rotors (tandem, side-to-side, coaxials...) the torque is compensated between them
- It is also used for yaw control.
- Systems: anti-torque rotor, fenestron, notar

➤ Anti-torque rotor

- Changing the collective pitch angle of the blades, its thrust is controlled, and the torque with it.



➤ **Fenestron:**

- Aérospatiale
- Ducted fan
- It reduces the irradiated noise
- Less interference with the vertical stabilizer.
- More protected, higher safety in the operation.



➤ **NOTAR (NO TAIl Rotor)**

- Compressed air is expelled through a slot along the tailcone.
- Coanda effect.
- It reduces noise and vibrations.
- Increases safety.

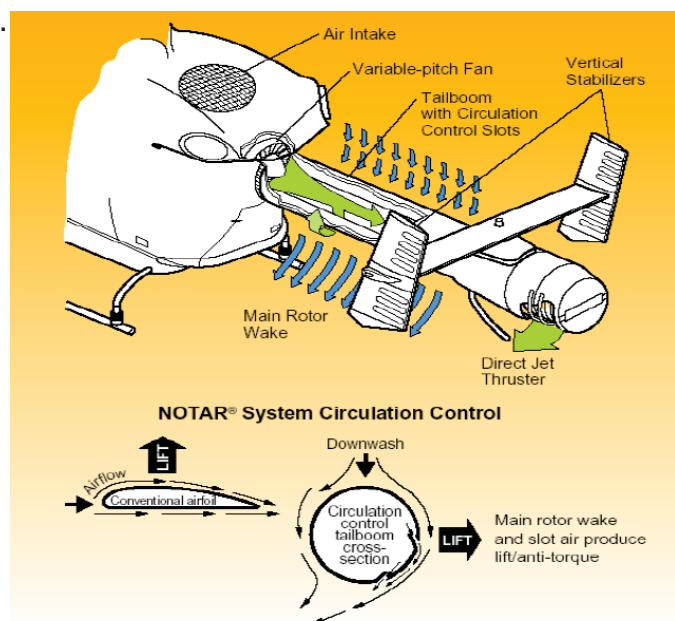
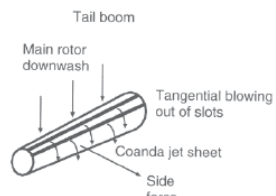
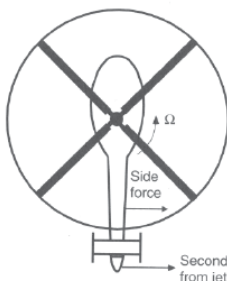

➤ **The anti-torque rotor**

The main purposes of the anti-torque rotor are:

- To provide the compensation torque to the engine torque.
- To provide stability as well as control around the yaw axis.

The anti-torque rotor operates in a pretty complex aerodynamic environment and must be capable of providing the necessary thrust from the relative airflow coming in any direction in general.

For instance, the anti-torque rotor must provide the necessary thrust in crosswinds, lateral maneuvers... When the helicopter is oriented towards the left, the anti-torque rotor finds an effective stream of ascending flight. However, if the helicopter is oriented toward the right, the rotor is working under descent flight conditions. This operation may be critical, since the anti-torque rotor can easily start operating in the vortex ring state or turbulent wake. This can lead to a loss of lateral control if a combination of the worst conditions takes place.

Since it is located in the vertical stabilizer, the aerodynamic interactions must be carefully analyzed, as they will affect the behavior of the anti-torque rotor.

➤ **The anti-torque rotor**

In addition, the interaction with the wakes thrown by the main rotorhead and fuselage as well as the main rotor's own wake will affect the behavior of the anti-torque rotor. This adverse aerodynamic environment means that the design requirements for the anti-torque rotor are pretty different compared to those of the main rotor.

The main consequence is that finding the anti-torque rotor design that satisfies all the specifications with regard to aerodynamics, control, stability, weight, etc. is a very difficult task.

➤ Dragging system (powerplant)

- It is employed to move the rotor or rotors.
- It can consist of one or several motors.
- Usually it is a reciprocating engine ($M < 2000$ kg) or turbomachines ($M > 2000$ kg)
- When it is dragged by reaction, the use of the anti-torque rotor can be saved.
- The most commonly used is the turboshaft.

➤ Dragging system (powerplant)

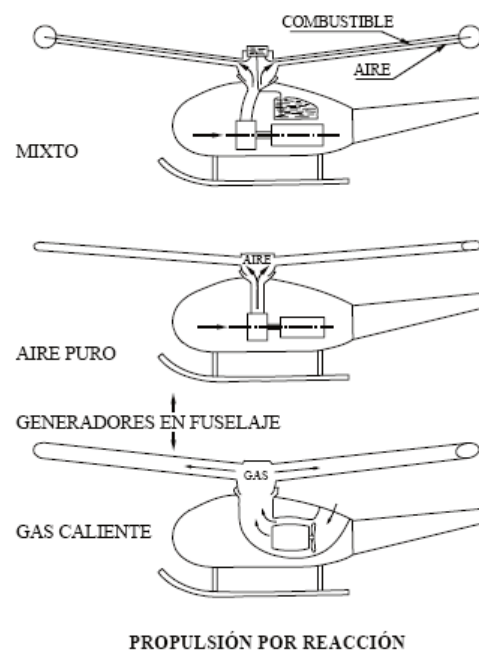
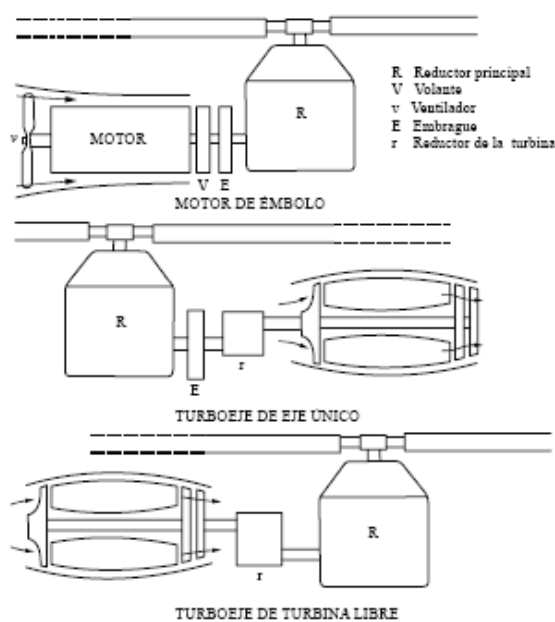

➤ Transmission system

- Very important, specially in helicopters of mechanical powerplant.
- Main elements that it is composed of:
 - Clutch
 - Free wheel
 - Rotor brake
 - Main gearbox
 - Driveshaft
 - Intermediate shaft (to the anti-torque)
 - Couplings
 - Change of angle
 - 90° change
 - Anti-torque gearbox
- Necessity of lubrication

➤ Transmission system

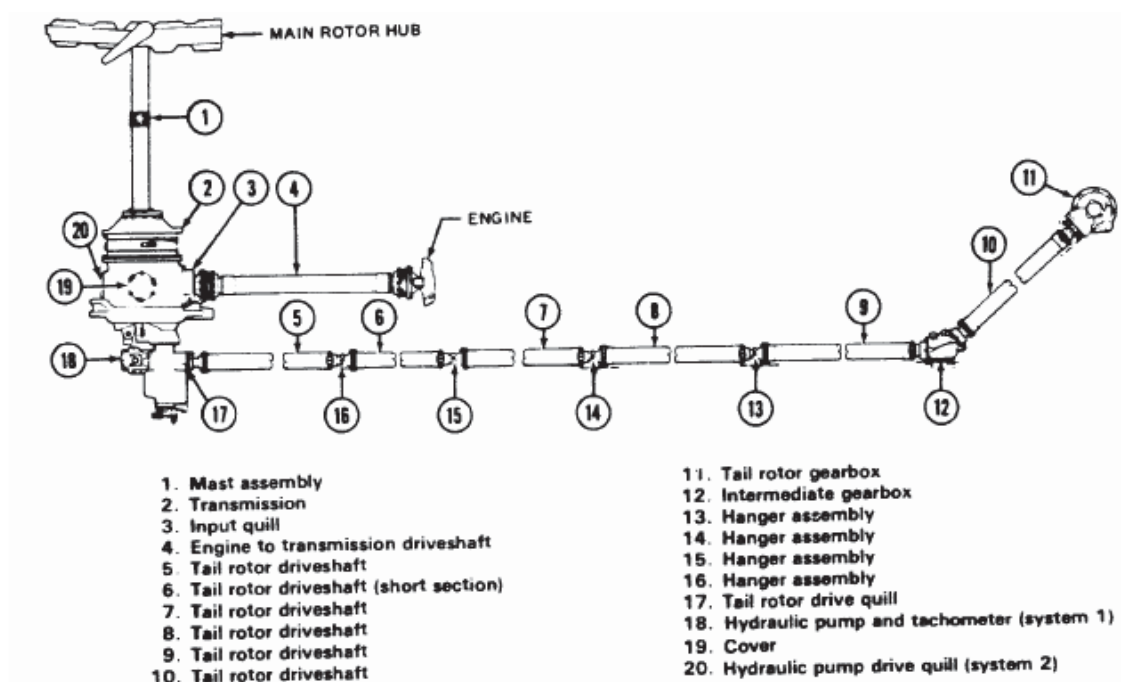

- **Transmission system**
Reciprocating engine

Motor alternativo.

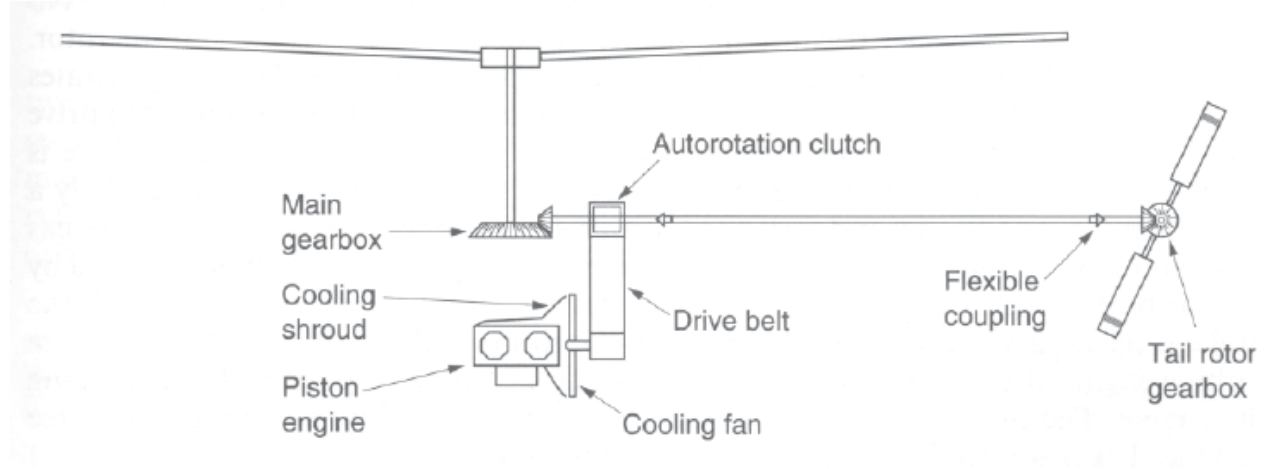

- **Transmission system**
Turboshaft engine

Motor turboeje.

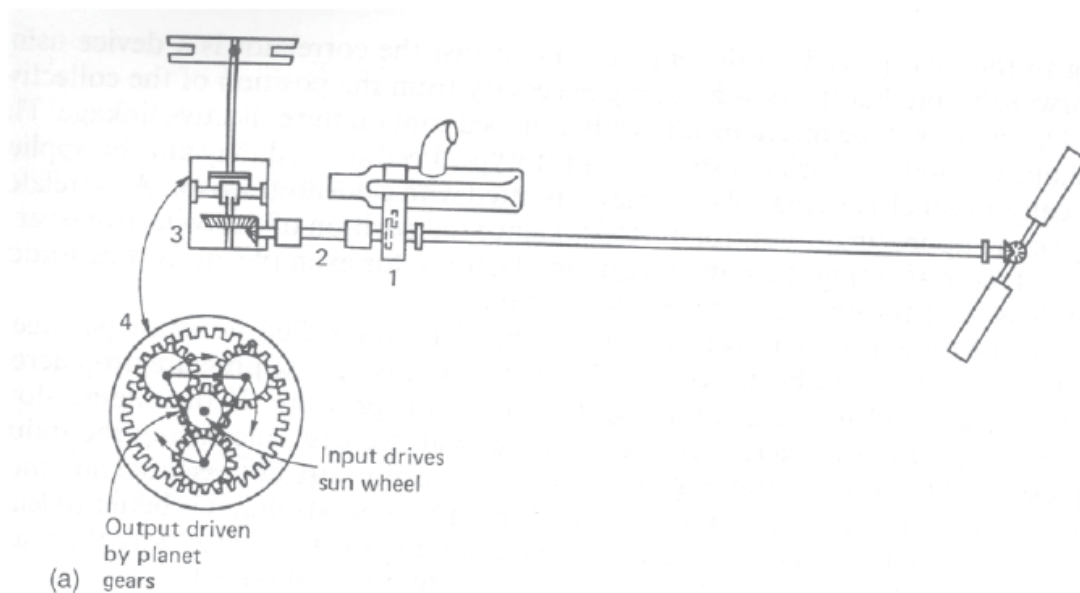

➤ Flight instruments



Classic cabin

➤ Flight instruments

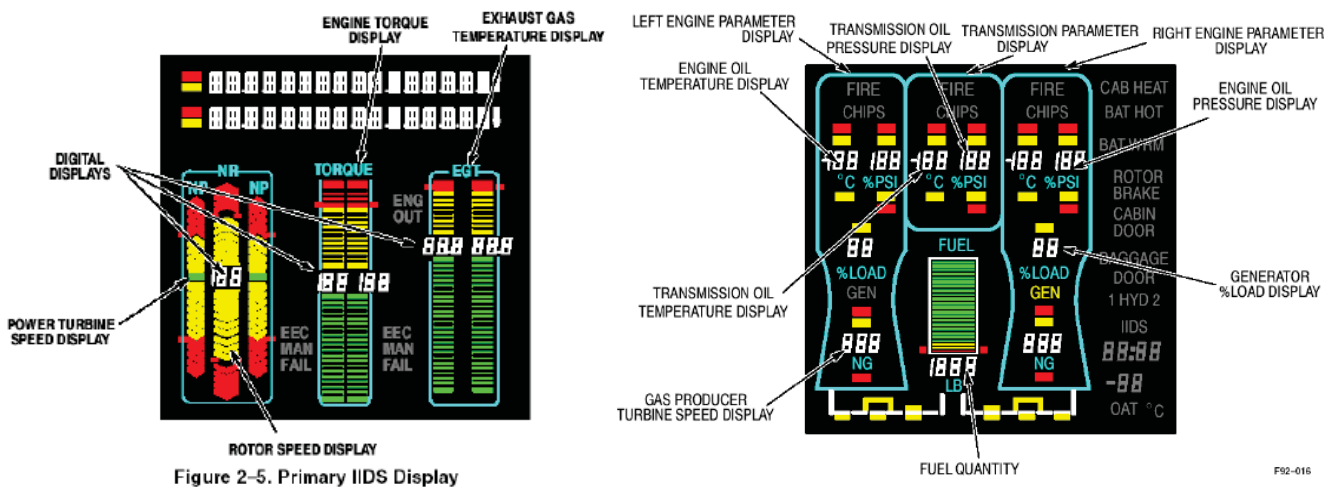

IIDS (Integrated Instrumentation Display System)

➤ **Disk loading**

- Thrust by surface unit of the rotor in steady flight.
- The disk loading has been increasing through the years.
- Typical values: 200-500 N·m⁻²

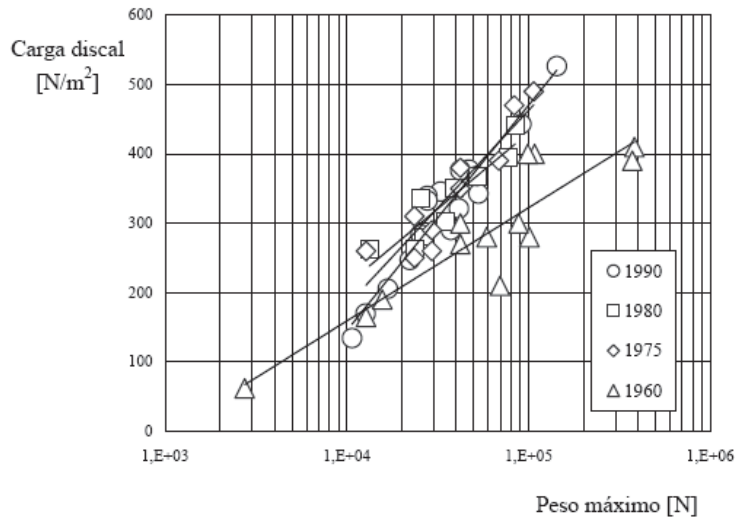

$$\text{Disk Loading} = \frac{T}{S}$$

➤ **Diameter of the anti-torque rotor**

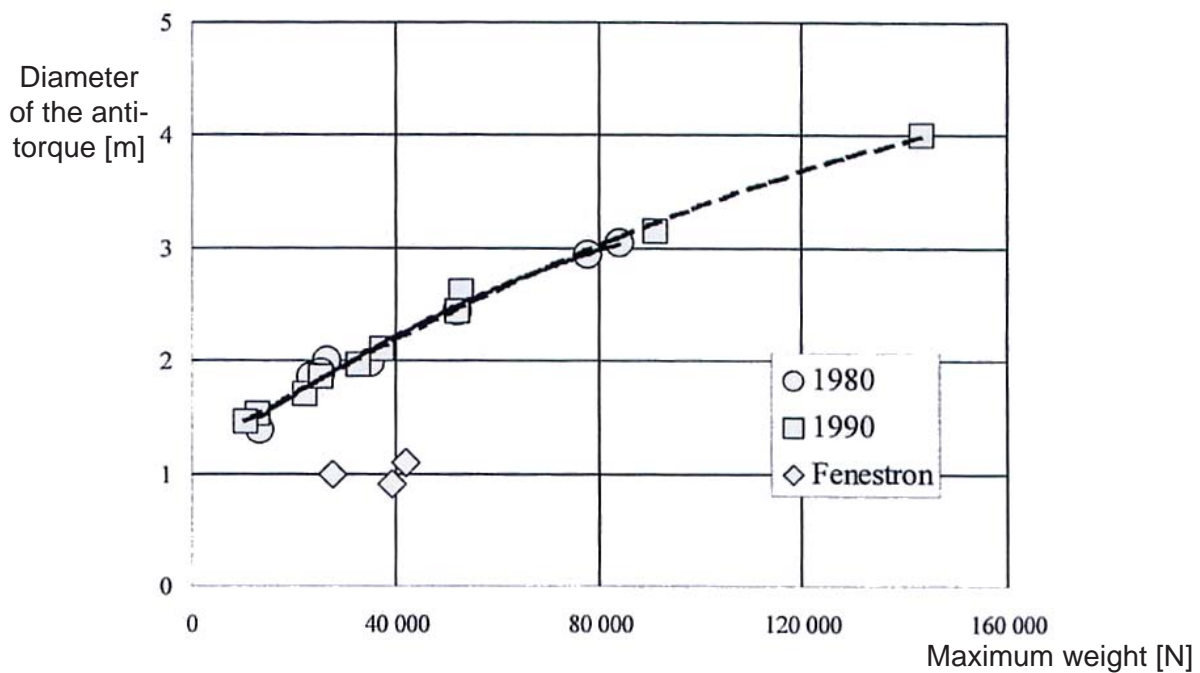

➤ Number of blades

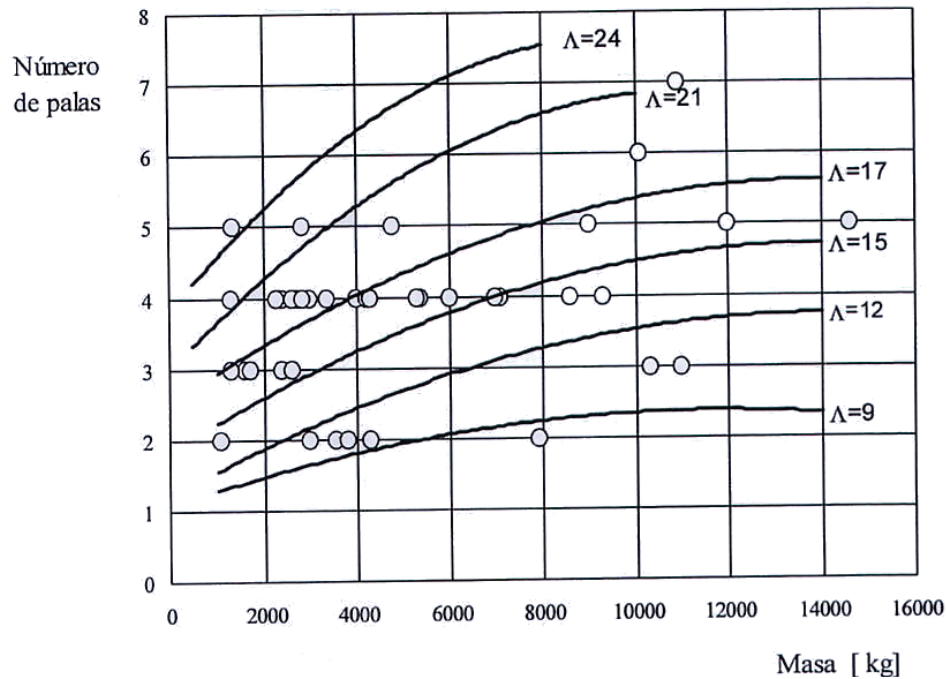

➤ Blade tip velocity to flight velocity relation

- Blade tip velocity $\Omega R \sim 200\text{-}220 \text{ m}\cdot\text{s}^{-1}$ ($M \sim 0,6\text{-}0,65$)
- $V + \Omega R \sim 0,8\text{-}0,9$
- Forward parameter: $\mu = V/\Omega R \sim 0,3 - 0,4$

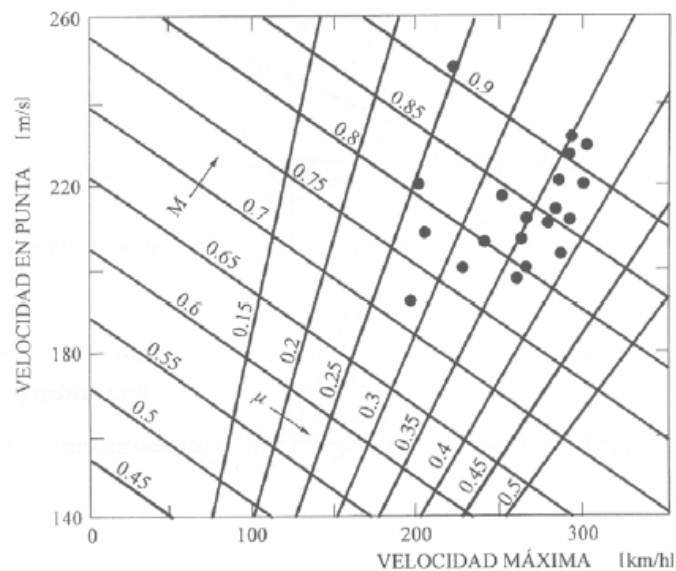

➤ **Flight envelope**

Altitude-flight velocity relation

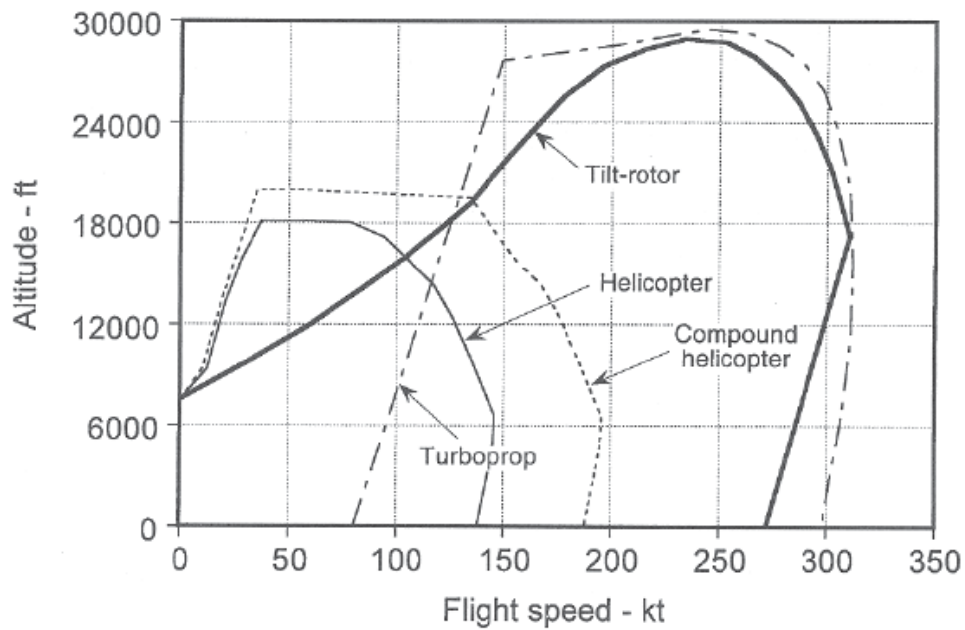

➤ **Useful load as a function of the total mass**

CARGA ÚTIL [kg]

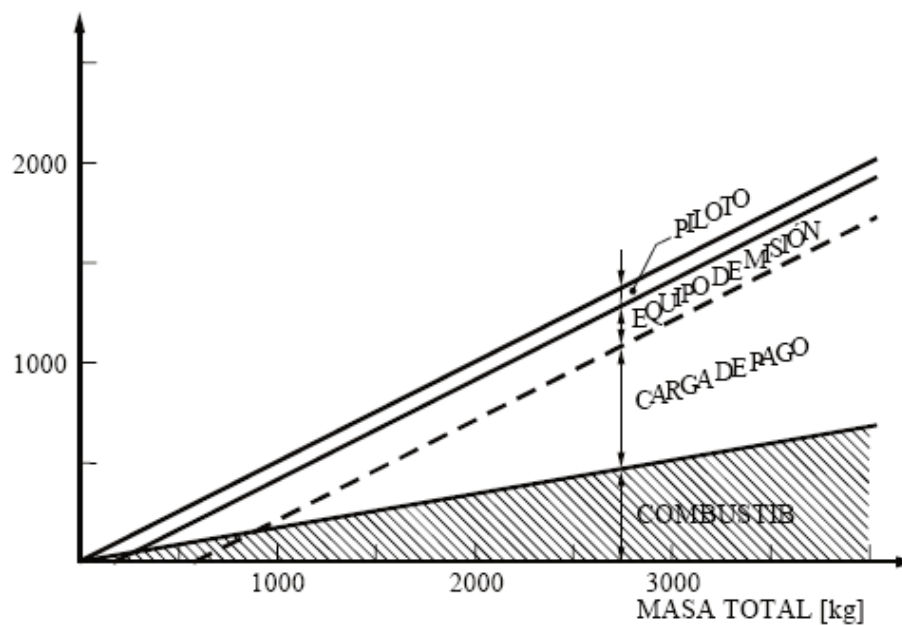

Aircraft

7 Missiles

Kinds of missiles and their main characteristics

Rockets that were first developed as missiles

- **Missiles Classification**
- **General Description**
- **Control and Guidance System**

	Strategic			Tactical		
	Ballistic and Tactical Ballistic	Cruise	AAM	ASM	SAM	SSM
Launch	Silo Rail Submarine Mobile launchers	Surface Air Submarine	Aircraft	Aircraft	Ground Ship	Ground Ship
Structure	Light	Airplane type	Robust	Robust	Robust	Robust
Energy	Gas generator Batteries	Generator Batteries	Gas generator Batteries	Gas generator Batteries	Gas generator Batteries	Gas generator Batteries
Guidance	Inertial	Inertial GPS Terrain reference	Auto guided	Auto guided TV-guided	Auto guided TV-guided Guiding beam	Auto guided TV-guided
Control	Jet + Aerod.	Aerodynamic	Aerodynamic	Aerodynamic	Aerodynamic Jet	Aerodynamic
Warhead	Nuclear Conv. (Tact)	Nuclear Conv.	Conventional	Conventional	Conventional	Conventional
Propulsion	Rocket Engine	Jet Engine	Rocket Engine	Rocket Engine Jet Engine Ramjet	Rocket Engine	Rocket Engine

➤ Cruise missile: airplane type, light, jet engine, attack to surface

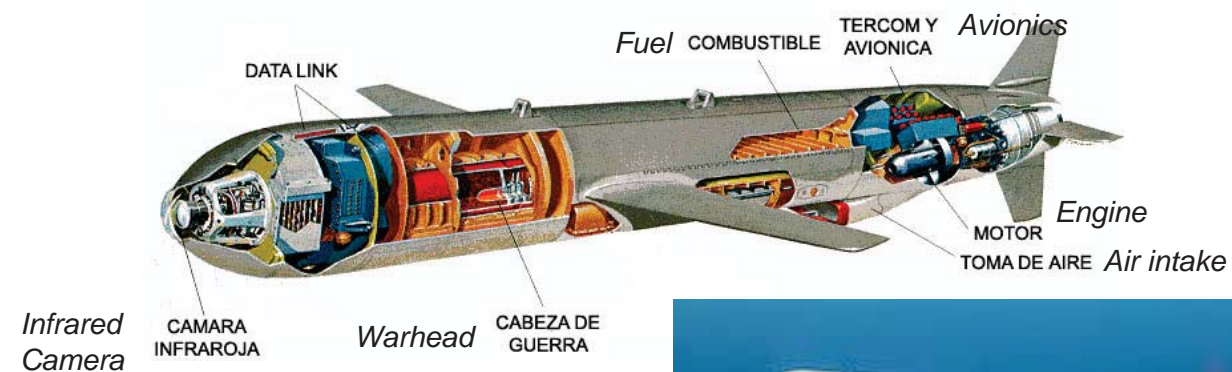

➤ **Anti-ship missile: robust, solid or liquid fuel, attack to surface**

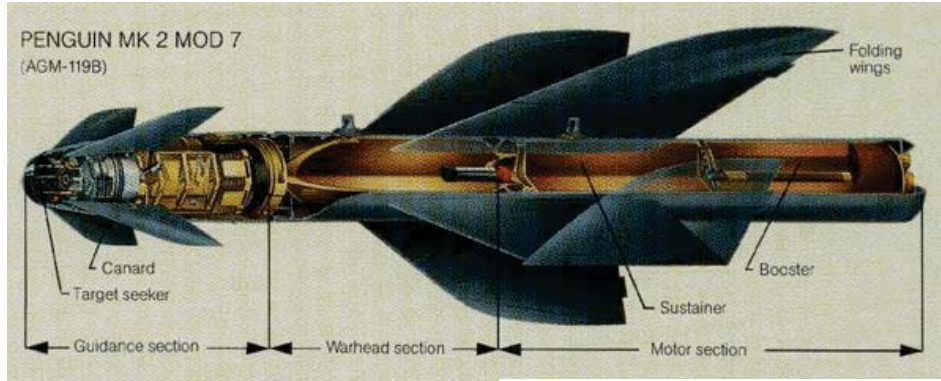

Primary Function	Helicopter launched anti-ship missile.	Diameter	11.2 inches (28.45 centimeters)
Contractor	Kongsberg Vaapenfabrikk (Norway)	Wing Span	30 in's folded, 55 in's Deployed
Power Plant	Solid propellant rocket engine and solid propellant booster	Range	25 nautical miles / 35 km
Length	120.48 inches (3.06 meters)	Speed	1.2 Mach maximum
Launch Weight	847 pounds (385 kilograms)	Guidance	Inertial and infrared terminal.
		Warhead	265 lbs gross, 110 lbs High Explosive, semi armor piercing derivative of the Bullpup missile
		Date Deployed	Fourth quarter 1993

➤ **AAM: robust, solid or liquid fuel, modern with jet engine (i.e. they can be autonomous or non-autonomous)**

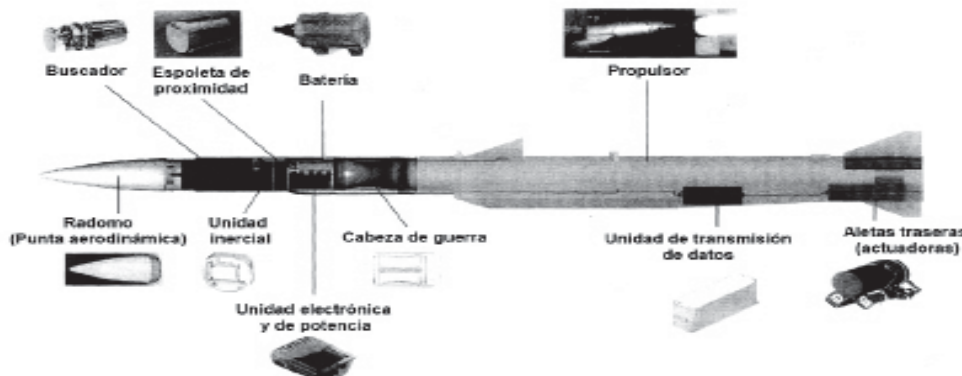
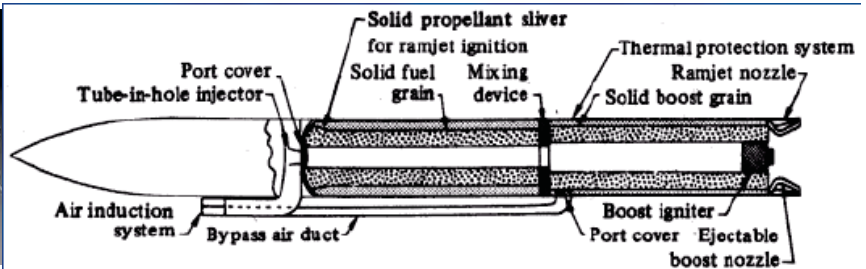

➤ Meteor missile, non-autonomous

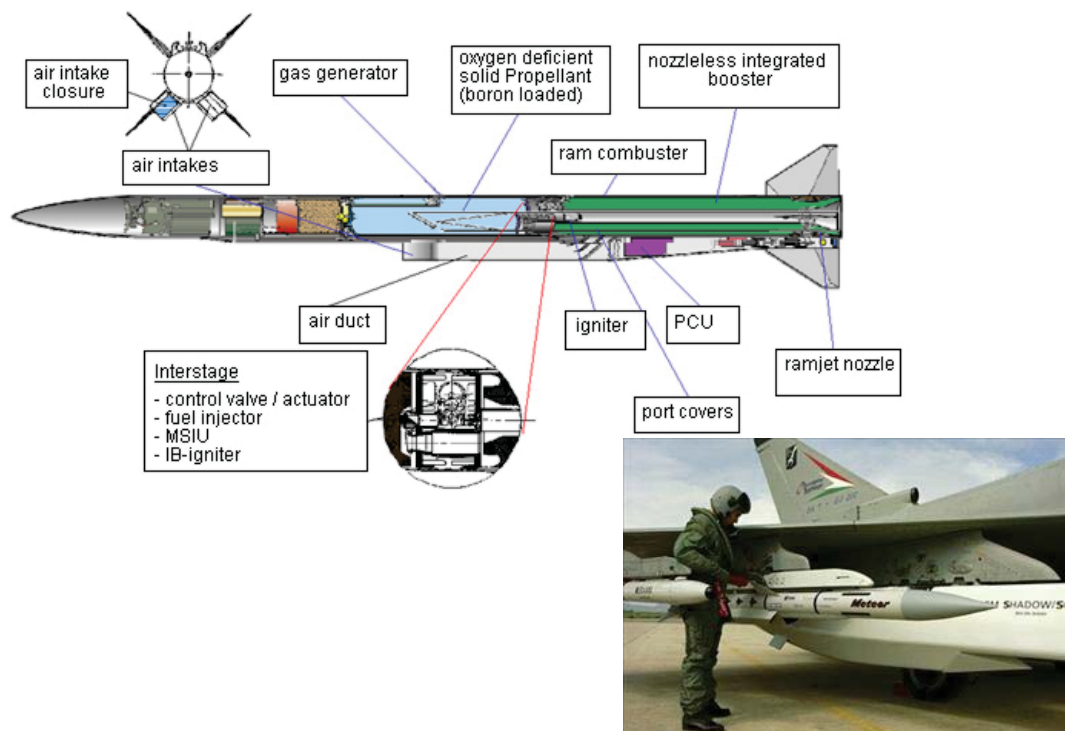

7. Missiles

7



Meteor	
Basic data	
Function	beyond visual range air-to-air missile
Manufacturer	MBDA, TDW
Unit cost	GBP1m
Entered	development to be completed by 2013
General characteristics	
Engine	throttleable ducted rocket
Launch mass	185 kg
Length	3.65 m
Diameter	0.178 m
Speed	over Mach 4
Range	100+ km
Warhead	high explosive blast/fragmentation
Guidance	inertial mid-course with datalinked updates, active radar terminal guidance
Fuzes	radar proximity and impact
Launch platform	Typhoon, Rafale, Gripen, F-35

7. Missiles

8



➤ **AAM: robust, solid or liquid fuel, autonomous**

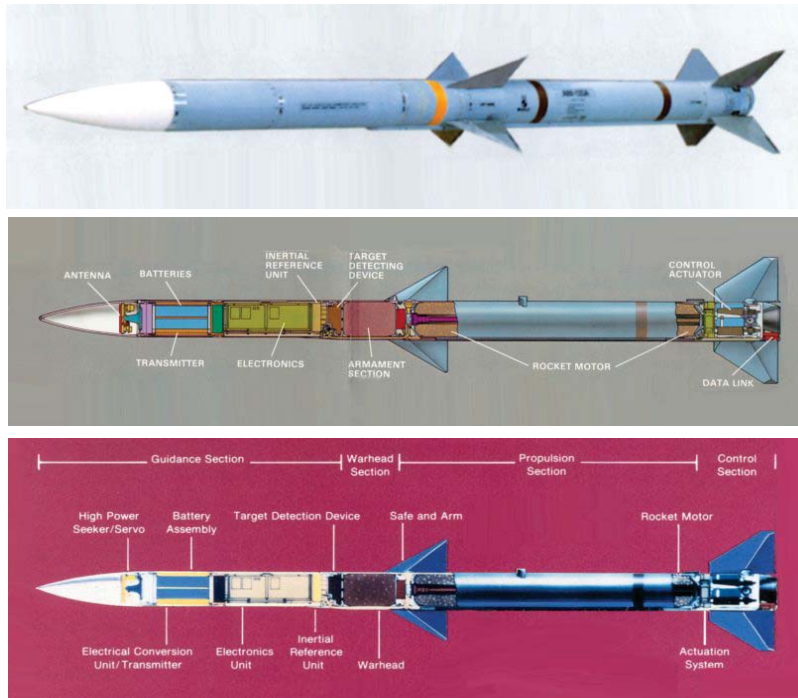

AIM-120 AMRAAM

Basic data

Function	Medium-range, air-to-air tactical missile
Manufacturer	Hugues / Raytheon
Unit cost	\$386,000 (2003); \$299,000 (price for Lot 12 contract in April 1998; the previous price in Lot 11 was \$340,000 each)
Entered service	September 1991

General characteristics

Engine	High-performance directed rocket motor
Mass	335 lb (152 kg)
Length	12 ft (3.66 m)
Diameter	7 in (178 mm)
Wingspan	20.7 in (526 mm) (AIM-120A/B)
Speed	Mach 4
Range	AIM-120A/B: 75 km (45 mi, 65, 112)
Warhead	High explosive blast-fragmentation
Guidance	INS, active radar
Launch platform	Aircraft

R-77/RVV-AE (NATO reporting name: AA-12 Adder) (russian missile similar to the AIM-120)

Basic data

Function	Medium-range, air-to-air tactical missile
Manufacturer	Vympel
Entered service	1994 (R-77)

General characteristics

Engine	Solid fuel rocket motor (R-77), air-breathing ramjet (R-77M1)
Launch mass	175 kg (R-77), 226 kg (R-77M1)
Length	3.6 m (R-77)
Diameter	200 mm
Wingspan	350 mm
Speed	over Mach 4 (R-77)
Range	90 km (R-77), 175 km (R-77M1)
Flying altitude	5m-25 km (16.5-82,000 ft)
Warhead	30 kg HE, fragmenting
Guidance	Inertial with mid-course update and terminal active radar homing
Fuzes	laser proximity fuze
Launch platform	Mikoyan MiG-29, Mikoyan MiG-49

➤ **SSM: robust, solid or liquid fuel, autonomous, small, precision laser guidance**

La oferta de misiles antitanque
El Ministerio de Defensa comprará 2.600 misiles para equipar al Ejército de Tierra y la Infantería de Marina.

Milan ER	
Peso	12,5 kg.
Longitud	1,20 m.
Calibre	115 mm.
Alcance	3.000 m.
Peso lanzadera	16,4 kg.
Guía	Térmica
Fabricante	MBDA (Francia)

Spike ER	
Peso	13 kg.
Longitud	1,67 m.
Calibre	170 mm.
Alcance	4.000 m.
Peso lanzadera	9 kg.
Guía	Electro-óptica
Fabricante	Rafael (Israel)

Javelin	
Peso	11,8 kg.
Longitud	1,8 m.
Calibre	126 mm.
Alcance	2.500 m.
Peso lanzadera	6,4 kg.
Guía	Infrarrojos
Fabricante	Lockheed Martin / Raytheon (EE.UU.)

FUENTE: www.mbdia.net, www.army-technology.com, www.military.com D.S. / EL MUNDO

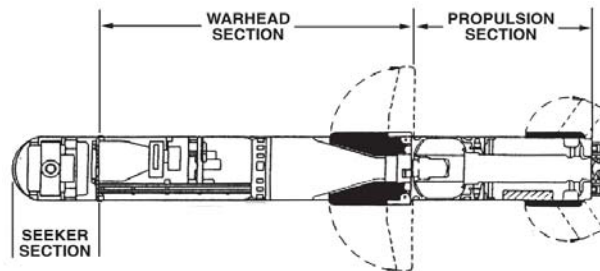

Weight: 28 kg Length: 1.76 meters Range: 2000 m (max) 75 m (min) Warhead Type: Heat Warhead Weight: 8.4 kg Armor Penetration: 600+ mm Launching Platforms: man portable crew of 2

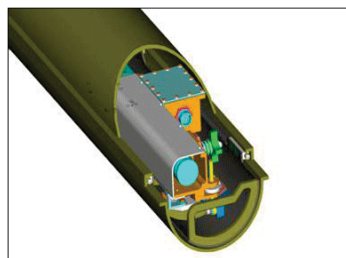

- **Rocket or ballistic missiles: light construction, solid or liquid fuel, inertial or satellite guidance**

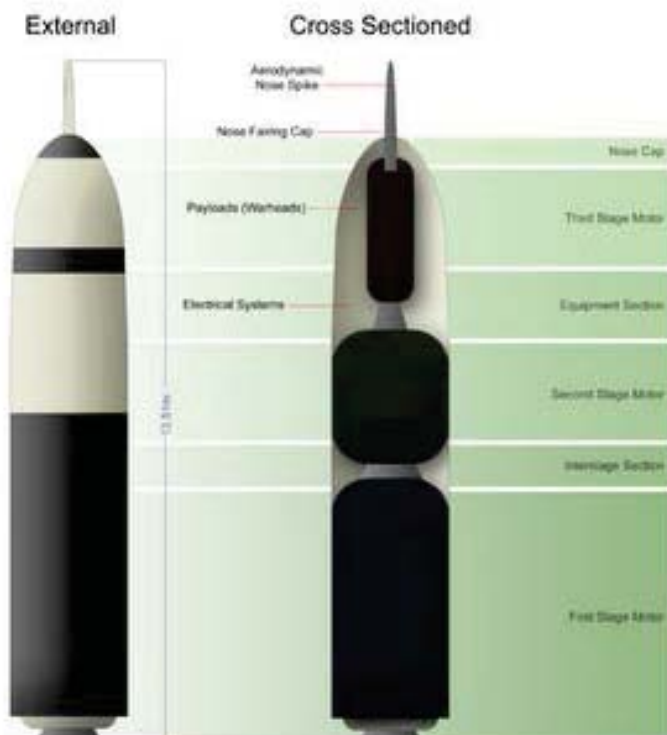
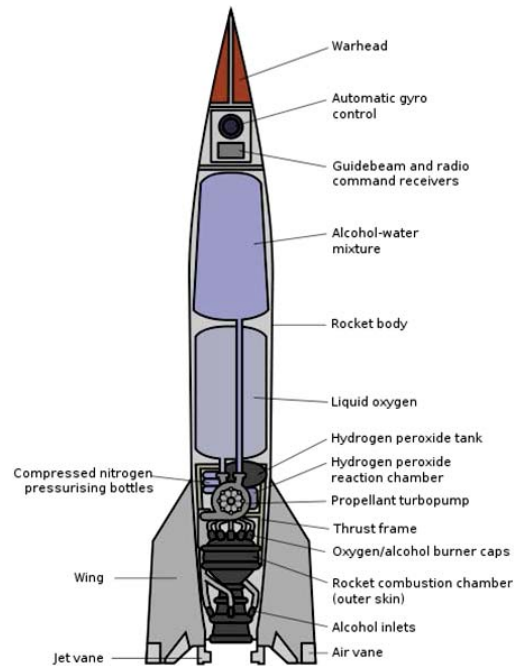

➤ SS-24 missile

Fast launch. It can be launched from a silo or a railway car. It has 3 stages, it uses solid fuel and thrust vectoring in order to be directed. It can carry 10 warheads of 550 kilotons.

This missile is the result of a big effort from the URSS in order to develop a solid fuel missile with several launch platforms (silo and railway). The mobile version was cancelled. These missiles could be moved through the large URSS railroad network, which made them survivable. It was developed in order to replace the SS-19 missiles, which were only able to be launched from silos.

The US version of this missile is the MX.



➤ Ballistic missile orbit

Three different stages:

- Powered ascent
- Ballistic trajectory in the space (without propulsion)
- Re-entry (impact on target)

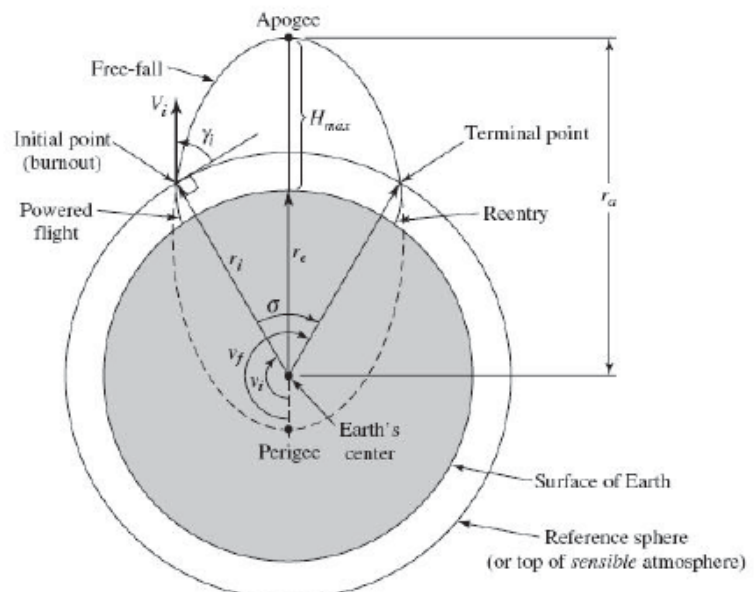
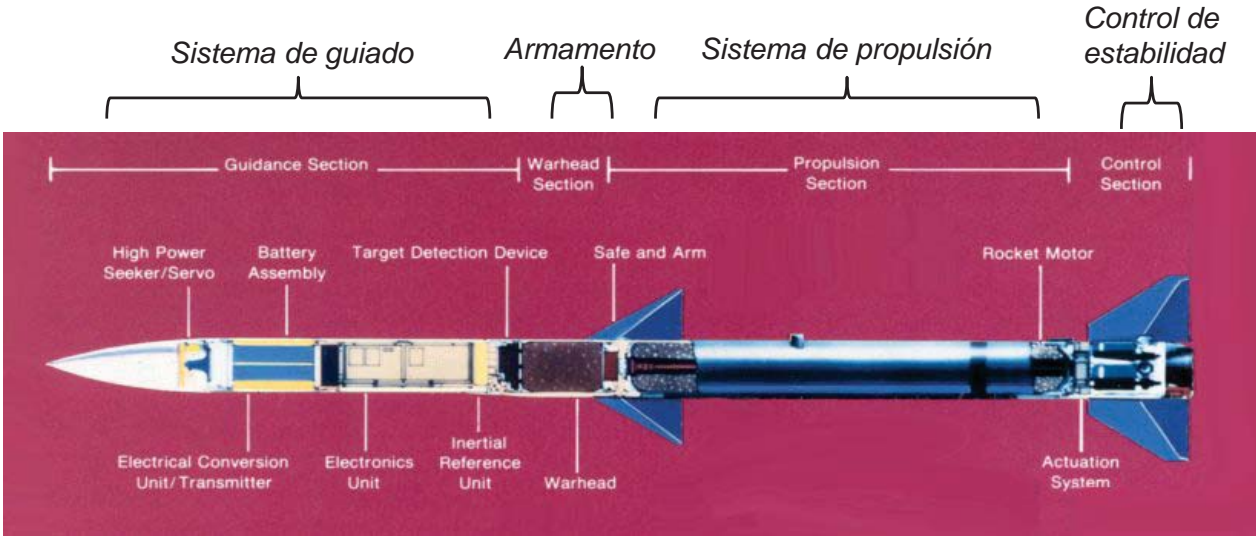

Fig. 6.9. Typical ballistic missile orbit.

➤ A missile can be divided into 4 sections:



For each section there are specific elements: gyroscope, control unit, battery, radar, guidance system, combustion section, movement mechanisms (actuators), nozzle that can be orientable or not.

➤ General accessories of a missile

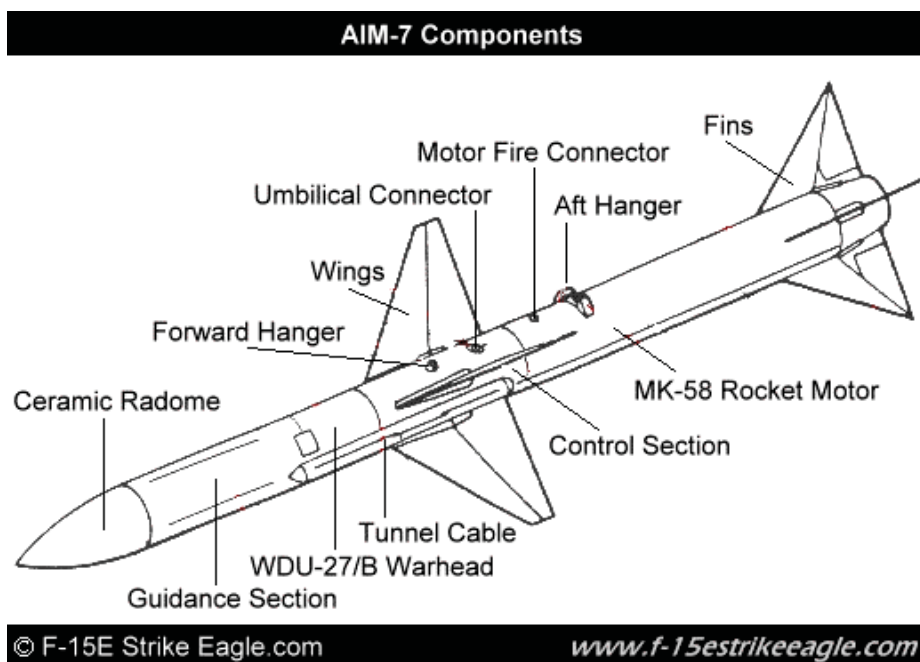

➤ **Parts of a small SSM**

The missile has four rectangular fins for aerodynamic control

The missile can penetrate tanks equipped with ERA

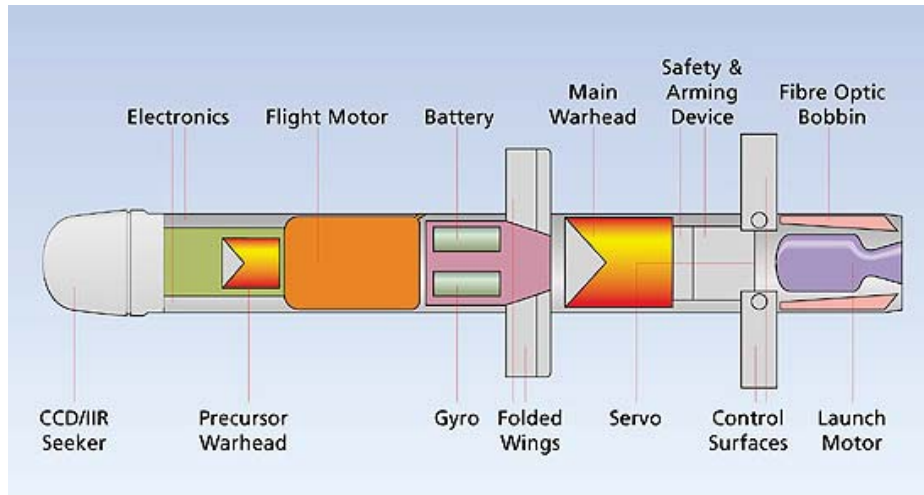

➤ **Missile control system**

The missile must be guided or guide itself towards the target. For this reason, it has a control unit that modifies its path with respect to the target at each instant. The control system is linked to the actuator, which has the control over the movable surfaces. The energy of the control system is provided by batteries.



Figura 23.1 Esquema general del proceso de guiado

➤ Missile guidance methods

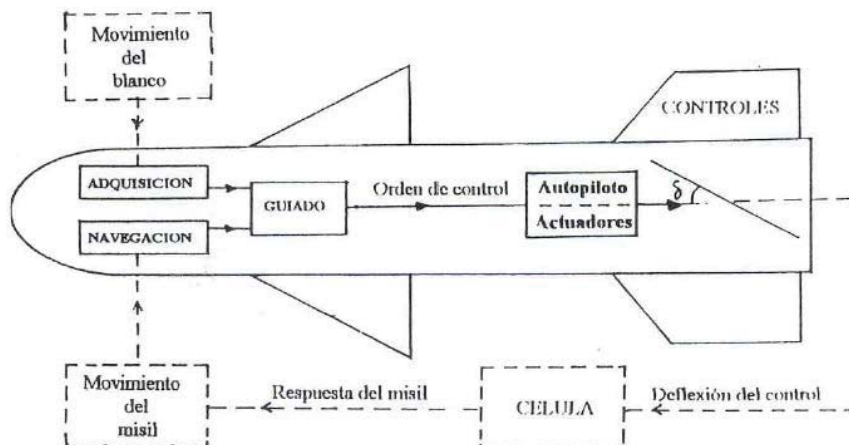
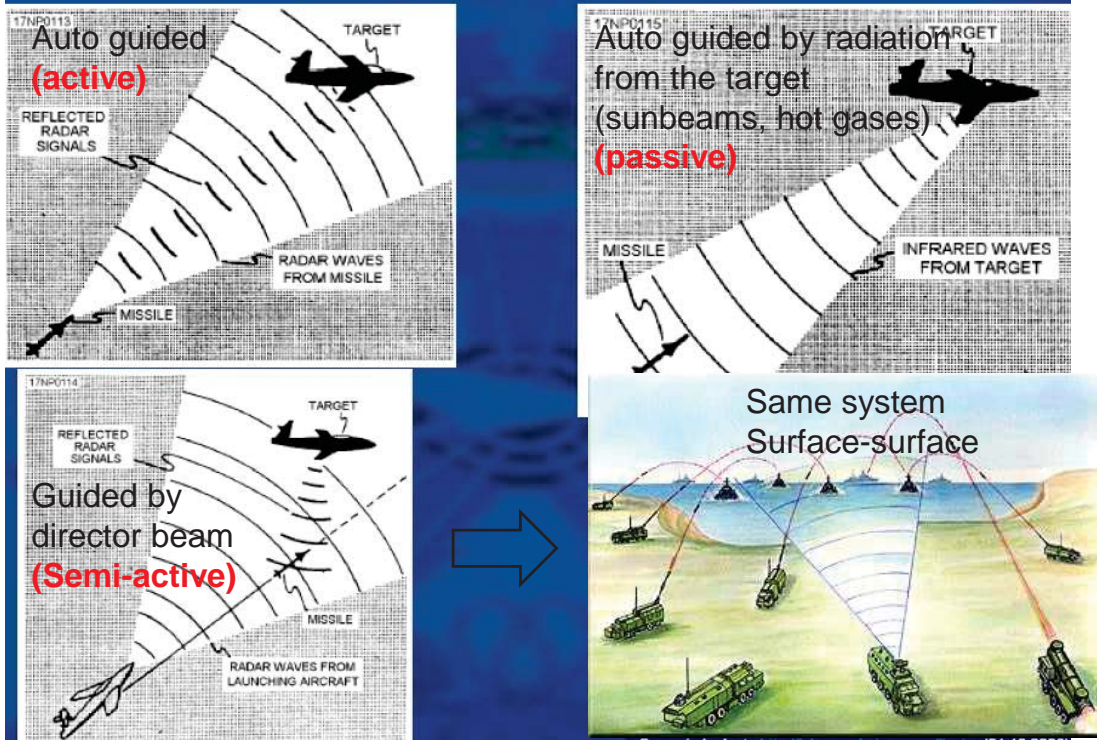

➤ Missile guidance methods

Active: Missile carries source of radiation onboard.

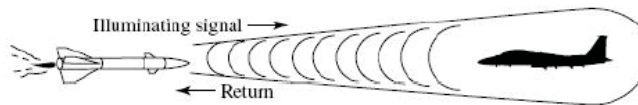

Semi-active: Missile uses external, controlled source of radiation.

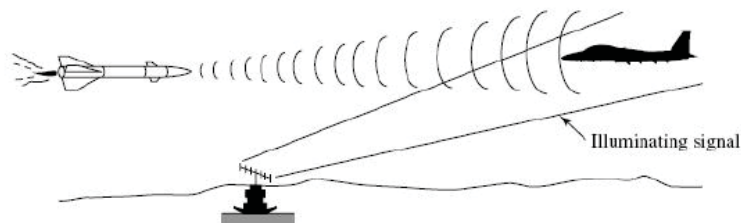

Passive: Missile uses external, uncontrolled source of radiation.

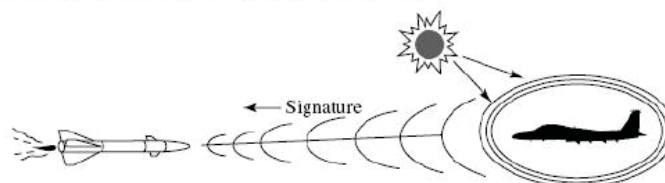

➤ Guidance law: AAM

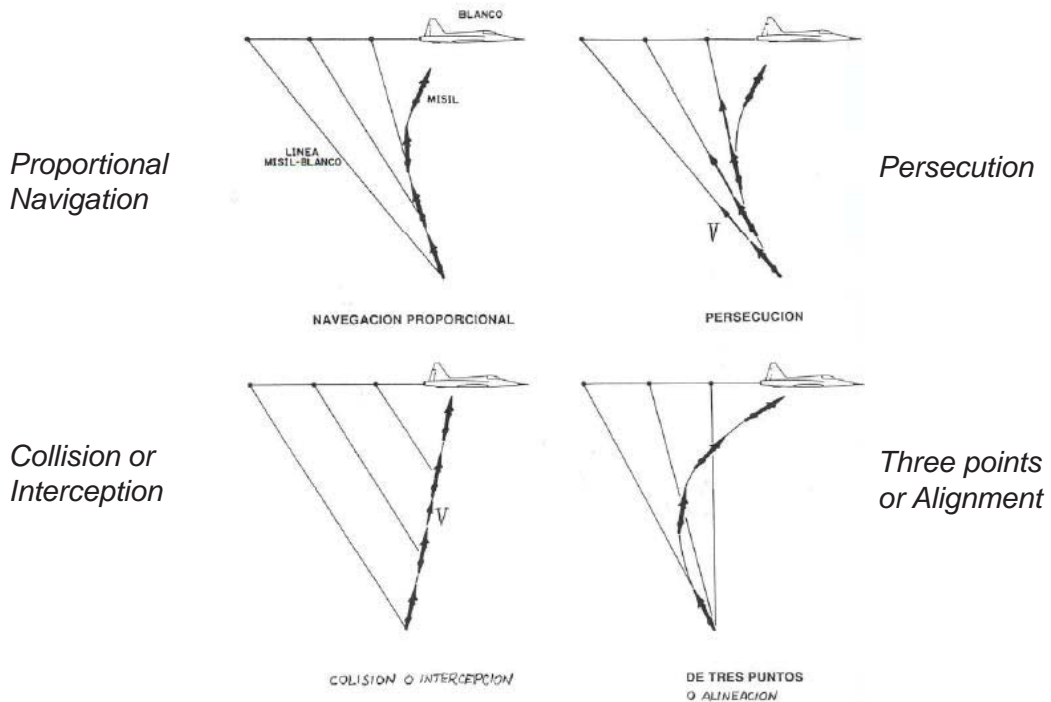

➤ Guidance system summary

Method of guidance to the target:

- Auto guided
- Director beam
- TV-guided
- Inertial
- GPS
- Terrain reference

Guidance laws:

- Persecution
- Collision or interception
- Three points alignment
- Proportional navigation

Control:

- Autopilot
- Actuators which may or not interact with the autopilot system. Through jet or movable surfaces

Commanded by the control system

- Example of a ballistic missile guidance through satellite to the target and GPS to position at the reentry

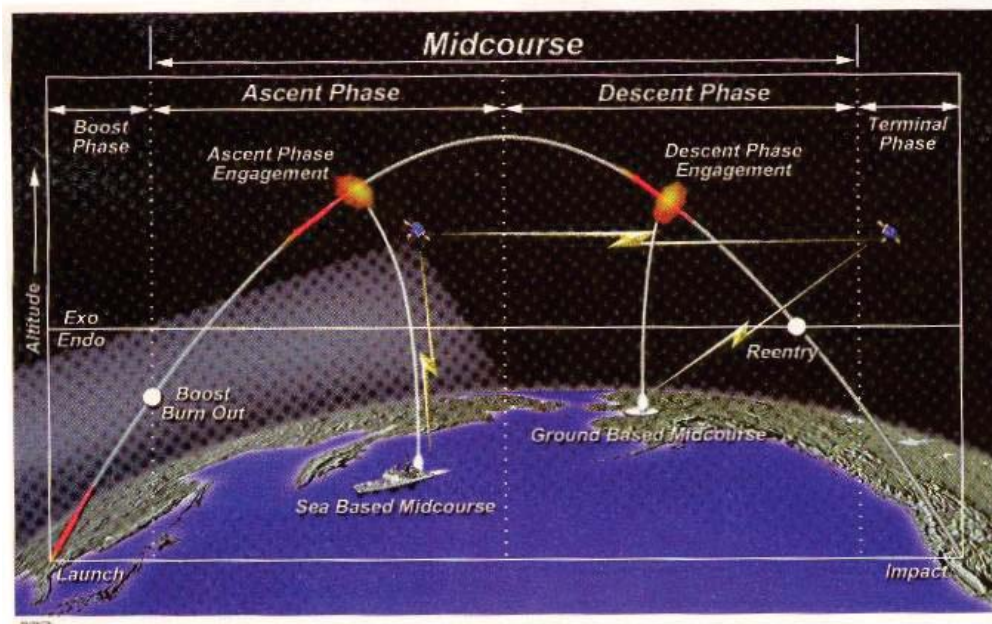

➤ Missile trajectories

- Accelerated followed by flight without thrust
- Constant velocity
- Cruise missile
- Ballistic missile

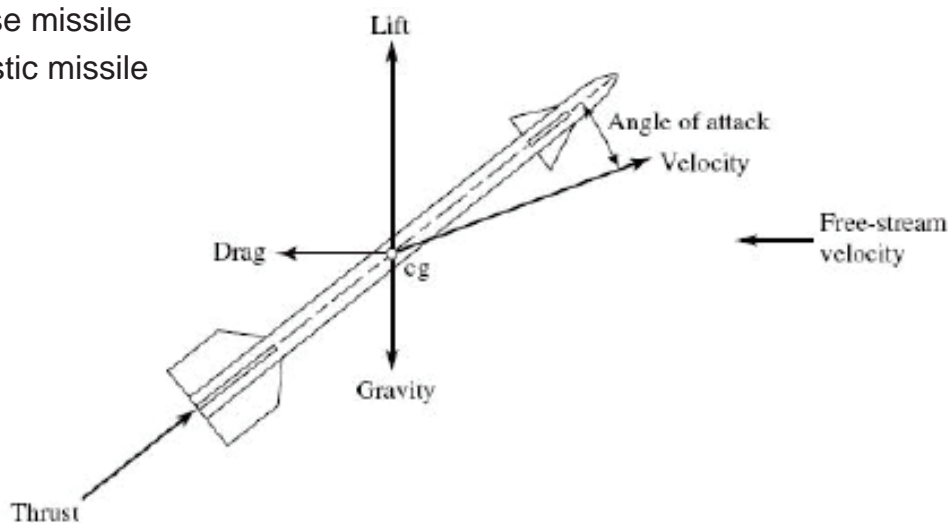
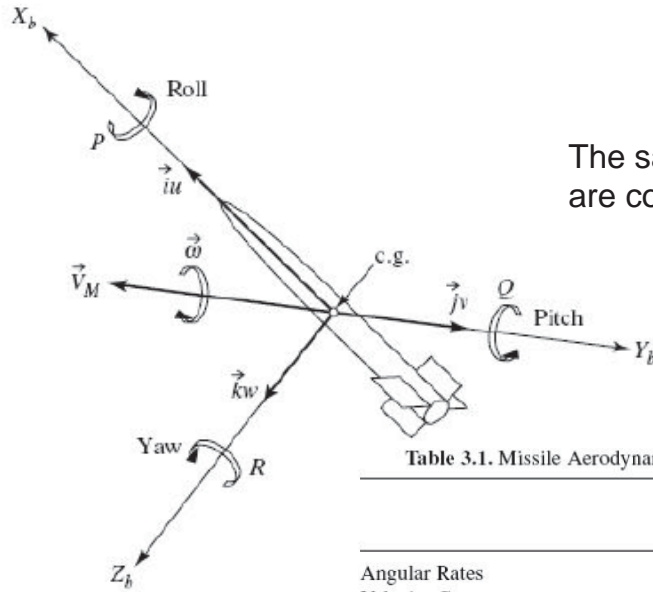

Fig. 3.2. Aerodynamic forces and thrust acting on a missile.



The same degrees of freedom of an aircraft are considered

Table 3.1. Missile Aerodynamic Moments, Coordinates, and Velocity Components

	Roll Body Axis (X_b)	Pitch Body Axis (Y_b)	Yaw Body Axis (Z_b)
Angular Rates	P	Q	R
Velocity Components	u	v	w
Aerodynamic Force Components	F_X	F_Y	F_Z
Aerodynamic Force Coefficients	C_D	C_Y	C_L
Aerodynamic Moment Coefficients	C_l	C_m	C_n

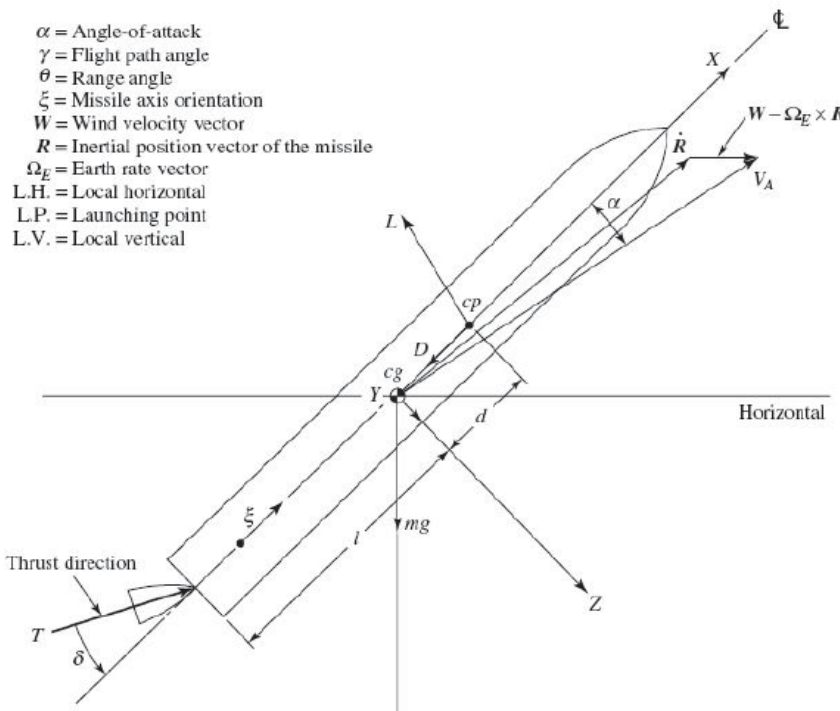

A missile is influenced by the wind component, differing from an airplane, which can compensate this component thanks to the rudder. At each time instant the missile has an inertial vector that predicts its future position, which is influenced by the wind component and originates the angle of attack.

Fig. 6.31. Forces acting on the missile.

➤ **Specific impulse depending on the kind of engine and the flight velocity**

According to the engines used for the tactical and strategic (ballistic) missiles, the ones that offer the best specific impulse are the so-called PDE (Pulse Detonation Engines), since they control the mass employed per unit of achieved thrust. Only two kinds of engine are useful for high velocities: the rockets employing solid or liquid fuels (autonomous) and/or the scramjet (jet engine without mechanical components with supersonic combustion), which are mostly employed in hypersonic aircraft.

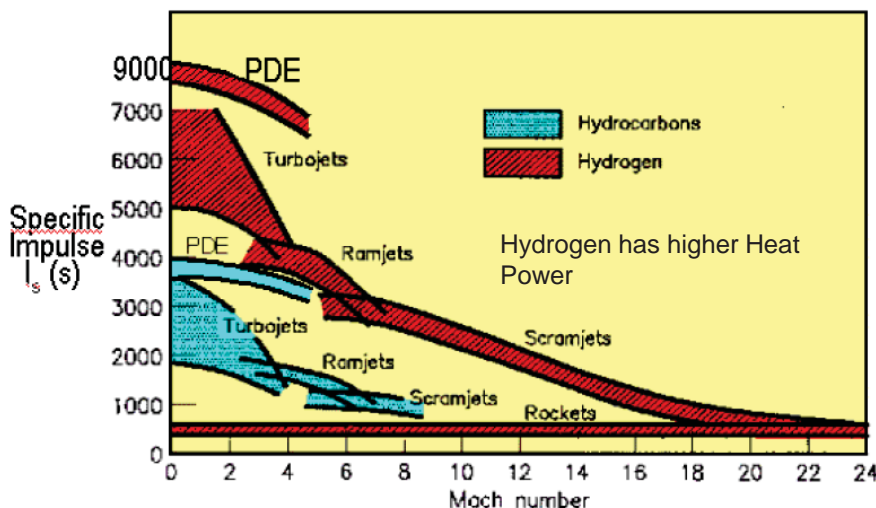

Futures families of PDE engines:
 Combines pulsed combustion and detonation .
 It is not a conventional pulsed jet: ignition is controlled

- A Family of Concepts
- PDE = PDWE (Pulsed Detonation Wave Engine)
- PDRE = Pulsed Detonation Rocket Engine
- RVSPDE = Rotary Valved Single PDE (ASI's concept)
- RVMPDE = Rotary Valved Multiported PDE (ASI's concept)

➤ **Fuel consumption strategies**

All-Boost: An all-boost motor typically will make the missile accelerate rapidly, causing high peak velocities. However, this causes high missile drag, high aerodynamic heating, and short time of flight, for a given range. This motor is suitable for a rear hemisphere, tail chase encounter.

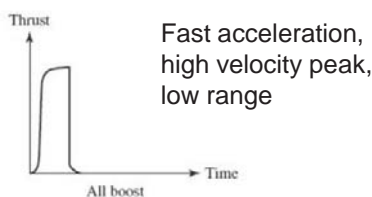

All-Sustain: The all-sustain motor has low missile acceleration, resulting in lower aerodynamic drag and longer time of flight, for a given range. Since the motor burns for a long period of time, the motor can be used to overcome gravity in a look-up engagement, and to provide sufficient velocity for maneuvering at high altitude. This motor is suitable for head-on engagements, or in look-up engagements at high altitudes.

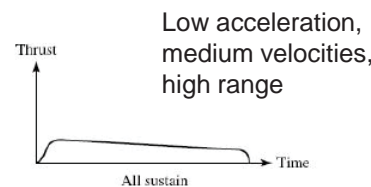

Missile fuel consumption strategy depending on its use and the chosen trajectory. This same thing applies to the rockets.

The fuel consumption may last from units to tens of seconds.

Boost-Sustain: The boost-sustain motor represents an attempt to combine the best features of the all-boost and the all-sustain designs.

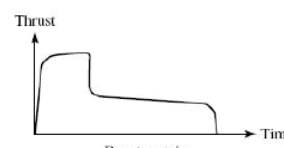

High acceleration followed by a prolonged combustion to increase the range, reduce drag and aerodynamic forces.

Spacecraft

8. Space Vehicles

Classification of Space Vehicles and subsystems

8. Space Vehicles

1



- Introduction
- Subsystems
- Typology
- Interplanetary Spacecraft
- Launch vehicles
- Space stations

8. Space Vehicles

2



➤ **The objectives of this unit are:**

- To identify the subsystems of a spacecraft.
- To establish the different typologies of spacecraft.
- To know the different configurations of interplanetary spacecraft.
- To know the different kinds of launch vehicles.
- To know the space stations configuration.



➤ **The functional requirements of the space segment (space vehicle) of a spatial mission are derived from the objective of proper operation of its payload.**

The accomplishment of the objective is facilitated by dividing the platform in different subsystems (not necessarily independent).

Generally:

- Structure and mechanisms
- Energy and power
- Telemetry and remote control
- Attitude and orbit control
- Thermal control
- Atmosphere control and vital support
- Propulsion

➤ **Structure and mechanisms**

The structure is the skeleton that holds all the hardware (equipment) and bears all the mechanical loads produced by the launch vehicle accelerations and vibrations, together with the thermal stresses in orbit. The mechanisms of deployment and retraction of the communication systems are included within this group. The vacuum conditions and thermal stresses are especially critical in the design of mechanisms.

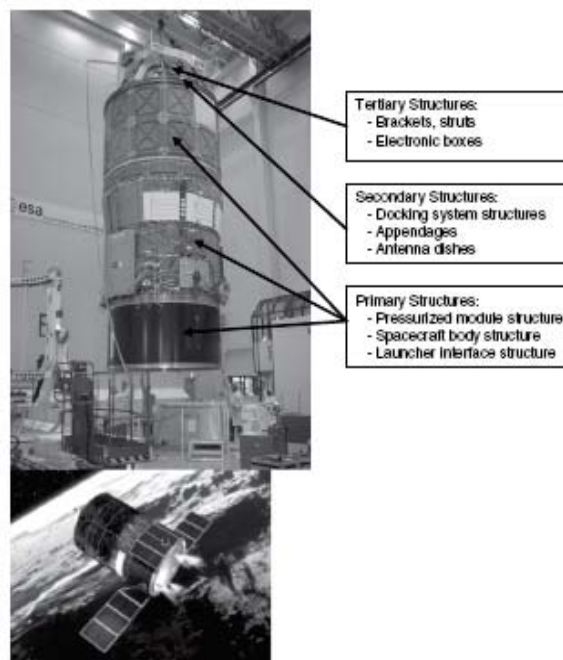

FIGURE 17.1 Categories of structures (ESA Automated Transfer Vehicle) (Courtesy of ESA).

➤ **Energy and power**

It comprises the generation, storage and distribution of the electric energy supplied to the hardware.

- **Telemetry and remote control:** It is in charge of keeping in touch with the ground segment in both its downlink and uplink.
- **Attitude and orbit control:** In charge of the satellite orientation process, comprising both the attitude stabilization and the control maneuvers.

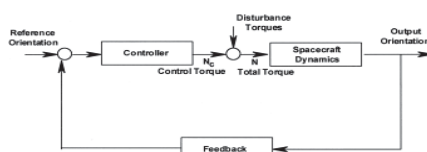

FIGURE 13 Closed-loop attitude control schematic.

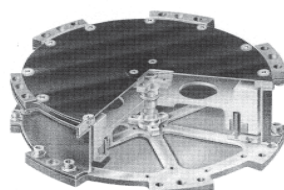
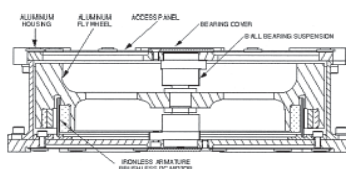

FIGURE 14 ITHACO TorqueWheel (Courtesy of ITHACO Space Systems, a wholly owned subsidiary of B.F. Goodrich).

➤ **Thermal control**

System in charge of keeping each element aboard within the adequate temperature limits for its proper operation during all the phases of the mission with the minimum resources.

➤ **Atmosphere control and vital support**

Present in manned flights and spatial stations. It comprises the creation of an atmospheric environment, temperature and humidity adequate maintenance, water supply, sanitary facilities, medical assistance and facilities for the crew for exercise.

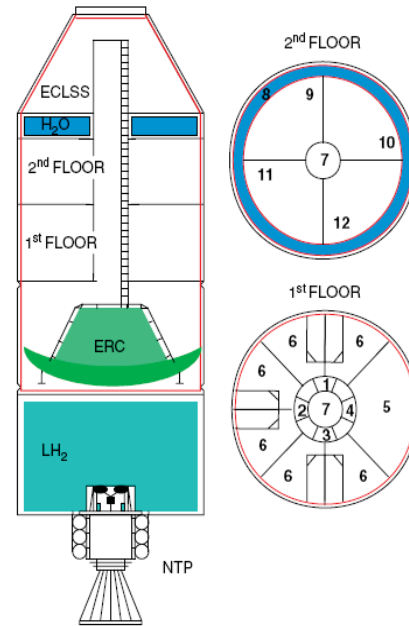

Fig. 11. Schematics of the habitation module: 1. WC, 2. shower, 3. storage, 4. kitchen, 5. living room, 6. crew accommodations, 7. tunnel, 8. water tank, 9. medical care, 10. storage, 11. control room and 12. fitness/workshop.

➤ **Propulsion**

The propulsion needs of the satellites and spacecraft arise as a consequence of needing to perform maneuvers for the change of orbit and attitude.

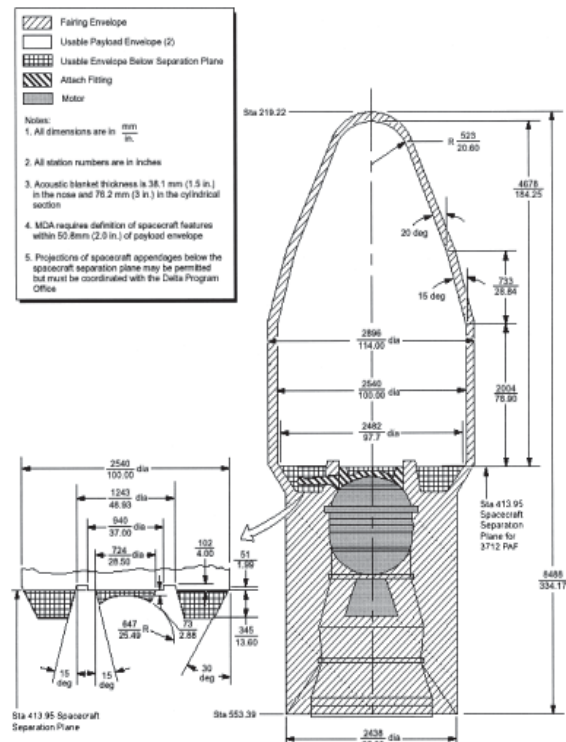

FIGURE 18 Delta II spacecraft envelope for 2.8-m diameter fairing, three-stage configuration. (Courtesy of the Boeing Company.)

- **The functional requirements of the space segment (spacecraft) of a spatial mission are related to a proper operation of its payload.**

Mission type	Spacecraft type
Space exploration	Interplanetary spacecraft: Fly-by, orbiters, atmospheric probes, landers, rovers, planetary aircraft
Transport	Launch vehicles
Scientific	Space stations
Communications Navigation Exploration Surveillance Earth observation	Satellites and satellite constellations

- **The interplanetary spacecraft configuration is influenced by 2 main factors:**
- Large distances: to the Sun (insufficient solar energy) and to the Earth (large antennas and high transmission power)
 - Heterogeneous group with varied requirements, since the features of each planet vary too.

Fig. 1 An artist's conception of the STEREO mission. Two nearly identical spacecraft situated well off the Earth-Sun line, making simultaneous measurements of the Sun

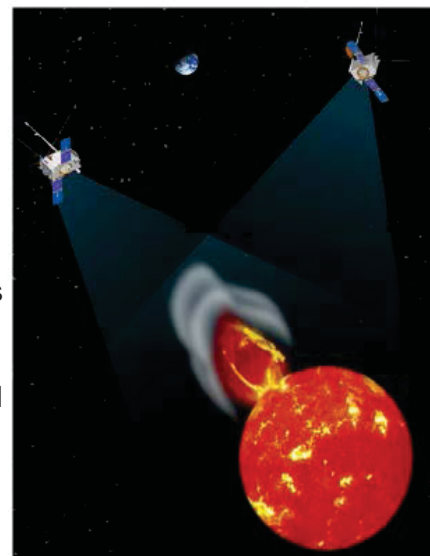

The interplanetary aircraft are specialized systems designed and built to gather and transmit information in extremely hostile environments. Their features strongly vary depending on the kind of mission they have been designed for.

➤ Classification

- Attending to the way they meet their objective
 - Impact:** The spacecraft impacts on the planet after a ballistic entry.
 - Fly-by:** The spacecraft passes at a certain distance from the planet in order to perform the necessary observations and it moves away from it afterwards.
 - Planet satellite (orbiter):** The spacecraft approaches the planet maneuvering in such a way that it stays within its gravitational field, orbiting around it. Thereby, continuous observations and measures are performed on the planet.
 - Lander:** Normally part of an orbiter. The descent, which must be controlled to avoid damage, can be:
 - Braking** with rockets in celestial bodies without atmosphere.
 - Landing with aerodynamic braking** in planets with atmosphere.
 - Rover:** Vehicle designed to travel over the surface of a planet.
 - Planetary aircraft:** Aircraft adapted to the atmosphere of the celestial body to be studied.

- Attending to the way they are controlled
 - Manned or inhabited:** The spacecraft transports people
 - Automatic:** It carries no crew
- Attending to the destination
 - Solar:** Reconnaissance of the Sun with or without impacting on it.
 - Lunar:** Reconnaissance and/or landing (or impact) on the Moon.
 - Spacecraft to inner planets:** Spacecraft to Mercury and Venus.
 - Spacecraft to outer planets:** Spacecraft to Mars, Jupiter, Saturn, Uranus, Neptune (and Pluto?). It includes the spacecraft travelling to the satellites of the previous planets and asteroids close to them.
 - Cometary spacecraft:** Sent to comets.
 - Spacecraft whose final destination is outside the **solar system** could be considered.
- Other types
 - Civil / military.**
 - Balloon spacecraft:** for atmosphere and planetary surface observation
 - Penetrator spacecraft:** to obtain underground information

➤ Fly-by

- Continuous trajectory, never captured by any gravitational field.
- Capability of observing moving objectives.
- High data download velocity from the Earth.
- Capability of storing information when the Earth remains hidden from the view of the vehicle.
- Capability of surviving during long periods of interplanetary journey.

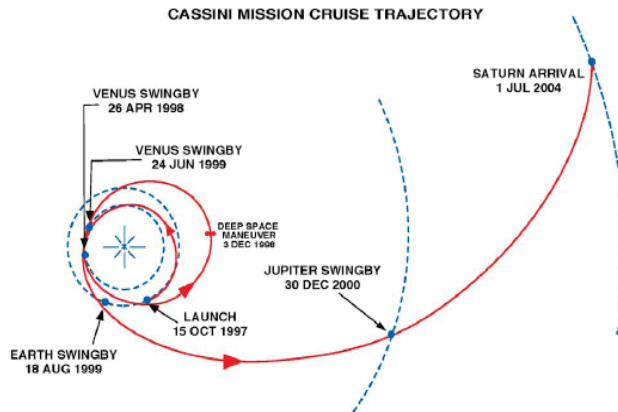

Employed especially in the first stages of space exploration

Fig. 1. Cassini was launched in October 1997 on a trajectory that would bring it to Saturn in 2004. This trajectory used gravity assists from Venus, Earth, and Jupiter. The Jupiter flyby offered an opportunity to achieve new Jupiter science results in addition to exercising spacecraft instruments and teams in a manner that emulated the Saturn tour operations.

➤ Fly-by

- The Voyager 1 and Voyager 2 vehicles were sent to the outer space at the end of 1977 in Titan III launch vehicles with a Centaur upper stage. They were the first successful missions to Jupiter (1979) and Saturn (1980 and 1981). An extended mission of the Voyager 2 successfully reached Uranus in 1986 and Neptune in 1989. In 1995 both satellites remained alive and performing interplanetary routes and interstellar space studies.
- The Voyager 1 is more than 100 AU far away from the Earth.
- Up-to-date they are around the heliopause.
- It is expected that both continue being active for a while, but they suffer from budget problems.

These probes are the artificial devices farthest ever sent by the human being.

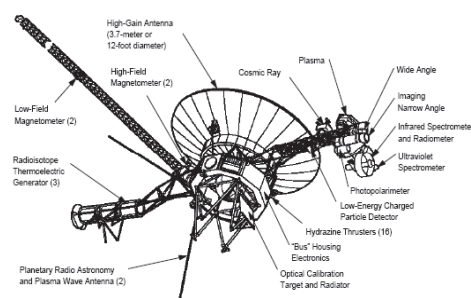

➤ Orbiter

- Spacecraft designed to travel to far planets and enter into their orbit.
- They have enough propulsion capability to brake the vehicle in the moment of entering into the orbit.
- Designed to overcome solar occultations when the planet locates between the vehicle and the Sun, avoiding the solar panels from being illuminated and submitting the vehicle to important thermal gradients.
- It will also be submitted to Earth occultations, preventing the communication to happen.
- They are employed in the second stage of the solar system exploration, to gain a higher knowledge with the study of the planets.
- Some examples are: Magellan, Galileo and Mars Global Surveyor.

➤ Orbiter

- The Magellan was sent to space at the beginning of 1989 through the Atlantis space shuttle with a IUS upper stage and Venus as its destination. By the end of its fourth rotation around Venus (243 days each), it had traced 98% of the Venus surface with altimetry and radiometry.
- After providing images of Venus, the Magellan was willfully destroyed in October 1994.

Magellan

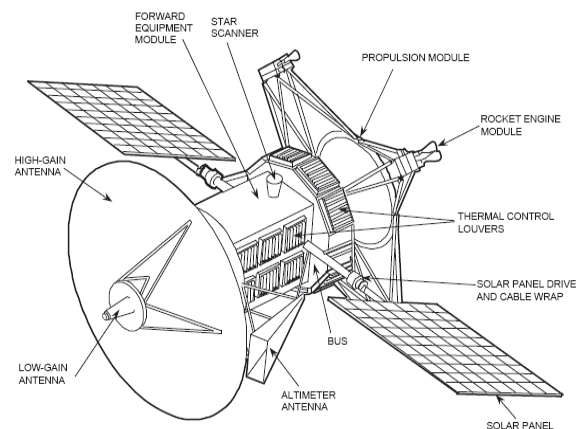

➤ Lander

- Designed to reach the planet's surface and survive enough to gather information and send it to the Earth.
- Some examples are:
 - Venera russian landers that survived to Venus dust in order to perform chemical analyses of its rock composition and provided colour images of it.
 - JPL (NASA's Jet Propulsion Laboratory) landers in Mars or Surveyor on the Moon.
 - Mars Pathfinder was launched on the 4th December 1996 aboard a Delta rocket to analyze the martian atmosphere, climate, geology and rock and soil composition.

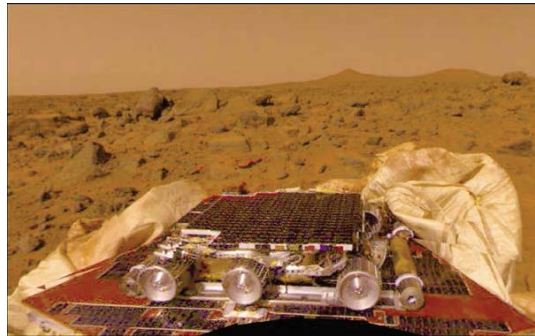

➤ Lander

- The Viking 1 landed on Mars in July 1976, followed by the Viking 2 a month later. These automatic scientific labs photographed their surroundings and obtained information about the structure, surface and atmosphere of the planet. Besides, they carried out a first investigation about the possibility of past and present life in Mars

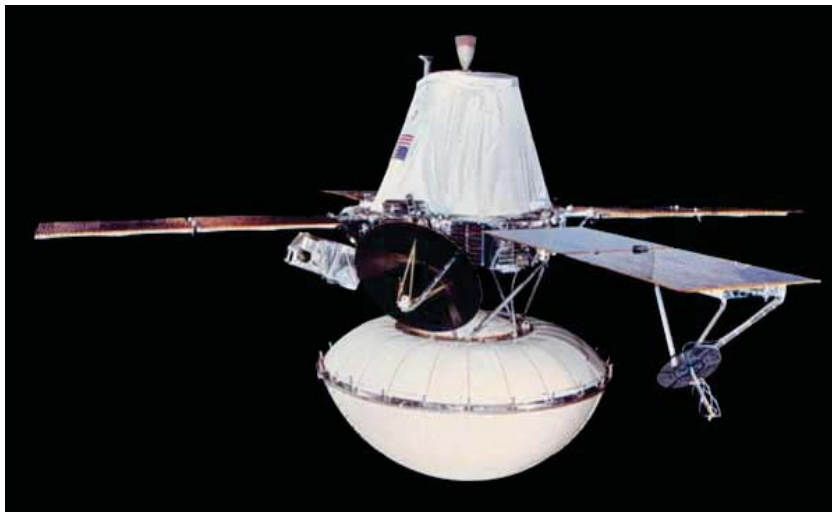

➤ Atmospheric probe

- Some missions employ one or more instrumented small vehicles that separate from the main vehicle to study the atmosphere of the planet as they fall.
- The atmospheric probes separate from the main vehicle thanks to simple systems that do not modify the trajectory substantially. However, a correction maneuver is necessary in some occasions.
- A thermal shield protects the probe from the temperature achieved during the atmospheric entry.
- The shield is ejected and a parachute reduces the falling velocity of the probe until it reaches the surface.
- The probe sends data to the main vehicle, which in turn sends it to the Earth.

➤ Atmospheric probe

- The atmospheric probe of Galileo was released from the orbiter in July 1995, 100 days before it reached Jupiter in order to study its atmosphere.
- The atmospheric entry took place on December 7th 1995, when the probe gathered information about the chemical composition and the physical state of the atmosphere to be sent to the Earth. The probe barely beared Jupiter's atmosphere for 1 hour.

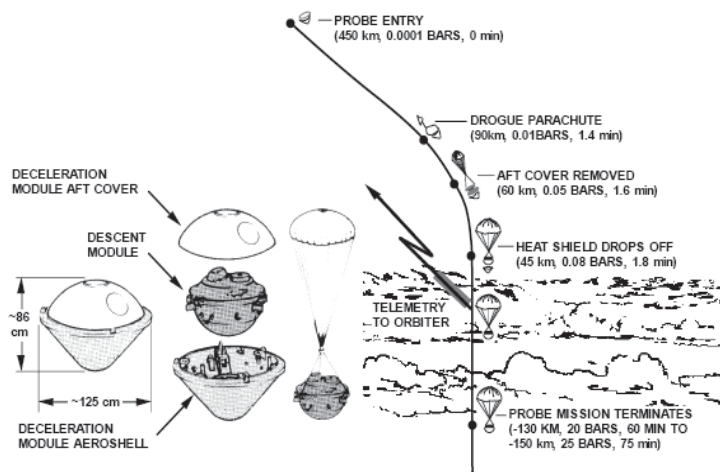

➤ Rover

- Rovers are electric vehicles designed to travel over the surface of the bodies to be studied.
- Rovers are generally semi-autonomous vehicles that can be controlled from the Earth.
- The Mars Pathfinder mission includes rovers.

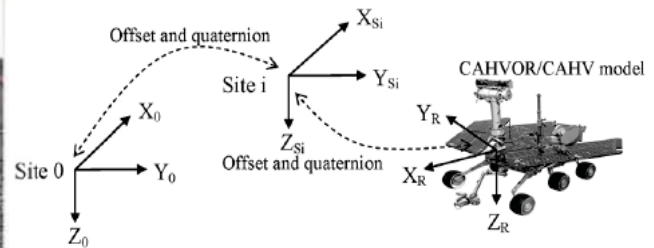
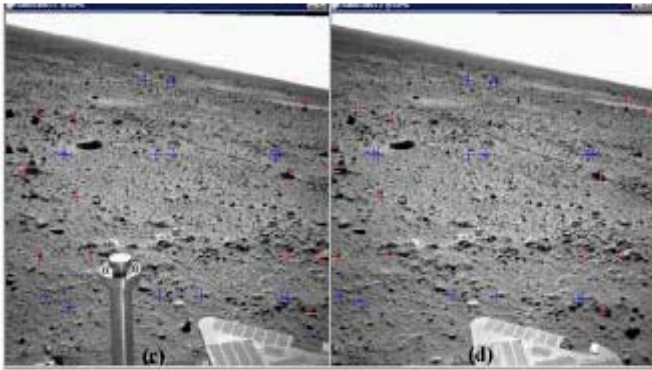

Fig. 1. Reference frames: site frame and rover frame.

➤ Penetrators

- Surface penetrators are designed to cross the surface of a body, such as a comet, surviving to an impact of hundreds of g's, measuring and sending data about the properties of the surface it comes across. Generally, data are sent to the main vehicle, which forwards them to the Earth.

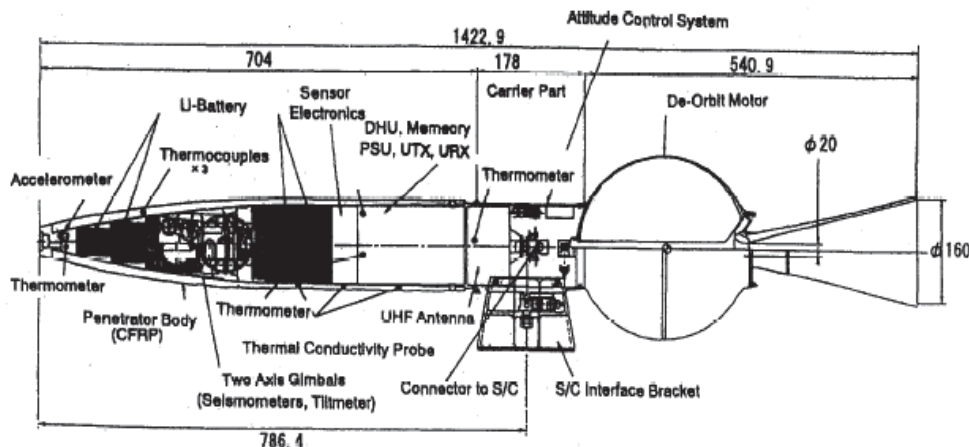

Fig. 1. Internal structure and size of the Lunar-A penetrator.

➤ Atmospheric balloon

- Atmospheric balloons are designed to remain floating over the atmosphere and going adrift, so that they provide information about the atmospheric movement. They are relatively simple and only need a power source for the transmitters that make it possible to determine their position over time. In occasions they may have probes to measure atmospheric properties (composition, temperature, pressure, density...).

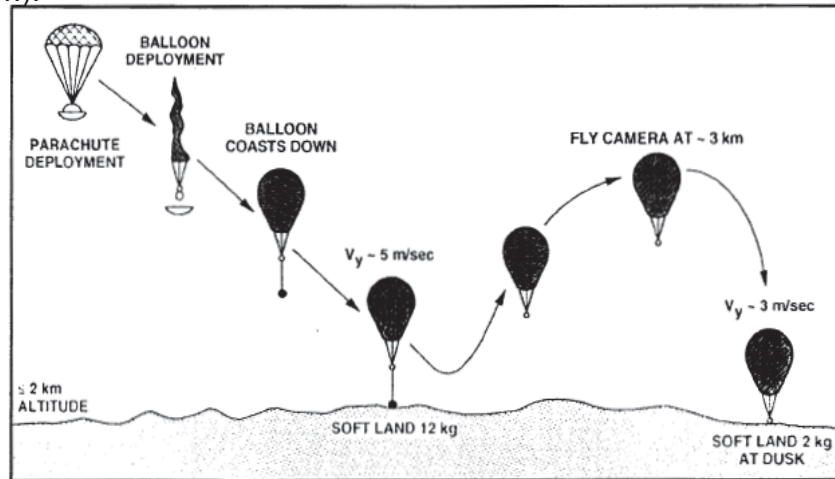

Figure 2. Mars Solar Balloon Mission Scenario

➤ Planetary Spacecraft

- Some studies have been carried out in order to evaluate the possibility of building aircraft, similar to the ones employed on Earth, to perform observations in the planets.
- Reaction propulsion using the atmosphere of the planet and a nuclear reactor.
- The fuel (nuclear) would be 1% of the spacecraft's mass (in terrestrial vehicles it is about 30% of the aircraft's mass).
- They can't be used in: Mercury, Pluto and Solar System satellites.

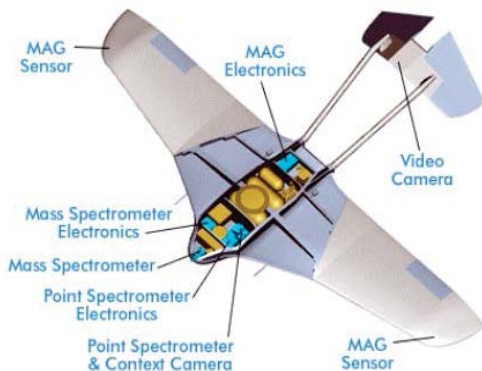
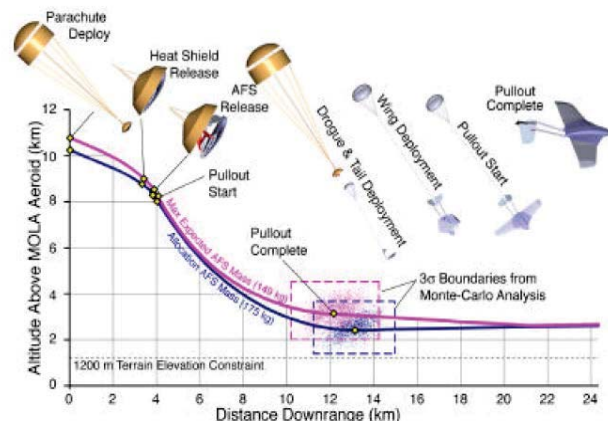

Figure 1. ARES Aircraft And Instrumentation



		Empuje (N)	Empuje/peso	Impulso específico (sg)	Fluido de Trabajo / $T_{max}(K)$	Estado	Tiempo característico	Aplicaciones	
Propulsion Fluidodinamica	Químicos	Sólidos	$0-10^7$	$<10^2$	≤ 280	Gases Comb. Prop. Solidos 3000	Utilización	Segundos	JATO, Misiles y Misiones Espaciales en General
		Líquidos	$0-10^7$	$<10^2$	≤ 500	Gases Comb. Prop. Líquidos 4500	Utilización	Minutos	JATO, Misiles y Misiones Espaciales en General
		Híbridos	$0-10^6$	$<10^2$	≤ 350	Gases Comb. Prop. Solidos y Líquidos	Investigacion y Desarrollo	Minutos	JATO, Misiles y Misiones Espaciales en General
	Nucleares	Fisión	$<10^5$ (no pequeños)	3×10^1	≤ 1000	H_2 3000	Investigacion y Desarrollo	Minutos	Misiones de Superficie e Interplanetarias
		Fusión	- - - -	10^{-1}	3000		Investigación Básica	- - - -	Especulativas
	Electricos	Resisto-jet	0-5	10^{-2}	150-800	N_2, NH_3 3000	Utilización	Dias	Misiones de Satélites
		Arco eléctrico	0-1.0	$10^{-4}-10^{-2}$	280-1500	N_2H_4, H_2, NH_3 5800	Utilización	Meses	Misiones de Satélites
		Electrostáticos (acelerad. iones)	0-1.0	$10^{-6}-10^{-4}$	1500-25000	X_e	Utilización y Desarrollo	Meses	Misiones de Satélites e Interplanetarias
		Electromagnético. (acelerad. plasma)	0-2	$10^{-6}-10^{-4}$	1500-15000	H_2	Utilización y Desarrollo	Meses	Misiones de Satélites e Interplanetarias
		Fotónicos	- - - -	- - - -	3.16×10^7		Especulativo	Años	Especulativas ¿Estelares?

- The first time the human being reached the space was October 4th 1957, through the Sputnik 1.
- Since then, 30 annual launches have been carried out from 10 points of our planet.
- Nowadays, about 8500 artificial objects of large size orbit the Earth.
- The Geostationary Earth Orbit (GEO) is practically saturated and the possibility of chain collisions in the Low Earth Orbits (LEO) is starting to be considered.
- Young technology
- 45 years after the first propelled aircraft flight (1890-Clément Ader), aviation was still at its childhood: the maximum velocity was still below $M=1$, the most sophisticated propulsion systems were the propellers, and the intercontinental airlines had not been inaugurated yet.
- What will the future spatial transport vehicles look like?



FIGURE 1 Venture Star.

➤ **Fundamental parameters of the launch vehicles**

Velocity change: The first function of the launch vehicle is to provide the payload with the necessary velocity increase to reach the target orbit.

$$\Delta V = \int \frac{F}{m} dt$$

Propulsion - Specific Impulse: The fundamental equation of the rockets determines that the thrust of a rocket is proportional to the exhaust gases mass flow rate times their exit velocity.

$$F = \dot{m} \cdot V_e = \dot{m} \cdot g_0 \cdot I_{sp} = \frac{dm}{dt} g_0 \cdot I_{sp}$$

where g_0 is the gravity acceleration and I_{sp} is the specific impulse.

Combining both expressions one can arrive to the Konstantin **Tsiolkovsky rocket equation** (valid for vehicles with a single stage to orbit):

$$\Delta V = g_0 \cdot I_{sp} \ln \frac{M_d + M_p + PL}{M_d + PL}$$

Where:

M_d is the launcher dry mass

M_p is the fuel mass

PL is the payload mass

➤ **Fundamental parameters of the launch vehicles**

Structural properties – Structural ratio: Ratio between the dry mass of the vehicle and the fuel mass.

$$\omega = \frac{M_d}{M_p}$$

combining it with the previous expressions:

$$\Delta V = g_0 \cdot I_{sp} \ln \frac{M_p (1 + \omega) + PL}{M_p \omega + PL}$$

from where it is deduced that the performance of a launch vehicle with a given payload to reach a certain orbit, exclusively depend on the specific propulsion and the structural index.

The previous expression can be generalized for any number of stages. In any case, 2 parameters (I_{sp} and ω) will be enough to define each of the stages.

➤ **Evolution of the launch vehicles**

• **First generation:**

- Derived from intercontinental missiles.
- Still employed nowadays.
- The Delta launcher family (USA) comes from the Thor missile (1963).
- The Atlas (USA) comes from the missiles of the same name from the 50s.
- The Titan (USA) come from the Atlas.
- The Soyuz are based on the R7 missile.
- The chinese Long March launcher family has its origin on the CZ-1 missile (1970).
- The modifications these launch vehicles have been suffering are mainly an increase in the loaded fuel as a consequence of the higher energetic demand of the missions, the development of new stages and the use of boosters to increase the thrust in the first stages of the launch.

• **Second generation:**

- It started with the development of the Ariane family (EU), the first launch vehicles entirely developed from a commercial point of view and not based on previous missiles. Their performance allowed to get a high part of the launching market share thanks to the reduced costs.

➤ **Evolution of the launch vehicles**

• **Second generation:**

- In 1981 the first launch of the Space Transportation System (STS) is carried out with a reusable launcher. The idea was to develop a launch vehicle suitable for any mission. 100 launches/year with a target cost of 5M\$/launch. The predictions were too optimistic and the STS was discarded as an autonomous launch vehicle, especially after the Challenger disaster (1986).

• **90s - Present day:**

- A new generation of launch vehicles is required to adapt to the actual commercial demands.
- The typical development time of a launch vehicle is 10 years.

➤ Evolution of the launch vehicles

• Present situation – Missions and market

–Geoestationary Earth Orbits (GEO): 30-40 satellites/year with a wide variety of loads (2-7 tons). To reach this part of the market the launch vehicles must be very flexible or focus only in a market niche (3-5 tons, per instance).

–Low and Medium Earth Orbits (LEO, MEO): The telecommunications satellite constellations have a promising future (Iridium, Globalstar, ...).

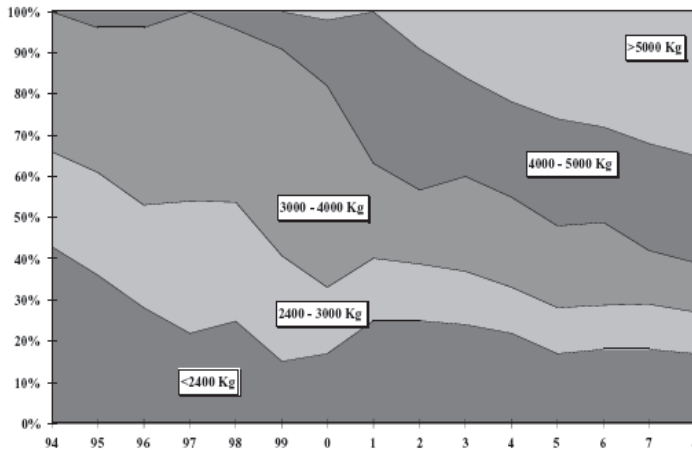

FIGURE 2 Geostationary satellites commercial market distribution (Arianespace).

–They require launch flexibility:

–Packs of 6-8 satellites / individual satellites

–Satellite mass: [500, 2000] kg

–Orbits of [700, 1500] km

–Orbit inclinations [60, 100]°

–Missions to the International Space Station: the STS is still the reference system for manned missions.

–Governmental, institutional (GPS, Galileo) and military missions will still have a relative importance.

➤ Evolution of the launch vehicles

• Present situation – Design parameters

2 design ways to build LVs with the necessary flexibility:

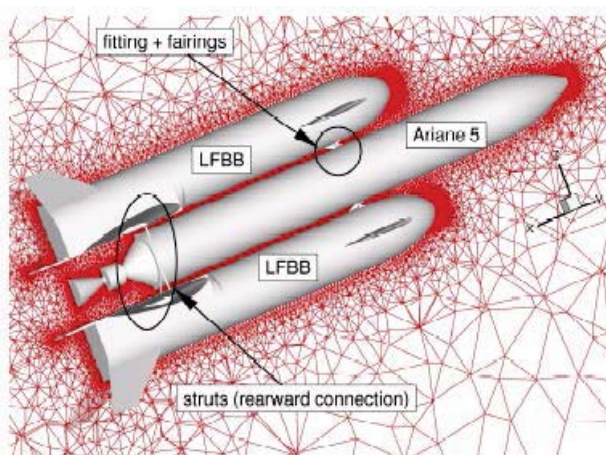

Fig. 1 Ariane 5 with liquid fly-back boosters

- A single launch vehicle of big size and capable of several deliveries (Ariane 5G). In this case the costs are reduced by proposing a unique version of the vehicle and put several satellites in orbit per flight.
- Modular design of the launch vehicles (Delta 4, Atlas 5, H2-A and Angara). In this case, the launcher adapts to the mission considering the combination of several modules. The costs are intended to be minimized by adapting the LV to the requirements of each launch. It requires numerous versions, making it difficult to rationalize the production and increasing the design and fabrication costs.

➤ **Evolution of the launch vehicles**

• **Present situation – Critical parameters**

The launch sequence is divided in two stages:

–Initial launch stage: The main objective is to extract the vehicle of the atmosphere avoiding, as far as possible, three effects:

»Aerodynamic drag: The thrust of the vehicle must overcome the air drag.

$$D = \frac{1}{2} \rho V^2 S C_D$$

»The air friction originates severe dynamic conditions to the vehicle. In the surroundings of the maximum dynamic pressure, with velocities close to Mach 2, the vibrations due to the air friction are critical for the structure.

»The thermal loads due to atmosphere friction may be important. The heat flux in W/m² is:

$$\phi \propto \frac{1}{2} \rho V^3$$

–Second launch stage: It begins when the body leaves the atmosphere. A typical value is 100 km, when the heat due to solar radiation (1400 W/m² approx.) reaches the value of the heat flux due to friction with the

➤ **Evolution of the launch vehicles**

• **Present situation – Propulsion systems**

–The propulsion system requirements depend on the launch stage:

»Initial launch stage: In order to quickly leave the atmosphere, the design of the first stage will focus on the search of a high thrust, even at expenses of a low efficiency of the propulsion system.

»Generally: solid fuel or liquid hydrocarbons with liquid oxygen

»For long first stages: liquid hydrogen (Delta 4 and Atlas 5)

»Second launch stage: In this stage, since the drag is lower, the efficiency prevails. Thus, modern launch vehicles employ liquid hydrogen and oxygen.

➤ **Evolution of the launch vehicles**

• **Present situation – Propulsion systems**

–Solid propulsion (first stage):

»Advantages: Simplicity, storable over long periods, high density (low volume required), a high variety of thrust laws can be obtained.

»Drawbacks: Low specific impulse (60% higher mass required compared to propellants with higher impulse), low regulation capability (expensive and heavy inhibitors), high reliability but catastrophic failure. Since they work at high pressures (60 bar), they require resistant coverings and thus are heavy (high ω).

–Liquid propulsion LH2 + LOX (second stage SSME in the Space Shuttle or LE7 in the H-II and first stages of the Vulcain or the Ariane 5):

»Advantages: maximum efficiency, maximum specific impulse.

»Drawbacks: For pressures higher than 1 bar, the H2 only remains in liquid state at very low temperatures (-250°C). In order to reach that temperature it is necessary to cool it, increasing the complexity of the propulsive system and introducing a problem of dilatation of different materials. The LH2 density is low (70kg/m³, 14 times lower than that of the water), thus the storage volume must be large and there appear cavitation problems at the entry of the pumps. The LOX-LH2 mixture does not self-ignite, an ignition sequence is required.

➤ **Evolution of the launch vehicles**

• **Present situation – Propulsion systems**

–Liquid propulsion LOX + hydrocarbon (RD180 boosters in the Atlas 5, boosters for some Ariane 5 variants, RD191M in the Angara family and evolution of the LE7 in the H-IIA):

»In use from the first USA and URSS rockets.

»Slightly lower performance than LOX-LH2 but with less complexity.

»Its high density (kerosene 820kg/m³ and methane 420kg/m³) reduces the space requirements and allows more simplicity.

➤ Evolution of the launch vehicles

• Present situation – Proposals

– Delta IV (USA): Launch vehicles family

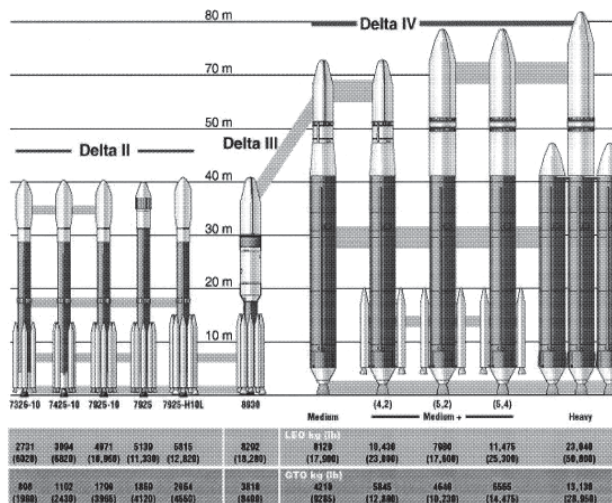

FIGURE 6 The Delta series of launch vehicles. (Courtesy of the Boeing Company.)

» Main stage: CBC (Common Booster Core) propelled by the RS-68 engine with 216 t of LOX-LH2.

» 2nd stage propelled by the RL10B2 engine with 17 t of LOX-LH2. This stage is replaced by a solid propulsion one in the smaller variant of the Delta 4.

» Additional boosters: Up to 4 with solid propulsion (GEMS-Plus) of 17 t of propellant each, or up to 2 with liquid propulsion (2 CBC in the heavier version).

» Three kinds of decks for the payload from 2 to 5 m of diameter.

» The varied kind of vehicles make it possible to send loads from 2.2 to 13.2 t to the GTO (Geostationary Transfer Orbit).

➤ Evolution of the launch vehicles

• Present situation – Proposals

–Atlas V (USA): Launch vehicles family

»Central stage: CCB (Common Core Booster) propelled by the RD180 engine with 248 t of LOX-Kerosene.

»2nd stage Centauri propelled by one or two RL10A4 engines with 20 t of LOX-LH2.

»Up to 5 additional boosters with solid propulsion of 36 t of propellant each.

»Two kinds of decks depending on the payload requirements.

»Flexibility: from 4 to 8.2 t to the GTO

–Ariane 5-C (EU): As all the Ariane from the 80s, it is designed to send two satellites to the GTO simultaneously. Therefore, the requirements are of the order of 2 times the maximum payload expected in 2005.

»Two boosters with solid fuel of 240 t (EAPs)

»A central stage (EPC) with a Vulcan-2 engine (170 t of LOX-LH2)

»A second stage (ESC-B) with a Vinci engine (26 t of LOX-LH2)

»A deck for the payload of 5.4 m diameter.

»It allows to launch 2 payloads of 6 t each to the GTO.

»Nowadays: in study the Ariane 2010, that will allow to send 2 payloads of 7.5 t each to the GTO.

➤ Evolution of the launch vehicles

• Present situation – Proposals

–H-IIA (Japan): Family of launch vehicles

»Central stage: propelled by the LE-7A engine with 86 t of LOX-LH2.

»Two boosters with solid fuel of 65 t.

»A second stage propelled by a LE-5B engine (16 t of LOX-LH2)

»A deck of 5 m diameter.

–Angara (Russia): Based on solid propellers and LOX-Kerosene. The objective is to reach 2 to 20 t to the LEO.

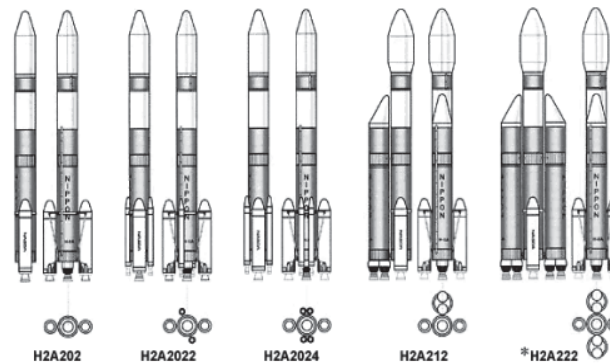

FIGURE 4 H-IIA family (NASDA).

➤ Evolution of the launch vehicles

• Present situation – Proposals

–It is not expected to develop new non-recoverable launch vehicles apart from small modifications of the present ones focused to cost reduction.

TABLE I Selected Launch Vehicles

Country	Company	Capability
China		
Long March	China Aerospace Corp.	2,300–4,800 kg to GTO
European Space Agency		
Arian 4	Arianespace	4,500 kg to GTO
Arian 5	Arianespace	6,800–12,000 kg to GTO
India		
CSLV	India Space Res. Org.	2,500 kg to GTO
Japan		
H II	NASDA	4,000 kg to GTO
H IIA	NASDA	7,500–9,500 kg to GTO
J-I	NASDA	3,500 kg to GTO
Russia		
Proton	Lockheed Martin	2,500–6,220 kg to GTO
Soyuz	STARSEM	3,600–6,070 kg to LEO
Zenit	KB Yuzhnoye/Sea Launch	6,500–13,740 kg to LEO
United States		
Athena I	Lockheed-Martin	820 kg to LEO
Athena II	Lockheed-Martin	2,050 kg to LEO
Atlas I	Lockheed-Martin	2,250 kg to GTO
Atlas II	Lockheed-Martin	3,050–3,600 kg to GTO
Atlas III	Lockheed-Martin	4,550 kg to GTO
Atlas V	Lockheed-Martin	6,000 kg to GTO
Delta II	Boeing	1,800 kg to GTO
Delta III	Boeing	3,810 kg to GTO
Delta IV	Boeing	4,173–13,200 kg to GTO
Pegasus XL	Orbital Sciences	500 kg to LEO
Space Shuttle	NASA	68,000 kg to LEO
Taurus	Orbital Sciences	1,360 kg to LEO
Titan III	Lockheed-Martin	1,850–5,000 kg to GTO
Titan IV	Lockheed-Martin	18,600 to GTO

➤ Recoverable Shuttles

- The costs of a launch vehicle are tremendous (>100M\$ for the big missions).
- About 70% of the vehicle cost is the hardware.
- The idea of using recoverable shuttles is justified (aircraft are...).
- Problems:
 - Hardware for the recovery.
 - Harder requirements.
 - Additional resources.

Reusability has an associated cost. However, cost reduction may vary in a factor from 2-10 depending on the kind of vehicle and the optimism of the analysis.

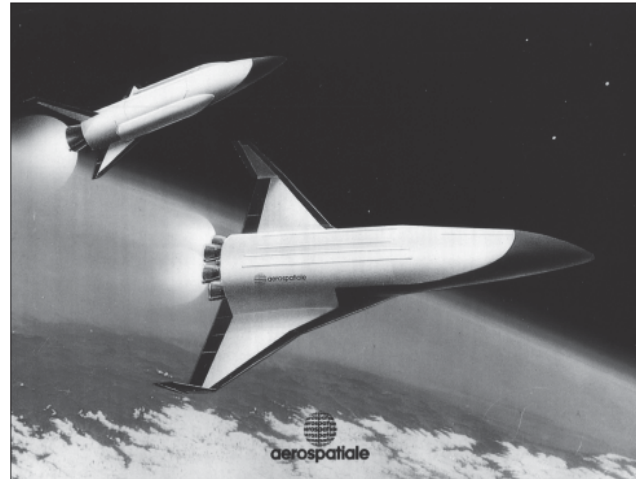

FIGURE 7 Tarania (EADS-LV).

➤ Recoverable Shuttles

Important challenges

- Recoverability:
 - Global recovery (manned and scientific)
 - Partial recovery (commercial missions)
- Number of stages:
 - SSTO: Simpler global design (airplane type design), but very sensitive to the propeller design parameters, must be way bigger than a TSTO for the same performance.
 - TSTO: More complex design, but higher adaptability and smaller size.

E Sänger design
previous to
WW2

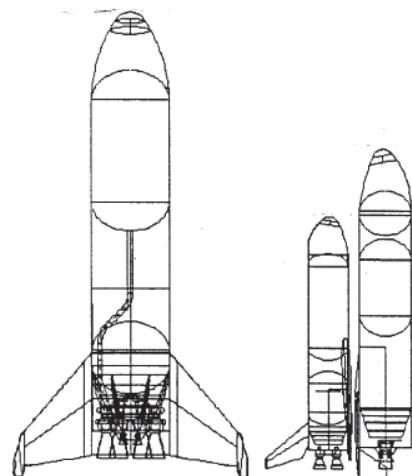

Size comparison of an SSTO and a TSTO (Boeing).

➤ **Recoverable Shuttles**

 ➤ **Recoverable Shuttles**

Important challenges

- Recovery of the first stage: it implies a technically complex solution if the first stage is intended to be recovered at the launch site, or a logistically complex solution if it is recovered at other site.
- Abortion strategies:
 - The loss of a shuttle results in a financial shock (higher development and production cost), and also technological (design rethinking, STS-Challenger).
 - The abortion strategies must allow to recover the vehicle:
 - »Number of engines (redundancy).
 - »Landing sites choice.
 - »Strategies of removal of fuels before landing.
- Technological challenges:
 - Thermal protections (reentry temperatures)
 - Reusable propulsion (the highest reutilization rate is 21: SSME)
 - Aero-thermodynamic (more complex shapes)
 - Light structures

➤ Recoverable Shuttles

The importance in the design of the transport vehicle is based on its payload, the utility cost and the way it is launched. From the beginning, the shuttles have been rockets improved over time. However, the future is directed towards vehicles that are not only reusable (lower cost) but also independent from any launcher (less infrastructure).

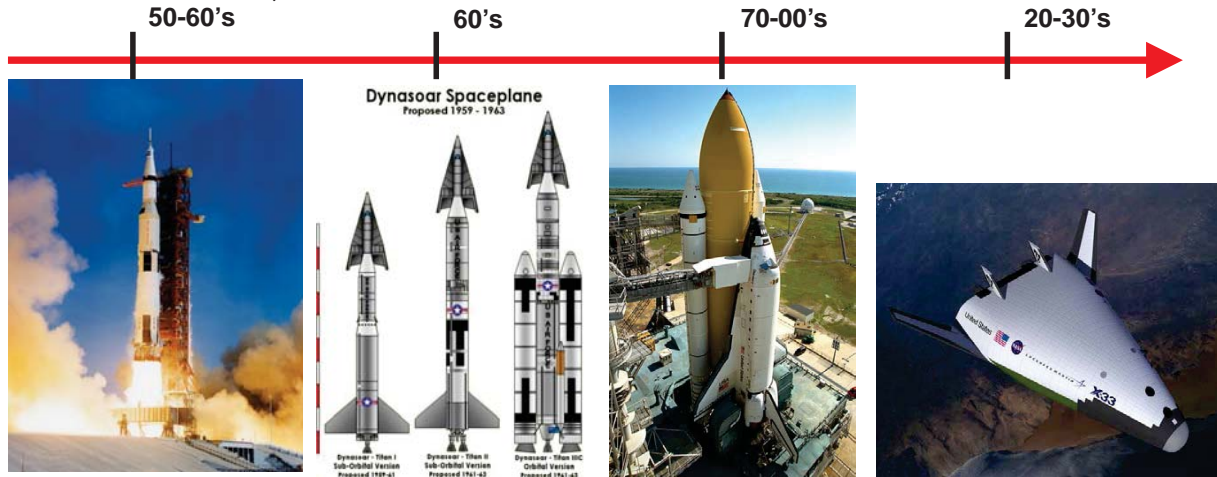

Photographies: NASA

From left to right: Apolo (Saturn V), Dynasaur X-20 Project (TITAN rocket), Atlantis Shuttle, X-33 Shuttle (sketch).

➤ Space Stations

A space station is an artificial structure designed to be inhabited in the outer space, with different aims. It is distinguished from other manned spacecraft for its lack of main propulsion (other vehicles are used as transport from and towards the station instead); and for its lack of landing means.



Photography: NASA

The MIR Space Station coupled to the Atlantis Space Shuttle, photographed during the STS-71.

➤ **Space Stations**
SkyLab (1973-1979)

- After a troubled launch, it was repaired and carried out 300 scientific experiments (astronomy, medical experiments, ...)
- Its crew surpassed the number of aggregate hours in the outer space up to the day.
- Due to funding problems it was left in a stable orbit.
- It fell on the Earth in a sparsely populated zone of Australia on July 11th 1979, without causing personal damages.



SL4-143-4706

Photography: NASA

The SkyLab Space Station seen from the SkyLab 4 Command and Service Modules (CSM) taken during 1974.

8. Space Vehicles

47

 ➤ **Space Stations**

Spacelab (1983-1999): first international cooperation.

Freedom Program: proposed by Reagan to return to the Moon and reach Mars in 30 years

Salyut-Mir (1986-2003): program of the old URSS, cooperations with ESA and NASA after its fall.

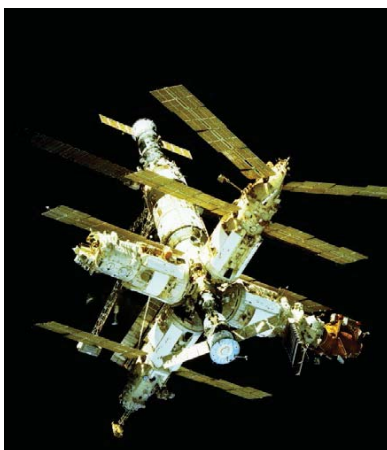

Photography: NASA

MSFC-9702655

The MIR Space Station seen from the Soyuz Space Shuttle, taken during the STS-81 mission in January 1997.

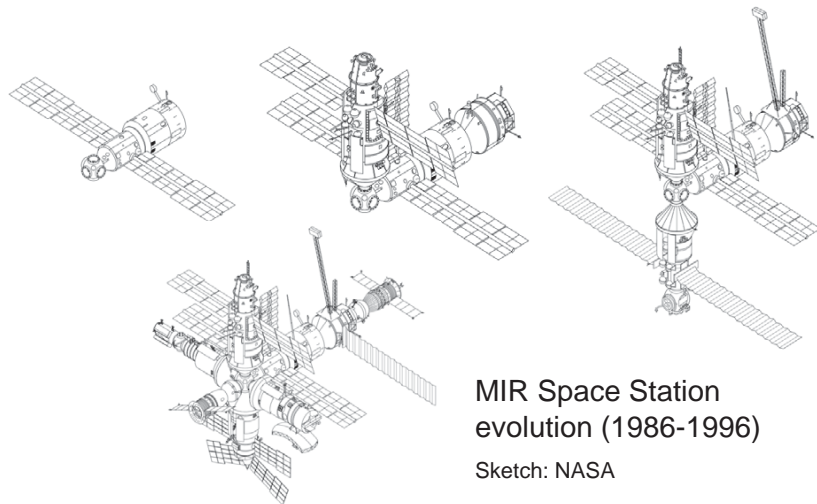
8. Space Vehicles

48



➤ Space Stations

ISS (1993-present):

- Ambitious project (budget, different countries involved).
- Limited use as a starting point for missions to the outer space.
- Utility of the experiments carried out.

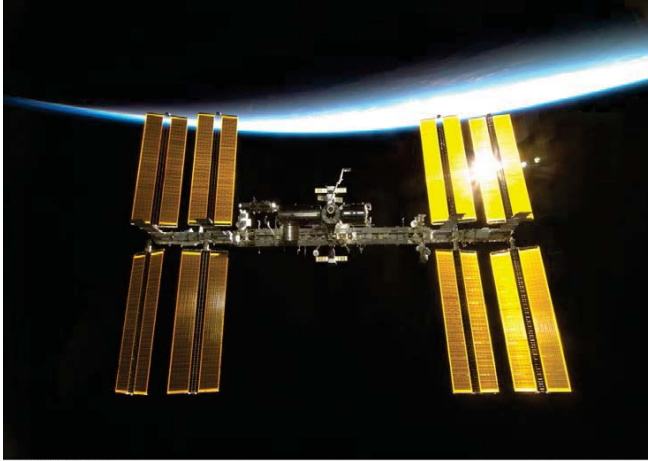

S130E006575

Photography: NASA



Photography: NASA

The International Space Station seen from the Endeavour Space Shuttle, taken during the STS-130 mission in February 2010.

➤ Space Stations

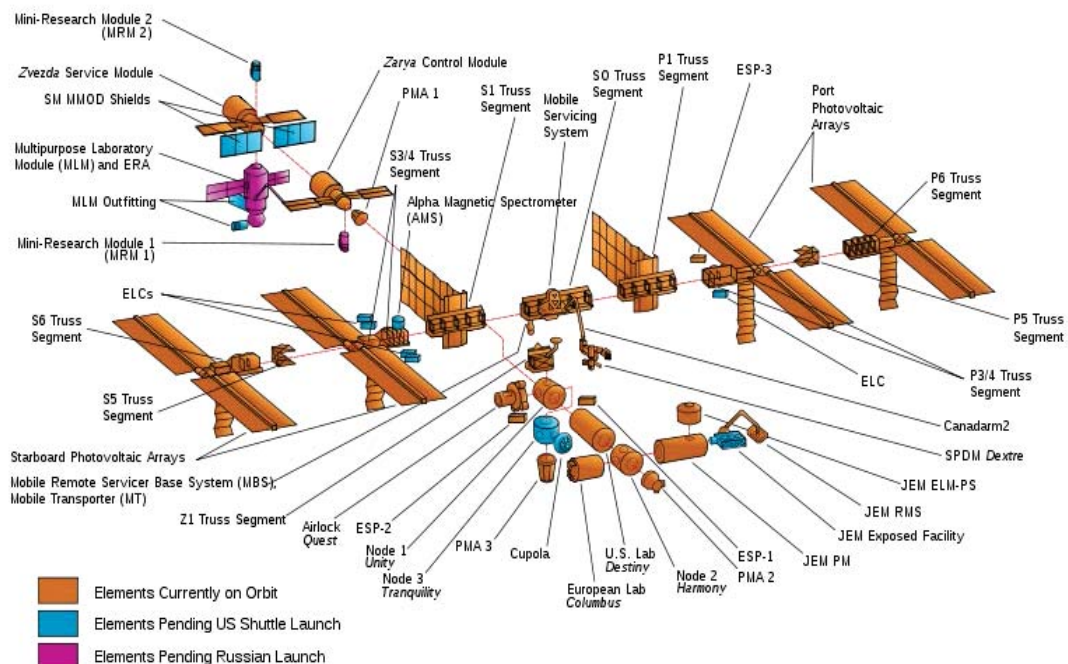

➤ **Space Stations**

Which factors apart from the political/economical ones determine the design of a space station?

- **Attitude Control:** The big mass of the space station makes the masses distribution be critical for the attitude control and the orbit stabilization.
- **Aerodynamic:** Since they are at the LEO, the residual atmosphere produces a continuous decrement in the orbit that must be compensated.
- **Rendezvous:** Coupling to transport vehicles.
- **Pressurized Modules:** Unions, redundant entries.
- **Solar collectors and radiators**
- **Propulsion**
- **Observation and communication** of the payload
- **Environmental control**
- **Life supply**



References

- John David Anderson, *Aircraft performance and design*, Boston: McGraw-Hill 1999
- Ajoy Kumar Kundu, *Aircraft design*, Cambridge etc.: Cambridge University Press 2010
- J. Seddon; Simon Newman, *Basic helicopter aerodynamics*, 1947- Reston: American Institute of Aeronautics and Astronautics cop. 2001
- J. Leishman, *Principles of helicopter aerodynamics*, Cambridge; New York: Cambridge University Press 2006 2nd ed.
- Goordon E Jensen; David W Netzer, *Tactical missile propulsion*, Reston: American Institute of Aeronautics and Astronautics cop. 1996
- Larson. Wiley J.; James R Wertz, *Space mission analysis and design*, Torrance Calif.; Dordrecht; London: Kluwer Academic : Microcosm ; cop. 1999 3rd ed.
- Ian Moir; Allan Seabridge, *Design and development of aircraft systems: an introduction*, London: Professional Engineering Publishing 2004
- Dava Newman, *Interactive aerospace engineering and design*, McGraw-Hill 2001.
- Apuntes de Aeronaves y Vehículos Espaciales*, Publicaciones de la ETSIA-UPM, 1998.
- John D Anderson, *Introduction to Flight*, McGraw-Hill 2008, 6th ed.
- Mark Davies, *The Standard Handbook for Aeronautical and Astronautical Engineers*, McGraw-Hill 2003.
- T.H.G. Megson, *Aircraft Structures for Engineering Students*, Butterworth-Heinemann 2012 5th ed.
- I.H. Abbott; A.E. von Doenhoff, *Theory of Wing Sections*, Dover Publications 1959.
- Roger R Bate; Donald D Mueller; Jerry E White; *Fundamentals of Astrodynamics*, Dover Publications 1971.
- Jan Roskam, *Airplane Design Parts I through VIII (v. 1-8)*, Darcorporation; 2nd edition, 2003
- Denis Howe, *Aircraft Conceptual Design Synthesis*, ed. Professional, Engineering Publishing, 2000
- Jenkinson & Marchman, *Aircraft Design Projects for engineering Students*, ed. Butterworth Heinemann-Elsevier, 2003
- Darroll Stinton, *The Design of the Aeroplane*, Bsp Professional Books, 1985
- David B. Thurston, *Design for Flying Paperback*, Mcgraw-Hill; 2 edition, 1994