

# Optimization procedures and benefits for sustainable water supply systems of tomorrow

BJØRNAR EIKEBROKK / KAMAL AZRAGUE / GEMA RASPATI  
ERWIN BEERENDONK / LUC PALMEN / PETER JARVIS / PAUL WEIR

# trust

# D41.2



## Safe and sustainable water supply: Status of operation performance

### Authors

Bjørnar Eikebrokk, Kamal Azrague, Gema Raspati (SINTEF)

Erwin Beerendonk, Luc Palmen (KWR)

Peter Jarvis (Cranfield University)

Paul Weir (Scottish Water)

---

Final Version

April 2015

---

The research leading to these results has received funding from the European Union Seventh Framework Programme (FP7/2007-2013) under grant agreement n° 265122.

This publication reflects only the authors' views and the European Union is not liable for any use that may be made of the information contained therein

## TABLE OF CONTENTS

<b>List of figures</b> .....	<b>2</b>
<b>List of tables</b> .....	<b>5</b>
<b>1. Introduction</b> .....	<b>6</b>
<b>2. Optimization framework</b> .....	<b>7</b>
2.1. Technical Evaluation and Optimization .....	8
2.2. Environmental Impact Assessment .....	8
2.3. Economic Evaluation .....	9
2.4. Multi-Criteria Assessment.....	9
<b>3. Case studies</b> .....	<b>10</b>
3.1. Test sites & Description of Current Status .....	10
3.2. Case Studies in Norway .....	11
3.2.1. Hygienic barriers and indicator requirements.....	12
3.2.2. Problem definition.....	13
3.2.3. Enhanced coagulation optimization .....	16
3.2.4. Alternatives to be evaluated.....	24
3.2.5. Removal efficiencies.....	25
3.2.6. Environmental impact assessment using LCA.....	26
3.2.7. Economic Evaluation .....	31
3.2.8. Multi-criteria assessment .....	33
3.2.9. Summary from case study in Norway.....	35
3.3. Case Study in the Netherlands.....	36
3.3.1. Introduction to Waternet and Weesperkarspel WTP .....	36
3.3.2. Sustainability targets Waternet .....	38
3.3.3. Procedures to increase sustainability.....	39
3.3.4. Procedures to decrease adverse effects of NOM.....	42
3.4. Case Studies in United Kingdom.....	50
3.4.1. Tullich Water Treatment Works.....	50
3.4.2. Bradan Water Treatment Works .....	55
3.4.3. Amlaird Water Treatment Works.....	60
3.5. Impact of specific organic components on water treatability.....	65
<b>4. Conclusions</b> .....	<b>75</b>
<b>References</b> .....	<b>76</b>

## LIST OF FIGURES

Figure 1	Optimization Framework.....	7
Figure 2	Life cycle assessment framework according to the ILCD Handbook (2010).....	9
Figure 3	TRUST WP4.1 selected test sites.....	10
Figure 4	Process scheme – Stangaasen WTP.....	11
Figure 5	Pictures from the flotation step (left), sedimentation (middle) and filtration (right) .....	11
Figure 6	NOM fraction concentrations in raw and treated water samples from Stangaasen WTP .....	14
Figure 7	NOM fraction removal efficiencies at Stangaasen WTP .....	15
Figure 8	BDOC concentration at Stangaasen WTP .....	15
Figure 9	Scheme of the full-scale enhanced coagulation optimisation trials at Stangaasen WTP aimed at identifying optimum coagulation conditions and the effects of filtration rate on performance (Eikebrokk et al, 2007).....	17
Figure 10	Illustration of the balance between safety and sustainable operation of enhanced coagulation facilities.....	17
Figure 11	Turbidity variation during the optimization at Stangåsen WTP 2011-2014 (Raw water turbidity varied between 1-3 NTU).....	19
Figure 12	Color variation during the optimization at Stangåsen WTP 2011-2014 (Raw water color varied between 35-46 mg Pt/L).....	20
Figure 13	TOC variation during the optimization at Stangåsen WTP 2011-2014 (Raw water TOC varied between TOC 6-8.5 mg/L).....	21
Figure 14	Residual Al during the optimization at Stangåsen WTP 2011-2014 (Raw water Al < 0.3 mg/L).....	22
Figure 15	System boundaries in a treatment process .....	26
Figure 16	Environmental profile-Contribution of WTP operation to the environmental impacts.....	28
Figure 17	Contributions to the environmental impact from processes (as 10 <sup>-3</sup> EcoPoints/m <sup>3</sup> ) .....	28
Figure 18	Contribution to the carbon foot-print from processes (as kg CO <sub>2</sub> eq/m <sup>3</sup> ).....	29
Figure 19	Effect of the type of energy mix .....	29
Figure 20	Foreseen environmental impacts for enhanced coagulation .....	30
Figure 21	Effect of the replacement of coagulant on the environmental impact.....	31
Figure 22	Geographical outline drinking water production and distribution of Waternet .	37

Figure 23	Process configuration of Loenderveen pretreatment and Weesperkarspel treatment facilities.....	37
Figure 24	Historical DOC development at Weesperkarspel.....	45
Figure 25	Process scheme – Tullich WTWs.....	50
Figure 26	HPSEC trace for Tullich WTWs, July 2012.....	52
Figure 27	Fractionation on a proportion basis at Tullich WTWs, July 2012.....	53
Figure 28	Fractionation on a mass basis at Tullich WTWs, July 2012.....	53
Figure 29	Flowsheet for Bradan WTWs.....	55
Figure 30	HPSEC for Bradan WTWs, August 2012.....	57
Figure 31	Fractionation on a proportion basis at Bradan WTWs, August 2012.....	58
Figure 32	Fractionation on a mass basis at Bradan WTWs, August 2012.....	58
Figure 33	Flowsheet for Amlaird Water Treatment Works.....	60
Figure 34	HPSEC for Amlaird WTWs, August 2012.....	61
Figure 35	Fractionation on a proportional basis at Amlaird WTWs, August 2012.....	62
Figure 36	Fractionation on a proportional basis at Amlaird WTWs, August 2012.....	62
Figure 37	Filter robustness at Amlaird Water Treatment Works.....	64
Figure 38	HPSEC for the raw and treated waters with increasing coagulant dose.....	66
Figure 39	Residual DOC of Amlaird raw water and treated water with 20 mg/L of ferric sulphate as Fe after addition of different concentrations of spikes.....	68
Figure 40	Percent DOC removal from Amlaird raw water after addition of spikes and treatment with 20 mg/L of ferric sulphate as Fe.....	68
Figure 41	HPSEC for treatment of Amlaird Water addition of 5 mg/L DOC spikes and treatment with 20 mg/L of ferric sulphate as Fe.....	69
Figure 42	Optimisation of coagulation after addition of 5 mg/L of spikes in Amlaird raw water samples.....	69
Figure 43	Change in THM-FP for treated water spiked oxalic acid and tannic acid.....	70
Figure 44	Floc breakage profiles for raw water with organic spikes coagulated using 20 mg/L as Fe coagulant.....	71
Figure 45	Floc strength profiles for raw water with organic spikes coagulated using 20 mg/L as Fe coagulant.....	72
Figure 46	Floc breakage profiles for raw water with organic spikes coagulated using 25 mg/L as Fe coagulant.....	72
Figure 47	Floc strength profiles for raw water with organic spikes coagulated using 25 mg/L as Fe coagulant.....	73

Figure 48 Floc strength profiles for organic spikes at 15 and 20 mg/L DOC respectively, both using 20 mg/L as Fe coagulant. Note that oxalic acid did not produce a floc, so was not included in the figure ..... 73

## LIST OF TABLES

Table 1	Indicator parameters and parameter values for the hygienic barriers in coagulation.....	13
Table 2	Typical water quality data from Stangaasen WTP (Nov 2011).....	13
Table 3	Alum and energy consumption at Stangaasen WTP in 2010 and 2011.....	16
Table 4	Variation range of raw water quality and filter outlet water during optimization experiments .....	18
Table 5	The alternatives considered .....	24
Table 6	Water treatment efficiencies of the alternatives considered.....	25
Table 7	Record of operational expenditures – chemicals and electricity (in kNOK) .....	32
Table 8	Weighting factors (in %).....	33
Table 9	Relative sustainability measures for the six alternatives .....	34
Table 10	Typical water quality data from Weesperkarspel WTP (average 2011).....	38
Table 11	Contributions to environmental impact from processes at LDV and Weesperkarspel as mPt/m <sup>3</sup> and percentage (Barrios, 2008).....	39
Table 12	Quantification of research and implementation of improved sustainable water supply projects at Weesperkarspel and Loenderveen.....	40
Table 13	Several studies on enhanced coagulation.....	44
Table 14	Input for cost evaluation: expected variation of DOC across treatment process (Grefte, 2013) .....	46
Table 15	Tullich WTWs detailed analysis, July 2012.....	51
Table 16	Fractionation data for Tullich WTWs, July 2012.....	53
Table 17	DBP data for Tullich WTWs, July 2012 .....	54
Table 18	Water quality data for Bradan WTWs, August 2012 .....	56
Table 19	Fractionation data for Bradan WTWs, August 2012.....	58
Table 20	DBP formation at Bradan WTWs, August 2012.....	59
Table 21	Water quality data for Amlaird WTWs, August 2012.....	61
Table 22	Water quality data for Amlaird WTWs, August 2012.....	62
Table 23	Water quality data for Amlaird WTWs, August 2012.....	63
Table 24	Compounds used as spikes.....	65
Table 25	Optimum treatment of Amlaird water using coagulation .....	66

## 1. INTRODUCTION

Most existing water supply systems will be in operation for decades to come. Thus, optimization of operation performance with respect to safety, environmental impacts and cost-efficiency should be a priority effort (Eikebrokk, 2009). However, the remaining optimization challenges and unexploited optimization benefits still seem significant. Optimization efforts are often restricted to water treatment plants, and are often motivated by water quality and cost considerations. Useful optimization criteria may include: 1) Maximum compliance with the current water quality standards and national regulations, 2) Maximum treatment and disinfection barrier efficiency, stability and safety, 3) Minimum use of resources like chemicals and energy, and 4) Maximum cost-efficiency (Eikebrokk, 2009).

Various tools can be used in helping towards sustainable water services. Utilization of such methods and tools should be able to promote:

- Better linking of water treatment technologies, system design and operations to the prevailing raw water quality, *e.g.* in natural organic matter (NOM) laden regions, NOM characterization tools should be more widely applied to identify treatability, biodegradability, *etc.*
- Better linking of water treatment and the corresponding treated water quality to processes going on during water distribution, *e.g.* improved characterization of biodegradable NOM (BOM), the relative roles/importance of biofilms and adsorbing metal precipitates on the pipe walls, *etc.*
- Improved process control systems that are well adapted to the raw water quality and seasonal variability.
- Improved understanding of environmental impact and costs during operation.
- Extended application of full-scale optimization roadmaps/procedures and optimization efforts. Finding the balance between safety and resource use/sustainability issues is of great importance.



## 2. OPTIMIZATION FRAMEWORK

Optimization of water treatment plants and distribution systems has to rely on selected optimization criteria that are site and system specific. Comprehensive knowledge of the specific characteristics, limitations and challenges of a water supply system is required in order to define available alternatives and to design and perform full-scale optimization studies and trials (Eikebrokk 2009, Ramos and Ramos 2010, Li and Chang 2011, Venkatesh et al. 2015).

Figure 1 presents the proposed framework in TRUST to follow during the optimization. This framework includes environmental and economic aspects that were not assessed in optimization roadmap developed within the FP7 TECHNEAU Project which considered only technical dimension. The present framework has been elaborated based on TRUST Master Framework (Deliverable 31.1) leaving aside social, governance, and assets dimensions.

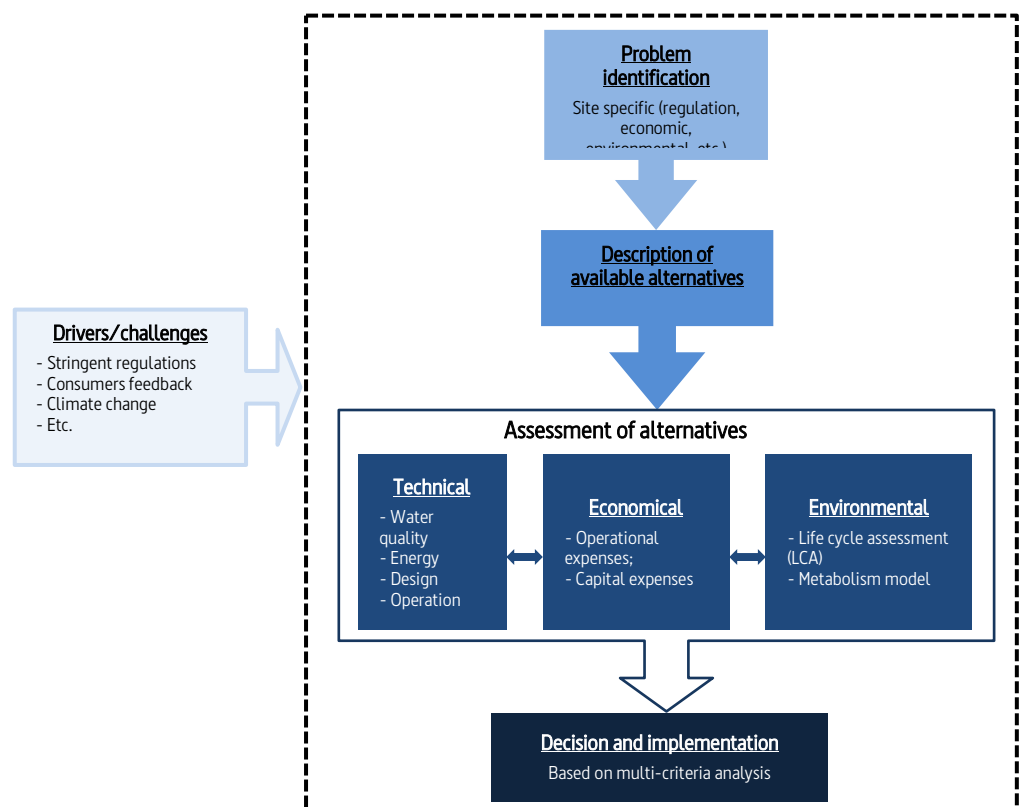

Figure 1 Optimization Framework

## 2.1. Technical Evaluation and Optimization

Technical optimization consists of technical measures that would help to maximize compliance with the current water quality standards and national regulations, to maximize treatment and disinfection barrier efficiency, stability and safety, to minimize the use of resources like chemicals and energy, and to maximize the cost-efficiency, with respect to today's situation.

Efforts for optimization should start with mapping of today's situation as the baseline, *i.e.* current status of operational performance. Comprehensive analysis of raw and treated water quality and variations are also important. For full-scale operation optimization trials, a systematic approach is needed and great care should be taken without compromising quality of the water produced and system integrity. Small steps should be taken in optimization trials, and adequate sampling and analysis is necessary. Furthermore, optimization potentials and possible benefits should be identified, and the implementation of new and revised treatment conditions should be done on the basis of careful assessments of the major implications that treatment and distribution systems may encompass.

The suggested optimization procedure includes:

- Mapping operational performance status that includes initial performance evaluation and comparison to model predictions.
- Utilizing diagnostic tools, e.g. for water quality characterization that also helps identification of variations in the performance.
- Utilizing curative tools that includes performing experiments and trials without compromising the water quality produced.
- Utilizing decision support systems to highlight some other aspects e.g. economic and environmental issues that are not covered by the diagnostic and curative tools.
- Identifying performance optimization potentials and possible benefits.
- Implementing selected operation conditions based on overall assessments of potential advantages and disadvantages for both treatment and distribution systems.

## 2.2. Environmental Impact Assessment

The proposed framework proposes to use Life Cycle Assessment (LCA) to assess the environmental impact. The framework for the LCA defined by the ISO-14040 is shown in Figure 2. The main goal of the LCA analysis is to determine the environmental impacts attributable to the operation of the water treatment plant during different operational options that would help to optimize the WTP.

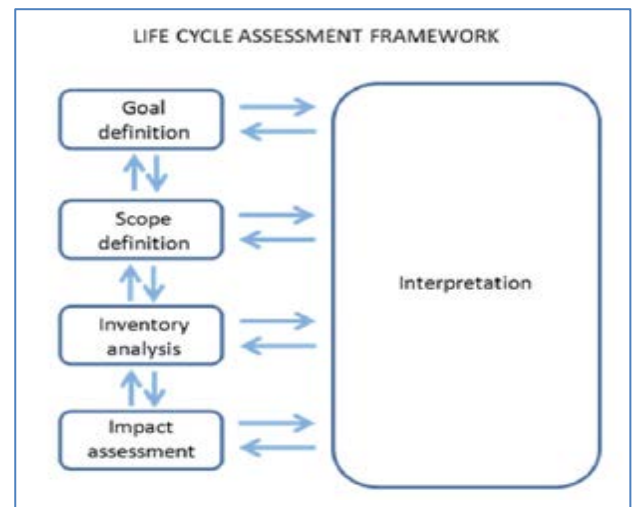

Figure 2 Life cycle assessment framework according to the ILCD Handbook (2010)

### 2.3. Economic Evaluation

Depending of the optimization in question, the economic criteria could be assessed using various methods such as capital/operational expenses (CAPEX/OPEX), Life Cycle Cost (LCC), Cost-Benefit Analysis (CBA), etc. In the case of an existing plant where no additional equipment needs to be installed, it is sufficient to only evaluate operating costs (OPEX). Operation and maintenance expenses incurred in water treatment, which primarily consists of expenses on chemicals and energy, are collected and systematised. The capital costs associated with the plant and the equipments are therefore not considered.

### 2.4. Multi-Criteria Assessment

In order to identify the best suited option a multi-criteria assessment needs to be used to integrate the outcomes from the technical, environmental and economic evaluations. Several ways exist in the literature and could be applied for this purpose (Pawłowski 2008, Quental et al 2011, Venkatesh et al., 2015). However, all these tools require that criteria are weighted against each other. The weighting may be carried out using a questionnaire addressed to relevant professionals.

### 3. CASE STUDIES

From activities at the three test sites in natural organic matter (NOM)-laden regions of United Kingdom, The Netherlands, and Norway, this report provides examples on the application of the optimization framework and the simple diagnostic tools for assessing water quality, NOM nature and properties including biodegradability, water treatability, treatment technology, and operational performance.

#### 3.1. Test sites & Description of Current Status

The test sites located in The Netherlands, United Kingdom, and Norway (Figure 3) are further described below. The test sites are chosen on the basis of common drivers and challenges with respect to drinking water safety and sustainability issues *i.e.* climate change and NOM increase. Differences in applied technologies and operations are also an important aspect to consider and will contribute to applicability of the roadmap to sustainable and safe water services proposed in this report.

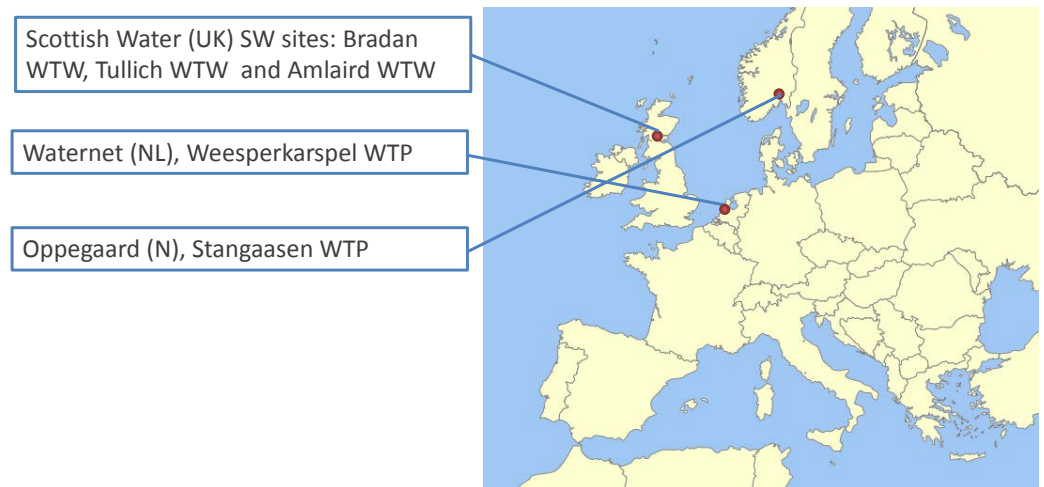

Figure 3 TRUST WP4.1 selected test sites

The proposed framework has been implemented fully in the case studies in Norway and the Netherlands, while for case studies in Scotland only the technical aspect was evaluated.

### 3.2. Case Studies in Norway

Stangaasen WTP is located in Oppegård, Norway (in Oslo region). The treatment process flowchart is illustrated in Figure 4 and Figure 5. The raw water is pumped from Lake Gjersjøen from a depth of 36 meter and sent to the water treatment facility.

Coagulants (granulated aluminium sulphate) are then added before the flow is split in two lines consisting of flotation and settling. Both are followed by a typical media filtration. A UV disinfection system has been installed to provide a more robust treatment to give two hygienic barriers. Sodium hypochlorite and sodium hydroxide are then added to provide respectively a residual disinfectant (only for the time spent in the header tank, there is no residual chlorine in the distribution system) and corrosion control respectively.

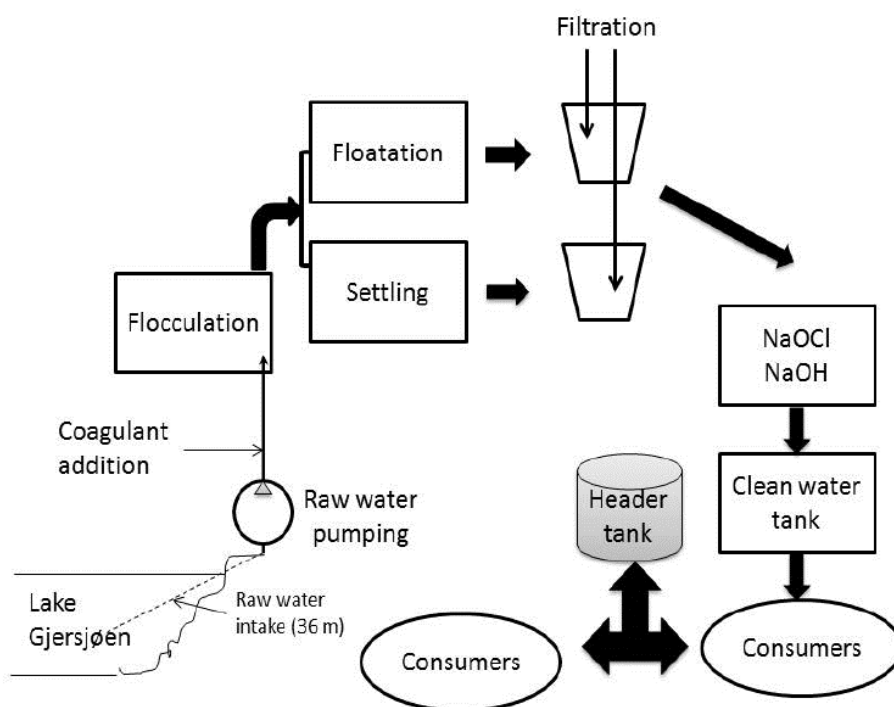

Figure 4 Process scheme – Stangaasen WTP



Figure 5 Pictures from the flotation step (left), sedimentation (middle) and filtration (right)

TRUST activities at Stangaasen WTP include the following activities:

- Mapping of current operation performance
- Mapping of the use of resources (energy, chemicals, water)
- Advanced raw and treated water quality analyses (natural organic matter (NOM)-fractionation, biodegradable dissolved organic carbon (BDOC), etc.)
- Full-scale optimisation trials in line with the TECHNEAU enhanced coagulation optimisation procedures (Eikebrokk, 2009)
- Triple bottom line assessment taking into consideration, economic, environmental and social aspects, in decision-making (Venkatesh et al., 2015)

### 3.2.1. Hygienic barriers and indicator requirements

The Norwegian drinking water regulations and associated guidelines require the presence of at least two hygienic barriers for the approval of water supply systems that supplies 50 people or more. Since Oppegård has no hygienic barrier at the water source, barriers are required at the water treatment plant consisting of coagulation and disinfection steps. Since chlorine disinfection is not very effective against parasites and did not receive sufficient credit against *Giardia* and *Cryptosporidium*, a UV disinfection step was installed in 2013. These parasites have in recent years caused large waterborne disease outbreaks in cities like Bergen (2004), Östersund (2010) and Skelleftea (2011), disease outbreaks mainly due to lack of or inadequate hygienic barriers.

Barrier effectiveness and consequently the security of water supply in Oppegård are therefore dependent on optimal operation of the water treatment plant. Drinking Water Regulations guide identifies specific requirements for barrier indicators for coagulation and for disinfection, *i.e.* requirements that must be met for each of these processing steps in order to constitute a hygienic barrier.

Coagulation plant must comply with barrier indicator values given in Table 1. To achieve this, adequate attention must be taken especially in places with poor raw water (high NOM / colour) and large seasonal variations.

For chlorination plant, a content of free residual chlorine of at least 0.05 mg Cl<sub>2</sub>/L, after at least 30 minutes contact time, should normally provide a satisfactory hygienic barrier against bacteria and viruses. The method does not constitute a hygienic barrier against parasites and bacterial spores. The value of 0.05 is corresponding to the analytical lower limit.

For UV systems, a dose of at least 30 mJ/cm<sup>2</sup> is considered to be a hygienic barrier for bacteria, viruses and parasites. If bacterial spores need also to be inactivated a UV dose of at least 40 mJ/cm<sup>2</sup> is required.

*Table 1: Indicator parameters and parameter values for the hygienic barriers in coagulation*

PARAMETER	VALUE	COMMENT
For water treatment with coagulation:		
Aluminium (mg Al/L)	< 0.15	When Al is used as the coagulant
Iron (mg Fe/L)	< 0.15	When Fe is used as the coagulant
Colour (mg Pt/L)	< 10	Should usually be < 5 for coagulation with Al or Fe
TOC (mg C/L)	< 3.0	
Turbidity (FNU)	< 0.2	To be monitored continuously for each filter unit
Particle count (1/mL) 2-400 µm	< 500	To be monitored continuously for each filter unit

### 3.2.2. Problem definition

#### Water quality and treatment performance

Table 2 shows typical raw and treated water quality data from Stangaasen WTP. The specific UV-absorbance (SUVA) was reduced from 3.3 L m<sup>-1</sup> mg<sup>-1</sup> in the raw water down to 2 L m<sup>-1</sup> mg<sup>-1</sup> in filtered water. This indicates that the raw water NOM is relatively amenable to removal by coagulation, and that the coagulation treatment performs reasonably well.

*Table 2: Typical water quality data from Stangaasen WTP (Nov 2011)*

SAMPLING POINT	pH	TURB. (NTU)	ALK. (mM)	COLOUR mg PT/L	UV-abs m <sup>-1</sup>	TOC mg/L	DOC mg/L	Al µg/L
Raw	7.0	1.2	0.8	33	23.3	7.1	7.1	50
Settling	6.4	1.1	0.4	4	6.0	3.4	3.1	380
Flotation	6.2	2.5	0.4	3	5.2	3.4	2.8	770
Filtration	6.3	0.1	0.4	3	5.6	2.8	2.8	30
Clean Water	7.6	0.2	0.8	3	4.8	2.7	2.7	30
Distribution	7.4	0.2	0.8	3	4.7	2.8	2.8	20
Raw	7.0	1.2	0.8	33	23.3	7.1	7.1	50

Occasionally, water quality from filter units does not comply with the Norwegian coagulation barrier guideline values (turbidity < 0.2 NTU; colour > 5 mg Pt/L; total organic carbon (TOC) < 3 mg/L; residual Al < 150 µg/L). Thus, the potentials for improvements in

treatment performance are investigated in specific optimisation trials as described in Section 3.2.3 (below).

As part of the treatment performance assessment, rapid NOM fractionation (Chow et al. 2004) and column-based BDOC analyses (Eikebrokk et al. 2007) were performed. The results are presented in Figure 6 to Figure 8 below.

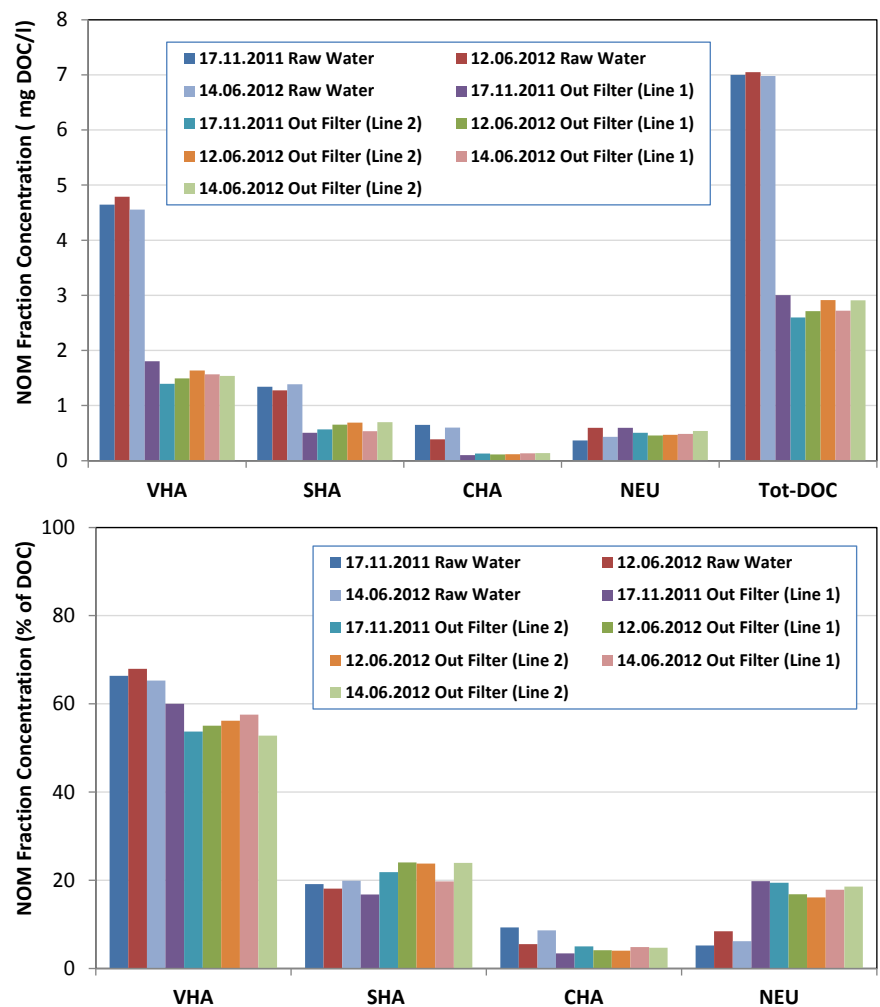

Figure 6 NOM fraction concentrations in raw and treated water samples from Stangaasen WTP



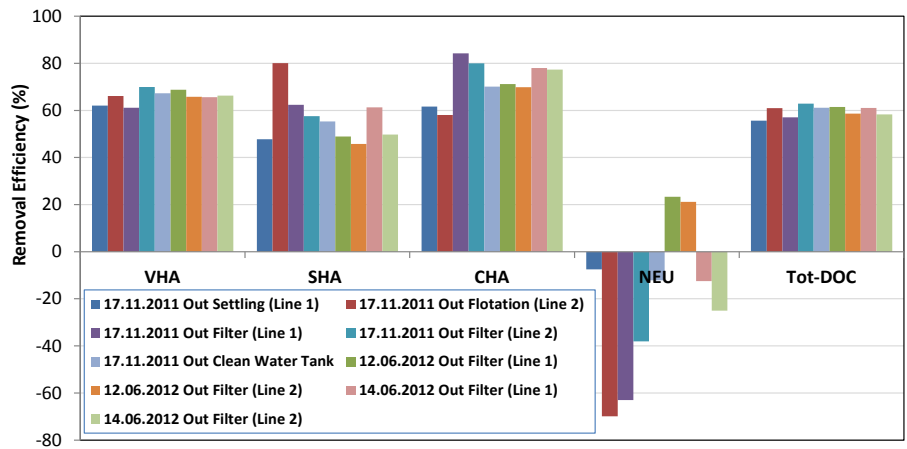

Figure 7 NOM fraction removal efficiencies at Stangaasen WTP

It can be seen from Figure 6 that the hydrophobic (humic) NOM fractions are predominant in the raw water. The very hydrophobic acid (VHA) and slightly hydrophobic acid (SHA) fractions contribute to 65-68 % and 18-20 % of the total DOC (7 mg/L), respectively. The hydrophilic charged (CHA) and neutrals (NEU) fractions contribute to 6-9 % and 5-8 % of the total DOC concentration in the raw water samples, respectively.

Figure 7 shows that the VHA and CHA fractions are effectively removed by coagulation (65-80 %). The SHA fraction is also removed effectively (50-80%). In contrast, the NEU fraction concentration remains similar after coagulation treatment indicating poor removal of this particular NOM fraction. Thus, the percentage of NEU fraction to the total DOC increases from 5-8 % in the raw water to 17-20 % in treated water. In order to control NOM at acceptable levels supplementary treatment steps may thus be required when coagulating raw waters with significant NEU fraction concentrations.

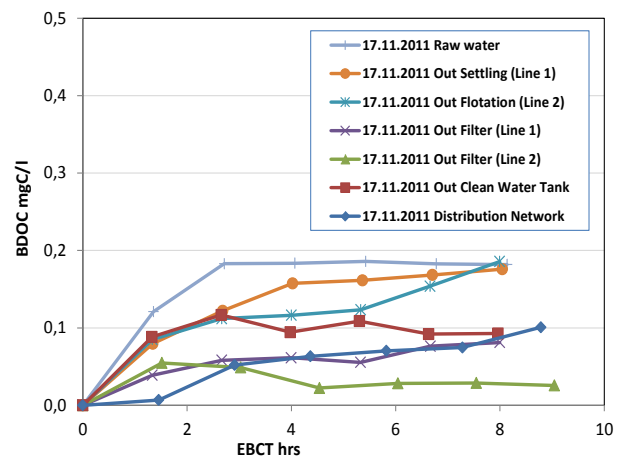

Figure 8 BDOC concentration at Stangaasen WTP

Figure 8 shows the biodegradable dissolved organic carbon (BDOC) concentrations in water samples from different treatment steps at Stangaasen WTP. The low BDOC in treated and distributed water (< 0.1 mg/L) shown in Figure 8 is indicative of limited availability of organic carbon substrate and corresponds to lower risk of microbial regrowth in the distribution system. This is confirmed by the utility's own experiences and the low heterotrophic plate counts (HPCs) found in distributed water samples.

### Use of resources

Consumption data for coagulation chemicals and energy for the years 2010 and 2011 are presented in Table 3. As shown, the average coagulant dose was 4.7 g of aluminium per m<sup>3</sup> water produced. The total energy consumption for water pumping and treatment was 0.46 kWh/m<sup>3</sup> of water produced in 2010 and 0.54 kWh/m<sup>3</sup> of water produced in 2011. The fraction of the total energy consumption used for pumping was 52% and 59 % in 2010 and 2011 respectively and the corresponding numbers for water treatment were 48% and 41 %. The water production efficiency, *i.e.* the amount of produced drinking water relative to the amount of pumped raw water was 90 % both in 2010 and 2011.

*Table 3: Alum and energy consumption at Stangaasen WTP in 2010 and 2011*

YEAR	ALUM COAGULANT		ENERGY			
	(kg AL/yr)	g AL/m <sup>3</sup>	(kWh/yr)	kWh / m <sup>3</sup>	TREATMENT	PUMPING
2010	26 147	4.7	2 578 560	0.46	48 %	52 %
2011	23 832	4.7	2 743 120	0.54	41 %	59 %
AVG		4.7		0.50		

### 3.2.3. Enhanced coagulation optimization

Full-scale enhanced coagulation optimisation trials have been performed at Stangaasen WTP. The trials follow the optimisation procedures outlined in the EU-project TECHNEAU ([www.techneau.eu](http://www.techneau.eu)) (Eikebrokk, 2009), and are based on a systematic variation of coagulation pH for a number of coagulant dose levels (Figure 9). In order to perform the optimisation trials, the WTP had to upgrade their equipment for coagulant dosing and pH-control. In addition, a UV disinfection system was installed in order to provide the two hygienic barriers required by Norwegian drinking water regulations.

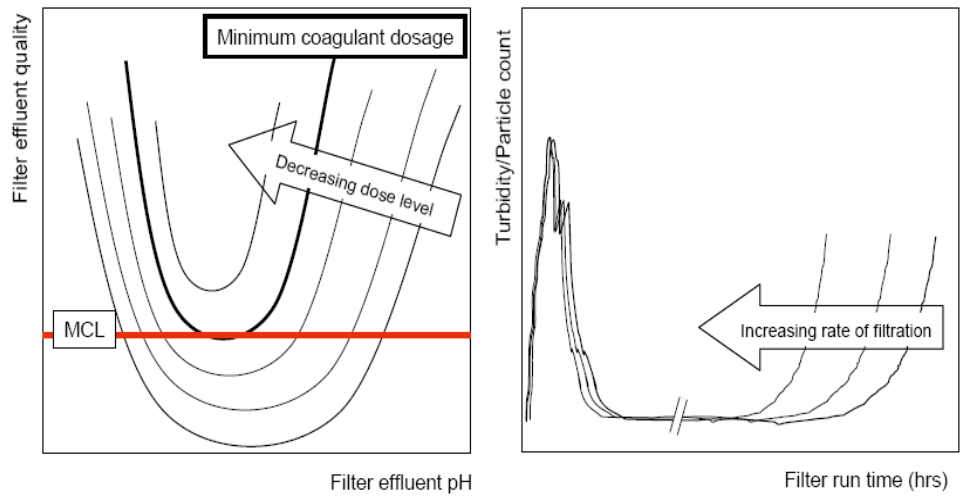

Figure 9 Scheme of the full-scale enhanced coagulation optimisation trials at Stangaasen WTP aimed at identifying optimum coagulation conditions and the effects of filtration rate on performance (Eikebrokk et al, 2007)

In terms of water supply safety and sustainability, Figure 10 illustrates a major goal of the operation performance optimisation trials: to find the balance between water quality/safety and sustainability/use of resources.

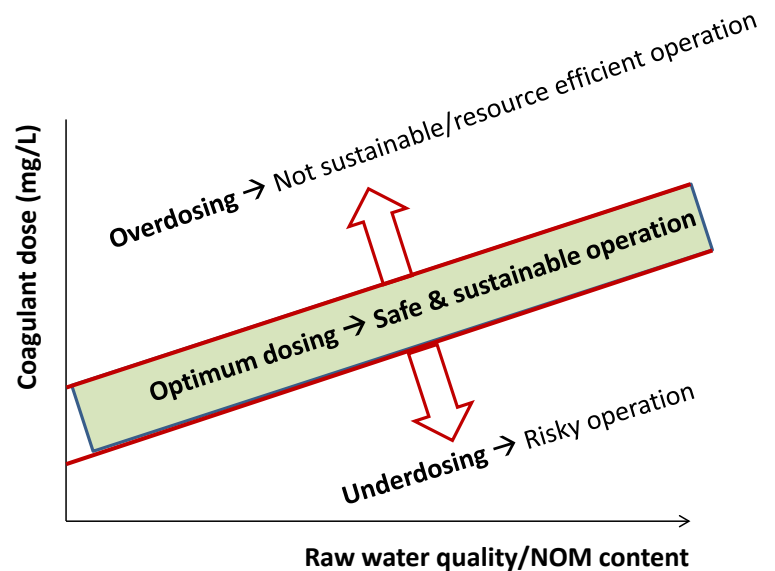

Figure 10 Illustration of the balance between safety and sustainable operation of enhanced coagulation facilities

## Optimization experiments

Optimization experiments were performed within the period November 2011 to July 2014. Coagulant doses ranging from 3.6 to 4.9 mg AL/L (40-55 mg ALG/L) and coagulation pH in the range 5.7 to 6.7 were used, while water temperature varied in the range of 5.2 to 5.7 °C. It was impossible to keep conditions stable for all experiments during such a long trial period as raw water flow and operating conditions of the plant were variable, complicating the interpretation of results.

Table 4 shows the range of variation of some key water quality parameters in raw water and the filter outlet water during optimization experiments.

*Table 4: Variation range of raw water quality and filter outlet water during optimization experiments*

	pH	ALKALINITY mmol/L	TURBIDITY NTU	COLOUR mg Pt/L	TOC mg/L	Ca mg/L
Raw water	7.0-7.5	0.67-0.79	0.1-2.6	33-43	6.2-7.9	18-21
Filter outlet	5.9-6.8	0.14-0.47	0.10-0.42	3-7	2.6-4.0	17-21

Figure 11 to Figure 14 depict the behaviour of selected water quality parameters during the optimization experiments.

Figures 11-14 show that the barrier indicator requirements for colour were met under all tested combinations of coagulant dose and pH. The residual Al requirement was also met except for the lowest pH values (pH 5.8 and 5.9) with lowest coagulant doses (40 and 47 mg ALG/L). Regarding the turbidity parameter the interpretation of the results is more complex due to variations in raw water quality. The barrier indicator requirement of 0.2 NTU is met for several combinations of coagulant dose and pH, but here it seems that the combination of low coagulant doses and low pH gives values that exceed the barrier indicator requirement.

The barrier indicator requirement for TOC (3 mg/L) appears to be the most difficult to fulfil. Although the picture here is somewhat unclear, it appears that the barrier indicator requirement for TOC will not be fulfilled at the lowest dose (40 mg ALG/L) regardless of the coagulation pH used. The TOC requirement is met for high dose, but only for some coagulation conditions. It appears to be more advantageous with relatively high doses and low pH. It should, however, be noted that the untreated water was of poorest quality during the experiments with the low coagulant doses meaning that the specific dosage (mg AL/mg TOC) was particularly low for those test series.

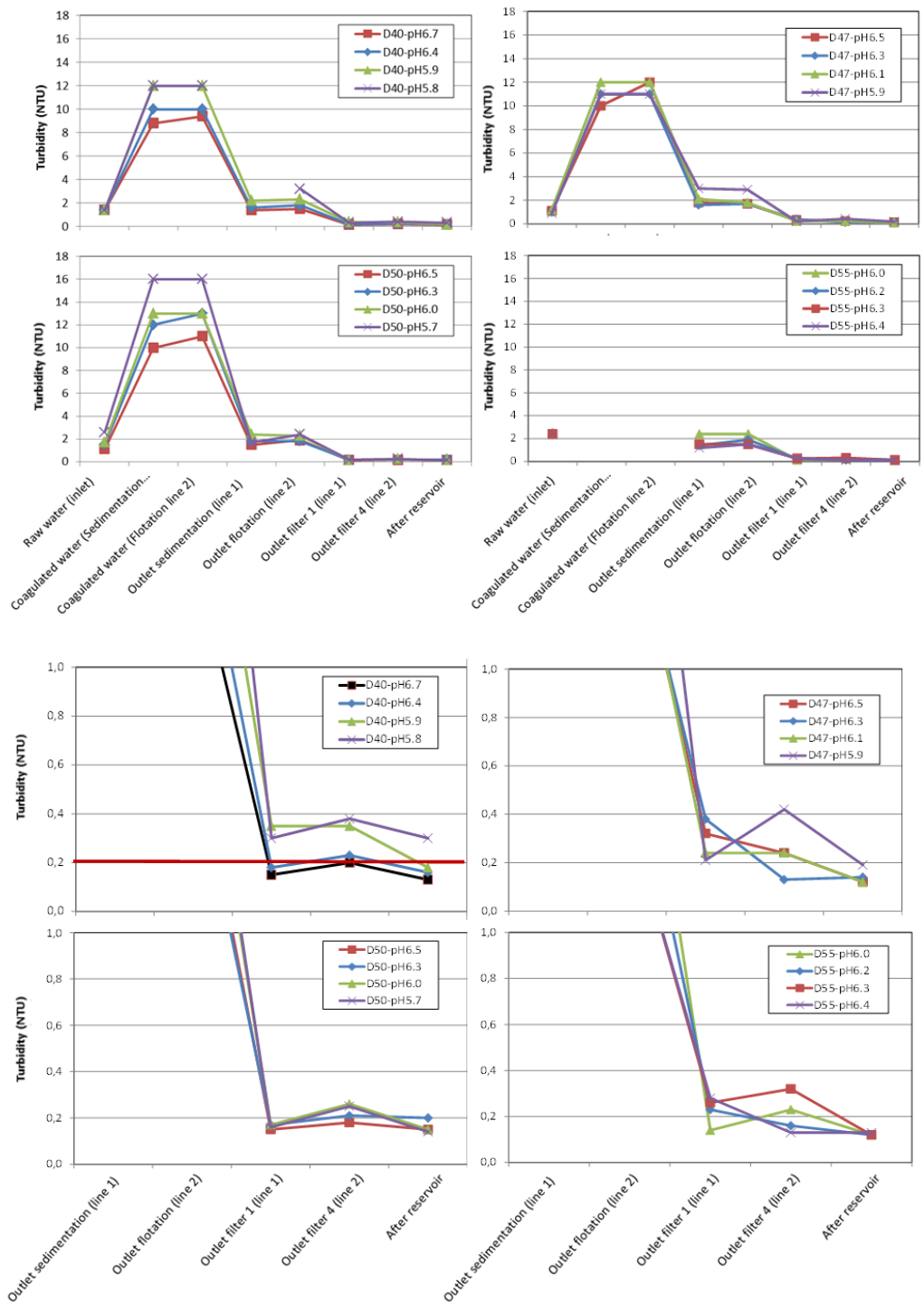

Figure 11 Turbidity variation during the optimization at Stangåsen WTP 2011-2014 (Raw water turbidity varied between 1-3 NTU)

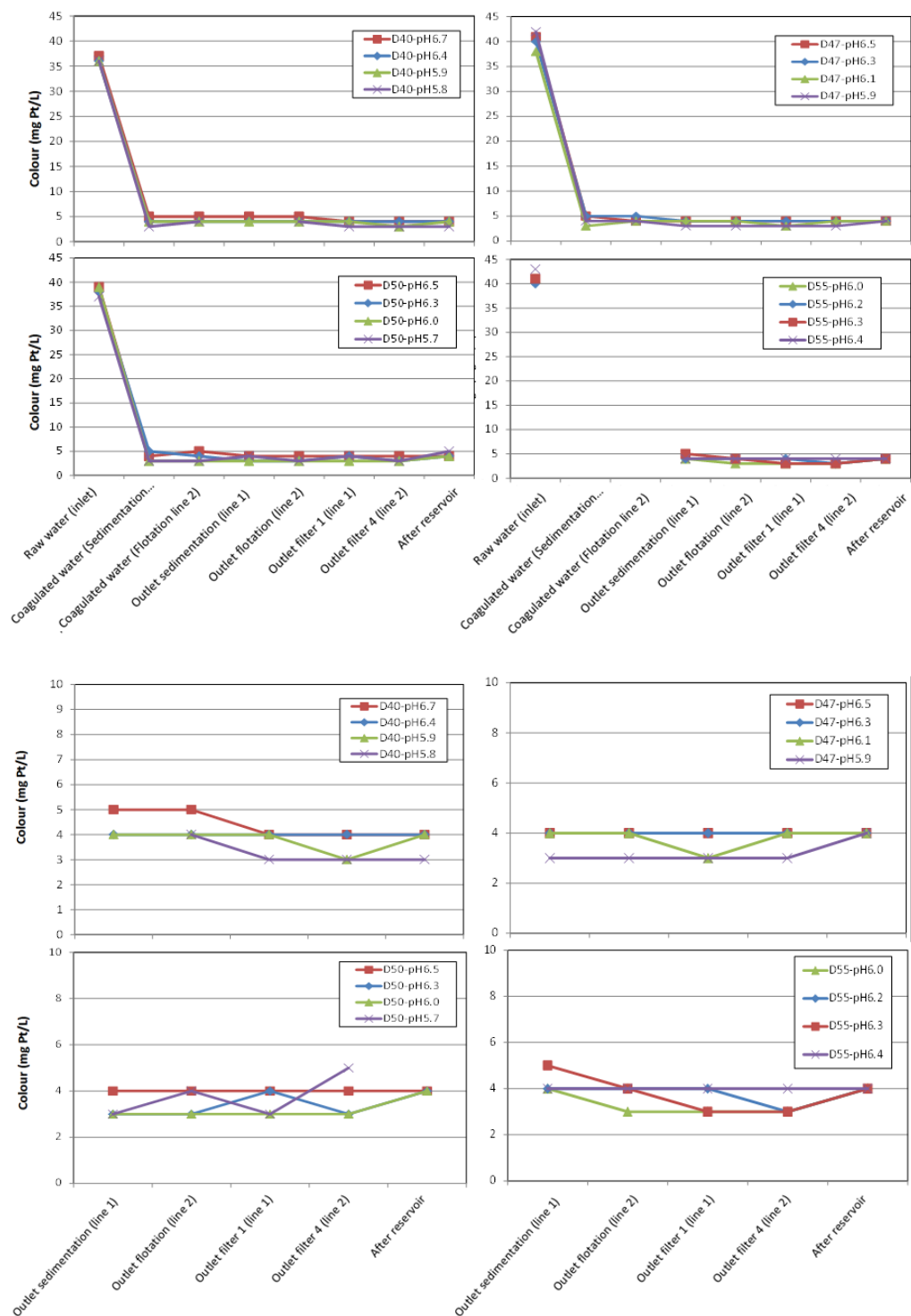

Figure 12 Color variation during the optimization at Stangåsen WTP 2011-2014 (Raw water color varied between 35-46 mg Pt/L)

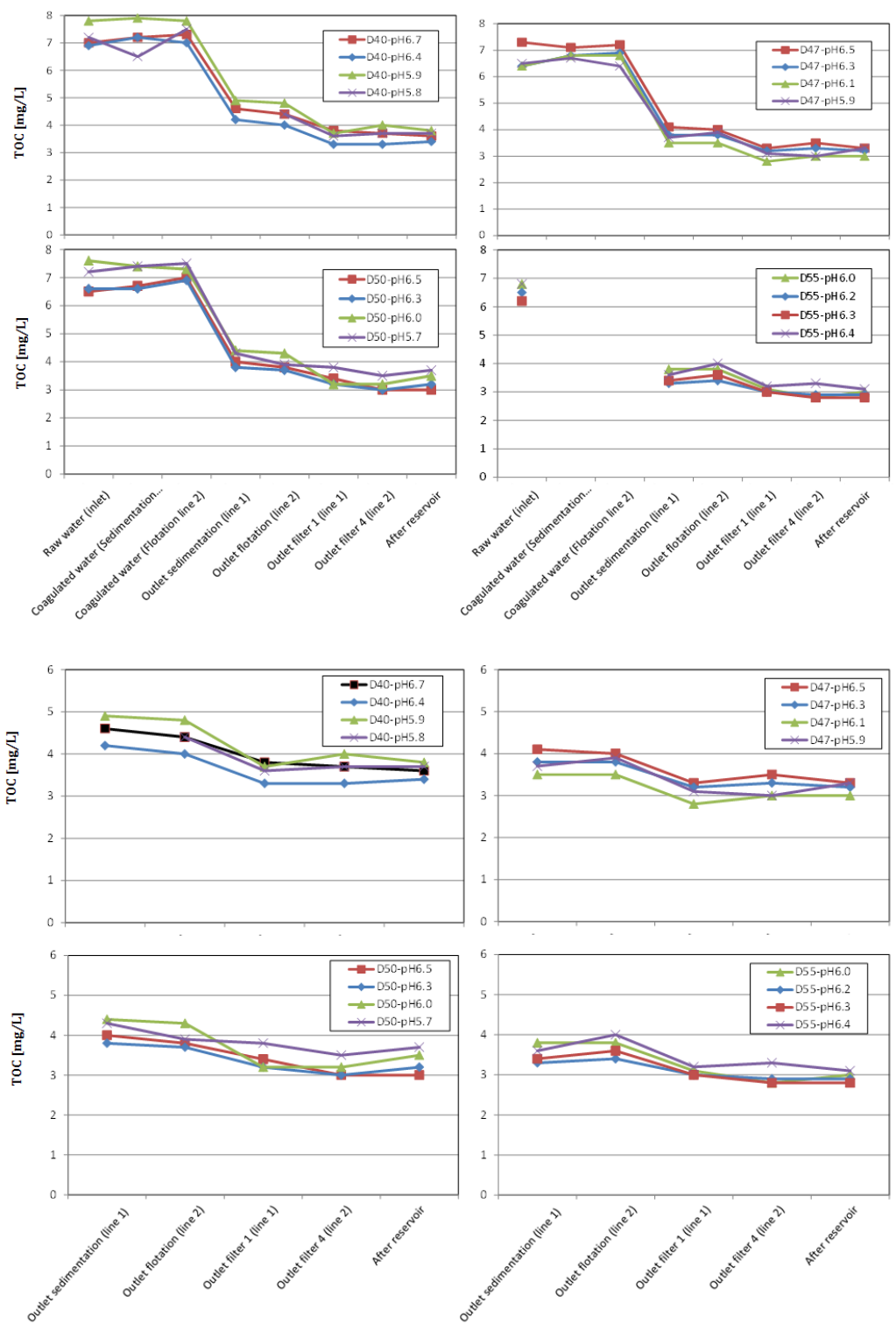

Figure 13 TOC variation during the optimization at Stangåsen WTP 2011-2014 (Raw water TOC varied between TOC 6-8.5 mg/L)

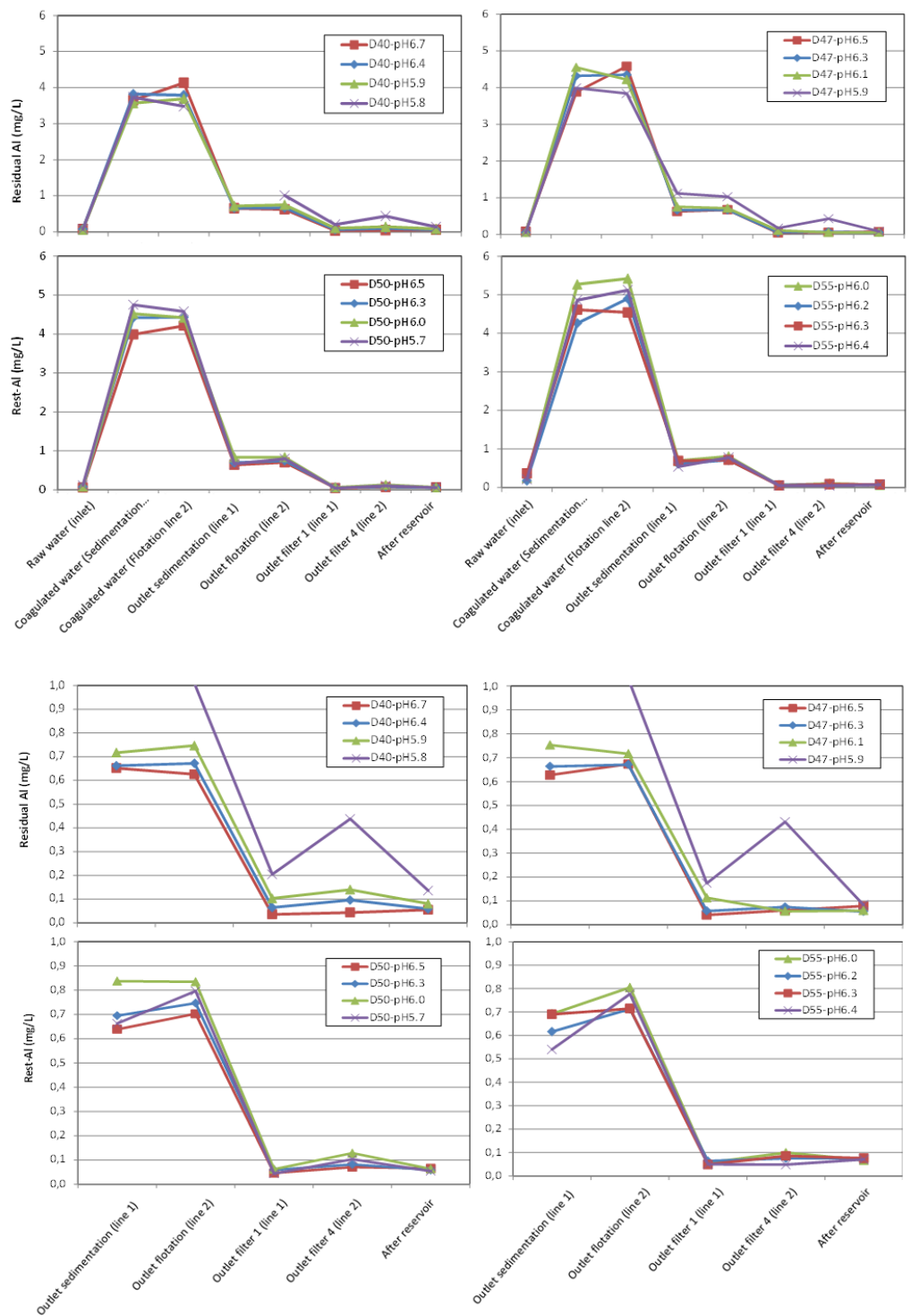

Figure 14 Residual Al during the optimization at Stangåsen WTP 2011-2014 (Raw water Al < 0.3 mg/L)



The main challenge at Stangåsen water treatment plant is to meet the barrier requirements for the coagulation step, especially for indicator parameters TOC and turbidity. The results of the optimization experiments at Oppegård differs from similar attempts in other coagulation treatment plants, where clear effects of changes in coagulant dose and coagulation pH showed significant potential for reduction of coagulant dose or improvement of water quality and coagulation barrier. At Stangåsen water treatment plant, the effects of changes in dose and pH were surprisingly small and often unsystematic. This is probably due to circumstances, as it is difficult to have full control due to varying raw water quality, lack of control on coagulant dosing (especially in the early trials phases), and operation issues. Uncertainties associated with these conditions have of course been amplified as the experiments extended over a long time.

The problems for meeting barrier indicator requirements (TOC) indicate that a transition to the Fe-based coagulation should be considered. Iron-based coagulation usually removes NOM in a somewhat more effective way than Al-based coagulation (often around 10%). Though, Fe-coagulation will require a significantly lower coagulation pH (pH 4-5). It is also important to have a good control over Fe-residual in filtered water to prevent fouling on quartz sleeves of the subsequent UV facility

### 3.2.4. Alternatives to be evaluated

The alternatives compared with the present situation are listed in Table 5. Although the full scale optimization experiments have shown that the reduction of the dose of coagulant is not feasible, it has been considered as well as the increase of the coagulant dose for illustration.

*Table 5: The alternatives considered*

DESIGNATION OF ALTERNATIVE	DESCRIPTION
A0	Currently-used coagulant – granulated aluminium sulphate (ALG) – at a dosage of 4.70 mg Al/litre
A1	40% reduction in dosage of currently-used coagulant - granulated aluminium sulphate (ALG) – 2.82 mg Al/litre
A2	20% reduction in dosage of ALG – 3.76 mg Al /litre
A3	20% increase in dosage of ALG – 5.64 mg Al /litre
A4	40% increase in dosage of ALG – 6.58 mg Al / litre
B1	Liquid ferric chloride (40%) used instead of granulated aluminium sulphate, dosage with respect to metal-ion same as the current situation with ALG – 9.7 mg Fe / litre. Amount of CO <sub>2</sub> to reach the required pH of 4.5 where coagulation is optimal with ferric chloride coagulant, and the amount of sodium hydroxide to neutralise the acid at the end of the treatment were determined theoretically.
B2	Liquid ferric chloride sulphate (40%) used instead of granulated aluminium sulphate, dosage with respect to metal-ion same as the current situation with ALG – 9.7 mg Fe / litre. Amount of CO <sub>2</sub> to reach the required pH of 4.5 where coagulation is optimal with ferric chloride coagulant, and the amount of sodium hydroxide to neutralise the acid at the end of the treatment were determined theoretically.
C	Liquid aluminium sulphate (48%) used instead of granulated aluminium sulphate, dosage with respect to metal-ion same as the current situation with ALG

### 3.2.5. Removal efficiencies

Table 6 represents the water treatment efficiencies with regard to the four contaminant-categories, for the options considered. The degree of removal (or rather reduction) of micro-organisms in the raw water reflects on the barrier efficiency. By Norwegian standards, coagulated water with turbidity<0.2 NTU, colour<5 Pt, TOC<3 mg/l and residual Al< 0.15 mg/l signifies a barrier *i.e.* > 3 log removal of bacteria and viruses and 2log removal for parasites. In our calculations, if all four criteria are met, the removal efficiency is set at 100%, if only three are met, at 75%, if two, 50% and if only one is met, 25%. If none is fulfilled, it is as good as not having any barrier at all (0% removal).

From the results presented in Table 6, alternatives B1 and B2 as well as A2 and A3 would improve the water quality compared to the status quo. Though, economic and environmental assessments of these alternatives may bring a different sight and result in a different decision.

*Table 6: Water treatment efficiencies of the alternatives considered*

WQ PARAMETER (% REMOVAL) ALTERNATIVE	COLOUR/NOM (% REMOVAL)	TURBIDITY (% REMOVAL)	MICRO-ORGANISMS (BARRIER EFFICIENCY) (% REMOVAL)	TOTAL ORGANIC CARBON (% REMOVAL)
Status quo	93	95	75	56
A1	63	85	0	43
A2	88	95	50	50
A3	93	95	100	60
A4	93	95	100	61
B1	95	93	100	71
B2	95	93	100	71
C	93	95	75	56

### 3.2.6. Environmental impact assessment using LCA

The LCA was carried out according to ISO-14040. The framework for the LCA is shown in Figure 2. The main goal of the LCA analysis is to determine the environmental impacts attributable to the operation of the water treatment plant at Oppegård WTP for the different alternatives to be evaluated for potential optimization.

#### Scope

Since previous studies have shown that construction and dismantlement phases of a DWTP are negligible with respect to the environmental impact (Raluy et al., 2005; Stokes and Horvath, 2006; Vince et al., 2008) and because the DWTP at Oppegård already exists, this LCA study focuses only on the production phase of the waterworks life cycle. The boundaries (Figure 15) of the system are selected to include all the activities that are an essential part of the current treatment processes. The functional unit is one cubic meter of drinking water produced ( $1 \text{ m}^3$ ) that meet the legal requirements on water quality for human consumption.

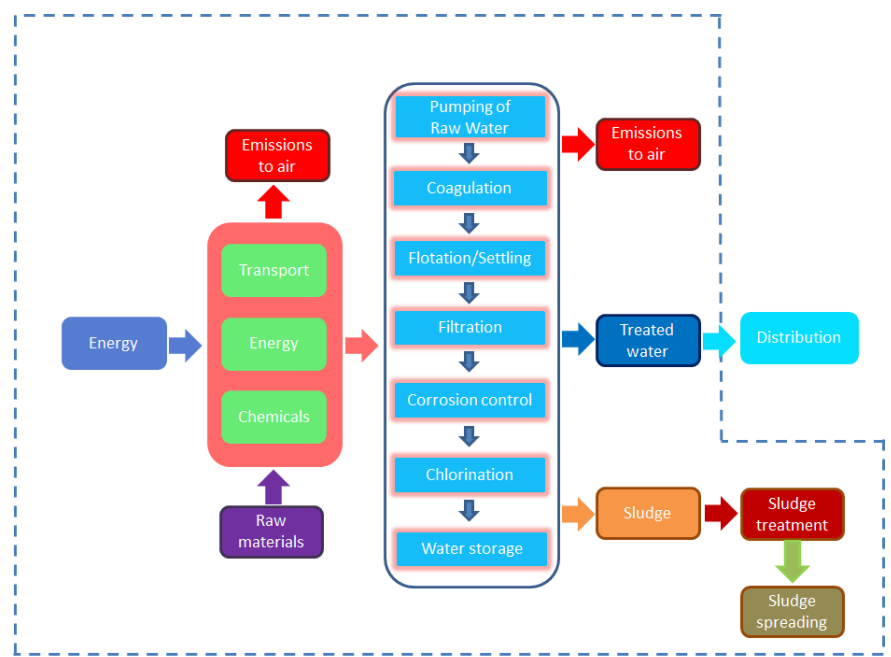

Figure 15 System boundaries in a treatment process

#### Life Cycle Inventory

Two types of data have been used, real data on chemical substances and electricity collected from the waterworks/reports, and data from databases included in SIMAPRO with some modifications when needed. For example energy resources included in the Eco-invent database were replaced by local energy resources depending on the location of the manufactured product (Swedish energy or Norwegian hydro-electricity energy).

Transportation distances of materials and consumables that are found in the Eco-invent database were replaced by relevant driving distances. Moreover, additional data were collected for items that are not included in the Eco-invent database (*e.g.* liquid aluminium sulphate).

All input and output data collected in the inventory phase are normalised to the functional unit. The input and output data include the use of materials and energy and releases to air, land and water associated with the processes. The sludge is transported through the sewerage system and mixed with municipal wastewater prior to it being treated at the Nordre Follo wastewater treatment plant (WWTP). Treated sludge is transported by truck to the farms where it is spread as a fertiliser.

### Impact assessment

The software SIMAPRO 7.1.5 has been used with the method Eco Indicator 99. The latter was developed with the aim to simplify the interpretation and weighting of results. One of the intended applications was the calculation of single-point eco-indicator scores that can be used by designers in day-to-day decision making.

An eco-indicator is a value that expresses the environmental impact of a product or a process or service in a single figure. The environmental effects of each of the impact categories are normalised relative to a reference. The reference used to obtain the normalisation factors for each of the impact categories is related to the environmental impacts in each of the impact categories that an average European person causes in one year. This results in impact scores for each of the categories which are in turn multiplied by weight factors to get impact scores or eco-points for each impact category. The impact scores of all impact categories can be aggregated to get one single score or eco-point for each unit process and product. The higher the eco-point value the worse is the environmental impact.

The Eco-Indicator 99 has been selected for the main reasons in that it can be easily understood by the target audience (water utilities) who are not LCA experts, and because this method has been successfully used previously for a Waternet site in The Netherlands (Tapia et al., 2008; Barrios et al., 2008) which is of interest for WP4.1.

### LCA Results

#### Alternative A0

Figure 16 and Figure 17 present the environmental impacts for the WTP operation. The actual treatment situation accounted for 9.56 mEco-point/m<sup>3</sup>. Overall, the chemicals have the largest contribution with 5.91 mEco-point/m<sup>3</sup>, while the sludge treatment represented 1.38 mEco-point/m<sup>3</sup>, the electricity 1.42 mEco-point/m<sup>3</sup> and the transport only 0.82 mEco-point/m<sup>3</sup>. Among chemicals, granulated aluminium sulphate (3.76 mEco-point/m<sup>3</sup>) has the largest share, followed by the sodium hydroxide (1.55 mEco-point/m<sup>3</sup>).

Except from radiation and ecotoxicity, aluminium sulphate contributes the most to all other impact categories.

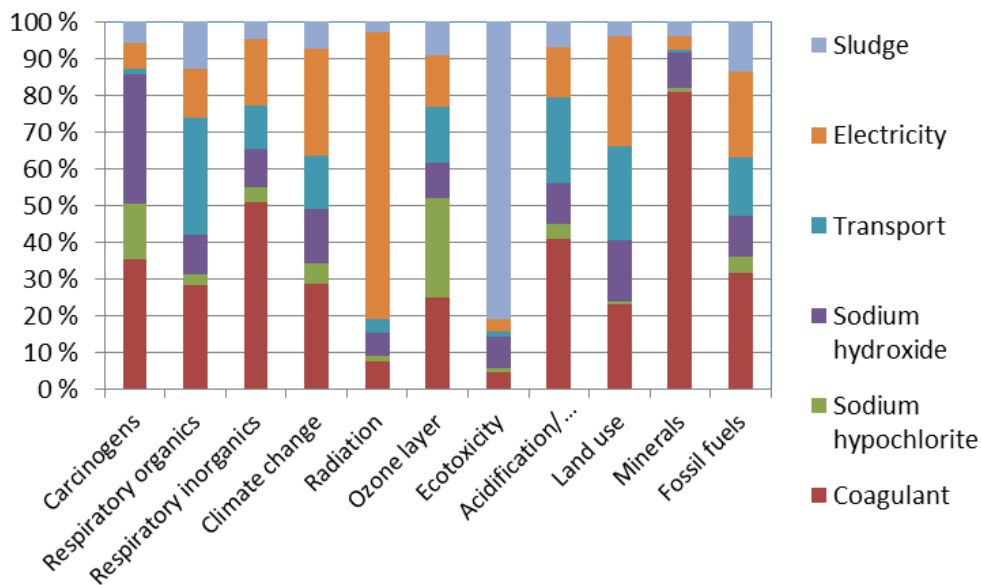

Figure 16 Environmental profile-Contribution of WTP operation to the environmental impacts

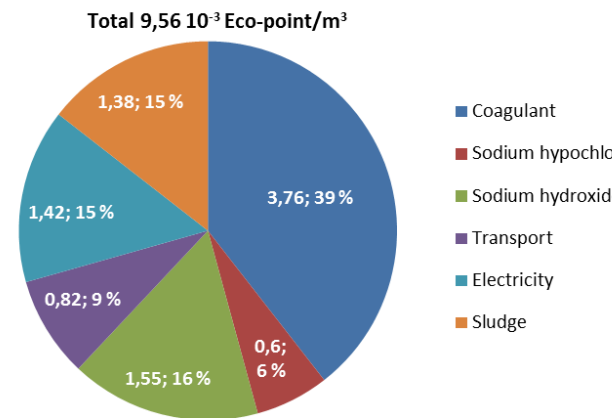

Figure 17 Contributions to the environmental impact from processes (as 10<sup>-3</sup> EcoPoints/m<sup>3</sup>)

Regarding the carbon foot print (Figure 18), electricity has the largest contribution followed by the sodium hydroxide, the coagulant, transport, sludge and sodium hypochlorite. The type of energy conversion process may have a large effect on the overall assessment. Indeed, depending on the energy conversion process, the production of electricity may indeed use fossil fuels. Their combustion generates CO<sub>2</sub> emissions, thus leading to high potential impacts on climate change. Between electricity supply from renewable sources, nuclear energy or coal power plants, electricity production impacts can be multiplied by as

much as 10 (Vince et al., 2008). Power losses during electricity transport also have to be compensated by supplementary electricity production, thus generating additional impacts.

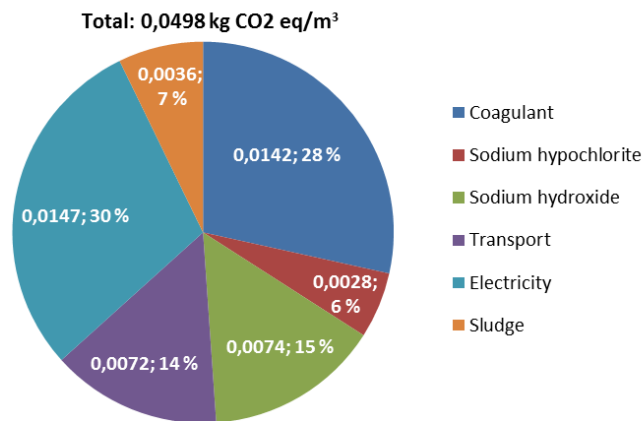

Figure 18 Contribution to the carbon foot-print from processes (as kg CO<sub>2</sub> eq/m<sup>3</sup>)

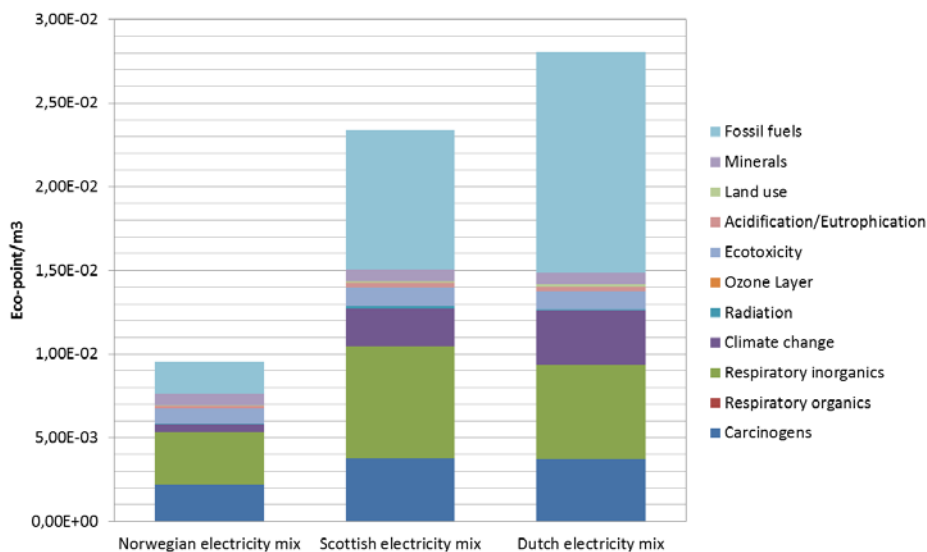

Figure 19 Effect of the type of energy mix

As illustrated in Figure 19, the local electricity production mix and transport have a tremendous influence on the impacts of water treatment processes. For the same treatment plant, by using the Norwegian electricity mix (99.06% Hydropower) the impact of energy production could be reduced by a factor of 2.5 and 3 compared to the Scottish electricity mix (30.1% hard coal, 29.9% nuclear, 18% natural gas, 2% oil, 20% renewable energy) and the Dutch electricity mix (59.4% natural gas, 24.9% hard coal, 4.1% nuclear, 11.6% other) respectively. Therefore, for the same treatment plant the effort involved in optimization of

that treatment plant would be different depending of the location. Indeed, in Scotland and The Netherlands the focus would probably be on the reduction of energy rather than only chemical consumption as it is for the present case study.

Figure 19 illustrates well that LCA should be used only at plant scale. The LCA based tool provides a complete picture of the environmental impacts generated by a plant but in its local context. LCA are not general, but very site- and country-specific. Thus, model results from general LCA data bases could be misleading and should be used with great care, and comparison between plants should be avoided or carried out with precautions.

### Alternatives A1, A2, A3, A4, B1, B2 and C

These values represent typical changes observed in Norway for enhanced coagulation. For each coagulant dose simulated, the corresponding transport and sludge treatment has been taken into account.

As expected a reduction in coagulant dose allows a reduction of the overall impact and an increase of the coagulant dose leads to the opposite Figure 20.

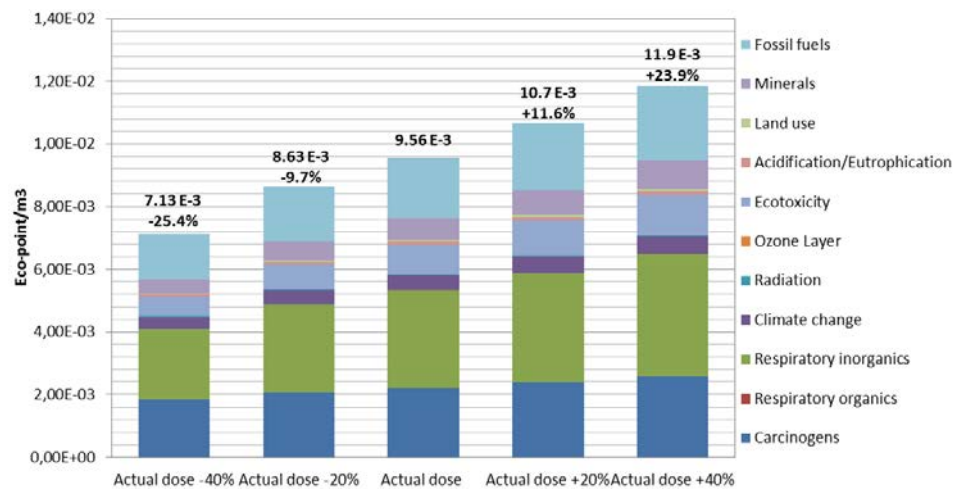

Figure 20 Foreseen environmental impacts for enhanced coagulation

Alternative coagulant maybe used to reduce environmental impacts. Different types of coagulants have been simulated: liquid aluminium sulphate, FeCl<sub>3</sub>, and FeClSO<sub>4</sub>, both being produced with green energy in Norway. The replacement from aluminium to iron has been considered by assuming the demand of iron to be equivalent to the demand for aluminium. As suggested in Figure 21, the use of liquid aluminium sulphate coagulant allows already a reduction of the overall impact of 14.3% compared to granulated aluminium sulphate that is used today. However, the use of iron based coagulant is even more beneficial with a reduction of 20.6% and 23.3% of the overall impact compared to granulated aluminium, for respectively liquid FeCl<sub>3</sub> and FeClSO<sub>4</sub>.



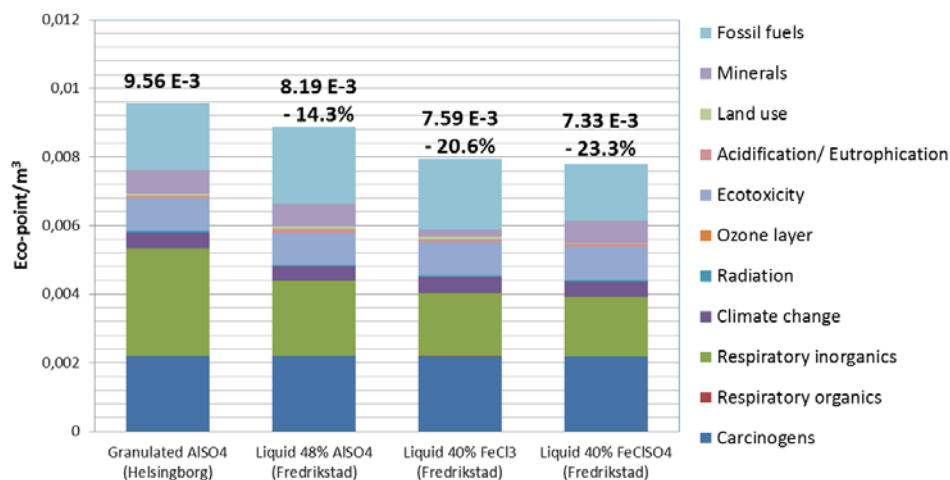

Figure 21 Effect of the replacement of coagulant on the environmental impact

### 3.2.7. Economic Evaluation

The economic evaluation is based on the following operational costs:

1. Operation and maintenance expenses incurred in water treatment, which primarily consists of expenses on chemicals and energy. The specific costs of carbon dioxide, sodium hypochlorite, granulated aluminium sulphate and sodium hydroxide were obtained from the treatment plant – 1.32 NOK per kg, 4.05 NOK per kg, 4.50 NOK per kg and 3.95 NOK per kg respectively (1 NOK is approximately equal to 0.125 Euro). These unit costs were then compared with the unit selling price of the supplier Kemira (Sweden). This comparison provided information about the toll, taxes and transport costs incurred in route to the treatment plant – these taken together raise the cost to the plant by a factor of 2.12. This factor was then used to determine the cost to the treatment plant, of alternative coagulant, *i.e.* iron chloride, iron chloride sulphate and liquid aluminium sulphate. The unit cost (to the plant) of these three chemicals is 2.96 NOK/kg. Specific electricity expenditure was 0.66 NOK per kWh. Knowing the masses, these values are used to find the total expenditure on treatment chemicals. Conversion from NOK to more standard currencies - Euros or USD - has not been done, as it is the percentage change which is of interest in this report.
2. Sludge treatment costs, at the WWTP – As the sludge from the water treatment plant forms a very small share of the total sludge handled at the WWTP, the costs associated with treating this portion of the sludge, may be ignored.
3. Treated-sludge transport costs, from the WWTP to the farms – for the same reason as above, these costs could also be overlooked.

The capital costs associated with the plant and the equipment are not considered. Because the focus of the analysis is on dematerialization, over-materialisation and trans-

materialisation of the coagulant – in one of the series of processes at the WTP – the capital costs do not change.

Using the specific costs introduced in the previous section, Table 7 has been constructed. The total expenses for each of the scenarios – status quo, A1, A2, A3, A4, B1, B2 and C – can be calculated by summing up and the percentage changes thereby determined.

*Table 7: Record of operational expenditures – chemicals and electricity (in kNOK)*

OPEX ITEMS	STATUS QUO	A1	A2	A3	A4	B1	B2	C
Granulated aluminium sulphate	1,308	785	1,046	1,570	1,831	NA	NA	NA
Liquid aluminium sulphate	NA	NA	NA	NA	NA	NA	NA	1,792
NaOH	654	654	654	654	654	1,059	1,059	654
NaOCl	68	68	68	68	68	68	68	68
Iron chloride	NA	NA	NA	NA	NA	902	NA	NA
Iron chloride sulphate	NA	NA	NA	NA	NA	NA	902	NA
CO <sub>2</sub>	NA	NA	NA	NA	NA	71	71	NA
Electricity (all needs)	1,848	1,848	1,848	1,848	1,848	1,848	1,848	1,848
Total	3,880	3,356	3,618	4,141	4,403	3,960	3,960	4,363

### 3.2.8. Multi-criteria assessment

The methodology used is presented extensively in Venkatesh et al. (2015). A more detailed presentation of the method and of the results obtained for the optimization of Stangasen WTP can be found in Venkatesh et al. (2015).

A single weighted percentage value can be obtained by summing up the weighted percentage changes.

$$\Delta\text{Sust}\% = (-k_{\text{cost}} * \Delta C\%) + (-k_{\text{env-upstream}} * \Delta E_{\text{upstream},\%}) + (-k_{\text{env-process}} * \Delta E_{\text{process},\%}) + (k_{\text{WQ}} * \Delta WQ\%) \quad \text{eq 1}$$

Where  $\Delta\text{Sust}\%$  is the weighted sum of the percentage changes ( $\Delta C\%$  the percentage change in costs,  $\Delta E_{\text{upstream},\%}$  and  $\Delta E_{\text{process},\%}$  the percentage change in environmental impacts upstream and during the production,  $\Delta WQ\%$  the percentage change in water quality) interpreted as a percentage change in ‘sustainability’. The ‘k’ values with the appropriate subscripts are the weighting factors referred to.

By definition, a positive value of  $\Delta\text{Sust}\%$  indicates a desirable change (a sustainable one in other words), and a negative one would entail rethinking. The relative importance of removal of Colour /TOC, Turbidity, and Microorganisms (Barrier efficiency), was gauged by seeking weighting factors from experts and personnel either working at / associated with the Stangasen WTP, or experienced and knowledgeable as far as the water and wastewater in Norway is concerned, and averaging the same subsequently. These respondents also provided the weighting factors referred to in Equation 1 –  $k_{\text{cost}}$ ,  $k_{\text{WQ}}$ , etc. They respondents are randomly referred to as A, B, C, D, E and F, in Table 8 below. Here, it must be mentioned that no difference is made between  $k_{\text{env-upstream}}$  and  $k_{\text{env-process}}$ . A single weighting factor  $k_{\text{env}}$  is defined, and the environmental impacts both on the upstream and process-related are added together.

*Table 8: Weighting factors (in %)*

OPEX ITEMS	A	B	C	D	E	F	AVERAGE
Water quality ( $k_{\text{WQ}}$ )	30	70	60	70	50	80	60
Environmental ( $k_{\text{env}}$ )	20	10	20	0	30	10	15
Economic ( $k_{\text{cost}}$ )	50	20	20	30	20	10	25

Water quality considerations are prioritized above the environmental and economic since it is directly related to consumer's health. In fact, as seen in Table 8, the sum of the weights of the two latter aspects is less than the weight assigned to water quality, which here is considered to be a proxy for the social aspect. In the case of Norway, the social aspect often closely mirrors the political one, so that the 'social' may well be dubbed as 'socio-political'. Abundance of clean water, a hydropower-dominated electricity grid, and a relatively-clean environment (air, water and soil) with a very high carrying capacity make the environmental aspect less critical, vis-à-vis many other regions in the world. Barrier efficiency (safety/removal of microorganisms) scores the most, among the quartet of parameters determining water quality in our study.

*Table 9: Relative sustainability measures for the six alternatives*

WEIGHTING FACTOR ALTERNATIVE	$\Delta C\%$	$\Delta E\%$	$\Delta WQ\%$	$\Delta SUST\%$
	25%	15%	60%	
A1	-13,4	-25,5	-43,8	-19,1
A2	-7,8	-9,8	-12,4	-4,0
A3	7,2	11,6	10,5	2,8
A4	12,6	24,0	10,6	-0,4
B1	3,4	-20,6	11,7	9,3
B2	3,4	-23,3	11,7	9,7
C	11,0	-14,3	0,0	-0,6

As seen from Table 9, alternative B2 –iron chloride sulphate - turns out to be the best option with respect to holistic sustainability (9.7% overall improvement) – costs rise by 3.4%, environmental impacts decrease by 23.3% and water quality improves by 11.7%, with respect to the status quo situation. If the same coagulant that is being used currently is to be retained, in order to comply with the barrier indicator values mentioned earlier in the report, a minor optimization potential was identified. These results are, however, contrary to the findings from similar optimization experiments at most enhanced coagulation facilities in Norway, where potential reductions ranging from 20% - 40% in coagulant dose levels – and in the corresponding sludge production rates - were identified, thus allowing a more sustainable operation while still maintaining safety and barrier efficiency and stability (Eikebrokk, 2009).

In this study, a sensitivity analysis could have been performed by considering different sets of weighting factors. But the weighting factors are obtained from experts and then averaged. Hence, it was found not useful to test different sets of weighting factors. Further, one could also repeat the experiments with different inlet WQ parameters and determine the effect on the total sustainability index for the approaches considered.

### **3.2.9. Summary from case study in Norway**

The following points may be summarized:

- An operation performance status mapping as well as comprehensive full-scale optimization trials has been performed, including water quality surveys and analyses incl. NOM fractionation, BDOC analyses, use of chemicals and energy, etc.
- The performance assessments and optimization efforts revealed that the main challenge at Stangåsen water treatment plant is to meet the barrier requirements, especially for TOC and turbidity.
- The problems for meeting barrier indicator requirements (TOC) indicate that a transition to the Fe-based coagulation should be considered. Iron-based coagulation removes usually NOM somewhat in a more effective way than Al-based coagulation (often around 10%). Though, Fe-coagulation will require a significantly lower coagulation pH (pH 4-5).
- LCA study shows that the coagulant - aluminium sulphate - contributes the most to the overall environmental impact. Alternative coagulant maybe used to reduce environmental impacts. Different types of coagulants have been assessed with the LCA tool: liquid aluminium sulphate,  $\text{FeCl}_3$ , and iron chloride sulphate  $\text{FeClSO}_4$ , both being produced with green energy in Norway.
- The sustainability assessment has identified that iron chloride sulphate is the best option to improve the sustainability at Stangåsen water treatment plant.

### 3.3. Case Study in the Netherlands

#### 3.3.1. Introduction to Waternet and Weesperkarspel WTP

This section describes an overview of the performed research, realized implementations and future plans of Waternet, aimed at 1) a more sustainable operation of drinking water production and 2) improvement of NOM removal and understanding of the effects of NOM on the operation. The section includes the sustainability targets of Waternet, lessons learned and implemented improvements in the past five – ten years concerning sustainability and NOM removal, as well as some of the on-going research projects.

Waternet is the first and only water cycle company in the Netherlands, established on January 1st, 2006. Waternet is responsible for all activities in the water cycle in and around Amsterdam, comprising drinking water treatment and distribution, wastewater collection and treatment, and water system management and control (van der Hoek, 2011). Different water types in the water cycle are of concern, namely groundwater, surface water, drinking water and wastewater.

The drinking water of Waternet is produced at two facilities: the Weesperkarspel (WPK) water treatment plant is located in Amsterdam South East, and the Leiduin water treatment plant is located in the dune area near Vogelenzang, west of Amsterdam. The water of Weesperkarspel is pretreated at Loenderveen, located approximately 10 km south of the Weesperkarspel facility. The water of Leiduin is pre-treated at the WRK facility in Nieuwegein, which is located approximately 60 km south east from Leiduin.

The annual drinking water production capacity is 90 Mm<sup>3</sup>/y, of which 30% is produced by Weesperkarspel and 70% is produced by Leiduin. The production capacity of Weesperkarspel WTP is circa 25 Mm<sup>3</sup>/year. The two facilities supply the drinking water to the inhabitants of Amsterdam and surroundings, approximately 900,000 people. The geographical outline of the drinking water (pre)treatment facilities of Waternet is presented in Figure 22.



Figure 22 Geographical outline drinking water production and distribution of Waternet

The process configuration of the Loenderveen pretreatment and the Weesperkarspel treatment facility is presented in Figure 23. The pretreatment comprises the intake of Bethune polder water (or Amsterdam-Rhine canal water as back-up facility), coagulation, lake water reservoir and rapid sand filtration. The ‘test reservoir’, shown in the picture below, is bypassed since 2009. The bypass led to a tenfold reduction of bacteria occurring by the feces of residing birds on the reservoir. The Weesperkarspel treatment comprises ozonation, fluidized bed softening, biological activated carbon filtration and slow sand filtration.

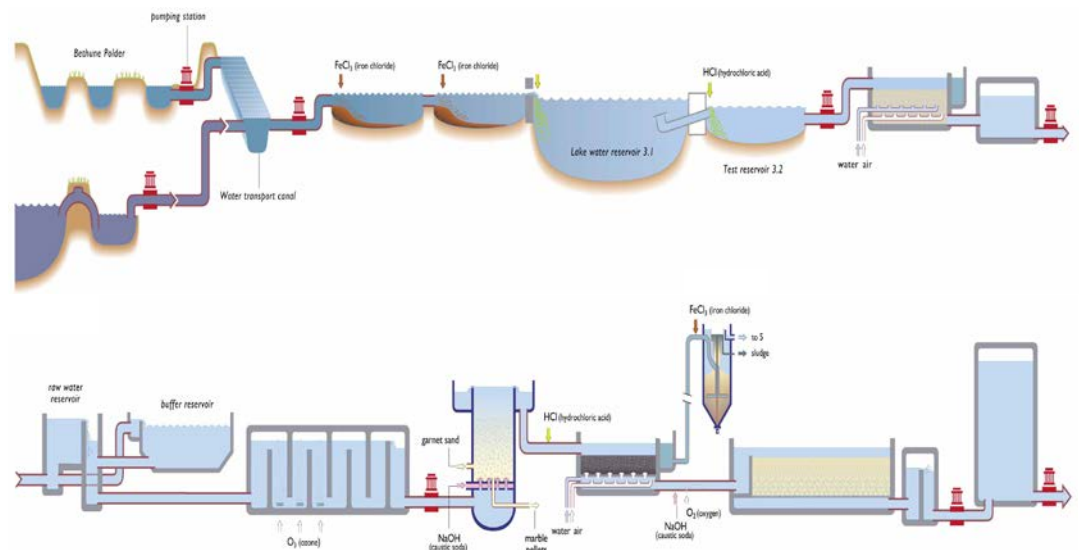

Figure 23 Process configuration of Loenderveen pretreatment and Weesperkarspel treatment facilities

The extensive treatment is needed because of the raw water quality (disinfection and removal of organic micro pollutants is needed) and very good biological stability that is needed to supply drinking water without any chlorine dosing. The raw water at Weesperkarspel may occasionally contain several organic micro pollutants, for which Weesperkarspel has ozonation and GAC filtration processes. Table 10 shows typical raw and treated water quality data from Weesperkarspel.

*Table 10: Typical water quality data from Weesperkarspel WTP (average 2011)*

SAMPLING POINT	pH	TURB (NTU)	UV-abs $m^{-1}$	DOC mg/L	AOC $\mu g/L$	Ca mg/L
Raw	7.6	33	29.8	8.2	n.a.	87
Drinking Water	8.0	0.03	5.2	3.2	18	49

In the past two decades, the amount of NOM in the raw water has increased by approximately 10%. After coagulation and sedimentation at the Loenderveen pre-treatment plant, the amount of DOC is reduced by approximately 3 mg/L. A further 3 mg/L is removed by the Weesperkarspel treatment plant.

### 3.3.2. Sustainability targets Waternet

Waternet has set the ambition to operate in a climate neutral way in 2020. In order to realize this ambition, measures are required to compensate for an emission of 53 kton CO<sub>2</sub>-equivalents per year (Status 2011, according to van der Hoek, 2011. Status 2014: targeted reduction is 50.5 kton CO<sub>2</sub>-equivalents per year, according to S. Mol). This corporate objective can be reached by reduction of direct greenhouse gas emission, reduction of energy and production of sustainable energy, and thoughtful resource usage (Waternet Watercycle Plan). Waternet reduced the emissions via three routes, which are scope 1, 2 and 3 according to the Greenhouse Gas Protocol. The emission because of production of electricity (scope 2) has been compensated by the use of renewable energy. Next, Waternet is realizing projects by which the direct emission (scope 1) or the emission correlated to the usage of chemicals and materials (scope 3) is reduced or compensated for.

The climate footprint can be calculated with SimaPro LCA (life cycle assessment) Software, and is expressed in EcoPoints (Pt) or milli EcoPoints (mPt). The EcoPoint scale is chosen in such way that the value of 1 Pt is representative for one thousandth of the yearly environmental load of one European inhabitant. The SimaPro LCA software is based on the implementation of the world's leading database Ecoinvent. The climate footprint of Waternet (expressed in Pt) was reduced with a factor of two for the entire water cycle between 1990 and 2010, mainly by the usage of renewable electricity only (Klaversma, 2013). Currently, the largest contribution to the climate footprint (60%) is caused by indirect emissions through the use of materials and chemicals. Waternet performs life cycle



assessment (LCA) studies for investment decision support. In the period 2010–2013, Waternet performed about ten LCA studies, both on wastewater projects and drinking water projects. Prior to 2010, LCA studies were performed as well. Some of the LCA results were published by Barrios (2008), Tapia (2008) and Klaversma (2013). Barrios et al. (2008) found that the impact of the operational stages of the pretreatment of Loenderveen was 2.63 mPt/m<sup>3</sup>, and the impact of the final treatment of Weesperkarspel was 5.98 mPt/m<sup>3</sup>. The total environmental impact is found to be 8.61 mPt/m<sup>3</sup>. Table 11 presents the contribution of each process unit to the total environmental impact (Barrios, 2008). The annual production of Weesperkarspel is approximately 26 Mm<sup>3</sup>/y, hence the total environmental impact is almost 225000 Pt/year.

*Table 11: Contributions to environmental impact from processes at LDV and Weesperkarspel as mPt/m<sup>3</sup> and percentage (Barrios, 2008)*

TREATMENT PROCESS LDV AND WPK	mPt/m <sup>3</sup>	%
Coagulation	2.01	23.3%
Lake water reservoir	0.49	5.7%
Softening	3.93	45.7%
BACF	1.17	13.6%
Slow sand filtration	0.72	8.4%
Other processes	0.28	3.3%

Data on the consumption of energy during 2010, 2011 and 2012 show that the total energy consumption for water pumping and treatment is 0.406 kWh/m<sup>3</sup> of water produced.

### 3.3.3. Procedures to increase sustainability

This section provides a summary of the research projects and implemented investment projects with an impact on sustainability. The summary is presented in Table 12. This table provides a summary of the quantified contribution of several investments to a more sustainable water supply. A more complete description and analysis of this research and subsequent implementations was provided in TRUST Deliverable 41.1. The research and implementation was conducted by Waternet, and for this purpose mostly related to the Weesperkarspel facility and the pre-treatment at Loenderveen. In many cases, the research results are accompanied with LCA analyses and feasibility analyses in order to justify implementation or investment.

Table 12: Quantification of research and implementation of improved sustainable water supply projects at Weesperkarspel and Loenderveen

PROCESS	PROJECT	GOALS AND PRINCIPLES	CONTRIBUTION	IMPLEMENT
Softening	General	<p>Softening has various advantages:</p> <ul style="list-style-type: none"> <li>- Customer satisfaction: decrease of calcium carbonate scaling.</li> <li>- Public health: pH value increase reduces copper and lead release from piping materials.</li> <li>- Social costs: decreased detergents usage, decreased maintenance/replacement costs warm water appliances, increased energy efficiency.</li> <li>- Environmental benefits: reduced detergent usage, reduced copper and lead release to waste water, increased energy efficiency.</li> </ul>	<p>Environmental impact reduction of 25% due to softening from 2,25 to 1,5 mmol/L.</p> <p>Softening at Weesperkarspel corresponds to impact reduction in <i>overall system</i> (WPK treatment plant + household area) of:</p> <p><b><u>3.5 x 10<sup>6</sup> mPt/year</u></b></p>	Since 1987
	pH correction reactor effluent	<p>Replace hydrochloric acid pH correction with carbon dioxide pH correction.</p> <p>Annual usage and transport of carbon dioxide less than hydrochloric acid.</p>	<p>Environmental impact reduction at WPK treatment plant:</p> <p><b><u>7 x 10<sup>6</sup> mPt/year</u></b></p>	Planned in near future
	Calcite	<p>Replace garnet sand seeding material with calcite seeding material. Calcite is produced from the calcium carbonate pellet produced in softening as by-product. Environmental impact reduction due to:</p> <ul style="list-style-type: none"> <li>- local production of seeding material;</li> <li>- replacement of commercial calcite in Dutch industries with locally produced “drinking water calcite”.</li> </ul>	<p>Environmental impact reduction in <i>overall system</i> (WPK treatment plant + calcite using industries) of:</p> <p><b><u>10.6 x 10<sup>6</sup> mPt/year</u></b></p>	<p>Pilot: 2014 – 2015</p> <p>Decision on continuation: 2015 – 2016.</p>

	Nanofiltration	Replace current fluidized bed softening with nanofiltration. Environmental impact reduction is attained through reduction of caustic soda usage. Disposal of brine was not accounted for in calculation.	Environmental impact reduction at WPK treatment plant:  <b><u>94 x 10<sup>6</sup> mPt/year</u></b>	Future possibility, no concrete plan for implement.
Loenderveen Pre-treatment	pH correction	Replace hydrochloric acid pH correction with carbon dioxide pH correction.  Environmental impact reduction due to chemical usage and transport.	Environmental impact reduction at LNV pre-treatment plant:  <b><u>12 x 10<sup>6</sup> mPt/year</u></b>	Implemented (prior to 2013)
	Enhanced coagulation (Tapia, 2008)	Increase NOM removal.  Additional chemicals needed for pH adjustment, reduction of ferric chloride dosage.	Environmental impact reduction for LNV pre-treatment plant:  <b><u>10 x 10<sup>6</sup> mPt/year</u></b>	Researched

Besides abovementioned quantified measures for sustainability improvement, next additional improvements are implemented at Weesperkarspel or are being researched by Waternet:

- Backwash water reduction project lead to a backwash water usage reduction of 5%, which corresponds to 1.3 million m<sup>3</sup> of water per year.
- Optimization of the fluidized bed control lead to a reduction of seeding material (garnet sand) usage.
- The water demand model based predictive control and renewed process automation projects created possibilities to install more energy efficient pumps. In the future, it could be possible to further decrease distribution related energy requirements by means of pressure controlled pumping (pressure sensors in the distribution area are available).
- Klaversma (2013) compared the LCA studies of several climate impacts reducing implantation. One option involves the reuse of iron containing sludge from drinking water production process rather than iron chloride for the phosphate removal. It was shown that this option would lead to an environmental impact reduction of approximately 10% (expressed in Pt). The best way to improve the climate footprint of phosphate removal and recovery is by adding magnesium chloride to digested sludge during aeration and form struvite. Waternet has implemented this struvite project in 2013.

Currently, Waternet performs a great deal of sustainability and resource recovery related research projects. As Waternet is a water cycle company, some of the research involves the entire water cycle:

- Waternet investigates the possibility to recollect heat from showers.
- Waternet operates waste water treatment plants and investigates possibilities to increase the sustainability of the waste water treatment operations by reducing the emission of the strong greenhouse gas of nitrous oxide (laughing gas).
- Waternet plans to investigate the possibilities to convert calcium carbonate pellets (softening by-product) back to calcium oxide quick lime (burnt lime), which could be used as chemical for softening rather than caustic soda.
- Prior to dune infiltration in Leiduin, river water is pretreated at the WRK site in Nieuwegein, 60 km land inwards. The pipeline which transports the pretreated water to the dune site runs nearby the airport of Schiphol. Waternet and Schiphol investigate the possibilities to provide cooling from this water.
- Waternet is involved in the researching of thermal energy storage.
- Waternet investigates the possible savings household could make by distributing drinking water with somewhat higher temperatures in the winter.

### **3.3.4. Procedures to decrease adverse effects of NOM**

This section provides an overview of research on the characterization of NOM, the removal of NOM and the understanding of the effects of NOM in the water treatment process. NOM interacts with several treatment processes in a negative way, therefore NOM removal is of interest because of various reasons.

NOM increases the ozone demand in the ozonation. The higher required ozone dosage might therefore lead to higher bromate formation. NOM provides precursor compounds for disinfection by-products. NOM competes with the target components for adsorption on activated carbon. Waternet, as well as other drinking water companies in The Netherlands, distributes drinking water without chlorine disinfectant residual.

Several conditions must be met in order to distribute chlorine free drinking water. A few of these conditions are i) realization of sufficient disinfection by alternative technologies, good engineering and maintenance practices of the distribution network, and ii) the production of biologically stable drinking water in order to prevent regrowth of bacteria. The presence of NOM forms a threat to the production of biologically stable drinking water. NOM is oxidized by ozone to assimilable organic carbon (AOC), which may lead to regrowth in the distribution network in case AOC is not sufficiently removed by the biological activated carbon and the slow sand filters.

Both drinking water sources of Waternet, river Lek water and Bethune polder water, contain NOM. This section summarizes the most important research results and implementations

performed by Waternet regarding the effects, presence and removal of NOM, with a focus on the Weesperkarspel facility. In the current situation, the NOM concentration of the Weesperkarspel drinking water approximately is 3 mg/L. A more complete description and analysis of this research and subsequent implementations was provided in TRUST Deliverable 41.1.

### **Improving coagulation**

The pre-treatment of Loenderveen has two coagulation reservoirs which are operated in series. Nowadays, the ferric chloride dosage is 8 mg/L Fe in the first reservoir and 4 mg/L Fe in the second reservoir. The lake water to be treated contains 9 mg/L NOM. The primary goal of coagulation is the removal of phosphorous in order to limit algae growth. The NOM has increased over the past decades (Figure 24).

The current NOM removal is 20%. The phosphate removal has decreased over the past decades. Waternet investigated the application of enhanced coagulation in order to improve the removal of NOM. New insights in the occurring biological processes in the drinking water lake show that long-term efficient phosphate removal prior to the lake seem to inhibit the self-purification capacity of the lake too much.

The enhanced removal of NOM is favourable to the consecutive treatment processes of ozonation and activated carbon filtration, and will lead to cost savings in these processes. In order to apply enhanced coagulation, the pH value needs to be lowered first, next the ferric dosage will be lower compared to conventional coagulation, and finally the pH value needs to be increased. Waternet conducted several studies regarding the application of enhanced coagulation (Table 13).

Table 13: Several studies on enhanced coagulation

	EFFECT ON NOM	EFFECT ON PHOSPHATE	OPERATIONAL CONDITIONS	CONCLUSION
Febrina (1998)	DOC reduction of 50 – 60 %.	Phosphate reduction of 80 – 90%.	1st coagulation step optimized for DOC removal @ pH value of 5, and 5 ppm FeCl <sub>3</sub> dosage.  2nd coagulation step optimized for phosphate removal @ pH value of 7, and 5 ppm FeCl <sub>3</sub> dosage.	
Peerdeman (1998)	Reduce DOC to 3 mg/L.		@ pH value of 6.5, and 15 mg/L Fe dosage.	Costs for pH adaptation (HCl dosing) do not outweigh savings related to reduced activated carbon reactivation frequency.
Van Leenen (2005)			@ pH value of 5.5	Additional costs of 0.05 €/m <sup>3</sup> .  Corresponds to an increase of 30%.
Tapia (2008)				Additional costs of 0.009 €/m <sup>3</sup> . <sup>1</sup>

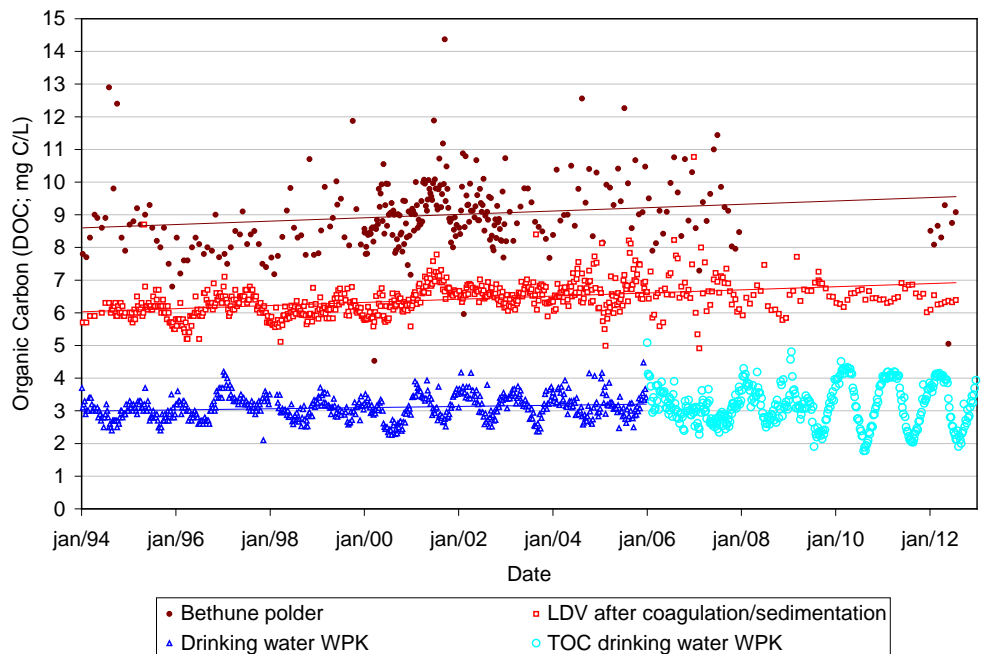

Figure 24 Historical DOC development at Weesperkarspel

Currently, Waternet considers implementing various process adaptations with respect to the coagulation:

- The application of enhanced coagulation is considered because of new insights regarding the long term efficient removal of phosphate and the advantageous of an increased NOM removal.
- The process economics and environmental impact will change if carbon dioxide is used rather than hydrochloric acid for pH adjustment.
- Ferric chloride is dosed in a fixed rate based on the production capacity, but it is investigated whether it is possible to apply variable dosing rates based on the actual water quality. The optimization of the coagulant dosing could lead to an improved NOM removal on one hand, and a reduction of coagulant usage in periods the water quality allows to, and therefore affecting both the performance of consecutive processes as well as sustainability.
- The application of pre-polymerized ferric chloride in the coagulation is considered in order to further improve the coagulation and to increase the NOM removal.

### NOM removal by ion exchange (IEX)

Anionic ion exchange is able to remove negatively charged NOM fractions. Removal of NOM prior to ozonation will decrease the ozone demand, it will increase the disinfection elimination capacity and will lead to a decrease of biodegradable carbon (AOC). Removal of

NOM prior to activated carbon filtration decreases competition for adsorption of micropollutants and leads to a decrease of the reactivation frequency. Finally, removal of NOM can lead to an increased biological stability of the finished drinking water.

Waternet tested fluidized ion exchange (FIX) and magnetic ion exchange (MIEX) in the pilot plant at Weesperkarspel, at various positions in the process configuration. Tests were performed with IEX prior to ozonation and IEX after slow sand filtration (prior to distribution). Water quality analysis results and process operation parameters were integrated in a conceptual design, and the addition of cost information has led to a business case calculation. The expected variation of DOC across the treatment process is summarized in Table 14, these data were used as an input for the cost evaluations calculations (Grefte, 2013).

*Table 14: Input for cost evaluation: expected variation of DOC across treatment process (Grefte, 2013)*

	DOC CONCENTRATION (MG/L)			
	CURRENT PROCESS	BEFORE COAGULATION	BEFORE OZONATION	AFTER SLOW SAND FILTRATION
Raw surface water	9.0	9.0	9.0	9.0
IEX effluent	–	3.5	–	–
Coagulation effluent	7.1	2.7	7.1	7.1
Surface reservoir effluent	6.5	2.5	6.5	6.5
Rapid sand filtration effluent	6.0	2.2	6.0	6.0
IEX effluent	–	–	2.2	–
Ozonation effluent	5.7	2.1	2.1	5.7
Pellet softening effluent	5.4	2.0	2.0	5.4
Biological activated carbon filter effluent	3.0	1.2	1.2	3.0
IEX effluent	–	–	–	1.0
Finished water	2.7	1.0	1.0	1.0



It was concluded that ion exchange positioned before the ozonation was the most cost effective and improved the biological stability of the drinking water (Grefte 2011). Waternet decided not to install ion exchange, because the costs of FIX (capital and exploitation) do outweigh the advantages of FIX concerning the improvement of the biological stability of the drinking water, the effect on the environmental impact is limited, and installation of IEX does not outweigh the cost savings in ozonation and biological activated carbon filtration.

- The expected costs of IEX vary between 0.062 and 0.066 €/m<sup>3</sup>. The highest costs occur if FIX is installed before coagulation, followed by installation before ozone and finally installation after slow sand filtration. The cost savings in the downstream processes vary between 0.012 and 0.017 €/m<sup>3</sup>. The highest savings are obtained if FIX is installed before coagulation. No savings are obtained if FIX is installed after slow sand filtration. The net costs of FIX vary between 0.049 (FIX before ozonation) and 0.062 €/m<sup>3</sup> (FIX after slow sand filtration).
- It was estimated that IEX installation prior to coagulation will lead to an environmental impact reduction of 26 x 10<sup>6</sup> mPt/year, and IEX installation prior to ozonation will lead to an environmental impact reduction of 2.6 x 10<sup>6</sup> mPt/year. Installation of IEX after slow sand filtration does not affect the environmental impact of the existing treatment plant.
- The AOC concentration in two IEX scenarios (IEX prior to ozonation versus IEX after slow sand filtration) was lower than the current situation, and the biofilm formation rate of the finished water decreased by 70%, to 2 pg ATP/cm<sup>2</sup>.day in case IEX was positioned before ozonation.

### **NOM in softening**

NOM is oxidized to AOC in the ozonation. Ozonation is followed by softening. Hammes et al. (2011) shows that AOC is removed during pellet softening at the Leiduin treatment plant. The biomass present on the calcium carbonate pellets was characterized with various analyses techniques, such as ATP analyses and advanced microscopy. They found that these organisms could remove up to 60% of the AOC formed in ozonation, and therefore softening contributes to the biological stability. Such data are not available for the Weesperkarspel plant.

### **NOM in ozonation**

The primary goal of ozonation is disinfection. Also, micropollutants are oxidized during ozonation. The oxidation of NOM leads to formation of biodegradable organic carbon, which will be partly removed by subsequent biological activated carbon filtration. Disinfection by products are formed during ozonation. Bromate is the most important disinfection by product. The Dutch standard for bromate is 5 µg/L in case bromate is formed due to disinfection. The bromate formation depends on the precursor concentration (bromide), the ozone dose and the contact time. The ozone dosage depends on the ozone demand which is

influenced by the presence of NOM. Lower amounts of NOM reduce the ozone demand, and as a consequence bromate formation can be reduced. Waternet has performed various studies to optimize the disinfection capacity, while limiting bromate formation at the same time. Waternet has implemented various adaptations to the ozone dosing system, the ozone contact chambers and the operational conditions of the ozonation.

### **Static mixers and adaptation of ozone dispersion system (2008-2009)**

Ozone is dosed in the so-called ozone dosing chambers via a gas dispersion system. The dosing chambers are situated before the ozone contact chambers. The ozone contact installation comprise ten chambers, initially having one inlet chamber, three ozone dosing chambers and six contact chambers. The number of ozone dispersion systems was reduced from three to one (2008). In order to remain controllability of the dosing system and to compensate for the smaller total gas flow, the ozone concentration in the gas flow was increased from 10 to 17 g/Nm<sup>3</sup>.

The ozone dosing system in the third chamber was removed. Waternet installed static mixers in this chamber in order to improve the mixing behavior of the water and the ozone. The enhanced mixing leads to an increased disinfection capacity. In the Leiduin treatment, baffles were installed in the ozone contact chambers in order to improve the hydraulic flow conditions. The installation of baffles led to a decrease of the residence time distribution, an improvement of the disinfection capacity and limitation of bromate formation. The installation of baffles was based on computational fluid dynamics (CFD) modelling (Wols, 2008). The adaptation was initiated for the Leiduin facility because of bromate formation.

### **Bypass ozone dosing system (2013-2014)**

Currently, the ozonation in Weesperkarspel is adapted to the new insights in ozone reaction rates and the elimination of specific micro-organisms. The ozonation was designed in the 1970s in order to maintain high CT-values. The ozone reaction rates are rather high and consequently, large residence times are no longer required. The application of large CT-values for elimination of *Giardia* and spores of sulphite reducing *Clostridia* (SSRC) is not required because these microorganisms are effectively removed by the slow sand filtration. The first five ozone chambers have been removed, which leads to a reduction of the residence time of approximately 30%.

Another trigger was the replacement of the gas dosing system was of the installation of ozone generators. Formerly, ozone was produced from air, but nowadays ozone is produced from pure oxygen. This leads to higher ozone concentrations and as a consequence the ozone gas rate needed to be reduced.

The ozone dosing chambers are replaced by the so-called bypass dosing system. The first five chambers are replaced by one pipe, in which the ozone is dosed. This system is also known as a dissolved ozone plug flow reactor (DOPFR). The ozone is dosed in a water flow which accounts for 5% of the total flow. Because of the high ozone concentrations in the bypass flow, the bromate formation in this stream will be high. However, the overall

bromate concentration will be lower (van der Helm 2009). The bypass piping system was optimized with CFD modelling (Wols et al. 2008).

Waternet intends to implement UV scans in the ozone contact chambers in order to detect the ozone concentrations. The on-line ozone data are used as the input for a model which can be used to control the ozonation performance.

### **NOM in biological activated carbon filters (BACF)**

The biological activated carbon filters adsorb micro-pollutants and aim for degradation of the AOC which is formed in the ozonation. The reactivation criterion used to be the DOC concentration of the effluent of 3 mg/L. These criteria led to an average time between reactivation of approximately 1.5 years, without direct relation to the water quality.

Until 2010, the reactivation of the activated carbon was planned throughout the whole year. The temperature of the Weesperkarspel water is significantly higher during summer time compared to winter time. The required adsorption capacity is the largest during the higher temperature period in order to limit regrowth in the distributed water. Secondly, the development of active biomass on the filters is faster when the water temperature is higher, which is favourable for the removal of AOC in the BACF. Therefore, after 2010 it was decided to plan the majority of the reactivations prior to the warmer period, between May and August. This results in a DOC concentration of 2.5 mg/L during summer, and 3.5 mg/L during winter.

The current reactivation criterion has been determined years ago and might be obsolete for several reasons:

- AOC formation is expected to decrease because the ozone dosage system was adapted;
- The current DOC criteria are not actually used to determine the reactivation moment;
- The annual production capacity is approximately 4 Mm<sup>3</sup>/y lower than former times.

Waternet wants to optimize the reactivation procedure and the reactivation frequency because reactivation is costly, it has a large impact on the environment and the current reactivation criteria are subject to improvement. Waternet plans to include water quality data (*e.g.* AOC and micro pollutants) and other measurements into the reactivation criteria. The reactivation procedure improvement involves a midterm reactivation planning, variable water flow per carbon filter, keeping filters standby rather than continuous production and includes the actual number of bed-volumes treated.

### 3.4. Case Studies in United Kingdom

Three Scottish Water (SW) sites have been selected for the TRUST activities in this work package, namely: Tullich, Bradan and Amlaird WTWs. The SW region has suffered water quality deterioration impacts that have been driven by climate change. Water quality deterioration has principally been observed through increases in water colour and NOM. For example, at Amlaird WTWs the water colour has increased by 22% from 2009 to 2010. Colour in other water sources in the region have over doubled over the same time period. This has caused significant treatment challenges for the WTWs that receive these waters, with the main concern centred on disinfection-by-product (DBP) formation. SW has seen big improvements in DBP compliance (an 85% reduction in the failure rate) over the last 10 years, but this has principally been caused by asset operation improvements against the back-drop of deteriorating water quality. The three selected WTWs have been chosen as they represent different treatment flow sheets and have different source water characteristics. In addition, these sites have further potential to be improved with respect to water quality compliance.

#### 3.4.1. Tullich Water Treatment Works

The WTWs treats a typical flow of 10 million litres per day (MLD), serving a population of 15,000 inhabitants. The flow sheet for the WTWs is shown in Figure 25. The site is a bio-filtration plant consisting of pre-filtration using microstrainers, pre-ozonation, granular activated carbon filtration and post ozonation. The primary disinfectant for the treated water is chlorine due to the regulatory requirement of residual disinfection for the water in distribution.

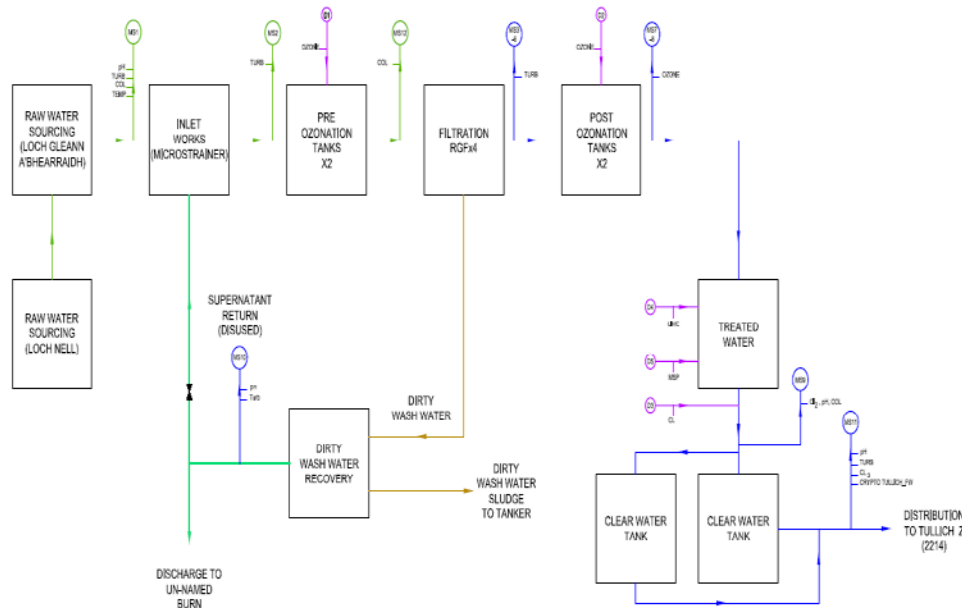

Figure 25 Process scheme – Tullich WTWs

## Results from Tullich WTWs

The raw water colour ranges between 10 – 100 Hazen, with an average value of 30 Hazen. As expected for a water source of moderate water colour, the site receives water of intermediate DOC concentration, with values ranging between 1.5 – 5.0 mg/l (average – 3.5 mg/l). The raw water turbidity is between 0.5 – 10 NTU (with an average of 0.7 NTU).

The treated water is typically between 2 – 30 Hazen (average – 3 Hazen); 1.5 – 4.0 mg/l TOC (average – 2.5 mg/l); 0.2 – 2 NTU Turbidity (average – <0.25 NTU). Compliance with regulatory THM samples is 62.5% (note that the site does employ secondary disinfection in the related distribution system).

Further characterisation has been carried out at this site for a single point in time (July 2012). The source water was of moderate DOC and UV<sub>254</sub> absorbance and also of low turbidity (Table 1). The bulk of the UV absorbing organics compounds in the raw water are removed by the first ozonation stage as a result of the oxidation of the ‘colour-causing’ DOC. However, significant DOC remains in the water after ozonation with removal of around 1 mg/L of the DOC achieved by oxidation. A further 0.5 mg/L DOC was removed across the activated carbon.

Of interest, the water source has a high charge associated with the organic compounds in the sample. This is identified by the very negative zeta potential in the raw water. The charge is largely removed by the oxidation in the pre-ozone stage. However, after GAC the organic material is highly charged again, indicating that through biological transformation or release of biological DOC, the organic matter becomes negatively functionalised. The secondary ozone is able to partially remove this charge, but not to any great extent.

*Table 15: Tullich WTWs detailed analysis, July 2012*

	UV <sub>254</sub> ABS (cm <sup>-1</sup> )	MEASURED DOC (mg.L <sup>-1</sup> )	ZETA POTENTIAL (mV)	TURBIDITY (NTU)
Raw Water	0.16	3.3	-18.2	0.19
Pre-Ozone	0.06	2.3	-4.6	0.19
GAC Filter	0.05	1.8	-18.6	0.24
Post-Ozone	0.04	1.9	-11.0	0.11

The charge density of the raw water was measured and found to be 7.93 meq.gDOC<sup>-1</sup>, which indicates that the organic matter is highly charged. This is in agreement with the zeta potential values which were very negative for a water source that had a DOC of only 3.3 mg/L. Typical charge densities that have been measured before for other moorland waters

have been of the order of 2-4 meq.gDOC<sup>-1</sup>. The results observed for Tullich show that the DOC is particularly highly charged. This result indicates that coagulation may be an option to consider at the site in order to remove what should be relatively easy DOC to coagulate.

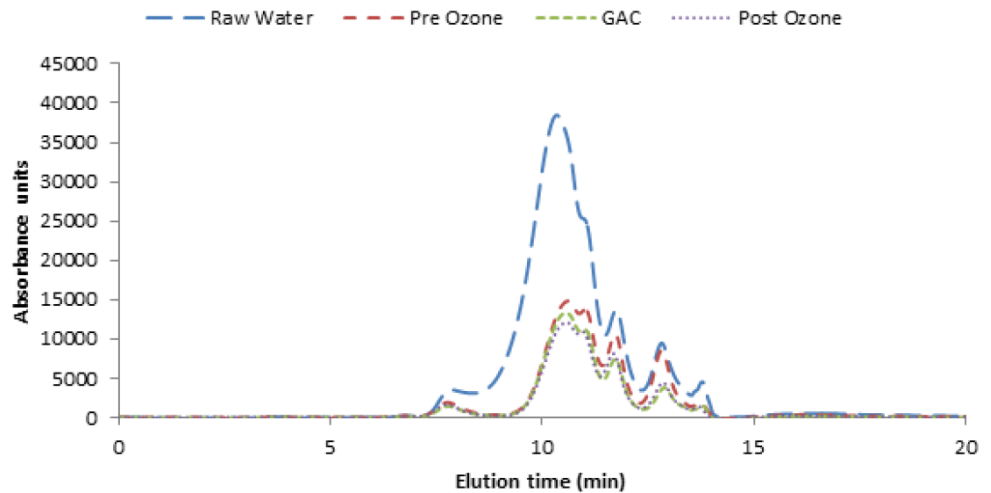

Figure 26 HPSEC trace for Tullich WTWs, July 2012

The HPSEC traces (Figure 26) show the change in MW distribution of organic compounds in the water that are able to absorb UV at 254 nm. On these figures, short elution times (left hand side) represent high MW organic compounds and long elution times (right hand side) are representative of low MW compounds. The higher the spike of the curve is, the higher the concentration of the organics for a specific MW. Because a large portion of the UV254 absorbing compounds are removed after the first ozone stage but a significant portion of DOC remains in the water, care must be taken in not over-interpreting the results for Tullich WTWs. The traces show that the bulk of the high MW organics are degraded or removed after the first ozonation stage, leaving a residual of medium to low MW DOC in the sample that is not removed to any degree by the subsequent treatment processes.

The fractionation data indicates how the DOC is split in terms of its hydrophobicity (Table 16). The organic compounds are split into hydrophobic (HPO), transphilic (TPI) and hydrophilic (HPI) DOC. Most UV absorbing organic matter and charged DOC is usually hydrophobic and this is the fraction which is most easily removed by coagulation (if this process stage was used). It is therefore not surprising to see that the DOC is transformed from HPO to mainly HPI material after the first ozonation stage (Figure 27 and Figure 28). In agreement with the increase in zeta potential observations, there is an increase in the HPO fraction after the GAC stage, indicating again that there is transformation or release of a different type of organic material across this treatment stage (as well as the removal observed). From these figures it appears that there is further argument to use coagulation as a bulk removal process to remove the high proportion of hydrophobic DOC from the raw water.

Table 16: Fractionation data for Tullich WTWs, July 2012

SAMPLE	CALCULATED DOC (mg/L)	HPO %	TPI %	HPI %
Raw	3.0	76.0	1.6	22.4
Pre-Ozone	1.4	9.6	1.5	88.8
GAC	1.5	25.9	1.9	72.2
Post-Ozone	1.4	8.2	10.1	81.7

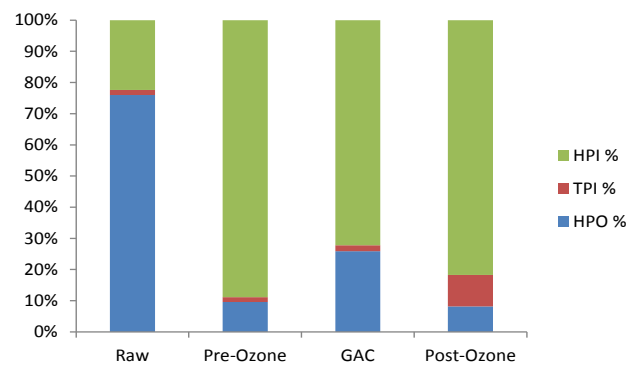

Figure 27 Fractionation on a proportion basis at Tullich WTWs, July 2012

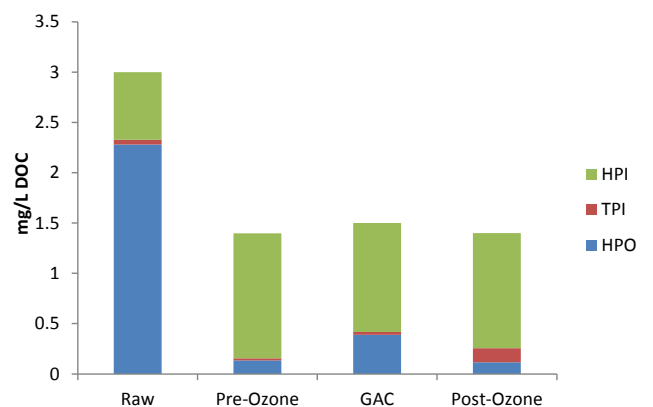

Figure 28 Fractionation on a mass basis at Tullich WTWs, July 2012

The DBP-FP of the water shows the absolute concentration of DBPs that will form by overdosing with chlorine and leaving the sample for seven days. Here we have measured the trihalomethane formation potential (THM-FP) on a normalised  $\mu\text{g THMs.mg DOC}^{-1}$  basis and then calculated a  $\mu\text{g.L}^{-1}$  concentration based on the DOC of the sample. The results show that the DOC in the water has high THM-FP indicating highly reactive organic compounds in the water:

*Table 17: DBP data for Tullich WTWs, July 2012*

SAMPLE	THM-FP ( $\mu\text{g.L}^{-1}$ )	THM-FP ( $\mu\text{gTHMs.mgDOC}^{-1}$ )
Raw	298	90
Pre-Ozone	216	94
GAC	117	65
Post-Ozone	118	62

The reduction in THM-FP on a  $\mu\text{g.L}^{-1}$  basis broadly agrees with the removal of DOC across the first ozone stage. This indicates that there is no change in the reactivity of the DOC as it was predominantly transformed from HPO to HPI material, which was a surprising result. This was confirmed by looking at the similar normalised THM values. This observation is worthy of further investigation because it indicates that a highly reactive HPI fraction of DOC is formed after ozonation. Across the GAC treatment stage, DOC reactivity is reduced and this stays reduced after the post-ozone process.

Key points from the data are that:

- Tullich water is of moderate DOC and UV254. However, the DOC is highly charged and reactive with chlorine in respect of THM formation.
- The DOC is reduced by 50% across the treatment plant.
- THM-FP for the raw water is high. This reduces across the WTWs but still remains high in the final treated water.
- The DOC is transformed across the treatment plant:
  - From being very hydrophobic to predominantly hydrophilic after pre-ozonation.
  - From being highly negatively charged in the raw water to low charge after pre-ozonation to being highly charged again after GAC to being of moderate negative charge after the final ozone stage.
  - No change in DOC reactivity for THM formation after the first ozonation stage. This reactivity is reduced slightly after subsequent treatment processes.



### 3.4.2. Bradan Water Treatment Works

The WTWs treats a typical flow of 75 MLD, serving a population of 200 000 inhabitants. The flow sheet for the WTWs is shown in Figure 29. The site receives water from two separate locations: Derclach Loch and Bradan Loch. The site is a typical coagulation/flocculation, clarification, filtration site with the added addition of an ozonation stage before filtration. The site uses alum as the primary coagulant. The primary disinfectant for the treated water is chlorine due to the regulatory requirement of residual disinfection for the water in distribution.

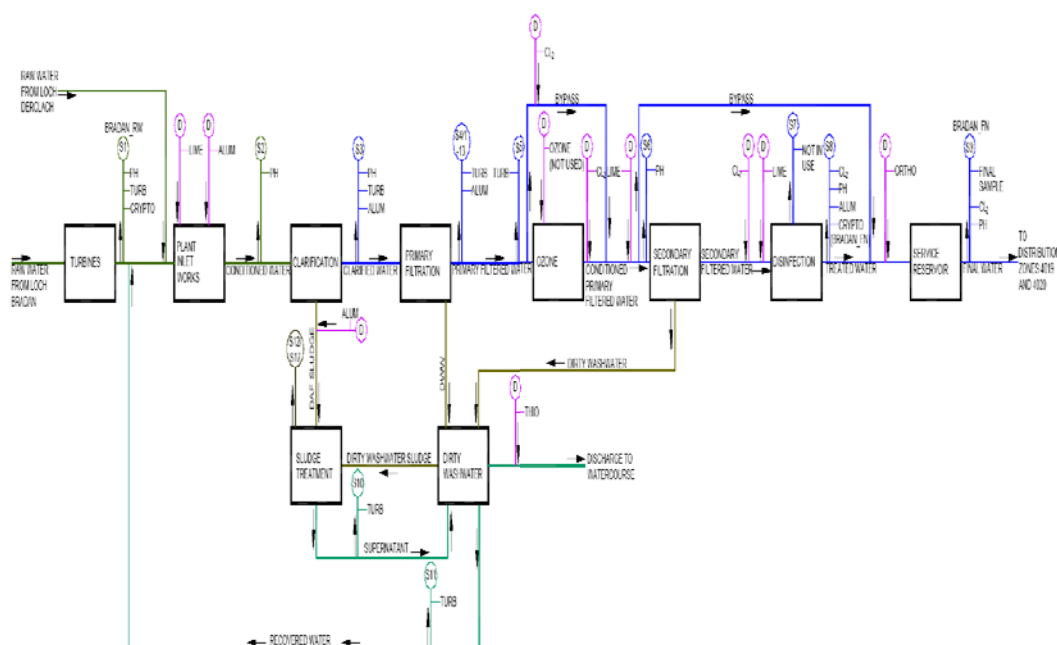

Figure 29 Flowsheet for Bradan WTWs

### Results from Bradan WTWs

The raw water colour ranges between 20 – 100 Hazen, with an average value of 75 Hazen. As expected for a water source of high water colour, the site receives water of moderate DOC concentration, with values ranging between 1.5 – 11.0 mg/l (average – 8.0 mg/l). The raw water turbidity is between 0.5 – 4 NTU (with an average of 0.7 NTU).

The treated water is typically between <2 – 6 Hazen (average – 2 Hazen); 1.0 – 2.5 mg/l TOC (average – 2.0 mg/l); 0.2 – 1 NTU Turbidity (average – <0.25 NTU). Compliance with regulatory THM samples is 75% (note that the site does employ secondary disinfection in the related distribution system).

Further characterisation has been carried out at this site for a single point in time (August 2012). The source waters were of high DOC, whilst the UV<sub>254</sub> absorbance was low, indicating that the water sources were dominated by more hydrophilic NOM (Table 18). There was little difference in the water characteristics for Bradan and Derclach water sources. The combined water most closely represented the ‘Bradan’ water source. Whilst residual UV<sub>254</sub> was acceptable after coagulation, the results suggested that the treated water residual DOC was higher than would be considered ideal given that only half of the DOC was removed by the coagulation process. Residual DOC higher than 2-3 mg/L puts the site at risk of failing disinfection by-products on a routine basis. Further confirmation of the residual DOC in the treated water is required to see if this was a one-off occurrence or if this is regularly as high.

*Table 18: Water quality data for Bradan WTWs, August 2012*

	UV <sub>254</sub> ABS (cm <sup>-1</sup> )	MEASURED DOC (mg.L <sup>-1</sup> )	ZETA POTENTIAL (mV)	TURBIDITY (NTU)
Raw (Bradan)	0.05	16.8	-16.3	0.25
Raw (Derclach)	0.03	14.5	-16.4	0.22
Raw (Combined)	0.05	16.0	-15.6	0.29
Primary filter	0.01	6.9	-10.3	0.12
Secondary filter	0.01	6.6	-7.7	0.13

The charge density for the Bradan raw water was 4.8 meq.gDOC<sup>-1</sup>. For Derclach raw water, the charge density was 6.4 meq.gDOC<sup>-1</sup>. The results indicate that these sources were higher than typical with respect to their charge, indicating that the coagulant dose might not be high enough to match the charge demand. Further increases in the coagulant dose may help reduce the residual DOC given that the current zeta potential of coagulated water was <-10 mV, which is on the cusp of acceptable charge neutralisation.

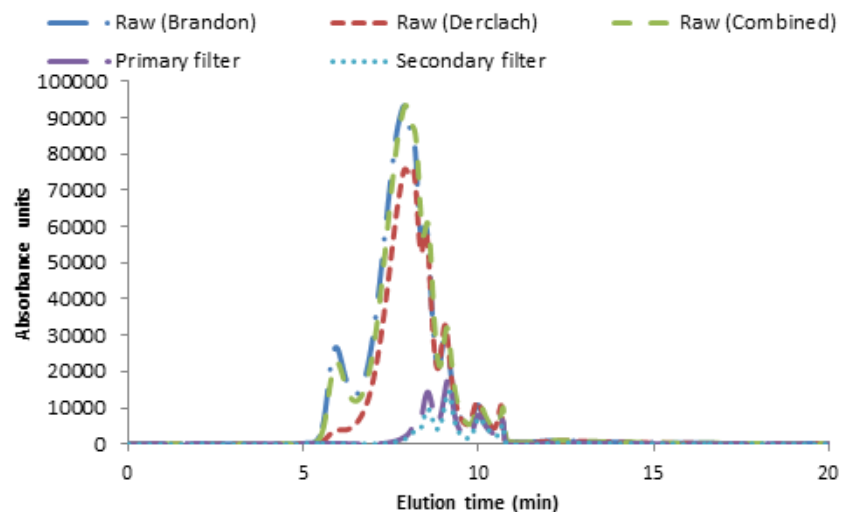

Figure 30 HPSEC for Bradan WTWs, August 2012

As for the bulk water characteristics, the MW distribution of the combined raw water most closely matched the Bradan water source (Figure 30). A small residual of low MW weight UV254 absorbing material was left after coagulation treatment.

The balance of organic material in the raw waters was dominated by transphilic and hydrophilic NOM, accounting for >80% in Bradan and Derclach water sources (Table 19). The combined water appeared to have a much greater fraction of transphilic material in it indicating either a transformation of organic matter in the combined sample or a mistake in the analysis. Regardless of this, it was no surprise to see that coagulation resulted in a high residual of DOC after coagulation due to the high concentration of DOC that is more difficult to coagulate (*i.e.* the TPI and HPI in Figure 31 and Figure 32). However, it was surprising to see that the HPO component of the treated water did not change after coagulation indicating that further optimisation work may be necessary in order to reduce the treated water DOC further.

Table 19: Fractionation data for Bradan WTWs, August 2012

SAMPLE	HPO %	HPI %	HPINA %
Raw (Bradan)	12.8	52.9	34.3
Raw (Derclach)	19.0	33.3	47.6
Raw (Combined)	15.4	77.4	7.1
Primary filter	39.8	27.7	32.5
Secondary filter	39.5	31.5	29.0

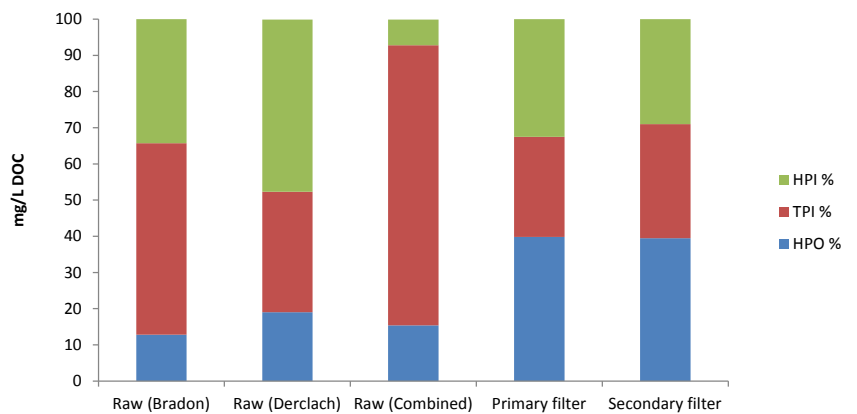

Figure 31 Fractionation on a proportion basis at Bradan WTWs, August 2012

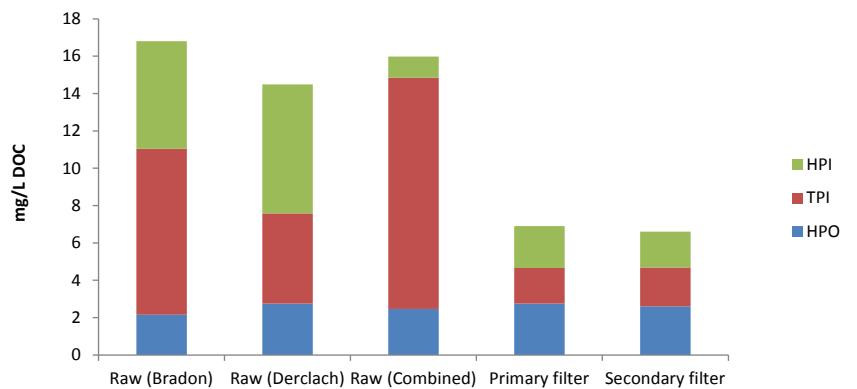

Figure 32 Fractionation on a mass basis at Bradan WTWs, August 2012

All raw waters formed high concentrations of disinfection by-products as seen in Table 20. The reactivity of the DOC was highest in the Bradan water source. After coagulation, the residual DOC was of a slightly lower reactivity (going from 58 to 45-49  $\mu\text{gTHMs.mgDOC}^{-1}$ ), but the high remaining DOC meant that the THMFP concentration was also still high (307-321  $\mu\text{g.l}^{-1}$ ).

*Table 20: DBP formation at Bradan WTWs, August 2012*

SAMPLE	THM-FP ( $\mu\text{gTHMs.mgDOC}^{-1}$ )	THM-FP ( $\mu\text{g.L}^{-1}$ )
Raw (Bradan)	70	1,169
Raw (Derclach)	58	840
Raw (Combined)	58	920
Primary filter	45	307
Secondary filter	49	321

### 3.4.3. Amlaird Water Treatment Works

The WTWs treats a typical flow of 14 MLD, serving a population of 35 000 inhabitants. The flow sheet for the WTWs is shown in Figure 33. The site is a typical coagulation/flocculation, clarification, filtration site with the added addition of an ozonation stage before filtration. The site uses a ferric based chemical as the primary coagulant. The primary disinfectant for the treated water is chlorine due to the regulatory requirement of residual disinfection for the water in distribution.

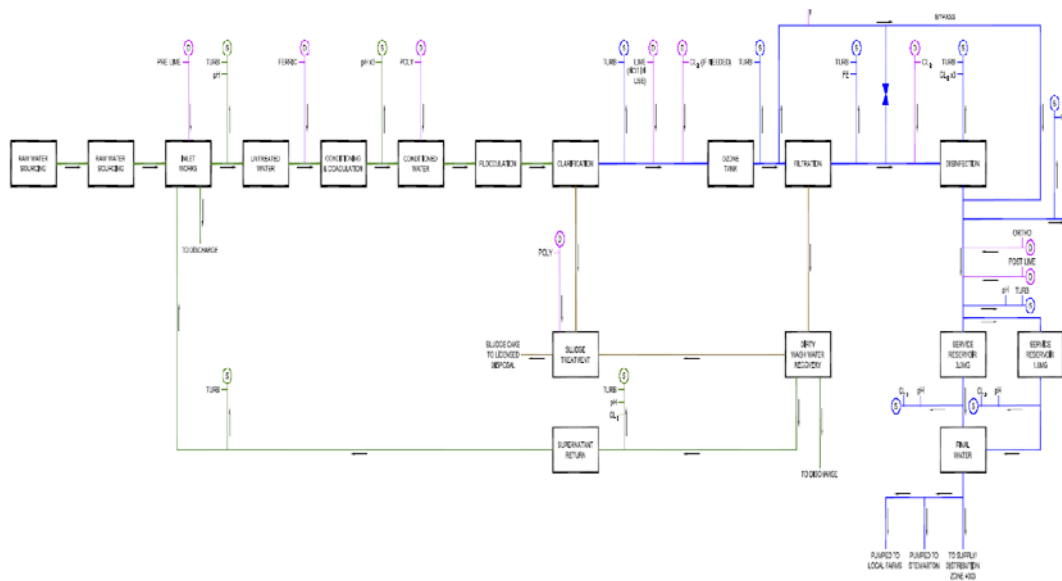

Figure 33 Flowsheet for Amlaird Water Treatment Works

### Results from Amlaird WTWs

The raw water colour ranges between 70 – 300 Hazen, with an average value of 180 Hazen. As expected for a water source of high water colour, the site receives water of high DOC concentration, with values ranging between 10 – 20 mg/l (average – 17 mg/l). The raw water turbidity is between 2 – 15 NTU (with an average of 3NTU).

The treated water is typically between 2 – 10 Hazen (average – 3 Hazen); 1 – 3 mg/l DOC (average – 2.2 mg/l); <0.2 – 0.5 NTU Turbidity (average – <0.2NTU). Compliance with regulatory THM samples is 62.5% (note that the site does employ secondary disinfection in the related distribution system).

Table 21: Water quality data for Amlaird WTWs, August 2012

	UV <sub>254</sub> ABS (cm <sup>-1</sup> )	MEASURED DOC (mg.L <sup>-1</sup> )	ZETA POTENTIAL (mV)	TURBIDITY (NTU)
Raw	0.44	7.2	-15.7	0.64
Clarified	0.05	2.0	-13.7	0.23
Final	0.05	1.7	+1.0	0.48

Further characterisation has been carried out at this site for a single point in time (August 2012). The source waters were of high DOC and UV254 absorbance, indicating that the water sources were dominated by more hydrophobic NOM (Table 21). Both residual UV254 and DOC were acceptable after coagulation.

The charge density for Amlaird raw water was 4.49 meq.gDOC<sup>-1</sup>. The results indicate that the source water was higher than typical with respect to its charge, but coagulation and subsequent treatment was effective at this site. The analysis of the MW distribution of the raw water showed two large peaks at 11 and 15 minutes elution time (Figure 34). A small residual of low MW weight UV254 absorbing material was left after coagulation treatment.

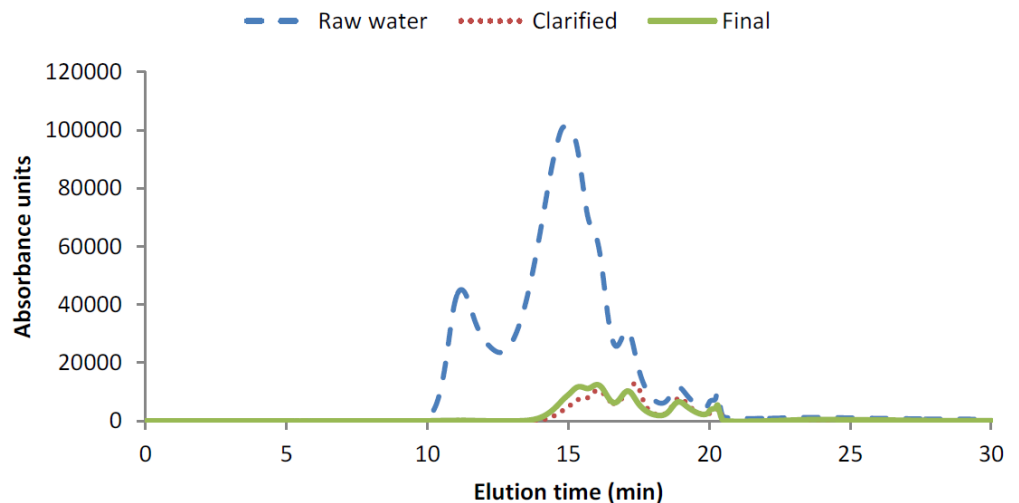

Figure 34 HPSEC for Amlaird WTWs, August 2012

The balance of organic material in the raw waters was dominated by hydrophobic NOM, accounting for 68% (Table 22). After coagulation there was a shift to more transphilic and hydrophilic NOM (Figure 35 and Figure 36).

Table 22: Water quality data for Amlaird WTWs, August 2012

	HPO %	TPI %	HPI %
Raw	68.0	18.1	13.9
Clarified	41.2	30.5	28.3

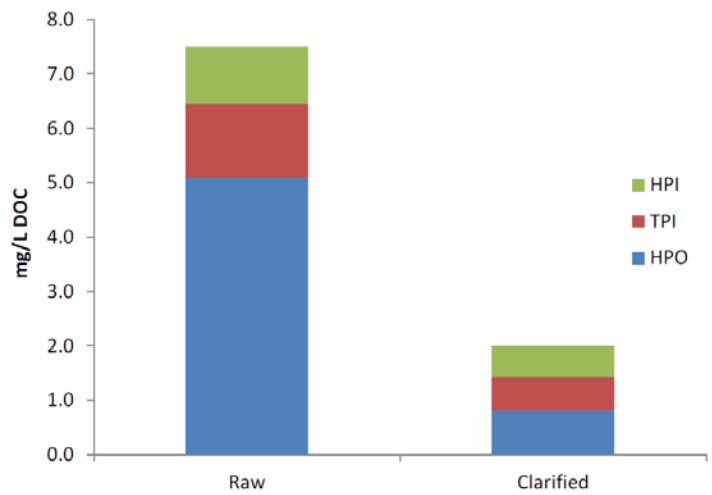

Figure 35 Fractionation on a proportional basis at Amlaird WTWs, August 2012

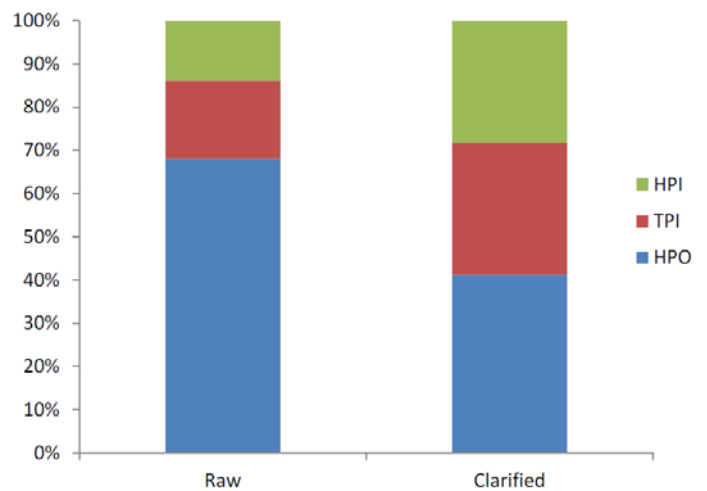

Figure 36 Fractionation on a proportional basis at Amlaird WTWs, August 2012



The raw water formed high concentrations of disinfection by-products with high reactivity (Table 23). The reactivity of the DOC reduced following coagulation, but was still high (going from 130 to 100-107  $\mu\text{gTHMs.mgDOC}^{-1}$ ), meaning that the THMFP concentration was also still quite high (182-200  $\mu\text{g.l}^{-1}$ ).

*Table 23: Water quality data for Amlaird WTWs, August 2012*

SAMPLE	THM-FP ( $\mu\text{g.L}^{-1}.\text{g}^{-1}$ )	THM-FP ( $\mu\text{g.L}^{-1}$ )
Raw	130	974
Clarified	100	200
Final	107	182

### Filter performance status

Further status reporting for the site has been completed by analysis of the performance of the filters at Amlaird. The objective of this work was to take data obtained from Amlaird and assess filter performance based on 'robustness' analysis. The aim of doing this was to try and identify treatment problems on site and determine whether identified problems could be linked to in-coming water quality. Data was available from January 2011 until July 2012. The data was composed of SCADA data logged every 5 minutes for post filtered turbidity and final treated turbidity. Data was plotted in cumulative probability curves, with the percentile plotted on the Y axis against the variable (either filtered turbidity or colour) on the X axis (*e.g.* in Figure 37). The key diagnostic interpretation of these figures can be understood by considering the following questions associated with the curves:

- Is line near vertical around 50th%ile (post filter) - if no, filter not operating robustly
- Is vertical section at low turbidity (sub 0.1 NTU post filter – as defined by Scottish Water) – if no, likely to be upstream chemistry problems. For example, coagulation not optimized
- Does curve have large tail on upper percentiles (post filter) – if yes, backwash may need investigating: frequency, operating procedure, etc.
- Does final water line change compared to filter outlet – if yes, post filter effects: precipitation or aggregation of residual fines

The shallow shape of the curve at Amlaird (Figure 37) indicated that there was a problem with the filter and the large tail observed at the upper percentiles indicated backwashing may need investigating at this site. In addition, the high residual turbidity after filtration of

0.39 NTU (based against an internal SW standard of 0.1 NTU), indicated sub-optimal filter performance. This analysis will be continued at Amlaird and used for the other sites.

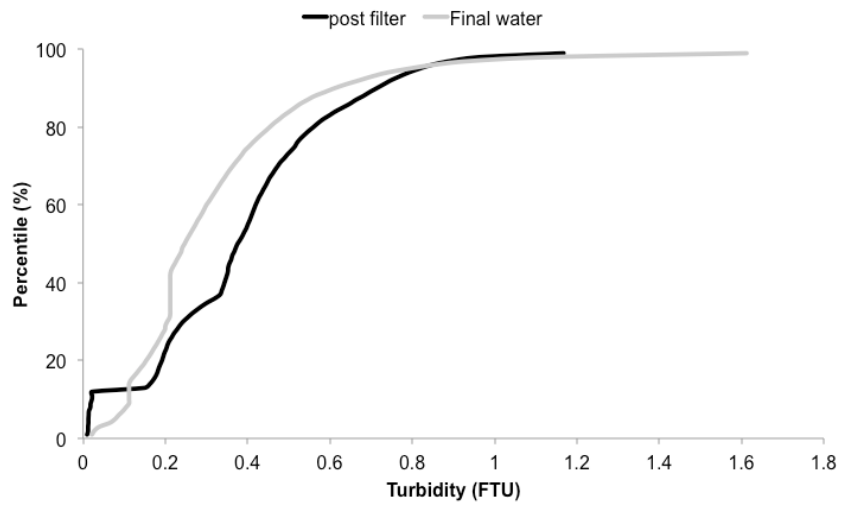

Figure 37 Filter robustness at Amlaird Water Treatment Works

### 3.5. Impact of specific organic components on water treatability

Further control on treatment of water sources containing elevated levels of organic matter can be understood through investigation of how different types of organic matter impact on the prevailing treatment train. It is expected that climate change impacts and land use changes will cause different types of organic compounds to be passed onto the WTWs in the future, so a series of tests was devised to investigate how easily water could be treated using three spike compounds with different physico-chemical characteristics (Table 24). The compounds dosed were representative of hydrophobic (tannic acid) and hydrophilic (oxalic and aspartic acids) organic compounds. The molecules also represented some of the major classes of NOM found in organic laden source waters.

The organic spikes were dosed into Amlaird source water, which, as shown previously, is a relatively high DOC source with predominantly hydrophobic organic compounds present in the water. Preliminary tests on raw water identified the coagulation conditions required in order to give optimum removal of both UV<sub>254</sub> absorbance and DOC from water that did not contain any spiked compounds (Table 25). The coagulant dose required was 20 mg/L as Fe. The MW distribution of UV absorbing organic compounds around this dose range can be seen in Figure 38, showing that coagulation was highly effective in removing these organic materials. Further increases in coagulant dose did not improve NOM removal.

Table 24: Compounds used as spikes

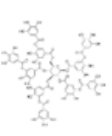
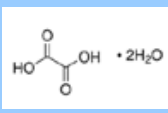
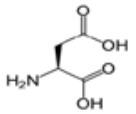
SPIKES	STRUCTURE	CLASSIFICATION	CHEMICAL GROUP	MW (g/mol)	log Kow	WSol (mg/L)	pKa <sub>1</sub> pKb pKa <sub>2</sub>
Tannic acid		Hydrophobic anionic	Phenolic; humic acid	1701.23	13.33	N/A	3.2 N/A 8.7
Oxalic acid dihydrate		Hydrophilic anionic	Carboxylic acid	126.07	-1.74	1,350	1.27 4.27
L(+) Aspartic acid		Hydrophilic anionic	Amino acid	133	-3.89	5,390	1.95 9.66 3.71

N/A=not applicable

Table 25: Optimum treatment of Amlaird water using coagulation

PARAMETERS	RAW WATER	OPTIMUM
pH coagulation	-	4.5
Coagulant dose (mg/L Fe)	-	20.0
UV <sub>254nm</sub>	0.8	0.04
Turbidity (NTU)	2.3±0.4	0.6±0.1
Residual DOC (mg/L)	14.2±0.8	2.3±0.6
SUVA (m <sup>-1</sup> .L.mg <sup>-1</sup> .C)	5.7	1.2

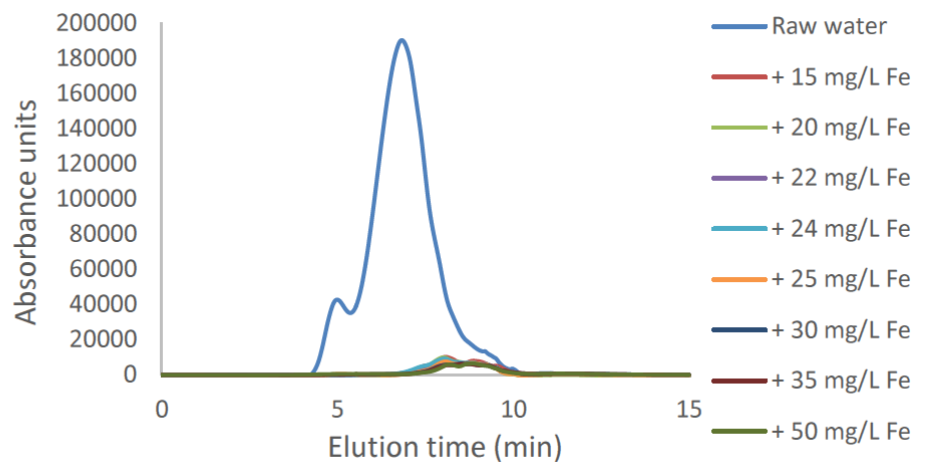

Figure 38 HPSEC for the raw and treated waters with increasing coagulant dose

The effect of adding increasing the concentration of organic spike on total residual DOC for the same coagulant dose of 20 mg/L as Fe was quite different for the three compounds investigated (Figure 39 and Figure 40). The residual DOC of the treated water remained around 2.5 mg/L when up to an extra 4 mg/L of DOC was added to water from tannic acid. Even with up to 7 mg/L of additional DOC in the water, the treated water residual remained below 5mg/L showing that this type of organic compound remained easy to remove from the water and that the added coagulant had capacity to remove more of this organic material.

For oxalic acid, the addition of this compound into the water caused a significant increase in the residual DOC of the treated water. The rate of increase in the residual DOC rose rapidly above a spike addition of 5 mg/L DOC. When investigated on the HPSEC trace (Figure 41), it was clear that a large portion of high MW material, eluting around 5 minutes was not removed. For all of the other treated waters, this MW range of organics was well removed. For aspartic acid, initially there was a sharp increase in the residual DOC of the treated water after 1 mg/L of aspartic acid was added to the water, but this increase then slowed as further addition of the spike chemical was added to the water.

These experiments clearly show that should a WTWs receive water from a source that can change rapidly, the characteristics of the organic materials that are contained in the water are critical in determining how effectively the water could be treated without adjusting the coagulant dose, with spikes of hydrophilic material likely to cause the biggest issue.

The response that a WTWs can make to such an increase in DOC through an increase in coagulant dose was very different as a result of differences in the ease which these spike materials can be coagulated (Figure 42). For tannic acid, only a moderate increase of 1-3 mg/L Fe was needed in order to match the residual DOC of 2.5-3.0 mg/L achieved when the unspiked water was treated. For aspartic and oxalic acids, it took an extra 10 and 15 mg/L as Fe respectively before the residual DOC in the treated water stabilised. However, in these cases the treated water DOC was more than double that seen for the unspiked source water at 6mg/L DOC.

The high DOC residual left behind following the addition of the spikes therefore has potential to react with chlorine to form disinfection by-products (DBPs). Tests were therefore carried out to determine the DBP formation potential of waters containing oxalic and tannic acids (data for aspartic acid did not produce reliable results) (Figure 43). For oxalic acid, the DBP-FP of the water at a dose of 20 mg/L as Fe remained close to that of the raw water (550—650 µg/L). For tannic acid, the DBPs were reduced to well below 100 µg/L at an Fe dose of 25 mg/L as Fe, whilst for oxalic acid the THM-FP was above 200 µg/L for a similar coagulant dose. A further 10 mg/L as Fe addition of coagulant only reduced the THM-FP to just above 100 µg/L.

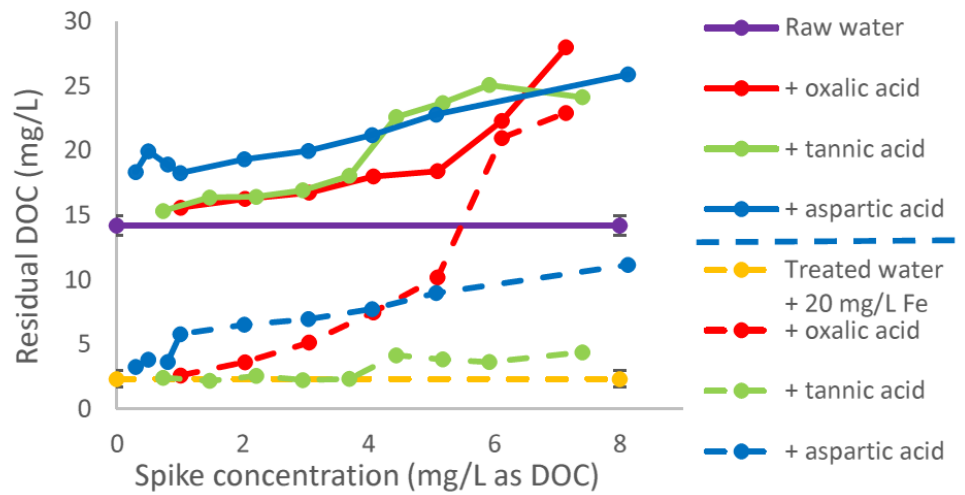

Figure 39 Residual DOC of Amlaird raw water and treated water with 20 mg/L of ferric sulphate as Fe after addition of different concentrations of spikes

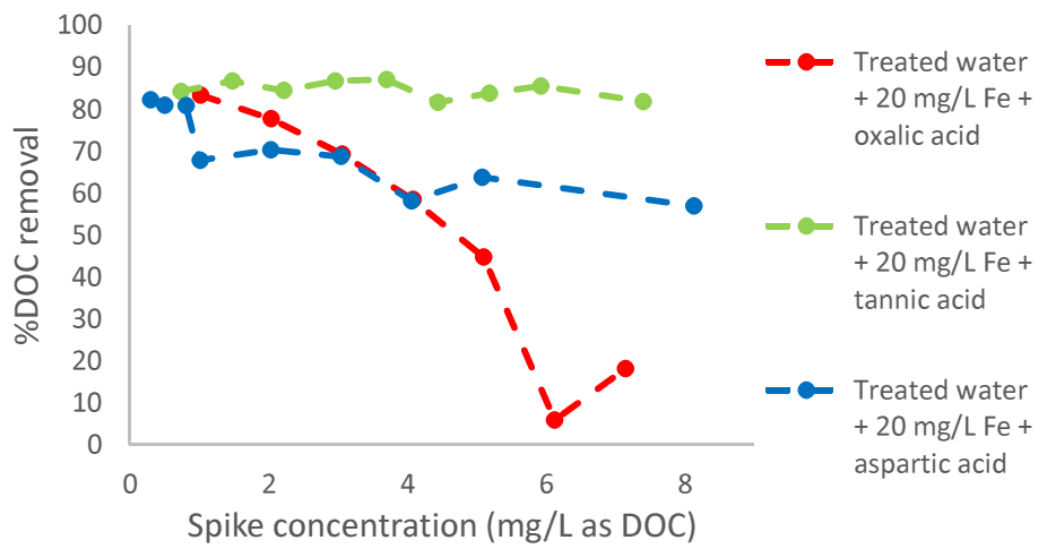

Figure 40 Percent DOC removal from Amlaird raw water after addition of spikes and treatment with 20 mg/L of ferric sulphate as Fe

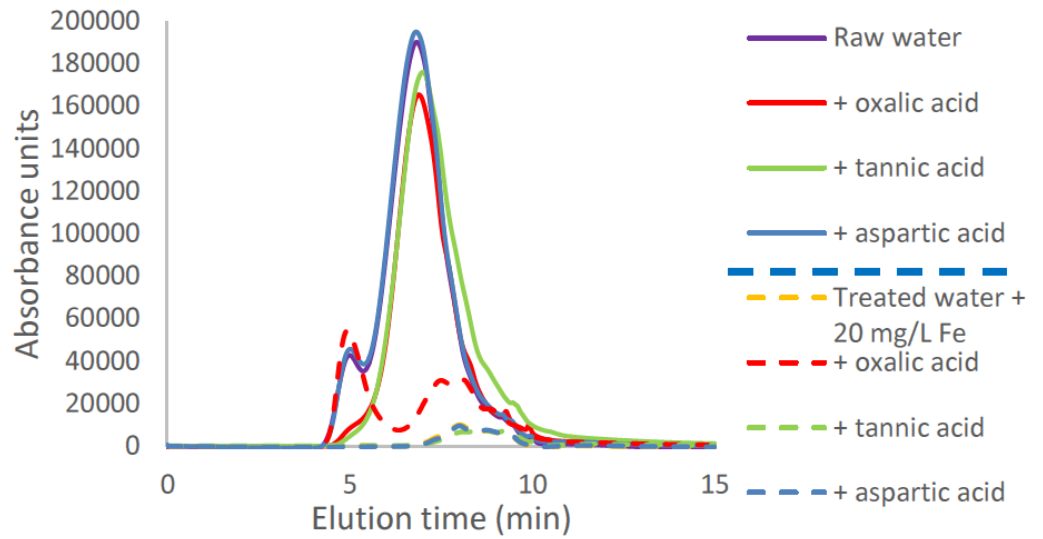

Figure 41 HPSEC for treatment of Amlaird Water addition of 5 mg/L DOC spikes and treatment with 20 mg/L of ferric sulphate as Fe

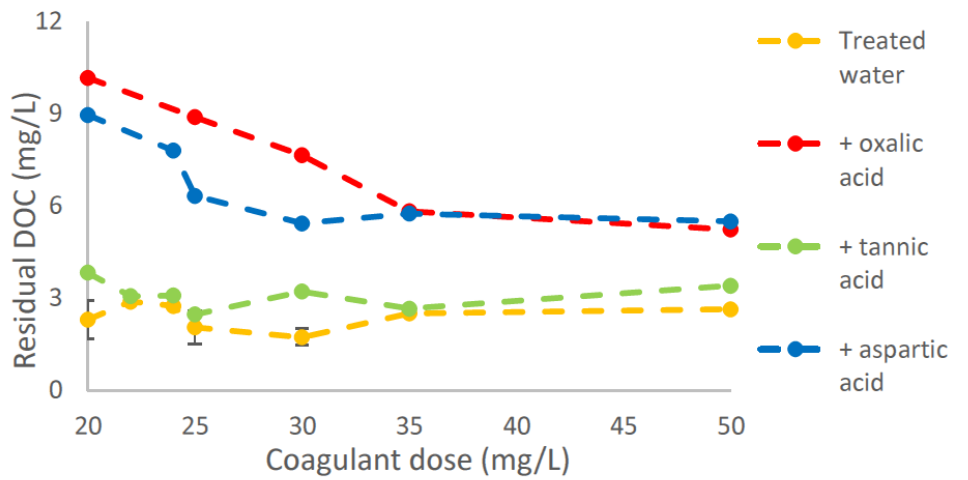

Figure 42 Optimisation of coagulation after addition of 5 mg/L of spikes in Amlaird raw water samples

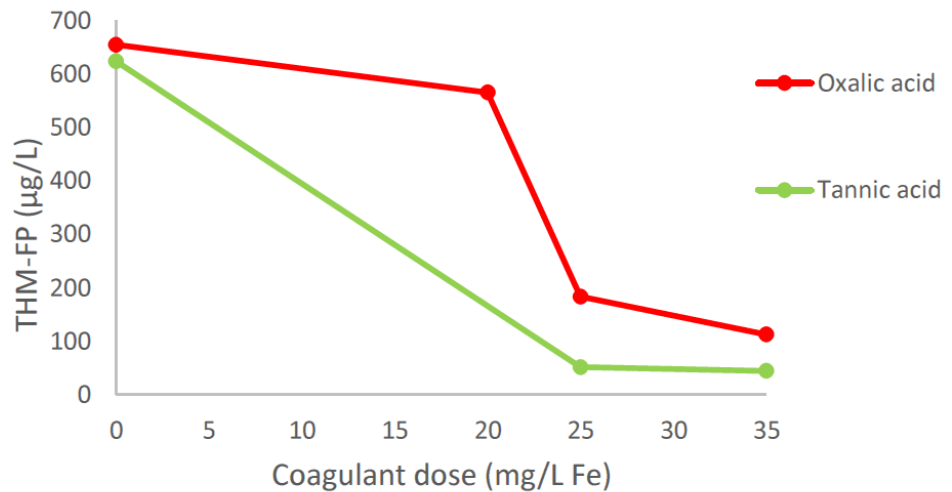

Figure 43 Change in THM-FP for treated water spiked oxalic acid and tannic acid

Further impacts that increased DOC in source waters may have on drinking water treatment is on the floc characteristics. In turn this will then impact on the efficiency by which the particles are removed from the water in clarification and filtration systems. The size and strength of flocs was therefore measured for water containing a 5 mg/L spike of the model organic compound for an Fe dose of 20 mg/L (Figure 44 and Figure 45) and a dose of 25 mg/L (Figure 46 and Figure 47). This was then compared to the strength of flocs formed from just the spiked compound (Figure 48). Flocs formed in only the raw water reached a median size of 350 µm at 20 mg/L as Fe and 200 µm at 25 mg/L as Fe. The presence of tannic acid in the water resulted in larger flocs, increasing the average floc size by 50 µm for both coagulant doses.

The presence of oxalic acid caused slower growing flocs that reached a similar size to the unspiked water. For aspartic acid, smaller flocs were formed that had a median diameter of 150 µm at 20 and 25 mg/L as Fe. Of interest, when the spikes were coagulated on their own, only the tannic and aspartic acids formed a viable floc when Fe coagulant was dosed in. This appeared to be the cause of the much slower floc growth observed when the oxalic acid was spiked into the raw water as it reduced the interaction of the coagulant with the other DOC present in the water.

Although floc breakage profiles were quite similar for the different spiked waters it was clear that aspartic acid resulted in smaller flocs that broke to consistently smaller sizes for comparable mixing intensities than when compared to the other organic spikes (Figures 48 and 50). Indeed, when the flocs formed from a pure aspartic acid solution were compared with the pure tannic acid solution, there was a very large difference in floc sizes for each of the breakage rpm.



The results from the floc profiling work shows that firstly flocs formed in the presence of compounds similar to aspartic acid are likely to be smaller and break to smaller sizes on exposure to high shear rates. The presence of tannic acid on the other hand forms flocs that are larger and hence could be better removed from clarification units than for other types of organic compound that may dominate a water source. Secondly, the presence of organic materials similar to oxalic acid will slow the growth of flocs such that if inadequate flocculation time is given in these types of water a poor floc might be formed.

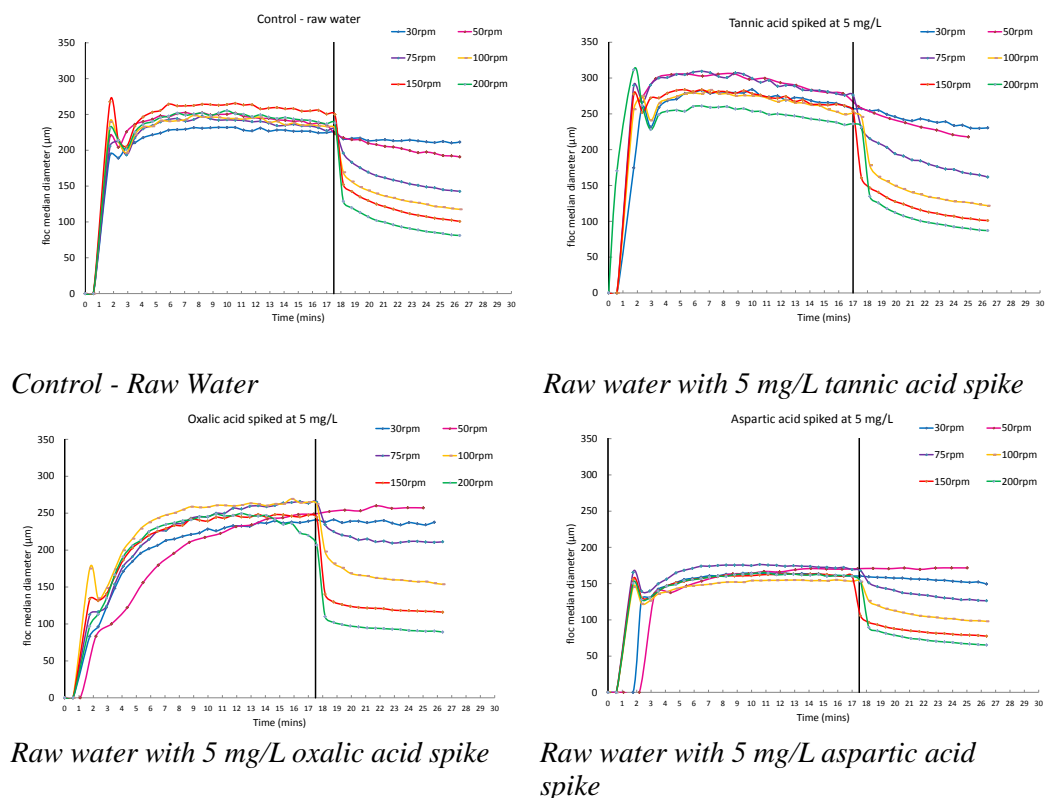

Figure 44 Floc breakage profiles for raw water with organic spikes coagulated using 20 mg/L as Fe coagulant

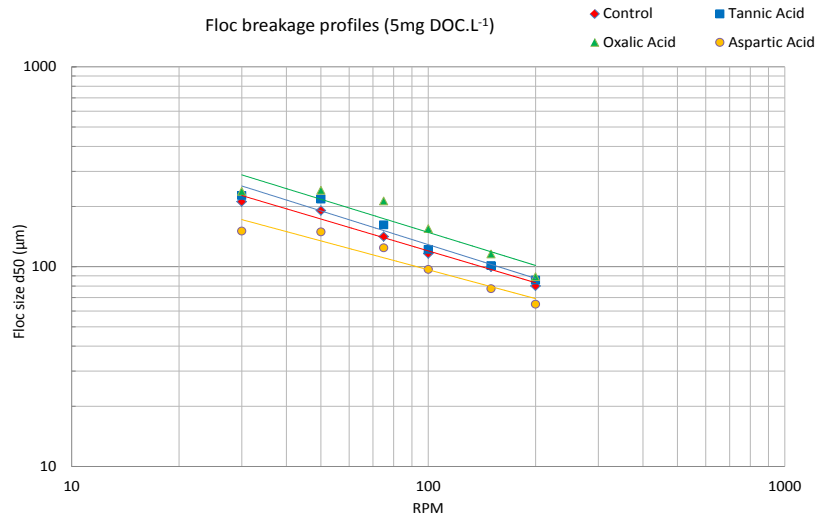
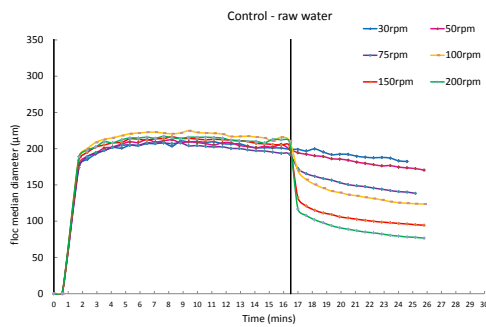
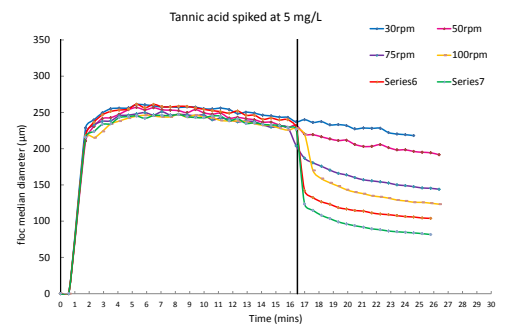

Figure 45 Floc strength profiles for raw water with organic spikes coagulated using 20 mg/L as Fe coagulant



Control - Raw Water



Raw water with 5 mg/L tannic acid spike

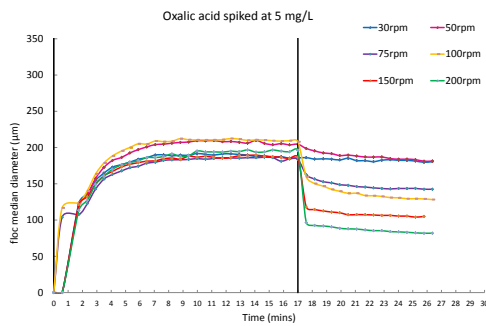

Raw water with 5 mg/L oxalic acid spike

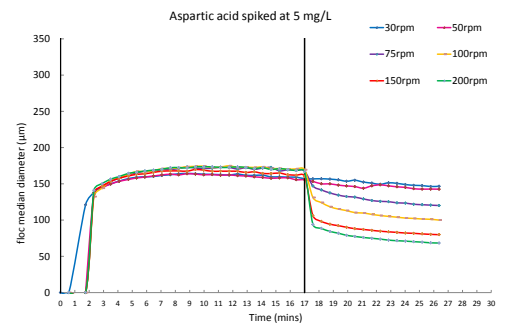

Raw water with 5 mg/L aspartic acid spike

Figure 46 Floc breakage profiles for raw water with organic spikes coagulated using 25 mg/L as Fe coagulant

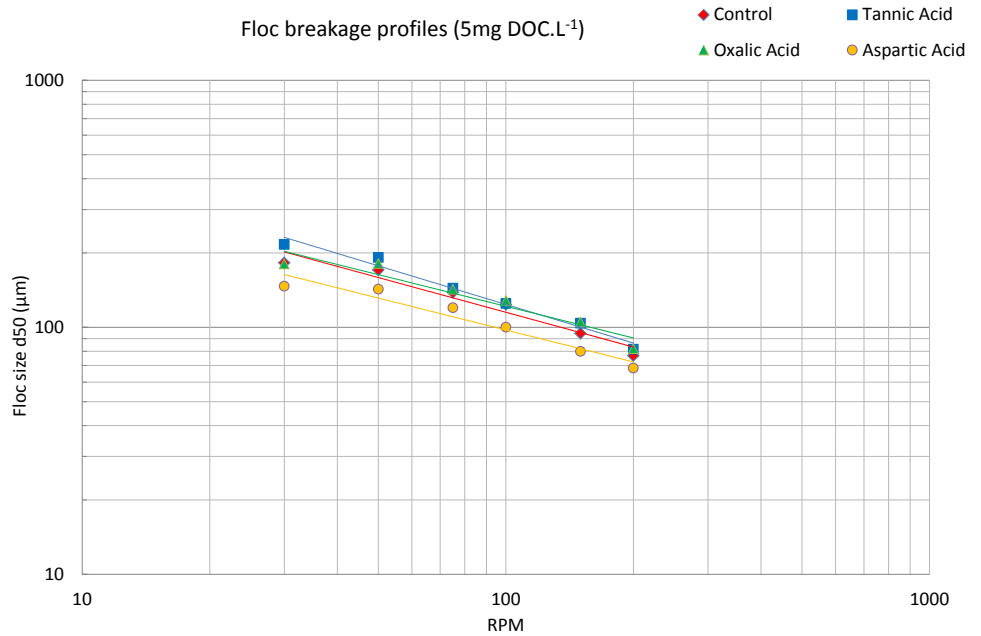

Figure 47 Floc strength profiles for raw water with organic spikes coagulated using 25 mg/L as Fe coagulant

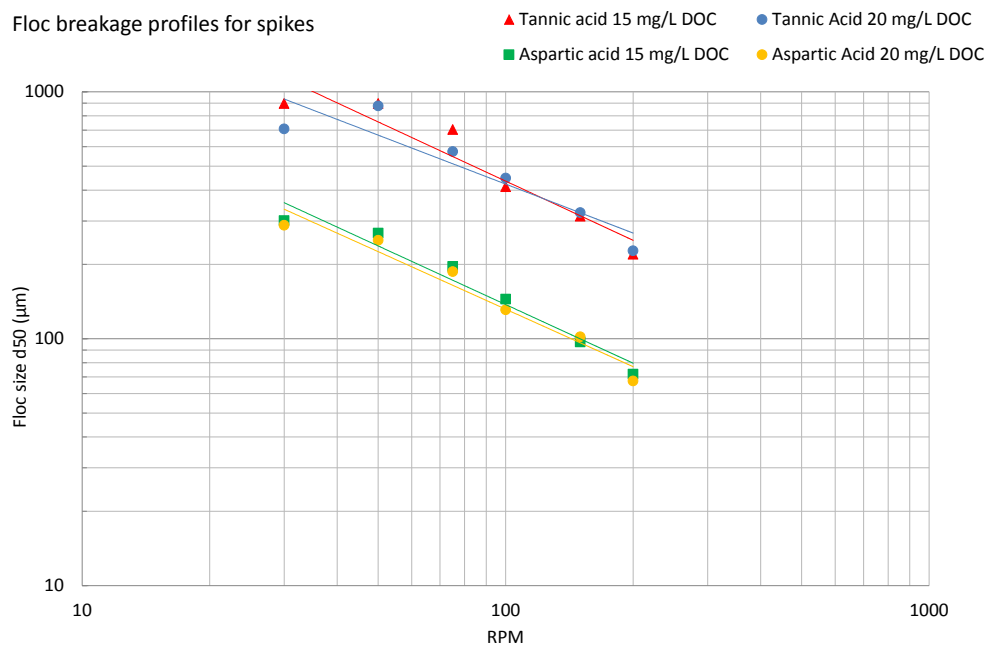

Figure 48 Floc strength profiles for organic spikes at 15 and 20 mg/L DOC respectively, both using 20 mg/L as Fe coagulant. Note that oxalic acid did not produce a floc, so was not included in the figure

Although there are limitations in looking at individual compounds as spiking agents, for example the fact that a spike of NOM seen in a real water source is very unlikely to have been caused by a single molecule, the objective of this work was to show how different types of organic matter might influence water treatability and hence how the source water might be better controlled in order to prevent such spikes hitting the WTWs.

For the hydrophilic compounds, oxalic acid is a small carboxylic acid, whilst aspartic acid is an amino acid hence they are highly relevant to the types of small organic molecule that might be present in a real water source. In reality, a flush through of this type of material onto a conventional coagulation plant would mean that residual DOC would increase, because the materials cannot be coagulated, and THMs would also increase (as shown here). In addition, floc properties would deteriorate.

For a flush through of hydrophobic material, such as tannic acid, it has been shown that so long as an adequate coagulant dose is applied to match the increase in DOC load, the same level of treatment can be maintained. Understanding the nature of DOC spikes is therefore crucial in determining how well a water treatment works might cope. These spikes are expected to increase as a result of climate change. When spikes are experienced, minimum best operational practice should be to determine the balance of hydrophobicity and hydrophilicity of the organics materials present. This may then enable more appropriate selection of a water source that can be more easily treated, the slowing of treatment rates and the appropriate coagulant dose applied to minimise the impact of the DOC load for DBP control and solid-liquid separation processes.

## 4. CONCLUSIONS

This report summarizes activities in TRUST WP4 addressing optimization of operation performance with respect to safety, environmental impacts and cost-efficiency.

Optimization of water treatment plant and distribution system has to rely on selected optimization criteria that are site and system specific in order to cope with challenges posed by *e.g.* stringent regulations, consumer feedback, climate change, *etc.* Comprehensive knowledge of the specific characteristics, limitations and challenges of a water supply system is required in order to define available alternatives and to design and perform full-scale optimization studies and trials.

The proposed optimization framework includes:

- Mapping operational performance status that includes initial performance evaluation and comparison to model predictions.
- Utilizing diagnostic tools, *e.g.* for water quality characterization that also helps identification of variations in the performance.
- Utilizing curative tools that includes performing experiments and trials without compromising the water quality produced.
- Utilizing decision support systems to highlight some other aspects *e.g.* economic and environmental issues that are not covered by the diagnostic and curative tools.
- Identifying performance optimization potentials and possible benefits.
- Implementing selected operation conditions based on overall assessments of potential advantages and disadvantages for both treatment and distribution systems.

The proposed framework has been implemented fully in the case studies in Norway and the Netherlands, while for case studies in Scotland only the technical aspect was evaluated.

Improvement of the proposed framework could include governance and asset dimensions as defined in the TRUST Master Framework for UWCS Sustainability (Deliverable 31.1).

## References

- Deliverable D31.1. (2012). A Master Framework for UWCS Sustainability. [www.trust-i.net](http://www.trust-i.net) – info@trust-i.net.
- Barrios, R., Siebel, M., van der Helm, A., Bosklopper, K., Gijzen, H. (2008). Environmental and financial life cycle impact assessment of drinking water production at Waternet. *Journal of Cleaner Production* 16, 471-476.
- Chow, C. W. K., Fabris, R. and Drikas, M. (2004). A rapid fractionation technique to characterise natural organic matter for the optimisation of water treatment processes. *Journal of Water Supply: Research and Technology—AQUA* | 53.2 | 2004
- Klaversma, E., van der Helm, A. W. C. and Kappelhof, J. W. N. M. (2013). The use of life cycle assessment for evaluating the sustainability of the Amsterdam water cycle, *Journal of Water and Climate Change* Vol 4 No 2 pp 103–109 © IWA Publishing, doi:10.2166/wcc.2013.007
- Eikebrokk, B., Juhna, T., Melin, E. and Osterhus, S.W. (2007). Water treatment by enhanced coagulation and ozonation-biofiltration. *Techneau-Report D5.3.2A*, Dec. [www.techneau.eu](http://www.techneau.eu)
- Eikebrokk, B. (2009). Water treatment: optimization with respect to what? *TECHNEAU: Safe Drinking Water from Source to Tap, State of art & Perspectives*, Editors: Theo van den Hoven and Christian Kazner, IWA publishing, 69-82 (Book, ISBN: 9781843392750)
- Grefte, A., Dignum, M., Baghoth, S.A., Cornelissen, E. R., Rietveld, L.C. (2011). Improving the biological stability of drinking water by ion exchange, *Water science & Technology: Water supply*, 11.1, 107-112.
- Grefte, A., Dignum, M., Cornelissen, E. R., Rietveld, L.C. (2013). Natural organic matter removal by ion exchange at different positions in the drinking water treatment lane, *Drink. Water Eng. Sci.*, 6, 1–10, 2013.
- Hammes, F., Boon, N., Vital, M., Ross, P., Magic-Knezev, A. and Dignum, M. (2011) Bacterial colonization of pellet softening reactors used during drinking water treatment. *Applied and Environmental Microbiology* 77(3), 1041-1048.
- Hofman, J., Kramer, O., van der Hoek, J.P., Nederlof, M. and Groenendijk, M. (2007), Twenty years of experience with central softening in The Netherlands: Water quality – Environmental benefits – Costs. *Water21*, (July), 21 –24.
- Hofs, B., Schetters, M.J.A., Baars, E.T. (2014). *Ontharden met Hollands calciet*, KWR.
- Joint Research Centre, European Commission & Institute for Environment and Sustainability (2010). *International Reference Life Cycle Data System (ILCD) Handbook - Specific guide for Life Cycle Inventory data sets*. Available at: <http://lct.jrc.ec.europa.eu/pdf-directory/ILCD-Handbook-Specific-guide-for-LCI-online-12March2010.pdf>
- Kramer, O. (2012). Business case “light” CO<sub>2</sub>, internal Waternet memo, September 2012.

- Li, B.-H. and Chang, C.-T. (2011). Multiobjective Optimization of Water-Using Networks with Multiple Contaminants. *Industrial & Engineering Chemistry Research* 50(9), 5651-5660.
- Palmen, L., W. Oorthuizen, H. Koppers and Hofs, B. (2012). Calciet als alternatief entmateriaal bij ontharding produceert hoogwaardige kalkkorrel. *H2O magazine*, 45(10), 35-37.
- Pawłowski, A. (2008) How many dimensions does sustainable development have? *Sustainable Development* 16(2), 81-90.
- Personal communications Waternet: M. Dignum, E. Baars, A. van der Helm, R. van der Aa, S. Willemse.
- Quental, N., Lourenço, J.M. and da Silva, F.N. (2011) Sustainability: Characteristics and scientific roots. *Environment, Development and Sustainability* 13(2), 257-276.
- Raluy, G., Serra, L., Uche, J., Valero, A. (2005). Life Cycle Assessment of Water Production Technologies - Part 2: Reverse Osmosis Desalination versus the Ebro River Water Transfer. *The International Journal of Life Cycle Assessment* 10, 346-354.
- Ramiro Barrios, Maarten Siebel, Alex van der Helm, Karin Bosklopper, Huub Gijzen (2008). "Environmental and financial life cycle impact assessment of drinking water production at Waternet", *Journal of Cleaner Production* 16, p. 471-476
- Ramos, J.S. and Ramos, H.M. (2010) Multi-criterion optimization of energy management in drinking systems, pp. 129-144.
- Schettters, M.J.A. (2013). Grinded Dutch calcite as seeding material in the pellet softening process, Waternet and TU Delft.
- Stokes, J., Horvath, A. (2006). Life Cycle Energy Assessment of Alternative Water Supply Systems. *The International Journal of Life Cycle Assessment* 11, 335-343.
- Tapia, M., Siebel, M.A., van der Helm, A.W.C., Baars, E.T., Gijzen, H.J. (2008). Environmental, financial and quality assessment of drinking water processes at Waternet. *Journal of Cleaner Production*, 16, 401-409.
- Van der Helm, A. (2009). Overzicht aanpassingen ozonisatie Weesperkarspel en Leiduin, internal Waternet memo.
- Van der Hoek (2011). Energy from the water cycle: a promising combination to operate climate neutral, *Water Practice & Technology* 6 (2).
- van Leenen, M. (2005). Invloed van verwijdering van organische stof op ozonisatie, final thesis.
- Venkatesh, G., Azrague, K., Bell, S., Eikebrokk, B. (2015). Triple bottom line assessment of raw water treatment: Methodology and application to a case study in the municipality of Oppegård in south-eastern Norway. *Environmental Technology* 18, p. 1-12.
- Vince, F., Aoustin, E., Bréant, P., Marechal, F. (2008). LCA tool for the environmental evaluation of potable water production. *Desalination* 220, 37-56.

Volk, C., Bell, K., Ibrahim, E., Verges, D., Amy, G., LeChevallier, M. (2000). Impact of enhanced and optimized coagulation on removal of organic matter and its biodegradable fraction in drinking water, *Water Research*, Volume 34, Issue 12, Pages 3247–3257.

Waternet Watercycle Plan,

<https://www.waternet.nl/media/88275/waternetwatercyclusplan.pdf>

Wols, B.A., Hofman, J.A.M.H., Uijttewaal, W.S.J., Rietveld, L.C., Stelling, G.S., van Dijk, J.C. (2008). A particle tracking technique to estimate disinfection efficacy in drinking water treatment plants, proceedings 6th International Conference on CFD in Oil&Gas, Metallurgical and Process Industries, SINTEF/NTNU, Trondheim Norway (10-12 June 2009).





trust

TRANSITIONS TO THE URBAN WATER SERVICES OF TOMORROW

Optimization procedures and benefits for sustainable water supply systems of tomorrow  
**D 41.2**

© TRUST 2015

The research leading to these results has received funding from the European Union Seventh Framework Programme (FP7/2007-2013) under grant agreement n° 265122.

This publication reflects only the author's views and the European Union is not liable for any use that may be made of the information contained therein.

