

Integrating top-down and bottom-up approaches to design a cost-effective and equitable programme of measures for adaptation of a river basin to global change

Ph.D. Thesis
November 2015

Corentin Girard

Advisers:
Manuel Pulido-Velázquez
Jean-Daniel Rinaudo



UNIVERSITAT
POLITÈCNICA
DE VALÈNCIA



Programa de Doctorado en Ingeniería del Agua y Medioambiental

Integrating top-down and bottom-up approaches to design a cost-effective and equitable programme of measures for adaptation of a river basin to global change

PhD Thesis

Author: Corentin Girard

Advisers: Manuel Pulido-Velázquez

Jean-Daniel Rinaudo

This PhD thesis has been developed under a joint doctorate supervision agreement with the Centre international d'études supérieures en sciences agronomiques (SupAgro Montpellier, France).

December 2015

A celles qui sont parties,

A ceux qui sont arrivés,

A ceux qui ont été là.

Acknowledgements

The preparation of this thesis has taken me on a journey that has led me across geographical, disciplinary, linguistic and cultural borders. Along the way, I have had the good fortune of being able to count on the support of many people, without whom this experience would not have been so fruitful. I am grateful to them all.

In particular, I thank those who agreed to show me the route: my advisors, Manuel Augusto Pulido Velázquez and Jean-Daniel Rinaudo, for the trust they have placed in me from the outset of this PhD, and for their complementary support throughout these years. Their interest and dedication to our work gave me the opportunity to participate in stimulating scientific cooperation and inspiring discussions.

Manuel, gracias por la acogida en tu grupo de investigación y por haberme introducido al mundo de los modelos hidro-económicos, de GAMS, y de las “catalinas con queso”. Tu fe en este trabajo y tu experiencia han sido determinantes para llegar a este resultado.

Jean-Daniel, merci pour avoir partagé ton expérience d'économiste ancré dans la réalité du terrain, et pour avoir pris le temps de trouver les mots et les moyens pour mener ce projet à son terme. Sans ta motivation et créativité, cette thèse ne serait pas ce qu'elle est.

I also thank the members of the steering committee of this PhD: Joaquin Andreu, Frédéric Grelot, and I am especially grateful to Yvan Caballero, for his valuable advice, which extended beyond academic recommendations. I thank as well the reviewers of this manuscript: Brian H. Hurd and Josué Medellín-Azuara for their positive feedbacks; and the members of the thesis jury, Jay R. Lund, María A. Máñez Costa and Luis Garrote de Marcos for their interest and stimulating comments. I am really grateful to James Hunt,

who carefully reviewed the entire manuscript and made sure that it was properly written.

Merci à Laurent Rippert et à son équipe du Syndicat Mixte de la vallée de l'Orb pour leur intérêt et disponibilité au long de cette thèse. Je remercie aussi tous les acteurs du bassin versant de l'Orb qui ont participé à un moment ou à un autre à l'une des phases qui ont permis le développement de cette thèse. Je remercie aussi personnellement Christian Pagé, Sébastien Chazot, Edith Vier et Fabien Aigoui, pour leur aide dans l'obtention d'une partie des données nécessaires à l'élaboration de cette thèse, ainsi que pour leurs disponibilités et commentaires sur les développements réalisés.

I am also grateful to the organizations that supported the PhD. On the Spanish side, the Spanish ministry of Education Sport and Culture, for the FPU grant that financed my research, and the Instituto de Ingeniería del Agua y Medio Ambiente (IIAMA) of the UPV. On the French side, the BRGM (thanks to Marc Audibert et Jean-Christophe Maréchal), and the people and organizations that co-founded the various research projects that accompanied this PhD, the Région Languedoc-Rousillon, the Conseil Général de l'Hérault, the Agence de l'Eau Rhône-Méditerranée-Corse and the Office National de l'Eau et des Milieux Aquatiques (ONEMA).

A los compañeros del Departamento de Ingeniería Hidráulica y Medio Ambiente, desde Cesar que fue el primero, hasta Patricia y Dani que han sido los últimos en llegar, y por supuesto a todos los del Norte o del Sur de la pecera con quien sigo nadando: a Antonio por los primeros pasos en GAMS, a Héctor por haber aumentado mi vocabulario, a Andrea, María, Edgar, Néstor, Jesús, Jessica y Adrián, sigue siendo un placer. Agradezco también la disponibilidad y ayuda en todos los procesos administrativos al equipo de secretaria del departamento Merche, Javier, y Rosa, sin olvidar a Menchu por su ayuda cotidiana.

A l'ensemble des collègues et stagiaires de l'équipe du BRGM à Montpellier pour leur accueil toujours chaleureux et leur disponibilité. En particulier, merci à ceux avec qui j'ai eu la chance de collaborer : Laure, Tommy, Dominique, Céline, Marine, Nina, Sandra, Jean-François, sans oublier Franck. Merci aussi à Marielle Montginoul, pour sa disponibilité et pour la coordination avec l'EDEG. A Anne-Gaëlle, pour y être passée avant moi et pour les conseils de dernières minutes.

Aux amis qui m'ont rendu visite et à qui j'ai rendu visite durant ces années pour m'avoir changé les idées.

Als meus veïns i amics del barri viu del Cabanyal, per haver-me acollit al seu barri i haver-me fet sentir-me ací com al meu poble.

A los amigos y familia de adopción de Godella, por el cariño. I especialment a Claudia per la seua ajuda amb el resum en valencià.

Merci à ma famille, et en particulier à celles qui nous ont quittés, pour m'avoir transmis leur curiosité et bien plus. A ceux qui sont arrivés, pour leurs sourires. A ceux qui ont été là, mes parents pour m'avoir donné le goût des ascensions difficiles, et pour leur soutien et compréhension au-delà de la distance. A Martin et Valentin pour m'avoir appris à marcher et le reste, à Anaïs et Aurore pour les bons moments passés ensemble. A toute la famille d'Escolives Sainte Camille et d'ailleurs, et en particulier à Lucile, pour la solidarité entre doctorants.

Y por supuesto, le doy las gracias a Mar, que es gracias a quien he empezado y sin quien no sé dónde habría acabado esta aventura. Hemos avanzado juntos por los valles y por las cumbres de este camino que ahora acabamos, pero seguiremos caminando, se hace camino al andar.

Finally, thanks to those who will read this thesis, for their interest in the research.

Abstract

Adaptation to the multiple facets of global change challenges the conventional means of sustainably planning and managing water resources at the river basin scale. Numerous demand or supply management options are available, from which adaptation measures need to be selected in a context of high uncertainty of future conditions. Given the interdependency of water users, agreements need to be found at the local level to implement the most effective adaptation measures. Therefore, this thesis develops an approach combining economics and water resources engineering to select a cost-effective programme of adaptation measures in the context of climate change uncertainty, and to define an equitable allocation of the cost of the adaptation plan between the stakeholders involved.

A framework is developed to integrate inputs from the two main approaches commonly used to plan for adaptation. The first, referred to as “top-down”, consists of a modelling chain going from global greenhouse gases emission scenarios to local hydrological models used to assess the impact of climate change on water resources. Conversely, the second approach, called “bottom-up”, starts from assessing vulnerability at the local level to then identify adaptation measures used to face an uncertain future. The methodological framework presented in this thesis relies on a combination of these two approaches to support the selection of adaptation measures at the local level.

Outcomes from these two approaches are integrated to select a cost-effective combination of adaptation measures through a least-cost optimization model developed at the river basin scale. The model is then used to investigate the trade-offs between different planning objectives defined in terms of environmental flow requirements, irrigated agriculture development, and the cost of the programme of measures. The

performances of a programme of measures are finally assessed under different climate projections to identify robust and least-regret adaptation measures.

The issue of allocating the cost of the adaptation plan is considered through two complementary perspectives. The outcome of a negotiation process between the stakeholders is modelled through the implementation of cooperative game theory to define cost allocation scenarios. These results are compared with cost allocation rules based on social justice principles to provide contrasted insights into a negotiation process.

This innovative framework has been applied in a Mediterranean case study in the Orb River basin (France). Mid-term climate projections, downscaled from 9 General Climate Models, are used to assess the uncertainty associated with climate projections. Demand evolution scenarios have been developed to project agricultural and urban water demands on the 2030 time horizon. The least-cost river basin optimization model developed in GAMS allows the cost-effective selection of a programme of measures from a catalogue of 462 supply and demand management measures ranging from infrastructure development to household water saving and improvements in irrigation efficiency. Nine cost allocation scenarios based on different social justice principles have been discussed through face-to-face semi-structured interviews with 15 key informants and compared with solution concepts from cooperative game theory for a 3-player game defined at the river basin scale.

The interdisciplinary framework developed in this thesis combines economics and water resources engineering methods, establishing a promising means of bridging the gap between bottom-up and top-down approaches and supporting the creation of cost-effective and equitable adaptation plans at the local level.

Resumen

La adaptación a los múltiples aspectos del cambio global supone un reto para los enfoques convencionales de planificación y gestión sostenible de los recursos hídricos a escala de cuenca. Numerosas opciones de gestión de la demanda o de la oferta están disponibles, de entre las cuales es necesario seleccionar medidas de adaptación en un contexto de elevada incertidumbre sobre las condiciones futuras. Dadas las interdependencias existentes entre los usuarios del agua a nivel local, hace falta buscar acuerdos a escala de cuenca para implementar las medidas de adaptación más eficaces. Por este motivo, esta tesis desarrolla una metodología que, combinando economía e ingeniería de los recursos hídricos, busca seleccionar un programa de medidas coste-eficaz frente a las incertidumbres del cambio climático, y asimismo definir un reparto justo del coste de la adaptación entre los actores implicados.

El marco metodológico ha sido desarrollado para integrar contribuciones de los dos principales enfoques utilizados para la planificación de la adaptación. El primero, denominado descendente (“top-down”), consiste en una cadena de modelación que va desde los escenarios de emisiones de gases efecto invernadero a nivel global hasta los modelos hidrológicos utilizados a nivel local para evaluar así el impacto del cambio climático sobre los recursos hídricos. Por el contrario, el segundo enfoque denominado ascendente (“bottom-up”) empieza por evaluar la vulnerabilidad del sistema a nivel local para después identificar medidas de adaptación frente a un futuro incierto. El marco metodológico presentado en esta tesis se basa en una combinación de estos dos enfoques para facilitar la selección de medidas de adaptación a nivel local.

Los resultados de los métodos mencionados previamente se han integrado con el fin de seleccionar una combinación coste-eficaz de medidas de

adaptación a través de un modelo de optimización a menor coste a escala de cuenca. El modelo se utiliza para investigar las soluciones de compromiso (“trade-offs”) entre diversos objetivos de planificación como son los caudales ecológicos necesarios, el desarrollo del regadío y el coste del programa de medidas. Seguidamente, se han evaluado los programas de adaptación frente a varias condiciones climáticas para definir así un programa de medidas robusto y de arrepentimiento mínimo frente al cambio climático.

En la última parte se aborda el problema del reparto justo de los costes del plan de adaptación, entendiéndose que esto es una manera de favorecer su implementación. Para ello, se han modelado los resultados de un proceso de negociación entre los diferentes actores mediante escenarios de reparto basados en la teoría de juegos cooperativos. Posteriormente, se han comparado estos resultados con otras reglas de reparto de costes basadas en principios de justicia social, proporcionando así un punto de vista diferente al proceso de negociación.

Este novedoso enfoque ha sido aplicado a una cuenca mediterránea, la cuenca del río Orb (Francia). Para ello, se han empleado proyecciones climáticas a medio-plazo de datos reescalados de 9 Modelos de Circulación Global. Además, se han desarrollado escenarios de evolución de la demanda en los sectores urbano y agrícola para el horizonte de planificación de 2030. El modelo de optimización a menor coste a escala de cuenca desarrollado en GAMS permite seleccionar un programa de medidas, de entre las 462 medidas de gestión de la oferta o de la demanda. Las medidas incluyen desde el desarrollo de nuevas infraestructuras hasta ahorros de agua en los hogares o en sistemas de riego. Nueve escenarios de reparto de costes basados en diferentes principios de justicia social han sido debatidos con informantes clave mediante entrevistas y comparados

con conceptos de solución de la teoría de juegos cooperativos, considerando un juego de 3 jugadores a escala de cuenca.

El marco interdisciplinario desarrollado durante esta tesis combina métodos de economía y de ingeniería de los recursos hídricos de manera prometedora y permite integrar los enfoques “top-down” y “bottom-up”, contribuyendo a definir un plan de adaptación coste-eficaz y justo a nivel local.

Resum

L'adaptació als múltiples aspectes del canvi global implica un repte per als enfocaments convencionals de planificació i gestió sostenible dels recursos hídrics a escala de conca. Hi ha nombroses opcions de gestió de la demanda i de la oferta. Entre aquestes, cal seleccionar mesures d'adaptació en un context d'incertesa elevada sobre les condicions futures. Ateses les interaccions entre els usuaris de l'aigua en el pla local, és necessari buscar acords a escala de conca per tal d'implementar les mesures d'adaptació més eficaces. Per aquest motiu, la tesi desenvolupa una metodologia que, mitjançant la combinació d'economia i enginyeria dels recursos hídrics, és adient per seleccionar un programa de mesures cost-eficàcia per fer front a les incerteses del canvi climàtic i, a més a més, definir un repartiment just del cost d'adaptació entre els actors implicats.

El marc metodològic ha estat desenvolupat amb el fi de permetre integrar contribucions dels principals enfocaments que s'utilitzen per a la planificació de l'adaptació. El primer, que es denomina descendent (*top-down*), consisteix en una cadena de modelat que va des dels escenaris d'emissions de gas d'efecte hivernacle en el pla global fins als models hidrològics locals per avaluar l'impacte del canvi climàtic sobre els recursos hídrics. Per contra, el segon enfocament, que es denomina ascendent (*bottom-up*), comença per avaluar la vulnerabilitat del sistema en el pla local per a tot seguit identificar mesures d'adaptació de cara a un futur incert. El marc metodològic presentat en la tesi es basa en una combinació dels dos enfocaments, fet que permet facilitar la selecció de mesures d'adaptació en l'àmbit local.

Els resultats del mètodes esmentats prèviament s'han integrat per a seleccionar una combinació de mesures d'adaptació cost-eficàcia mitjançant un model d'optimització a menor cost a escala de conca. El model s'utilitza

per investigar les solucions de compromís (*trade-offs*) entre els diversos objectius de planificació, com són els cabals ecològics necessaris, el desenvolupament del regadiu i el cost del programa de mesures. A continuació, s'avaluen els programes d'adaptació per a diverses condicions climàtiques amb el fi de definir un programa de mesures robust i de penediment mínim per a fer front al canvi climàtic.

En la darrera part s'escomet el problema del repartiment just dels costos del pla d'adaptació, considerant que això és una manera de facilitar la implementació del pla. En conseqüència, els resultats d'un procés de negociació entre els diferents actors han estat modelats mitjançant escenaris de repartiment basats en la teoria de jocs cooperatius. Tot seguit, els resultats s'han comparat amb unes altres regles de repartiment de costos basades en principis de justícia social. Això ha proporcionat un punt de vista diferent al procés de negociació.

Aquest enfocament innovador s'ha aplicat a una conca mediterrània, la conca del riu Orb (França). Amb aquesta finalitat s'han utilitzat projeccions climàtiques a mitjan termini de dades reescalades de 9 Models de Circulació Global (MCG). A més a més, s'han desenvolupat escenaris d'evolució de la demanda en els sectors agrícola i urbà per a l'horitzó de planificació de 2030. El model d'optimització a menor cost a escala de conca desenvolupat en GAMS permet seleccionar un programa de mesures d'entre les 462 mesures de gestió de la oferta o de la demanda. Les mesures inclouen des del desenvolupament d'infraestructures fins als estalvis d'aigua a les llars o als sistemes de reg. Els nou escenaris de repartiment de costos han estat debatuts amb informants clau, mitjançant entrevistes, i comparats amb conceptes de solució de la teoria de jocs cooperatius, considerant un joc de tres jugadors a escala de conca.

El marc interdisciplinari desenvolupat al llarg de la tesi combina mètodes d'economia i d'enginyeria dels recursos hídrics de manera prometedora i

permet la integració d'enfocaments *top-down* i *bottom-up*, fet que contribueix a definir un pla d'adaptació cost-eficàcia i just a escala local.

Résumé

L'adaptation aux multiples facettes du changement global remet en cause l'approche traditionnelle adoptée pour la planification et la gestion des ressources en eau à l'échelle des bassins versants. De nombreuses options de gestion de l'offre ou de la demande sont disponibles parmi lesquelles des mesures d'adaptation doivent être sélectionnées dans un contexte d'incertitudes élevées concernant les conditions futures. Etant donné l'interdépendance entre les usagers de l'eau, des accords ont besoin d'être trouvés au niveau local pour mettre en place les mesures d'adaptation les plus efficaces. Cette thèse développe une approche combinant l'économie et l'ingénierie des ressources en eau pour : sélectionner un programme de mesures d'adaptation coût-efficace dans un contexte d'incertitudes liées au changement climatique ; et pour définir une répartition équitable du coût d'un tel plan d'adaptation entre les différentes parties prenantes.

Le cadre méthodologique développé intègre des apports des deux principales approches habituellement utilisées pour la planification de l'adaptation. La première, intitulée « Top-down » (Descendante), comprend une chaîne de modélisation, partant de scénarios d'émissions de gaz à effet de serre au niveau global pour arriver aux modèles hydrologiques locaux, utilisée pour estimer l'impact du changement climatique sur les ressources en eau. Au contraire, la deuxième approche, appelée « Bottom-up » (Ascendante), commence par évaluer la vulnérabilité au niveau local pour permettre par la suite d'identifier des mesures d'adaptation qui permettront de faire face à un futur incertain. Le cadre méthodologique présenté dans cette thèse se base sur une combinaison de ces deux approches pour améliorer la sélection des mesures d'adaptation au niveau local.

Les résultats des approches précédentes sont intégrés au moyen d'un modèle d'optimisation développé à l'échelle du bassin versant pour

sélectionner une combinaison coût-efficace de mesures d'adaptation. Le modèle est ensuite utilisé pour explorer les arbitrages possibles entre différents objectifs de planification définis en termes de débits environnementaux, de développement de l'agriculture irriguée, et de coût du programme de mesures d'adaptation. Les performances de différents programmes de mesures sont finalement estimées pour différentes projections de changement climatique dans le but d'identifier des mesures d'adaptation robustes et de moindre regret.

La question de la répartition du coût du plan d'adaptation est ensuite considérée depuis deux perspectives complémentaires. Les résultats d'un processus de négociation entre les acteurs impliqués sont modélisés au moyen de la théorie des jeux coopératifs pour définir des scénarios de répartition des coûts. Ces résultats ont ensuite été comparés avec des règles de répartition des coûts basées sur différents principes de justice sociale pour fournir des éléments de discussion au processus de négociation.

Ce cadre méthodologique innovant a été appliqué dans un cas d'étude Méditerranéen, le bassin versant de l'Orb (France). Des projections du climat à moyen terme, désagrégées à partir de 9 modèles de circulation globale, sont utilisées pour évaluer les incertitudes associées aux projections climatiques. Des scénarios d'évolution ont été développés pour projeter les demandes en eau urbaines et agricoles à l'horizon de planification 2030. Le modèle d'optimisation développé sous GAMS permet la sélection d'un programme de mesures coût-efficace parmi un catalogue de 462 mesures de gestion de l'offre et de la demande, considérant la possibilité de développer de nouvelles infrastructures, mais aussi de mettre en place des mesures d'économie d'eau dans les ménages ou d'amélioration de l'efficacité de l'irrigation. Neuf scénarios d'allocation des coûts, construits à partir de différents principes de justice sociale, ont été

discutés lors d'entretien semi-directifs en face à face avec 15 informateurs clés. Ils ont ensuite été comparés avec des solutions issues de la théorie des jeux coopératifs pour un jeu à trois joueurs défini à l'échelle du bassin versant.

Le cadre méthodologique interdisciplinaire développé durant cette thèse combine des méthodes issues de l'économie et de l'ingénierie des ressources en eau pour combler l'écart entre les méthodes Top-down (descendantes) et Bottom-up (ascendantes) et pour informer la définition de plan d'adaptation coût-efficace et équitable à l'échelle locale.

2.2.3	Selecting adaptation measures in a context of climate change uncertainty	21
2.3	ADDRESSING THE COST ALLOCATION ISSUE.....	23
2.3.1	Equity and cost allocation in water resources management	23
2.3.2	Insights from game theory.....	24
2.3.3	The social justice approach.....	27
2.4	RESEARCH GAP AND MOTIVATION	28
CHAPTER 3	METHODS.....	31
3.1	OVERVIEW OF THE GENERAL METHODOLOGICAL FRAMEWORK	31
3.2	TOP-DOWN IMPACT ASSESSMENT.....	33
3.2.1	Emission scenario and general climate models	33
3.2.2	Downscaling techniques.....	34
3.2.3	Hydrological modelling.....	34
3.3	BOTTOM-UP EVALUATION OF DEMAND SCENARIOS AND ADAPTATION MEASURES.....	35
3.3.1	The participatory process	36
3.3.2	Defining future agricultural demand scenario.....	36
3.3.3	Defining future urban demand scenario.....	37
3.3.4	Selecting adaptation measures	38
3.3.5	Economic and technical assessment of measures.....	39
3.4	INTEGRATING TOP-DOWN AND BOTTOM-UP APPROACHES.....	39
3.4.1	Least-Cost River Basin Optimization Model.....	39
3.4.2	Scenario analysis through LCRBOM	42
3.4.3	Performance indicator	43
3.5	CLIMATE CHECK.....	44
3.5.1	Performance matrix.....	44
3.5.2	Regret matrix	45
3.5.3	Preferences and weights for ranking	45
3.6	ADDRESSING THE COST ALLOCATION ISSUE.....	46
3.6.1	Two approaches to define cost allocation scenarios	47

3.6.2	Cooperative game theory	48
3.6.3	Social justice approach	52
CHAPTER 4	CASE STUDY: THE ORB RIVER BASIN.....	55
4.1	HYDROLOGY OF THE ORB RIVER BASIN	56
4.2	WATER MANAGEMENT INFRASTRUCTURE	58
4.2.1	The Monts d'Orb reservoir.....	58
4.2.2	The BRL Company and the regional infrastructure	60
4.2.3	The Montahut hydropower plant.....	61
4.3	CONSUMPTIVE USES (CURRENT SITUATION)	62
4.3.1	The urban water sector	63
4.3.2	The irrigated agricultural sector	65
4.4	ENVIRONMENTAL FEATURES.....	67
4.5	LOCAL PLANNING AND MANAGEMENT CONTEXT	69
4.5.1	Planning process	69
4.5.2	Quantitative water management.....	70
4.5.3	Adaptation strategy to climate change.....	71
4.6	FINAL COMMENTS ON THE CASE STUDY.....	72
CHAPTER 5	IMPLEMENTING THE GENERAL FRAMEWORK	73
5.1	RESULTS FROM THE TOP-DOWN IMPACT ASSESSMENT.....	73
5.1.1	Future climate projections	73
5.1.2	Calibration and validation of the hydrological model	76
5.1.3	Future hydrological scenarios.....	79
5.2	RESULTS FROM THE BOTTOM-UP APPROACH	82
5.2.1	Stakeholder involvement.....	82
5.2.2	Future agricultural demand scenarios.....	85
5.2.3	Future urban demand scenario.....	89
5.2.4	Adaptation measures	90
5.3	DEVELOPING A LEAST-COST RIVER BASIN OPTIMIZATION MODEL.....	94
5.3.1	Characteristics of the model	94

5.3.2	Environmental flow requirements	95
5.3.3	Infrastructure management	95
5.3.4	Spatial representation: connectivity matrices	96
5.4	REMARKS ON THE IMPLEMENTATION OF THE FRAMEWORK.....	96
CHAPTER 6 SELECTING COST-EFFECTIVE ADAPTATION MEASURES UNDER GLOBAL CHANGE UNCERTAINTIES		99
6.1	COST-EFFECTIVENESS ANALYSIS OF THE MEASURES.....	99
6.1.1	Index-based cost-effectiveness analysis.....	99
6.1.2	Limits of the index-based cost-effectiveness analysis	102
6.2	SCENARIO ANALYSIS	103
6.2.1	Baseline scenario.....	103
6.2.2	Business-as-usual scenario.....	104
6.2.3	Least-cost programme of adaptation measures	105
6.3	TRADE-OFF ANALYSIS.....	107
6.3.1	Variations in agricultural demand at the basin scale	107
6.3.2	Trade-offs between environmental flows and cost of adaptation	111
6.3.3	Trade-offs between environmental flow, adaptation cost and agricultural demand.....	112
6.4	CLIMATE CHECK.....	113
6.4.1	Considering different climate projections	113
6.4.2	Assessing the performance matrix.....	116
6.4.3	Regret matrix	120
6.4.4	Analysis of preferences.....	120
6.5	FINAL COMMENTS ON THE SELECTION OF COST-EFFECTIVE ADAPTATION MEASURES.....	121

CHAPTER 7	ADDRESSING THE COST ALLOCATION ISSUE	123
7.1	APPLYING THE GAME THEORY APPROACH	124
7.1.1	Representation of the Orb River basin.....	124
7.1.2	The characteristic function.....	126
7.1.3	The core of the game	127
7.1.4	Solution concepts.....	128
7.2	APPLYING THE SOCIAL JUSTICE APPROACH	129
7.2.1	Defining cost allocation scenarios in practice.....	129
7.2.2	Field survey	131
7.2.3	Cost allocation scenarios following social justice principles	134
7.3	COMPARING COST ALLOCATION SCENARIOS	136
CHAPTER 8	DISCUSSION.....	141
8.1	KEY FINDINGS AND POLICY RECOMMENDATIONS	141
8.2	FEEDBACK ON STAKEHOLDER INVOLVEMENT	144
8.3	INSIGHTS FROM THE INTERDISCIPLINARY APPROACH	147
8.4	LIMITATIONS OF THE METHODS	149
8.4.1	On uncertainties in top-down and bottom-up approaches .	149
8.4.2	On the least-cost optimization model.....	152
8.4.3	On the cost allocation.....	154
8.4.4	On the overall framework	155
CHAPTER 9	SUMMARY AND CONCLUSIONS	157
9.1	SUMMARY	157
9.2	CONCLUSION.....	158
9.3	FUTURE RESEARCH.....	159
REFERENCES	163

APPENDIX A DISSEMINATION	185
APPENDIX B DOWNSCALING	187
APPENDIX C HYDROLOGY	191
APPENDIX D AGRICULTURAL DEMAND	213
APPENDIX E URBAN DEMAND	227
APPENDIX F ADAPTATION MEASURES.....	231
APPENDIX G ENVIRONMENTAL FLOW	237
APPENDIX H LEAST-COST RIVER BASIN OPTIMIZATION MODEL....	241
APPENDIX I COMPARISON IBCEA VS. LCRBOM.....	253
APPENDIX J COST ALLOCATION SCENARIOS	263
APPENDIX K PUBLICATION LICENSE AGREEMENTS.....	267
APPENDIX L CHAPITRES TRADUITS EN FRANÇAIS	271

Index of Figures

Figure 3–1 General methodological framework.....	31
Figure 3–2 Conceptual representation of a river basin.....	48
Figure 4–1 General map of the Orb River basin.....	55
Figure 4–2 Map of the Orb River and its tributaries.....	57
Figure 4–3 Monthly natural flow of the Orb River	57
Figure 4–4 View of the Monts d'Orb reservoir	59
Figure 4–5 Time series of monthly storage in the Monts d'Orb reservoir ...	60
Figure 4–6 Monthly releases from the Montahut hydropower plant	62
Figure 4–7 2008 Population in the Orb River basin.....	64
Figure 4–8 2008 Distribution of annual urban water demand in the Orb River basin.....	65
Figure 4–9 Current irrigated areas by Agricultural Demand Unit	66
Figure 4–10 2008 Distribution of the irrigated areas by type of crop.....	67
Figure 4–11 Fish distribution in the Orb River basin.....	68
Figure 4–12 Organization of water management in France.....	70
Figure 5–1 The SAFRAN grid on the Orb River basin.....	74
Figure 5–2 Monthly potential evapotranspiration anomalies for the 9 climate projections	75
Figure 5–3 Monthly rainfall anomalies for the 9 climate projections.....	75
Figure 5–4 Statistical analysis of climate data for 9 climate projections.....	76
Figure 5–5 Nodes of the hydrological model.....	77
Figure 5–6 Monthly average flow statistics under 9 future mid-term climate change projections and historical on the sub-basin O1	80
Figure 5–7 Mapping of the stakeholders included in the participatory process	83
Figure 5–8 Drivers of future agricultural water demand identified by consulted stakeholders.	86

Figure 5–9 Evolution of agricultural water demand at the basin scale under different scenarios.....	88
Figure 5–10 Monthly average agricultural water demands at the basin scale for 9 future mid-term (2046-2065) climate change projections.....	89
Figure 5–11 Comparison of monthly urban water abstractions from the Orb water resources	90
Figure 5–12 Workshops on the adaptation measures in the urban sector ..	91
Figure 5–13 Representation of the Orb River basin in the optimization model	94
Figure 5–14 Interdisciplinary interactions through the integration process..	97
Figure 6–1 Cost-effectiveness statistics for adaptation measures.	100
Figure 6–2 Ranking of the specific adaptation measures based on their cost-effectiveness indexes. The cumulated volume is the sum of volume saved or obtained through capacity expansion	101
Figure 6–3 Results of the scenario analysis.....	106
Figure 6–4 Cost of the PoM for different levels of agricultural demand at the basin scale.....	108
Figure 6–5 Distribution of measures selected given an increasing level of agricultural demand.....	109
Figure 6–6 Cost of the PoM for different environmental flow thresholds at three sub-basins	112
Figure 6–7 Cost of the Programme of Measures for different levels of agricultural demand	113
Figure 6–8 Distribution of the measures applied in the Orb River basin under 9 different climate projections.....	116
Figure 7–1 Schematic representation of the Orb River basin to address the cost allocation problem	126
Figure 7–2 Localization of the key informants.....	132
Figure 7–3 Results of the survey on the equity of cost allocation scenarios	133

Figure 7–4 Scenario for the cost allocation of the adaptation plan..... 135

Figure 7–5 Comparison of the cost allocation scenarios between the three
players..... 138

Index of Tables

Table 3-1 Scenario characteristics	42
Table 3-2 Description of the characteristic function of a three-player game	50
Table 5-1 Indicators of the hydrological model calibration and validation....	79
Table 5-2 Variation in the 5-year monthly low-flow by sub-basin and climate projection.....	81
Table 5-3 Stakeholder involvement in main water policy issues	84
Table 5-4 Assumptions on the change in irrigated crop area in the Orb River basin.....	87
Table 5-5 Participants at the three workshops on urban water conservation measures.....	92
Table 5-6 Characteristics of the adaptation measures	93
Table 6-1 Demand Reliability Index (DRI) under a business-as-usual scenario and cost of the optimal PoM for the 9 adaptation scenarios.	114
Table 6-2 Performance matrix of the 9 programmes of measures under the 9 climate projections	118
Table 6-3 Regrets matrix calculated to compare the performance of the 9 programmes of measures according to agricultural Demand Reliability Index and annual costs.....	119
Table 6-4 Preference table of the aggregated regret for different combinations of weight between the agricultural DRI and the cost of the PoM.....	121
Table 7-1 Characteristic function of the 3-player cost allocation game	127
Table 7-2 Boundaries of the Core of the 3-player cost allocation game....	128
Table 7-3 Cooperation game theory solution for the 3-player cost allocation game	128

Glossary of abbreviations

ADI	Agricultural Deficit Index
ADU	Agricultural Demand Unit
AERMC	Agence de l'Eau Rhône, Corse, Méditerranée; French River basin authority for the Rhône, Mediterranean basins and Corsica.
BAU	Business-As-Usual
CEA	Cost-Effectiveness Analysis
DRI	Demand Reliability Index
DS	Desalination (type of measure)
GAMS	General Algebraic Modelling System
GCM	General Climate Model
GW	Groundwater (type of measure)
GR2M	2 parameters monthly rainfall-runoff model (Modèle du Génie Rural à 2 paramètres Mensuel, in French).
IBCEA	Index-Based Cost-Effectiveness Analysis
IPCC	International Panel on Climate Change
LCRBOM	Least-Cost River Basin Optimization Model
PET	Potential EvapoTranspiration
PoM	Programme of Measures
SMVO	Syndicat Mixte de la Vallée de l'Orb, Local water management association of the Orb River basin
UDU	Urban Demand Unit
WFD	Water Framework Directive

Chapter 1 General introduction

1.1 Water management and adaptation to global change

Over the past decade, river basin authorities and stakeholders have been confronted with changing environmental, economic and societal conditions. Climatic conditions are evolving in many regions of the world, leading to increased water scarcity and risk of drought (Arnell, 2004). The Mediterranean basin is identified as a climate change “Hot Spot” at the global scale (Giorgi and Lionello, 2008; Mariotti et al., 2008) and significant impacts are expected on its water resources (Iglesias et al., 2007; Bates et al., 2008) and related ecosystem services (Bangash et al., 2013). Moreover, climate change should be considered as one of many drivers likely to increase pressures on water resources systems within a global change context (population growth, agricultural and industrial developments, changes in consumption patterns, increasing environmental awareness, etc.). In some cases, the impact of these other changes can substantially exceed the direct impact of climate change on water resources systems (Vörösmarty et al., 2000; Tanaka et al., 2006). Climate change and the increased demand for food production lead to an extension and intensification of irrigated agriculture. Urban water use also increases due to the concentration of population in cities and the emergence of new consumption patterns (Hunt and Watkiss, 2011), particularly in the Mediterranean Basin (Thivet and Fernandez, 2012). These trends result in increasing pressure on surface and groundwater resources and dependent ecosystems.

Concomitantly, societies have rising expectations regarding environmental protection. This has materialized in many legislative frameworks, such as the EU Water Framework Directive (WFD) which aims to achieve the good status of all European water bodies (EU, 2000). More recently, the EU communication (Blueprint) to Safeguard Europe’s Waters (EC, 2012) identified directions to achieve this good status, highlighting the interest of water efficiency improvement measures, among others. At the same time, the European guidelines for the implementation of the WFD in a changing climate suggest that new river basin

management plans and Programme of Measures (PoM) should be “climate checked”, to ensure long-term cost-effectiveness and robustness of the adaptation measures (EC, 2009). Adaptation strategies are needed and this necessity poses political and scientific challenges (Smith, 1997; Hallegatte, 2009; Biesbroek et al., 2010; Haasnoot et al., 2013), generating an increasing number of research initiatives and policy recommendations in the water sector in particular (Ludwig et al., 2011; Quevauviller, 2014; EC, 2013).

Two main approaches are commonly implemented in the design of climate change adaptation plans. The first begins at the global scale with the definition of emission scenarios, then moving to the local scale to assess the impact of climate change and support the selection of adaptation measures, thus following an approach named “top-down” (IPCC-TGICA, 2007). An alternative approach starts at the local level by assessing the different components of social vulnerability to climate change of the local community prior to developing an adaptation strategy. Therefore, this second approach is named a “bottom-up” approach. This was summarized, although in an exaggerated manner, by Dessai and Hulme (2004) in the following way: the bottom-up approach addresses adaptation with humans and largely disregards physical exposure, while the top-down approach ignores humans and only considers physical exposure. These approaches indeed differ in their definition of vulnerability (physical or social), as well as in their scale of analysis (local/global) and the timescale they use (short- to long-term). Several authors have highlighted the benefits of integrating both approaches as a way to improve the assessment of vulnerability at the local level to ensure more robustness of the adaptation strategy and to connect with the decision-making process (Wilby and Dessai, 2010; Mastrandrea et al., 2010; Ekström et al., 2013). Thus, it reinforces the relevance of existing approaches that integrate social and physical sciences to solve water management problems, and the need to go further in that direction (Reuss, 2003; Lund, 2015).

Selected adaptation measures are expected to be “cost-effective”, but also “environmentally sustainable, culturally compatible and socially acceptable”, and their selection should be based on “vulnerability assessments, costs and benefits

assessments, development objectives, stakeholder considerations and the resources available” (UNECE, 2009). Elements of effectiveness, efficiency, equity and legitimacy are indeed identified as key factors to ensure the sustainability of adaptation strategies (Adger, et al. 2005). However, the consideration of these different factors and their integration in the adaptation decision-making process is still an issue, especially given the high level of uncertainty often associated with future climate projections and other variations in eco-systems and socio-ecological systems involved in global change (IPCC, 2014).

Defining adaptation plans in a river basin requires selecting from a wide range of possible measures in different sectors (Iglesias and Garrote, 2015; Olmstead, 2013), from supply-side capacity expansion measures to develop new infrastructures and sustainably exploit new water resources (groundwater, desalination, transfer, reuse, etc.), to demand-side management measures to ensure water savings in urban or agricultural water sectors (Thivet and Fernandez, 2012), and through reforms at the institutional level to allow possible changes in the organization and management rules of the basin (Roggero, 2015). Some of these measures could be implemented autonomously by the different water users as a way of adapting to an evolving environment, but others may need to be planned by policymakers based on the awareness that conditions have changed and that actions are required to ensure the desired state of the river basin (IPCC, 2007). Therefore, decision makers need a way to select the adaptation measures in a context of climate uncertainty.

From an economic perspective, different approaches can be applied to select water management measures. In the US, Cost-Benefit Analysis (CBA) has been a standard in federal water projects since the 1936 US Flood Control Act made it a requirement to assess that the benefits, “to whomsoever they accrue”, are in excess of the estimated costs. However, the difficulty of correctly applying CBA to water management programmes in systems with complex physical and economic interactions “weakens policymakers’ confidence in comprehensive economic assessments at the basin scale” (Ward, 2009). Alternatively, a Cost-Effectiveness Analysis (CEA), defined as a method for comparing alternative policies in view of

minimizing the cost of achieving a desired objective (Garber and Phelps, 1997), has often been used to select programmes of measures, bypassing the valuation of non-market environmental benefits (and related controversies over non-market benefit valuation methods) and secondary benefits (Griffin, 1998). Following that direction, the policy approach currently adopted in Europe consists in defining water quality and environmental objectives based on biophysical criteria only. The appropriateness of CEA as a decision rule to address the complexity of water management problems in comparison to other types of analysis (Cost-Benefit Analysis, Multi-criteria, etc.) is clearly an issue (Messner, 2006; Martin-Ortega and Balana, 2012). However, in this thesis we will follow the current recommendation at European level, asking water managers and planners to conduct “an economic analysis that shall contain enough information to make judgments about the most cost-effective combination of measures to be included in the programme of measures” to meet environmental objectives (EU, 2000).

There are various methods of performing a cost-effectiveness analysis at the river basin scale, from the simple ranking of the measures following their cost-effectiveness ratio, dividing the cost of the measures by their effectiveness, to the development of a more complex integrated water resources modelling approach aiming at representing the complexity of water resource systems (Heinz et al., 2007). Indeed, in the water resources engineering literature, the issue of selecting measures for water resources planning has long been addressed as the problem of capacity expansion optimization (planning and scheduling of infrastructure development over time) through least-cost optimization models (Ejeta and Mays, 2005; O’Laoghaire and Himmelblau, 1974; Loucks et al., 1981). However, these approaches often assumed that future climate variability will maintain the statistical properties of past and current climate. Climate variability used to be characterized stochastically, through probability distribution functions. Climate change challenges this assumption, and with it the conventional way of planning and managing water resources, calling for the development of innovative methods to design adaptation programmes that could perform well across a variety of possible future situations.

An optimal or robust adaptation management plan elaborated under such an optimization framework generally consists of a combination of measures spatially distributed, which involve a large number of stakeholders from different sectors. However, most of the approaches based on optimization often fail to consider equity issues and share a common assumption of a state of perfect cooperation between the different stakeholders (Madani, 2010). This corresponds to following a social-planner perspective at the river basin scale to implement the most effective plan or water resources allocation, without considering individual interests. In practice, the implementation of such a programme of measures requires the agreement of stakeholders to implement the first best option. One of the key factors that determine the willingness to cooperate is how the cost of the optimal plan is shared between stakeholders. Stakeholders will only agree to implement actions prescribed by a cost-effective plan if they consider that the overall cost has been allocated in an equitable way between them, raising the need to ensure equity in the cost allocation. In the adaptation literature, the issue of equity is often limited to spatial equity issues related to reducing carbon emissions at the global level, or to temporal equity issues linked to intergenerational dependency between present and future generations (Paavola and Adger, 2006; Paavola, 2008). Equity in on-going adaptation at the local level is an emerging issue (Thomas and Twyman, 2005; Hughes, 2013; Graham et al. 2015). It is acknowledged that adaptation decisions are framed by antecedent decisions and existing institutional frameworks that determine the distribution of power and resources (Adger and Nelson, 2010). However, adaptation is already required, and decisions need to be taken in the present at the local level. Thus, equity needs to be addressed so that the impact of climate change does not contribute to reinforcing existing inequity.

1.2 Aim and objectives of the thesis

The general objective of this research is to develop an approach combining “top-down” impact assessments and context-sensitive “bottom-up” analyses in a consistent framework, to define a programme of adaptation measures integrating the goals of economic efficiency, environmental sustainability, climate robustness

and social acceptability, at the basin scale, in what we define as a bottom-up meets top-down approach.

To achieve the aim of the thesis, the following specific objectives have been defined.

- First, to integrate results from a “top-down” modelling chain, assessing the impact of climate change on water resources, with development scenario and adaptation measures elaborated through a “bottom-up” approach to support the selection of adaptation measures to global change at the river basin scale.
- Second, to select cost-effective adaptation measures at the river basin scale, also considering the trade-offs between different management objectives (agricultural development, environmental protection and economic efficiency) and aiming at identifying the least-regret adaptation measures in a context of climate uncertainty.
- Third, to investigate the definition of a fair allocation of the cost of the programme of adaptation measures between the stakeholders involved in its implementation to ensure that the adaptation is not only efficient, but also fair and acceptable.

As adaptation issues need to be addressed at the local level, in order to better confront the local impact of global change, the general methodological framework developed in this thesis was implemented in a real case study. The research was carried out in the Orb River basin, a Mediterranean basin located in Southern France, where global change is expected to exacerbate the difficulty in meeting growing demands and the EU-WFD environmental in-stream flow requirements. The area is facing one of the highest population growth rates in France, with a rapid development of vineyard irrigation, and the available water resources are threatened by the impact of climate change. The selection of water resources management measures to cope with the future challenges has become a strategic issue at the regional level, with several options under investigation.

1.3 Method and assumptions

The overall methodological framework developed to address the aim and objectives of the thesis relies on different methods and assumptions that we briefly detail in this section.

First, we consider the range of impact of climate change on the river basin on both the river natural flow regime and the water demands of users. Climate change impacts will depend on the climate projections and the areas considered. Thus, an appropriate modelling chain will be developed, based on downscaled climate data from different general climate models (GCM) combined with local hydrological and agro-climatic models following a “top-down” approach. In addition to the range of impact of climate change, we consider that adaptation needs will be determined by the evolution of the demand for water in the different sectors due to other factors of global change, and by the various adaptation measures that may be implemented. These components are addressed through participatory scenario-building workshops (“bottom-up” approach) identifying global change factors that drive the evolution of urban and agricultural demands, and possible adaptation measures.

The “top-down” and “bottom-up” results will be integrated through the development of an integrated river basin optimization model. The model will represent the management of water resources at the river basin scale given the operational and physical constraints of the water resources system, such as the allocation of water and the management of infrastructures, to ensure that management objectives are achieved in terms of supply of agricultural and urban demands, and environmental flow requirements. These management objectives are defined based on legal requirements (supply objectives) and biophysical criteria (environmental objectives). Thus, the development of the optimization model aims at selecting from a range of possible supply- or demand-side water management measures to adapt to global change at the river basin scale, based on a cost-effectiveness criterion. Under this cost-effectiveness framework, the evolution of demand scenarios or the level of environmental requirements can be modified to quantify the trade-offs between different management objectives such as the cost of

adaptation measures, the development of irrigated agriculture, and the level of environmental requirements. Then, the performance of various programmes of measures will be assessed under different climate change projections to identify a least-regret programme of adaptation measures in the context of climate uncertainty.

In order to transcend the limitations of the central planner perspective underlying the optimization process, which assumes that different stakeholders will cooperate in the implementation of the cost-effective programme of measure, the acceptability of the allocation of the cost of the adaptation plan will be investigated in terms of equity. Cost-allocation scenarios will first be designed by applying cooperative game theory solution concepts based on the principle of economic rationality. Subsequently, these results will be contrasted with cost allocation scenarios representing alternative principles of social justice, and investigated through face-to-face semi-structured interviews with local key informants to obtain insights on the definition of a fair allocation of the adaptation cost at the river basin scale.

Overall, one of the main contributions of this thesis lies in the methodological developments made to further integrate appropriate economic analysis with the complexity of water resource systems, at the frontier between economics and water resources engineering, combining – in a single piece of research – approaches that are usually implemented by diverse scientific communities. Its added value resides in the formulation of scientific recommendations to enhance economic analysis to support the design of adaptation strategy at the river basin scale.

1.4 Structure of the thesis

After this general introduction, the backgrounds of the various components of the thesis are introduced in a state-of-the-art chapter (Chapter 2). It introduces successively: the top-down and bottom-up approaches developed in the adaptation literature, and preceding attempts made towards integrating these approaches; this is followed by a presentation of current practices in water resources management

to select a cost-effective programme of adaptation measures, and the breakthrough provided by the development of an integrated water resources management model to address such issues; finally it reviews the literature associated with the design of an equitable allocation of the cost of the programme of measures.

Chapter 3 describes the general framework integrating top-down and bottom-up approaches and details its various components. The Orb River basin in France, where this general framework has been implemented, is then presented in Chapter 4, describing the current situation in terms of hydrology, water demands, and existing infrastructures, as well as the local institutional and management context.

The results of the implementation of the first steps of the general methodological framework developed are presented in Chapter 5, comprising: the adaption measures and the demand evolution scenarios obtained through the bottom-up approach; the impact of climate change in water resources through downscaling and hydrological modelling from the top-down side; and the integrated water resources management model used to integrate both approaches and to select a cost-effective programme of adaptation measures.

In chapter 6, the results of a first cost-effectiveness analysis of the adaptation measures and its limitations are explained as an introduction to the results from the integrated optimization model. Then, further results from the implementation of the modelling framework are displayed. The deficits in the supply of agricultural demand due to global change are quantified under different scenarios and described. Trade-offs between the cost of the programme of adaptation measures, the development of irrigated agriculture and the level of environmental flow requirements are evaluated for a given global change scenario. Then, the performances of various cost-effective programmes of measures are compared under alternative climate scenarios to assess their robustness (climate check) and identify least-regret options.

The issue of equitably allocating the cost of the programme of measures is finally addressed in the chapter 7. The cost allocation problem associated with the

definition of an adaptation programme of measures in the case study area is described. Then, the results from the implementation of social justice and cooperative game theory approaches are presented and contrasted.

Chapter 8 discusses the results of the case study and highlights the key findings of the thesis. It also reflects the limits associated with the development and implementation of the general framework in the light of the existing literature.

In order to facilitate the understanding of the whole work developed during the thesis, the different publications realized during this PhD have been combined and reorganized to produce the present manuscript, in agreement with the co-authors of these publications. Additional material has been added, either in the corresponding chapters or in the various appendices, to give access to a detailed and easier to read version of the work realized. Parts of the text are directly extracted from the publication in full agreement with the authors' copyright policy of the journal, allowing that "authors can use their articles, in full or in part, for a wide range of scholarly, non-commercial purposes, such as the inclusion in a PhD thesis" (See License agreements in Appendix K).

1.5 Research context and publications

Stakeholders and policymakers have been linked to the development of this thesis through the cooperation established with the French geological survey (BRGM). Indeed, the research presented in this thesis has benefited from the work realized in the Orb River basin by the BRGM research during successive previous research projects: the Ouest-Hérault Project phase I (2007-2008) and phase II (2010-2012) supported by the Rhône Mediterranean and Corsica River Basin agency, the regional and district council, and the research project on the development of a hydro-economic model funded by ONEMA and BRGM (2013-2014) that provided the necessary prerequisite and accompanying resources for the successful development of this thesis.

During my PhD, I have been registered as a PhD candidate at the Technical University of Valencia (UPV) in the doctorate programme of Water and

Environmental Engineering. I was also registered in France, administratively at Montpellier SupAgro (Centre international d'études supérieures en sciences agronomiques), and academically at the Montpellier Doctorate School of Economics and Management (EDEG), associated with the research unit of the UMR G-EAU, as part of a double degree procedure, alternating my work time between France and Spain.

My research has been financed by a grant from the University Lecturer Training Programme (FPU12/03803) of the Ministry of Education, Culture and Sports of Spain.

The following articles have been published in international peer-reviewed journals during the preparation of this thesis dissertation¹:

- **Girard**, C., Rinaudo, J.D., Pulido-Velázquez, M., Caballero, Y., 2015. An interdisciplinary modelling framework for selecting adaptation measures at the river basin scale in a global change scenario, *Environmental Modelling & Software*, (69), 42-54. <http://dx.doi.org/10.1016/j.envsoft.2015.02.023>
- **Girard** C., Rinaudo, J.-D., and Pulido-Velazquez M. 2015 Cost-Effectiveness Analysis vs. Least-Cost River Basin Optimization Model: comparison in the selection of water demand and supply management measures at river basin scale. *Water Resources Management*, 29, 4129-4155 <http://link.springer.com/article/10.1007/s11269-015-1049-0>
- **Girard**, C., Pulido-Velazquez, M., Rinaudo, J.-D., Page, C., and Caballero, Y., 2015, Integrating top-down and bottom-up approaches to design global change adaptation at the river basin scale, *Global Environmental Change* 34,132-146 <http://dx.doi.org/10.1016/j.gloenvcha.2015.07.002>.

¹ Further scientific publications and communications in international conferences are listed in Appendix A

Chapter 2 State-of-the-art

This chapter reviews the literature and existing approaches to select cost-effective adaptation measures in a context of climate uncertainty and to allocate the cost of the adaptation of water resources systems equitably. After a brief introduction to top-down and bottom-up approaches to climate change adaptation at the river basin scale, the literature on the integration of both approaches is presented (2.1). Then, the methods used to select cost-effective programmes of measures are reviewed, with a special focus on current cost-effectiveness analysis and the added value provided by integrated water resources management models when selecting measures in a context of climate uncertainty (2.2). Finally, to address the equity issue, the literature from cooperative game theory and social justice theory are reviewed in relation to allocating the cost of the adaptation measures (2.3).

2.1 Integrating top-down and bottom-up approaches

2.1.1 Top-down approaches

Since the first evidences of an increase in atmospheric carbon dioxide in the atmosphere were provided by the Keeling curve (1957), climate models have been developed by the scientific community to provide sound scientific information in order to support the development of climate policy at the global level, following a so-called “science first” approach (Howe, 2014). Mainly oriented towards the negotiation of mitigation policy at the global scale, the main assumption of the scientific community was that once scientific knowledge about climate change was provided, policy would follow and agreements would be made concerning the reduction targets at the international level. This opened the way to the International Panel on Climate Change (IPCC), cycles of discussion and the elaboration of assessment reports to establish agreed climate science among the scientific community. Whereas climate models were first thought to assess the relation between the increase in the concentration of greenhouse gases and climate change at the global scale, they have since been used to investigate possible

impacts under different climate change projections at a more local level, following what is known as the “top-down” approach.

Thus, these top-down (or ‘scenario-centred’) methods involve downscaling climate projections from General Circulation Models (GCM) under a range of emission scenarios, to provide inputs for hydrologic and management models to estimate potential impacts and, finally, to analyse adaptation measures (Caballero et al., 2007; Sperna Weiland et al., 2012; Milano et al., 2012; Pulido-Velazquez et al., 2014). The term “top-down” is used because information is cascaded from one step to the next, with uncertainty expanding at each step of the process. However, given that uncertainties increase along the top-down modelling chain, at best it provides an “uncertain outlook”, which complicates the definition of adaptation strategies; and at worst, it provides results too uncertain for decision makers to even consider. Despite this unavoidable propagation of uncertainty (Ekström et al., 2013; Dessai et al., 2005), this should not be used as an excuse for delays or inaction in adaptation, as water resource systems can be greatly affected (UNECE, 2009).

Improving the top-down approach would require, on the one hand, addressing the challenges of a more complex probabilistic multi-model ensemble forecast (Knutti et al., 2010) or, on the other hand, addressing the uncertainty propagation through all steps involved in regional climate downscaling and hydrological modelling (Ekström et al., 2013). The case for or against probabilistic approaches is made by biophysical and social vulnerability scholars respectively, the latter challenging the relevance of climate change probabilities in defining adaptation strategy (Dessai and Hulme, 2004).

2.1.2 Bottom-up approaches

The bottom-up approaches analyse social vulnerability and adaptive capacity to uncertain climate variations to make adaptation decisions (decision-centred approaches) and to achieve resilience of the socio-environmental systems (Holling, 1973; Norris, 2008). Vulnerability is a multifaceted concept and it does not have an unequivocal definition across different approaches and disciplines. Under a risk reduction approach, it is defined as one of the determinants of risk, encompassing

“the characteristics and circumstances of a community, system or asset that make it susceptible to the damaging effects of a hazard” (UNISDR, 2009). In the specific field of climate adaptation, the last IPCC assessment report glossary updated its definition of vulnerability as “the propensity or predisposition to be adversely affected, encompassing a variety of concepts and elements including sensitivity or susceptibility to harm and lack of capacity to cope or adapt” (IPCC, 2014). The updated glossary also acknowledges the difference between “outcome” and “contextual” vulnerabilities made in the literature (Kelly and Adger, 2000; O’Brien et al., 2007), and also differentiated as “end-point” and “starting-point” vulnerability; referring to physical and social vulnerability respectively.

“Outcome vulnerability” is defined as “the residual consequences remaining after adaptation has taken place” (IPCC, 2014). Thus vulnerability is the end-point of a sequence defining local impact from global drivers to define an adaptation response, corresponding, in this sense, to what we previously described as a top-down approach. The second approach defines “contextual vulnerability” as “the present inability to cope with external pressures or changes, such as changing climate conditions. It is a characteristic of socio ecological systems generated by multiple factors and processes” (IPCC, 2014), corresponding thus to the definition of vulnerability used in bottom-up approaches described in this chapter.

In such bottom-up approaches, adaptation strategies or key vulnerability variables are not presumed by the researcher but rather identified empirically from the community, using semi-structured interviews and focus-group discussions, information from experts and local stakeholders, and available literature (Smit and Wandel, 2006; Adger et al., 2009; Bhave et al., 2013). The definition of a future scenario may still rely on some national estimation but needs to be grounded on the local perceptions of stakeholders (IPCC, TGICA, 2007) to ensure the proper characterization of exposure and the credibility at the local scale where the adaptation decision will be made. To summarize this shift in the analysis, the bottom-up approach, instead of asking how much water needs to be supplied to meet projected climate changes, asks what patterns of development and socio-economic activities are sustainable and will reduce water risks generated by climate variability (Smit and Wandel, 2006).

2.1.3 Integrating top-down and bottom-up approaches

These two attitudes toward the “drama of uncertainty” (Mearns, 2010) that challenge the adaptation to climate change can be summarized thus: on one side, the “necessity-of-reducing-uncertainty camp” that would further investigate via a top-down approach in order to narrow down uncertainties and support adaptation from a “predict-then-act” perspective; and, on the other side, the “vulnerability-and-response camp” that develops tools and methods to analyse the risks associated with adaptation strategies. The distinction between the two camps is not straightforward, and scientists do not always belong to one camp only (Meyer, 2012).

However, in practice, few studies have combined these approaches. Bottom-up and top-down approaches have been associated through the combination of a multi-level stakeholder consultation process, used to identify adaptation measures through scenario analysis, with an integrated water resources management model to assess the performance of different soil and water conservation measures under different climate scenarios from regional climate models (Bhave, Mishra et al., 2013). However, this approach did not account for any factors of change that may affect the definition of adaptation strategy other than that of climate.

Participatory integrated assessment tools have been developed to engage with stakeholders on the assessment of impacts and vulnerability to climate change of various sectors, including water resources (Harrison et al., 2013). Through a series of participatory workshops, a web-based platform was developed that links various sectorial models to estimate the impact of climate and socio-economic scenarios on the vulnerability of these sectors and assess possible adaptation measures on a large scale.

The fact that decision makers are currently not using climate data, due to a mismatch between the way information is provided and the current decision-making process, has been acknowledged (Mastrandrea et al., 2010). The benefits of linking scientist and stakeholder knowledge to produce understandable, usable information and tools to deal with climate change risks has been highlighted in

hypothetical examples dealing with biodiversity conservation and coastal management (Mastrandrea et al., 2010).

A promising approach, named “decision scaling” has been developed to connect vulnerability analysis with climate projections (Brown et al., 2012). It relies mainly on the use of stochastic vulnerability analysis for the definition of adaptation response. The analysis aims at obtaining a climate response function linking climate statistics to key performance indicators and it only uses climate projection information at the end of the process, to estimate the probabilities of the risky climate state. Within this computer- and data-intensive framework, the involvement of stakeholders would be mainly limited to the definition of the performance indicators, which could challenge local appropriation.

In Europe, guidelines on the implementation of the WFD in a context of climate change recommend seeking methods that examine how each potential measure will perform against the range of possible future climates modelled (EC, 2009). These methods would start with a range of possible local responses as a portfolio for coping with global change-related threats at the level of the different stakeholders (individuals, households and communities). Then, the robustness of various possible adaptation strategies can be assessed by evaluating their performance against a wide range of plausible scenarios (Groves et al., 2008) without waiting for an eventual improvement in the accuracy of future scenarios. Some methods do not rely on global climate projections at all but focus on sensitivity analysis or stress tests (scenario-neutral approaches, (Prudhomme et al., 2010)). Our interest lies in this interface between the two aforementioned approaches, leading to our investigation of a “bottom-up meets top-down” perspective, where the focus is on the river basin under study and GCM projections are used to inform rather than direct adaptation strategies (Brown and Wilby, 2012).

2.2 Selecting cost-effective adaptation measures in river basin

2.2.1 Cost-effectiveness analysis in water resources management

Defining an adaptation plan at the river basin scale requires selecting from a wide range of measures in a context of uncertainty. Although the European legal framework clearly requires that the most cost-effective combination of measures must be included in river basin management plans (EC, 2000), no direct reference is made to the method to be implemented. Only the EU policy implementation guidelines clearly call for the use of Cost-Effectiveness Analysis (WATECO, (2003). The approach has been recommended by most national guidelines, reports and academic papers (Berbel et al., 2011). In most of the existing studies, the CEA approach consists of ranking measures at the basin scale based on a single indicator of cost-effectiveness (what we call Index-Based Cost-Effectiveness Analysis, IBCEA), estimated as total cost divided by total effect (ACTEON, 2011). The main limitation of the IBCEA approach is that it measures effectiveness as a reduction in the pressure (e.g. decrease in water abstraction), whereas objectives are defined in terms of impacts (good environmental status of the water bodies, often linked to in-stream environmental flow requirements), (Martin-Ortega and Balana, 2012; Berbel et al., 2011; Balana et al., 2011). These limitations have mainly been highlighted in the context of water quality issues, but here we extend this reflection on the use of CEA by focusing on water quantity management challenges in a context of adaptation to climate change.

A basin-wide index-based cost-effectiveness ratio can certainly be useful for conducting a preliminary screening of measures and for supporting the development of the main lines of quantitative water management strategies. However, it can be misleading when identifying cost-efficient solutions at the basin scale for several reasons. First, the cost and effectiveness of measures vary significantly with the location within the watershed, depending on the specific technical and economic circumstances under which they are implemented. Second, river basin management plans usually target multiple quantitative

management objectives simultaneously (not to mention quality objectives); for example, minimum in-stream flow requirements at different river reaches.

The effectiveness of measures should therefore be assessed by taking into account their contribution to these different objectives, and by considering the spatial and temporal specificities of the basin. This requires integrating the physical characteristics of the water bodies (interconnections, stream/aquifer interactions, reservoir releases, return flows, system operating rules, etc.) to capture the spatial (upstream-downstream interactions) and temporal (hydrological and demand variability) dimensions of the problem, as is the case in integrated water resources management models (Wurbs, 1996). The problem to be solved thus becomes more complex than ranking measures according to a single indicator. It can be formalized as a least-cost optimization problem at the river basin scale, where the analyst seeks to identify the optimum combination of measures that (i) minimizes costs, while (ii) meeting several interrelated management constraints, (iii) associated with a given probability of failure over time (performance indicators). Solving this kind of problem requires implementing a computer-based optimization model that integrates hydrology, infrastructure management and economics; tools that belong to the family of integrated water resource management models (Loucks and van Beek, 2005).

2.2.2 Integrated water resources management models

When addressing water scarcity issues, water managers need to anticipate how to adapt management practices and infrastructure development for some future state of their water resource systems. This requires that they develop a systemic approach, depicting the natural and socio-economic factors and processes that determine future dynamics of river basins using tools more complex than basic IBCEA. The factors and interaction processes can be formally represented through the development of integrated river basin management models (Jakeman and Letcher, 2003; Letcher et al., 2007), which can be used either to learn about the impact of alternative water management strategies or to identify optimal strategies under future climate, demand and regulatory scenarios. Developing such integrated models to estimate future changes and frame adaptation plans is not,

however, a trivial task. It requires integrating concepts, methods and modelling tools from various domains of expertise and scientific disciplines such as water resources engineering and economics.

Engineering and micro-economics share common ancestors in the French engineering school of the 19th century. Jules Dupuit is acknowledged as being the first to introduce the concept of consumer surplus to take into account the economic benefits from public projects (e.g. water-conveying canals, bridges and roads), opening the way to the economic analysis of engineering projects (Elelund and Hebert, 1999). Pioneering efforts to address water planning issues within an interdisciplinary approach date back to the Harvard Water Programme in the late 1950s, when economics, social sciences and engineering were first brought in to support water policy-making.

Nowadays, such initiatives have become even more necessary due to the growing complexity of water management issues (Reuss, 2003; Lund, 2015; Brown et al., 2015). River basin management models – often coupled with Decision Support Systems tools – have been developed at basin scale to assess the performance of water resource systems under different scenarios and policy strategies combining optimization and simulation frameworks (Andreu et al., 1996; Labadie, 2004, Singh, 2012; Jacoby and Loucks, 1972). Within this family of models, hydro-economic models (HEM, (Harou et al., 2009; Heinz et al., 2007; Brouwer and Hofkes, 2008)) took one step further into interdisciplinary modelling by integrating economics and water resources management into a coherent framework. The potential of hydro-economic models to assess policies and select management measures at the basin scale within the context of the European Water Framework Directive is acknowledged in the literature (Heinz et al., 2007). At basin scale, HEMs have been applied to assess the marginal economic value of storage and environmental flows and so provide economic indicators and instruments, as required by the EU WFD (Pulido-Velazquez et al., 2008, 2013; Riegels et al., 2013).

However, regarding current practices in Europe, few case studies are using such integrated optimization procedures and models for the selection of a programme of measures (ACTEON, 2011). These models have mainly been implemented to

select least-cost combinations of measures to meet water quality standards (Peña-Haro et al.; 2009; Lescot et al., 2013; Udias et al., 2013) and in some cases to define a portfolio of management measures (Padula et al., 2013).

At the European scale, a hydro-economic model has been developed to select water efficiency measures to support the next EU water policy development (De Roo et al., 2012) recognizing the limits of such an approach at the European scale. In the United-States, HEMs have been applied to analyse the adaptation of inter-tied water supply systems to global change in California (Tanaka et al., 2006; Medellín-Azuara et al., 2008) and New Mexico (Hurd and Coonrod, 2012). Various research initiatives have been launched to integrate the impact of climate change, from an interdisciplinary perspective, into the implementation process of the European WFD (Quevauviller et al., 2012; Pouget et al., 2012). However, despite a few pioneering studies, the vast majority of existing studies stop short at the impact assessment stage. So, although they are valuable, they only provide a limited contribution to the question of adaptation (Wilby and Dessai, 2010).

2.2.3 Selecting adaptation measures in a context of climate change uncertainty

An approach defining a programme of adaptation measures has to address the uncertainties associated with future climate change projections. At this stage, the difference needs to be made between at least two types of uncertainties. On the one hand “randomness” associated with natural processes that can be characterized by a probability distribution function and that is addressed in the planning of water resources management through, for instance, stochastic optimization procedures. And on the other hand, “severe” or “deep” uncertainty, which occurs when probability distributions are unknown, as is the case with the future climate projections, which require new approaches to be developed (Walker et al., 2013). Within planning approaches for adaptation under deep uncertainty, a distinction can be made between the conceptual approaches elaborated to define an adaptation plan and the computational tools developed to support these approaches (Walker et al., 2013).

Conceptual approaches to plan under deep uncertainties can be classified into four main categories: resistance, resilience, static robustness and dynamic robustness (Walker et al., 2013). Resistance is understood as planning for the worst case. Resilience ensures that the system will be able to recover when confronted with a wide range of situations. Static robustness would reduce vulnerability in most of the possible future conditions, whereas dynamic robustness, or flexibility, would add the possibility of taking into account the evolution over time and changing conditions. Starting from the Assumption Based Planning method (Dewar et al., 1993), planning approaches, such as robust decision making, have been developed (Lempert and Groves, 2010) following a static robustness approach or, more recently, dynamic adaptive policy pathways (Haasnoot et al., 2013), which follow a dynamic robustness approach to progressively capture the complexity of the decision-making process associated with the planning of adaptation to climate change.

In the water sector, various modelling frameworks and computational tools have been developed to support these different planning approaches to cope with deep uncertainty in water resources systems (Dessai et al., 2013). The Robust Decision Making approach has been applied to support planning of water resources under deep uncertainty by combining simulation tools with a scenario discovery algorithm to assess the vulnerabilities of adaptation plans under specific conditions in the water sector in California (Lempert and Groves, 2010). Matrosova, et al. (2013a, b) compare, successively, Robust Decision Making with Economic Optimization and Info Gap Analysis in the selection of portfolios of adaptation measures for South East England, to highlight the complementarity of these approaches in providing appropriate information for adaptation. Kwakkel, et al. (2014) investigate Dynamic Adaptive Policy Pathways through a multi-objectives evolutionary algorithm to assess the trade-offs between different adaptation pathways to produce a map of the different possible pathways over time in a hypothetical case study, highlighting the computational burden associated with such calculation-intensive tools.

2.3 Addressing the cost allocation issue

As presented in the previous sections, research on the elaboration of a water resources adaptation programme of measures at the local level has mainly focused on the definition of a cost-effective, robust or flexible adaptation plan or portfolio to face the uncertainty associated with climate change and future development scenarios. Most of these approaches share a common social-planner approach to design the most effective plan or water resources allocation without considering equity issues or strategic interactions between stakeholders.

However, implementing such optimal or robust adaptation management plans, generally consisting of a combination of measures spatially distributed and benefitting more than one water user, will require reaching an agreement among a large number of stakeholders from different sectors. One of the key factors that determine the willingness to cooperate is how the cost of the optimal plan is shared by the stakeholders. They will only agree to implement actions prescribed by an adaptation plan if they consider that the overall cost is allocated equitably.

2.3.1 Equity and cost allocation in water resources management

Equity issues in water resources planning and management are often addressed for the allocation of the cost of projects and infrastructures developed or shared between various stakeholders, such as multi-purpose reservoirs. The design of an equitable cost allocation mechanism has long been seen as the best way to ensure the agreement or cooperation of those who pay the costs of large water infrastructure projects (Young et al., 1982). Various sets of principles have been established and recommended as guidelines to ensure an equitable cost allocation of water resources projects (Ransmeier, 1942; Heaney, 1997; James and Lee, 1971; Straffin and Heaney, 1981). Each set of principles and guidelines underscores the fact that every cost allocation strategy has its unique history and set of arguments as to what constitutes a “fair” division of costs (Heaney, 1997). It highlights why context is so important in the definition of a cost allocation that captures the complexity behind the notion of equity, which resists simple formulation. It has to be recognized that equity is strongly shaped by cultural

factors, by precedent, and by the type of good and burdens being distributed (Young, 1994). In general, cost allocation problems have no universal correct answer, and the nature of cost allocation is fundamentally indeterminate and controversial, as each stakeholder could be tempted to favourably influence the allocation by shifting the largest share of the joint costs to the others (James and Lee, 1971). Therefore, the definition of a cost allocation can be seen rather as a way of ensuring the successful resolution of a conflict of interests, than as a quest for theoretical universal equity. In order to investigate possible cost allocations and provide some food for thought concerning the allocation of the cost of a programme of adaptation measures at the river basin scale, two main approaches have been investigated: one following the implementation of principles coming from the game theory literature; and the other, contrasting this approach by considering a social justice approach.

2.3.2 Insights from game theory

In the 1930's, engineers and economists of the Tennessee Valley Authority (TVA) investigated ways of allocating the cost of multi-purpose water resources development projects between multiple users. Their pioneering work of comparing various cost allocation methods, such as the Separate Cost method, and the Alternative Cost Avoided has later been recognized as foreshadowing the development of game theory concepts (Ransmeier et al, 1942; Straffin and Heaney, 1981).

Formal game theory indeed came later on, with the theoretical development from Von Neuman and Morgenstern (1944) that founded the mathematical representation of strategic interactions between different players. However, the conclusions of the TVA were more related to the later development of cooperative game theory and associated solution concepts, such as the Shapley value (Shapley, 1953) or the nucleolus (Schmeidler, 1969), and the analysis of the stability of the coalition through the power index (Shapley and Shubik, 1954) or the propensity of a member of the coalition to disrupt (Gately, 1974). The branch of cooperative game theory assumes that players can make binding agreements, in

contrast with non-cooperative game theory, where the players' commitments are not enforceable (Montet and Serra, 2003).

Cooperative game theory has been applied to the management of water resources as a theoretical framework to analyse the possibility and stability of long-term agreements on the allocation of water resources or on cost-sharing agreements at the basin scale (Parachino et al, 2006). Cooperative game theory is interested in the way coalition between players can form instead of "stand-alone" or "status quo" non-cooperative solutions, and on how the benefits from a cooperative solution could be allocated among the members of a grand coalition.

An example of the cost allocation problem associated with the development of joint water supply facilities was investigated by comparing solutions coming from cooperative game theory (Shapley, Nucleolus) to cost allocation methods coming from water resources planning practices, such as direct proportionality or the Separated Cost Remaining Benefits (Young et al., 1982). The limits of the commonly recommended separated cost remaining benefit methods were highlighted, as well as the interest of the simple proportional allocation, or more elaborate game theory solution. However, the complexity of such methods and the data required were recognized as limiting factors for their implementation in practice.

The power index and the propensity to disrupt have been used to assess the stability of the allocation of the cost of water quality pollution control under different cost allocation rules (proportional, marginal cost and SCRB) and alternative game theory solution concepts (Nucleolus, Shapley, Nash-Harsanyi), (Dinar and Howitt, 1997). The allocation of benefits associated with the cooperative management of groundwater has been assessed through the stability analysis of different cooperative game theory solution concepts, considering different individual management institutions to estimate the status quo solution (non-cooperative), (Madani and Dinar, 2012). In Europe, cooperative game theory concepts have been combined with river basin optimization models to allocate the cost of water management infrastructures in complex water resources systems, as a way to

support the definition of pricing policy in agreement with the implementation of the Water Framework Directive (Deidda, et al., 2009; Sechi, et al., 2013).

These approaches rely on a common rationality assumption underlying the development of game theory. Indeed, the development of game theory assumes that an agent or player is rational if he makes choices consistently to maximize his payoff (or utility) according to his belief of the decision-making context (Montet and Serra, 2003). For instance, the definition of the Core of the game assumes that the solution space for cooperation between players is bound by individual and group rationality principles, considering that no player or group of players will join the coalition if this will reduce their payoff in comparison with a stand-alone solution.

An interesting debate emerged on this assumption, inspired by recent developments in behavioural economics. It highlights the possibility of integrating social components in the utility function to overcome the drawbacks of a limited utility function considering only material self-interest. A utility function following a standard self-centred utility-maximizing framework would impede the possibility of capturing any prosocial behaviour (Zarri, et al, 2010). Indeed, understanding social preferences, in terms of fairness and reciprocity for instance, have been proven to be crucial in understanding the processes of cooperation or collective action (Fehr and Fischbacher, 2002). And assuming that agents are only self-interested in material terms could in the end be counterproductive in the design of policy, such as by including economic incentives. It could undermine the propensity of agents to cooperate and to also value non-material incentives (Bowles, 2008). This phenomenon is known as the motivation crowding-out effect in the economic theory on individual behaviour (Frey and Jegen 2001) and collective action (Ostrom, 2000). In the case of solving a cost allocation problem at the river basin scale, focusing only on the way the cost could be allocated given each agent interest would impede understanding which other elements, such as social preferences, should be taken into account to ensure a fair cost allocation.

2.3.3 The social justice approach

Without entering further into a debate that could be beyond the scope of our current research, we can consider, from a more pragmatic perspective, that agent decisions on environmental resource management in general, and on water resources in particular, can be based on different definitions of equity, as there is no single one-size-fits-all equity criteria. In order to define equitable cost allocation rules, these different definitions of equity need to first be acknowledged and understood to be then taken into account in the definition of the allocation rule.

Such an approach corresponds to the perspective adopted in the social justice literature, following which, agent decisions related to the environment are strongly influenced by social justice principles (Wenz, 1988; Neal, et al., 2014; Syme, 2012; Zwarteveen and Boelens, 2014). This literature, mainly grounded in economic sociology and economic psychology, acknowledges that economic agent decisions also depend on social preferences and ethical motives and suggest that judgment about what is fair and equitable is additionally based on philosophical, ethical and moral principles; not (solely) on self-interested material considerations, considered as the myth of “self-interest”, (Tyler and Blader, 2000). The underlying idea is that individuals may be willing to give up some monetary pay-off for motives relating to altruism, solidarity, reciprocity, etc.

Allocating the cost of a programme of measures to improve the management of water resources at the river basin scale presents similarities with resources allocation problems, considered in the social justice literature as “social dilemma” (Dawes, 1980), where people may have to decide between their self-serving actions (defection) and actions serving the collective (cooperation). This dilemma results from the contradiction between three main factors that have to be considered simultaneously in a resources allocation problem: greed, efficiency and fairness (Wilke, 1991), understanding that, in a resources dilemma, people’s greed leads them to defect, but is constrained by preferences for efficient use of resources and fair distribution (Eek and Biel, 2003).

In practice, social justice approaches have been implemented in few cases related to the management of water resources, and mainly to address the problem of water resources allocation. Gross (2008) followed a transdisciplinary approach to investigate the equity issue linked to the allocation of water for irrigated agriculture in Australia. The various perspectives from the irrigation community are revealed, providing elements to integrate equity principles in the decision-making process.

The perception of fairness in the allocation of water resources in Australia has been extensively investigated by Syme and Nancarrow (1997) through stakeholder surveys comparing different case study areas. First, they asked respondents to rate general philosophical statements on water allocation, and then express their perception of fairness on the water allocation in various case studies. The statistical analysis of the results enables an understanding of the determinants of the judgment of fairness in the water allocation and provides recommendations on the definition of a fair water allocation. Moreau, et al. (2013, 2015) investigated the social justice principles at stake in the acceptability of groundwater resources allocation among farmers. Social justice principles from the literature were used to design groundwater allocation scenarios, which were later discussed through face-to-face semi-structured interviews with farmers in different case studies in France. They made an ex-ante evaluation of the acceptability of the various allocation rules and provided some understanding of the rationale developed by the farmers on the definition of equitable allocation, thus providing some elements to better understand the determinants of an allocation that is not based exclusively on efficiency criteria.

2.4 Research gap and motivation

From this state-of-the-art, the development of a framework to reach the objectives of defining a cost-effective and equitable programme of adaptation measures at the river basin scale in a context of climate uncertainty requires integrating different methods coming from the water resources engineering, economics and adaptation literatures. Each of these objectives is usually addressed separately through different methods. However, ensuring one objective is achieved is not always

considered in the light of the others. Each method presents its respective limitations in terms of underlying assumptions aiming at representing the complexity of the problem, and also in terms of useful outcomes to provide relevant information to the adaptation decision-making process.

There is still a need for a better integration of these different approaches to cross disciplinary boundaries. Therefore, this thesis aims at bridging the research gap between economics and water resources engineering approaches to develop a cost-effective programme of adaptation measures at the river basin scale in a context of climate uncertainty, and to address the cost allocation problem associated with such a programme of measures. The research question is not which method is the best to solve each of the separate problems, but how to integrate relevant methods in a coherent framework to better address the overall problem of selecting adaptation measures at the river basin scale, taking the best from each approach. From a methodological perspective, we hope that the combination of approaches described in this thesis can be a source of inspiration, as much for economists dealing with the management of water resources as for water resource engineers interested in improving the economic analysis of the planning and management of water resources.

Chapter 3 Methods

To address the research gap identified in the preceding section, we first present a general framework developed during this thesis. To facilitate the understanding of the complex, modular and interdisciplinary approach implemented, we start this chapter with a brief overview of the methodological framework before describing each component in more detail. Figure 3-1, which summarizes the methodological framework, is referred to extensively in the rest of the chapter.

3.1 Overview of the general methodological framework

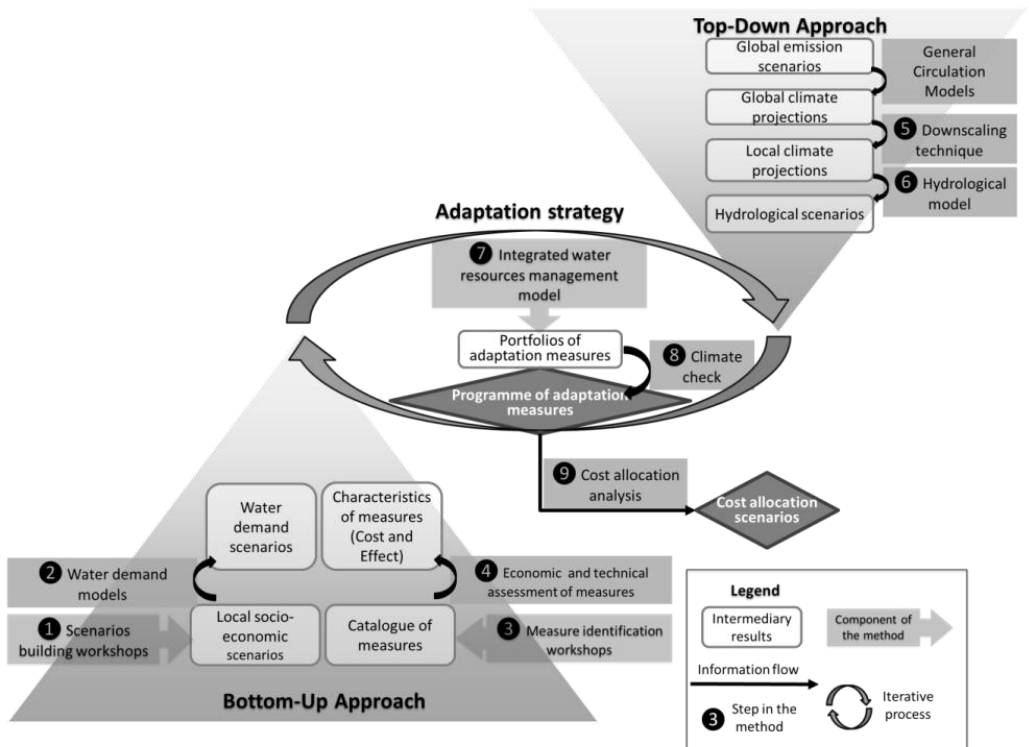

Figure 3–1 General methodological framework

The bottom-up approach component of the framework consisted of eliciting stakeholders' visions of how global change may affect the territory under study, and the range of adaptation that could be implemented to cope with the changing conditions. Participatory foresight techniques are first used to progressively engage stakeholders in an exploration of possible alternative future economic development (①²), considering a large number of economic, regulatory, social, and environmental factors of change. The output of this task consists of one or several scenarios characterized by assumptions in terms of land use, economic production, demographic growth, etc. Deterministic forecasting models are then used to estimate sector-level long-term water demands associated with the scenarios considered (②). Participatory approaches have also been used to identify and evaluate the local suitability of a range of adaptation measures (③). Systematic and complete information on the cost and effectiveness of measures has then to be gathered, integrating expert criteria where needed (④). Herein, effectiveness is initially defined based solely on the impact of the measures on the system pressures (the real assessment of the measures' effectiveness will come after the application of the hydrological and water management models).

The top-down approach starts by choosing one or several climate projections, defined as the simulated response of the climate system to a scenario of future emission or concentration of greenhouse gases and aerosols, generally derived using climate models. To account for uncertainty in the projected scenarios, several projections can be used, considering one or more emission scenarios and several Global Circulation Models. These climate projections are then downscaled (⑤) to construct local climate change projections. These local climate data are used as input to hydrological rainfall-runoff models (⑥) to obtain future inflow time series that enable simulation of the impact on the available resources. The local climate projections are also the input for the agro-climatic models (⑦).

² Hereinafter, the black-circled numbers make reference to the corresponding part of Figure 3-1.

The two approaches meet and feed each other through the development of an integrated water resources management model to support the definition of a programme of measures to adapt to global change ⑦. To address the uncertainty of the global change scenarios, we then evaluate how robust water management plans are in relation to the uncertain future ⑧. The performance of adaptation programmes of measures is assessed across a range of different climate projections (climate check), and then compared by applying a multi-criteria decision-making approach.

Finally, we test two approaches for defining an equitable allocation of the cost of the programme of measures ⑨. The first approach mobilized concepts and methods from cooperative game theory, whereas the second is inspired by the literature on social justice. We now describe the different components of this methodological framework.

3.2 Top-down impact assessment

3.2.1 Emission scenario and general climate models

The first step of the top-down approach consists in defining climate change projections for the case study area. We used climate projections downscaled from 9 General Climate Models in order to address the uncertainty of these projections. The GCMs belong to the wider set of GCM outputs available in the framework of the CMIP3 experiment (Meehl et al., 2007), considered as able to capture both regional precipitation and temperature climatology for the Mediterranean region (Mariotti et al., 2008). The GCMs are forced by one greenhouse gases emission scenario (A1B), considered as an average emission scenario among the various possible futures (IPCC, 2007). This emission scenario is similar to the new Representative Concentration Pathways (RCP) 6.0 used in the 2013 IPCC 5th assessment report, which were not available at the beginning of the study.

3.2.2 Downscaling techniques

The downscaled projections used to assess the impact of the future climate on the water resources and agricultural demand have been produced by CERFACS (European centre for research and advance formation in scientific calculation), within the SCRATCH project in 2010 (www.cerfacs.fr/~page/work/scratch) (5) in Figure 3-1). This project aimed at disaggregating the output from climate models following a statistical method based on the concept of “weather type” (Boé and Terray, 2008). The weather-type downscaling technique used here statistically links the large-scale circulation (predictor variables) and the local-scale climate variables to disaggregate the output from coarse spatial resolution climate models of both temperature and precipitation (DSCLIM: Pagé and Terray, 2010, more details in Appendix B Downscaling). It provides climate data (precipitation and Potential Evapotranspiration, PET) for the control period defined from 01/01/1971 to 31/12/2000, and the future period from 01/01/2046 to the 31/12/2065. The climate data are provided on a daily time step with a spatial resolution of 8 km that fits the grid of the SAFRAN historical local meteorological data set (Quintana-Seguí et al., 2008), since it is used in the learning phase of the downscaling technique.

3.2.3 Hydrological modelling

The next step of the top-down approach consisted in implementing a hydrological model to assess the impact of future climate conditions on the water resources of the river basin under study (Leavesley, 1994; Praskievicz and Chang, 2009). The hydrological modelling process (6) follows a three-step approach applied at the sub-basin level. The first step was to reconstruct the natural flow regime of each sub-basin (without the influence of reservoir releases and users withdrawals) on the basis of the available monthly river discharges data at the observed hydrological stations. Then, in order to select the most appropriate rainfall-runoff model, the monthly lumped two-parameter rainfall-runoff GR2M model (Mouelhi, et al. 2006) and the four-parameter TEMEZ model commonly used in Spain (TEMEZ,

1977) were tested, with a conclusion that revealed the close performance of the two approaches (Berthomieu, 2012³). As the GR2M model seems to perform slightly better in the various indicators analysed and requires less parameters, it has finally been implemented (see Appendix C Hydrology). The GR2M model has been calibrated and validated using historic precipitation, PET and discharge data for each sub-basin.

The GR2M model (Mouelhi et al., 2006) was developed by the IRSTEA, (French research centre for environmental and agricultural science and technology, former CEMAGREF) to simplify a previous four-parameter daily model. It has been used in more than 410 basins representing a wide range of climates from semi-arid to tropical humid. It has shown efficiency and valuable insight in comparison with several well-known models at a monthly time step, especially for the reservoir management and long-term drought forecasting. Given its simplicity and robustness, as well as its free access, this monthly model fits our requirements. (See further description of the GR2M model in Appendix C Hydrology).

3.3 Bottom-up evaluation of demand scenarios and adaptation measures

This part of the approach is greatly inspired by the literature that uses scenario analysis to determine adaptation options in natural resource management problems, in considering the uncertainty attached to future evolution (Hatzilacou et al., 2007; Berkhout et al., 2002; March et al., 2012; Alcamo et al., 2007; Rinaudo et al., 2013a; Faysse et al., 2014). Participatory foresight and demand forecasting models were combined to anticipate future water stress levels, setting the ground for a discussion on required adaptation measures. Having acknowledged the limitations of deterministic forecasting techniques, it was decided to elicit the stakeholders' visions of alternative possible futures (exploratory approach) before trying to create a consensus on the most likely outcome at the 2030 time horizon.

³ This comparison was realized in a supervised internship during the current thesis.

The 2030 time horizon was chosen as a compromise between the time horizon used by climate scientists (2045-2060) and the time horizon that makes sense for most stakeholders when considering future scenarios (15-20 years) and planning at the local level.

3.3.1 The participatory process

The selection of stakeholders involved in the participatory process was based on four main criteria inspired by a previous analysis of interests at stake and existing conflicts in the area (Garin, et al., 2002; Rinaudo and Garin, 2005) and by the analysis of a recent public debate over the construction of a large inter-basin transfer, which took place between September and December 2011 (Rinaudo and Barraque, 2015). These criteria are the following ones:

- 1) level of expertise and ability to contribute to the development of future scenario (envisioning capacity);
- 2) involvement in the design or implementation of the main water policy issues;
- 3) type of organization they represent, including private actors (or representatives thereof), government agencies, regional and county councils, watershed councils;
- 4) position in the current debate, opposing proponents of a water resource development policy with those of a limited growth and water conservation policy.

3.3.2 Defining future agricultural demand scenario

Stakeholders were first involved in the construction of 2030 agricultural water demand scenarios (❶). The agricultural water use scenarios were developed in two steps using a methodology developed in a different case study (Rinaudo et al., 2013a). First, semi-structured interviews were conducted with the stakeholders and a few additional experts. This enabled the identification of factors likely to determine future water demand (drivers) and the quantification of possible trends associated with these drivers. Information collected during the interviews was

compiled and presented to stakeholders, who debated and collectively chose the quantitative assumptions (trends) to be incorporated into the scenario finally selected.

Then, an agro-climatic crop water requirement model, based on Allen et al. (1998), was developed to assess future water demand associated with the agricultural scenario developed ②. The model simulates the impact of climate change on irrigation demand for the climate projection of the 9 GCMs (Hoang et al., 2012). It calculates Agricultural Water Demand (AWD) with a 10-day time step (Eq. 3.1). Inter-annual monthly average demands are estimated for the baseline and future periods. For each irrigation district (i), the model calculates the Crop Water Requirement (CWR) of crop (j) associated with an irrigated area ($A_{i,j}$). CWR is a function of the meteorological variables (PET_i and P_i present and future), available soil moisture (SM_i), and a crop coefficient (Kc_j). AWD is then estimated for each irrigation district as the product of crop water requirements and an irrigation efficiency parameter ($E_{i,j}$), which depicts the distribution and field irrigation techniques in each irrigation district i and associated water losses (see Appendix D Agricultural demand).

$$AWD_{i,t} = \sum_j E_{i,j} \times A_{i,j} \times (ETP_{i,t} \times Kc_{j,t} - P_{i,t} - SM_{i,t}) \quad \forall i, t \quad (\text{Eq. 3.1})$$

3.3.3 Defining future urban demand scenario

Concerning future urban demand, since there was lower uncertainty associated with the future trends of the major drivers considered at the 2030 time horizon (demographic growth, water pricing policy, reduction of leakages in municipal networks, etc.), the scenario was developed by the research team and only validated by stakeholders during a meeting. The scenario was based on an in-depth analysis of past and present demographic and housing trends, on forecasts made by the National Institute for Statistical Studies (INSEE, France) and on interviews with urban planning experts.

Subsequently, these assumptions were used to estimate future urban water demand at the municipal level considered as Urban Demand Units (UDU), using an

econometric model (Rinaudo et al., 2012) combined with a population and property forecast model based on regional statistical data (Vernier and Rinaudo, 2012). The model allowed the adjustment of the domestic per capita consumption ratio to different explanatory variables in each UDU in the present period: the price of water, average household income, climatic conditions (see more details on Appendix E Urban demand). This permits the simulation of the impact of changes in the socioeconomic variables (water tariffs, income) agreed with stakeholders. The model calculates urban water demand for 2008 (Baseline) and 2030 (Future) planning horizons for all the UDU that abstract water from the water resources system during the annual and summer peak periods.

3.3.4 Selecting adaptation measures

After developing a socio-economic scenario depicting the most likely evolution of urban and agricultural water use in the basin at the 2030 time horizon, the stakeholders assisted the research team in screening a range of possible responses for coping with global change (③). A first catalogue of measures was elaborated by combining literature reviews (peer-review journals, technical reports, case study description, as well as planning documents), personal communication with local experts (water managers, local authorities), and submitted to the scrutiny of the stakeholders. Specific workshops were also organized to scrutinize urban water conservation measures, involving three types of stakeholders: members of the board of the river basin committee, representatives of the local authorities and general citizens. In addition to open discussion, each participant was asked to individually express his opinion on the relevance of each measure given their perception of the local issues at stake in the basin. This was followed by a group discussion to explain the arguments for and against each measure.

We mainly discussed planned adaptation measures defined as the result of a deliberate policy decision, based on an awareness that conditions have changed or are about to change and that actions are required to return, to maintain, or to achieve a desired state (IPCC, 2007). We consider that autonomous adaptation measures, defined as an adaptation in response to experienced climate and its

effects without planning explicitly or consciously focused on addressing climate change (also named spontaneous adaptation), (IPCC, 2014), are addressed and integrated in the development of the demand evolution scenarios. Where, for instance, the development of irrigation by the agricultural sector or the increase in water consumption due to climate change, or water savings due to technological changes in households, could be considered autonomous adaptation measures.

3.3.5 Economic and technical assessment of measures

The measures identified through the stakeholder consultation process were then characterized in terms of their cost and effectiveness (as volume of water saved or mobilized) for the different demand units of the basin (4). The calculations were made at the municipal level (Urban Demand Unit) for all urban water conservation measures, considering the heterogeneity of water users (type of houses, income) and water services (current tariffs, current level of leakage, etc.). Agricultural water conservation measures were evaluated at the irrigation district level (Agricultural demand Unit). Capacity expansion measures (groundwater exploitation, desalination) were assessed at the project level. Direct financial cost (investment, operation and maintenance) were used to estimate the annual equivalent cost considering the technical lifespan for the equipment, and a 4% discount rate as suggested by French national guidelines (CGP, 2005). Effectiveness was first assessed as the volume of water saved or added (capacity expansion) during the 4 months of the peak demand period (Rinaudo, et al., 2013c). All the measures were designed to potentially be implemented at the same time (mutually non-exclusive), except when it is technically infeasible (for instance, a change in irrigation technics, or the development of different levels of a groundwater project).

3.4 Integrating top-down and bottom-up approaches

3.4.1 Least-Cost River Basin Optimization Model

The integration of the bottom-up and top-down approaches is carried out through the development of an ad-hoc optimization river basin model (7). The model aims

to define a combination of the adaptation measures identified with stakeholders (bottom-up) in such a way that they would allow the water deficit resulting from climate change (top-down) and from economic change (bottom-up) to be bridged at the lowest possible cost at the river basin scale. Thus, this optimization model, hereinafter named the Least-Cost River Basin Optimization Model (LCRBOM), minimizes the cost of a programme of adaptation measures at the river basin scale (objective function), while meeting the management objective defined in terms of agricultural and urban demand to be supplied and in-stream environmental flow targets (constraints).

Following common approaches on the design of river basin management models, the sub-river basins are represented as a flow network of nodes (diversions and/or storage nodes), linked by arcs that represent canals and river reaches. The Urban Demand Units and Agricultural Demand Units of the river basin are connected to the node of the sub-basin from which water is abstracted, or to which it returns. At each node, constraints are imposed on demand targets, minimum environmental flow requirements, and reservoir operating rules. The optimization is carried out over a monthly flow time series, first on the baseline period (1971-2000) and then for the global (climate and demand) change scenarios corresponding to the future period (2046-2065). The model was developed using GAMS (General Algebraic Modelling System, (Rosenthal, 2012)) and by applying Mixed Integer Programming with the solver from the Cplex Callable Library from IBM ILOG CPLEX.

The objective function of the LCRBOM model (Eq. 3.2) minimizes the total annualized cost of the measures applied to meet urban and agricultural demands and minimum in-stream flow constraints, following the legal requirement⁴ in terms of allowed deficit. Measures are activated, or not, through binary variables to maintain the deficit in agricultural demand within these legal requirements (Eq. 3.3 and 3.4).

⁴ French legislation requires all demands to be fully supplied in at least 4 out of 5 years, giving priority to urban use and environmental requirements over agricultural use (MEEDDT, 2008). This allows a deficit in the supply of agricultural demand with a return period T of 5 years (5-year deficit).

$$\text{Minimize } \Pi = \Pi_C + M \times \Pi_D \quad (\text{Eq. 3.2})$$

With:

$$\Pi_C = \sum_m \text{Act}(m) \times \text{Cost}(m) + \sum_t \sum_m V(m, t) \times \text{VCost}(m) / N \quad (\text{Eq. 3.3})$$

$$\Pi_D = \sum_t \sum_a \text{Def}_{a,t}^{T^*} \quad (\text{Eq. 3.4})$$

where, M is a very large positive number that is higher than the sum of the cost of all the other measures; m is an index of the measures of urban or agricultural demand management, groundwater or desalination projects; t is the time step index (monthly); $\text{Act}(m)$ are binary activation variables of the measures m ; Cost is the fixed annual equivalent cost (€) of the measures, m ; V is the volume of water in Mm^3/month coming from the groundwater and desalination measures, respectively; VCost is the variable costs of the groundwater and desalination measures in € per Mm^3 per month; N is the total number of years of optimization; “ a ” is the index of the ADU, and $\text{Def}_{a,t}^{T^*}$ is the deficit for ADU “ a ” at month “ t ” with a return period T^* less than T , as defined in the next section (3.4.3).

The objective function equation is subject to a “mass balance” constraint at all nodes of the network and to capacity constraints at nodes and links. Deliveries for urban demands and environmental flow requirements are integrated in the model as hard constraints, whereas deliveries for the agricultural demands are defined as soft constraints with a penalization in the objective function when not met. The large number of artificial penalty (M) associated with the agricultural deficit is just a programming trick (with no real economic meaning) to ensure that the system fulfils the legal requirements on the reliability of supply and that measures will be applied prior to any deficit. (Additional equations are presented in Appendix H Least-cost river basin optimization model).

3.4.2 Scenario analysis through LCRBOM

The LCRBOM model is used to assess different scenarios (baseline, business-as-usual (BAU), and adaptation scenario (Table 3-1)) corresponding to different hypothesis on: (i) the agricultural and urban demands; (ii) the climate and corresponding hydrological flows and crop water requirement, and (iii) the possibility, or not, of implementing adaptation measures.

Scenario	Demand	Climate	Adaptation measures
Baseline	Present 2008	Present 1970/2000	Not applicable
Business-as-usual	Future 2030	Future 2046-2065	Not applicable
Adaptation scenarios	Future 2030	Future 2046-2065	Applicable

Table 3-1 Scenario characteristics

Assuming that the existing regulatory framework is maintained, deficits would mainly be borne by agriculture. Urban demand, legally defined as the use with the highest priority, would be satisfied first. After that, environmental flows should be guaranteed, while agriculture would only be authorized to use the remaining water available. The least-cost river basin optimization model was used to estimate the agricultural deficit in the different scenarios where no measures are applicable (baseline and BAU), integrating the demand and hydrological scenarios previously defined, but prohibiting the implementation of measures (introducing constraints ensuring that $\Pi_c=0$ in Eq. 3.2). Thus, the model minimizes agricultural deficit with a return period of less than 5 years with a monthly time step, by optimizing reservoir management and water allocation (decision variables) over the time horizon. Meanwhile, water allocation has to meet the environmental requirements and the target supplies for the urban demands, according to their priority.

3.4.3 Performance indicator

In the scenario with no adaptation measures, water deficits can appear due to a combination of high water demand and limited water resources. Various indicators exist to assess the performances of the water resources systems (Hashimoto et al., 1982; Loucks, 1997). In our case, to assess the deficit in supplying the agricultural demand, we adopted the Demand Reliability Index (DRI) (Martin-Carrasco et al., 2013), which quantifies the reliability of a system to satisfy demands, by computing the ratio between the demand satisfied for a given acceptable level of reliability and the total annual demand.

French legislation requires all demands to be fully supplied in at least 4 out of 5 years, giving priority to urban use and environmental requirements over agricultural use (MEEDDT, 2008). This allows a deficit in the supply of agricultural demand with a return period T of 5 years (5-year deficit). In other words, this corresponds to supplying the full agricultural annual demand with a level of monthly reliability (noted r) of 80 % ($r = (1-1/T) \times 100$). In accordance with this requirement, we also defined an Agricultural Deficit Index (ADI) to characterize the degree of failure of the system to meet this acceptable 5-year deficit. The ADI is the ratio between the maximum annual deficit that occurs with a return period T^* less than T equal to 5 years ($T^* < T = 5$) and the annual demand of a given ADU (Eq. 3.5). An ADI equal to 0 means that the system fulfils the legal requirements of having no more than a 5-year deficit; if this condition does not hold (ADI greater than 0 and up to 1), the index quantifies the magnitude of the greater than acceptable deficit in comparison to the annual demand.

$$ADI_{T^*}^a = (1 - S_{T^*}^a / Dem^a) \times 100 \quad (\text{Eq. 3.5})$$

Where $ADI_{T^*}^a$ is the Agricultural Deficit Index for the agricultural annual demand at the ADU "a" associated with a return period T^* lower than the acceptable value T ; $S_{T^*}^a$ is the minimum annual water supplied to the ADU "a" in Mm^3 per year, with a return period T^* ; Dem^a is the annual demand at the ADU "a", in Mm^3 per year.

3.5 Climate check

Due to the uncertainty associated with climate modelling; different programmes of adaptation measures can be designed depending on the climate change projections we consider. In our case, we used $n=9$ climate projections; we thus can estimate 9 different adaptation Programmes of Measures or PoM (PoM 1 to PoM9). To evaluate how robust each PoM is in relation to these uncertain climate projections **⑧**, we then assess how the system would perform for each of them, but under alternative climate projections, different from the one the PoM has been designed for. Thus, we obtain a matrix of the performances of each PoM against each climate projection (performance matrix). The level of performance of each PoM under the different climate projections has to be contrasted with the cost of a given PoM. A high cost PoM could ensure better performance under a greater diversity of climate projections. However, it may not be worth making such an investment if the projections are not realized. There is a risk of over-design (“gold-plating”) the PoM. Thus, performance under various climate projections and cost of PoM are then compared by applying a multi-criteria decision-making approach (Srdjevic, et al. 2004; Huang, et al. 2011). We adapted the TOPSIS (Technique for Order Performance by Similarity to Ideal Solution) approach to identify the least-regret adaptation PoM. TOPSIS is a simple multi-criteria analysis method that has already been applied in many contexts (Hwang and Yoon, 1981; Huang et al., 2011) aiming to minimize the distance to the ideal alternative and maximizing the distance from the worst one. It follows a three-step process. First, performances are calculated for each PoM and evaluation criteria in order to create a performance matrix; then, relative performance indices (regret) are computed based on their distance from the best and the worst solutions; finally, weights are defined for each criteria to calculate an indicator of the overall regret in the selection of the Programme of Measures.

3.5.1 Performance matrix

Using the LCRBOM, we assess two types of performance indicators in connection with each PoM: the cost of adaptation, previously obtained for a fixed set of

measures, and the DRI index calculated for the PoM under a given climate projection at the river basin scale. From a general point of view, if n is the number of climate change projections and m the number of criteria for the evaluation of the performance of a PoM, a performance matrix, $P = [x_{ij}]$, can be defined as (Eq. 3.6)

$$P = \begin{pmatrix} \text{PoM}_1 \\ \vdots \\ \text{PoM}_n \end{pmatrix} \begin{pmatrix} w_1 & \cdots & w_{m-1} & w_m \\ x_{11} & \cdots & x_{1m-1} & x_{1m} \\ \vdots & \ddots & \vdots & \vdots \\ x_{n1} & \cdots & x_{nm-1} & x_{nm} \end{pmatrix} \quad (\text{Eq.3.6})$$

Where, in our case study, the number of PoMs to evaluate corresponds to the n climate change projections ($\text{PoM}_1, \text{PoM}_2, \dots, \text{PoM}_n$); the performance criteria, x_{i1} to x_{im-1} , corresponds to the agricultural demand reliability index calculated for each climate projection, and the last x_{im} criteria is the cost of the evaluated PoM. The weights (w_1, \dots, w_m) correspond to each of the m performance criteria, as defined in section 3.4.3.

3.5.2 Regret matrix

The regret matrix, $R = (r_{ij})$, is derived from the performance matrix by calculating regret indices r_{ij} (relative normalized performance index). Each regret index quantifies how much each performance (x_{ij}) of a PoM_i deviates from the best performance of the j criteria (x_j^*). To compare performance criteria that do not have commensurable units, the performance indices are normalized (Eq. 3.7).

$$r_{ij} = |x_j^* - x_{ij}| / |x'_j - x_j^*|, \quad (\text{Eq. 3.7})$$

Where x'_j is the worst performance for each criteria. The higher the index value, the more the performance deviates from the best one, which has an index of 0.

3.5.3 Preferences and weights for ranking

The preferences over the regret on the different performance indicators are captured through the weight associated with each of them in the calculation of a final aggregated regret indicator. The value of the weights associated with each criterion can be defined by stakeholders, expert judgment or information theory

methods (Srdjevic, et al. 2004). As a starting point, the weights of each agricultural DRI under a climate change projection ($x_{i1}, x_{i2}, \dots, x_{im-1}$) are stated as equal (Eq. 3.8).

$$w_k = w_j, \forall k, j \text{ from } 1 \text{ to } m - 1 \quad (\text{Eq. 3.8})$$

Then, two situations can be considered: first, it can be decided, arbitrarily in the first step, to assign the same weight to the agricultural demand reliability (DRI) and to the cost of the PoM (i.e., the sum of the weight of the agricultural DRI is equal to the weight for the cost of the PoM, w_m). The sum of all the weights must be equal to 1 (Eq. 3.9). Solving equations 3 and 4 gives the weight $w_m = 1/2$; and $w_j = 1/18 = (1/2) \times (1/9)$ for $i = 1$ to n .

$$\sum_{j=1}^{m-1} w_j = w_m ; \sum_{j=1}^{m-1} w_j + w_m = 1 ; w_j > 0 ; w_m > 0 \quad (\text{Eq. 3.9})$$

Alternatively, different values could be assigned to the agricultural and cost weights, in order to reflect the potential preferences of the stakeholders. This was done by defining, firstly, that $w_m=1/4$ and $\sum_{j=1}^{m-1} w_j = \frac{3}{4}$ to give more importance to the agricultural DRI and, subsequently, that $w_m=3/4$ and $\sum_{j=1}^{m-1} w_j = 1/4$ to give more importance to the cost criteria.

Aggregated regret indicators (R_i) are finally calculated as the sum of the weighted regrets, in order to rank the PoMs by increasing order (Eq. 3.10) to identify the least-regret solution.

$$R_i = \sum_{j=1}^m w_j \times r_{ij} \quad \forall i \text{ from } 1 \text{ to } n \quad (\text{Eq. 3.10})$$

3.6 Addressing the cost allocation issue

At this point, we have looked at the definition of a programme of adaptation measures from the point of view of a central planner, whose objective is to maximize social welfare (or minimize cost). Indeed, the least-cost adaptation plan aims to take advantage of upstream/downstream interactions and ensure cost-effectiveness at the river basin scale. We assumed that the central planner would be able to implement the least-cost PoM.

However, in reality, adaptation measures are implemented and financed by a number of actors depending on the water resources of the river basin. These actors can be located at different places upstream or downstream, and inside or outside the river basin (if water transfers are considered). The implementation of the measures requires active participation from irrigation associations, drinking water utilities, municipalities and other local or regional governments. These actors will only agree to implement the measures included in the optimal PoM if they consider that the effort (in terms of cost) is “fairly” or “equitably” shared among the different actors of the basin.

3.6.1 Two approaches to define cost allocation scenarios

From an operational perspective, defining a cost allocation **9** can be addressed by using two different approaches. The first consists in organizing a negotiation process through which stakeholders will try among themselves to identify the financial transfers that are required for all parties to agree to implement the measures of the least-cost PoM. The objective is to help the actors involved in the negotiation to identify win-win situations. Therefore, the central planner will ensure that the allocation decided by the different users in a unanimous agreement will be legally enforced (a binding agreement). The negotiated solution can be investigated using cooperative game theory to identify the possibility for cooperation (coalition formation) and to define possible cost allocation or side payment required, considering the cost allocation game as a transferable utility game. This is the first approach we investigate.

The second approach adopts a different perspective. It consists in constructing, through social dialogue, an empirical cost allocation rule that is considered fair and equitable by the stakeholders involved, by considering the prevailing social, ethical and philosophical values of the society. This approach assumes that stakeholders do not only judge the acceptability of allocation scenarios based on monetary criteria of the costs and benefits for themselves, but may also consider wider social preferences (altruism, solidarity) included in their social justice principles.

3.6.2 Cooperative game theory

A first approach considers the definition of a cost allocation among the stakeholders of a river basin as a negotiation between the stakeholders on a compensation mechanism based on monetary transfers to ensure cooperation. Without any cooperation, each actor of a sub-basin (A, B or C in Figure 3-2) should implement measures to reach its own objectives in terms of water supply and environmental flows in its sub-basin. However, this would not be cost-effective at the river basin level. On the contrary, if A, B and C cooperate, they could implement a more cost-effective solution at the river basin scale. However, they would need to agree on the allocation of the final cost among them, and define financial transfer if needed, to ensure that everyone benefits from cooperating. This is the approach we investigate through the use of cooperative game theory.

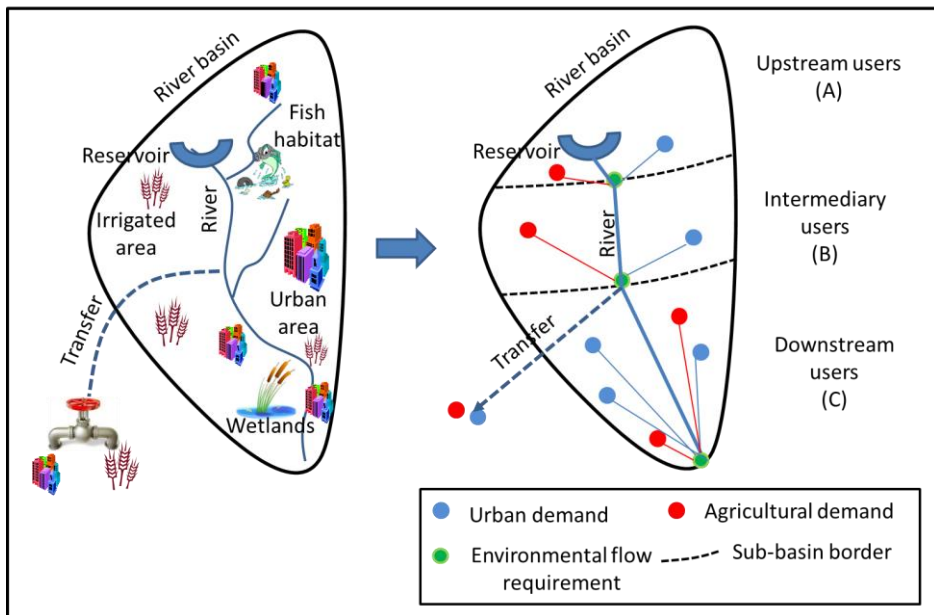

Figure 3–2 Conceptual representation of a river basin

Cooperative game theory, also named coalitional game theory, focuses on groups (coalition) more than on individual decisions, unlike the conventional non-cooperative game theory. Under the transferable utility assumption, it provides a

framework to investigate possible coalition formation and to allocate the payoffs of these coalitions among their members (benefits or cost savings, including the possibility of side payments defined as monetary transfers), (Leyton-Brown, 2008).

As the monetary transfers are not uniquely determined, the boundaries of an acceptable solution space can be defined by taking into account criteria of equity. Axiomatic principles coming from the cooperative game theory literature can define this solution space (the Core of the cooperative game). Solution concepts (Shapley value and Nucleolus) then estimate possible cost allocation solutions determining the monetary transfer between the agents.

The definition of cooperative game theory solutions requires the estimation of the cost associated with each possible coalition, what is called the characteristic function of the game. The different coalitions and the action that each player considered in our representation of the river basin can take are described in Table 3-2. The first line corresponds to the case where all players follow a stand-alone strategy benefitting only from their own water management measures and paying their own costs. The bottom line corresponds to the grand coalition, where the three players are playing together, sharing the costs and effects of the measures.

The least-cost river basin optimization model, described in the previous section (3.4), is then used to assess the cost associated with each coalition or stand-alone strategy. The objective function is modified so that each coalition minimizes the cost of its own programme of measures to avoid deficits for its water users and ensure the minimum environmental flow at the outlet of its part of the river basin. The first line corresponds to a sequential optimization from the upstream to the downstream users: the upstream users A optimize the management of their sub-basin, then B users optimize their programme of measures accounting for the measures implemented by A but without any possibility of modifying them, and C comes at the end, assuming the measures applied in A and B as given. Then, in the following cases, when a player is not in the coalition, he follows his stand-alone strategy (applying the measures needed only to supply his demand without deficit). The grand coalition combines the three player actions, to minimize the deficit at the full river basin scale. The priorities in the management of infrastructure (reservoir)

are taken into account in the optimization to supply the users. For instance, if B has a priority on the management of the reservoir, the reservoir is optimized first to supply B, then C and A.

Optimization problem to be solved			
Coalition	A	B	C
A,B,C stand-alone	Min C(A)	Min C(B)	Min C(C)
AB,C	Min C(A+B)		Min C(C)
AC,B	Min C(A+C)	Min C(B)	Min C(A+C)
A,BC	Min C(A)	Min C(B+C)	
ABC (Grand coalition)	Min C(A+B+C)		

Table 3-2 Description of the characteristic function of a three-player game

The core of the game identifies a solution space made of cost allocation scenarios following different economic principles (rationality, marginality, efficiency). The rationality principle implies that no player, or coalition, should pay more than he would have to pay on his own. Thus, it takes into account that the minimum incentive to join a coalition is to have something to win. This means that for each collation S made by a player i, an allocation of cost y_i must be lower than the cost of going alone c. N being the total number of players (Eq. 3.11).

$$\sum_{i \in S} y_i \leq c(S) \quad \forall S \in N \tag{Eq. 3.11}$$

The marginality principle (marginal individual cost coverage) states that no player or coalition should pay less than the marginal cost of including him in the project (Eq. 3.12).

$$\sum_S y_i \geq c(N) - c(N - S) \quad \forall S \in N \tag{Eq. 3.12}$$

Finally, the principle of efficiency states that all costs have to be met by the members of the coalition (Eq. 3.13).

$$\sum_N y_i \geq c(N) \tag{Eq. 3.13}$$

The Core of the game is the set of vector y (y_i) satisfying the previous set of constraints. The core definition does not provide a unique answer, but can be

considered as a guideline to solve the cost allocation problem ensuring the cooperation of all players in a grand coalition. Different solution concepts have been developed to reach a unique cost allocation among the members of the coalition.

The Shapley value (Shapley, 1953) allocates the cost of a grand coalition to its members following their average marginal contributions. The Shapley value is calculated by averaging the marginal contribution of a player by all the different sequences according to which they can join the grand coalition. If the Shapley value ensures that some principle are respected, such as no cost savings are attributed to dummy players not contributing to improving the results of the cost allocation, it does not ensure that the cost allocation is within the core (Eq. 3.14).

$$y_i = \sum_{s=1}^n \frac{(s-1)!(n-s)!}{n!} \sum [c(S) - c(S - i)] \quad (\text{Eq. 3.14})$$

Where: $c(S-i)$ represent the cost of the collation S without member i, $c(S) - c(S-i)$ being the marginal contribution of i to the coalition S.

The Nucleolus (Schmeidler, 1969) is another solution concept that ensures a unique solution. If the core is not empty the solution is within the core, otherwise it can be interpreted as the way to define an incentive to some players or coalitions to join the grand coalition by paying them a uniform amount (ε). The smallest amount required for the cost allocation to be in the core is named the Nucleolus. It can be computed by solving the following linear program (Eq. 3.15, 3.16):

Min ε

Subject to:

$$\sum_{i \in S} y_i \leq C(S) + \varepsilon \quad (\text{Eq. 3.15})$$

$$\sum_{i \in N} y_i = C(N) \quad (\text{Eq. 3.16})$$

3.6.3 Social justice approach

The alternative approach consists in assuming that the allocation of the cost of the programme of measures is a problem of distributive justice. Distributive justice refers to the allocation of resources, incomes or taxes and the way we define what is a fair access to a resource or a fair contribution to a common effort. The social justice approach assumes that the acceptability of an allocation of natural resources depends on an agents' conception of social justice (Neal, et al., 2014). The notion of distributive justice can refer to very different interpretations and philosophical principles (Lamont and Favor, 2012) such as strict egalitarianism (Nielsen, 1979), the difference principle and equality of opportunity (Rawls, 1971), the desert-based principle (Sadurski, 1985), welfare-based principles (Mill, 1861) and libertarian principles (Nozic, 1974):

- According to the “prior appropriation” principles of justice, people who first use the resource are entitled to keep it (entitlements) provided they do not violate the rights of others. Applied to cost allocation problem as discussed in this paper, this philosophy means that the cost of managing water scarcity should be attributed to recent water users, who contributed to creating the water scarcity problem.
- Strict egalitarianism assumes that people are morally equal, and that equality in material goods and services is the best way to give effect to this moral ideal (Lamont and Favor, 2012). Applied to a cost allocation problem, this means that all water users in a basin should bear an equal share of management cost, irrespective of their water use.
- The difference principle assumes that inequalities in the distribution of resources and costs are acceptable if they improve the situation of the worst-off in the society, whereas the “equality of opportunity” principle aims at attenuating inherited sources of inequalities (gender, race, etc.). This could support the idea that users located in poor remote rural areas should bear a smaller share of the cost than rich urban areas, for example.
- The “desert principle” assumes that resources should be allocated considering the socially valuable efforts (i.e. leading to the production of

goods and services desired by others) made by each individual. In the case of water management, this would support the idea that efficient users (e.g. municipalities where losses in distribution networks are small) should be privileged in the cost allocation process in comparison with less efficient municipalities.

- Welfare-based principles of justice assume that the allocation of cost and resources should maximize social welfare, defined as the sum of individual satisfied preferences, and frequently interpreted in terms of economic wealth (utilitarian approach).

To consider the allocation of the cost of a programme of measures from the perspective of social justice, these general principles need to be translated to the local context. In the method developed inspired by Moreau, et al. (2013, 2015), a limited number of philosophies of justice have been identified and transposed into plausible scenarios adapted to the cost allocation problem in the case study area, based on a grey literature review (planning documents, technical reports, peer-review journals and case study description), and discussion with local experts (local authorities, water managers). Then, these scenarios are presented through face-to-face semi-structured interviews with local key informants. Following a description of the local context of adaptation to climate change in the river basin and the measures needed, the different allocation scenarios are presented and the local key informants are asked to define if the scenario is equitable or not. The cost allocations corresponding to different social justice principles are then quantified, based on the results of the hydro economic model to be discussed, with the results from cooperative game theory.

The two approaches applied in parallel, cooperative game theory and social justice, should theoretically not lead to the same result, given that they rely on fundamentally different assumptions concerning how stakeholders' decisions are made. However, from their comparison we expect to learn just how different or similar the results are, and to what extent they can reflect some of the positions in the debate that occurs in a real case study.

Chapter 4 Case study: The Orb River basin

The framework combining top-down and bottom-up approaches to define a cost-effective and equitable programme of adaptation measures was implemented in the Orb River basin. This is a Mediterranean basin located in Southern France, where global change is expected to exacerbate the imbalance between available water resources and increasing water demands. The Orb River basin is relatively small in extension (1580 km², Figure 4–1), but is at the heart of local and regional water management issues. This basin is representative of river basins of the Northern rim of the Mediterranean Sea, where water scarcity is an emerging issue. Managers are increasingly aware of the fact that water management strategy and practices will need to evolve to cope with the effects of climate change and increasing water demands in the coming 20 or 30 years.

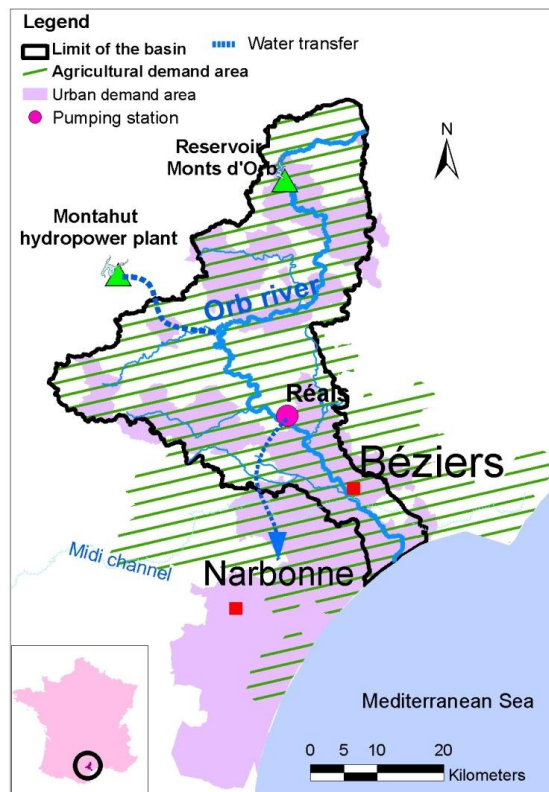

Figure 4–1 General map of the Orb River basin

This chapter presents successively the hydrology of the Orb River basin (4.1) and the main hydraulic infrastructures present in the area (4.2). The main consumptive water users are introduced (4.3), to characterize the determinants of urban and agricultural water demands. The environmental features of the basin are described in (4.4), before concluding with a description of the water planning and management context in the basin (4.5).

4.1 Hydrology of the Orb River basin

The Orb River basin is located on the western side of the French Hérault County (“department”), in the south of France, on the Mediterranean coast. From the spring in the limestone plateau of the Larzac at 886 masl to the estuary in the Mediterranean Sea at Valras-Plage, the Orb River is 125 km long. Its river basin of 1580 km² receives water from the following tributaries (upstream to downstream): the Mare, the Jaur, the Vernazobre, the Taurou and the Lirou, representing altogether 40 % of the total area of the river basin (Figure 4–2). The annual average natural flow is 850 Mm³. Its flow regime is characteristic of Mediterranean rivers, with great variations between very low summer flows and high autumn flows. The highest flows and flash floods occur from September to December during intense rainfall events, known as “épisodes Cevenols” (Figure 4–3).

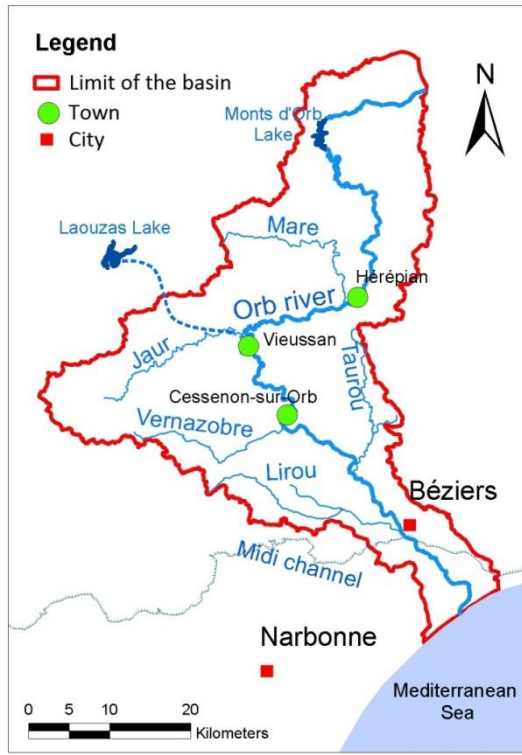

Figure 4–2 Map of the Orb River and its tributaries

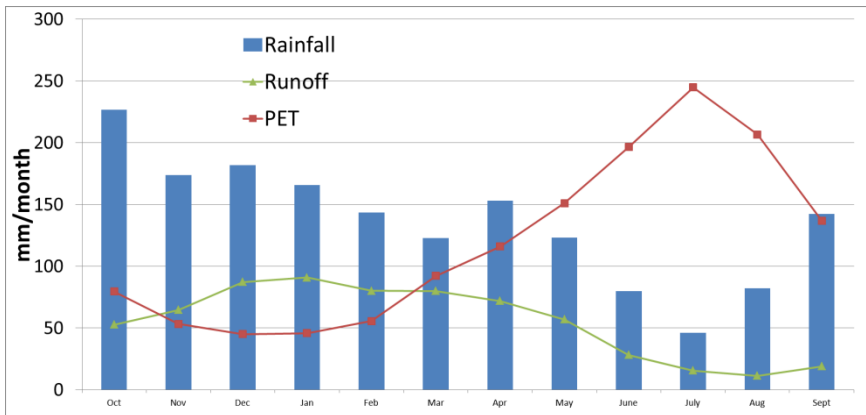

Figure 4–3 Monthly natural flow of the Orb River (1968–2007)

The Orb River basin can be divided in two sub-basins. The upstream part, from its spring to the town of Cessenon-sur-Orb (Figure 4–2), represents the biggest part of basin with almost the 2/3 of the total area. These sub-basins are composed of a mix of geological components with a majority of schist and crystalline basement representing 60% of the area, and about 40% of limestone formation. It benefits from an average annual rainfall of 1200 mm, ranging from 1800 mm on the upstream mountains to 700 mm at Cessenon-sur-Orb. This upstream part is the most productive in terms of flow due to the abundant rainfall and the presence of karsts in the Jurassic limestone providing most of the flow during the summer period.

The downstream part of the Orb River basin is mainly composed of tertiary sediments, the alluvial aquifer of the Orb River. Its average rainfall is clearly lower than the upstream part with an annual average precipitation of 700 mm, the minimum being met along the coast, with 570 mm.

In the future, the impact of climate change is expected to again increase the pressure on the Orb water resources. The last assessment realized using CMIP5 (Coupled Model Intercomparison Project) scenario ensembles (Taylor et al., 2012; Terray and Boé, 2013) showed that projections for the near-future (2020-2049) over the French Mediterranean rim, lead to a warmer climate compared to present (temperature increase greater than 1.5°C). While more uncertain, a summer precipitation decrease is projected, together with an increase of extreme precipitation in autumn. In the Orb River basin, a + 10 to - 55 % decrease in average inter-annual flow is forecasted in a mid-term horizon (2050-2070), (Chazot, et al., 2012).

4.2 Water management infrastructure

4.2.1 The Monts d'Orb reservoir

The Orb River is mainly influenced by the releases of the Monts d'Orb reservoir (storage capacity of 30.6 Mm³, Figure 4–4). Built by the French state, in 1964, as part of a wider project to develop touristic and agricultural activities along the

Mediterranean coastline, it is the cornerstone of a more complex system composed of pumping stations (the main one being located at Réals) and piped distribution network. These pumping stations supply more than 12,000 hectares of irrigated agriculture, and more than 150,000 inhabitants in summer, in part of the Orb basin and down to the neighbouring Aude county coastline. Therefore, the first objective of building a reservoir was to compensate these water abstractions in summer. Since 1975, the reservoir has also been producing electricity through a micro-hydropower plant with a maximum capacity of 3.2 m³/s. Protection against floods, even though this was not defined as an original function of the reservoir, has always been taken into account by the manager, who maintained a volume of 10 Mm³ during September and October for this purpose.



Figure 4–4 View of the Monts d'Orb reservoir

The reservoir is located at 15km from the spring of the Orb River and therefore influences 90% of the total river length. However, the reservoir controls only 8% (125 km²) of the total area of the river basin. In the annual average, the river basin controlled by the reservoir represents 18% of the natural inflows of the total river basin, with high variations during flood events. The average annual inflow in the reservoir from 1964 to 2007 is estimated to be 110 Mm³. The variations of the volume of the reservoir are presented in Figure 4–5 (the 10-year cycle of emptying for maintenance appears clearly).

The reservoir is known to have an important influence on the upstream flow regime of the river basin. One of the management objectives is to maintain a minimum

low-flow of 2 m³/s downstream of the Réals water abstractions. Its summer releases also ensure that the low-flows of the Orb River are twice as high as flows during dry years would be without regulation (Chazot, 2011).

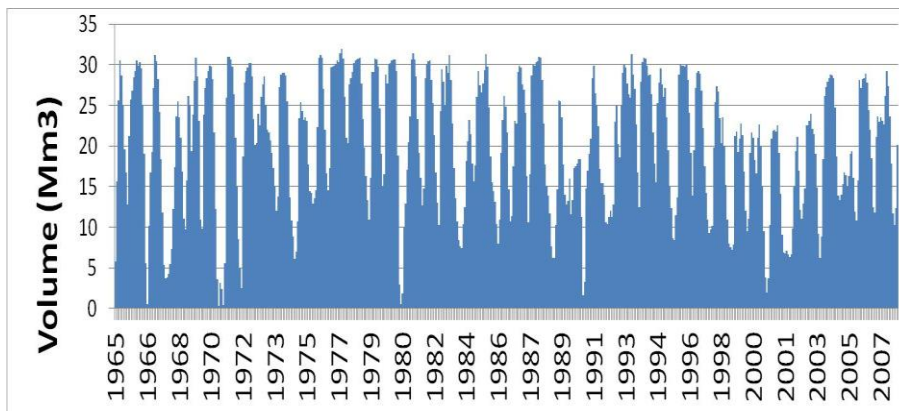

Figure 4–5 Time series of monthly storage in the Monts d'Orb reservoir (1965- 2007)

4.2.2 The BRL Company and the regional infrastructure

This reservoir is managed by a regional company, the BRL Company (company for the development of the Bas-Rhône and Languedoc, the region located on the west side of the Rhône river estuary). The BRL Company is not only in charge of the management of the Monts d'Orb reservoir, but also the Réals pumping station and pipe network associated with the transfer of water from the Orb River. The BRL Company manages other regional hydraulic infrastructures, such as a water transfer from the Rhône River or various reservoirs in the region to support regional planning and development projects. The company is now a public-private partnership controlled by the regional authority to run the infrastructures until at least 2051.

The BRL company manages the Réals pumping station to supply water to municipalities of the coastline and to secure the water supply of the Narbonne urban area in the neighbouring county (150,000 inhabitants in summer), and to supply a pressurized network for drip or aspersion irrigation of 12,000 hectares.

At the regional level, an ongoing project of regional water transfer named Aquadomia (the “via Domitia” was the roman road crossing the south of France) is under debate. The project was taken over by the regional authorities, after the city of Barcelona abandoned a bigger project to transfer water from the Rhone River to Catalonia (Spain) in favour of building a desalination plant. However, the project was still under public debate at the beginning of our work, and the allocation of the water and associated costs of the project among the different beneficiaries was one of the most debated issues in this debate (Ruf, 2015; Rinaudo and Barraque, 2015). Therefore, the full project has not been considered in this work. In a first period, the Orb basin is expected to export water through the Aquadomia project to the neighbouring areas, this option has been included in our analysis. We included an option of using desalinated water in the coastal area, which could be assimilated or substituted by the transfer coming from the Rhone River if the project is confirmed.

4.2.3 The Montahut hydropower plant

The Montahut hydropower plant is managed by the French national electric company (EDF). It is classified as being of national interest for energy production. Indeed, thanks to a waterfall of 623m and a raw power capacity of 120 MW it is used for peak production regulation of energy at the national level. Using an enclosed pipe (penstock), it transfers water from the Laouzas and Salvetat reservoirs (located on the Vèbre and the Agout rivers on the Atlantic side of the Cévennes mountains) into the Jaur River, a tributary of the Orb River. This transfer is significant as in the annual average it represents 20 % of the influenced inflow of the Orb River basin. However, the transfer mainly occurs in winter, when electric consumption increases. During the low flow period, the month of August is the month with the lowest release (Figure 4–6), corresponding to the possibility of stopping electricity production to perform maintenance during this month. During dry years, the summer discharges are reduced to the minimum, in order to maintain minimum environmental flow in the two Atlantic rivers mentioned previously. The inflows from Montahut produce high variations in the flow regime of the Orb River as they follow the peak in energy consumption. Therefore, this

reservoir cannot be considered as a complementary resource to ensure water resources management (for instance environmental flow) in the Orb River during drought periods (Vier and Aigoui, 2011; Chazot et al. 2011).

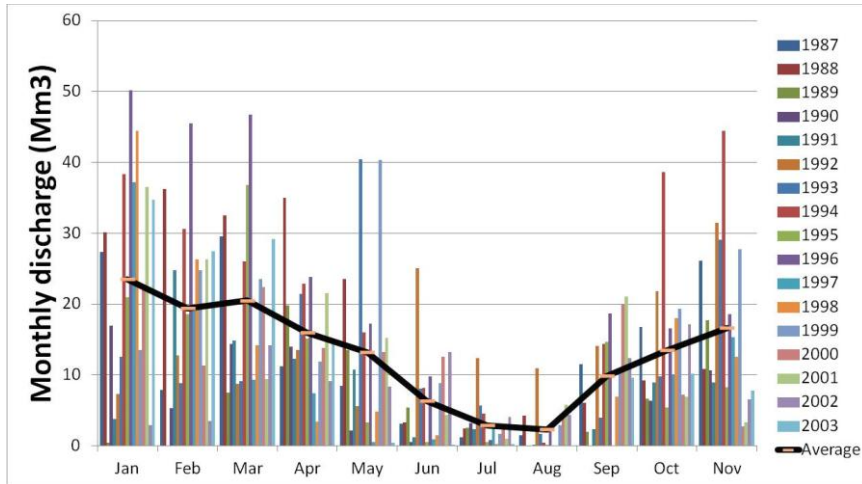

Figure 4–6 Monthly releases from the Montahut hydropower plant (adapted from Vier and Aigoui, 2011)

4.3 Consumptive uses (current situation)

The water resources of the Orb River basin qualify as regional resources, as the infrastructure developed allows them to supply irrigation and urban water demand both inside and outside the boundaries of the river basin. The characteristics of these consumptive uses are described in this section to identify the determinant of their water demand. In this thesis, the term water demand is usually used to refer to the common interpretation used by water resources engineers as the amount of water needed to meet the requirements of urban or agricultural water users.⁵

⁵ We acknowledge the difference with the definition of demand used by economists, who consider demand in terms of price or utility (assessed as the willingness to pay) for different quantities of water (demand function).

4.3.1 The urban water sector

The urban water sector in the Orb River basin aims mainly to supply water for the domestic water uses of the population. 233,000 permanent inhabitants are supplied by the resources of the Orb River in 2010, (SMVO, 2014). The distribution of the population over the study area is mainly separated between the upstream and the downstream area (Figure 4–7). Upstream, the population is more scattered, mainly in small villages of less than 2,000 inhabitants. Most of the population is concentrated downstream of the basin in the south-east, and outside the basin in the south-west area. These areas correspond respectively to the urban area around the city of Béziers (105,400 permanent inhabitants, 50 % more in summer) and the coastal area around Narbonne (up to 150,000 inhabitants in summer), where the highest urban demands are thus located.

The Orb River basin is located in Herault County, characterized by one of the highest population growths in France (1.4 %). Within the Orb River basin, two demographic zones are identified, each one being characterized by a different demographic growth trend. The coastal area has presented a high population growth since 1990, especially the towns located in the Aude County and around the main city of Béziers. Following a period of decline of the population during the 1990s, these areas now present a population growth rate of 1.6 % per year. The second part corresponds to the upstream area of the basin, where the population growth rate is lower (0.95 %).

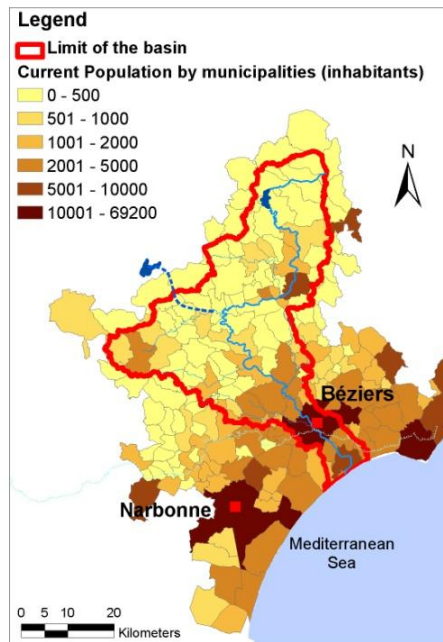

Figure 4–7 2008 Population in the Orb River basin

Given the attractiveness of the Mediterranean coastal area, numerous camping sites and hotels are present in the study area and represent a significant share of the economic activity of the region (200,000 beds, 20 % of the jobs in the area and €500M turnover per year, SMVO, 2014). The area is also characterized by an elevated number of secondary residences, mainly occupied during the summer time. The remaining uses of urban water are the municipal uses, composed of the water needed to water the public parks and green areas, and supply public infrastructure, and the water uses of small economic and industrial activities taking place in the river basin.

These urban water uses have different shares in the total urban water demand of the Orb River basin (Figure 4–8). The water required to supply domestic uses represents 40 % of the total urban water demand. Based on available data, the losses of the water supply distribution network were estimated at about one third of the total water demand of the urban water sector, with significant variation between the water supply utilities (Vernier, et al. 2012).

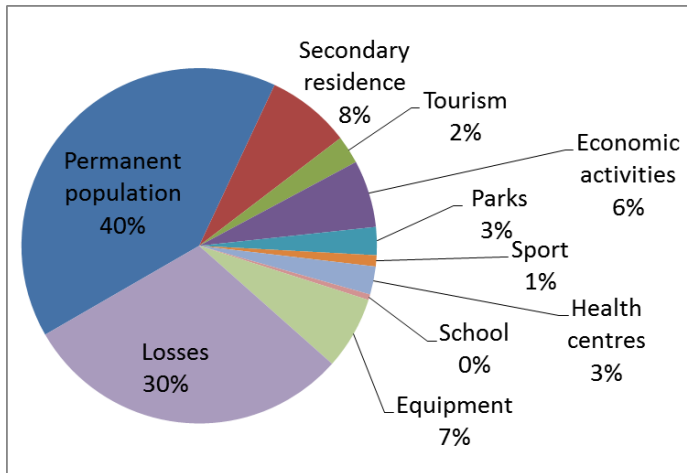

Figure 4–8 2008 Distribution of annual urban water demand in the Orb River basin (from Vernier, et al. 2012)

The way the water demand of the municipalities, considered as Urban Demand Units (UDU), has been estimated over the planning horizon, as well as the way these demands have been integrated in the general modelling framework is developed in the following chapters.

4.3.2 The irrigated agricultural sector

The territory of the Orb River basin is mainly rural, with significant agricultural activities (€113M per year turnover without subsidies, SMVO, 2014). Even though they are currently in transition following a decline over the last 30 years, agricultural activities, especially wine growing, are part of the historical activities of the territories supplied by the Orb River basin. One of the determinants of the restructuring of agricultural activities is the availability of water resources, to develop, for instance, irrigated vineyards. Until now, the Orb River basin has been characterized by three main types of irrigated agriculture⁶:

⁶ a more detailed description of the general agricultural sector in the study area is provided in Appendix D Agricultural demand

- Upstream on the hillside, where irrigated areas are small with mainly forage production, orchards and vineyards.
- An intermediary area dominated by the quality vineyard with famous AOC labels (Appellation of controlled origin, from Saint-Chinian and Faugère) and other vine production areas (Roquebrun and Berlou) (a7, a8, a11 in Figure 4–9).
- The downstream area, where the majority of the irrigated land is located, (Figure 4–9) featuring, in addition to vineyards, market gardening production (melon), large scale agriculture (cereals) and orchards.

In terms of irrigation techniques the same distribution appears. Upstream in the river basin, water is diverted from the Orb River through open channels (“Béals”) to supply gravity and aspersion irrigation on the field. Downstream, the pressurized piped networks managed by the BRL Company mainly supply the irrigation by aspersion and drip-irrigation. The vineyards are irrigated through drip irrigation most of the time.

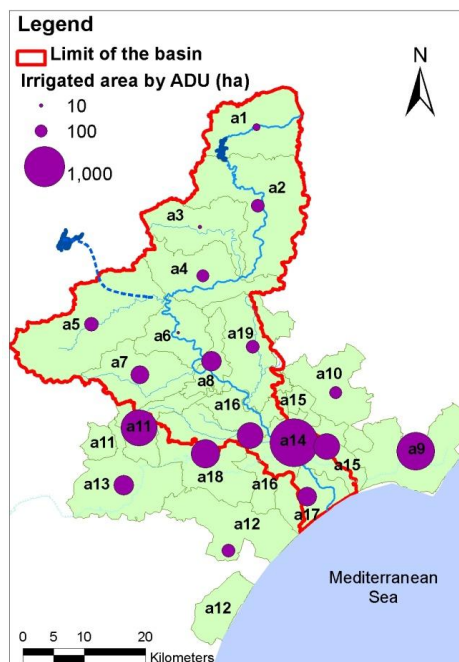

Figure 4–9 Current irrigated areas by Agricultural Demand Unit

The distribution of the irrigated areas shows the predominance of irrigated vineyards, representing 50 % of the total irrigated area (Figure 4–10). Historically famous for its intensive vine production, the agricultural sector is now in a conversion process towards the production of higher quality and more standardized wines. As a consequence, the demand for water to irrigate vineyards is skyrocketing, in a desire to guarantee and improve the quality of production. The area for market gardening is second, with 17 % of the area, followed by the large-scale agriculture of cereals 12%.

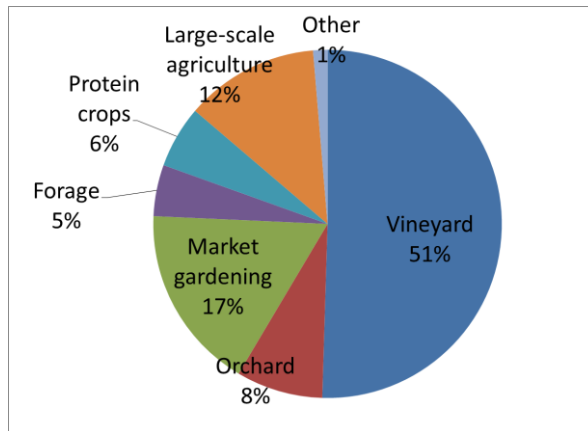

Figure 4–10 2008 Distribution of the irrigated areas by type of crop (adapted from Maton et al., 2013)

In summary, the consumptive users of the Orb River basin are concentrated in the downstream part of the basin either inside or outside the natural boundaries of the river basin, given the possibility of transferring water through the various infrastructures developed at the regional level.

4.4 Environmental features

In a context of increasing pressures on water resources, the environment is competing with consumptive uses. The Orb River basin management association has classified the river basin at risk of not meeting the good status required by the WFD due to a quantitative imbalance in water abstractions (SMVO, 2014).

The Orb River crosses various geophysical territories that provide habitats for a large range of biocenosis (Vier and Aigoui, 2011). The diversity of the fish population, used as indicator of the aquatic fauna, follows a classical upstream-downstream distribution. The salmonids, represented by trout, dominate the upstream part of the river until Bédarieux, where the lotic ecosystems are predominant, associated with a succession of rapids, with shallow and flat river reaches. The population of rheophilic cyprinids, such as the gudgeon, becomes more important downstream of Bédarieux as the lentic ecosystems increase progressively. The cyprinids such as the carp and carnivorous species dominate the downstream area of the basin, where a lentic ecosystem dominates in a succession of ponds controlled by weirs along the rivers (Figure 4–11). Overall, the lotic ecosystems are dominant, representing more than 67% of the ecosystems (Vier and Aigoui, 2011). A plan for the protection of the aquatic environment and the management of fish resources of the Orb River basin has existed since 1997. It aims to protect this diversity, conditioned by the summer low flows upon which the habitat relies. More details on the definition of the environmental flow and the way they have been integrated in the general modelling framework are provided in section 5.3.2 and in Appendix G Environmental Flow.

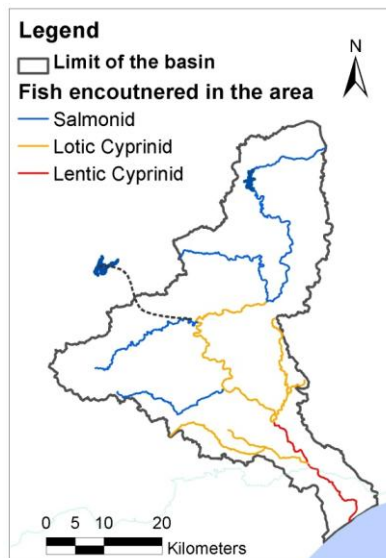

Figure 4–11 Fish distribution in the Orb River basin

4.5 Local planning and management context

4.5.1 Planning process

In the last two decades, the Orb River basin stakeholders have teamed up in a unique stakeholder platform, the Orb River Basin Management Association (“Syndicat Mixte de la Vallée de l’Orb, SMVO” in French). The SMVO supports the development of the local water management plan (SAGE, “Schema d’Aménagement et de Gestion des Eaux” in French) by the local water committee (CLE, “Commission Locale de l’Eau”) formed in 2009.

Local water committees have existed in France since the 1992 French Water Law. In the Orb, it is composed of representatives of: water users (including associations for environmental protection and recreational activities), government agencies and selected members of local authorities. The committee develops local water management plans (SAGE), identifying key water management issues, and specific management actions to be financed and implemented. This local plan follows the transposition at national level of European water legislation requirements, as well as the guidelines given by the river basin management master plan (Schéma Directeur d’Aménagement et de Gestion des Eaux, SDAGE) developed at the River basin district level by the river basin authority (Figure 4–12). If the local water committee identifies actions to be implemented, the actions have to be carried out by local water users owning, managing and developing their own infrastructure at the municipal or inter-municipal level, for the urban water sector; and at the irrigation association level for the agricultural sector, or a higher level in the case of the BRL Company. Then, these organizations can apply for subsidies granted by the River basin authority to finance projects in line with the plan of the local water committee. No single water manager has the possibility of financing and implementing measures at the river basin level, so management must be agreed collaboratively among stakeholders.



Figure 4–12 Organization of water management in France (institutions in bold and planning documents in brackets)

4.5.2 Quantitative water management

Within this context, the latest action plans of the local water committee of the Orb River clearly call for an improvement of the quantitative management of water resources as one of the priorities (SMVO, 2013). French legislation requires all demands to be fully supplied in at least 4 out of 5 years, giving priority to urban use and environmental requirements over agricultural use (MEEDDT, 2008). In the years of a shortfall in supply, various levels of crisis are defined, associated with progressive restrictions on agricultural and urban users. Indeed, the water withdrawal licenses in the French system are not property rights. Water users need to apply for an authorization delivered by the public authority corresponding to an annual volume of withdrawal, or in the case of the BRL company, constraints are defined in terms of remaining flow in the river beyond their water intakes.

The local water committee is currently defining a ceiling on total water withdrawals to ensure that water resources are exploited within the boundaries of ecosystem sustainability. The next step will consist in defining the strategy that will guide future policy to cope with increased water scarcity. To elaborate this strategy, regional and local stakeholders have shown interest in a programme of measures

that could bridge the gap between anticipated future water demands and available resources.

4.5.3 Adaptation strategy to climate change

At the local level, the management strategy of the Orb River basin does not yet consider climate change as one of the main drivers of the planning process. Climate change is mentioned as a factor that could increase crop requirements or challenge the management of the Monts d'Orb reservoir, but no specific adaptation strategy is included in the local management plan.

In contrast, pioneering efforts have been made at the broader level of the River basin authority to develop the first river basin adaptation plan for climate change in France (AERMC, 2014a). The document, based on the assessment of physical vulnerability of the river basins, develops an adaptation strategy based on four pillars: saving water, avoiding mal-adaptation, preserving the current potential of the aquatic environment, and ensuring a shared vision of the problem and its solution. Generic measures are listed for the urban and agricultural sectors, including, among others, reducing water losses in the urban water supply network, improving the efficiency of irrigation or promoting the use of water saving devices in households. These demand management measures coincide with one of the flagship measures of the French adaptation strategy to climate change, which aims for a 20 % water saving target on water abstraction by the time horizon of 2020 (MEDDTL, 2011)

Furthermore, adaptation to climate change has been included as the first fundamental orientation of the draft version of the 2016-2021 River Basin Development and Management Master Plan of the River Basin Authority. The first measure recommends involving the local actors of the management of water resources to implement adaptation actions, through the local river basin committee, for instance. It also highlights that new infrastructure investments are required, but that there is a need to consider contrasted prospective scenarios and associated uncertainties at the local level in the planning process (AERMC, 2014b). The draft programme of measures associated with the master plan includes water savings

measures in agricultural and urban sector in the Orb River basin as one of its territorial measures (AERMC, 2014c). This also justifies the work developed in this thesis, which tries to provide some methodological insights into the development of such an adaptation plan at the local level by combining climate and demand evolution scenarios to inform local decision makers on the possible adaptation options.

4.6 Final comments on the case study

The Orb River basin is modest in extension, but represents an interesting case study to develop and implement our general framework for the integration of top-down and bottom-up approaches to design cost-effective and equitable programme of adaptation measures at the river basin scale. Its geographic and climatic context makes it quite representative of the river basins of the northern rim of the Mediterranean Sea, where the issue of adaptation to the effects of global change will require adaptation in a mid-term perspective. Global change is expected to exacerbate the difficulties of meeting the growing water demands and the WFD environmental in-stream flow requirements. A range of options exists for this adaptation, from pursuing the supply-side management in the region through the development of infrastructures, to the implementation of more demand-side management measures. Thus, this gives some room for the elaboration of an adaptation plan, and the development of methods to support the decision-making process. Therefore, this thesis aims not only to fill a research gap in the scientific literature as explained in the previous chapter, but also to address an issue of primary relevance at the local level for the management of water resources. If water management and adaptation strategies are defined at the national or river district level (group of basins), the definition of an adaptation plan at the local level still needs to be addressed, and this thesis aims to support this definition.

Chapter 5 Implementing the general framework

This chapter presents, successively, the results of the implementation of the top-down (5.1) and bottom-up (5.2) approaches in the Orb River basin. The last section (5.3) describes the ad-hoc least-cost river basin model developed in the case study area to integrate the various results and optimize the selection of adaptation measures.

5.1 Results from the top-down impact assessment

5.1.1 Future climate projections

The climate data were downscaled ⑤ from 9 General Climate Models (GCMs: CCCMA CGCM3 (Canada); CNRM CM3 (Météo-France); GFDL CM2 (NOAA, USA); GISS MODELER (NASA, USA); CNRM Arpège (Météo-France); IPSL CM4 (IPSL, France); MPI ECHAM5 (Germany); MRI CGCM2 (Japan); NCAR CCSM3 (NCAR, USA)). The local climate data (precipitation and Potential EvapoTranspiration, PET) are provided in a daily time step with a spatial resolution of 8 km (Figure 5-1), which fits the grid of the historical local meteorological data set, SAFRAN (Quintana-Seguí et al., 2008). Data were provided for the control period defined from 01/01/1971 to 31/12/2000, and the future period from 01/01/2046 to the 31/12/2065.

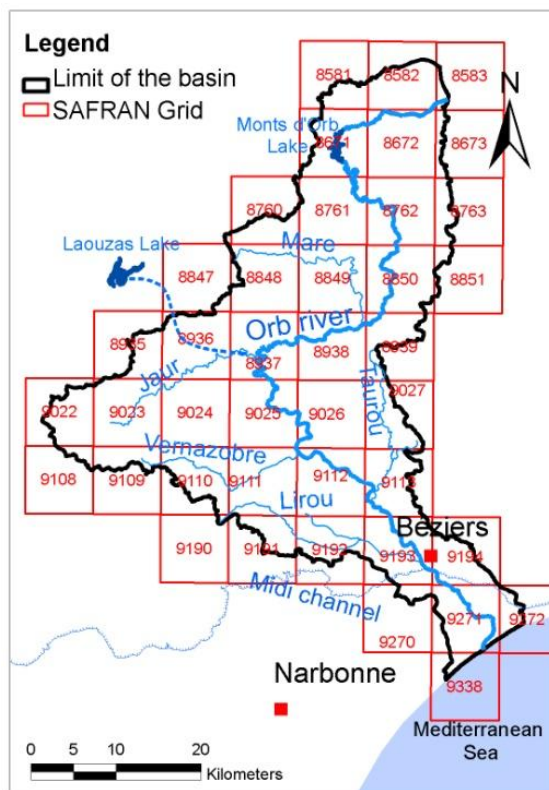

Figure 5–1 The SAFRAN grid of 8 by 8km on the Orb River basin

Monthly average anomalies for the 9 climate projections have been estimated between the future climate projection and the control period (Figure 5–2 and Figure 5–3). The projections show a 13.2 % average increase of annual PET over the Orb River basin, ranging from 8.4% to 18.2 %, in comparison with the control period. Regarding precipitation, a high amount of dispersion is observed between the results of the models: an average 8 % decrease in the annual rainfall is expected, ranging from – 18.6 % to + 5.8 %. Although a trend appears in PET according to the multi-model average, anomalies in rainfall are less homogenous. A reason that can explain the large range of variations is that there are great uncertainties concerning France with respect to precipitation trends under climate change, as the general trends in Northern and Southern Europe are opposite (Kjellström et al., 2013; Boé et al., 2009).

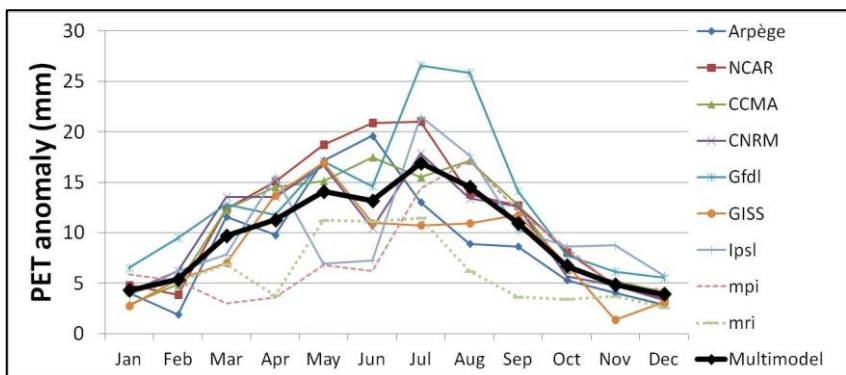

Figure 5-2 Monthly potential evapotranspiration (PET) anomalies for the 9 climate projections

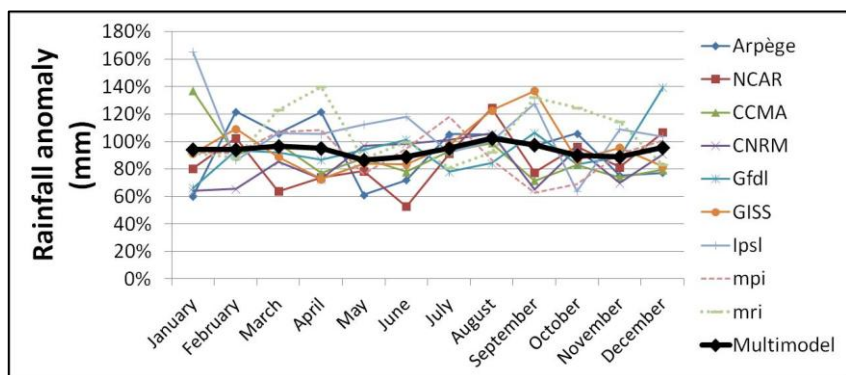

Figure 5-3 Monthly rainfall anomalies for the 9 climate projections

To illustrate the variability between the GCMs in reproducing the existing climate, the following graphs (Figure 5-4) show the relative differences between the observed (SAFRAN) and the control period of the different models for potential evapotranspiration (PET) and rainfall (P). The models that best represent current precipitation (CCMA and GFDL) are different from those with the best reproduction of the PET (GISS, IPSL). The NCAR model seems to be the poorest in both cases. In any case, the quality of the simulation of the control period does not necessarily ensure the quality of the simulation of the future period under a changing climate (Reifen and Toumi, 2009). It can only be assumed that a model that performs better in the control period is more likely to perform better under changed conditions. In our case, the range of results can neither be considered as a

probability distribution function, given that the number of samples is very low. Therefore, working on a selection of these models or a combination following an ensemble approach would not allow the variability of the projections of the GCMs to be accounted for in the subsequent steps of the methods. In order to capture the range of impacts introduced by climate change, the results of all the climate projections were considered during the development of the next step of the method.

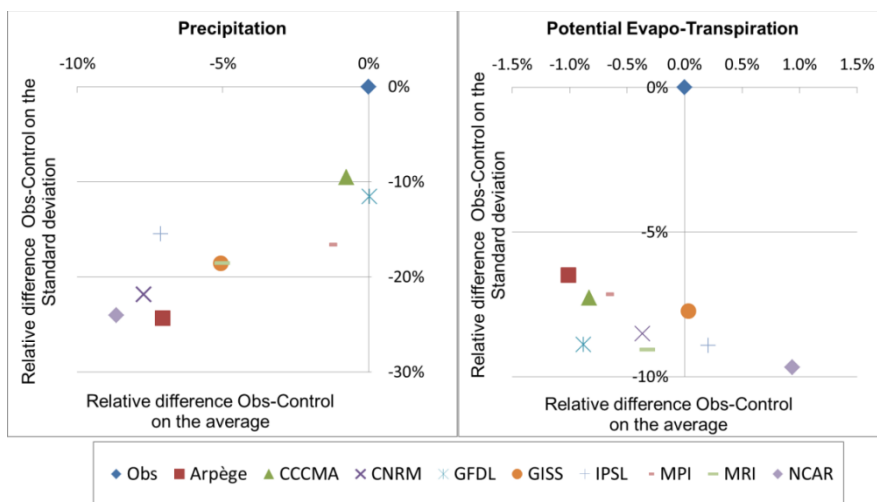

Figure 5–4 Statistical analysis of climate data for 9 climate projections (average annual Potential Evapotranspiration, (PET) and Precipitation over the river basin)

5.1.2 Calibration and validation of the hydrological model

The Orb River basin authority has adopted various nodes of reference for the quantitative management of water resources at the river basin scale (Vier and Aigoui, 2011), (Figure 5-5). These nodes have been adopted as a reference to define the sub-river basins prior to performing the hydrological analysis ⑥.

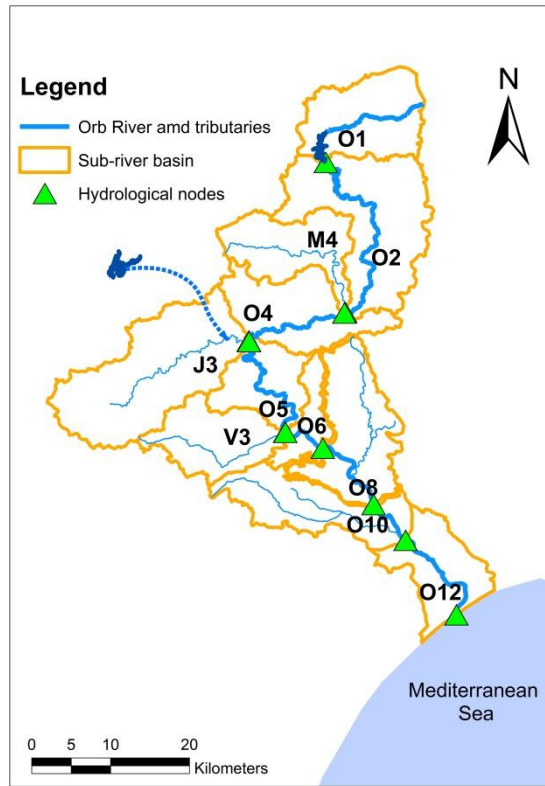

Figure 5–5 Nodes of the hydrological model

The data of the natural flow regime of most of the nodes originate from Chazot et al., (2011) who performed the restitution to the natural flow regime and thus provided us with a monthly natural flow time series. The main limits of the restitution to natural flow regime they carried out are due to the lack of accurate observed data and the need to interpolate the natural flow between the different nodes (see Appendix C Hydrology for a more detailed analysis of the quality of the natural flow regime).

The rainfall-runoff GR2M model has been calibrated and validated in each sub-basin with the historical climatic data (precipitation and potential evapotranspiration) and natural monthly discharges for 38 years, from 1970 to 2001 for the calibration and from 2002 to 2007 for the validation. The Root-Mean-Square Error (RMSE) has been used to automatically calibrate the models through an Excel solver. The RMSE was found, by Oudin et al., (2006) to be a good

compromise for an all-purpose model, by not giving too much emphasis to low or high flows. The validation/calibration performance of the model was assessed using the Nash and Sutcliffe (1970) efficiency⁷ coefficient in addition to the RMSE. Finally, the validated models for each of the sub-basins were used to simulate the natural river discharge at their respective outlets, using the inputs from the 9 climate projections downscaled from the General Climate Model for the future period (2046-2065).

The results of the validation and calibration of the hydrological models indicate variable calibration and validation quality (Table 5-1 and Appendix C Hydrology) that were considered good enough overall for the model to be used in climate change impact studies. On the one hand, the difference between simulation and observation is partly due to some inconsistency of the natural flow restitution mentioned in the previous section and detailed in Appendix C Hydrology. On the other hand, the differences could also be due to surface water seepages that recharge the calcareous aquifers further downstream in the basin. Indeed, the statistics indicating the poorest performance are obtained for the sub-basins, where these surface-groundwater interactions are probably the cause of the significantly lower specific river discharges (O5, O8, O10 and O12). This is linked to the coarse description of the surface-groundwater interactions, due to the lack of relevant data in such a complicated geological context (see geological map in appendix Hydrology). Applying models able to simulate groundwater dynamics or stream-aquifer interactions should improve the quality of the modelling. However, this raises the need to acquire new data, particularly in order to quantify the part of the river flow that disappears underground in the sink holes specific to limestone regions. In any case, the flows coming from these sub-basins are clearly lower than the more productive upstream sub-basins.

⁷ The Nash-Sutcliffe efficiency (NSE) criterion quantifies models performance in relative terms, whereas the RMSE characterizes only the performance in absolute values (Pushpalatha et al., 2012).

Sub-basin	O1	O2	M4	O4	J3	O5	V3	O6	O8	O10	O12
Warm up	1968-1969										
Calibration	1970-2001		1970-1992		1970-2001						
Nash (Q)	0.86	0.89	0.75	0.78	0.85	0.85	0.80	0.72	0.55	0.46	0.36
RMSE (mm)	23.8	19.8	20.2	24.0	28.2	28.2	26.1	19.4	2.8	3.1	3.4
Validation	2002-2007		1993-1995		2002-2007						
Nash (Q)	0.93	0.80	0.47	0.54	0.80	0.72	0.78	0.40	0.69	0.58	0.40
RMSE (mm)	16.5	29.3	42.1	50.5	29.8	1.8	25.5	20.8	1.7	2.0	2.4

Table 5-1 Indicators of the hydrological model calibration and validation

5.1.3 Future hydrological scenarios

The future monthly time flow series present large variations between the different climate change projections (Figure 5–6). Looking at the monthly time step, the dispersion between the climate projections is higher in the high-flow season than in summer, due to more uncertainties in climate modelling of the projection of the rainfall. The summer low-flows decrease in the future in comparison to the observed historical data.

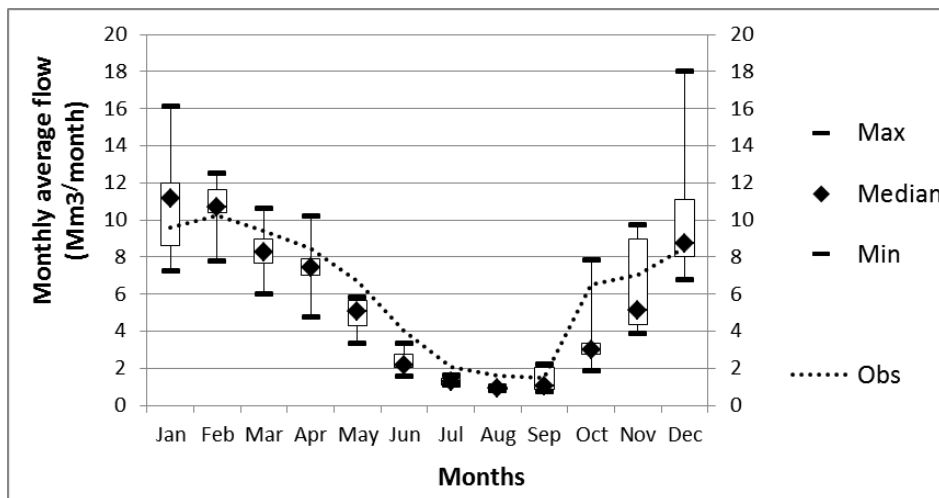

Figure 5–6 Monthly average flow statistics under 9 future mid-term (2046-2065) climate change projections and historical (1970-2000, Obs) on the sub-basin O1

The spatial variations between the different sub-river basins are estimated through the variations of the monthly low-flow with a return period of 5-years⁸ under the future climate projections of the 9 GCMS (Table 5-2). If all models indicate the same signal of a decrease in the low-flow over the different sub-basins, a wide range of variation appears among the projections and the sub-river basins considered. The upstream basins (O1, M4, O3, O4, J3) are those most impacted by climate change, whereas those downstream seem to be less affected. This may be due to a compensation between the variations of the low-flow from upstream sub-basins reaching these sub-basins (here we consider the flow at the outlet of the basin not only the natural inflow from the sub-basins). The range of dispersion among the sub-basins (difference between minimum and maximum low-flow decrease between the climate projections) spreads between 18 % in the sub-

⁸ The 5-year monthly low-flow is commonly used in French planning and management of water resources (known as the QMNA5).

basins O1 and O6, to 37 % in the upstream sub-basins (M4 and J3). The basin O1 upstream of the Monts d'Orb reservoir seems to be strongly impacted, with a narrow range of dispersion, therefore with more confidence.

Climate projection	Sub-basin										
	O1	O3	M4	O4	J3	O5	V3	O6	O8	O10	O12
MRI	-27%	-20%	-14%	-16%	-9%	-10%	-2%	-8%	-8%	-7%	-6%
IPSL	-24%	-14%	-15%	-11%	-7%	-13%	0%	-11%	-11%	-11%	-12%
CCMA	-22%	-16%	-19%	-11%	-9%	-12%	-7%	-12%	-11%	-11%	-12%
MPI	-25%	-18%	-23%	-17%	-20%	-20%	-7%	-17%	-17%	-17%	-17%
GISS	-32%	-21%	-17%	-19%	-11%	-20%	-12%	-17%	-18%	-18%	-18%
Arpège	-40%	-37%	-29%	-33%	-23%	-27%	-7%	-21%	-21%	-20%	-22%
GFDL	-37%	-32%	-34%	-25%	-24%	-24%	-6%	-21%	-21%	-22%	-22%
CNRM	-29%	-18%	-51%	-22%	-35%	-21%	-19%	-21%	-21%	-22%	-24%
NCAR	-39%	-33%	-52%	-31%	-43%	-32%	-18%	-27%	-27%	-27%	-29%
Min	-40%	-37%	-52%	-33%	-43%	-32%	-19%	-27%	-27%	-27%	-29%
Max	-22%	-14%	-14%	-11%	-7%	-10%	0%	-8%	-8%	-7%	-6%
Range of variations	18%	23%	37%	22%	37%	22%	19%	18%	19%	21%	23%
Average	-30%	-23%	-28%	-21%	-20%	-20%	-9%	-17%	-17%	-17%	-18%

Table 5-2 Variation in the 5-year monthly low-flow (QMNA5) by sub-basin and climate projection (%)

However, the average, or single low-flow indicators, are not enough to capture the variations in the flow regime that will modify the management of the Monts d'Orb reservoir, for instance. Thus, monthly flow time series will be used in order to address how the water resource system behaves in a succession of dry and high-flow periods and account for the intra- and inter-annual reservoir management.

The results of implementing the top-down approach provide a comparison of the impact of different climate change projections on the 5-year monthly low-flows of the river sub-basins, illustrating the range of uncertainties associated with climate change projections. It characterizes the exposure of each sub-basin to the projected impact of climate change. However, in order to estimate the vulnerability

of these sub-basins, we also need to consider their respective sensitivity to climate change that will be determined by their level of urban and agricultural demands, and also their capacity to adapt through adaptation measures and the management of the hydraulic infrastructures (reservoir). Therefore, the implementation of the top-down approach is performed in parallel with the implementation of a bottom-up approach, presented in the next section, that will address these issues.

5.2 Results from the bottom-up approach

5.2.1 Stakeholder involvement

An advisory group was set up comprising experts and stakeholders with representatives from two government agencies, the regional and the county councils, two local watershed councils (Orb River basin and Astian sand aquifer) and the Rhône Mediterranean and Corsica river basin district authority. The members met about ten times over six years. The stakeholder advisory group accompanied the various steps during the successive projects prior to and during the development of this thesis. More specifically, it contributed to the development of future agricultural and urban water demand scenarios ❶ and to the identification of adaptation measures relevant for the basin ❸. Additional experts and user representatives were invited to participate in meetings and workshops dealing with agricultural issues, including the BRL Company and the regional agricultural chamber.

Although the number of stakeholders involved in the participatory process was relatively small, the representativeness of the views expressed (Figure 5–7) was to some extent guaranteed by the participation of representatives of the Orb local water committee, local authorities or water users involved in the design or implementation of the main water policy issues in this area (Table 5-3). Thus, we consider that they were able to reflect pre-existing choices and knowledge from the local context and diversity of opinion debated, for instance, among the local water

committee representatives (see section 4.5.1) in the construction of the scenarios, and adaptation measures.

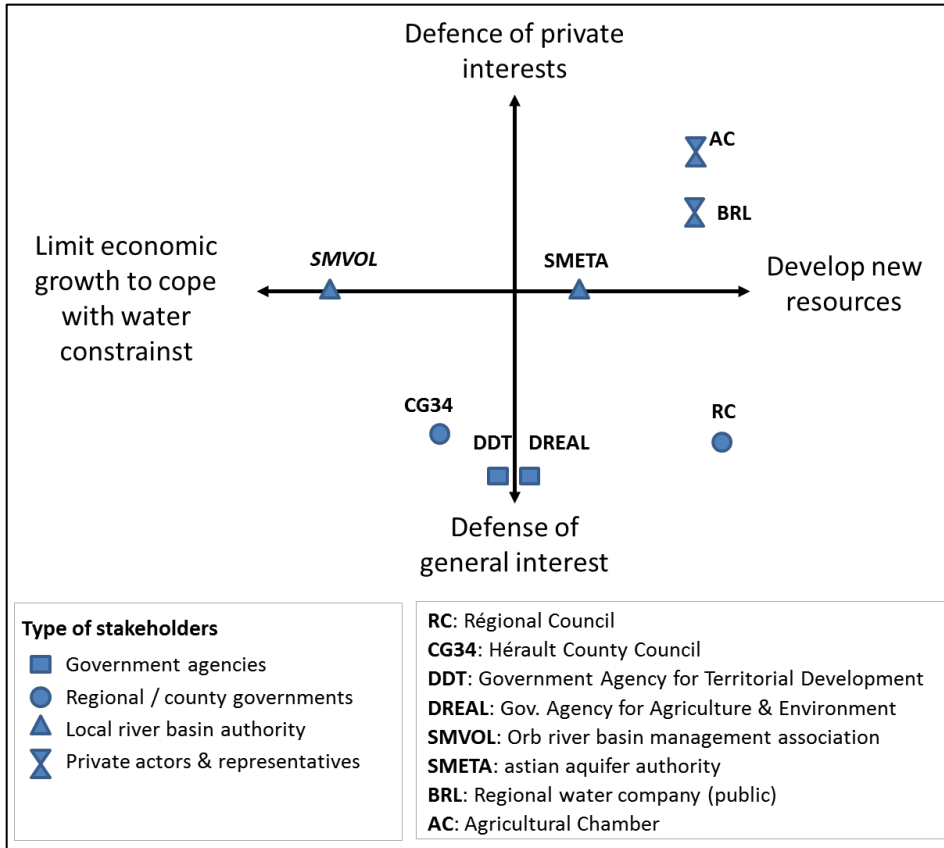

Figure 5–7 Mapping of the stakeholders included in the participatory process
 (X axis: position on the current debate opposing proponents of water resource development policy against the ones of a limited growth and water conservation policy; Y-axis: their consideration of private or general interest)

Implementing the general framework

		Local river basin councils		Government agencies			Local government		Users & representatives	
		SMVOL	SMETA	DDT	DREAL	AERMC	RC	CG34	AC	BRL
Urban sector	Urban planning and development	X	X	X						
	Development of urban water networks			X		X				X
	Urban water conservation programmes		X							
	Long term urban demand forecasting	X	X				X	X		X
	Development of new water resources (groundwater, interbasin transfers)		X		X	X	L	L		L
Agricultural sector	Development of regional agricultural policy (incl. irrigation)	X		X		X	X		L	
	Development of new irrigation infrastructures					X	L	X		X
	Agricultural water conservation programmes	X								
	Long term agricultural water demand forecasting						L	X		X
Management of resource &	Operation of large infrastructures (reservoirs, interbasin transfers)							X		L
	Integrated planning at river basin / aquifer level	L	L		X					
	Climate Change adaptation				L					
	Supporting the participation of civil society in long term water planning	L	L		X					

x = actively involved ; L = leading role

Table 5-3 Stakeholder involvement in main water policy issues (Acronyms are defined in Figure 5–7)

5.2.2 Future agricultural demand scenarios

During the scenario-building workshops dedicated to the evolution of the agricultural sector ②, stakeholders first debated the major factors of change (drivers) of the agricultural sector, which they had to rank (Figure 5–8). They then discussed possible trends associated with each driver and formulated quantitative assumptions that were used to frame three contrasted scenarios. A consensus was found on the most likely trends, in order to build a future scenario corresponding to a negotiated vision of future irrigated agriculture and considered as plausible and to some extent desirable by participating stakeholders. The output of the workshops, of course, has a clear subjective dimension and it is acknowledged that contradictory visions could have been expressed by other components of the civil society. However, stakeholders were considered as representative of actors whose decisions will shape the future in the Orb River basin, therefore the scenario they have defined is used as a future scenario. The workshop output consisted of a series of assumptions on future irrigated areas, crops and technologies used to quantify the corresponding future irrigation water demand. Additional details can be found in (Maton et al., 2008, 2013), and in Appendix D Agricultural demand.

Stakeholders who participated in the definition of the future agricultural development scenarios envisaged a significant development of drip-irrigation practices within the existing vineyards (Table 5-4), as a way to secure the grape harvest and the quality of wine in the event of drier summers.

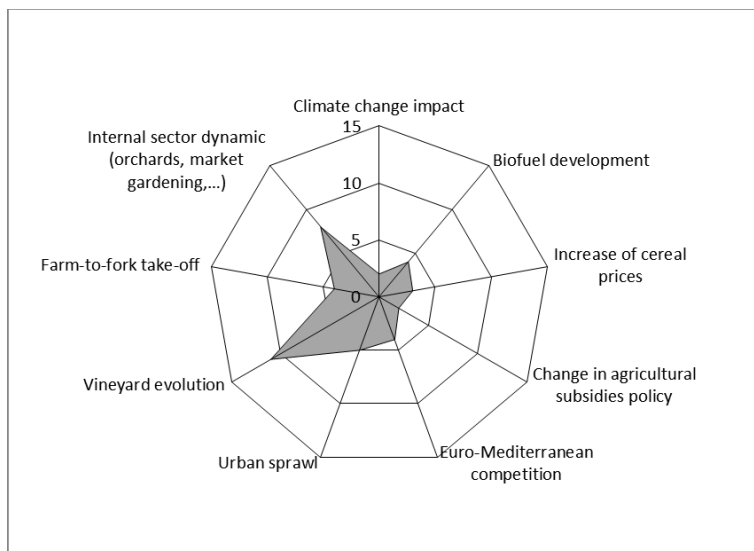

Figure 5–8 Drivers of future agricultural water demand identified by consulted stakeholders (the score represents the number of experts that consider that the factor will strongly determine future evolution).

Based on the hypotheses on the agricultural demand scenario obtained from the previous workshops, future cultivated and irrigated areas were estimated in the case study area in order to build up a coherent development scenario for the river basin, through an iterative process, between researcher and stakeholders, to validate the final figures and quantified assumptions. This scenario assumes an increase in irrigated area by a factor of 4, mainly due to the development of irrigated vineyards from the current 3,000 hectares to more than 21,000 hectares (Table 5-4). However, this increase relies on assumptions on the availability of water resources, public subsidies and land use planning. Clearly, this scenario represents the development desired by the agricultural sector without considering the limitations of the water resources. The possibility of such development and its cost in terms of adaptation is discussed in the rest of the thesis as trade-offs between the cost of the programme of measures and the amount of irrigated agriculture (section 6.3.1).

Irrigated crop	Area in ha		Variation
	Present (2010)	Future (2030)	
Cereals	752	902	20%
Oil seeds and protein plants	350	415	20%
Fodder	289	346	20%
Market gardening	1041	2082	100%
Orchards	487	223	-54%
Including olive trees	100	171	137%
Other	81	81	0
Irrigated vineyard	3058	21125	691%
Total irrigated	6158	25345	411%

Table 5-4 Assumptions on the change in irrigated crop area in the Orb River basin

The agricultural water demand has been calculated for 4 different scenarios

- The first scenario is a baseline scenario corresponding to the current irrigated areas under the current climate observed (SAFRAN data).
- The second scenario represents a hypothetical situation in 2030 where the cultivated areas have changed, but the climate is still the same as the baseline climate. This allows the impact of changes in the cropping pattern to be assessed separately.
- The third scenario represents the opposite hypothetical situation in 2030, where the cultivated areas remain the same as in 2008, but the climate corresponds to the future climate associated with the 2045-2065 time period and the projection from the GCM ARPEGE. This allows the impact of climate change to be assessed separately.
- The fourth scenario represents a situation in 2030 where the cultivated areas have changed following the previous scenario and the climate corresponds to the future climate associated with the 2045-2065 time period.

The marginal (and combined) effects of changes in irrigated area and climate are depicted in Figure 5–9. Climate change alone would increase demand by 58 % (considering that the crops grown and the area under irrigation remain unchanged). Socio-economic change alone would result in a 64 % increase. When combined, the two drivers result in a 145 % increase in irrigation water demand.

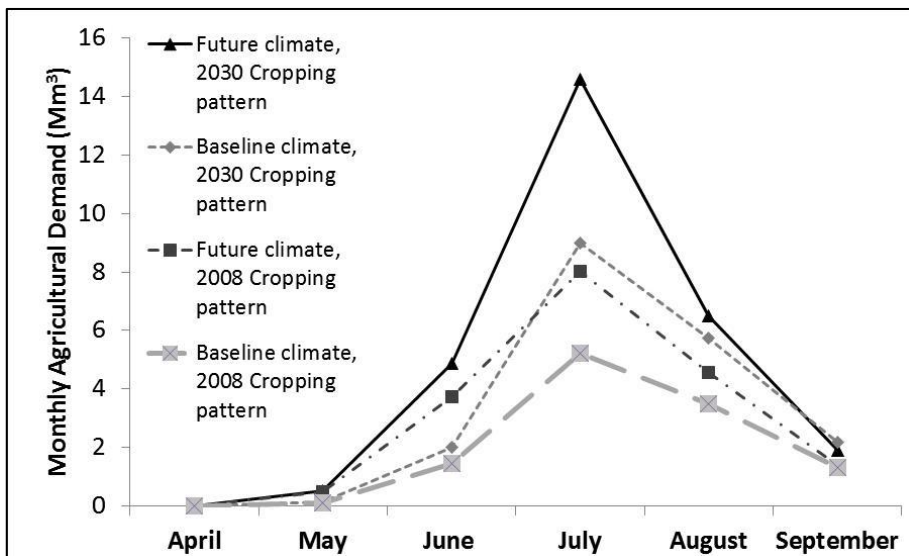

Figure 5–9 Evolution of agricultural water demand at the basin scale under different scenarios

Monthly average water demand values are computed for the 9 climate projections in combination with the 2030 cultivated areas at the agricultural demand unit level (Girard and Rinaudo, 2013, and Appendix D Agricultural demand). Aggregated values have been estimated at the basin scale (Figure 5–10). The average monthly water demands vary significantly between the climate projections (especially in July with variations of -2.8 Mm^3 to $+4.7 \text{ Mm}^3$ around the average at the basin scale). However, to reduce the computational burden in the analysis of different scenarios in the rest of the work, we consider the multi-model average at the monthly time scale for each of 19 agricultural demand units.

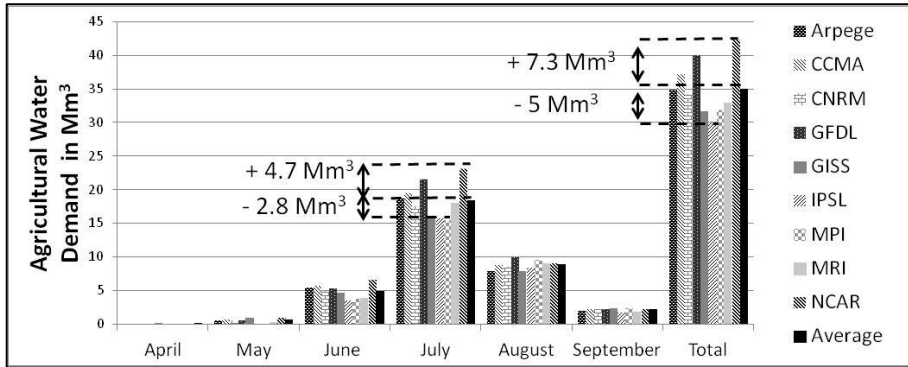

Figure 5–10 Monthly average agricultural water demands at the basin scale for 9 future mid-term (2046-2065) climate change projections

5.2.3 Future urban demand scenario

The scenario defined specifies that change in future urban water demand is mainly driven by future population growth (1 % per year, on average in the future planning horizon) and the following assumptions were agreed over the 2008-2030 period: 1) a 10 % decline in per capita consumption, due to technological change, a 6 % increase of per capita consumption due to climate change (mainly due to swimming pool evaporation and lawn watering). A 30 % increase in water price was estimated, based on historical data, not only due to the need to finance the replacement of ageing infrastructure, but also to the strengthening of the environmental and health legislation on water supply. Incomes were assumed to be stable over the area. (More details on these hypotheses are given in Appendix U). Based on these assumptions, the econometric model estimated the future urban demand of the 64 UDUs supplied by the water resources of the Orb River basin. In total, it estimated an increase in the annual demand of 4.4 Mm³ a year on average (Vernier and Rinaudo, 2012), corresponding to an increase of 15 % between the baseline (29.3 Mm³/year) and future period (33.7 Mm³/yr).

Subsequently, assumptions were made on monthly distribution from the annual and peak abstractions at the UDU level. The result at the scale of the river basin is presented in the following graph (Figure 5–11). The average peak factor increases between 2008 and 2030 from 1.47 to 1.62. This distribution has been estimated for

all the UDU of the river basin to take into account the fact that the UDU located downstream and on the coast would have a higher peak factor due to the touristic population in summer.

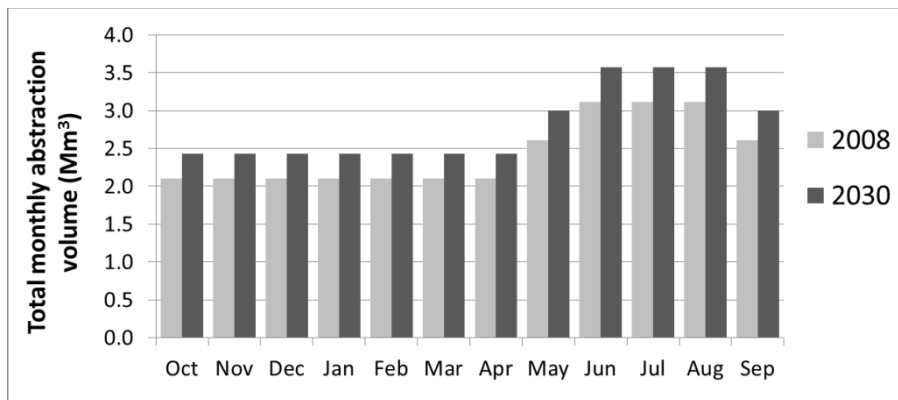

Figure 5–11 Comparison of monthly urban water abstractions from the Orb water resources

5.2.4 Adaptation measures

The stakeholder consultation process identified different types of planned adaptation measures for the demand management of urban and agricultural sectors as well as capacity expansion measures. In addition, three specific workshops were organized to scrutinize urban water conservation measures, involving three types of stakeholders: members of the board of the river basin committee, representatives of the local authorities and general citizens (Figure 5-12 and Table 5-5). In addition to open discussion, each participant was asked to individually express his/her opinion on the relevance of each measure given their perception of the local issues at stake in the basin. This was followed by a group discussion to clarify the arguments for and against each measure.

On the demand management side, nine measures were identified for the urban water sector, targeting households as main water users, but also other urban water users who have a critical impact on urban peak water demand, such as touristic, municipal and commercial uses (few industries are located in the basin) and park/green spaces uses.

Two types of measures were identified to improve irrigation efficiency in the field or in the distribution network, given the existing practices in the area (Rinaudo, et al., 2013c). Other typical measures usually considered in the adaptation of the agricultural sector, such as change in cropping pattern or changes in the area of production, were not considered. This was mainly due to the specific characteristics of the wine production in the area and the importance of the quality label associated with the land and variety that limit such measures. (More details in Appendix F Adaptation measures).

On the supply management side, the catalogue of measures includes the possibility of building a desalination plant to supply coastal municipalities. Investment and operating costs for such plants were estimated based on figures provided by local engineering companies and cross-checked with values reported in international surveys (Rinaudo et al., 2013c, Ghaffour et al., 2013, Zhou and Tol, 2005). A specific study was carried out to identify aquifers unconnected to the river that could be sustainably used by drilling new wells (Rinaudo et al., 2013b). The sustainable yield and costs (investment, operation and maintenance) associated with the projected wells were estimated.



© Girard.C

Figure 5–12 Workshops on the adaptation measures in the urban sector

Actors	Number of participants
Members of the board of the Orb River basin management association	12
Government agencies and regional council representatives	6
Citizens	16

Table 5-5 Participants at the three workshops on urban water conservation measures

Some measures that had been identified at first were then eliminated based on legal constraints and acceptability or feasibility considerations expressed by the stakeholders (e.g. water reuse). Other measures were discarded after a first assessment of cost-effectiveness due to their unfavourable cost-effectiveness ratio (e.g. rainwater harvesting).

The measures identified were characterized in terms of their cost and effectiveness (as volume of water saved or mobilized) for the different demand units of the basin ④. The results obtained are summarized in Table 5-6, which shows the average cost per unit of water (cost-effectiveness ratio in €/m³) and maximum volume of water that can be saved or mobilized with each measure (further details are available in Appendix F Adaptation measures).

Id	Description of measure	Maximum annual volume available in 2030 (Mm³)	Average annualized unit cost (€/m³)	Number of measures considered
Supply side				
GW	Substitution of water withdrawals in the Orb River by other groundwater resources	1	1.89	3
DS	Substitution of water withdrawals in the Orb River with desalinated water (coastal municipalities)	3.60	1.22	2
Demand side				
MA1	Conversion of gravity irrigation systems to pressurized / sprinkler irrigation	0.81	0.16	7
MA2	Development of drip irrigation at field level in all pressurized irrigation systems	1.56	0.54	11
MU1	Reduction of leaks in urban water distribution networks	3.28	0.77	48
MU2	Installation of water conservation devices (tap aerators, shower flow reducer, etc.) in individual households	0.36	0.56	84
MU3	Water consumption audits for single family houses & changes in appliances	0.52	1.16	84
MU4	Same as U2 for multi-family housing units	0.51	1.64	36
MU5	Installation of automated reading meters & use of seasonal water tariffs to reduce peak-season demand	0.83	0.66	84
MU6	Installation of water saving devices in hotels (tap aerators, toilet flushes)	0.04	0.61	24
MU7	Water consumption audits of campsites and holiday parks. Installation of low-flow flushes / showers, leakage detection in campsite distribution network, etc	0.18	1.55	11
MU8	Replacement of water intensive landscapes with xeric vegetation (public gardens)	0.59	0.68	84
MU9	Replacement of irrigated lawns with artificial turf for sport grounds	0.43	1.95	7

Table 5-6 Characteristics of the adaptation measures

5.3 Developing a least-cost river basin optimization model

5.3.1 Characteristics of the model

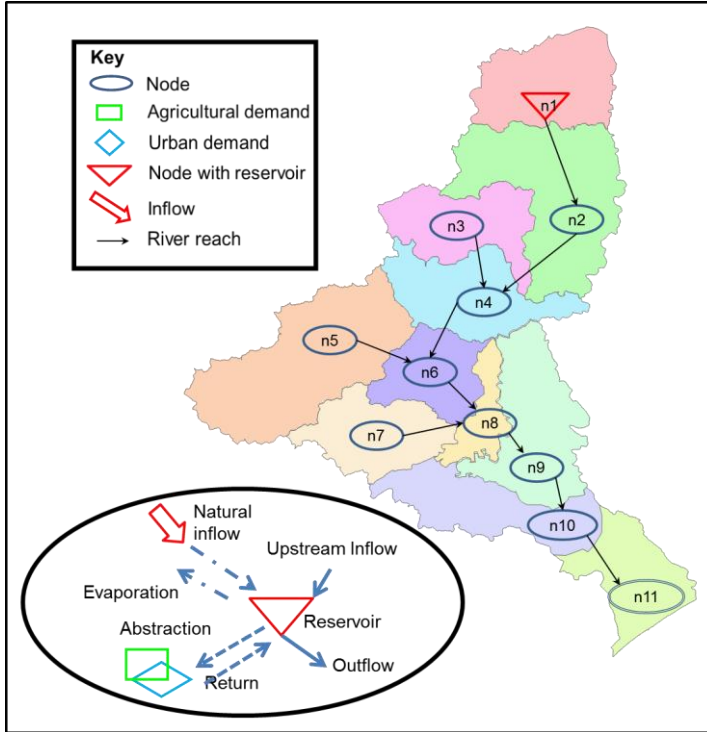

Figure 5–13 Representation of the Orb River basin in the optimization model (with the flow network on the map of sub-basins, and details of the mass balance at reservoir node n1).

In a schematic view, the least-cost river basin optimization model ⁷ of the Orb River can be represented as shown in Figure 5-13. The UDU and ADU have been aggregated for each node in order to facilitate the representation, but they are all independent units in the model. The 11 sub-river basins are represented as a flow network of 11 nodes, including one node with a storage capacity representing the Monts d’Orb reservoir. Nodes are linked by arcs that represent the different river reaches. The 64 Urban Demand Units and 19 Agricultural Demand Units of the Orb River basin are connected to the node of the sub-basin from which water is abstracted, and to which it returns. At each node and for each monthly time step,

constraints are imposed on demand targets, minimum environmental flow requirements, and reservoir operating rules for flood protection and dead storage volume. The optimization is carried out over a monthly flow time series, first on the baseline period (1971-2000) and then for the global (climate and demand) change scenarios corresponding to the future period (2046-2065).

5.3.2 Environmental flow requirements

In-stream environmental flow requirements aim at maintaining the environmental functions of the river by means of an appropriate flow regime (Postel and Richter, 2003). Ideally, a seasonally variable flow regime is needed to sustain freshwater ecosystems (Poff et al., 1997). However, the current approach applied in the river basin defines only minimum in-stream flow requirements for selected nodes. A hydraulic method (Gippel and Steardson, 1998) using the habitat method ESTIMHAB (Lamouroux, 2002) was applied to define minimum flow thresholds at each node of the basin (Vier and Aigoui, 2011). The hydraulic method estimates the wet perimeter at each node of the model as a function of the minimum flow to be defined. The wet perimeter is representative of the available habitat for the aquatic fauna and depends directly on the minimum flow to be defined. The hydraulic method was completed by the habitat method applied in four nodes of the basin (two on the Jaur and two on the Orb) and the results from microhabitat studies on the Mare and the Vernazobre were integrated. (More details are provided in Appendix G Environmental Flow).

5.3.3 Infrastructure management

The reservoir is managed as a multipurpose reservoir. Operating rules fix only the monthly dead-storage and maximum volume of the reservoir for flood protection (Chazot, 2011). The volume released from the reservoir and the volumes of water allocated are defined during the optimization procedure. Direct evaporation from the reservoir was calculated based on estimates of average annual reservoir evaporation in the south of France (Vachala, 2008). More details are provided in Appendix H Least-cost river basin optimization model.

5.3.4 Spatial representation: connectivity matrices

In order to elaborate the LCRBOM, the data on the measures and demand need to be connected in a consistent spatial framework at the river basin scale. The hydrological nodes are connected through river reaches (Inflow-node matrix) and each urban or agricultural demand is connected to its respective node (demand-node matrix). The main difficulty lies in establishing the link between the UDU, ADU and the water resources. The connectivity matrices were established by reviewing the existing studies (Vier and Aigoui, 2011; Chazot et al., 2011), and were validated by local experts in the case of conflicting data. More details are provided in Appendix H Least-cost river basin optimization model.

5.4 Remarks on the implementation of the framework

The implementation of the interdisciplinary framework presented above has only been possible thanks to close collaboration with several colleagues: specialists in economics, hydrology, climate change and water resources modelling. I have personally been involved in the various tasks in different ways and with a varying degree of intensity, depending on the discipline and skills required. My work did not consist in developing and implementing all the different parts of the methods presented in this chapter from scratch, as some had been already developed during previous or ongoing projects by other scientists involved in local research projects over the last 10 years. More precisely, the challenge addressed in the thesis was to appropriate these tools and methods in close two-way interactions (Figure 5-14) with a team of scientists: first, to understand their perception and representation of each part of the problem under study; and second, to adapt and complement their work so it could address the desired issue, integrating it with the study process.

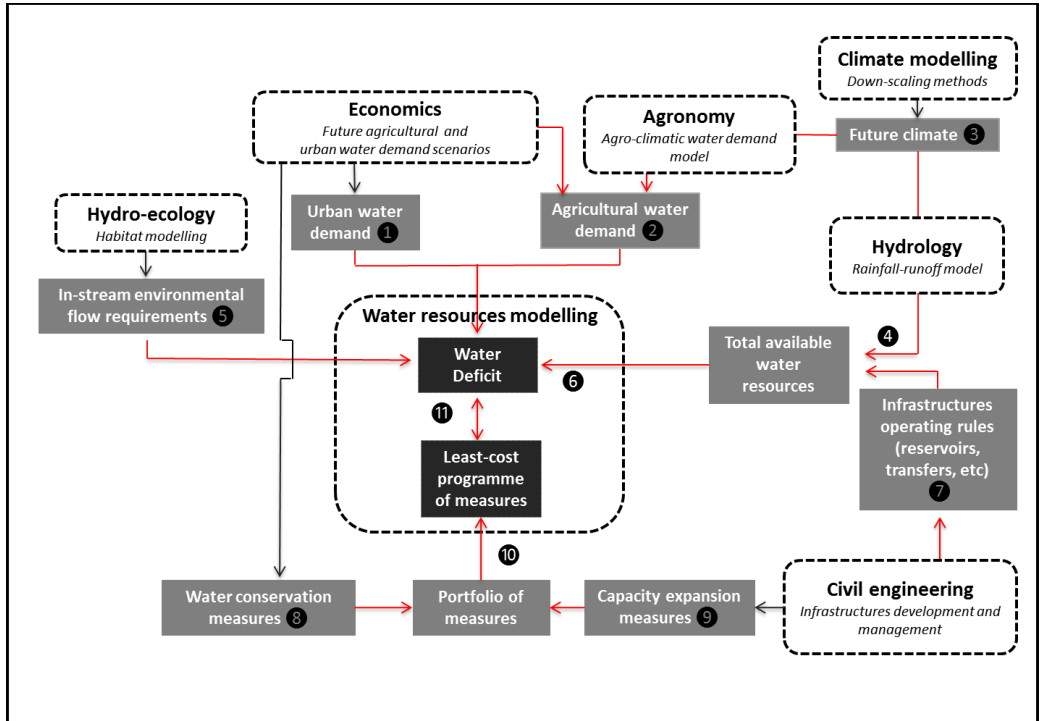

Figure 5–14 Interdisciplinary interactions through the integration process
 (The exchanges in which I was actively involved are in red)

Chapter 6 Selecting cost-effective adaptation measures under global change uncertainties

This chapter presents the different results with the aim of identifying cost-effective adaptation measures in a context of global change. First, the results from a simple cost-effectiveness analysis based on a cost-effectiveness ratio are presented, acknowledging the limitations of the approach (6.1). Then, results from the least-cost river basin optimization model are presented for baseline, business-as-usual and future adaptation scenarios, to identify a first set of adaptation measures that are cost-effective at the river basin scale (6.2). Subsequently, we investigate the trade-offs between the selection of cost-effective adaptation measures and other management objectives, such as the development of irrigated agriculture or the level of environmental flow (6.3). Finally, the results of the climate check performed on the selection of measures on the Orb River basin are described to address the issue of uncertainties associated with climate change projections (6.4).

6.1 Cost-effectiveness analysis of the measures

6.1.1 Index-based cost-effectiveness analysis

As mentioned in the State-of-the-Art chapter (section 2.2.1), the cost-effectiveness analysis of a programme of measures based on the ranking of cost-effectiveness ratio of the measures is a standard approach in the management of water resources, recommended and used in the implementation process of the European Water Framework Directive. Such an analysis was performed at the beginning of this thesis. We now present some results of this cost-effectiveness analysis as a way of introducing the problem of selecting cost-effectiveness measures at the river basin scale.

First, the measures can be ranked according to their average cost-effectiveness ratio (Figure 6–1). However, the dispersion in the individual cost-effectiveness ratios of each measure highlights that although some measures seem less cost-effective when looking at their average cost-effectiveness index, their implementations in a limited number of specific locations could be worth including in a programme of adaptation measures. For instance, the measure of seasonal water pricing (MU5) was less cost-effective on average than MU8, MU2 or MU6. However, the 1st quartile of the individual MU5 measures appears to be as, or more, cost-effective than these other measures. At the opposite end, the implementation of the cost-effective measures (MU1) would not be cost-effective in some specific locations. Developing a programme of measures based on the average index would ignore the potential of some specific measures, leading to a sub-optimal ranking of measures and generating a loss of economic efficiency.

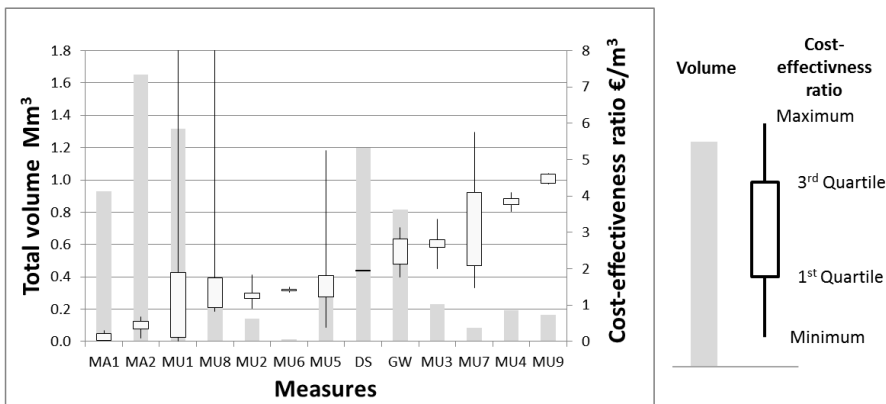
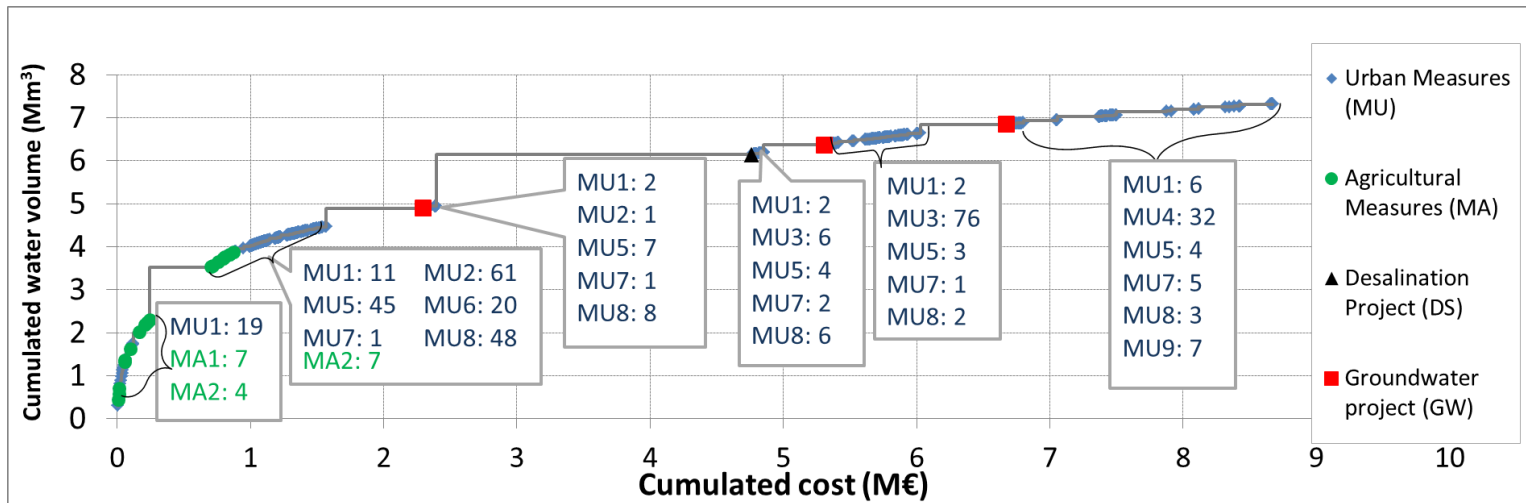

Figure 6–1 Cost-effectiveness statistics for adaptation measures.
 (The labels used for each measure correspond to those in Figure 6-2, measures are ranked by average cost-effectiveness ratio)



- MU1: Reduction of leaks in urban water distribution networks
- MU2: Installation of water -saving devices in households
- MU3: Water consumption audits for single family houses
- MU4: Water consumption audits for multi-family housing units
- MU5: Use of seasonal water tariffs to reduce peak-season demand
- MU6: Installation of water-saving devices in hotels
- MU7: Water consumption audits of campsites and holiday parks
- MU8: Implementation of xeric vegetation
- MU9: Artificial turf for sport grounds
- GW: Development groundwater resources
- DS: Desalinated water
- MA1: Conversion of gravity to pressurized / sprinkler irrigation
- MA2: Development of drip irrigation in irrigation systems

Figure 6–2 Ranking of the specific adaptation measures based on their cost-effectiveness indexes. The cumulated volume is the sum of volume saved (water conservation measures) or obtained through capacity expansion (groundwater or desalination). The measure are further described in Table 5-6

Then, the measures are ranked and ordered according to their individual cost-effectiveness ratio to construct a CEA curve that depicts the evolution of the cumulated cost and cumulative effectiveness associated with the progressive implementation of the various measures (Figure 6–2). This cost-effectiveness analysis provides information for the design of an adaptation plan that would specify which measure should be implemented in which local urban or agricultural demand unit. In this case, measures should be implemented from left to right following their cost-effectiveness ratio. Agricultural measures to modernize irrigation (MA1 and MA2) and measures to improve urban network efficiency (MU1) appear to be the most cost-effective. At the other extreme, some measures could be discarded based on their high cost per cubic metre (e.g. the introduction of artificial turf, MU9; the distribution of water-saving devices for multi-family housing units, MU4; or the water audit for individual houses, MU3). The capacity expansion measures (groundwater and desalination) allow a large amount of water to be provided but at a high cost, with lower cost-effectiveness. From a policy perspective, the results of this analysis suggest that water conservation measures are more cost-effective than the mobilization of new resources. It also shows that a future gap between demand and available resources could be bridged by a combination of water conservation measures in the urban and agricultural sector, groundwater and desalination development programmes being required only if this gap is greater than expected.

6.1.2 Limits of the index-based cost-effectiveness analysis

A cost-effectiveness analysis based on indices such as the one presented above is useful for a River Basin Authority, as a first approximation, to define priorities in the design of a programme of measures from an economic efficiency perspective. It provides a first screening of the large number of possible actions. However, this Index-based cost-effectiveness analysis (IBCEA) is faced with a variety of limitations when selecting a programme of measures at the river basin scale.

First, the time step, either annual or seasonal (4 months in the case study), does not permit the assessment of intra-annual (monthly) deficits of water deliveries in relation to the demands. This also excludes the possibility of considering the

management of the reservoirs in the water resources systems, moving water over time and hedging releases to deal with imbalances in water availability. The IBCEA is a static analysis, whereas the management of the system requires a dynamic approach that considers water resources and demand variability over time.

The spatial scale adopted in the IBCEA, aggregated either at the basin or regional scale, is another significant limitation. Selecting measures to tackle a deficit estimated at the basin scale does not ensure that the environmental constraint defined at the water bodies will be met. The IBCEA is still based on pressure reduction and not on the real impact of the measures on the interconnected water bodies in the basin, therefore it does not account for upstream-downstream interactions. Basically, savings upstream will also benefit downstream water users. Because of these restrictions, the combination of measures resulting from the implementation of an IBCEA is not optimum, either from an economic or a water resources management perspective.

Overcoming these constraints was one of the reasons behind the development of the least-cost river basin optimization model, with the aim of being able to better represent the management of water resources at the river basin level, integrate the management of infrastructures and the hydrological variations, and allow a finer spatial and temporal resolution of the analysis. Results from this model are presented in subsequent sections, to support the selection of a cost-effective programme of adaptation measures. Further comparison between conventional cost-effectiveness analysis and least-cost river basin optimization approaches are summarized in Appendix I Comparison IBCEA vs. LCRBOM, together with the results of a comparison of their respective performance in the selection of measures under a same future scenario and budget constraints.

6.2 Scenario analysis

6.2.1 Baseline scenario

Using the optimization model, Agricultural Deficit Indices (ADI, section 3.4.3) were computed for the historical hydrology and current demands (baseline scenario) and

aggregated by sub-basin. Its spatial distribution was found to be uneven (Figure 6-3, top-right). In the baseline scenario, ADI reaches the maximum value (100 %) in the Mare (M4) and Jaur (J3) sub-basins, meaning that legal requirements are not fulfilled in these sub-basins (a deficit of magnitude equal to the demand occurs for a return period of less than 5 years). These sub-basins correspond to tributaries of the River Orb that do not benefit from regulation of an upstream reservoir. These water deficits are locally coherent with other results and observations for the river basin mentioned in previous studies, and actions are already being implemented to address these issues (Vier and Aigoui, 2011). In contrast with these sub-basins, the higher demand in the Orb sub-basins, which benefit from regulation from the upstream reservoir (O2, O4, O5, O6, O10 and O12), can be supplied as required for the baseline scenario. The reservoir filling and release strategy has generally been captured well, although we need to consider that we are using an optimization tool that is searching for an optimal solution (not necessarily the current situation). The results of the optimization model cannot, therefore, be formally validated against observations.

6.2.2 Business-as-usual scenario

In the future under a business-as-usual (BAU) scenario⁹, the ADI increases under the impact of higher demands and scarcer water resources. In addition to the basins that show a deficit under the baseline scenario (M4 and J3), three more downstream sub-basins (O8, O10 and O12) show deficits for the future scenario (Figure 6-3, top-right). Thus, the decrease in summer flow impacts, first, the sub-basins that do not benefit from flow regulation from the reservoir; then, the downstream sub-basins with the highest demands (Figure 6-3, top-left) and the lowest natural inflows. The impact of global change thus challenges the current protection against dry summers provided by the reservoir and underscores the

⁹ The business-as-usual and adaptation scenarios will be considered for the different climate change projections in the next section (6.6). However, we first perform an analysis based on one climate projection using downscaled data from the GCM Arpège to make it more understandable.

need for additional measures to meet environmental flow requirements and supply agricultural demands in the future.

6.2.3 Least-cost programme of adaptation measures

A least-cost PoM was selected using the LCRBOM developed. At the sub-basin scale, the spatial distribution of the volumes to be mobilized (sum of the volumes saved by water conservation measures and provided by capacity expansion measures); (Figure 6-3, bottom-left) and the associated costs (Figure 6-3, bottom-right) do not follow the pattern of the distribution of deficits (Figure 6-3, top-right). While the greatest deficits occur in tributaries M4 and J3 (ADI of 100 %), their contribution to the total cost and volume saved is low. This difference is explained by their lower demand, so there is less potential for water saving through efficiency improvements. The volumes saved and associated with these basins are lower in absolute terms than in other sub-basins; in fact, they would still require more savings to avoid deficits in their sub-basins. In contrast, the sub-basins with no deficit (O1, O2, O4, O5 and V3) have measures applied that also benefit other sub-basins. The downstream basins with the highest demand take up the biggest share of the new and saved water volume. Sub-basin O12 has a high ADI, but few measures are applied in this area, as it benefits from measures implemented further upstream.

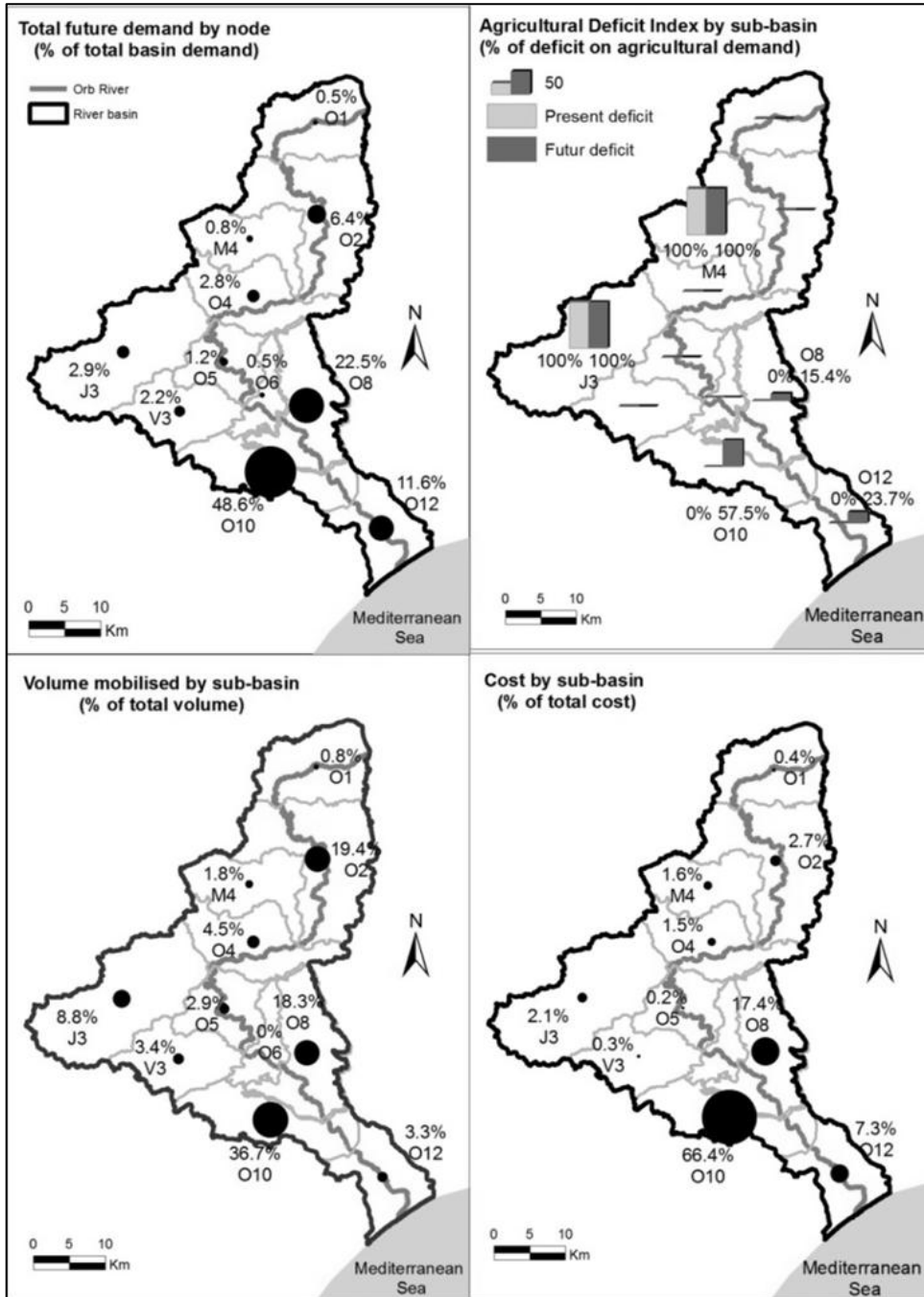

Figure 6-3 Results of the scenario analysis. Spatial distribution of: future demand in the Orb River basin (top-left); present and future agricultural deficit (top-right); saved and new (mobilized) water volume by sub-basins (bottom-left); and cost by sub-basin (bottom-right).

6.3 Trade-off analysis

The least-cost river basin optimization model is then used to assess possible trade-offs between agricultural demand, environmental flow requirements and the cost of the programme of measures. The constraints of the optimization are relaxed or strengthened, on a one-at-a-time basis, to represent variation in the demand and/or environmental requirements, and quantify their consequences on the cost of the PoM. Once the constraints are changed in relative or absolute terms, loops of optimization allow marginal costs and trade-offs to be assessed for the different scenarios. To illustrate the potential of the model, the variations have been investigated under the following parameters: agricultural demand at the catchment scale; environmental requirements at the sub-basin scale, and a combined analysis on environmental requirements and agricultural demands at the local level.

6.3.1 Variations in agricultural demand at the basin scale

We have identified the estimation of future agricultural demand, which combines a wide range of uncertainties from climate and socio-economic scenarios, as the most uncertain component of the model. On one hand, it depends on uncertainty associated with the modelling parameters and its propagation along the modelling chain that would require further assessment following a classic sensitivity analysis (Refsgaard et al., 2007). On the other hand, it also depends on the irreducible uncertainties regarding, for instance, the agricultural development policy. To represent the effect of various agricultural development scenarios, we analyse the consequences of variations of the agricultural demand at the basin scale at settings of +/- 5% and 10 % around the estimated level (Figure 6-4).

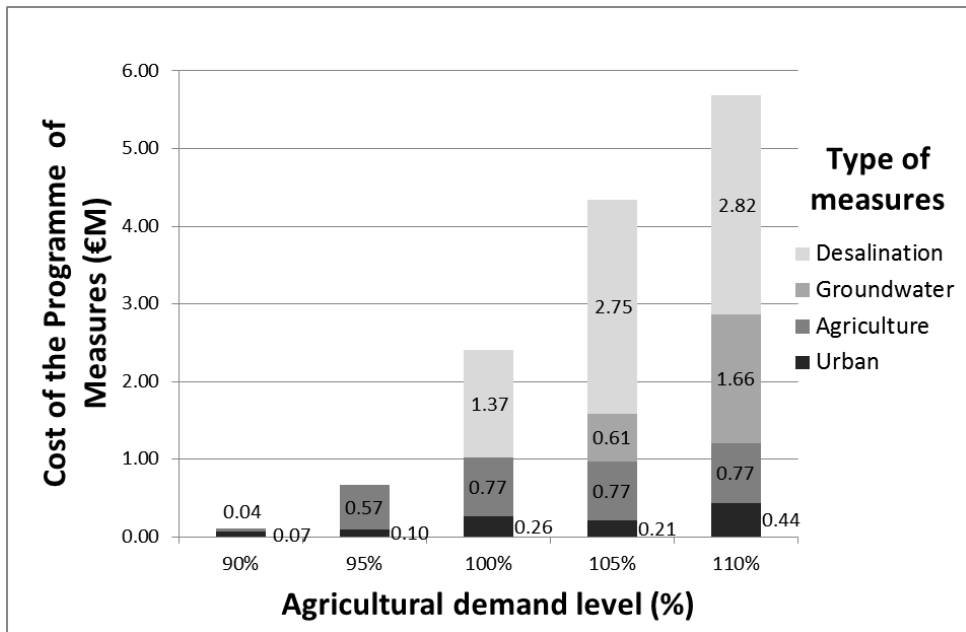

Figure 6–4 Cost of the PoM for different levels of agricultural demand at the basin scale

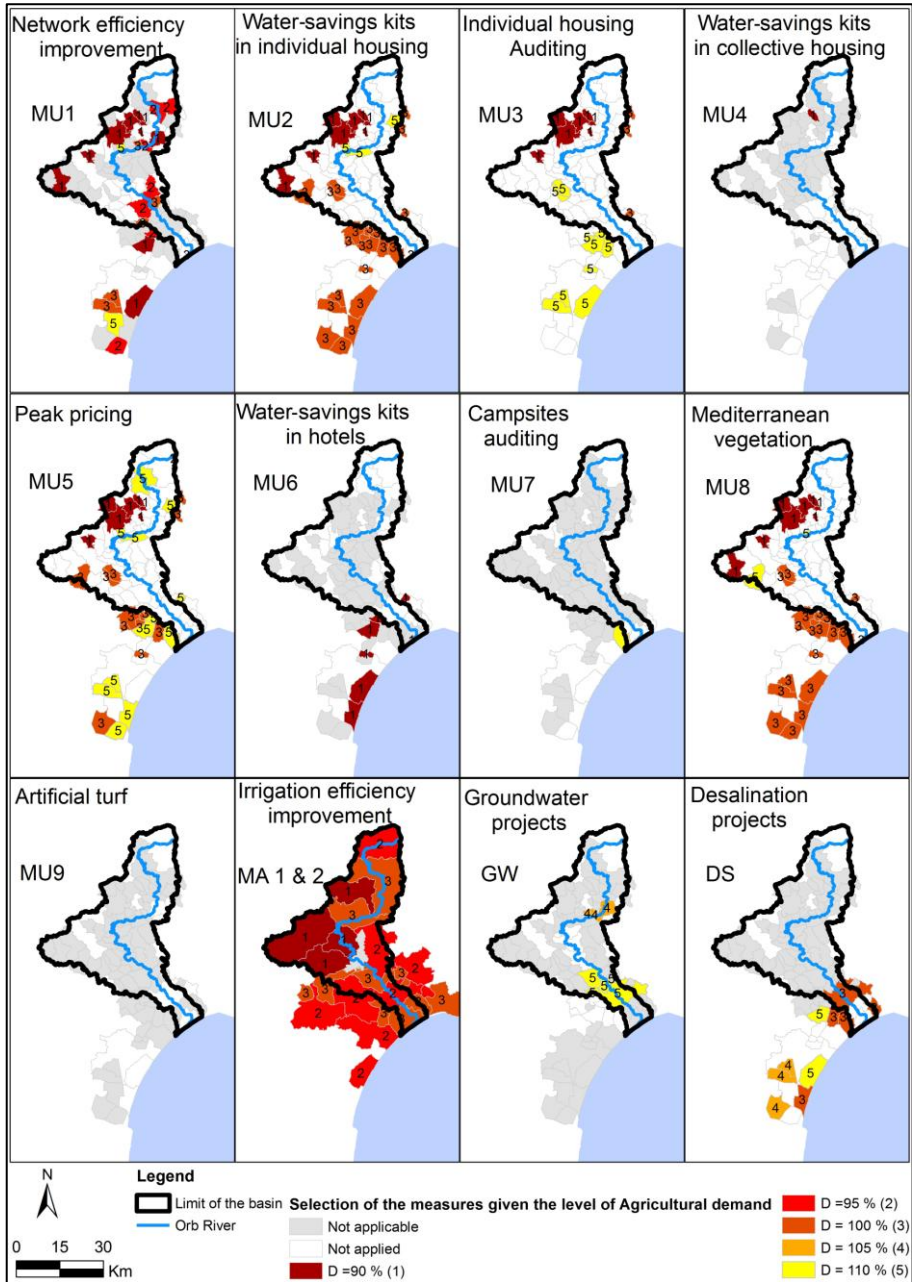

Figure 6-5 Distribution of measures selected given an increasing level of agricultural demand. The number and colour indicate at which level of demand the measure is first applied (e.g. If equal to 1 the measures is applied from the level of demand equal to 90 % of the total). Measures are presented in detail in section 5.2.4. The agricultural measures are mutually exclusive; therefore they are presented on the same map.

A +/-10 % variation in the agricultural demand at the basin scale, representing a volume of +/- 2.9 Mm³ per year, corresponds to a variation in the cost from €0.11M to €5.68M (-95% and +137 %). In the absence of a better estimation of the future demand, it highlights the key issue associated with agricultural development in the management of water resources at the basin scale. The skyrocketing development of irrigated vineyard in the basin or the impact of climate change could result in such a range of variation that it could challenge the management of water resources or represent an unaffordable cost.

Demand management vs. capacity expansion measures:

The estimation of the cost of the PoM illustrates, then, the interest in demand management measures and the fact that expensive capacity expansion projects could be avoided if the increase in agricultural demand is limited. For the lowest level of agricultural demand (90 % and 95%) only demand management measures are selected (MU 1, 2, 3, 4, 5, 6, 8 and MA1 and 2 show indices of 1 or 2, corresponding to a level of 90 and 95 % of the agricultural demand respectively in Figure 6-5). Capacity expansion measures are selected only once the increase in agricultural demand equals or exceeds 100% (GW or DS with indices higher or equal to 3 in Figure 6-5).

Prioritizing measures between Urban and Agricultural sectors:

The programme of measures is designed to reduce the deficit in agricultural demand, assuming that urban demands are always satisfied. Nevertheless, measures are applied in either the agricultural or the urban demand (Figure 6-5). The measures on the agricultural demand (MA1 and MA) are applied in all the agricultural demand units of the basin and from the lowest level of agricultural demand (lower or equal to 100%), highlighting the efficiency of these measures in comparison to the others.

For the urban demand, the measure most applied is the network efficiency improvement (MU1), which is recommended over the whole urban demand area for the lowest level of agricultural demand. MU2, MU8, MU3, MU5, MU4, and MU6 are also selected but mainly on tributary sub-basins with high deficits (M4, J3). In the

urban area located outside of the catchment benefitting from the Réals water transfer (the Aude littoral, South West), MU2 and MU8 are applied for the lowest level of agricultural demand (100 %). The other urban measures apply only for the highest level of agricultural demand (110 %). Some urban measures present little interest, such as MU4, MU7 and MU9, and could be discarded from the programme of measures. Groundwater measures (GW) and desalination measures (GW and DS), even if spatially limited, present some interest locally to alleviate the burden on some urban demand unit. However, they are applied only for the highest level of agricultural demand.

This distribution of measures by sector raises the following concerns. First, agricultural measures should be applied, as they are more efficient, in order to guarantee that environmental flow requirement and urban demand are satisfied. However, from a dynamic perspective, if the agricultural sector wants to develop its irrigation capacity, more expansive capacity extension measures, such as groundwater or desalination, are needed. The model does not provide answers on who should be given priority and who has to pay the costs, but it could provide some food for thought in a participatory decision-making process, and in defining the trade-offs between the actors involved in the river basin.

6.3.2 Trade-offs between environmental flows and cost of adaptation

The model can also be used to prioritize where it is economically more efficient to concentrate efforts on a more precise definition of the environmental flow requirements. Indeed, the variations in the cost of the PoM changes with the level of environmental flow by sub-basins (Figure 6-6). Similar variations, +/- 5 %, in the environmental flow thresholds applied in different sub-basins have varying impacts on the cost of the programme of measures. For a similar variation of the flow requirements, the impact on the cost of the PoM is greater if it is made in O1. Although the sub-basins O2 and O4 present higher environmental flow requirements than O1 (0.85, 1.7, and 0.67 m³/s respectively), the cost of the programme of measures is less sensitive to the definition of their environmental

flow requirements. These results highlight the strategic importance of ecological flow definition in the sub-basin O1 – the location of the Monts d’Orb reservoir, which regulates most of the flow of the Orb River, especially the summer low flows. Indeed, the environmental flow applied in O1 is also a minimum flow release requirement for the reservoir. Therefore, decision makers could decide to set the priority on the definition of the flow regime in this section of the Orb River to balance cost and environmental requirements.

Clearly, the definition of environmental flow requirements is driven by ecological considerations. However, the success of their implementation depends on other factors, such as the economic capacity of the river management authority to apply water conservation measures. Therefore, the modelling approach allows investigating the relation between environmental flow requirements and the cost of their implementation.

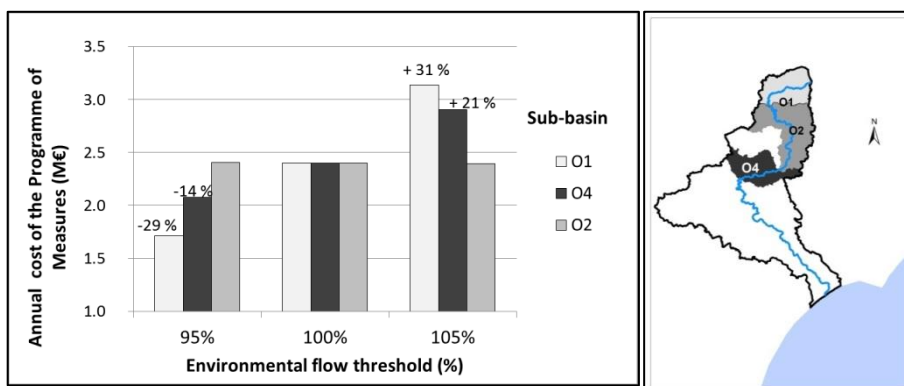

Figure 6–6 Cost of the PoM for different environmental flow thresholds at three sub-basins (O1, O2 and O4)

6.3.3 Trade-offs between environmental flow, adaptation cost and agricultural demand.

We assessed the trade-offs between the cost of the PoM, the threshold set on environmental flow requirements and the level of agricultural demand. A similar variation in volume (-0.1 and + 0.1 Mm³/month) is applied to the environmental flow upstream in the basin at O1, and to the agricultural demand of the downstream agricultural demand unit, a14 (Figure 6-7). In this case, the total cost of the PoM

presents a higher sensitivity to variation in agricultural demand at a14 than to environmental flows at O1. The cost of the PoM increases by + €0.499M once the agricultural demand at a14 increase by + 0.1 Mm³/month (the grey arrow in Figure 6-7), and it increases by + €0.497M when the environmental flow increases by + 0.2 Mm³/month at O1 (the bold, dotted arrow on Figure 6-7).

An almost fixed increase in the cost of the PoM, allows a decrease of 0.1 Mm³/month in the agricultural demand at a14, or an increase in the environmental flow of 0.2 Mm³/month at O1. As agricultural demand is a consumptive use, no water returns to the Orb basin, whereas the environmental flow requirements only change the timing of the flow. Economic assessment could be balanced with environmental and agricultural impact to take into account the various components of an integrated management of water resources at the basin scale.

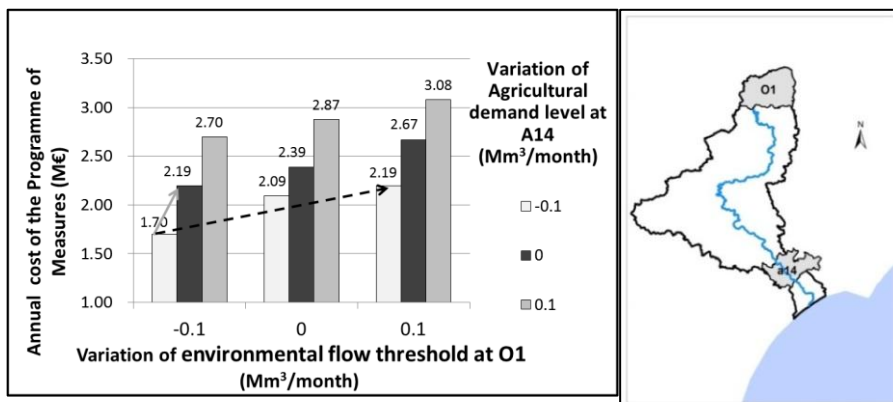

Figure 6–7 Cost of the Programme of Measures for different levels of agricultural demand

6.4 Climate check

6.4.1 Considering different climate projections

Up to now, the scenario and trade-offs analysis have been performed under one single climate projection. However, a large range of variation between the climate projections has been observed and needs to be considered. Nine different adaptation PoMs were defined through the LCRBOM, one for each climate

projection. The PoMs were characterized in terms of their cost and the agricultural DRI under each climate projection, assuming business-as-usual (BAU), i.e. without adaptation measures (Table 6-1).

In 3 cases out of 9, there was no need for a PoM in the future situation. In the 6 remaining cases, the annual cost of the PoM ranged from €0.2M (CCMA scenario) to €6.7M in the worst case (NCAR scenario). The relation between the cost of the PoM and the DRI without adaptation is not direct, given that some scenarios with similar DRI (0.940 and 0.941 for Arpège and GFDL respectively) lead to different PoM costs (€2.7M and €1.5M respectively). In the following sections, the different PoMs are identified by the name of the GCM for which they have been optimized (e.g. the PoM GFDL is the least-cost PoM optimized for the climate projection coming from the GFDL general circulation model).

Climate projection	DRI without PoM	Cost of the PoM (€)
IPSL	1.000	-
MPI	1.000	-
MRI	1.000	-
CCMA	0.987	214,000
GISS	0.961	772,000
Arpège	0.940	1,570,000
GFDL	0.941	2,730,000
CNRM	0.863	2,910,00
NCAR	0.871	6,720,000

Table 6-1 Demand Reliability Index (DRI) under a business-as-usual scenario and cost of the optimal PoM for the 9 adaptation scenarios.

In view of the large range of variation between the PoMs defined through the LCRBOM, stopping at this stage would provide limited information to support decision making, given that one adaptation PoM needs to be selected in the end. To deal with this variability and uncertainty concerning the definition of least-cost adaptation measures for climate change, we have compared the measures selected in the different climate change projections to identify those that are most often selected, under the assumption that this could indicate a higher level of confidence in the selection of such measures (Figure 6-8).

The level of confidence is higher for the selection of the agricultural measures, up to 6 in most of the irrigated areas, meaning that irrigation efficiency improvement measures should be prioritized. Regarding urban demand, the measure most applied is that of improving network efficiency (MU1), with levels of confidence reaching up to 6 over the whole urban demand area. The other measures, such as MU2, MU3, MU5 and MU8, are also selected, but with lower levels of confidence. Some urban measures, such as MU4, MU6, MU7 and MU9, do not raise that much interest under the scenarios considered and could be discarded from an adaptation PoM. Groundwater measures (GW), even if spatially limited, produce some interest locally, to alleviate the burden on some Urban Demand Units, with confidence levels reaching up to 3. Desalination measures (DS) are included in the PoMs in only two cases, corresponding to the driest climate projections.

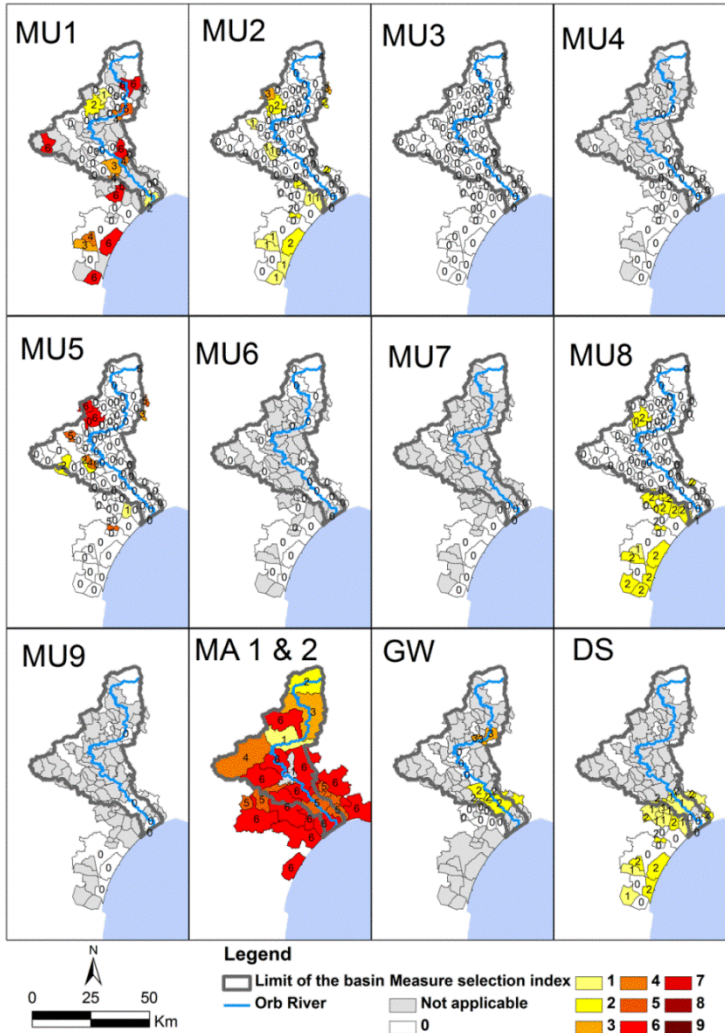

Figure 6–8 Distribution of the measures applied in the Orb River basin under 9 different climate projections. The number and colours indicate the level of confidence in the selection of the measure, ranging from 0 (white) to 9 (dark red), adding 1 each time the measure is selected under one of the 9 climate projections. The agricultural measures MA1 and 2, mutually exclusive, are presented together (measures are described in Table 5-6).

6.4.2 Assessing the performance matrix

To provide more insights into the definition of the final adaptation plan, we suggest evaluating the performance of each of the 9 PoMs, in succession, through the other climate projections, so that we can assess the robustness of the performance

of the PoMs under conditions that they have not been designed for; this was described as a climate check in the method section (3.5).

The first element of the climate check (8) is to assess the performance matrix (Table 6-2) that presents the result of the optimization for a given PoM (row) under different climate projections (column) in terms of agricultural demand reliability and cost. The results have been ordered in rows according to the increasing cost of the PoM, and in columns by the corresponding climate projection. In the performance matrix, the bold numbers of the diagonal of DRI equal to 1 correspond to the cases where the PoM is checked against the climate projection for which it has been optimized (e.g. the PoM Arpège has been optimized for the climate projection Arpège). Therefore, the DRI is equal to 1, as this was one of the constraints of the optimization. DRIs lower than 1 mean that the level of demand that can be supplied for the given reliability is below the legal requirement (i.e. the deficit in water supply to the agricultural sector is higher than that allowed). The lower the DRI, the greater the deficit is.

We have considered 3 categories of DRI as illustrative guidelines for the state of the system. Ideally this should be linked to the impact of the deficit on agricultural production, but this was beyond the scope of the research. Below the diagonal (green area), DRIs are equal to 1 and, above it, DRIs decrease by row – from left to right; and by column – from bottom to top. It can be seen that the greater the cost of the PoM, the higher the DRI, with the lowest DRI obtained in the cases where no PoMs are applied (IPSL, MPI and MRI) and the highest DRI observed for the most expensive PoM (NCAR). Some irregularities to that rule are observed between the PoM designed under the GFDL and the Arpège climate projections (even though it is more expensive, the GFDL PoM results in a lower DRI than the Arpège scenario for the Arpège climate projection). A trade-off appears between the cost of the PoM and an acceptable level of reliability of irrigated agriculture supply.

Programme of Measure (PoM)	Demand reliability index (0 to 1) under climate projection									Cost of the PoM (€)
	IPSL	MPI	MRI	CCMA	GISS	Arpège	GFDL	CNRM	NCAR	
No PoM	1.00	1.00	1.00	0.99	0.96	0.94	0.94	0.86	0.87	0
PoM IPSL	1.00	1.00	1.00	0.99	0.96	0.94	0.94	0.86	0.87	0
PoM MPI	1.00	1.00	1.00	0.99	0.96	0.94	0.94	0.86	0.87	0
PoM MRI	1.00	1.00	1.00	0.99	0.96	0.94	0.94	0.86	0.87	0
PoM CCMA	1.00	1.00	1.00	1.00	0.97	0.95	0.95	0.89	0.89	213,497
PoM GISS	1.00	1.00	1.00	1.00	1.00	0.98	0.98	0.94	0.94	771,784
PoM Arpège	1.00	1.00	1.00	1.00	1.00	1.00	0.99	0.97	0.95	1,565,466
PoM GFDL	1.00	1.00	1.00	1.00	1.00	0.99	1.00	0.96	0.95	2,730,458
PoM CNRM	1.00	1.00	1.00	1.00	1.00	1.00	1.00	1.00	0.98	2,905,221
PoM NCAR	1.00	1.00	1.00	1.00	1.00	1.00	1.00	1.00	1.00	6,701,525

Table 6-2 Performance matrix of the 9 programmes of measures (lines) under the 9 climate projections (columns). The categories are represented by the colours (DRI=1 (Green), between 1 and 0.95 (Yellow), from 0.95 to 0.90 (Orange) and below 0.9 (Red)).

Programme of Measure (PoM)	Regret on the Demand Reliability Index under climate projection									Regret on the Cost of the PoM	Average Regret Agri DRI	Weighted regret
	IPSL	MPI	MRI	CCMA	GISS	Arpège	GFDL	CNRM	NCAR			
Without PoM	0.00	0.00	0.00	1.00	1.00	1.00	1.00	1.00	1.00	0.00	0.67	0.33
PoM IPSL	0.00	0.00	0.00	1.00	1.00	1.00	1.00	1.00	1.00	0.00	0.67	0.33
PoM MPI	0.00	0.00	0.00	1.00	1.00	1.00	1.00	1.00	1.00	0.00	0.67	0.33
PoM MRI	0.00	0.00	0.00	1.00	1.00	1.00	1.00	1.00	1.00	0.00	0.67	0.33
PoM CCMA	0.00	0.00	0.00	0.00	0.70	0.81	0.81	0.80	0.83	0.03	0.44	0.24
PoM GISS	0.00	0.00	0.00	0.00	0.00	0.37	0.36	0.42	0.49	0.12	0.18	0.15
PoM Arpège	0.00	0.00	0.00	0.00	0.00	0.00	0.18	0.24	0.37	0.23	0.09	0.16
PoM GFDL	0.00	0.00	0.00	0.00	0.00	0.02	0.00	0.32	0.41	0.41	0.08	0.25
PoM CNRM	0.00	0.00	0.00	0.00	0.00	0.00	0.00	0.00	0.14	0.43	0.02	0.22
PoM NCAR	0.00	0.00	0.00	0.00	0.00	0.00	0.00	0.00	0.00	1.00	0.00	0.50

Table 6-3 Regrets matrix calculated to compare the performance of the 9 programmes of measures according to agricultural Demand Reliability Index and annual costs

6.4.3 Regret matrix

Drawn from the performance matrix, the regret matrix enables the comparison of different criteria (Table 6-3). It illustrates how the best performing PoMs for one criterion are not those of least-regret. The decision to not apply any PoM is the best-performing strategy according to the cost criterion (regret = 0) but the worst in regard to the agricultural DRI (regret = 1). In contrast, the most expensive PoM obtained under the NCAR climate projections is the best-performing strategy in terms of DRI (regret = 0) but the worst in terms of cost (regret = 1). Given the weight assigned to the different performance criteria, the least-regret option would be to apply the PoM defined under the GISS climate change projection corresponding to an aggregated regret of 0.15 balancing the cost of the PoM (€0.7M) with an average DRI of 0.98. The PoM corresponding to the Arpège climate change projection, with aggregated regrets of 0.16, also seems to be worthy of further consideration.

6.4.4 Analysis of preferences

The final selection of a PoM will depend on the respective importance given to each criterion in line with the preferences of the stakeholders and decision makers. The preference matrix illustrates the range of variation in the aggregated regret for different preferences. Three different preference arrays are considered corresponding to: 1. an equal importance given to agricultural demand and to adaptation PoM cost, 2. a preference given to the cost of the adaptation PoM, and 3. A preference given to the agricultural demand ($w_c=1/2$; $w_c=1/4$, $w_c=3/4$ respectively, see Table 6-4). When more importance is given to the cost indicator, the less expensive PoMs present less regret. Correspondingly, the PoMs with lower agricultural deficit also have a lower aggregated regret. The extreme programmes in terms of cost and DRI are also the most sensitive to the weighting of the regrets (variation of 0.33 and 0.5 for the No PoM and NCAR respectively), whereas the PoM least affected by the variation of the weights is the GISS PoM (0.04). These elements could be useful in terms of discussion and negotiations with the stakeholders on the selection of the adaptation PoM, given that they provide an

assessment of the different choices and performances possible in terms of cost and the reliability of agricultural demand.

PoM	Weighted regret (%)		
	1. 25 C/75 A	2. 50 C/50 A	3. 75 C/25 A
No PoM (IPSL, MPI, MRI)	0.50	0.33	0.17
CCMA	0.34	0.24	0.13
GISS	0.17	0.15	0.13
Arpège	0.12	0.16	0.20
GFDL	0.16	0.25	0.33
CNRM	0.12	0.22	0.33
NCAR	0.25	0.50	0.75

Table 6-4 Preference table of the aggregated regret for different combinations of weight between the agricultural DRI (% A) and the cost of the PoM (% C).

The least-regret option is indicated in bold for each weighting, the colours are decided arbitrarily to provide four categories (below 0.20 (Green); From 0.2 to 0.3 (Yellow); from 0.3 to 0.4 (orange); more than 0.40 (red)).

6.5 Final comments on the selection of cost-effective adaptation measures

The first steps of the general framework to integrate top-down and bottom-up approaches have been implemented in a real case study, in the Orb River basin, to define a cost effective adaptation programme of measures at the local level. The least-cost river basin optimization model developed provides the possibility of integrating results from both approaches in order to prioritize the measures to be applied, taking into account the spatial distribution of the measures at the river basin scale and the temporal variation of the hydrology. Measures are selected to meet management objectives, defined as constraints, and the trade-offs between the cost of the programme of measures and the management objectives can be

assessed. The method developed to take into account the uncertainty associated with climate change projections confirms that demand management measures, such as network efficiency, improvements in irrigation and urban supply, seem to be the least-regret options. The need for supply-side capacity expansion measures, such as desalination plants or ground water exploitation, is limited, given their high investment cost; they are less cost-effective in a context of climate change uncertainty. The trade-offs between the cost of the adaptation plan and the reliability on the supply of agricultural demand have been identified. Depending on the preferences of the decision makers, the appropriate level of adaptation could be defined to adapt to climate change.

Without adaptation measures, the deficit in agricultural supply remains at what could be considered an acceptable level, even in the driest regions of the world, which challenges the need for adaptation in the Orb River basin. One reason for the relatively good coping capacity of the Orb River basin is linked to the storage capacity of the reservoir located upstream of the basin, which is able to regulate the variations in runoff. In contrast, meeting the legal requirement to supply agricultural demand under each scenario could be far too expensive to be assumed by the local actors. These variations highlight the interest of the framework presented. If the programme of adaptation measures is designed under only one climate projection, clearly, it could be inefficient, either by being over-designed at a very high cost, or under-designed at a low cost, but failing to provide the level of reliability required for the supply of demand. In this way, fruitful insights for adaptation decision makers are provided, to assist them in the design and discussion of adaptation plans with stakeholders.

Chapter 7 Addressing the cost allocation issue

An adaptation plan at the river basin scale, such as those presented in the previous chapter, encompasses measures all over the river basin area and involves multiple stakeholders, often with conflicting goals and priorities. The approach described up to this point follows a central social-planner perspective, taking advantage of upstream/downstream interactions to ensure efficiency at the river basin scale. It assumes the central planner will be able to implement the plan. However, in reality, the implementation and financing of such plan requires a certain consensus among the different actors involved. The decision on the allocation of the cost needs to be considered fair or equitable by the different actors of the basin in order to gain support and acceptability, thus increasing the probability of its implementation being successful.

From a pragmatic perspective, two different approaches could be implemented for the definition of an acceptable cost allocation scenario ⑨. First, stakeholders could negotiate a cost allocation scenario, including the possibility of side payments if needed. This unanimously approved allocation scenario will then be enforced by the local water authority. Alternatively, the local water authority could try to design and implement an equitable cost allocation rule. Since there is no standard definition of equity or fairness, the definition of the rule could be based on the preferences of stakeholders for varying social justice principles.

This chapter addresses the cost allocation problem following each of these approaches successively by implementing methods from cooperative game theory (7.1) and the social justice approach (7.2). The comparison of the cost allocation scenarios (7.3) brings contrasted insights to inform the decision-making process at the river basin scale, potentially reaping efficiency gains from cooperation in the design of a river basin adaptation plan.

7.1 Applying the game theory approach

7.1.1 Representation of the Orb River basin

In regard to the implementation of the game theory concepts, we propose a simple representation of the Orb River basin and of the stakeholders involved in the implementation of the programme of measures. We basically assume that the basin comprises three main sub-basins A, B and C. The upstream users (A, Figure 7-1) correspond to rural areas with low density population, and gravity irrigation systems. Sub-basin B is the users supplied by the transfer infrastructure taking water from the Orb River at Réals. The downstream users (C) correspond to a densely populated urban area and an intensive agricultural area. In order to simplify the formulation of the problem, we also consider that management decisions are taken by one player in each basin. As highlighted in chapter 4, one of the main features of the basin is that water flows can be regulated thanks to a reservoir located upstream (Monts d'Orb reservoir). This reservoir was constructed to offset water abstraction of player B and to maintain a minimum flow downstream of the main withdrawals made by B (Réals pumping station).

In a non-cooperative case, players do not exchange information; each one would design his own programme of measure at the sub-basin level to ensure that the water supply of users in his area is satisfied, and to meet the environmental target at the outlet of his sub-basin. Player B can optimize the management of the reservoir to meet his demand and minimum flow constraints, without considering the other two players. Player B then has to pay the cost of operating and managing the reservoir on his own (€690,000 per year), and to implement additional measures if necessary. Players A and C also implement measures (water conservation or supply augmentation) without being able to influence the management of the reservoir. We shall name the PoM corresponding to these non-cooperative strategies as PoM_A , PoM_B and PoM_C , the stand-alone solution of players A, B and C respectively, and their cost C_A , C_B and C_C .

Now the three players can also decide to cooperate to reach the objectives in the three basins with the least cost for the society as a whole (A, B and C together). In

this case, cooperation means: 1. that the management of the reservoir is optimized in view of meeting the three environmental flow constraints in sub-basin A, B and C; 2. the additional measures are also identified, in view of minimizing their total cost for the coalition. Let us call this PoM corresponding to the cooperative case PoM_{ABC} and its cost C_{ABC} . The measures of the least cost PoM_{ABC} will only be implemented by A, B and C if they agree on how to share their cost. We can expect each player A, B and C to compare the cost of the stand-alone solution (C_A , C_B , C_C) with the share of the cost P_{ABC} they would have to pay (called Y_A , Y_B , Y_C), if they cooperated.

Intermediary solutions also exist, where only two players would cooperate while the other would decide to stand alone. The LCRBOM model developed previously is used to assess the characteristic function of the game defined as the cost of the PoM for A, B and C in the different coalitions by modifying the objective function and constraints. The PoM are optimized for each coalition, assuming that when one player or group optimizes its PoM, the others are playing their stand-alone solution. We present the results in the following sub-section. The management of the reservoir is optimized for player B or the coalition he belongs to. The results are presented in the next section.

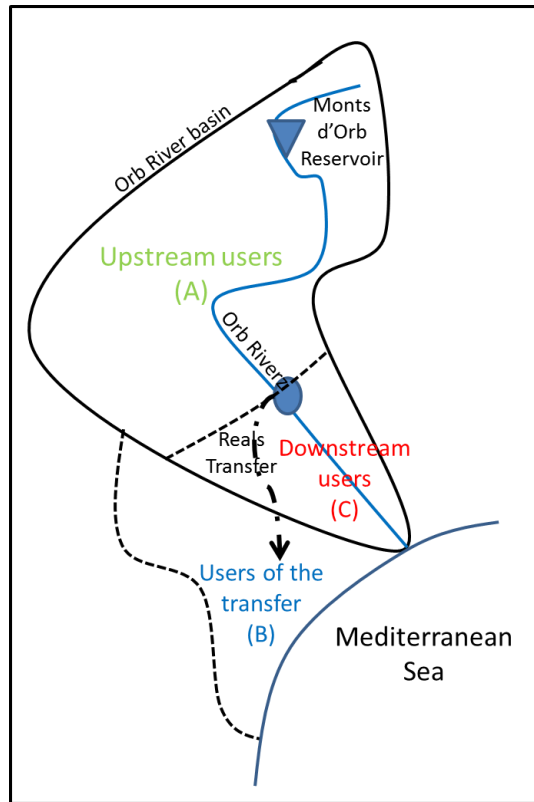

Figure 7–1 Schematic representation of the Orb River basin to address the cost allocation problem

7.1.2 The characteristic function

The cost of the coalition formed by the three users together (grand coalition) is less than the sum of the costs of the three stand-alone strategies (Table 7-1), thus providing incentives for cooperation. However, the contributions of the different users have to be considered to ensure that the three players will join the grand coalition. Indeed, the distribution of the cost of the stand-alone solutions is unbalanced. Whereas the upstream users (A) have a low-cost stand-alone strategy (€0.12M) that could be an incentive to stand alone, the downstream users (C) have the highest cost (€5.15M), and would therefore be the main beneficiaries of cooperation. These differences must be taken into account in the definition of a fair allocation of the cost between the members of the grand coalition, to ensure their cooperation.

Coalition	Cost (€M)			Total Cost
C_A, C_B, C_C (Stand alone)	0.12	0.69	5.15	5.96
C_{AB}, C_C	0.79		5.15	5.93
C_A, C_{BC}	0.12	4.74		4.86
C_B, C_{AC}	0.69	2.81		3.50
C_{ABC} (Grand coalition)	3.05			3.05

Table 7-1 Characteristic function of the 3-player cost allocation game

7.1.3 The core of the game

Under the cooperative game theory, a cost allocation must follow the principles of rationality, marginality and efficiency to ensure the solution is equitable among different players (Section 3.6.2). Applying these principles to the solution space of the possible cost allocation, determines the boundaries of the Core of the game (Table 7-2). In other words, the rationality principle gives an indication of the highest share a player would accept before leaving the coalition for the stand-alone solution (rationality). The marginality principle indicates the lowest share a player should pay given the additional cost of having him in the grand coalition. The efficiency principle only ensures that all costs are allocated.

The boundaries of the Core calculated in the cost allocation problem in the Orb River basin indicate that for a cooperative agreement to be found, downstream users (C) should pay the highest share of the total cost (more than 74 %). In addition, downstream users could provide incentives, such as a monetary transfer within a compensation scheme to the other users, to ensure that they join the grand coalition (Y_C can be higher than 100 % of the total cost, and Y_A can be negative). In this case the transfer received by player A has an upper bound fixed at €1.69M. In contrast, player C could pay a transfer to A and B up to €2.10M (=5.15-3.05). As mentioned previously, C was the player with the greatest interest in the coalition due to the elevated cost of his stand-alone solution. The cost allocation should take into account this interest by allocating a higher share to C,

and C could even provide incentives to join the grand coalition from a redistribution of the cost saved in comparison to a stand-alone solution.

Principle	Player cost allocation	Value (Cost in €M)	% of ABC Cost
Efficiency (all cost are allocated)	$Y_A + Y_B + Y_C =$	3.05	100%
Rationality (Player X cannot pay more than its stand alone cost, $Y_X \leq$)	$Y_A \leq$	0.12	4%
	$Y_B \leq$	0.69	23%
	$Y_C \leq$	5.15	169%
Marginality (Player X cannot pay less than its marginal cost, $Y_X \geq$)	$Y_A \geq$	- 1.69	-55%
	$Y_B \geq$	0.24	8%
	$Y_C \geq$	2.26	74%

Table 7-2 Boundaries of the Core of the 3-player cost allocation game

7.1.4 Solution concepts

In the search for a single solution, the Shapley value and the Nucleolus were calculated (Table 7-3). They both suggest that the cost allocation should ensure that the downstream player C pays more than the total cost, in order for the benefits of the grand coalition to be shared equitably. In this case, the upstream player A will receive a compensatory monetary transfer to pay for their measures, as these benefit the downstream users. Both solutions belong to the core, which should ensure their stability and the agreement to form the grand coalition.

Solution concept	Shapley	Nucleolus
A	-29.3%	-47.8%
B	11.5%	15.2%
C	117.8%	132.7%

Table 7-3 Cooperation game theory solution for the 3-player cost allocation game

7.2 Applying the social justice approach

7.2.1 Defining cost allocation scenarios in practice

The general conceptions of social justice defined previously (section 3.6.3) were used to formulate cost allocation scenarios specifically applied to the Orb River basin case study. The formulation of these scenarios was adapted, based on discussions with local key informants. They are briefly presented below.

- Principle of strict equality

S1: Allocation proportional to water withdrawals. Each water user pays a share of the cost of the adaptation plan proportionally to the volume withdrawn (as a % of total abstraction in 2030). An upstream or downstream user that withdraws 10 % of the total volume of water withdrawn would pay 10 % of the total cost of the plan. This allocation is based on a principle of strict equality.

- Principle of prior appropriation

S5: Allocation taking into account the initial function of the Monts d'Orb reservoir. The upstream Monts d'Orb reservoir was initially built to compensate the agricultural and urban users affected by the downstream water transfer. Therefore, the cost of the adaptation plan is allocated between the users not benefitting from this transfer (A and C), considering that the users of the water transfer (B) implicitly have a right to the water stored in the reservoir.

S9: Allocation to water users located outside the basin. The cost is allocated only to the water users outside the Orb River basin (belonging to B) to allow them to keep benefitting from the water transfer. Indeed, no adaptation plan would be needed in the absence of this transfer. Cost is shared proportionally to their water withdrawals respectively. In this scenario, fairness is considered as giving the water users that belong to the river basin the priority to use its resources.

S4: Allocation proportional to deficits. Costs are allocated to the users that would experience a deficit in 2030 without any action plan. Those without deficit

are not required to contribute even if measures are applied in their area to avoid deficit elsewhere. This scenario takes into account that some sub-basins are water-rich and their water savings will mainly benefit other water-poor sub-basins. Savings would not be needed in their own interest, instead considering that the existing resources would be enough, and that they belong to them.

- Desert principle

S3: Allocation proportional to savings efforts. Each water user is allocated an abstraction quota calculated by the river basin authority based on technical criteria. In urban water supply, this quota takes into account: the type of water supply service (urban or rural), the presence of economic and industrial activities, and the efficiency of water supply networks. In the agricultural sector, the quota accounts for the irrigated area and the type of crops and the efficiency of irrigation. Users pay in proportion to their abstraction excess in comparison to this quota. This scenario rewards the efforts already realized by each user to improve his water efficiency.

S2: Allocation proportional to the increase in water abstraction from 2008 to 2030. Each user pays in proportion to his increase in water abstraction between 2008 and 2030 as a percentage of the total increase at river basin level. This allocation relies on the fact that no adaptation would be needed if there was no increase in demand (the effect of climate change alone is not enough). The cost of the adaptation plan is therefore allocated between the users responsible for this increase, rewarding those that have controlled their increase in demand.

S8: Allocation proportional to summer abstractions. The adaptation plan is mainly designed to supply the summer peak demand (from May to September). Thus, its cost could be allocated in proportion to the water abstractions during this period. This scenario increases the share paid by seasonal users, such as the agriculture and touristic sectors.

-
- Difference principle

S6: Allocation following the users' capacity to pay. This scenario assumes that payment must be proportional to the financial capacity of the users. It considers it fair to ask the urban and touristic users to pay more than the agricultural users. The cost is allocated in proportion with the abstractions and then weighted proportionally to the value associated with the water uses.

- Equal opportunity principle

S7: Allocation proportional to the wealth of the territories. The cost is allocated taking into account the wealth produced in each territory (sub-basin). It assumes as fair that rich urban territories pay more than poor rural ones, for instance. Cost is allocated in proportion to the volume abstracted, weighted by a factor proportional to the wealth of each territory (sub-basin).

7.2.2 Field survey

In order to understand the perception the local actors have of these different social justice principles, a survey was realized. 15 key-informants (see map 7.2 and Appendix J from different areas located inside or outside the basin, upstream or downstream, and different sectors (urban/agricultural) were interviewed in semi-structured face-to-face interviews. First, the context of the adaptation to climate change was introduced, as well as the measures probably needed to ensure that water management objectives are met at the river basin scale. Then, the 9 scenarios were presented and discussed with the key informants prior to asking them if they considered each scenario to be an equitable way to allocate the cost of the programme of adaptation measures (Figure 7-2).

Judging from the results of this survey, the scenario perceived as the most equitable is the one acknowledging the efforts in terms of water savings already realized by the different users (S3). This scenario was chosen almost unanimously by the key informants interviewed, who agreed on the common value of rewarding effort (desert principle). The main restrictions being based on the difficulty of technically defining the saving objectives and the unfair burden placed on users

that could already be having difficulty efficiently managing their water services (rural municipalities with less resources and a less efficient network than richer urban municipalities, for instance).

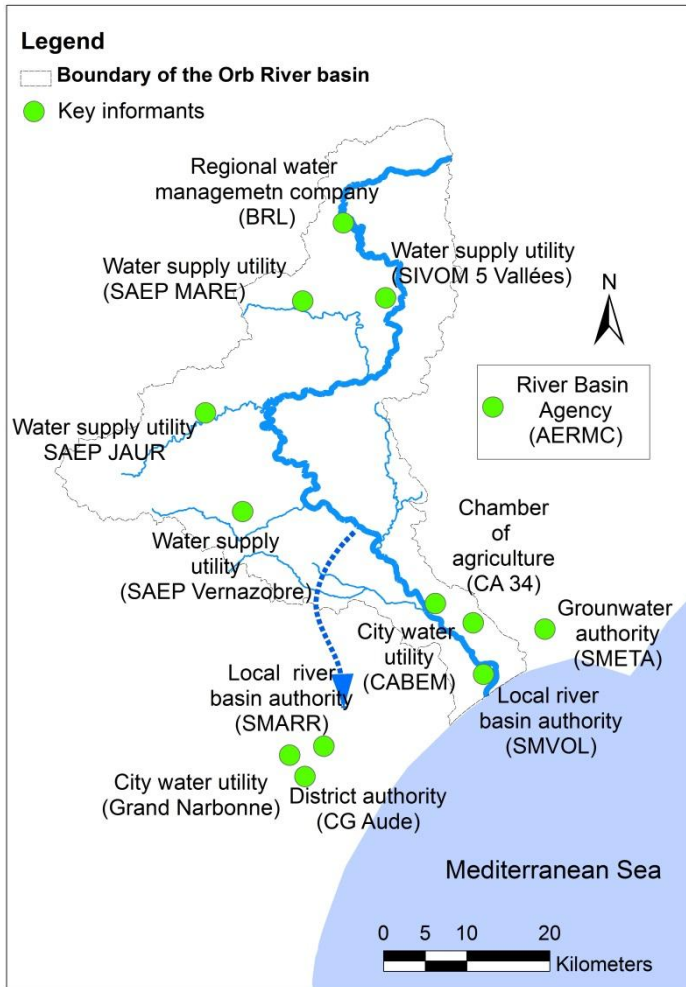

Figure 7–2 Localization of the key informants (the list of the key informants with their affiliations is presented in Appendix J)

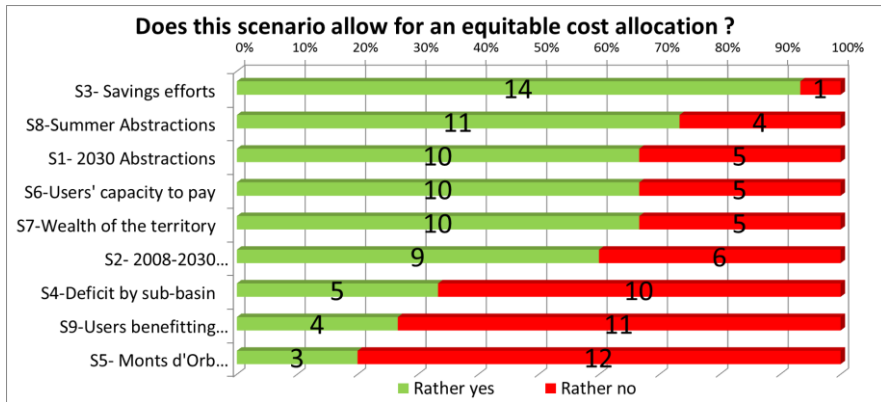

Figure 7–3 Results of the survey on the equity of cost allocation scenarios

The S3 scenario is followed in the ranking by a set of scenarios considered as fair by more than half of the key informants. They are based on different types of proportionality to the volume withdrawn or economic criteria (S8, S1, S6, S7, S2) and correspond to different social justice principles, from strict equality and desert principles for the first two, to equal opportunity and difference principles. The idea of volumetric proportionality is seen as fair as it provides some reward (desert principle) and is valued as well for its relative simplicity. However, the various users need to be differentiated in accordance with additional characteristics in order to take into account varying levels of development (history of water use) or the economic characteristic of the users (capacity to pay and wealth).

The last three scenarios (S4, S9 and S5) are considered as unfair by more than two thirds of the key informants. They are perceived as unfair as they are based on a strong discrimination between the users based on the appropriation of the resources (prior appropriation). They permit that some of the users bear the burden of the cost of the adaptation plan on their own. It can be noticed that for these three scenarios, the users favoured under one scenario (no cost to be paid) did not systematically define this scenario as fair, arguing that the idea of not paying their share of the plan was unacceptable.

Following these first results and the discussions during the survey, it appears that no single criterion alone can be selected in order to capture the complexity of the social justice issue associated with the cost allocation problem. A combination of

different social justice principles would ensure that the pros and cons of each principle are better balanced. Therefore, the answer from the survey will be used to illustrate how the different cost allocation scenarios could be weighted to build a weighted cost allocation scenario (SW).

7.2.3 Cost allocation scenarios following social justice principles

The next step of the analysis quantifies the different cost allocation scenarios to estimate the share of the total cost attributed to each user in each case (we assumed the same users as in the game theory setting to allow a comparison of the results). The cost allocation scenarios are then represented in the same triangle plot¹⁰ (Figure 7-4). The data provided to estimate each principle have been collected from previous local studies in the area for the water withdrawals, the potential of saving efforts and the allocation of water among the various users (Vernier, and Rinaudo, 2012). The territory wealth has been estimated based on statistical data provided on financial potential per inhabitant (*potential financier par habitant*) of the local municipalities of the study area (DGCL, 2013). The relative capacity of users to pay has been assumed to correspond to the current difference made by the local water authority between the urban and agricultural sectors in the water fees as a first proxy (MEDDE, 2012). A weighted allocation W_i of a given user i is obtained by by summing the product between the share of the total cost ($P_{i,j}$) allocated to this user (i) in one scenario (j) with the percentage of answers on the survey that consider this scenario as equitable (Y_j), (Eq. 7.1).

$$W_i = \sum_j P_{i,j} \times Y_j \text{ so that } \sum_i W_i = 1. \quad (\text{Eq. 7.1})$$

¹⁰ The triangle plot represents the three users of the cost allocation problems (A, B and C) as the three sides of a triangle. Each allocation scenario can be represented as a point with three coordinates corresponding to the share allocated to each user, the sum of the three contributions being always equal to 100%.

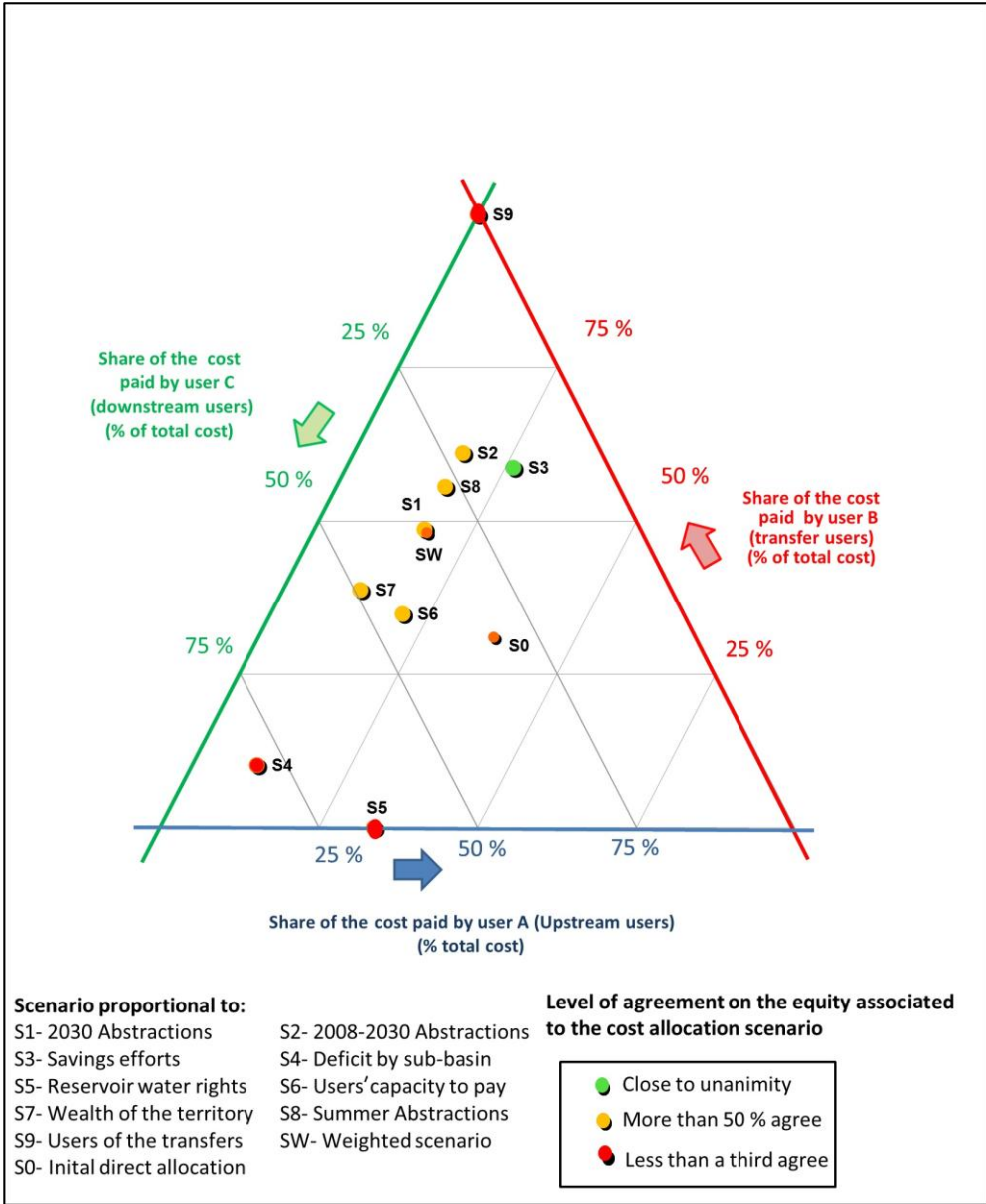

Figure 7–4 Scenario for the cost allocation of the adaptation plan

The application of the principle of a proportionality to water withdrawals (considering either the 2030 withdrawals (S1), the increase between 2008 and 2030 (S2), or the summer withdrawals in 2030 (S8)) leads to similar cost allocation between the three sectors. The highest share is assigned to the users of the

transfer (B from 58.8 to 61.2 % of the total cost), and the lowest share given to the upstream users (A around 17 %).

Therefore, two solutions (S5 and S9) are almost opposite in terms of the way we attribute the priority over the use of the water resources. If we give the priority to the historical water right of the transfer, then the others sector share the total cost (S5). On the contrary, if we consider that the users from the river basin have a priority, then the users benefitting from the transfer pay the entire cost of the PoM (S9).

The solution allocating cost proportionally to deficit (S4) leads to the highest part of the cost being associated (80 %) with downstream users, considering that upstream users have a priority on the use of the resource. The weighted allocation W is close to the allocation corresponding to 2030 water withdrawals. In comparison with the initial direct allocation of costs, the weighted scenario corresponds to a shift of 20 % of the costs from user A to user B.

7.3 Comparing cost allocation scenarios

In order to compare the cost allocation solutions from the different approaches, the cooperative game theory (CGT) solutions are added to the triangle plot (Figure 7-5). The solutions following CGT principles (Core, Shapley, and Nucleolus) are on the same side of the triangle, recommending that a higher part of the cost be paid by the downstream users (C). They are close to the cost allocation scenarios giving a priority to the users of the transfer from the Orb resources (S4). This scenario is the closest to those following CGT principles, given that it respects two of the three boundary conditions of the Core (for B and C, not for A). The remaining solutions following other social justice concepts are further from the CGT solutions. That which is furthest from the CGT is the solution where all the costs have to be paid by user B (S9), who benefits from the water transfer and manages the upstream reservoir. The weighted scenario, based on a combination of the social justice principles, lies outside the Core, and allocates almost half of the costs to user B.

The CGT approach informs us that the grand coalition could form (the Core is non-empty – some solutions exist within its boundaries), but side payment in the form of monetary transfers may be required to ensure its stability (from C to A and B), (further details on the stability analysis of the cost allocation scenarios are presented in Appendix J). The social justice approach presents different results, especially the fact that a cost allocation including large side payments between users would not be perceived as fair. A cost allocation rule that recognized the efforts already implemented would probably be more widely accepted and form the basis of an agreement.

These results illustrate the large differences between a possible allocation defined according to an agreement founded on social justice principles, and the economic and strategic analysis that some users could undertake in a negotiation process. Although all the cost allocation solutions seem to agree on attributing a low share of the costs to upstream user A, they differ markedly on the cost allocation between the two main users, A and B. Following economic rationality considerations associated with the historical water right of the transfer, B should pay less than C. However following a social justice criteria B should pay more than C.

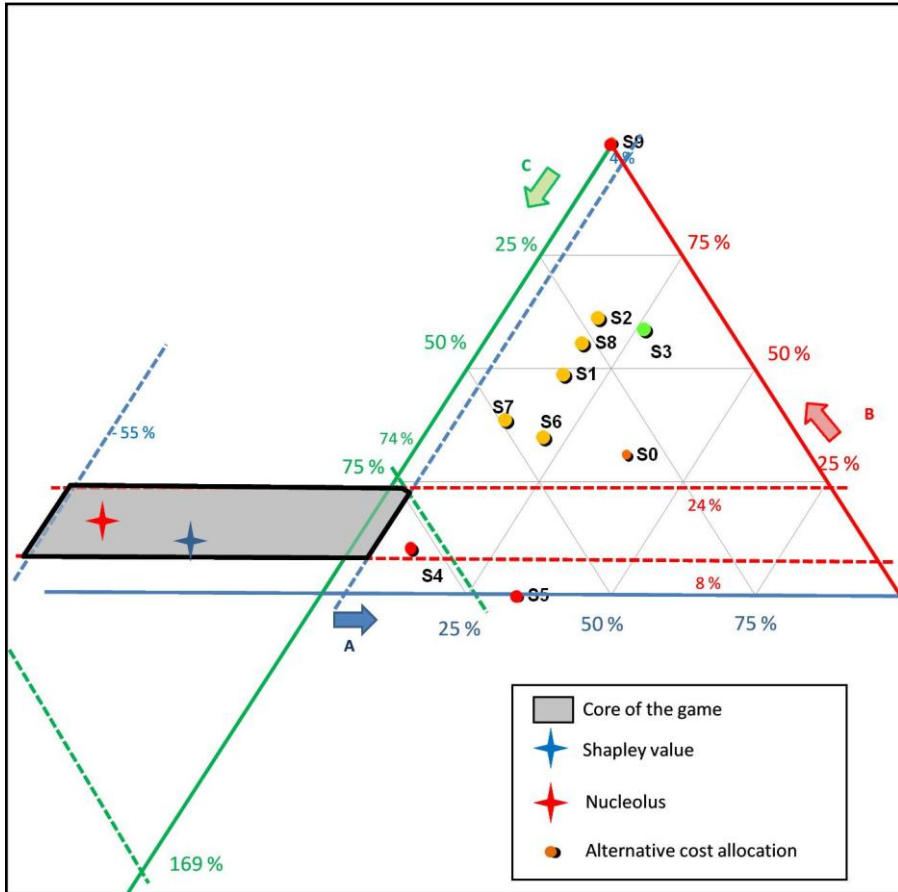

Figure 7–5 Comparison of the cost allocation scenarios between the three players (A, B and C). The percentage on each axis represents the share of the total cost of the programme of measures to be paid by the corresponding user.

If the local authority let the users agree on a cost allocation, users A and B would have more power of negotiation than player C, mainly due to their localization upstream of the river basin and to the historical water right attributed to the users of the water transfer that allow them to further develop and face climate change uncertainty on their own. However, the allocation of this water right seems to be perceived as unfair when taking into account social justice principles.

To some extent, this reflects the rising conflict between the water users located downstream of the transfer (player C) and the regional water company managing the reservoir and the users located outside of the river basin (player B). The

downstream users demand that more water be released from the reservoir to secure their development and water supply, considering that the water right allocated to the transfer was too generous at the time it was defined and needs to be updated. On the other hand the regional company, which manages the reservoir and supplies farmers and urban users, agrees on the possibility to release more water, but ask for monetary compensation, following a more economically rational approach.

Chapter 8 Discussion

This chapter presents a discussion on the framework developed in this thesis and its implementation. The first section (8.1) discusses the results presented in the previous chapters and considers their potential to formulate policy recommendations. The second section (8.2) provides some feedback from the participation of stakeholders, highlighting the difficulties and learning involved in this process. The third section (8.3) reflects on the insights gained from the development of an interdisciplinary approach and the challenges associated with it. The last section (8.4) acknowledges the main limitations of the framework and methods implemented in the light of other existing literature and studies.

8.1 Key findings and policy recommendations

The methodological framework developed makes various contributions to bridging the research gap identified at the beginning of this thesis, by integrating conventional top-down and bottom-up approaches in an innovative way to support the design of climate change adaptation strategies at the river basin scale.

On the one hand, by integrating results from work realized with the local stakeholders on the definition of the measures and development scenarios, and including local knowledge from economists, hydrologists, climate scientists, water resource engineers, water managers, stakeholders and planning authorities, the approach takes root in the local context, fostering dialogue on a common basis in the design of the adaptation strategies. This is essential for the definition of relevant, credible and acceptable adaptation options.

On the other hand, the top-down modelling part of the framework allows the complexity of physical interlinks between the adaptation options to be captured, and to consider future scenarios representing conditions far beyond current experience. This provides insights on the impacts, costs and trade-offs related to adaptation at the basin scale.

Furthermore, the proposed integration of the bottom-up and top-down information in a water resources management model enables the definition of cost-effective adaptation plans. Trade-offs between different management objectives (environmental flow targets, reliability of supply, adaptation cost, etc.) are assessed. The robustness of the adaptation measures across different climate projections is characterized. This is achieved on the basis of the relevant local information derived from the local stakeholders through the bottom-up approach.

The last part of the work developed addresses the cost allocation issue associated with the planning for adaptation at the river basin scale, to ensure the participation of the different stakeholders involved in the decision-making process and the implementation of the measures. Contrasted insights were obtained from a survey identifying the social justice principles to be taken into account in the definition of a cost allocation rule, and from the assessment of the outcomes of a negotiation process over cost allocation based on cooperative game theory.

This combined approach captures different rationales that have to be taken into account in the negotiation of cost allocation. Far from providing a ready-to-use cost allocation solution that would not be relevant, the comparison of approaches provides some elements to approach the problem from different perspectives. This allows the different representations of the problem to be quantified and represented on a common basis, providing food for thought during the necessary negotiation process, which can enable a consensus on the decision to be achieved.

The key benefits from the development of the integrated framework are illustrated by the results obtained through its implementation in a real case study, the Orb River basin. The implementation of the framework provides new results that can certainly help inform the decisions of policymakers at the regional or basin level. First, the results can help to prioritize the spatial allocation of measures in the basin to satisfy management constraints at a minimum total cost. The results of the integrated approach highlight that the optimal programme of measures is characterized by a spatial distribution of costs and water volume (saved or mobilized), which is neither proportional to the deficit nor to the demands. This

reflects differences in the actual efficiency of the measures at basin scale, depending on their spatial location. A water conservation measure implemented upstream not only allows the environmental target in the sub-basin to be met, but also contributes to solving the problem in downstream sub-basins. The integrated model developed captures this issue by accounting for the upstream–downstream interaction in the basin. These results provide valuable insight into the definition of a first-best solution that could be a basis for negotiating a basin-scale adaptation strategy with the relevant stakeholders.

Second, the implementation of the framework helps to prioritize the type of actions that need to be implemented. For instance, the results of our case study suggest that demand management measures, such as network efficiency improvements in irrigation and urban water supply networks are the least-regret options. Supply-side capacity expansion measures, such as desalination plants or ground water exploitation, are less cost-effective in a context of climate change uncertainty due to their high investment cost. However, if agricultural demand grows above a certain value, these capacity expansion measures could be required to ensure that urban water demand and environmental flow targets are fully met. Further analysis could be conducted to assess the threshold of agricultural development that would make capacity expansion measures unavoidable, and provide elements to further match water resources management and agricultural development at planning level.

Third, the modelling framework can help evaluate possible trade-offs between development of water uses, environmental objectives and adaptation costs in a context of climate change uncertainty. This is useful information for regional and river basin level policymakers as they attempt to reconcile agricultural and urban development policies with environmental objectives over the planning horizon. It can be used to identify tipping points between agricultural development, urban growth, adaptation cost and environmental objectives.

Finally, regarding the issue of cost allocation, the implementation of the cooperative game theory enables an estimation to be made of the potential outcomes of a negotiation between the various users at the river basin scale. To

ensure the formation of the grand coalition involving all the stakeholders, important side payments in the form of monetary transfers would be required between the downstream users and the users benefitting from the historical water right of the water transfer, defined before any consideration of climate change. However, such an agreement will be perceived as unfair by the various stakeholders, highlighting the need to consider alternative principles of social justice to solve the cost allocation issue. The debate on the cost allocation involved in adaptation to global change is influenced by the historical water resources allocation. Thus, an equitable cost allocation would need to be defined in the light of the historical water allocation, giving some more room for negotiation.

8.2 Feedback on stakeholder involvement

From a scientific perspective, the use of an integrated framework, based on a river basin management model such as the LCRBOM, can be recommended to improve: the economic efficiency of adaptation to climate change, or the cost-effectiveness analysis required by the Water Framework Directive. However, it has to be acknowledged that a clear gap exists between academic recommendations and real implementation of methods in the management of water resources. To avoid this mismatch between scientific prescriptions and policy application there is a need to co-construct knowledge with stakeholders (Martin-Ortega and Balana, 2012). Indeed, the active involvement of the stakeholders, beyond the minimum requirements of informing and consulting them, is also recognized as a way to improve the effectiveness of the implementation of the water policies (Wright and Fritsch, 2011).

The development of models relies on experts, and a top-down development process could impede the operational active involvement of stakeholders and the associated benefits. However, water resources management models have also proven to be useful in developing some common understandings on water management issues at the river basin scale; for example, supporting the development of a shared-vision planning process (Loucks et al., 1985) or participatory modelling exercises (Castelletti and Soncini-Sessa, 2006; Voinov and

Bousquet, 2010). Thus, in addition to the development and implementation of methods, this research has been an opportunity to test the relevance of a method combining stakeholder participation, economic analysis and water resources modelling to support water management decisions¹¹. This was performed at the local river basin level, where participation is actually taking place in France to design an operational PoM. When commencing the research, we initially thought that this would be the appropriate scale at which bottom-up and top-down approaches could be integrated, through the use of an integrated water resources management model. However, a number of difficulties have been encountered in the case study implementation that question this assumption.

Certainly, discussions with stakeholders involved in the research have shown that the integrated approach presented in this thesis has been understood and appreciated. However, it has to be acknowledged that, beyond the research project, stakeholders did not appropriate the results to formulate specific demands or to use the model to test specific scenarios and define operational decisions. The integrated modelling framework and results presented have not been further considered for operational adaptation decisions by stakeholders for several reasons.

First, stakeholders were not very familiar with the kind of analysis and results performed through economics methods and integrated river basin models. For instance, economic approaches have been only used progressively to support the design of water management plans (WFD); in the best case, river basin management plans are supported by a simple IBCEA. And pressure-impact models are much more common than integrated water resources management models in the planning and management of water resources in France (Brignon, 2004). In the case study presented, the IBCEA was useful as a first step to involve stakeholders, who were not previously familiar with economic analysis. Then, once their

¹¹ Interviews on the outcomes of our research were realized at the local level with stakeholders, water managers and consultants who are accustomed to working in the river basin. This section tries to summarize the main elements of the discussions.

knowledge and awareness had increased, the method was refined step-by-step, helping them to understand the limitations of IBCEA. We could further develop the full LCRBOM model to support the design of an effective operational programme of measures. The model could finally be used as a tool to explore a “space of solutions”, as trade-offs between planning objectives and uncertainties associated with climate change. It is, therefore, a method that can be used by stakeholders when they become more familiar with the economic analysis of a programme of measures. In summary, for the use of scientific tools, such as the LCRBOM, to be successful in supporting water resource planning decisions requires undergoing a learning process with stakeholders and decision makers to co-construct a common representation of the problem and progressively refine the method used, so they may share the conviction that the tool developed brings some added value to solving a common problem.

A second difficulty was that, although the development and implementation of the bottom-up and top-down part originated from a common decision among researchers and stakeholders, their integration through an integrated model was developed more as part of a research project trying to anticipate stakeholders need on their own planning agenda, and not through a full participatory modelling process. Major methodological choices made in the development of the integrated model were made by the interdisciplinary team of scientists, before stakeholders had to consider the issues at stake in the planning procedure. Science was therefore still ahead of management, which did not facilitate the appropriation of the tool. This may be a very case-specific result and it does not allow any conclusion to be derived concerning the relevance and usefulness of the same kind of approach in other contexts, through a more participatory modelling approach.

A third difficulty was associated with the discussion of long-term adaptation in a context of uncertainties. It is already difficult to discuss long-term issues because stakeholders do not all have the same understanding capacity and interests in the planning process. The communication of the wide range of uncertainties linked to the climate projections acted as an additional barrier to engage discussion over the long term, when climate change itself was not questioned following climate-sceptic

arguments. However, formulating the issues in terms of a search for “no regret solution” and illustrating the range of outcomes from different programmes of measures under different scenarios (climate check) was considered relevant, as a first step to address such difficulties.

These various difficulties linked to the communication of the outcomes from our integrated approach lead us to think that it would be better suited to support discussion and decision preparation by members of the technical commission of the local water committee, but not to communicate directly with representatives of water users, for instance, or local politicians. Those stakeholders with a more technical background could then act as translators to find the appropriate way to communicate and to make the link between science and management at the local level.

From a more general perspective, it seems that this type of integrated model would be more useful for water resources planning and management in larger river basins, such as, in France: the Rhône River (comparison of different projects to transfer water to other basins from the Rhône), or at the regional level for the region of Southern France, Languedoc Roussillon. It seems that, at this level, stakeholders’ representatives involved in the management and planning of water resources have developed more capacities to interact with a model. The increasing complexity of the system and its evolution also reinforce the need for an integrated approach to support the strategic decision over the planning horizon.

8.3 Insights from the interdisciplinary approach

This thesis illustrates how analysing adaptation to global change in river basin management requires bringing together multiple scientific disciplines (engineering, hydrology, economics, social sciences, environmental sciences, climate modelling, etc.), and binding them into a single framework, facilitated by integrated modelling. Deploying such an interdisciplinary approach is by no means a trivial task. Indeed, during the research, a continuous dialogue took place to construct a shared representation of the river basin, specify the problem, and identify and formalize water management constraints to be included in the water resources management

model. Each discipline involved in the overall framework had its specific time and spatial scale of analysis, therefore, reaching an agreement on the spatial and temporal scales on which the model was to be developed was an iterative process. Its aim was to agree on a resolution of water resources modelling, which would be consistent with the other scales of analysis.

Selecting the planning horizon reflects another challenge in the integration of disciplines involved in top-down and bottom-up approaches, as these approaches are used to work on different planning horizons. As described by (Dessai and Hulme, 2004), bottom-up approaches mainly focus on the present- or short-term horizon, whereas top-down approaches are used to work on short- to long-term planning horizons. Thus, the selection of 2030 as planning horizon required an agreement between both approaches. It corresponded to the planning horizon mentioned in the local strategic document (SMVO, 2013). If we had considered a longer time frame (e.g. 2050), the uncertainty associated with future water demands and available water management technologies and practices would have increased. The result of the overall approach would have lost its significance for the stakeholders involved. It was probably the furthest horizon for which farmers were able to provide valid agricultural development scenarios. Even if data from the top-down approach could be provided for further planning horizon, using them in discussions on adaptation at the local level would have been more challenging.

Thus, each approach (concept and tools) had to be adapted to fit into the overall framework and the water resources management model, seen as an end-point for research and integration, was a useful tool to harmonize the different perspectives. The modeller had to play a role of 'guardian of integration', as already reported in the literature (Kragt et al., 2013). This integrative approach stands in contrast with multidisciplinary research where the various disciplines basically do their own thing in parallel, their conceptual and methodological choices remaining independent from each other (Mollinga, 2009). Creating this dialogue implies that researchers be willing to cross-disciplinary boundaries, that they invest time and energy to appropriate concepts and methodologies of the other disciplines, the success of such interdisciplinary approaches requiring an attitude of '*engaged problem solvers*' rather than '*detached specialists*' (Pohl, 2005). This clearly raised

teamwork challenges to ensure communication, engagement, trust, and coordination between disciplines, and also challenges the way the academia sometimes evaluates such integrative interdisciplinary research (Kragt et al., 2013).

Based on the learning from the stakeholder involvement summarized in the previous section, the interdisciplinary framework developed would need to be improved to serve as a medium for even wider stakeholder participation in adaptation planning. This will imply not only a discussion of the framework assumptions and structure, but also a possible restructuring of the framework to include additional processes and output indicators as required by stakeholders, going one step further up the participatory research ladder, from consultative participation towards more collaborative and “collegiate” participation (Biggs, 1989; Barreteau, et al., 2010). This should give an opportunity to incorporate further lay stakeholder knowledge and decisions into the building of the general framework toward a better adaptation to global change – moving from an interdisciplinary to a trans-disciplinary approach (Pohl, 2005; Wickson et al., 2006).

8.4 Limitations of the methods

In addition to the previous discussion on the stakeholder involvement and interdisciplinary approach, the different components of the method developed in the present thesis have revealed several caveats and limitations that need to be acknowledged and discussed in the light of existing literature.

8.4.1 On uncertainties in top-down and bottom-up approaches

A main limitation of the framework is the lack of a detailed assessment of uncertainty on its different components. Conventionally, uncertainty in hydrological modelling stems from an incomplete understanding of the hydrological processes modelled (e.g. surface-groundwater interactions), from imprecise hydrological data used for calibration, and from the choice of models used for simulating sub-components of the system (water demand, hydrological processes), (Refsgaard et al., 2007). In the case of the analysis of global change scenarios, in which we assume that the climate is changing, this is far more complex, since we would need

to add the uncertainty on the meteorological variables (defined as plausible scenarios derived from GCM projections, with a wide range of variations between them) and on the resulting inflow time series that define available resources in the basin. Moreover, land use changes will affect water demand but also affect the hydrology and even the climate, creating a circle of feedbacks demanding different approaches for the design of adaptation under climate uncertainty (Brown and Wilby, 2012). Thus, from the top-down side, the analysis of uncertainties could be improved by performing the full downscaling method for the updated emission scenario with the latest Representative Concentration Pathway, considering a larger set of climate models (Rajagopalan et al., 2009), comparing results from downscaling techniques or hydrological models (Steinschneider et al., 2012), running a deeper sensitivity analysis to various components in the modelling chain. It could be tempting to use an ensemble-like approach, weighting each model according to their ability to simulate the past climate, hence attributing more probability to one scenario or another in the future (Barsugli et al., 2012). However, it is still a matter for discussion whether the improvement achieved by using ensembles instead of a single model is as great as expected, and how this translates into improvements in the projections (Knutti et al., 2010). Another innovative approach would be the use of model genealogy (Knutti et al., 2013) to combine models according to their similarities in their dynamical and physical codes.

Even though bottom-up approaches are less dependent on outputs from GCM scenarios and associated modelling uncertainties, they are not exempt from method-related uncertainties, such as epistemic or linguistic uncertainties, bias in the representativeness of the stakeholders and uncertainty due to variability in the data or population sampled (Ekström et al., 2013; Hayes, 2011). Other sources of uncertainty are inherent to each component involved in the bottom-up approach, such as water demand forecasting, for example, which relies on future socio-economic conditions (e.g. agricultural markets) with uncertainties that are hardly predictable. Future demand patterns are partly driven by predictable trends (e.g. demography, type of construction, development of large infrastructures, etc.) for which statistical data and the results of previous studies were provided to the

participants to construct the scenarios. However, we recognize that there are several other factors of change that can scarcely be predicted (uncertainty and risk of surprise), in particular those concerning markets (energy, employment, agriculture, etc.) and economic, social and environmental policies. These sources of uncertainties were presented and debated with the stakeholders during the workshops following methods previously developed (Maton et al., 2008; Rinaudo et al., 2013a). Stakeholders who participated in the scenario development are also involved in long-term planning and infrastructure development at the local or regional levels, whose time horizon corresponds to the one we considered in this study (2030). Thus, we consider that they have the envisioning capacity required to develop such future scenarios. We acknowledge that many drivers of water demand are external to the area, thus beyond the control of the stakeholders who participated in the scenario development. However, since their future depends on these drivers, local stakeholders are collecting information and developing their own vision of the most likely evolution. In the end, what will shape the future are not only changes in external drivers, but also how local actors respond to these changes by adapting their individual strategies (e.g. farmers) or local policies (e.g. land use planning). This is another good reason for involving local stakeholders in the development of future water demand scenarios. Stakeholder participation is not the only way to construct scenarios and capture the uncertainty associated with the planning process. However, it is necessary to ensure the relevance and consistency of the storylines developed, and their transformation into quantitative assumptions through forecasting techniques using actual data and models (e.g. agronomic simulation of future agricultural demands).

These uncertainties could be better addressed by considering different development scenarios, as we did with climate projections. This could have been achieved by using methods to manage such uncertainties in the planning of water resources systems, for example, robust decision-making and relying on computational techniques such as scenario discovery (Lampert et al., 2006), where a larger number of scenarios are investigated by varying future climate conditions and future demands. The optimization model would then have been used to find the optimal adaptation programme of measure for each of these scenarios. Apart

from their computational burden, one of the limitations of these approaches is their level of complexity for stakeholder participation. Our choice consisted in using a limited number of socio-economic scenarios that could more easily be grasped and used by the stakeholders who constructed them.

8.4.2 On the least-cost optimization model

Other limitations are inherent to the least-cost river basin model developed to integrate the different approaches. The deterministic optimization procedure selected certainly relies on 'perfect foresight' (Labadie, 2004). It assumes that an all-knowing manager would know the hydrological future with certainty and therefore would be able to select the ideal measures or to release water from the reservoir when needed. This clearly leads us to an overoptimistic result. It implies an underestimation of the adaptation needed, and therefore the results given here must be taken as the lower bound of the adaptation strategy needed. This optimization method, even if appropriate to the relative simplicity of the case study, may need to be adapted to more complex water resource systems (greater storage capacity and temporal correlation of the hydrology) as the importance of perfect foresight generally decreases significantly with the amount of over-year storage (Draper et al., 2003). However, the effects of perfect foresight have been considered as acceptable even in some complex water systems (e.g. the California water supply network (Newlin et al., 2002; Pulido-Velazquez et al., 2004)).

The ad-hoc optimization model developed does not allow accounting for other types of measures such as the transfer of water rights between users, through water markets for instance, which could be potentially more efficient than the demand and supply management measures presented. On the one hand, considering such measures would require accounting for the value generated by the water in different uses (benefit), through economic demand curves, which is clearly an interesting development of the current model into a full hydro-economic model, but would go beyond the framework of a cost-effective selection of measures. The difficulty is mainly due to data availability limitations related to water demand functions in agriculture, especially in wine production. On the other hand, the study is limited to measures fitting the current legal framework, and water

markets were discarded as they are not allowed in the current French water management context and would raise acceptability issues among the stakeholders (Rinaudo, et al., 2014).

Neither does the modelling framework presented allow for the consideration that farmers could adapt their cropping pattern or area of production to the effects of climate change. The future changes in the cropping patterns and areas are indeed estimated beforehand, during the definition of the scenario, and the corresponding changes in agricultural water demand are included in the model and discussed during the analysis of the trade-offs between supplying the agricultural demand and other decision variables (cost, environmental flows). This is partly due to the case study considered and the specific characteristics of the wine production sector, where the area of production determines the quality of the product, and thus limits the possibilities of relocation.

From the water resources modelling perspective, the LCRBOM model could be seen as a least-cost planning model without option scheduling. Indeed, we considered that the main focus of the work is located one step before the scheduling in the planning process. The integrated framework developed clearly deals with the definition of the planning scenarios (demand and hydrological) and objectives (environmental flows, agricultural development) in a context of climate change uncertainty before the phasing of the investment. We consider that addressing the trade-offs at stake, those between the planning objectives of environmental preservation, economic development and adaptation cost, is a necessary step for the definition of a programme of measures. However, a next step of development would clearly be to consider the phasing of the investment needed to achieve the objectives defined, by following a more conventional least-cost planning approach to advise on the investment required or a real option analysis (Jeuland and Whittington, 2014). An adaptive approach will also include the possibility of learning throughout the planning process or modifying the adaptation process as global changes unfold. Thus, the aim would be to go from an objective of static robustness towards one of a dynamic robustness and flexibility in the selection of measures.

8.4.3 On the cost allocation

In regard to the way we address the cost allocation issue, different limitations have to be taken into account in the implementation of the methods. Our implementation of the cooperative game theory approach relies on a limited definition of the utility of each player restricted to the direct financial cost (equivalent annualized cost of investment, operation and maintenance). A full economic analysis would include the estimation of indirect costs for each user in the implementation of measures in their area. It will also integrate the benefits for each user and then could bring more elements in the analysis of an efficient and fair definition of the programme of the programme of measures. A formulation of the problem to consider the full utility function of the different users, that would include utility losses due to unfair cost allocation would improve the characterization of the game and capture the equity considerations driving the user's choices in more detail. This could enable the Core of the game and the feasibility set to be extended. However, the assessment of these elements could also be more controversial and could probably exacerbate the difficulty in finding an agreement between the different users discussing the evaluation methods or challenging the transferable utility assumption, given the complex nature of water resources. The debate on the definition of this monetary compensation persists.

The implementation of the social justice approach relies on the definition of alternative scenarios elaborated on theoretical social justice principles and translated into the real case study. These principles have been discussed with key informants in the case study area. However, to ensure the consistency of this translation and to fully capture the principles at stake in the river basin, the scenario would benefit from a co-construction of the scenarios through a participatory process that would allow to the relevant stakeholders involved in the decision-making process to become further engaged. This would also allow the possibility of investigating the issue of social justice not only from an allocative perspective, but also from a procedural justice perspective, recognizing the importance of the way stakeholders take part in the decision-making process involved in defining the allocation of costs or benefits (Lawrence et al., 1997).

Thus, considering these different aspects of the social justice approaches would enable the achievement of the overarching objective of a “just distribution justly achieved” (Harvey, 1973).

8.4.4 On the overall framework

The step-by-step process of the general framework developed (Figure 3-1) allows a characterization of the different elements of the problem, developing in each case an appropriate method and then combining them into a coherent framework. Thus, it ensures an interaction between bottom-up and top-down approaches beyond disciplinary boundaries and a harmonization of the temporal and spatial scales of analysis of the adaptation at river basin scale. Although the framework is presented as a step-by-step process, this does not mean that its implementation must be linear in practice. The development of the top-down and bottom-up approaches are performed in parallel. Once established the framework, the interactions between the top-down and the bottom-up approaches could continue on this common basis to feed the decision-making process. Each part can be updated to integrate new information available such as learnings from the bottom-up side, or updated climate scenarios for the top-down side. The climate check assessment can then be performed again under improved assumptions, or modified if needed to better fit or integrate the different elements of the framework. The scenario workshop, climate check, and cost allocation analysis could be realized in a regular planning exercise to support and debate the adoption of new adaptation measures in the definition of an extended river-basin adaptation strategy (Lemieux, et al., 2014).

However, the framework is still a first step, in terms of adaptation, towards what could be the development of a full adaptive management strategy that would consider an iterative process of planning, implementing and updating the plan as more information is obtained and lessons are learned by the decision makers when they experience changing conditions. Indeed, to properly address the issue of planning for adaptation, the framework should fit into a wider management framework that accounts for what is learned as future conditions are experienced and that allows for the dynamic update of plans under an adaptive management

paradigm (Walters, 1986; Johnson, 1999; Convertino, 2013). The current framework provides some insights for describing and analysing adaptation at the river basin scale, as well as for the identification of adaptation actions under climate uncertainty, which are necessary steps to frame dynamic adaptive policy pathways, for instance (Haasnoot et al., 2013). However, the proposed approach focuses clearly on the resource-based problem generated by climate change rather than fully addressing the governance dimension of adaptation. The combination of the bottom-up and top-down approaches is a first practical way to move from a normative governance framework to the development of an actor's adaptive capacity to deal with uncertainty and to increase the resilience of the full socio-ecological system. Adaptation to global change will also require changes in governance regimes, institutional innovation and the development of more social learning capacities (Pahl-Wostl, 2009).

Chapter 9 Summary and conclusions

9.1 Summary

Adaptation to global change at the river basin scale is a complex process that requires the integration of different approaches. The work presented in this thesis combines economics and water resources sciences with system analysis techniques to integrate top-down and bottom-up approaches in order to develop adaptation plans, while taking into account the objectives of cost-effectiveness in the selection of adaptation measures and equity in the allocation of the cost of adaptation.

The bottom-up approach involves a scenario-building approach, applying participatory forecasting techniques in combination with agricultural and urban demand simulations to estimate future demand scenarios. Local adaptation measures are identified through stakeholder workshops, and systematically characterized in terms of cost and effectiveness. In the top-down approach, climate data are downscaled from a general climate model to assess the impact on hydrological regime under climate uncertainty.

The bottom-up approach meets the top-down approach when least-cost adaptation PoMs are identified using an integrated water resources optimization model. Economic and reliability indicators of water resource system performance are evaluated under different future climate projections and for different adaptation programmes of measures. This is a useful contribution when assessing the robustness of the potential adaptation decisions to climate change, and identifying the least-regret option. The allocation of the cost of the programme of adaptation measures has been addressed through two complementary approaches: one representing the potential outcomes of stakeholder negotiation based on the principles of cooperative game theory; and the other defining an equitable cost allocation rule based on social justice principles discussed with key informants through a field survey. This permits equity and acceptability issues to be considered when defining the adaptation strategies.

The framework has been implemented in a real case study, the Orb River basin in Southern France, to inform adaptation strategy defined at the local level. The results highlight the interest of demand-side management measures as least-regret options when adapting to uncertain global change, in contrast to more capital-intensive supply-side measures. A trade-off will be needed between the development of irrigated agriculture, environmental conservation and budget constraints, to ensure sustainable water resources management in the river basin. The relatively good coping capacity of the Orb River basin regarding the changes considered is due to the existing margins available in the management of the upstream Monts d'Orb reservoir. However, to ensure that a fair adaptation process takes place, one important issue is the allocation of the cost of the adaptation measures at the river basin scale. Addressing this issue could require reconsidering the historical way of managing the reservoir, changing from its actual function of compensating water transfer to consider the possibility of supporting water management and ensuring equity among the various stakeholders of the river basin.

9.2 Conclusion

The main contribution of the research is that it integrates results from different approaches in a coherent framework to support the selection of adaptation measures and the allocation of adaptation cost at the river basin scale. It thus overcomes the limitations of a conventional top-down impact assessment study by providing a way to connect with the definition of adaptation identified at the local level. It also improves bottom-up adaptation approaches by providing additional information on the range of changes to be expected and by allowing an estimation of the consequences of different adaptation options under future conditions (trade-off analysis and climate check). By comparing the results from the implementation of cooperative game theory and social justice approaches, it also provides contrasted insights that could support a negotiation over the fair allocation of the cost of adaptation. Overall, it provides an opportunity to address various key criteria in the adaptation process (cost-effectiveness, equity, environmental

sustainability, robustness) that have often been considered separately in previous studies.

The added value of the integrated interdisciplinary framework resides in the combination of its various components. At the frontier between engineering and economic sciences, integrated top-down and bottom-up approaches could be the way to bridge the gap between investigating climate change impacts and designing pragmatic local adaptation strategies. The integrated water resources management model developed to select adaptation options and investigate cost allocation possibilities is, in this case, an element of integration for a common understanding of the problem. The methodological framework opens the way to a participatory integrated assessment of the impact of climate change and to the design of adaptation strategy at the river basin scale. This would also require considering its further integration within a full adaptive management cycle. Even though the increasing complexity of water management issues to face global change seems to call for the adoption of such an approach, whether it will become part of common water management practices remains an open debate. This raises questions not only about the financial resources for the development of such approach, but also about its acceptability and appropriation by policymakers, technicians, stakeholders, and even academics, who are not always so familiar with integrated and interdisciplinary approaches.

9.3 Future research

While the developments achieved during this research have provided a variety of contributions to address the issue of adaptation at the river basin scale, they have also raised numerous questions and allowed the identification of new challenges to be addressed. Based on the limitations presented in the previous discussion chapter, these various future research lines can be summarized as follows:

From what has been learned during the implementation of the general framework at a local scale, it would be interesting to scale up the development of such a framework to address adaptation issues at a larger river basin scale or at the scale of a regional water resources system. We expect such an approach to be more

relevant at a larger scale, where strategic decisions have to be taken (e.g. the construction of inter-basin transfers) in a context of climate uncertainty. Moreover, decision makers involved in water resources planning at regional level in France are more likely to be familiar with the complexity of water resources systems, planning processes and modelling tools.

At the local level, from the bottom-up perspective, further research would be needed to improve the interaction with stakeholders on the development of such integrated modelling framework or the communication of uncertainties associated with future scenarios. For instance, developing an advanced participatory modelling approach would probably improve the relevance and appropriation of the development of such a framework in the management and adaption of water resources systems to global change. This would imply shifting from an interdisciplinary approach, such as that presented in this thesis, to a trans-disciplinary approach.

On the top-down side, a better analysis of uncertainties and its propagation along the modelling chain could be performed by considering updated emissions scenarios, alternatives GCMs, downscaling methods and hydrological models. It could be interesting to focus on using an improved risk-based approach, one which relies, for instance, on the combination of a stochastic weather generator with global climate models.

From a wider perspective, the determinants of the vulnerability of the water resources systems could be further explored through the analysis of a wider set of climate and development scenarios, through the implementation of scenario discovery methods or cluster analysis. Such methods could enable the identification of the critical thresholds in the various scenarios, not only in terms of climate variation, but also the urban or agricultural development that would challenge the adaptation process in the river basin.

Regarding the least-cost river basin optimization model, one interesting development would be to quantify the impact of the perfect foresight of the deterministic optimization on the results, by comparing it to alternative stochastic

optimization approaches or to optimization frameworks based on simulation models combined with genetic algorithms.

The solutions pool around the optimal least-cost programme of measures could be explored to identify second-best options through the application of diverse filtering techniques. This would assess the margin for negotiation in the definition of the programme of measures. The optimization process could also be improved to include the phasing of investments and give more flexibility in the design of the adaptation pathways by integrating the possibility of learning through the adaptation planning process.

The development of a full hydro-economic model including demand functions could provide some complementary elements to the analysis of the adaptation to global change by allowing changes in water allocation, which were not considered in this thesis. It could also characterize the benefits of different adaptation strategies from an economic perspective. The consideration of these benefits could, in turn, improve the definition of a fair adaptation plan by understanding how these benefits are allocated.

Regarding cost allocation, a possible first means to improve the analysis of the problem could be to modify the optimization framework to enforce some constraints. For instance, defining different equity criteria in order to assess the trade-offs between equity and the efficiency of an optimum programme of measures. To improve the consideration of climate uncertainty linked to the adaptation process, the definition of a cost allocation scenario could be performed under different climate projections, highlighting the range of variation in the possible allocation, and the consequences in terms of equity. Then, the spatial resolution of the analysis could be improved through the development of agent based model, or through the use of a decentralized optimization framework to perform the optimization at the sub-basin level, or a finer spatial scale of analyses, which would reflect the interactions between stakeholders in more detail.

From the cooperative game theory perspective, the optimization framework could allow the different players to modify their strategies in response to the coalition

made by other players, instead of considering that they will continue with their stand-alone solution. This has already been accomplished, for instance, through a reinforcement learning approach.

Regarding the analysis of the cost allocation from a social justice approach, other dimensions of this concept could be worth investigating, given their importance in the definition of an equitable cost allocation. Deliberative justice, understood as justice in the process through which the allocation rules are defined, could be one such dimension. Then, to go one step further in our comparison between different approaches on the definition of a fair cost allocation, we could develop experimental protocol to estimate the differences between the outcomes forecasted through the above mentioned approaches, and what stakeholders would choose to do in an experimental setting.

Finally, a key challenge still to be addressed is to integrate the methodological framework developed within a wider management framework to account for the learning capacities and address the governance and management issues linked to the adaptation process. This would require, for example, considering other adaptation options or constraints related to the institutional or legal context, as well as developing a better understanding of the local learning and decision-making process.

References

- ACTEON, 2011. Research report on the use of cost-effectiveness analysis in regard to the European water framework directive. Acteon Publishing 2011.
- Adger and Nelson, Fair decision making in a new climate of risk in *Climate Change, Ethics and Human Security*, eds. Karen O'Brien, Asunción Lera St.Clair and Berit Kristoffersen. Published by Cambridge University Press. Cambridge University Press 2010
- Adger, W.N., 2003. Social capital, collective action, and adaptation to climate change. *Economic Geography* 79, 387-404.
- Adger, W.N., Arnell, N.W., Tompkins, E.L., 2005. Successful adaptation to climate change across scales. *Global Environ. Change* 15, 77-86.
- Adger, W.N., Dessai, S., Goulden, M., Hulme, M., Lorenzoni, I., Nelson, D.R., Naess, L.O., Wolf, J., Wreford, A., 2009. Are there social limits to adaptation to climate change? *Clim. Change* 93, 335-354.
- AERMC (Agence de l'Eau Rhône Corse Méditerranée), 2009. Schéma directeur d'aménagement et de gestion des eaux du bassin Rhône-Méditerranée. Vers le bon état des milieux aquatiques. Agence de l'Eau Rhône, Méditerranée, Corse. http://www.rhone-mediterranee.eaufrance.fr/docs/dce/sdage/docs-officiels/BD/RM_Sdage_BD.pdf (In French)
- AERMC, 2014a, Plan de bassin d'adaptation au changement climatique dans le domaine de l'eau. Available on-line at http://www.eaurmc.fr/fileadmin/grands-dossiers/documents/Changement_climatique/Plan_Bassin_Chgt_Clim-VF30-06-14.pdf
- AERMC, 2014b, Projet de SDAGE 2016-2021, Bassin Rhône Méditerranée, <http://www.rhone-mediterranee.eaufrance.fr/docs/sdage2016/consultation/20141114-RAP-ProjetDeSdage-v0.pdf>
- AERMC, 2014c, Projet de programme de mesures 2016-2021, Bassin Rhône-Méditerranée. <http://www.rhone-mediterranee.eaufrance.fr/docs/sdage2016/consultation/20141114-RAP-ProjetDePdm-v0.pdf>
- Alcamo, J., Flörke, M., Märker, M., 2007. Future long-term changes in global water resources driven by socio-economic and climatic changes. *Hydrological Sciences Journal* 52, 247-275.

References

- Allen, R.G., Pereira, L.S., Raes, D., Smith, M., 1998. Crop Evapotranspiration—Guidelines for computing Crop Water Requirements. FAO Irrigation and drainage paper 56. Rome, Italy: Food and Agriculture Organization of the United Nations. ISBN 92-5-1042
- Andreu, J., Capilla, J., Sanchís, E., 1996. AQUATOOL, a generalized decision-support system for water-resources planning and operational management. *Journal of Hydrology* 177, 269-291.
- Arnell, N.W., 2004. Climate change and global water resources: SRES emissions and socio-economic scenarios. *Global Environ. Change* 14, 31-52.
- Balana, B.B., Vinten, A., Slee, B., 2011. A review on cost-effectiveness analysis of agri-environmental measures related to the EU WFD: Key issues, methods, and applications. *Ecol. Econ.* 70, 1021-1031.
- Bangash, R.F., Passuello, A., Sanchez-Canales, M., Terrado, M., López, A., Elorza, F.J., Ziv, G., Acuña, V., Schuhmacher, M., 2013. Ecosystem services in Mediterranean river basin: Climate change impact on water provisioning and erosion control. *Sci. Total Environ.* 458-460, 246-255.
- Barreteau, O., Bots, P.W.G., Daniell, K.A., 2010. A framework for clarifying "Participation" in participatory research to prevent its rejection for the wrong reasons. *Ecology and Society* 15, 24.
- Barsugli, J., Vogel, J., Kaatz, L., Smith, J., Waage, M., Anderson, C., 2012. Two Faces of Uncertainty: Climate Science and Water Utility Planning Methods. - *J. Water Resour. Plann. Manage.* 138, 389-395.
- Bates, B.C., Z.W. Kundzewicz, S. Wu and J.P. Palutikof, Eds., 2008: *Climate Change and Water*. Technical Paper of the Intergovernmental Panel on Climate Change, IPCC Secretariat, Geneva, 210 pp. Battaglini, et al., 2009
- Béal, et al. 2013
- Berbel, J., Martin-Ortega, J., Mesa, P., 2011. A Cost-Effectiveness Analysis of Water-Saving Measures for the Water Framework Directive: The Case of the Guadalquivir River Basin in Southern Spain. *Water Resour. Manage.* 25, 623-640.
- Berkhout, F., Hertin, J., Jordan, A., 2002. Socio-economic futures in climate change impact assessment: Using scenarios as 'learning machines'. *Global Environ. Change* 12, 83-95.
- Berthomieu, M., 2012. Modelling climate change impacts on water resources, application to the Orb River basin (France). Rapport de stage scientifique, Ecole des Ponts Paristech.

-
- Bhave, A.G., Mishra, A., Raghuwanshi, N.S., 2013. A combined bottom-up and top-down approach for assessment of climate change adaptation options. *Journal of Hydrology* .
- Biesbroek, G.R., Swart, R.J., Carter, T.R., Cowan, C., Henrichs, T., Mela, H., Morecroft, M.D., Rey, D., 2010. Europe adapts to climate change: Comparing National Adaptation Strategies. *Global Environ. Change* 20, 440-450.
- Biggs, S. D. 1989. Resource-poor farmer participation in research: a synthesis of experiences from national agricultural research systems. OFCOR, comparative Study No. 3. International Service for National Agricultural Research, The Hague, The Netherlands.
- Boé, J. et L. Terray, 2008 A Weather-Type Approach to Analyzing Winter Precipitation in France : Twentieth-Century Trends and the Role of Anthropogenic Forcing. *J. Climate*, 21 (13), 3118.
- Boé, J., Terray, L., Cassou, C., Najac, J., 2009. Uncertainties in European summer precipitation changes: Role of large scale circulation. *Clim. Dyn.* 33, 265-276.
- Bowles, 2008 Policies Designed for Self-Interested Citizens May Undermine "The Moral Sentiments": Evidence from Economic Experiments Samuel Bowles, et al. *Science* 320, 1605 (2008);DOI: 10.1126/science.1152110
- Brignon, J.-M., 2004 Les modèles pressions/impacts pour la Directive-Cadre Eau : Bilan des outils actuellement utilisés et des besoins futurs, Rapport INERIS
- Brouwer, R., Hofkes, M., 2008. Integrated hydro-economic modelling: Approaches, key issues and future research directions. *Ecol. Econ.* 66, 16-22.
- Brown, C. M., J. R. Lund, X. Cai, P. M. Reed, E. A. Zagona, A. Ostfeld, J. Hall, G. W. Characklis, W. Yu, and L. Brekke (2015), The future of water resources systems analysis: Toward a scientific framework for sustainable water management, *Water Resour. Res.*, 51, doi:10.1002/2015WR017114.
- Brown, C., Ghile, Y., Laverty, M., Li, K., 2012. Decision scaling: Linking bottom-up vulnerability analysis with climate projections in the water sector. *Water Resour. Res.* 48.
- Brown, C., Wilby, R.L., 2012. An alternate approach to assessing climate risks. *Eos* 93, 401-402.
- Caballero, Y., Voirin-Morel, S., Habets, F., Noilhan, J., LeMoigne, P., Lehenaff, A., Boone, A., 2007. Hydrological sensitivity of the Adour-Garonne river basin to climate change. *Water Resour. Res.* 43.

References

- Carpenter, S.R., Bennett, E.M., Peterson, G.D., 2006. Scenarios for ecosystem services: An overview. *Ecology and Society* 11.
- Castelletti, A., Soncini-Sessa, R., 2006. A procedural approach to strengthening integration and participation in water resource planning. *Environmental Modelling and Software* 21, 1455-1470.
- CGP (Commissariat Général du Plan), 2005. Révision du Taux d'Actualisation des Investissements Publics, Rapport du groupe d'experts présidé par Daniel Lebègue, Paris
- Chazot, et al., 2012 Chazot, S., Norotte, T., David, J. (2012) Rapport Final du Projet Explore 2070, BRLi-Irstea-Météo France, Ministère de l'Ecologie, Paris. 77 p (In French)
- Chazot, S., 2011. Perspectives d'évolution de la gestion des volumes stockés dans le barrage des Monts d'Orb. Rapport final, Novembre 2011, BRL Ingénierie. <http://www.vallees-orb-libron.fr/wp-content/uploads/2012/12/etude-gestion-Monts-Orb-Rapport-V16.pdf> (In French)
- Convertino, M., C.M. Foran, J.M. Keisler, L. Scarlett, A. LoSchiavo, G.A. Kiker, I. Linkov, 2013. Enhanced Adaptive Management: Integrating Decision Analysis, Scenario Analysis and Environmental Modeling for the Everglades, *Scientific Reports* (Nature Publishing Group), 3, 2922, doi:10.1038/srep02922
- Dawes, R. M. (1980). Social dilemmas. *Annu. Rev. Psychol.* 31: 169–193.
- De Roo, A., Burek, P., Gentile, A., Udias, A, Bouraoui, F., Aloe, A. Bianchi, A. La Notte, A., Kuik, O., Elorza Tenreiro, J., Vandecasteele, I., Mubareka, S., Baranzelli, C., Van Der Perk, M., Lavalle, C., Bidoglio, G., 2012. A multi-criteria optimisation of scenarios for the protection of water resources in Europe, Support to the EU Blueprint to Safeguard Europe's Waters, JRC Scientific and policy report, European Commission. <http://publications.jrc.ec.europa.eu/repository/handle/111111111/26672>
- Deidda D, Andreu J, Perez MA, Sechi GM, Zucca R, Zuddas P (2009) A cooperative game theory approach to water pricing in a complex water resource system. 18th World IMACS/MODSIM Congress, Cairns, Australia
- Dessai S., Lu X., Risbey J. S. (2005) On the role of climate scenarios for adaptation planning. *Global Environmental Change* 15, 87-97.
- Dessai, S., Browne, A., Harou, J.J. (2013) Introduction to the Special Issue on "Adaptation and Resilience of Water Systems to an Uncertain Changing Climate", *Water Resource Manage* (2013) 27:943–948, DOI 10.1007/s11269-012-0254-3

-
- Dessai, S., Hulme, M., 2004. Does climate adaptation policy need probabilities? *Climate Policy* 4, 107-128.
- Dessai, S., Lu, X., Risbey, J.S., 2005. On the role of climate scenarios for adaptation planning. *Global Environ. Change* 15, 87-97.
- Dessai, S., O'Brien, K., Hulme, M., 2007. Editorial: On uncertainty and climate change. *Global Environ. Change* 17, 1-3.
- Dewar, J.A.; Builder, C.H.; Hix, W.M.; Levin, M.H. Assumption-Based Planning: A Planning Tool for Very Uncertain Times; Report MR-114-A; RAND: Santa Monica, 1993.
- DGCL (Direction Générale des Collectivités Locales), 2013 Potentiel financier par habitant. Données. Observatoire des territoires. <http://www.observatoire-des-territoires.gouv.fr/observatoire-des-territoires/es/potentiel-financier-par-habitant> (Accessed on the 20/06/2015)
- Dinar, A., S. Dinar, S. McCaffrey, D. McKinney, 2007, Bridges Over Water, Understanding Transboundary Water Conflict, Negotiation and Cooperation World Scientific Publishing Company, Oct. 2007, 468 pp
- Dinar, A. and Howitt, R. (1997), Mechanisms for allocation of environmental control cost: Empirical Tests of acceptability and stability, *J Environ. Manage.*, 49, 183–203.
- Donkor E. A., Mazzuchi T. A., Soyer R., Alan Roberson J. (2014) Urban water demand forecasting: Review of methods and models. *Journal of Water Resources Planning and Management* 140, 146-159.
- Dovers, S., 2009. Normalizing adaptation. *Global Environ. Change* 19, 4-6.
- Draper, A.J., Jenkins, M.W., Kirby, K.W., Lund, J.R., Howitt, R.E., 2003. Economic-engineering optimization for California water management. *J. Water Resour. Plann. Manage.* 129, 155-164.
- EC (European Commission) ,2009, River basin management in a changing climate, Common implementation strategy for the water framework directive (2000/60/EC), Guidance document No. 24, European Union Publications Office, ISBN 978 92 79 14298 7.
- EC, 2012, A Blueprint to Safeguard Europe's Water Resources, European Commission, Brussels, 14.11.2012, COM(2012) 673 final.
- EC, 2000, Directive 2000/60/EC of the European Parliament and of the Council Establishing a Framework for Community Action in the Field of Water Policy. *Official Journal of European Communities*, L327, pp. 1-72 .

References

- Eek, D. and Biel, A., 2003 The Interplay Between Greed, Efficiency, and Fairness in Public-Goods Dilemmas, *Social Justice Research*, Vol. 16, No. 3,
- Ejeta, M.Z., and Mays, L.W., 2005, Regional Water supply planning and capacity expansion models, in: Larry W Mays, 2005, *Water Resource Systems Management Tools*. McGraw-Hill. Available from: http://www.public.asu.edu/~lwadays/research_paper.htm
- Ekström, M., Kuruppu, N., Wilby, R.L., Fowler, H.J., Chiew, F.H.S., Dessai, S., Young, W.J., 2013. Examination of climate risk using a modified uncertainty matrix framework- Applications in the water sector. *Global Environ. Change* 23, 115-129.
- Elelund RB, Hebert RF ,1999, *The secret origins of modern microeconomics: Dupuit and the engineers*. University of Chicago Press. Chicago, Illinois
- Faysse, N., Rinaudo, J.-., Bento, S., Richard-Ferroudji, A., Errahj, M., Varanda, M., Imache, A., Dionnet, M., Rollin, D., Garin, P., Kuper, M., Maton, L., Montginoul, M., 2014. Participatory analysis for adaptation to climate change in Mediterranean agricultural systems: Possible choices in process design. *Regional Environmental Change* 14, 57-70.
- Fehr,E., and Fischbacher, U., 2012 Why social preferences matter – the impact of non-selfish motives on competition, cooperation and incentives, *The Economic Journal* 112, 1-33.
- Frey, B. S., Jegen, R., 2001. Motivation Crowding Theory. *Journal of Economic Surveys* 15 (5), 589-611
- Garber, A.M., Phelps, C.E., 1997, Economic foundations of cost-effectiveness analysis. *J. Health Econ.* 16, 1-31.
- Garin. P., RINAUDO.J.D., Ruhlmann.J.D. ,2002. Linking expert evaluations with public consultation to design water policy at the watershed level, *Water Science and technology*, 46, 6-7
- Garin.P., RINAUDO.J.D., Ruhlmann.J.D. ,2002. Linking expert evaluations with public consultation to design water policy at the watershed level, *Water Science and technology*, Vol. 46 - pp. 6-7
- Gately, 1974 Gately, D. ,1974. Sharing the gains from regional cooperation: A game theoretic application to planning investment in electric power, *Int. Econ. Rev.*, 15(1), 195–208
- Ghaffour, N., Missimer, T.M., Amy, G.L., 2013. Technical review and evaluation of the economics of water desalination: Current and future challenges for better water supply sustainability. *Desalination* 309, 197-207.

-
- Giorgi, F., Lionello, P., 2008. Climate change projections for the Mediterranean region. *Global Planet. Change* 63, 90-104.
- Gippel, C., J., and Stewardson, J., 1998. Use of wetted perimeter in defining minimum environmental flows, *Regulated Rivers: Research & Management*, 14: 53–67.
- Girard, C., and Rinaudo, J.D., 2013. Evolution des besoins en eau d'irrigation à l'horizon 2030 dans l'Ouest de l'Hérault Rapport BRGM- RP - 61323 - FR. 41 pages (In French) Available at <http://infoterre.brgm.fr/rapports/RP-61323-FR.pdf>
- Gleick P. H., 2003. Global Freshwater Resources: Soft-Path Solutions for the 21st Century. *Science* 302, 1524-1528.
- Graham, S., Barnett, J., Fincher, R., Mortreux, Hurlimann, C. A. 2015, Towards fair local outcomes in adaptation to sea-level rise, *Climatic Change*, 130:411–424, DOI 10.1007/s10584-014-1171-7
- Griffin, R. C. 1998. The fundamental principles of cost-benefit analysis, *Water Resour. Res.*, 34(8), 2063–2071, doi:10.1029/98WR01335
- Gross, C. 2008. A Measure of Fairness: An Investigative Framework to Explore Perceptions of Fairness and Justice in a Real-Life Social Conflict, *Human Ecology Review*, 15 (2)
- Groves, D.G., Robert J. Lempert, Debra Knopman, Sandra H. Berry, 2008. Preparing for an Uncertain Future Climate in the Inland Empire Identifying Robust Water-Management Strategies. Rand Corporation, Santa Monica, CA. 98 p.
- Haasnoot, M., Kwakkel, J.H., Walker, W.E., ter Maat, J., 2013. Dynamic adaptive policy pathways: A method for crafting robust decisions for a deeply uncertain world. *Global Environ. Change* 23, 485-498.
- Hallegatte, S., 2009. Strategies to adapt to an uncertain climate change. *Global Environ. Change* 19, 240-247.
- Harou, J.J., Pulido-Velazquez, M., Rosenberg, D.E., Medellín-Azuara, J., Lund, J.R., Howitt, R.E., 2009. Hydro-economic models: Concepts, design, applications, and future prospects. *Journal of Hydrology* 375, 627-643.
- Harrison, P.A., Holman, I.P., Cojocar, G., Kok, K., Kontogianni, A., Metzger, M.J., Gramberger, M., 2013. Combining qualitative and quantitative understanding for exploring cross-sectoral climate change impacts, adaptation and vulnerability in Europe. *Regional Environmental Change* 13, 761-780.
- Harvey, D 1973 *Social justice and the city*. Edward Arnold, London, UK

References

- Hashimoto, T., Stedinger, J.R., Loucks, D.P., 1982. Reliability, resiliency, and vulnerability criteria for water resource system performance evaluation. *Water Resour. Res.* 18, 14-20.
- Hatzilacou, D., Kallis, G., Mexa, A., Coccosis, H., Svoronou, E., 2007. Scenario workshops: A useful method for participatory water resources planning? *Water Resour. Res.* 43.
- Hayes, K., 2011. Uncertainty and uncertainty analysis methods. Australian Centre of Excellence for Risk Assessment (ACERA) project 0705A. Report number EP102467, 131 pp. Available online at: http://www.acera.unimelb.edu.au/materials/endorsed/0705a_final-report.pdf.
- Heaney, 1997, chapter 13 Cost allocation in water resources, in *Design and Operation of civil and environmental engineering systems*, Edited by ReVelle, C., McGarity A.E., Wiley-Interscience publication
- Heinz, I., Pulido-Velazquez, M., Lund, J.R., Andreu, J., 2007. Hydro-economic modelling in river basin management: Implications and applications for the European water framework directive. *Water Resour. Manage.* 21, 1103-1125.
- Hoang, T., Maton, L. Caballero, Y. et Rinaudo J-D. 2012. Impact du changement climatique sur le besoin en eau d'irrigation dans l'Ouest de l'Hérault. Rapport Brgm RP-61311-FR. 36 pages + 2 annexes. <http://infoterre.brgm.fr/rapports/RP-61311-FR.pdf>.
- Holling, C. S. 1973. Resilience and stability of ecological systems. *Annual Review of Ecology and Systematics* 4:1–23
- Howe, J.P., 2014. *Behind the curve: science and the politics of global warming*. University of Washington Press, Seattle, 296 pp.
- Huang, I.B., Keisler, J., Linkov, I., 2011. Multi-criteria decision analysis in environmental sciences: Ten years of applications and trends. *Sci. Total Environ.* 409, 3578-3594.
- Hughes, S. 2013. Justice in urban climate change adaptation: criteria and application to Delhi. *Ecology and Society* 18(4): 48. <http://dx.doi.org/10.5751/ES-05929-180448>
- Hunt, A., Watkiss, P., 2011. Climate change impacts and adaptation in cities: A review of the literature. *Clim. Change* 104, 13-49.
- Hurd, B.H., Coonrod, J., 2012. Hydro-economic consequences of climate change in the upper Rio Grande. *Climate Research* 53, 103-118.
- Hwang, C.L., and Yoon, K., 1981, *Multiple Attribute Decision Making: Methods and Applications*, Springer-Verlag, New York, (1981).

-
- Iglesias A., Garrote, L. (2015) Adaptation strategies for agricultural water management under climate change in Europe, *Agricultural Water Management* 155 (2015) 113–124
- Iglesias, A., Garrote, L., Flores, F., Moneo, M., 2007. Challenges to manage the risk of water scarcity and climate change in the Mediterranean. *Water Resour. Manage.* 21, 775-788.
- Interwies E., Kraemer, A., Kranz, N., Görlach, B, Dworak T., 2004, Basic principles for selecting the most cost-effective combinations of measures for inclusion in the programme of measures as described in Article 11 of the Water Framework Directive- Handbook. Research Report 202 21 210 UBA-FB 000563/E, Federal Environmental Agency, Berlin, 2004
- IPCC (2007) Appendix 1: Glossary in: Contribution of Working Group II to the Fourth Assessment Report of the Intergovernmental Panel on Climate Change, 2007 M.L. Parry, O.F. Canziani, J.P. Palutikof, P.J. van der Linden and C.E. Hanson, Cambridge University Press, Cambridge, UK
- IPCC (2007) Climate Change 2007: Synthesis report. Contribution of Working Groups I–III to the Fourth Assessment Report of the Intergovernmental Panel on Climate Change, Cambridge University Press, Cambridge
- IPCC, (2014) Annex XX: Glossary [J., Agard, E.L.F., Schipper, J., Birkmann, M., Campos, C., Dubeux, Y., Nojiri, L., Olsson, B., Osman-Elasha, M., Pelling, M.J., Prather, M.G., Rivera-Ferre, O.C., Ruppel, A., Sallenger, K.R., Smith, A.L. St. Clair, K.J., Mach, M.D., Mastrandrea, T.E., Bilir (eds.)]. In: *Climate Change 2014: Impacts, Adaptation, and Vulnerability. Part B: Regional Aspects. Contribution of Working Group II to the Fifth Assessment Report of the Intergovernmental Panel on Climate Change* [V.R., Barros, C.B., Field, D.J., Dokken, M.D., Mastrandrea, K.J., Mach, T.E., Bilir, M., Chatterjee, K.L., Ebi, Y.O., Estrada, R.C., Genova, B., Girma, E.S., Kissel, A.N., Levy, S., MacCracken, P.R., Mastrandrea, L.L., White (eds.)]. Cambridge University Press, Cambridge, United Kingdom and New York, NY, USA
- IPCC-TGICA, 2007: General Guidelines on the Use of Scenario Data for Climate Impact and Adaptation Assessment. Version 2. Prepared by T.R. Carter on behalf of the Intergovernmental Panel on Climate Change, Task Group on Data and Scenario Support for Impact and Climate Assessment, 66 pp.
- Jacoby, H. D., and D. P. Loucks (1972), Combined use of optimization and simulation models in river basin planning, *Water Resour. Res.*, 8(6), 1401–1414, doi:10.1029/WR008i006p01401.

References

- Jakeman, A.J., Letcher, R.A., 2003. Integrated assessment and modelling: Features, principles and examples for catchment management. *Environmental Modelling and Software* 18, 491-501.
- James, L. D., and R. R. Lee, 1971 Chapter 23 Cost Allocation, in *Economics of Water Resources Planning*, McGraw-Hill, New York.
- Jenkins, M.W., Lund, J.R., Howitt, R.E., Draper, A.J., Msangi, S.M., Tanaka, S.K., Ritzema, R.S., Marques, G.F. (2004) Optimization of California's water supply system: Results and insights *Journal of Water Resources Planning and Management*, 130 (4), pp. 271-280. doi: 10.1061/(ASCE)0733-9496(2004)130:4(271)
- Jeuland, M., and D. Whittington, 2014. Water resources planning under climate change: Assessing the robustness of real options for the Blue Nile, *Water Resour. Res.*, 50, 2086–2107, doi:10.1002/2013WR013705.
- Johnson, B. L., 1999. The role of adaptive management as an operational approach for resource management agencies. *Conserv. Ecol.* 3, 8
- Kelly, P.M., and W.N. Adger, 2000: Theory and practice in assessing vulnerability to climate change and facilitating adaptation. *Climatic Change*, 47, 325–352
- Kjellström, E., Thejll, P., Rummukainen, M., Christensen, J.H., Boberg, F., Christensen, O.B., Maule, C.F., 2013. Emerging regional climate change signals for Europe under varying large-scale circulation conditions. *Climate Research* 56, 103-119.
- Knutti, R., Furrer, R., Tebaldi, C., Cermak, J., Meehl, G.A., 2010. Challenges in combining projections from multiple climate models. *J. Clim.* 23, 2739-2758.
- Knutti, R., Masson, D., Gettelman, A., 2013. Climate model genealogy: Generation CMIP5 and how we got there. *Geophys. Res. Lett.* 40, 1194-1199.
- Kragt, M.E., Robson, B.J., Macleod, C.J.A., 2013. Modellers' roles in structuring integrative research projects. *Environmental Modelling and Software* 39, 322-330.
- Kwakkel, J.H., Haasnoot, M., Walker, W.E., 2014. Developing dynamic adaptive policy pathways: a computer-assisted approach for developing adaptive strategies for a deeply uncertain world. *Clim. Change* .
- Labadie, J.W., 2004. Optimal operation of multireservoir systems: State-of-the-art review. *J. Water Resour. Plann. Manage.* 130, 93-111.
- Lamont, J. and Favor, C., 2013. Distributive Justice. In Edward N. Zalta (Ed.), *Stanford Encyclopedia of Philosophy* (pp. 1-46) Stanford, CA, United States: Center for the Study of Language and Information, Stanford University.

-
- Lamouroux N., 2002. Estimhab: estimating in-stream habitat quality changes associated with river management. Shareware & User's guide, Cemagref, Lyon. <http://www.lyon.cemagref.fr/bea/lhq/lhq.html> .
- Lawrence, R. L., Daniels, S. E., & Stankey, G. H., 1997. Procedural justice and public involvement in natural resources decision making. *Society and Natural Resources*, 10, 577–589
- Leavesley, G.H., 1994. Modeling the effects of climate change on water resources - a review. *Clim. Change* 28, 159-177.
- Lemieux, C.J., Gray, P.A., Douglas, A.G., Nielsen, G., Pearson, D., 2014. From science to policy: The making of a watershed-scale climate change adaptation strategy. *Environmental Science and Policy* 42, 123-137.
- Lempert R. J., Groves D. G., Popper S. W., Bankes S. C., 2006. A general, analytic method for generating robust strategies and narrative scenarios. *Management Science* 52, 514-528.
- Lempert, R.J., Groves, D.G., 2010. Identifying and evaluating robust adaptive policy responses to climate change for water management agencies in the American west. *Technological Forecasting and Social Change* 77, 960-974.
- Lereboullet, A.-., Beltrando, G., Bardsley, D.K., 2013. Socio-ecological adaptation to climate change: A comparative case study from the Mediterranean wine industry in France and Australia. *Agriculture, Ecosystems and Environment* 164, 273-285.
- Lereboullet, A.-., Beltrando, G., Bardsley, D.K., Rouvellac, E., 2014. The viticultural system and climate change: coping with long-term trends in temperature and rainfall in Roussillon, France. *Regional Environmental Change* 14, 1951-1966.
- Lescot, J-M., Bordenave, P., Petit, K., Leccia, O., 2013. A spatially-distributed cost-effectiveness analysis framework for controlling water pollution, *Environmental Modelling and Software* 41 107-122
- Letcher, R.A., Croke, B.F.W., Jakeman, A.J., 2007. Integrated assessment modelling for water resource allocation and management: A generalised conceptual framework. *Environmental Modelling and Software* 22, 733-742.
- Loucks, D. P., Stedinger, J. R., and Haith, D. A. 1981. *Water resources systems planning and analysis*. Englewood Cliffs, N.J.: Prentice-Hal.
- Loucks, D.P. and E. van Beek, 2006. *Water Resources Systems Planning and Management: An Introduction to Methods, Models and Applications*. Paris: UNESCO.

References

- Loucks, D.P., 1997. Quantifying trends in system sustainability. *Hydrological Sciences Journal* 42, 513-530.
- Loucks, D.P., Kindler, J., Fedra, K., 1985. Interactive water resources modelling and model use: an overview. *Water Resour. Res.* 21, 95-102.
- Ludwig, R., Roson, R., Zografos, C., Kallis, G., 2011. Towards an inter-disciplinary research agenda on climate change, water and security in Southern Europe and neighbouring countries. *Environmental Science and Policy* 14, 794-803.
- Lund, J. R. (2015), Integrating social and physical sciences in water management, *Water Resour. Res.*, 51, doi:10.1002/2015WR017125.
- Madani, K. and Dinar, 2012. Cooperative Institutions for Sustainable Common Pool Resource Management: Application to Groundwater, *Water Resour. Res.*, 48, W09553, doi:10.1029/2011WR010849.
- Madani, K. and Hooshyar, M., 2014. A game theory–reinforcement learning (GT–RL) method to develop optimal operation policies for multi-operator reservoir systems *Journal of Hydrology* 519 (2014) 732–742
- Madani, K., 2010. Game theory and water resources. *Journal of Hydrology* 381, 225-238.
- March, H., Therond, O., Leenhardt, D., 2012. Water futures: Reviewing water-scenario analyses through an original interpretative framework. *Ecol. Econ.* 82, 126-137.
- Mariotti, A., Zeng, N., Yoon, J.-., Artale, V., Navarra, A., Alpert, P., Li, L.Z.X., 2008. Mediterranean water cycle changes: Transition to drier 21st century conditions in observations and CMIP3 simulations. *Environmental Research Letters* 3.
- Martin-Carrasco, F., Garrote, L., Iglesias, A., Mediero, L., 2013. Diagnosing Causes of Water Scarcity in Complex Water Resources Systems and Identifying Risk Management Actions. *Water Resour. Manage.* 27, 1693-1705.
- Martin-Ortega, J., 2012 Economic prescriptions and policy applications in the implementation of the European Water Framework Directive, *Environmental science and policy*, 24: 83-91
- Martin-Ortega, J., Balana, B.B., 2012 Cost-effectiveness analysis in the implementation of the Water Framework directive: A comparative analysis of the United Kingdom and Spain. *European Water* 37: 15-25
- Mastrandrea, M.D., Heller, N.E., Root, T.L., Schneider, S.H., 2010. Bridging the gap: Linking climate-impacts research with adaptation planning and management. *Clim. Change* 100, 87-101.

-
- Maton, L., 2008. Evaluation économique du programme de mesures de gestion quantitative des ressources en eau dans l'Ouest de l'Hérault. Volume 1 : Scénario tendanciel et analyse coût-efficacité pour l'usage agricole de l'eau. Rapport BRGM-RP - 56143 - FR. 89p <http://infoterre.brgm.fr/rapports/RP-56143-FR.pdf>
- Maton, L., Girard, C., and Rinaudo, J.D., 2013. Evolution des besoins en eau d'irrigation à l'horizon 2030 dans l'Ouest de l'Hérault. Rapport BRGM- RP - 61323 - FR. 51 pages, 2 annexes. <http://infoterre.brgm.fr/rapports/RP-61323-FR.pdf> (In French)
- Matrosov, E.S., Padula, S., Harou, J.J., 2013a Selecting Portfolios of Water Supply and Demand Management Strategies Under Uncertainty-Contrasting Economic Optimisation and 'Robust Decision Making' Approaches, *Water Resources management* , 27(4), 1123 - 1148. 10.1007/s11269-012-0118-x.
- Matrosov, E.S., Woods, A.M., Harou, J.J., 2013b. Robust Decision Making and Info-Gap Decision Theory for water resource system planning. *Journal of Hydrology* 494, 43-58.
- Mearns, L.O., 2010. The drama of uncertainty. *Clim. Change* 100, 77-85.
- MEDDE (Ministère de l'Energie et du Développement Durable), 2012 Avis relatif à la délibération no 2012-17 du 14 septembre 2012 de l'Agence de l'eau Rhône-Méditerranée et Corse sur les taux des redevances pour les années 2013 à 2018, NOR : DEVL1237461V
- MEDDTL (Ministère de l'Ecologie du Développement Durable, des Transports et du Logement), 2011, Plan national d'adaptation au changement climatique, 2011-2015. Paris, 2011 (In French).
- Medellín-Azuara, J., Harou, J.J., Olivares, M.A., Madani, K., Lund, J.R., Howitt, R.E., Tanaka, S.K., Jenkins, M.W., Zhu, T., 2008. Adaptability and adaptations of California's water supply system to dry climate warming. *Climatic Change* 87, 75-90.
- MEEDDT (Ministère de l'écologie, de l'énergie, du développement durable et de l'aménagement du territoire), (2008), Circulaire du 30 juin 2008 relative à la résorption des déficits quantitatifs en matière de prélèvement d'eau et gestion collective des prélèvements d'irrigation NOR : DEVO0815432C, Bulletin officiel du Ministère de l'écologie, de l'énergie, du développement durable et de l'aménagement du territoire, Paris, 2008 (In French)
- Meehl, G. A., Covey, C., Delworth, T., Latif, M., McAvaney, B., Mitchell, J. F. B., Stouffer, R. J., and Taylor, K. E. ,2007. The WRCM CMIP3 multimodel dataset – a new era in climate change research, *B. Am. Meteor. Soc.*, (88), 1383–1394

References

- Messner, F., 2006. Guest editorial: Applying participatory multicriteria methods to river basin management: Improving the implementation of the Water Framework Directive. *Environment and Planning C: Government and Policy* 24, 159-167.
- Meyer, R., 2012. Uncertainty as a science policy problem. *Clim. Change* 110, 1-2.
- Milano, M., Ruelland, D., Fernandez, S., Dezetter, A., Fabre, J., Servat, E., 2012. Facing climatic and anthropogenic changes in the Mediterranean basin: What will be the medium-term impact on water stress? *Comptes Rendus - Geoscience* 344, 432-440.
- Mill, J., 1861. Utilitarianism, liberty, and responsive government. *Equity and justice in social behaviour*, 4
- Mollinga, P.P., 2009. Towards the transdisciplinary engineer: Incorporating ecology, equity and democracy concerns into water professionals' attitudes, skills and knowledge. *Irrigation and Drainage* 58, S195-S204.
- Montet, C., And Serra, D., 2003 *Game Theory and Economics*, Palgrave Macmillan
- Moody P., Brown C. (2013) Robustness indicators for evaluation under climate change: Application to the upper Great Lakes. *Water Resources Research* 49, 3576-3588
- Moreau, C., Garin, P., Rinaudo, J.-D., (2013) Justice sociale et allocation initiale des eaux souterraines, *Société Française d'Economie Rurale. 7èmes Journées de Recherches en Sciences Sociales*, Dec 2013, Angers, France. 25 p., 2013 <https://hal.archives-ouvertes.fr/hal-00934914> (In French)
- Moreau, C., Garin, P., Rinaudo, J.-D., (2015) La justice sociale dans la construction du jugement d'acceptabilité. Analyse des réactions d'agriculteurs face à différentes règles de partage de l'eau souterraine, *Économie rurale*, 346, 31-48, URL : <http://economierurale.revues.org/4612> (In French)
- Mouelhi, S., Michel, C., Perrin, C., Andréassian, V., 2006. Stepwise development of a two-parameter monthly water balance model. *Journal of Hydrology* 318, 200-214.
- Nash, J.E., and Sutcliffe, J.V., (1970) River flow forecasting through conceptual models, *J. Hydrol.*, 10(3), 282–290.
- Neal, J.M, Lukaszewicz, A., Syme, G.,J., 2014, Why justice matters in water governance: some ideas for a 'water justice framework, *Water Policy* 16, 1–18
- Newlin, B.D., Jenkins, M.W., Lund, J.R., Howitt, R.E., 2002. Southern California water markets: Potential and limitations. *J. Water Resour. Plann. Manage.* 128, 21-32.
- Nielsen, K., 1979. Radical Egalitarian Justice: Justice As Equality. *Social theory and practice* 5, 209-226.

-
- Norris, Fran H., S.P. Stevens, B. Pfefferbaum, K. F. Wyche, R. L. Pfefferbaum, 2008. Community Resilience as a Metaphor, Theory, Set of Capacities, and Strategy for Disaster Readiness *Am J Community Psychol.* 41:127-150. DOI 10.1007/s10464-007-9156-6
- Nozic, R., 1974. *Anarchy, State and Utopia*. Blackwell, Oxford.
- O'Brien, K., Eriksen, S., Nygaard, L.P., Schjolden, A., 2007: Why different interpretations of vulnerability matter in climate change discourses. *Climate Policy*, 7, 73–88
- O'Laoghaire, D. T., and Himmelblau, D. M., 1974. Optimal expansion of a water resources system. — With 273 pp. New York and London: Academic Press. ISBN 0-12-525450-4.
- Ostrom, E., 2000. Crowding out Citizenship, *Scandinavian Political Studies*, Vol. 23 No. 1, ISSN 00806757
- Oudin, L., Andréassian, V., Mathevet, T., Perrin, C., Michel, C., 2006. Dynamic averaging of rainfall-runoff model simulations from complementary model parameterizations. *Water Resour. Res.* 42.
- Paavola, J., 2008. Science and social justice in the governance of adaptation to climate change. *Environmental Politics*, 17(4), 644–659.
- Paavola, J., Adger, W.N., 2006. Fair adaptation to climate change. *Ecol. Econ.* 56, 594-609.
- Paavola, J., Adger, N., 2006. Fair adaptation to climate change, *Ecological Economics* 56 594– 609 doi:10.1016/j.ecolecon.2005.03.015
- Padula, S., Harou, J.J., Papageorgiou, L.G., Ji, Y., Ahmad, M., Hepworth, N., 2013. Least Economic Cost Regional Water Supply Planning - Optimising Infrastructure Investments and Demand Management for South East England's 17.6 Million People. *Water Resour. Manage.* 27, 5017-5044.
- Pagé, C. and Terray, L., 2010. Nouvelles projections climatiques à échelle fine sur la France pour le 21ème siècle : les scénarii SCRATCH2010. Technical Report TR/CMGC/10/58, SUC au CERFACS, URA CERFACS/CNRS No1875CS, Toulouse, France (<http://www.cerfacs.fr/~page/work/scratch/>). (In French)
- Pahl-Wostl, C., 2009. A conceptual framework for analysing adaptive capacity and multi-level learning processes in resource governance regimes, *Global Environmental Change*, 19 (3) 354–365, DOI: 10.1016/j.gloenvcha.2009.06.001
- Parrachino, I., Dinar, A., Patrone, F., 2006. Cooperative game theory and its application to natural, environmental, and water resource issues: 3. Application to Water Resources. World Bank Policy Research Working Paper No. 4074, WPS4072. <<http://www->

References

- wds.worldbank.org/external/default/WDSContentServer/IW3P/IB/2006/11/21/000016406_20061121155643/Rendered/PDF/wps4074.pdf>.
- Peña-Haro, S., Llopis-Albert, C., Pulido-Velázquez, M., Pulido-Velázquez, D., 2010. Fertilizer standards for controlling groundwater nitrate pollution from agriculture: El Salobral-Los Llanos case study, Spain. *J. Hydrol.* 392: 174–187.
- Peña-Haro, S., M. Pulido-Velazquez, A. Sahuquillo, 2009. A hydro-economic modelling framework for optimal management of groundwater nitrate pollution from agriculture. *Journal of Hydrology* 373, pp. 193–203
- Poff, N.L., Allan, J.D., Bain, M.B., Karr, J.R., Prestegard, K.L., Richter, B.D., Sparks, R.E., Stromberg, J.C., 1997. The natural flow regime: A paradigm for river conservation and restoration. *Bioscience* 47, 769-784.
- Pohl, C., 2005. Transdisciplinary collaboration in environmental research. *Futures* 37, 1159-1178. [http://refhub.elsevier.com/S1364-8152\(15\)00082-1/sref51](http://refhub.elsevier.com/S1364-8152(15)00082-1/sref51)
- Postel S. Richter B., 2003. *Rivers for Life: Managing Water for People and Nature*. Island Press, Washington, DC.
- Pouget, L., Escaler, I., Guiu, R., Mc Ennis, S., Versini, P., 2012. Global Change adaptation in water resources management: The Water Change project. *Sci. Total Environ.* 440, 186-193.
- Praskievicz, S., Chang, H., 2009. A review of hydrological modelling of basin-scale climate change and urban development impacts. *Prog. Phys. Geogr.* 33, 650-671.
- Prudhomme, C., Wilby, R.L., Crooks, S., Kay, A.L., Reynard, N.S., 2010. Scenario-neutral approach to climate change impact studies: Application to flood risk. *Journal of Hydrology* 390, 198-209.
- Pulido-Velazquez D., García-Aróstegui J. L., Molina J.L., and Pulido-Velazquez M. (2015), Assessment of future groundwater recharge in semi-arid regions under climate change scenarios (Serral-Salinas aquifer, SE Spain). Could increased rainfall variability increase the recharge rate?, *Hydrol. Process.*, 29, 828–844, doi: 10.1002/hyp.10191
- Pulido-Velazquez, M., Alvarez-Mendiola, E., Andreu, J., 2013. Design of efficient water pricing policies integrating basinwide resource opportunity costs. *J. Water Resour. Plann. Manage.* 139, 583-592.
- Pulido-Velazquez, M., Andreu, J., Sahuquillo, A., Pulido-Velazquez, D., 2008. Hydro-economic river basin modelling: The application of a holistic surface-groundwater model to assess opportunity costs of water use in Spain. *Ecol. Econ.* 66, 51-65.

-
- Pushpalatha, R., Perrin, C., Moine, N.L., Andréassian, V., 2012. A review of efficiency criteria suitable for evaluating low-flow simulations. *Journal of Hydrology* 420-421, 171-182.
- Quevauviller, P., 2014. European water policy and research on water-related topics - An overview. *Journal of Hydrology* .
- Quevauviller, P., Barceló, D., Beniston, M., Djordjevic, S., Harding, R.J., Iglesias, A., Ludwig, R., Navarra, A., Navarro Ortega, A., Mark, O., Roson, R., Sempere, D., Stoffel, M., van Lanen, H.A.J., Werner, M., 2012. Integration of research advances in modelling and monitoring in support of WFD river basin management planning in the context of climate change. *Sci. Total Environ.* 440, 167-177.
- Quintana-Seguí, P., Le Moigne, P., Durand, Y., Martin, E., Habets, F., Baillon, M., Canellas, C., Franchisteguy, L., Morel, S., 2008. Analysis of near-surface atmospheric variables: Validation of the SAFRAN analysis over France. *Journal of Applied Meteorology and Climatology* 47, 92-107.
- Rajagopalan, B., Nowak, K., Prairie, J., Hoerling, M., Harding, B., Barsugli, J., Ray, A., Udall, B., 2009. Water supply risk on the Colorado River: Can management mitigate? *Water Resour. Res.* 45.
- Ransmeier, 1942. *The Tennessee Valley Authority: A case study in the Economics of Multiple Purpose Stream Planning*, Vanderbilt University press, Nashville, Tennessee
- Rawls, J., 1971. *A theory of justice*. Harward University Press
- Refsgaard, J.C., van der Sluijs, J.P., Højberg, A.L., Vanrolleghem, P.A., 2007. Uncertainty in the environmental modelling process - A framework and guidance. *Environmental Modelling and Software* 22, 1543-1556.
- Reifen, C., and R. Toumi, 2009, Climate projections: Past performance no guarantee of future skill?, *Geophys. Res. Lett.*, 36, L13704, doi:10.1029/2009GL038082.
- Resco, P., Iglesias, A., Bardají, I., Sotés, V., 2015. Exploring adaptation choices for grapevine regions in Spain. *Regional Environmental Change* .
- Reuss, M., 2003. Is It Time to Resurrect the Harvard Water Program?, EDITORIAL , *J. Water Resour. Plann. Manage.*, 129, 5 , 357–360. EDITORIAL
- Riegels, N., Pulido-Velazquez, M., Doulgeris, C., Sturm, V., Jensen, R., Møller, F., Bauer-Gottwein, P., 2013. Systems analysis approach to the design of efficient water pricing policies under the EU water framework directive. *J. Water Resour. Plann. Manage.* 139, 574-582.

References

- Rinaudo, J.D. and Garin, P., 2005. The benefits of combining lay and expert input for water-management planning at the watershed level, *Water Policy*, 7(3), 279-293
- Rinaudo, J.D., 2011. Recherche et réparation de fuites quand la ressource est limitée : une approche économique. *Technicités* No. 221, December, page 16-18.
- Rinaudo, J.-D., Neverre, N., Montginoul, M., 2012. Simulating the impact of pricing policies on residential water demand: A southern france case study. *Water Resour. Manage.* 26, 2057-2068.
- Rinaudo, J.-D, Maton, L., Terrason, I., Chazot, S., Richard-Ferroudji, A., Caballero, Y., 2013a. Combining scenario workshops with modeling to assess future irrigation water demands. *Agric. Water Manage.* 130, 103-112.
- Rinaudo, J-D, Noel, Y., Marchal, J.-P., Lamotte, C., 2013b. Evaluation du coût de mobilisation de nouvelles ressources en eau souterraine dans l'Ouest de l'Hérault. Rapport BRGM-RP- 61794-FR <http://infoterre.brgm.fr/rapports/RP-61794-FR.pdf> (In French)
- Rinaudo JD, Girard C., Vernier de Byans C, 2013c, Analyse coût efficacité du programme de mesures de gestion quantitative : Application de deux méthodes au bassin versant de l'Orb Rapport BRGM. Available at <http://infoterre.brgm.fr/rapports/RP-62713-FR.pdf> (In French)
- Rinaudo, J.D., 2014, Water cap & Trade project final report, Water market scenarios for southern Europe: new solutions for coping with increasing water scarcity and drought risk ? at : <https://sites.google.com/site/capandtraderesearch/final-report>
- Rinaudo JD. et Barraque B., 2015. Inter-basin transfers: the end of an era? Volume 15 pp. 175-200 In Grafton Q. et al, *Understanding and managing urban water in transition. Global Issues in Water Policy*. Springer. DOI 10.1007/978-94-017-9801-3_8
- Roggero, M., 2015. Adapting institutions: exploring climate adaptation through institutional economics and set relations *Ecological Economics* 118 114–122, <http://dx.doi.org/10.1016/j.ecolecon.2015.07.022>
- Rosenthal, E., 2012. GAMS, A User's Guide Tutorial by Richard E. Rosenthal, GAMS Development Corporation, Washington, DC, USA
- Ruf, T., 2015 Transférer l'eau du Rhône dans le Languedoc : regard critique sur les incidences du projet Aqua Domitia et les contradictions territoriales », *Territoire en mouvement Revue de géographie et aménagement* [En ligne], 25-26, <http://tem.revues.org/2778> ; DOI : 10.4000/tem.2778

-
- Sadurski, W., 1985. Giving desert its due: social justice and legal theory. Kluwer Academic Publishers
- Salas-Mélia, D., F. Chauvin, M. Déqué, H. Douville, J.F. Gueremy, P. Marquet, S. Planton, J.F. Royer and S. Tyteca, 2005. Description and validation of the CNRM-CM3 global coupled model, CNRM working note 103. http://www.cnrm.meteo.fr/scenario2004/references_eng.html (accessed 20/01/2014)
- Schmeidler, D., 1969. The nucleolus of a characteristic function game. *SIAM Journal of Applied Mathematics*, 17, 1163–1170.
- Sechi, G.M., Zucca, R., Zuddas, P., 2013. Water Costs Allocation in Complex Systems Using a Cooperative Game Theory Approach *Water Resources Management*, 27 (6), pp. 1781-1796. .doi: 10.1007/s11269-012-0171-5
- Shapley and Shubik, 1954 Shapley, L. S. and Shubik, M., 1954. A method for evaluating the distribution of power in a committee system. *American Political Science Review* 48, 787–792.
- Shapley, L. S., 1953. A value for n-person games. *Annals of Mathematics Studies* 28, 307–318,
- Singh, A., 2012. An overview of the optimization modelling applications. *Journal of Hydrology* 466-467, 167-182.
- Smit, B., Wandel, J., 2006. Adaptation, adaptive capacity and vulnerability. *Global Environ. Change* 16, 282-292.
- Smith, J.B., 1997. Setting priorities for adapting to climate change. *Global Environ. Change* 7, 251-264.
- SMVO (Syndicat Mixte de la Vallée de l'Orb), 2013. Contrat de rivière Orb-Libron, 2011-2015, Dossier définitif, Dossier M001 8 03 039 / EV. <http://www.vallees-orb-libron.fr/wp-content/uploads/2012/12/dossier-definitif-contrat-riviere-orb-libron-11-15.pdf> (In French)
- SMVO, 2014 Stratégie SAGE ORB – LIBRON , Syndicat Mixte des Vallées de l'Orb et du Libron, Béziers, 2014
- Sperna Weiland, F.C., Van Beek, L.P.H., Kwadijk, J.C.J., Bierkens, M.F.P., 2012. Global patterns of change in discharge regimes for 2100. *Hydrology and Earth System Sciences* 16, 1047-1062.
- Srdjevic, B., Medeiros, Y.D.P., Faria, A.S., 2004. An objective multi-criteria evaluation of water management scenarios. *Water Resour. Manage.* 18, 35-54.

References

- Steinschneider, S., Polebitski, A., Brown, C., Letcher, B.H., 2012. Toward a statistical framework to quantify the uncertainties of hydrologic response under climate change. *Water Resour. Res.* 48.
- Straffin, P., and J. P. Heaney, 1981, Game theory and the Tennessee Valley Authority, *Int. J. Game Theory*, 10, 35-43
- Syme G. J. 2012 Justice and Environmental Decision Making In: E. Kals and J. Maes (eds.), *Justice and Conflicts*, DOI 10.1007/978-3-642-19035-3_17, # Springer-Verlag Berlin Heidelberg 2012
- Syme, G. J., and Nancarrow, B. E. 1997. The determinants of perceptions of fairness in the allocation of water to multiple uses. *Water Resour. Res.* 32: 1843-1850
- Tanaka, S.K., Zhu, T., Lund, J.R., Howitt, R.E., Jenkins, M.W., Pulido, M.A., Tauber, M., Ritzema, R.S., Ferreira, I.C., 2006. Climate warming and water management adaptation for California. *Clim. Change* 76, 361-387.
- Taylor, K.E., Stouffer, R.J., Meehl, G.A., 2012. An overview of CMIP5 and the experiment design. *Bull. Am. Meteorol. Soc.* 93, 485–498, [http:// dx.doi.org/10.1175/BAMS-D-11-00094.1](http://dx.doi.org/10.1175/BAMS-D-11-00094.1).
- TEMEZ, J.R., 1977. Modelo matemático de transformación Precipitación Aportación, ASINEL 1977
- Terray, L. and Boé, J. 2013, Quantifying 21st-century France climate change and related uncertainties, *C. R. Geosci.*, 345, 136–149, 2013
- Teutschbein, C., Seibert, J., 2012. Bias correction of regional climate model simulations for hydrological climate-change impact studies: Review and evaluation of different methods. *Journal of Hydrology* 456-457, 12-29.
- Thivet, G. and Fernandez, S., 2012. Water Demand Management: The Mediterranean Experience. Technical focus paper, Plan Bleu & Global Water Partnership, http://planbleu.org/sites/default/files/publications/water_demand_management_plan_bleu_gwp.pdf
- Thomas, D.S.G., Twyman, C., 2005. Equity and justice in climate change adaptation amongst natural-resource-dependent societies. *Global Environ. Change* 15, 115-124.
- Tyler, R.T. and S.L. Blader. 2000. *Cooperation in Groups: Procedural Justice, Social Identity, and Behavioral Engagement*. Philadelphia: Psychology Press.

-
- Udías,A.; Efremov,R.; Galbiati,L.; Cañamón,I. 2012 Simulation and multicriteria optimization modeling approach for regional water restoration management. *Annals of Operations Research*, 219(1) 1-18
- UNECE (United Nations Economic Commission for Europe), 2009. *Guidance on Water and Adaptation to Climate Change*, ECE/MP.WAT/30, United Nations, Geneva
- UNISDR, United Nation Strategy for Disaster Reduction 2009, *Terminology on Disaster risk reduction*, Geneva, Switzerland
- Vachala, S., 2008. *Evaporation sur les retenus EDF du Sud de la France*, Électricité De France. Division Technique Générale, Service ressources en eau.
- Vernier, M. and Rinaudo J.D., 2012. *Scénarios d'évolution de la demande en eau potable à l'horizon 2030 dans l'Ouest Hérault*. Rapport BRGM/RP-61317-FR. BRGM, Orléans, France. 51 pp <http://infoterre.brgm.fr/rapports/RP-61317-FR.pdf> (In French)
- Vier E. and Aigoui. F., 2011. *Etude de définition des débits d'étiage de référence pour la mise en oeuvre d'une gestion quantitative de la ressource en eau dans le bassin de l'Orb*. Rapport provisoire phases 1 et 2. Avril 2011. Syndicat mixte de la vallée de l'Orb. (in French).
- Voinov, A., Bousquet, F., 2010. *Modelling with stakeholders*. *Environmental Modelling and Software* 25, 1268-1281.
- Von Neuman and Morgenstern, 1944. *Theory of Games and Economic Behavior* (Third Edition). New York 1953. Original 1944.
- Vörösmarty, C.J., Green, P., Salisbury, J., Lammers, R.B., 2000. *Global water resources: Vulnerability from climate change and population growth*. *Science* 289, 284-288.
- Walker, W.E., Haasnoot, M., Kwakkel, J.H., 2013. *Adapt or perish: A review of planning approaches for adaptation under deep uncertainty*. *Sustainability* 5, 955-979.
- Walters, C. J. 1986, *Adaptive Management of Renewable Resources*. McMillian, New York.
- Ward, F., and Pulido-Velazquez, M., 2008. *Efficiency, equity, and sustainability in a water quantity–quality optimization model in the Rio Grande basin*, *Ecological economics* 66 (1) 23 -37
- Ward, F.A., 2009. *Economics in integrated water management*. *Environmental Modelling and Software* 24, 948-958.
- WATECO, 2003. *Common implementation strategy for the Water Framework Directive (2000/60/EC)*. Guidance Document no.1.Economics and the Environment - The implementation Challenge of the Water Framework Directive .

References

- Wenz, P. S., 1988. Environmental justice. Albany NY: State University of New York
- Wickson, F., Carew, A.L., Russell, A.W., 2006. Transdisciplinary research: characteristics, quandaries and quality. *Futures* 38, 1046-1059.
- Wilby, R.L., Dessai, S., 2010. Robust adaptation to climate change. *Weather* 65, 180-185.
- Wilke, H. A. M., 1991. Greed, efficiency and fairness in resource management situations. *European Review of Social Psychology*, 2, 165–187.
- Wright, S.A.L., Fritsch, O., 2011. Operationalising active involvement in the EU Water Framework Directive: Why, when and how? *Ecol. Econ.* 70, 2268-2274.
- Wurbs, R.A. 1996, Modeling and analysis of reservoir system operations Prentice Hall.
- Young, H.P., 1994. Chapter 34 Cost allocation. *Handbook of Game Theory with Economic Applications* 2, 1193-1235.
- Young, H.P., Okada, N., Hashimoto, T., 1982. Cost allocation in water resources development (Sweden). *Water Resour. Res.* 18, 463-475.
- Zarri, L., 2010. Behavioral economics has two 'souls': Do they both depart from economic rationality? *The Journal of Socio-Economics*, 39 (5), 562-567.
- Zhou, Y., Tol, R.S.J., 2005. Evaluating the costs of desalination and water transport. *Water Resour. Res.* 41, 1-10.
- Zhu, X., Moriondo, M., Van Ierland, E.C., Trombi, G., Bindi, M., 2014. A model-based assessment of adaptation options for Chianti wine production in Tuscany (Italy) under climate change. *Regional Environmental Change*. Published Online 09/2014
- Zwarteveen, M.Z., Boelens, R., 2014. Defining, researching and struggling for water justice: some conceptual building blocks for research and action. *Water Int.* 39, 143-158.

Appendix A Dissemination

The following communications in international conferences have been realized:

- **Girard C.**, Rinaudo, J.D., Pulido-Velázquez, M., 2015, Comparing cooperative game theory and social justice approaches to allocate the cost of a cost-effective programme of measures at the river basin scale. European Association of Environmental and resources Economics, 2015 annual conference, Helsinki, 24-27 June 2015 (Working paper presented during an Oral presentation)
- **Girard, C.**, Rinaudo, J.-D. and Pulido-Velazquez M. 2015 Towards an equitable allocation of the cost of a global change adaptation plan at the river basin scale: going beyond the perfect cooperation assumption,. EGU General Assembly 2015, Vienna, Austria, Geophysical Research Abstracts, Vol. 17, EGU2015-812, 2015. (Poster)
- **Girard C.**, Rinaudo, J.-D., Pulido-Velázquez, M., C., Pagé, and Caballero, 2014 Integrating top-down and bottom-up approaches to design global change adaptation at the river basin scale, Y., EAERE-FEEM-VIU European Summer School on the Economics of Adaptation to Climate Change , 2014 Venice, Italy. (Oral presentation)
- **Girard C.**, Rinaudo, J.-D., Caballero, Y., and Pulido-Velázquez M., 2013 Modelo de optimización para la selección de programas de medidas de oferta y demanda de menor coste a escala de Cuenca, III Jornadas de Ingeniería del Agua, Valencia, España, 23 y 24 de octubre de 2013 La protección contra los riesgos hídricos, Edición Marcombo S.A., Barcelona, ISBN 978-84267-2070-2 (Poster y artículo en libro con ISBN)
- **Girard C.**, Rinaudo, J.-D., Caballero, Y., and Pulido-Velazquez M. 2013 Assessing the opportunity cost of environmental flows in the management of water resources systems. Water in the Anthropocene: Challenges for Science and Governance Indicators, Thresholds and Uncertainties of the Global Water System, May 21-24, Bonn, Germany (Oral presentation).

- **Girard, C., Caballero, Y., Rinaudo, J.-D. and Pulido-Velazquez M.** 2013 A method to assess the cost of adaptation to climate change in water resources system through least-cost river basin optimization model. International Water Association International conference on Water economics, financing and management, Marbella, Spain, April 2013. (Oral presentation)
- **Girard, C., Caballero, Y., Rinaudo, J.-D. and Pulido-Velazquez M.,** Standard Cost-Effectiveness Analysis vs. Least-Cost River Basin Optimization Model in the selection of programme of measures (EU-WFD). International Water Association International conference on Water economics, financing and management, Marbella, Spain, April 2013. (Oral presentation)
- **Girard C., Rinaudo, J.-D., Caballero, Y., and Pulido-Velazquez M.** 2013 Selecting quantitative water management measures at the river basin scale in a global change context, European Geophysical Union General Assembly, Vienna, April 2013, Geophysical Research Abstracts, Vol. 15, EGU2013-920, 2013, EGU General Assembly 2013 (Oral presentation)

The following dissemination book has been co-authored:

- Grémont M., **Girard C.**, Gauthey J. and Augeard B., 2015. Contribution of hydro-economic models to water management in France. Onema. Knowledge for action series. Paris ISBN 979-10-91047-46-3 (in French) www.onema.fr/IMG/pdf/MHE_ONEMA.pdf

Appendix B Downscaling

Downscaling technique

The “weather type” downscaling technique (Boé and Terray, 2008; Boé, et al., 2009) was developed by CERFACS (European centre for research and advanced training in scientific calculation, www.cerfacs.fr), within the SCRATCH project in 2010 (www.cerfacs.fr/~page/work/scratch). It is used to statistically link the large-scale circulation (predictor variables) and the local-scale climate variables to disaggregate the output from coarse spatial resolution climate models of both temperature and precipitation (DSCLIM: Pagé and Terray, 2010). The method aims at finding groups of days exhibiting similar large-scale atmospheric circulations (weather type) with the most discriminating features regarding local climatic variables of interest over a specific region and season. The large-scale variables considered are the mean sea level pressure and the average temperature at two metres. Each season is processed separately because the atmospheric circulation differs significantly between seasons. Once the major weather-types (accounting for most of the observed variance) have been derived using an automated classification algorithm for each season, each day of the learning period is classified according to its distance from each weather-type. A regression equation is then built combining the distances from weather-types and the local scale variables (precipitation, and also temperature for the summer season). These regression coefficients are then used to downscale future local-scale conditions simulated by climate models. The climate data are provided on a daily time step with a spatial resolution of 8 km that fits the grid of the historical local meteorological data set SAFRAN (Quintana-Segui, et al., 2008), since it is used in the learning phase of the downscaling technique. The SAFRAN database, developed by the French meteorological office, Météo France, is based on surface observations combined with reanalysed data from climate models (in particular the reanalysis ERA of the European Centre for Medium-Range Weather Forecasts (ECMWF)). It produces hourly time series data of climate parameters. These parameters (temperature, humidity, wind speed, solid and liquid precipitation, solar

radiation and infrared incident radiation) are interpolated on a calculation grid of resolution 8 by 8 km.

Statistical description of the downscaled climate data for the river basin (Data from Figure 5-4)

			Statistics on Potential Evapotranspiration (PET)										
			Obs	Arpège	CCCMA	CNRM	GFDL	GISS	IPSL	MPI	MRI	NCAR	Average
Average	Control period	Average PET	73,2	72,4	72,6	72,9	72,5	73,2	73,3	72,7	72,9	73,8	72,9
		Relative Difference to Obs	0,0%	-1,0%	-0,8%	-0,4%	-0,9%	0,0%	0,2%	-0,7%	-0,3%	0,9%	-0,3%
	Future period	Average PET	na	81,3	83,2	83,1	85,7	81,6	83,3	80,3	79,0	85,5	82,6
		Relative Difference to Obs	na	11,2%	13,8%	13,6%	17,1%	11,6%	13,9%	9,8%	8,0%	16,8%	12,9%
Standard Deviation	Control period	Standard deviation	42,2	44,9	45,3	45,8	45,9	45,5	46,0	45,2	46,0	46,3	45,6
		Relative Difference to Obs	0,0%	-6,5%	-7,3%	-8,5%	-8,9%	-7,7%	-8,9%	-7,2%	-9,1%	-9,7%	-8,2%
	Future period	Standard deviation	na	49,6	50,5	49,9	52,3	48,9	49,6	48,0	48,7	52,4	50,0
		Relative Difference to Obs	na	-17,5%	-19,6%	-18,3%	-24,0%	-16,0%	-17,6%	-13,7%	-15,5%	-24,2%	-18,5%

Table B-1 Statistical analysis of the Potential EvapoTranspiration (PET) data for the observed, control and future climate periods

			Statistics on Precipitation (P)										
			Obs	Arpège	CCCMA	CNRM	GFDL	GISS	IPSL	MPI	MRI	NCAR	Average
Average	Control period	Average P	85,8	79,7	85,1	79,1	85,8	81,4	79,6	84,6	81,5	78,3	81,7
		Relative Difference to Obs	0,0%	-7,0%	-0,8%	-7,7%	0,0%	-5,1%	-7,1%	-1,3%	-5,0%	-8,7%	-4,7%
	Future period	Average P	na	71,0	73,9	64,4	80,5	76,6	83,5	75,8	86,2	67,5	75,5
		Relative Difference to Obs	na	-17,2%	-13,8%	-24,9%	-6,1%	-10,7%	-2,6%	-11,6%	0,5%	-21,3%	-12,0%
Standard Deviation	Control period	Standard deviation	77,4	58,6	70,1	60,5	68,5	63,0	65,5	64,6	63,1	58,8	63,6
		Relative Difference to Obs	0,0%	-24,4%	-9,5%	-21,8%	-11,5%	-18,6%	-15,4%	-16,6%	-18,5%	-24,0%	-17,8%
	Future period	Standard deviation	na	54,1	57,7	46,4	67,7	57,9	71,7	52,8	78,3	55,3	60,2
		Relative Difference to Obs	na	-30,1%	-25,5%	-40,0%	-12,6%	-25,2%	-7,4%	-31,8%	1,1%	-28,6%	-22,2%

Table B-2 Statistical analysis of the precipitation (P) data for the observed, control and future climate periods

Appendix C Hydrology

a) Hydrological analysis

Analyses of data of the natural flow regime

An analysis of the natural hydrological regime of the Orb River basin was performed, based on the comparison of the P, PET and natural flow along the Orb River; this is known as a hydrologic balance.

To characterize the natural flow regime of the Orb River sub-basins, the observed flows at a few gauging stations existing along the river need to be corrected from the influence of the Monts d'Orb reservoir and the Montahut hydropower plant, and the withdrawals directly from the river or from any water body associated with the river for urban and agricultural water supply.

The data of the natural flow regime of most of the nodes originate from another study on the management of the Monts d'Orb reservoir (Chazot et al., 2011) that performed the restitution to the natural flow regime and thus provided us with the monthly natural flow time series. These natural flow time series correspond to the sub-basins located upstream the Réals pumping station (O1 to O6), and have been used without transformation. Downstream of the Réals pumping station, only one sub-basin was considered by Chazot et al. (2011). To take into account the inflows from two tributaries, the Taurou and the Lirou, and the influence of alluvial aquifer, two more sub-basins were defined (O8 and O10) and a final node representing the outlet of the Orb River basin (O12). The natural flows of these 3 sub-basins have been estimated as a part of the inflow calculated downstream of the Réals pumping station proportional to the area of each sub-basin.

The main limitations of the restitution of natural flow regime realized by Chazot, et al. (2011) are due to the lack of accurate observed data. The 11 natural flow time series are restituted from only 3 time series of observed flows and the discharge from the reservoir. The restitutions are mainly realized through interpolation based on ratio proportional to the area of the sub-basins. Additionally, assumptions have been made on the repartition of the flow between the tributaries and the Orb River

when they are located downstream of the reservoir, as this study focused on the management of the reservoir. For instance, the flow between the Mare (M4) sub-basin and the sub-basin O4 is only defined as a 40/60 ratio from the intermediary inflow between the confluences of the Mare and the Jaur to the Orb River. This does not matter for the management of the reservoir, but it does for the comparison with in-stream environmental flow requirements defined for each sub river basin.

The prior natural flows have been analysed in order to assess the quality of the reconstruction of the natural flow regime before using them to calibrate and validate the hydrological model. The annual and monthly precipitation, PET and natural flow time series are presented in Figure C-1.

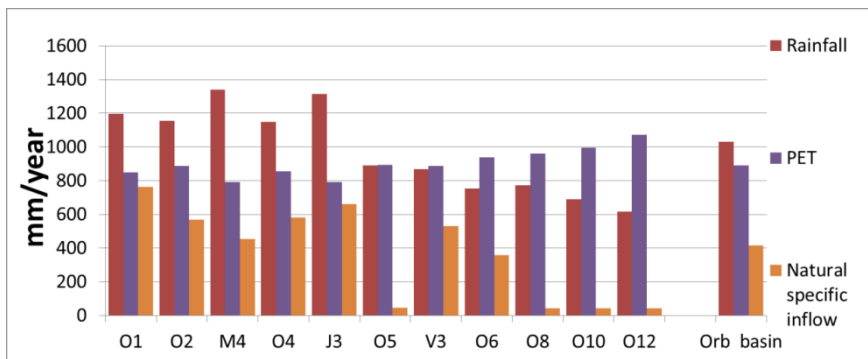

Figure C-1 Annual hydrological balance of the 11 sub-basins

The analysis of the hydrological balance at the river basin scale shows that the runoff represents 40% of the annual rainfall received by the basin. A significant difference appears between the upstream and downstream parts of the basin, in precipitation (400 mm difference between the upstream and downstream parts) and in productivity of the sub-basins, defined as the ratio of runoff (mm) by rainfall (mm). The sub-basins located downstream of the Réals pumping station seem to have a very low productivity.

An analysis of the monthly natural flows is presented in Figure C-2 for the sub-basin O1 and O12 at the two extremes of the basin, the graphs of the other sub-basins are presented at the end of this section. This analysis shows that the Orb River basin maintains a relatively important productivity during the low flow period

of the summer months, mainly in its upstream part. This productivity is linked to the high level of precipitation in the elevated part of the basin (around 1,000 mm over more than 2/3 of the basin). The karst system over 2/3 of the upstream part of the basin and the alluvial aquifer in the downstream part of the basin delay the restitution of these water resources to the low flow period.

Some sub-basins present some dubious natural flow regimes in comparison to the precipitations they received. For instance the sub-basin O5, between the confluence Orb-Jaur and the confluence Vernazobre-Orb, seems underestimated given the rainfall received. This could be due to the method of restitution of the natural flow regime applied by Chazot, et al. (2011). In this case, the natural flow of the sub-basin O5 is estimated based on expert judgment, to be 10% of the natural flow regime restituted upstream the Réals pumping station. If this is true, either the rainfall is overestimated or a part of the water infiltrates the aquifer of Pardailhan or Mont Peyrou. Even if the latter were to play a significant role, there is insufficient data to further analyse this problem. Therefore, hydrological models have been performed using this data.

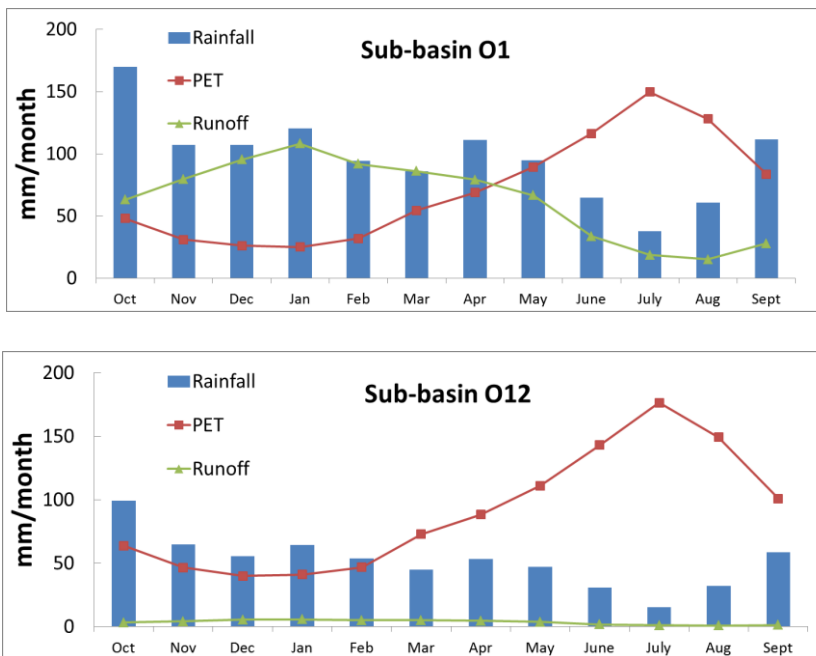

Figure C-2 Monthly hydrological balances for 2 sub-basins (O1 and O12)

Regarding sub-basins O8, O10 and O12, the natural flows have been weighted, since these three different sub-basins are considered as only one sub-basin, between the Réals pumping station and the sea, in the data provided. Chazot et al. (2011) consider that the flow reaching the sea is 98% of the inflow between the gauging station of Vieussan and the Réals pumping station. For July and August, the study realized by Ginger leads to the same conclusion, since the characteristic flows from O6 to O11 are almost equal, meaning that the inflow of these sub-basins is very low. This conclusion coincides with that observed on the hydrological balance presented in Figure 5-7. These sub-basins correspond to those where the Orb flows through its alluvial aquifer. One explanation of the low flow observed for the sub-basin could be that part of the water flows through this alluvial aquifer and therefore is not observed in the in-stream flow. The complexity of the interactions between the river, the alluvial and deep aquifers, and the hydraulic infrastructures in this part of the basin does not allow for further investigation into this topic at this stage.

The conclusion on the restitution of natural flow regime is that three basins have a good estimation of their natural flow, 4 are acceptable, and 4 are dubious corresponding to the less productive one, so with only minor consequences (Table C-1, Figure C-3). The coefficient of the rainfall/runoff is used as an indicator as well as the natural flow restituted. An overly significant difference with the other basins, as for O5 with a coefficient of 0.05, is dubious.

ID	Description	Comments on the restitution to the natural flow regime	Runoff coefficient
O1	Upstream of the Monts d'Orb reservoir	Restitution from the discharge of the reservoir and the evaporation and High/Volume curve of the reservoir	0.64
O2	Monts d'Orb Reservoir- Upstream Mare	Restitution from observed flow at Hérépian gauging station and discharge from the reservoir	0.49
M4	Mare	Estimated as 60% of the inflow between the Mare and the Jaur	0.34
O4	Mare to Jaur	Estimated as 40% of the inflow between the Mare and the Jaur	0.51
J3	Jaur	From the Olargues gauging station and a ratio of the area of the basin	0.50
O5	Jaur to Vernazobre	10% of the inflow between the Jaur and Réals pumping station	0.05
V3	Vernazobre	Ratio on area applied on the Jaur natural flow and a production factor	0.61
O6	Upstream Réals	90% of the inflow between the Jaur and Réals pumping station	0.48
O8	Upstream Tabarka bridge	Estimated from natural flow between Réals and the sea	0.05
O10	Upstream Pont Rouge		0.06
O12	Outlet Sea		0.07

Table C-1 Comparison of the quality of the natural flow regime for the different sub river basins (In green the good, yellow the acceptable, and in red the dubious)

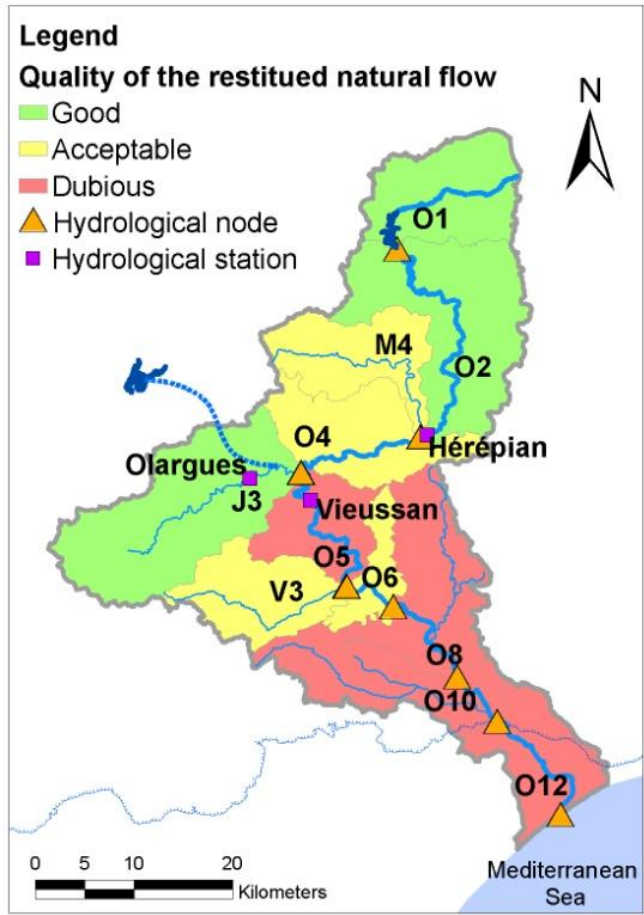
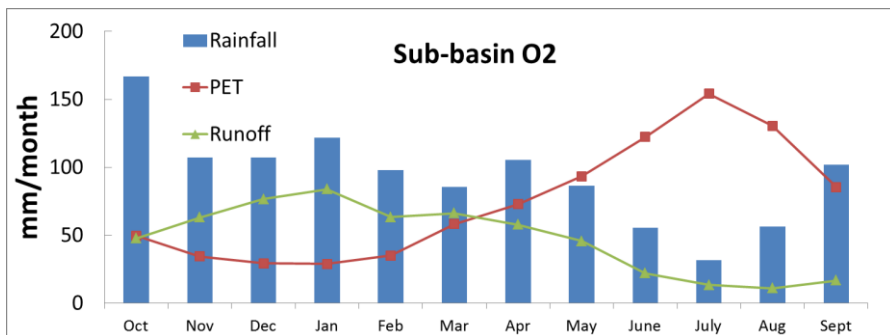
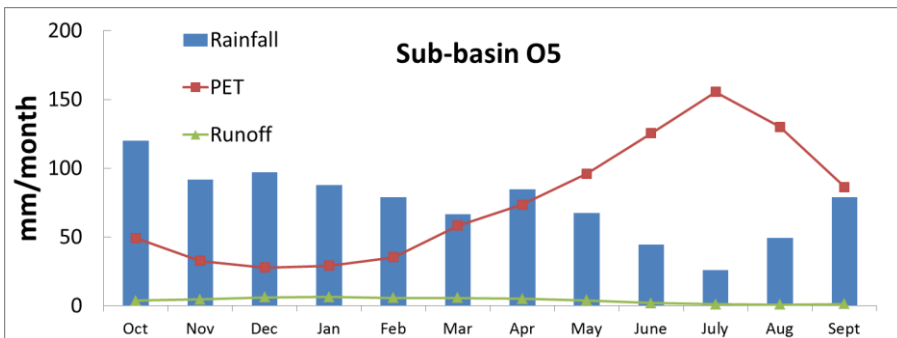
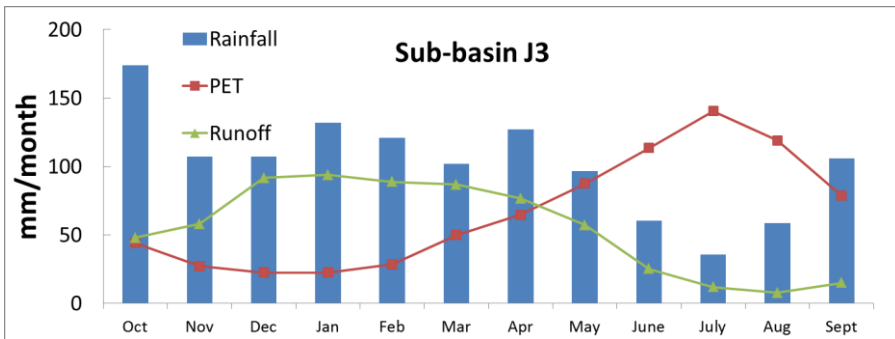
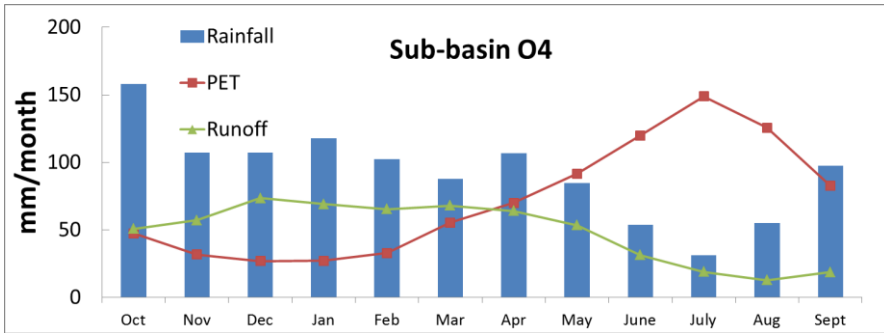
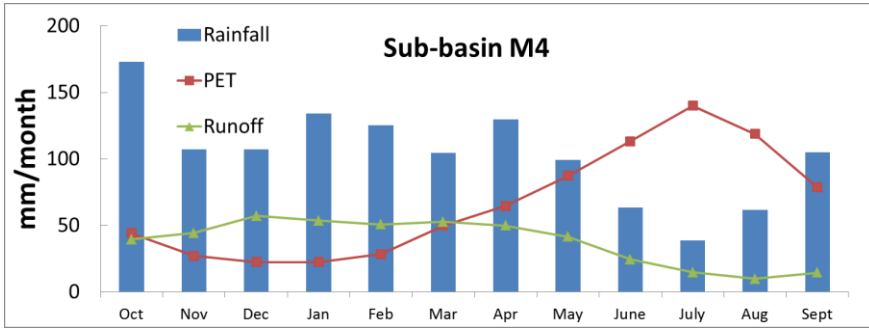
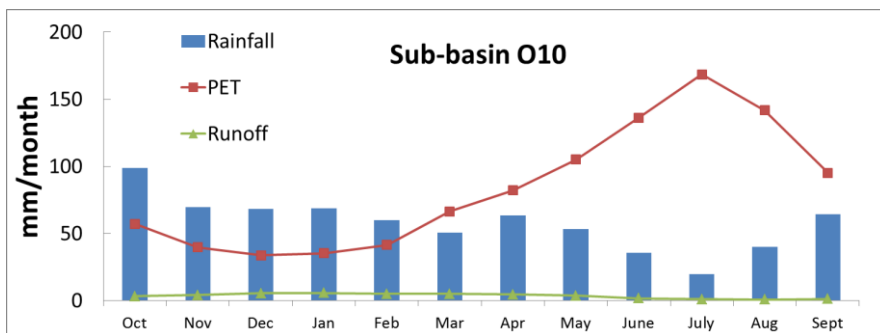
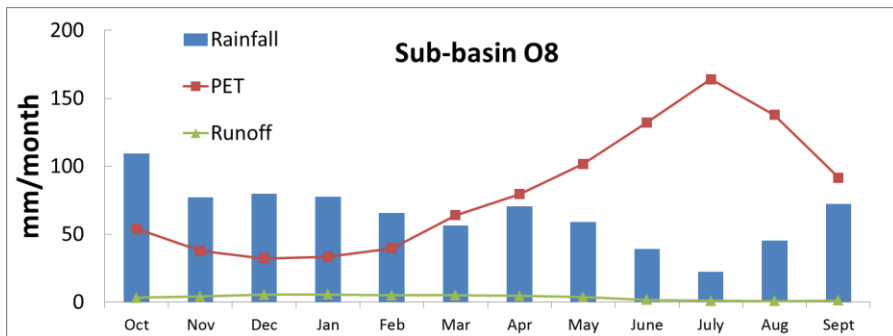
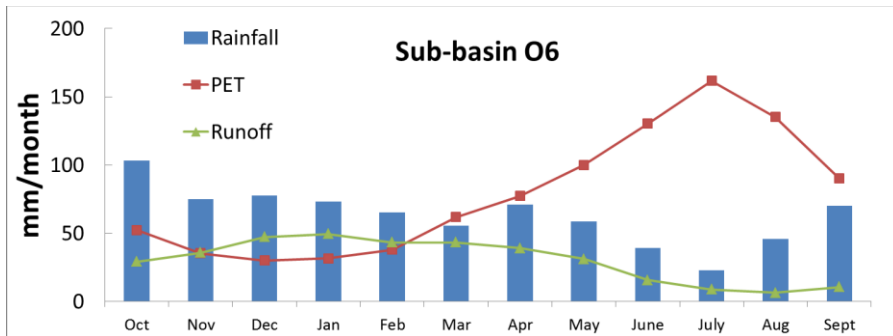
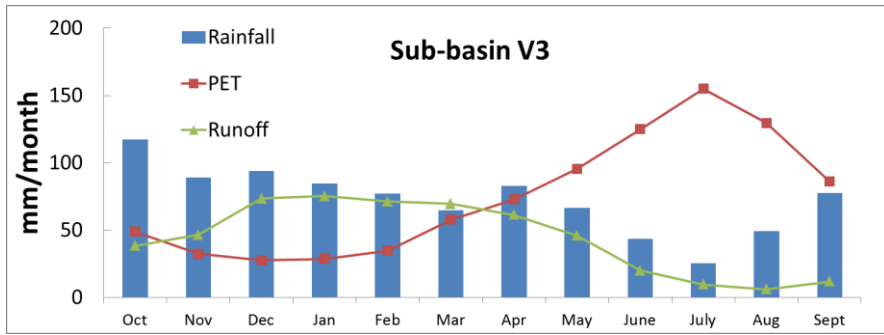

Figure C-3 Map of the quality of the natural flow regime restituted

Graphs of the monthly natural flows, PET, and precipitation on the sub river basins of the Orb River basin







b) Map of the geology of the Orb River basin

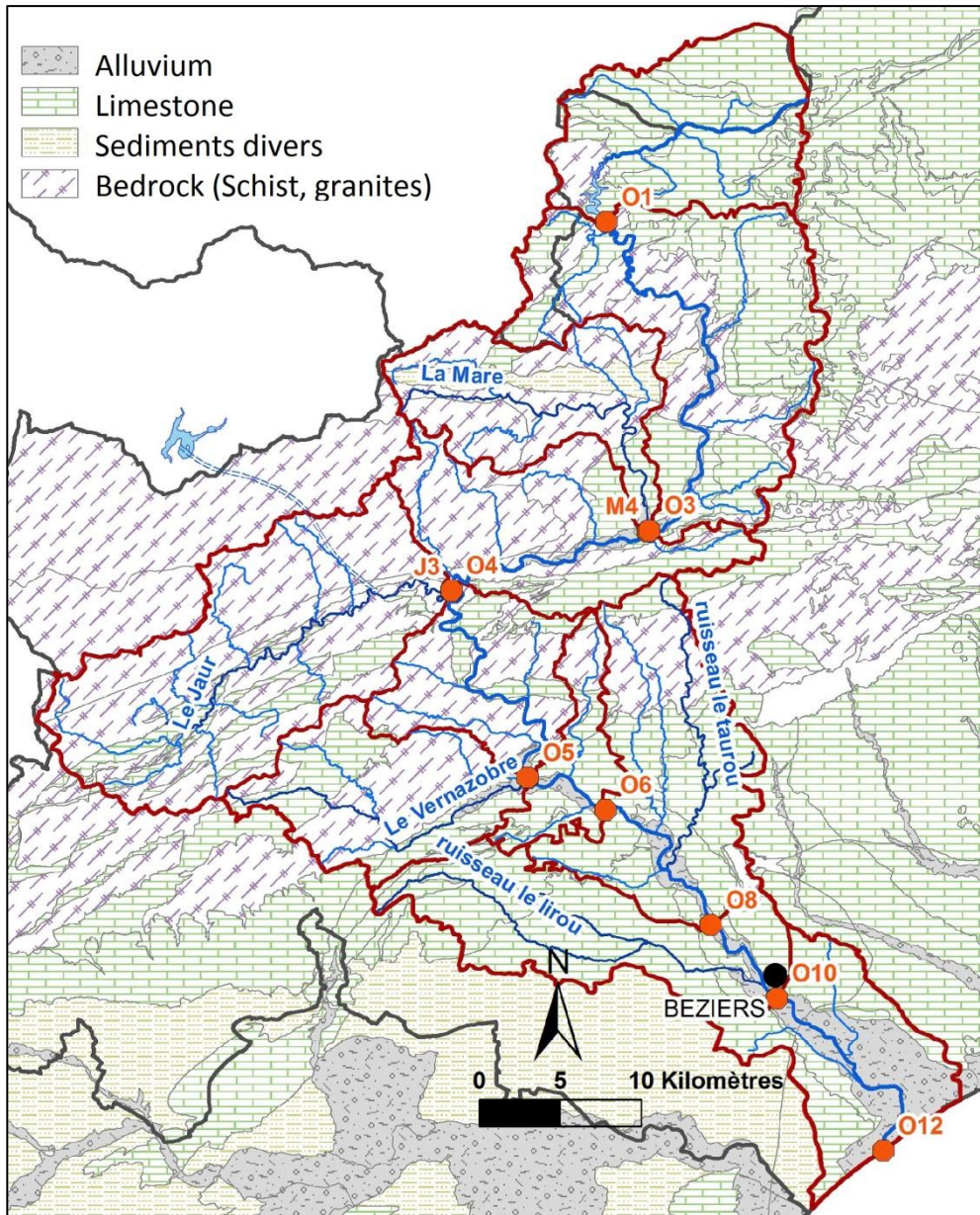

c) Description of the GR2M model

The GR2M model (Mouelhi, et al., 2006) uses two reservoirs associated respectively with two parameters X1 and X2. The first reservoir, named production

store, simulates the function of runoff production on the river basin from PET and precipitation (P) data. The second reservoir receives water from the first and a part of the rainfall. It reproduces the transfer of the runoff to the outlet of the basin (by considering the possibility of interaction with aquifers or export outside of the basin). X1 represents the capacity of the reservoir, its maximum level of soil moisture. X2 represents a coefficient of exchange with the aquifer or an export outside of the basin.

This model has the advantage of being rapidly operational as it requires few entry data, only P, PET, the area of the basin and two initial conditions of the two reservoirs. However, the physical processes are not described and cannot represent the real hydrology of the river basin. The value of the parameter X2 is, for instance, difficult to explain. Nevertheless it is well adapted, as a first tool to simulate the flow regime of the Orb River sub-basins, where all the processes in place in the basin are not fully known.

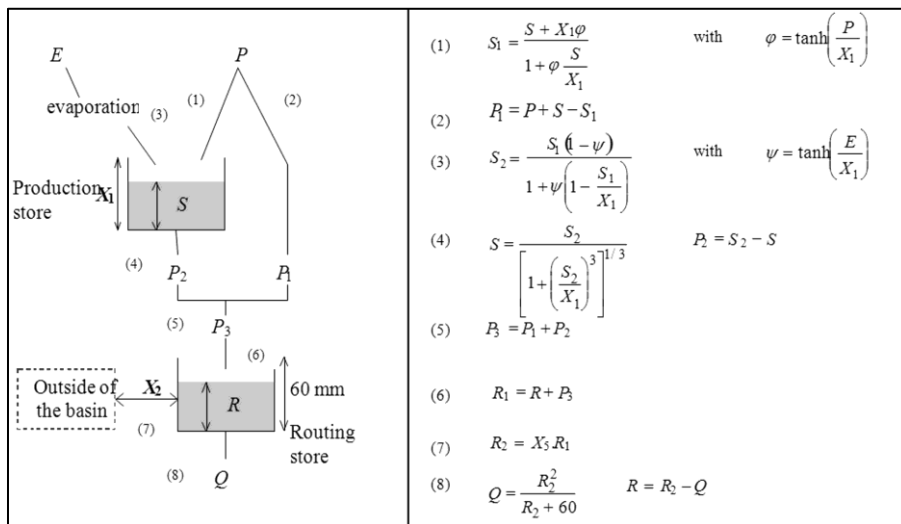

Figure C-4 The GR2M hydrological model

d) Calibration and validation of GR2M on the 11 Orb sub-basins

The model GR2M has been applied on the 11 sub-basins of the Orb River basin with P and PET data for the period 1968-2007. However, for the sub-basin M4 and

O4, the restitution of the natural flow regime is uncertain after the year 1995, as many monthly flow values are equal to zero. Therefore, we decided to limit the modelling period to 1968-1995 on these two sub-basins.

Then, three time periods were defined to have a certain warm-up span, and for the calibration and validation of the GR2M model on the sub-basins. The warm-up period is defined as one year as recommended by the guidelines on GR2M uses (Mouehli et al., 2006). At this stage, the calibration-validation method was made following a simple approach of choosing 10% of the data available for validation, increasing the data available for the calibration phase. As an objective function for calibration, we used the Root Mean Squared Error (RMSE) calculated on root square flows, which was found by Oudin et al., (2006) to be a good compromise for an all-purpose model (not giving too much emphasis on low or high flows). The calibration was realized using the Excel Solver to minimize the RMSE by modifying the two parameters of the model. The initial conditions, the initial level S_0 in the production store and of the initial level R_0 in the routing store, were defined as the average of the value of the model variables S and R in December (the model starting in January). Various efficiency criteria (Krause et al., 2005; Pushpalatha, 2012) were calculated to assess the goodness-of-fit of the models as presented. The NASH criteria (Nash and Sutcliffe, 1970) are better if they are close to 1. A negative value of the NASH criteria implies that the model outcomes are worse than considering the flow as constant each month and equal to the inter-annual monthly average. The RMSE and MAE (Mean absolute error) are better when closer to 0, and the correlation coefficient should get as close to 1 as possible. Colours have been added to help in the interpretation of the figures: green if more than 0.80 in the calibration or more than 0.70 in validation, red if below 0.50, and yellow highlights the different calibration and validation periods.

Sub-basin	O1	O2	M4	O4	J3	O5	V3	O6	O8	O10	O12
WarmUp period	1968-1969										
Calibration	1970-2001		1969-1987			1970-2001					
Nash(Q)	0.86	0.89	0.75	0.78	0.85	0.85	0.80	0.72	0.55	0.46	0.36
Nash(VQ)	0.87	0.88	0.72	0.75	0.82	0.82	0.78	0.72	0.50	0.41	0.34
Nash(ln(Q))	0.83	0.81	0.61	0.68	0.77	0.77	0.71	0.68	0.40	0.32	0.28
rmse	23.8	19.8	20.2	24.0	28.2	28.2	26.1	19.4	2.8	3.1	3.4
mae	14.3	12.0	13.3	16.2	18.4	18.4	16.7	11.4	1.8	2.0	2.2
coef corr	0.95	0.95	0.90	0.92	0.94	0.94	0.92	0.89	0.82	0.78	0.72
Validation	2002-2007		1987-1994			2002-2007					
Nash(Q)	0.93	0.80	0.47	0.54	0.80	0.72	0.78	0.40	0.69	0.58	0.40
Nash(VQ)	0.91	0.76	0.39	0.47	0.83	0.75	0.80	0.66	0.72	0.62	0.47
Nash(ln(Q))	0.87	0.51	-0.07	0.18	0.84	0.73	0.77	0.71	0.68	0.62	0.48
rmse	16.5	29.3	42.1	50.5	29.8	1.8	25.5	20.8	1.7	2.0	2.4
mae	10.8	18.1	27.0	33.4	19.2	1.0	16.7	11.9	1.0	1.2	1.5
coef corr	0.97	0.92	0.80	0.85	0.92	0.88	0.90	0.86	0.87	0.84	0.81

Table C-2 Calibration and validation criteria of the hydrological models.

The following parameters and initial values were used in the GR2M model.

Parameters	O1	O2	M4	O4	J3	O5	V3	O6	O8	O10	O12
x1: Capacity of the production store (mm)	536	490	536	462	541	2514	332	379	2768	3381	7361
x2: Water exchange coefficient (mm)	1.10	0.96	0.69	0.96	0.92	0.35	1.23	1.13	0.43	0.51	0.59
Initial values	O1	O2	M4	O4	J3	O5	V3	O6	O8	O10	O12
Initial level S0 in prod. store (max.: x1 mm)	393	320	402	309	385	1154	203	200	1112	1307	2140
Initial level R0 in routing store (max.: 60 mm)	37.0	34.0	34.0	36.0	36.0	12.6	32.0	27.0	12.0	12.0	12.0

Table C-3 Parameters and initial values of the hydrological models

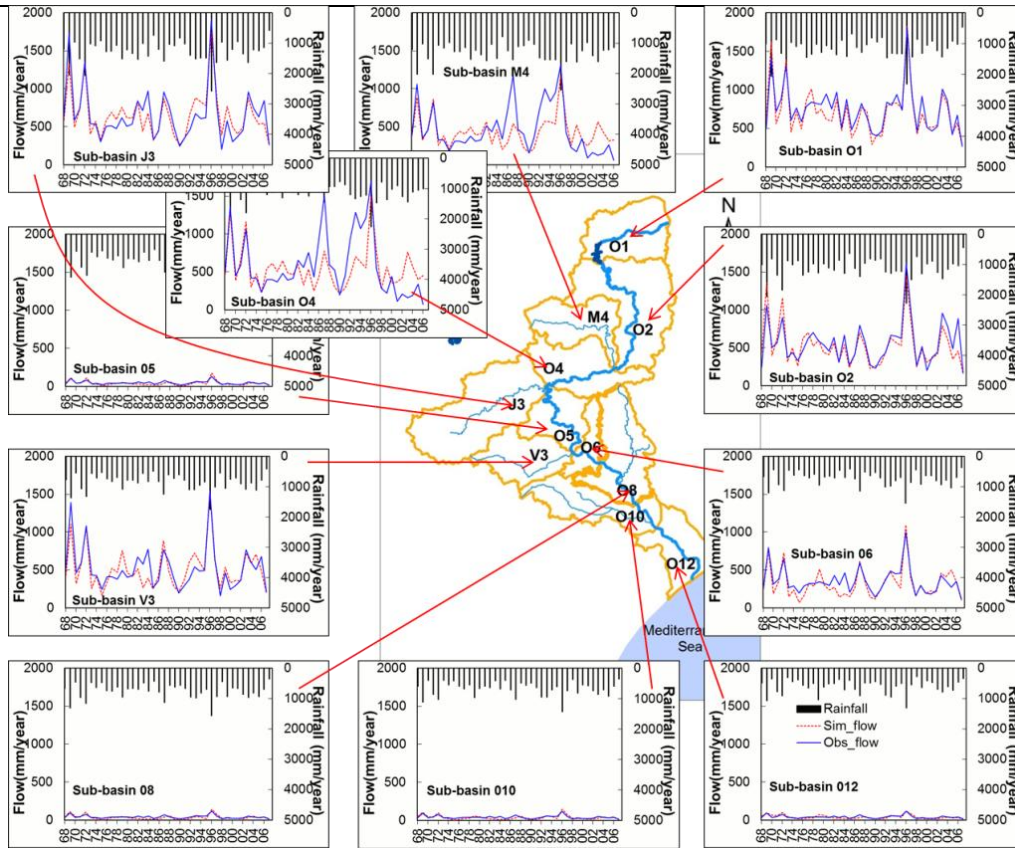

Figure C-5 Comparison of simulated and observed annual flow discharges and rainfall at the 11 sub-river basins from 1968 to 2007. (The model is run at the monthly scale but only annual data are represented)

The monthly flows for the 11 sub-basins were then simulated for the period 1969-2007 (1969-1995 for M4, O4), with various levels of quality. The annual hydrographs below present the result of the calibration and validation of the GR2M for the sub-basin O1 and O12 (Figure C-6). The hydrographs of the other sub-basins are presented in the following section of this appendix.

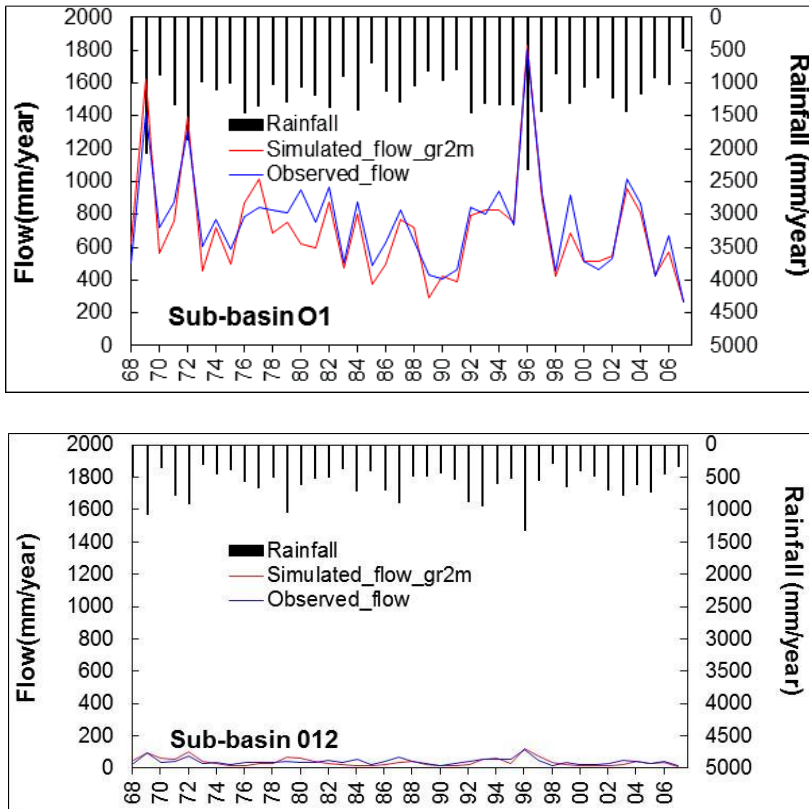

Figure C-6 Results of the hydrological simulation for the sub-basin O1 and O12

The quality of the simulations is different between the sub-basins. While the simulations for O1, O2, J3, V3 and O6 can be considered acceptable, those on O4 and M4 looks dubious, with indicators in calibration as in validation clearly below those of the other sub-basins (Table C-2). In these two sub-basins, the analysis of the difference between observed and modelled flow indicates that simulated flow is closer to observed flow between 1970 and 1980 than afterwards, when the model encounters difficulties in reproducing low flows and high flows. One explanation

could be the capacity of the simple GR2M model to represent the complexity of this type of mountainous sub-basin, characterized by a complex hydrogeology (crystalline basement and limestone formation). However, as described previously, the quality of the observed flow available is also questionable. These two sub-basins have changing responses to similar precipitations between the beginning and the end of the observed period available. This can be caused by important changes in land use in the sub-basins. It also corresponds to the difficulty mentioned previously on the restitution of the natural flow regime, especially after 1986 and the starting of the Montahut hydropower plant that influences the hydrological station at Vieussan. The natural flows of O4 and M4 have been restituted to this station based on a ratio defined by an expert judgment.

For the sub-basins O5, O8, O10, and O12, the model is able to reproduce the low production of these sub-basins by completely changing the range of the two parameters X1 and X2 (respectively higher and lower). However, the performances are poorer than for the other basin as shown by the indicators in Table C-4.

The conclusion is that the results of the calibration and validation of the GR2M model are closely linked to the quality of the restitution of the natural flow regime. The poorest coefficients correspond to the sub-basins identified as uncertain for their restitution of the natural flow regime (Table C-1). Therefore further work would be needed to understand the relation between the river and the aquifers to improve the description of the flow regime of these sub-basins.

Annual hydrographs for the calibration-validation period of the GR2M.

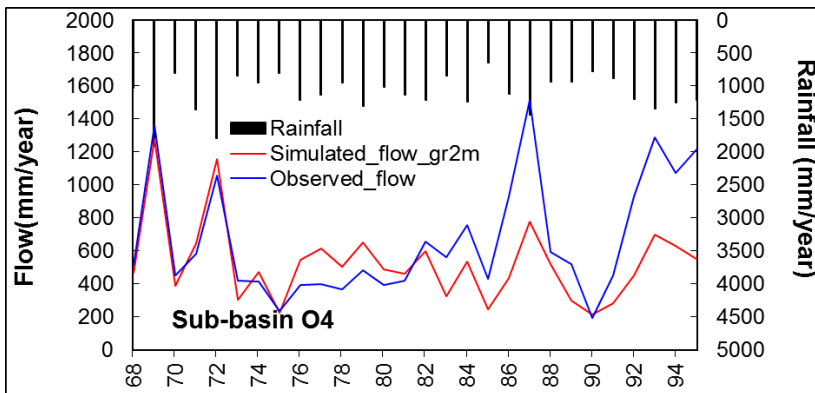
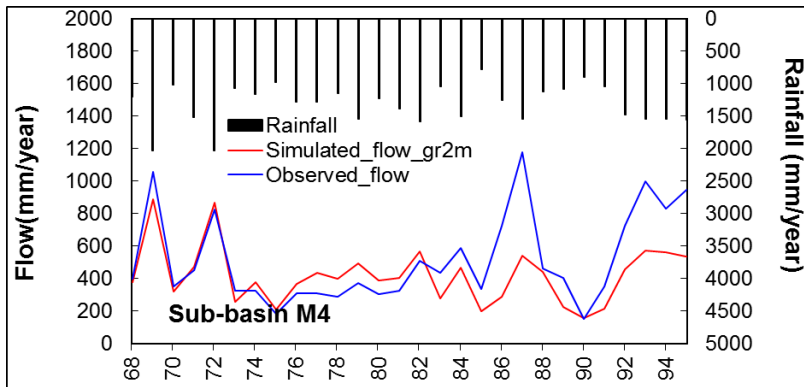
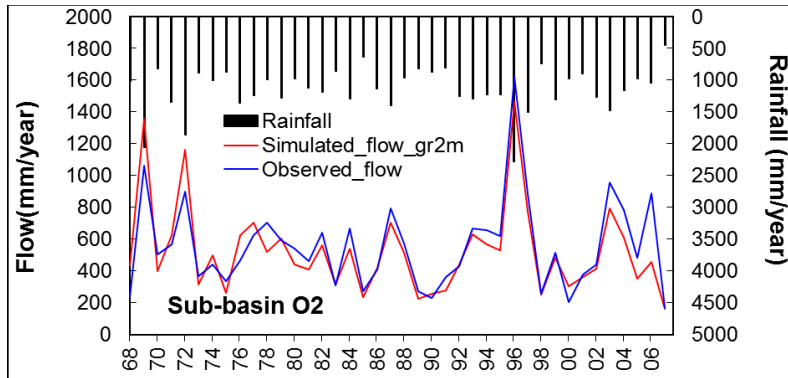

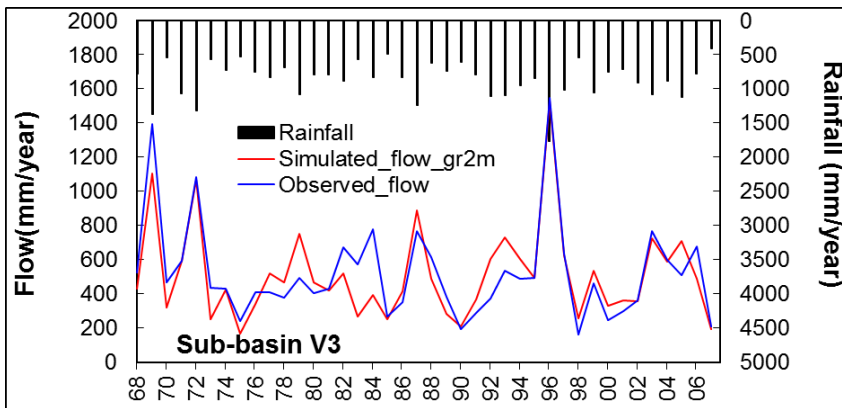
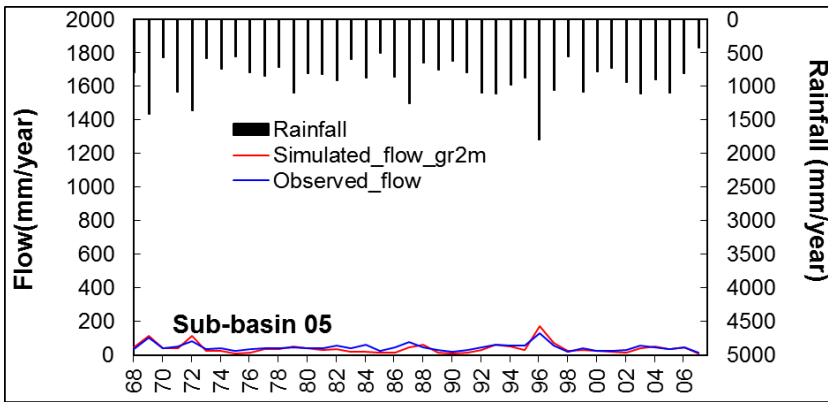
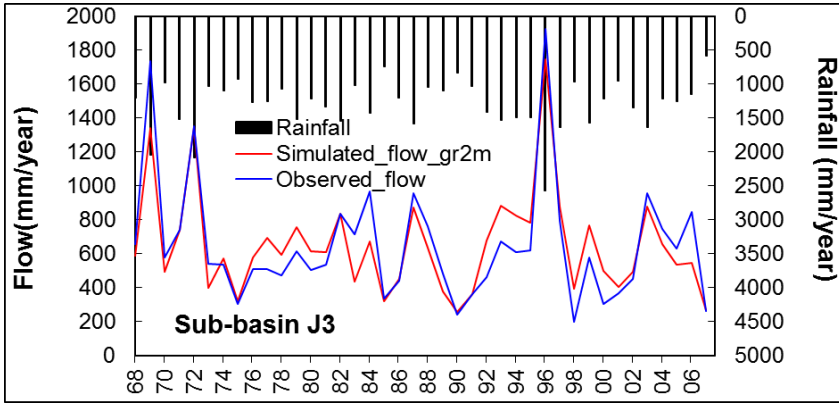

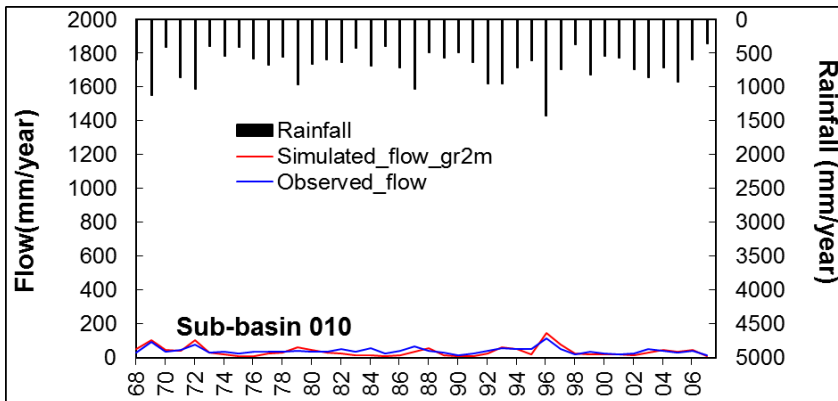
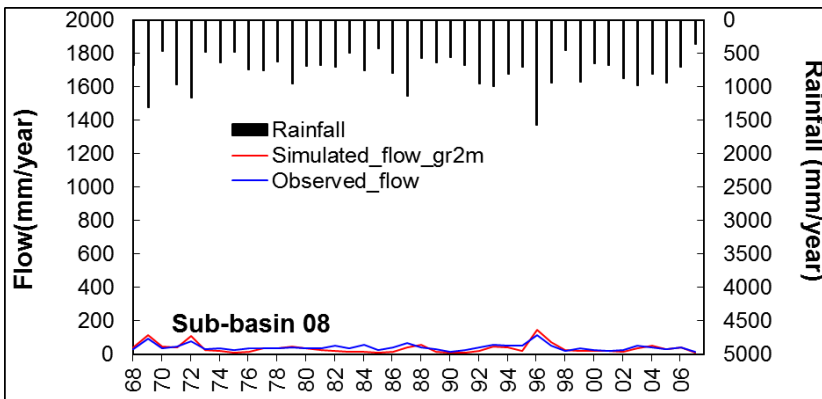
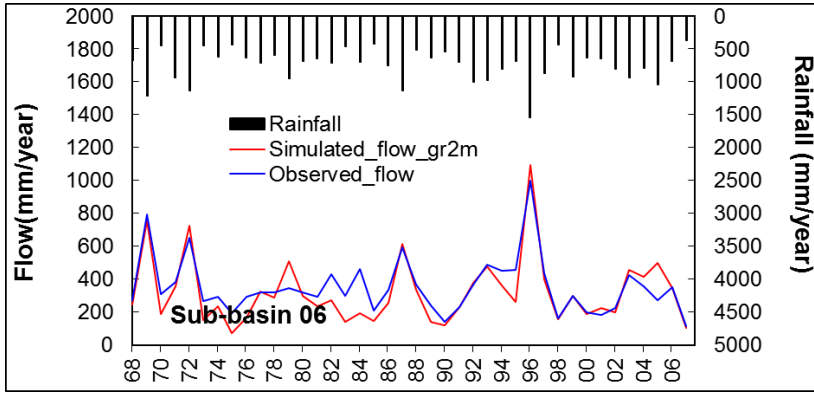

e) Comparison between GR2M and Temez models

In order to select the most appropriated rainfall-runoff model, the 2-parameter GR2M model and the 4-parameter TEMEZ model commonly used in Spain (TEMEZ, 1977) were tested. This comparison was realized during an internship supervised during the current thesis (Berthomieu, 2012). The results of the simulation at the basin scale for the two models are close at the annual scale, and the GR2M model performed better on the monthly average flow as it is closer to the natural flow (Figure C-7). The values of the indicators used for the calibration and validation of the GR2M and Temez models are also similar (Table C-4), even if the GR2M model seems to perform better than the Temez model in almost all the indicators, except from the Nash indicator in the validation. The conclusion is that, with less parameters, the GR2M model performed as well as the TEMEZ model. Therefore the GR2M model has been applied to all 11 sub river basins of the Orb River basin, as it easier to use and provides good results.

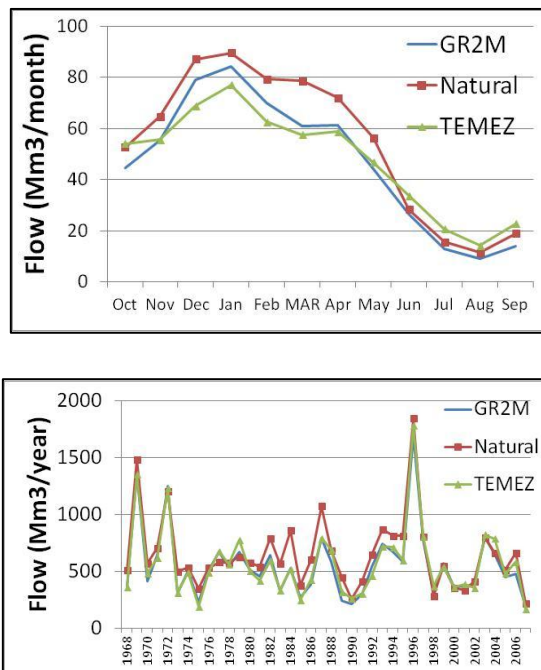

Figure H-3 Comparison of the results of the flow simulation of the Orb River basin with the GR2M and Temez models. At the top average monthly flows, at the bottom annual flow series.

Phase	Indicator	GR2M	TEMEZ
Calibration	RMSE	13,2	23,4
	NASH	0,89	0,86
	MAE	8,2	15,6
	Coef. Correlation	0,96	0,93
Validation	RMSE	11,2	16,3
	NASH	0,89	0,91
	MAE	8,2	12,6
	Coef. Correlation	0,96	1,0

Table C-4 Indicators of the calibration and validation of the Temez and GR2M models. (In green the best value) RMSE: Root mean squared error; NASH: Nash coefficient (in %); MAE; Mean absolute error

Appendix D Agricultural demand

This section presents the way the agricultural demands were calculated for the 19 agricultural zones of the case study (section 5.2.2). The estimations were based on the scenario defined by Maton et al., (2012) for the agricultural activities in the Orb River in 2030. The main assumptions of these scenarios are described and then the method to calculate the water needs and water withdrawals associated with this scenario are presented.

a) Current evolution of the agricultural sector:

Three main tendencies have been identified in the agricultural sector of the Orb River basin (Maton, et al. 2012):

- a concentration of the sector with a decrease in the number of farmers and farms associated with the generalization of the mechanization.
- A relative decrease in the part represented by the vineyard (irrigated or not). From 2000 to 2010 the decrease in farms mainly occurred in vineyards, with a slight increase in market gardening and other types of crops, such as large scale cereals, protein crops and forage for cattle.
- A land pressure on the agricultural lands, the Orb River basin being located in the part of France with the highest population growth associated with an urban sprawl competing with agricultural activities. Agricultural areas decreased by 10 % from 2000 to 2005 with an increase of 30 % in the price of agricultural hectare.

Trends by type of crop:

➤ Vineyards:

The vineyard of the Hérault department represents 40 % of the regional vineyard classified as the 5th vineyard at national level. The major part of the Hérault vineyard is located in the river basin of the Orb and Hérault rivers. However, the production of wine in the south of France is undergoing intensive restructuration after the crisis of the last decade. The number of vineyards has decreased by 36% and the overall vineyard area by 19 %, leading to the extinction of the smallest vineyards and the concentration of the activity in bigger vineyards. Following the widespread uprooting of vineyards between 2003 and 2007, sales are now increasing lead by exportation, especially to the Chinese market.

The drought events of the last decade (2003, 2005, 2006, 2008) have clearly impacted the vineyards. Yields have decreased by 30 %. The quality of the wine, with an overly high alcohol content, has limited sales and young plants, being under-irrigated, have been weakened. Vineyard irrigation, permitted by law since 2006, looks like a promising tool to ensure the quality of the production.

➤ Market gardening:

The production of vegetables represents 300 producers in the Hérault district, even though it corresponds to a small part of the cultivated area, its economic weight is important. The main activity is the large-scale production of melons by large specialized production companies. This highly mechanized cultivation relies on an adapted land distribution of large aggregated fields. Other types of market garden crops, such as tomatoes or asparagus, have seen their area either maintained or decreased during the last decade, mainly due to international competition. The area for industrial production, such as the melon, can change very quickly, given that a producer can rapidly start or cease production over areas ranging from 200ha to 1,000ha. The coastal zone is very attractive for this type of production and could also expand to the Orb River basin, as melon requires crop rotation every 4 years.

➤ Orchards:

The production of fruits has a limited importance in cultivated area, and also in economic value in the region. The tendency is to uproot the apple and peach trees that continue to be the main crop. The decrease in the area of production is significant for almost all the fruit trees and types of orchard. The only increase comes from direct sales or farm-to-table distribution systems supported by the local authorities. The situation is much better for olive trees, driven by an increase in market demand and public subsidies. The area dedicated to olive trees has increased by 1400 ha in the last 10 years, and relies on irrigation from 1,000 to 1,500 m³/ha.

➤ Extensive farming: cereals and protein crops

Wheat is the main cereal produced (81% of the area in the Hérault District) and cultivated areas increased up to 2009 to represent 21,000 ha in the district (93 % cereals). The recent drought events have introduced the need for complementary irrigation. The tendency is a clear increase in the use of pivot irrigation for the cultivation of high-added-value crops. This tendency could favour the development of seed production relying on secure water resources

➤ Forage

The demand for forage has clearly increased in the last decade due to the development of horse farms and the impact of the drought events on the livestock farming areas. Farmers are now considering increasing the forage production in the Orb River basin, where it already represents 32% of the cultivated area of the district (55,764 ha in grass and 7,498 ha in forage). However, this increase relies on irrigation, irrigation costs represent 50 % of the production costs, with water needs of 1,500 to 2,000 m³/ha by aspersion.

The way the water needs of these different crops were calculated is described in the following section for the present and future time period taking into account the impact of climate change. 19 agricultural demand units were defined as depending on the Orb water resources for their water supply, even if only partially (Table D-1).

Appendices

The areas are assumed to correspond to those from the year 2006 for these upstream agricultural demand units. For the downstream agricultural demand units corresponding to administrative wards (“cantons”), the data from the agricultural census of 2010 were used.

Agri Zone ID	Hydro zone or canton ID	Description
a1	O1	The river Orb upstream of the Monts d’Orb reservoir, (Sub river basin O1)
a2	O2	The Orb from the Monts d’Orb reservoir to the confluence with the Mare, (Sub river basin O2)
a3	M4	The Mare upstream of the confluence with the Orb, (Sub river basin M4)
a4	O4	The Orb from the confluence with the Mare to the confluence with the Jaur, Sub river basin O4,
a5	J3	The Jaur upstream of the confluence with the Orb, (Sub river basin J3)
a6	O5	The Orb from the confluence with the Jaur to the confluence with the Vernazobre, (Sub river basin O5)
a7	V3	The Vernazobre upstream of the confluence with the Orb, (V3)
a8	O6	The Orb from the confluence with the Vernazobre to the upstream of the Réals pumping station, (O6)
a9	3401	Canton d’Agde
a10	3435	Canton de Servian
a11	3430*	Canton de St Chinian
a12	1114	Canton de Coursan
a13	1117	Canton de Ginestas
a14	3498	Canton de Beziers
a15	3405	Canton de Beziers 2e
a16	3438	Canton de Beziers 3e
a17	3439	Canton de Beziers 4e
a18	3406	Canton de Capestang
a19	3425*	Canton de Murviel les Beziers

* this zone or “canton” (ward) has been modified due to the intersection with another

Table D-1 List of the 19 agricultural demand units (ADUs) defined for the study

The following graph (Figure D-1) illustrates the distribution of the irrigated area between the agricultural zones defined previously. It must be noted that the irrigated areas are concentrated downstream of the river basin, mainly downstream of the Réals pumping station.

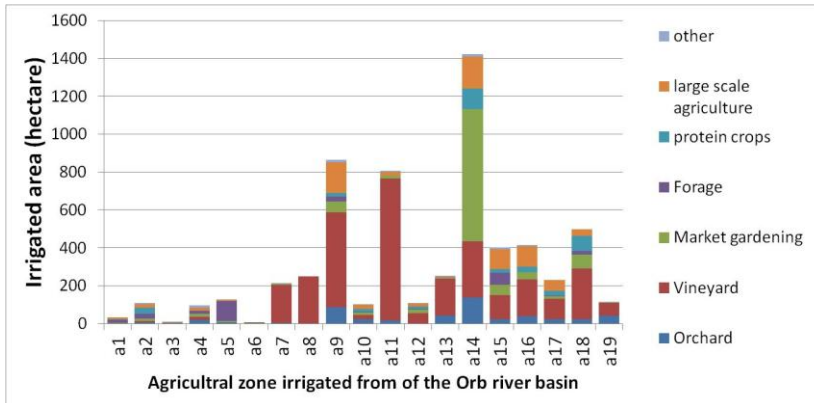

Figure D-1 Distribution of the irrigated areas by crop and Agricultural Demand Unit

b) Evolution scenario to 2030

The main agricultural activities (vineyards, market gardening, orchard, large-scale farming, and forage) and their current tendency have been introduced. However, by 2030, many changes are susceptible to occur. Therefore, an evolution scenario was built through a review of the existing literature on the evolution of the agriculture in the study area and this was completed by semi-structured interviews and focus group discussions with local experts.

Some factors influencing the evolution of the water needs are shared by all the areas of production:

- The evolution of the climate, with the impact of climate change expected to increase water crop needs and the development of irrigation in new areas of cultivation, such as vineyard and forage. The effect of climate change could also have a bigger impact on other production zones and modify the competitive equilibrium.

- The development inherent to each activity, given the opportunities and the evolution of the market.
- The access to water: depending on the evolution of water resources, as well as on the repartition rules established by the local river basin management plan (SAGE). The possibility of developing a distribution network from the water transfer from the Rhône River (Aquadomitia) or other water resources will also influence water needs.
- The irrigation techniques and the level of leakage of the distribution networks.

In the scenario developed, only the evolution of irrigated areas is presented and some element regarding the irrigation practices are detailed (water requirement). The assumptions were made at the scale of the whole Hérault district and were subsequently applied to the Orb River basin. First, two scenarios were developed corresponding to low and high assumptions, then a most probable scenario was built by selecting one of the two hypotheses for each type of production. The assumptions of this most probable scenario are briefly presented below. These assumptions were then translated into evolution of irrigated areas. The scenario developed for the vineyard is presented in more detail as it is the primary agricultural user of water in the study area.

➤ Vineyard

Of the two scenarios selected by experts, the scenario finally selected corresponds to the optimistic scenario desired by the wine-making professionals in the region. It assumes that the 2010 vineyard area will be maintained and irrigation further developed. The sector is assumed to improve its organization through a clear segmentation of the wine and the definition of associated zones to each type of wine.

Indeed, since 2008, wine is segmented between the AOP (Protected appellation of origin) as Saint Chinian in the Orb basin, the IGP (Protected geographic indication) and the wines without geographic indication. The AOP and IGP wines correspond to strict conditions of production, regarding, for instance, the level of irrigation

limited to 1 mm/day during a limited period of drought against 2 mm/day for the other wines.

In 2010, the distribution of these types of irrigated vineyards was dominated by the IGP Vineyard (76 %) followed by the AOP (18 %) and the vineyard without IG (6 %) of the total irrigated vineyard. The distribution among the ADU (Figure D-2) shows a clear distinction between the upstream part of the basin with almost no irrigated vineyard, and the lower part of the basin where the vineyards are located.

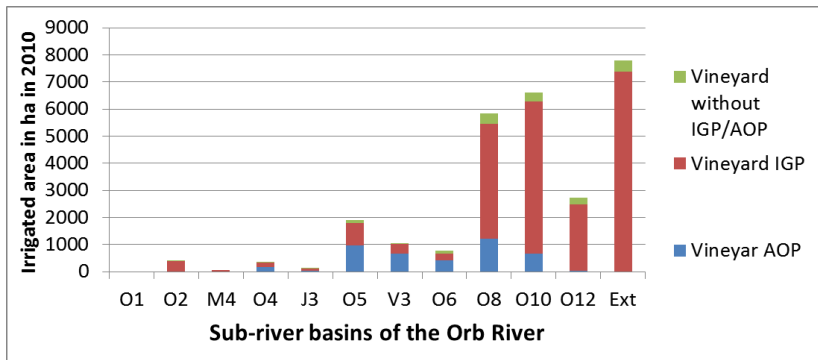

Figure D-2 Distribution of the vineyard areas in 2010 by Agricultural Demand Unit

Caution: At this stage the irrigated vineyards considered represent all the irrigated vineyards inside an agricultural zone. However, only a part of the irrigated vineyards in each of the agricultural zone defined are irrigated from the Orb water resources, as defined by the connectivity matrices for the agricultural demand on section 5.3.4. Other water resources are used, such as aquifers not connected to the Orb resources or surface water from other rivers (Hérault).

The scenario includes assumptions on the evolution of the cultivated area for each of these types of wine based on two main categories regarding the irrigation strategies:

- Toward a differentiated irrigation strategy corresponding to the current practices for the AOP, with a limited yield and limited irrigation;
- Or toward a cost/volume strategy associated with higher yield due to higher irrigation.

The following assumptions were applied to the vineyard of the Orb River basin in 2030 (Maton et al., 2013). The 2010 vineyard area is maintained but:

- 10 % of the 2010 AOP vineyards follow a differentiated irrigation strategy,
- 50% of the 2010 IGP vineyards follow a differentiated irrigation strategy,
- 50% of the 2010 IGP vineyards follow a cost/volume irrigation strategy,
- 50% of the 2010 without IG vineyards follow a cost/volume irrigation strategy up to 70% of the area,
- 50% of the 2010 without IG vineyards follow a cost/volume irrigation strategy, up to 100% of their area.

New irrigation networks of 600 ha and 2,000 ha are created and used corresponding to differential and cost/volume irrigation strategy respectively. The distribution of the future irrigated vineyard maintains the differences between the upstream and downstream part of the basin (Figure D-3). In the scenario adopted the cost/volume irrigation strategy is the dominant strategy 84 % and 16 % are irrigated following an AOP strategy.

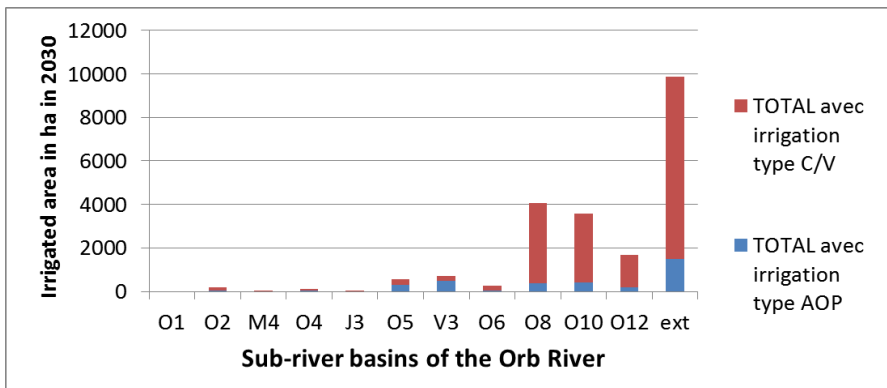

Figure D-3 Distribution of the future irrigated vineyard by Agricultural Demand Unit and type of irrigation strategy

➤ Other irrigated crops:

Market gardening: the 2010 cultivated areas are doubled in 2030 by assuming that demand for farm-to-table products will continue to increase, and thanks to a better organization of the production. Between 2000 and 2010 an increase of 1400 ha has been observed. A similar increase up to 2030 would lead to an additional 3,000 ha.

Large-scale agriculture: The irrigated area for cereals and protein crop production is assumed to increase by 20 % up to 2030, driven by an increase in the price of cereals (wheat) in the international market and a policy of protecting agricultural land to prevent urban sprawl.

Orchard: The irrigated area for fruit production is assumed to decrease by 50 % up to 2030, only the area irrigated for olives tree is maintained, representing 30% of the initial area.

Forage: the irrigated area for the production of grass and forage increases by 20%. The demand for forage is assumed to be maintained and changes in climatic conditions lead to an increase in the use of irrigation.

Applying this evolution scenario modifies the distribution of the irrigated area by type of crop (Figure D-4, vineyard is not represented). The market gardening irrigated area increases from one third to almost half of the total irrigated area, whereas the orchard decreases from 16 % to 6 % (and 4 % attributed to olive trees). The other irrigated crops continue to occupy a similar percentage of the total irrigated area.

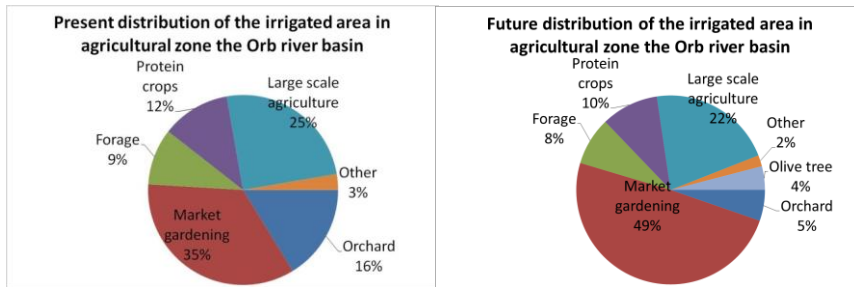

Figure D-4 Comparison between the present and future distribution of the irrigated areas between the Agricultural demand units in the Orb River basin (without considering vineyards).

c) Crop water needs

The increase in crop water needs is then estimated following the evolution of the crop and subsequently the evolution of the climate. This two-step method is presented in the following section. This estimation was realized by adapting the agronomic model developed in MatLab by Hoang, et al. (2012) for the Hérault district to the agricultural zones of the Orb River basin (Figure D-5). The present and future irrigated areas by type of crop were obtained by applying a prior assumption of the evolution scenario of the agriculture in the Orb River basin.

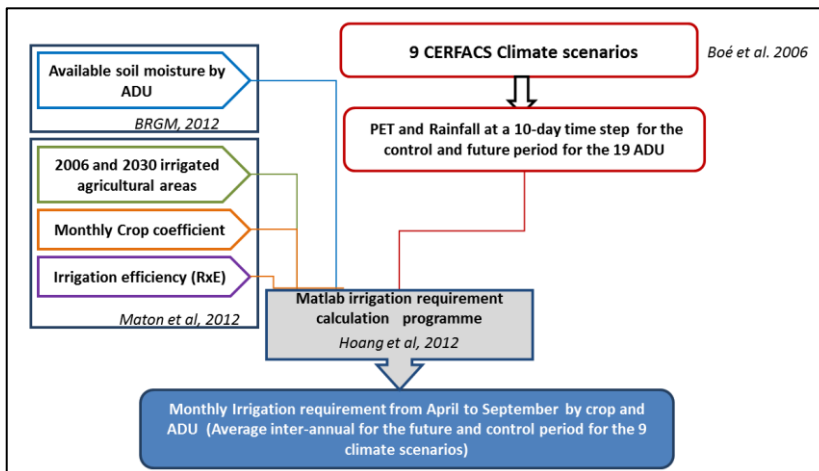

Figure D-5 Overview of the modelling framework of the agricultural demand model to estimate irrigation requirements on the 19 Agricultural Demand Units of the Orb River basin (Adapted from Hoang, et al., 2012)

The agronomic model is based on the crop coefficient method (Allen et al., 1998). It calculates the water required by the crop to compensate for EvapoTranspiration in addition to the rainfall, and also takes into account the water stored in the soil (available soil moisture). It can be summarized by the following equation:

$$\forall t \text{ CropIrrigationNeed}(t) \\ = Kc(t) \times PET(t) - Rainfall(t) - Available \text{ Soil Moisture}(t)$$

Where: Kc represents the cultural coefficient associated with a crop, it changes with the time of the year and the type of crop (Table D-2).

The climate data (PET and rainfall) are available at a daily time step from the SAFRAN database for the observed data and from the downscaling data for the 9 GCM for the future and control period, as described in the section of the manuscript on climate model (Section 5.1.1). The climate data were calculated on the SAFRAN grid resolution (8x8km) at the level of each agricultural zone on a weighted average proportional to the area of each cell on the zone. The weighting was made through the ArcGIS spatial analyst tool.

The model is run at a 10-day time step in order to update the available soil moisture data during the month. The data are then aggregated to calculate monthly crop irrigation needs for each agricultural zone. There are only 6 months of irrigation in the study area: from April to September. The available soil moisture is assumed to be at its maximum at the beginning of the irrigation period as a recharge occurs during the winter months. Average available soil moisture data has been calculated for each agricultural zone of the Orb River basin from a regional soil map using the ArcGIS Spatial analyst tool to calculate the weighted average of the soil unit present in each zone. The crop irrigation needs are then used to calculate the water need at the agricultural zone level given the crops present in each zone and for a given climate.

Kc Irrigated Crop coefficient	April	May	June	July	August	September
Wheat	0.8	1	0.3	0	0	0
Corn-grain and corn seeds	0.5	0.5	0.7	1	1	0.8
Other irrigated cereals	0	0	0.7	0.6	0.4	0
Soybean	0	0	0.5	0.8	0.8	0.5
Sunflower	0	0.4	0.5	0.8	0	0
Protein crop	0.3	0.3	0.6	0.85	0.4	0
Forage corn	0.5	0.5	0.7	1	1	0.8
Other forage crops	0.3	0.8	0.8	0.8	0.8	0.8
Temporary meadows	0.3	0.7	0.7	0.7	0.7	0.7
Potatoes	0	0.4	1	0.7	0	0.6
Vegetables, strawberries and melon	0.5	0.68	0.84	0.86	0.87	0.76
Vineyard irrigated AOP type	0	0	0.2	0.4	0	0
Vineyard irrigated C/V type	0.1	0.3	0.45	0.45	0.3	0
Orchard and smalls fruits	0.3	0.8	0.95	0.95	0.9	0.7
Olive tree	0.6	0.55	0.5	0.45	0.45	0.55
Other irrigated crops	0	0.9	0.9	0.9	0.9	0.9

Table D-2 Monthly crop coefficient by type of crop used in the agricultural demand model

d) Agricultural water demands

For the 19 agricultural zones and the selected climate, the model calculates the corresponding water need by multiplying the crop water need by the respective irrigated area for each crop by node. The climate is defined for each simulation.

$$\forall t, a \text{ AgriculturalWaterNeed}(a, t) = \sum_c \text{CropWaterNeed}(c, t, a) \times \text{IrrigatedArea}(c, t, a)$$

Where:

- c is the type of crop,
- t and a the time step and the agricultural zone respectively,
- Crop water need is defined in mm/ha,
- Irrigated area is defined in ha.

Irrigation efficiency:

To estimate the water abstraction, the agricultural water needs are corrected by the efficiency of the irrigation techniques on the field and the efficiency of the irrigation network. The outputs of the prior model were post processed in Excel to calculate the withdrawals. The following assumptions were made regarding the irrigation techniques and network.

- Regarding the current situation, these assumptions rely on the inventory of irrigation communities (ASA) realized in 2008. This inventory was completed by experts from the local river basin authority, and the data collected by the 2010 agricultural census with the repartition of irrigated areas by type of irrigation techniques.
- Regarding the future situation, two main assumptions were made: first, that all the new irrigated vineyard is using micro-irrigation techniques (mainly drip irrigation). Then, for the remaining crops, the proportion of the various irrigations techniques is maintained (gravity for the upstream part of the river basin, and aspersion and drip irrigation for the downstream part of the river basin). The modernization of irrigated areas is not considered to change as it one of the measures of the Programme of Measures assessed later on.

$$E_{total}(a) = E_{Network}(a) \times \overline{E_{Techniques}}(a)$$
$$= E_{Network}(a) \times \sum_i E_{Technique}(i) \times \% Irrigated\ area(i, a)$$

Where:

- E_{TOTAL} is the efficiency total associated with the agricultural zone a,
- $E_{Network}$ is the efficiency associated with the distribution network of the zone a,
- $E_{Techniques}$ is the efficiency associated with the irrigation techniques I,
- % irrigated area is the percentage of the irrigated area of the zone a irrigated by the technique i.

Appendices

Efficiency coefficients are estimated for the 19 agricultural zones depending on the crops (Table D-3), except the vineyards, where the irrigated technique is always assumed to be micro-aspersion. The irrigation techniques are assumed to have efficiency coefficient of 0.6, 0.75 and 0.9 for the gravity, aspersion and micro-aspersion techniques respectively.

Agricultural zone	Efficiency coefficient			Irrigated area by type of irrigation technique (% of irrigated area)			Comments
	Efficiency total	Efficiency of the Network (Enetwork)	Average Efficiency of the irrigation techniques	Gravity	Aspersion	Micro-aspersion	
a1	0.43	0.58	0.73	12%	88%	0%	Data from the Agricultural census provided by the Water Agency. Only the vineyard is assumed to be in microaspersion upstream of the river basin
a2	0.36	0.50	0.71	25%	75%	0%	
a3	0.36	0.50	0.72	19%	81%	0%	
a4	0.41	0.59	0.69	38%	61%	0%	
a5	0.35	0.50	0.70	32%	68%	0%	
a6	0.33	0.50	0.67	53%	47%	0%	
a7	0.40	0.55	0.73	14%	86%	0%	
a8							Only vineyard is attributed to this agrizone splitted with a11 and a19
a9	0.58	0.76	0.77	0%	90%	10%	Irrigation from the regional water company BRL (piped supplied) assumed to be only for aspersion and micro irrigation
a10	0.58	0.76	0.77	0%	90%	10%	
a11	0.58	0.76	0.77	0%	90%	10%	
a12	0.58	0.76	0.77	0%	90%	10%	
a13	0.58	0.76	0.77	0%	90%	10%	
a14	0.58	0.76	0.77	0%	90%	10%	
a15	0.58	0.76	0.77	0%	90%	10%	
a16	0.58	0.76	0.77	0%	90%	10%	
a17	0.58	0.76	0.77	0%	90%	10%	
a18	0.58	0.76	0.77	0%	90%	10%	
a19	0.58	0.76	0.77	0%	90%	10%	

Table D-3 irrigation efficiency coefficients defined by agricultural zone

Appendix E Urban demand

This appendix presents the way the urban demand was calculated for the urban demand units of the Orb River basin presented in section 5.2.3.

a) Estimation of the current urban demand

The model is based on the latest population census and the most recent statistical data concerning economic activities (employment, tourism, etc.) available from the national statistical institute (INSEEE). The most recent inventory on network efficiency was provided by the Orb River management association observatory of water services (SMVOL, 2011). The method consists in estimating the water demand for the different categories of urban water users, introduced previously as domestic, touristic, municipal, and business-industrial. This detailed approach gives the possibility to evaluate the potential for water savings by each user. The assumptions on the evolution of the demand can also be differentiated. One of the key elements of the method is the adjustment of the domestic demand ratio to the situation of each UDU regarding the price of water, the average income by household, the climate, and the opportunity to drill their own boreholes. The model was founded on the results of a previous statistical study at the municipal level of these characteristics within the European WAT project (Rinaudo, et al. 2012).

An average annual demand of 90 m³/yr is estimated for a flat or a house without garden, ranging from 68 to 121 m³/yr. The houses with garden correspond to an average annual demand of 138 m³/yr ranging from 100 to 204 m³/yr (Figure E-1). The assumptions take into account the price elasticity (-0.1 for multifamily units, and - 0.3 for single family units), the income elasticity (-0.4), the cost of drilling a private borehole, the number of dry days, and the number of days with a temperature higher than 28 °C.

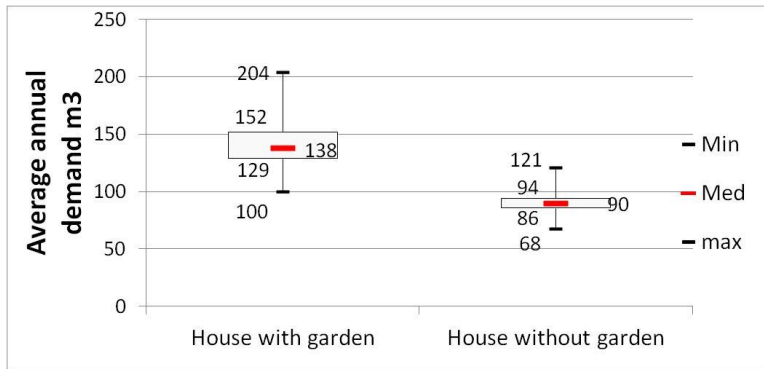

Figure E-1 Box-plot of the average annual water demand by type of household in the present situation

The model was validated by comparing the estimated water consumption (demand and losses) with the observed consumptions of a sample of 62 municipalities of the Orb River basin. The total consumption was estimated with a difference of less than 1% from reality. However, at the local level, differences were compensating each other and the sum of the differences in absolute value represents 18 % of the total volume. For 74 % of the municipalities, the estimation was between 80 and 120 % of the observed data. The major cities, such as Beziers and Narbonne, were corrected separately due to the importance of economic activities.

The demand estimation was carried out for two time periods: the peak demand, calculated from the 15th of May to the 15th of September, and the annual demand. The monthly demands were reconstituted from these data for the optimization model for each UDU.

b) Assumption of the future urban demand scenario

The estimation of the future urban demand for domestic water supply relies on the following main components: demographic growth, water prices, climate change and urban water savings.

➤ Demographic growth:

Between 1990 and 2007, the average demographic growth rate in the French region Languedoc-Roussillon, where the Orb River basin is located, was 1.13 %; the highest in France (0.52 % in average). The French National Institute of Statistics and Economic Studies (INSEE, model Omphale) projected that this growth rate will continue up to 2030, although the rate will become closer to that in other regions. The final demographic growth rate has been established at the “living area” scale (group of municipalities sharing resources, “basin de vie”) to harmonize local dynamics (1% in average).

➤ Water price:

The current trend in an increase of the price of water (volumetric part) is assumed to continue, accounting for the aging of the infrastructure and the need to finance its replacement, in addition to the strengthening of the environmental and health legislation on the supply of water. From 2004 to 2008, the price of water has increased by 3.3 % per year, whereas the consumer price index increased by 1.9 % per year. The price of water has, then, increased faster than inflation at a rate of 1.4%. By projecting this rate, the increase in water price in 2030 has been established at 30%. This increase is expected to act as an incentive to decrease household water consumption and is taken into account in the econometric model.

➤ Climate change impact:

The increase in maximal temperature (+ 1.5 to 2 °C in annual average) is expected to contribute to the increase in household water demand by increasing some outdoor water uses (swimming pool evaporation, garden irrigation) and indoor uses (showers). In the absence of further data about the magnitude of this increase on the study area, the 2003 summer heatwave consumption has been taken as a first proxy to estimate the impact of climate change on urban water demand. During this year, water consumption increased by 13 % in comparison to the 6 preceding years, with an increase in maximum temperature of more than 4 degrees (+ 20 % in summer). Therefore, an increase in the annual average water consumption of 6.5% and of 10 % in summer was assumed.

➤ Water savings:

Between 2004 and 2008, household water consumption in France decreased by 2 % per year and per habitant to reach 151 litres per capita per day. This decrease corresponds to a change in the tendency observed until 2004, when water demand increased by 1 % per year per habitant. Over the planning horizon, it is assumed that if this new trend continues, it could lead to a decrease of 14% in water consumption. The price increase could explain up to a fifth of this increase (given the econometric model developed), the rest being due to technological improvement of water devices and voluntary water savings. If the decrease in water consumption due to the decrease in the number of people per household (from 2.2 to 2 people per household between 2008 and 2030) is also deducted, the water savings due to technological change and voluntary water savings are estimated at 10%.

Other non-domestic water consumption increases were taken as proportional to the population. The efficiency of the water network distribution was assumed to remain constant through current maintenance of the water services, one of the measures of adaptation being to improve this efficiency.

Appendix F Adaptation measures

This appendix presents the way the adaptation measures were calculated in 5.2.4. The nature of adaptation measures considered in our study, as well as the main assumptions made to assess their cost and effectiveness, are presented in the table below. Readers interested in more details will find them in a French report (Vernier, et al., 2012).

Description of measure			
Code	Demand management measures	Unit cost	Effectiveness
	Conversion of gravity irrigation systems to pressurized / sprinkler irrigation.		
	The first measure is the investment in the modernization of gravity-irrigated systems located upstream in the river basin. The management of the irrigation channel is improved, and pumping stations are built along the channel to supply areas of 150 to 300 ha equipped with sprinklers. For the distribution system, the investment costs are assumed to be €6,500 per hectare, with a life span of 40 years. Maintenance costs are assumed to be 1 % per year and the energy cost, €30/ha.	€380/ha/yr on the field	Improve distribution network efficiency to 76 % and
MA1	Regarding the irrigation technique on the field, two types of sprinkler irrigation techniques are considered: the solid set sprinkler technique is associated with an investment cost of €1600/ha, a life span of 15 years and operation and maintenance cost of €310/ha. The “gun” sprinkler for irrigation is associated with an investment cost of €650/ha and an operation and maintenance cost of €260/ha for a life span of 20 years.	€423/ha/yr for the distribution network	field efficiency to 75 % on average

Development of drip irrigation at farm level in all pressurized irrigation systems		
MA2	<p>The second measure is the development of drip irrigation in the downstream part of the river basin, where pressurized piped distribution networks are already installed (therefore, a zero cost is associated with the distribution network). The investment cost is defined as €2,000/ha for a life span of 10 years, linked to operation and maintenance cost of €78/ha. The efficiency associated with the drip-feed irrigation remains at 0.9. The annualized cost of this measure is €325/ha.</p>	<p>€2,000/ ha</p> <p>Drip irrigation field efficiency 90 %</p>
MU1	<p>Leakage reduction in the water supply distribution network.</p> <p>This measure consists in conducting a diagnosis of the network to identify leakages and fixing them; intermediate meters are also installed to monitor leakages on a regular basis. The water saved is estimated as the difference between the volume of losses before and after the repair. The life span of this measure is estimated to be 15 years.</p>	<p>Cost and water saving were estimated in each municipality using a complex function of connection density, current leakage rate, rural/urban type (for details see Rinaudo, 2011)</p>
MU2	<p>Installation of water conservation devices (tap aerators, shower flow reducer, etc.) in households</p> <p>This measure relies on the pilot study realized in Portiragnes (a town located in the same district as the study area). Water saving kits are provided to households on a voluntary basis. A 25 % participation rate is assumed for households to collect their kits from the municipality (free of charge), of which only 75 % are finally installed. The kit includes water saving devices for showers, sinks and toilets, according to the type of house (single or multi-family unit). The cost includes the cost of the devices and the information campaign. An average life span of 6 years is assumed.</p>	<p>€21.8/ individual household</p> <p>€12.2/ flats</p> <p>Water savings of 13 % on flats and 9 % on individual houses</p>

Water consumption audits for single family houses & changes in appliances		
MU3	<p>A specialist is paid to audit individual houses with or without a garden. A diagnosis of leakages is carried out and water saving devices are installed. Low cost devices are installed by default and the specialist is assumed to be paid for 2 hours of work as a plumber (€40/hour). The household pays the costs up to the threshold of savings realized on the water and electricity bill, the public authority adding a subsidy to pay the remainder. Average cost of the audit: €40, cost of the water saving devices €24 (subsidized at 25 %, €6). The rate of uptake is assumed to be 50 %, thanks to the positive impact of the subsidy.</p>	<p>€46/ household in average for the public authority</p> <p>13 % water savings</p>
Same as MU2 for multi-family housing units		
MU4	<p>This measure is applied only in municipalities with more than a hundred multi-family housing units. Managers of this type of housing are always looking for ways to cut costs, therefore they are assumed to adopt this measure readily (75 %) and the subsidies can be less than in M3. The measure offers the support of a professional to locate and fix leakages and to install water saving devices. Installation of individual water meters is also promoted and subsidized.</p>	<p>€47/ household</p> <p>13 % water savings</p>
Installation of automated reading meters & use of seasonal water tariffs to reduce peak-season demand		
MU5	<p>The price of water is increased by 50 % during the peak period (from the 15th of May to the 15th of September). The price is decreased at other times of year in order to maintain an equivalent water bill for the permanent inhabitants. Only certain costs associated with the implementation of this measure are paid by the public authority, namely: remote reading water meters are installed and cost €5 per year per household more than classic meters. The meter must also be read automatically once during the first few days of the peak period (€3 per household).</p>	<p>€8 per water user</p> <p>Estimated using an econometric model, presented in Rinaudo, et al. 2012</p>

Appendices

Installation of water saving devices in hotels (tap aerators, toilet flushes)			
MU6	Hotels receive a 20% subsidy to install water saving devices in their rooms. A distinction is made between hotels with two stars or less, and luxury hotels of 3 stars or more, according to the quality of the water saving devices installed. The uptake rate is assumed to be high (75 %) due to the benefit generated by water savings. Life span is assumed to be 6 years.	€35 / room + €20 / hotel	20 to 35 % water saving given the type of hotel
Water consumption audits of campsites and holiday parks. Installation of low-flow flushes / showers, leakage detection in campsite distribution network, etc.			
MU7	On a voluntary basis, a campsite can apply for a free water audit to reduce their leakages. The cost of such an audit is fixed at €450, the campsite owner pays the cost of fixing the leakage. It is assumed that 50 % of campsites will volunteer, of which 60 % will reduce their leakages. The savings are estimated to be 25 % of the initial consumption.	€450 / audit + 25 % subsidies of works	25 % of initial consumption
Replacement of water intensive landscapes with xeric vegetation (public gardens)			
MU8	The choice of ornamental species in public parks is modified to introduce drought tolerant vegetation. Space dedicated to irrigated lawn is reduced and replaced with mineral cover or trees. Only the additional costs (compared to the classic design) are considered. The savings are 50 % over the first three years and 100 % afterwards. Only 10 % of the public parks will apply this measure.	€2.35 /m ² €1,000 to €4,000 for the training	0.85 m ³ per m ² converted
Replacement of irrigated lawns with artificial turf for sport grounds			
MU9	The existing football and rugby pitches are converted from turf to synthetic grass at a cost of €230,000 per field. Only 20 % of the investment cost is subsidies by the public authority and 75% of the fields are converted. The life span of the field is 10 years.	€230,000 /sport field	8,000 m ³ per sport field

Supply side adaptation measures

GW	<p>Substitution of water intakes in the Orb River (and alluvial aquifer) with other groundwater resources</p> <p>Five groundwater projects have been evaluated in terms of cost and sustainable yield. Pumping capacities from 100 to 400 m³ per hour have been considered. The costs include investment, operation and maintenance cost as well as network development specific to each project. Investment cost range from €0.35M to €1.6M (annualized cost).</p>	<p>Total annualized investment, operation and maintenance cost €0.5 to €0.8/m³</p>	<p>100 to 400 m³/hour</p>
DS	<p>Substitution of water intakes in the Orb River with desalinated water (coastal municipalities)</p> <p>Desalination is assumed to be an option for the urban demand units located along the coast. Small desalination plant are considered (10,000 m³/day). Costs associated with the use of desalinated water correspond to capital cost (€1.4M annualized per desalination plant and distribution network) and operation and maintenance cost (€0.7 /m³ for the plant and €0.15/m³ for the distribution network pumps).</p>	<p>Annualized investment cost €1.4M operational and maintenance cost €0.85 /m³</p>	<p>10,000 m³/day</p>

Table F-1 Detailed description of measures with their cost and effectiveness

The costs were annualized using the following formula:

$$\text{Annual Equivalent Cost} = \frac{\alpha \cdot I \cdot (1+\alpha)^d}{(1+\alpha)^d - 1}$$

Where:

- α is the discount rate, taken as 4%
- I is the investment cost,
- d the life span of the investment in years.

Comments on the agricultural measures not considered:

Neither the reallocation of area dedicated to vineyard nor the changes in grape variety were considered as adaptation options, and irrigation was considered as the main adaptation measure in this sector. We describe here some of the reasons for this choice related to the local context.

The change from one grape variety to another, more resistant to hot summers and requiring less water, or the possibility of changing the location of the area where the grapes are cultivated, are considered as adaptation options in other areas affected by climate change (Lereboullet, et al., 2013, (Zhu, et al., 2014, Resco, et al. 2015). However, a change in the variety of grapes or the place they are cultivated would also change the type of wine produced and the awarding of the quality label (“appellation”) based on the notion of “terroir”, crucial for the business model of winemakers in the French context. Wine growers in the South of France are quite reluctant to adopt this type of measure (Battaglini, et al., 2009). In this local context, new varieties of grape, such as Syrah, were introduced in the 1970s to improve the quality of the wine, and are required to obtain the appellation, thus improving the economic return of the wine producer. However, these varieties are also more sensitive to a warmer climate, then creating a conflict between the adaptation to evolving economic conditions of wine production and the adaptation to climate change in this area. One alternative measure would be to allow the appellation rules to evolve as climate changes, but this has not yet been considered (Lereboullet, et al., 2014).

Appendix G Environmental Flow

The main assumption realized by the method used to define environmental flow is that the water resources of the Orb River basin are mainly solicited during the summer months (Vier and Aigoui, 2011). The rest of the year, the impact of the water abstractions on the Orb basin is assumed to be negligible. Therefore, only the summer months of August and July were considered for the definition of minimum environmental flow requirements. Given the diversity of the river reaches of the Orb River, no single method was applied to the whole basin. In the upstream and middle part of the basin, down to the Taurou tributary, a combination of hydraulic and a habitat method was followed. Downstream, the water quality is the limiting factor as the river reaches are regulated by weirs and the minimum flow was defined based on water quality criteria.

A flow guideline was established following these methods. In order to represent the progressivity of the relation between the flow and the habitat, three flow thresholds were defined for the management of water resources (low, intermediary and high, Figure G-1).

- ✓ The higher threshold corresponds to the limit between a flow regime ensuring all the functions of the aquatic environment and a flow regime corresponding to a globally acceptable state of the environment.
- ✓ The intermediary threshold defines the limit to a disturbed state of the environment, with perturbations that must appear only temporarily. The definition of this threshold take into account the possibility of “refuges” in the area investigated.
- ✓ The lower threshold is the tipping point to a critical state; below this threshold, high modifications with irreversible effects for the environment are expected.

The method based on water quality parameters was applied in the river reaches to compare the minimum flow required to maintain the chemical quality, over the previous one required to maintain the biological quality. The results are that all the river reaches upstream Béziers (main city of the basin) have a higher biological

flow than chemical flow, therefore ensuring the biological quality ensures good chemical quality. Downstream from Beziers, the chemical quality is the limiting factor, therefore the flow requirements are defined to ensure good water quality and also ensure good biological quality.

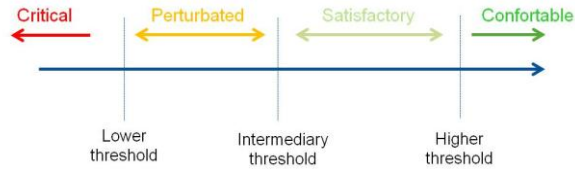

Figure G-1 Environmental flow thresholds

The results are presented on the Table G-1 for the 11 nodes of the basin.

Node	Natural QMNA5 (Mm ³ /month)	Influenced QMNA5 (Mm ³ /month)	High Flow requirement (Mm ³ /month)	Intermediary Flow requirement (Mm ³ /month)	LowFlow requirement (Mm ³ /month)
O1	1.81	4.41	1.74	1.37	0.65
O3	2.85	6.22	2.20	1.79	0.96
M4	1.09	0.52	1.09	0.93	0.60
O4	4.92	8.55	4.41	3.37	2.38
J3	1.40	0.65	1.04	0.91	0.62
O5	7.26	11.15	5.96	4.67	3.37
V3	0.70	0.23	0.65	0.54	0.36
O6	8.29	11.66	6.74	5.18	3.89
O8*	8.55	7.52	3.63	3.63	3.63
O10*	8.55	4.67	3.63	3.63	3.63
O12*	8.55	5.18	3.63	3.63	3.63

*Flow threshold defined for water quality issues

QMNA5: 5-years monthly low flow

Table G-1 In-stream environmental flow requirements at the 11 nodes of the Orb River basin

The comparison of the minimum environmental flow requirements with the QMNA5 highlights that some flow requirements are already covered by these low flows for the tributaries (M4, J3 and V3), whereas the effect of the water released from the Monts d'Orb reservoir ensures greater security for the nodes of the Orb River.

Appendix H Least-cost river basin optimization model

This appendix presents the way the least-cost river basin optimization model was elaborated to integrate the different components of the Orb water resources systems.

a) Infrastructure management

The main infrastructure influencing the Orb River basin, the Monts d'Orb reservoir and the Montahut hydropower plant are integrated in the model.

The Monts d'Orb Reservoir

The Monts d'Orb reservoir is managed as a multipurpose reservoir. However, legally it first aimed at compensating the water withdrawals from the transfer to supply agricultural and urban water demand during the summer months. In addition to this initial function, the reservoir is also used for flood protection and hydropower production. These three functions are described below, based on the latest study discussing the functions of the reservoir (Chazot, 2011).

➤ Compensation function

The reservoir has been working since 1962. It is the cornerstone of a more complex system composed of four abstraction points from the pumping stations of Réals, Cessenon sur Orb, Gaujac and a gravity abstraction at Pont Rouge in the Midi channel. The irrigable areas from these pumping stations represent more than 12,000 hectares in all, and the Puech de Labade and Cazouls les Beziers water treatment plants supply more 150,000 inhabitants in summer. This system is managed by the BRL Company, a regional public company.

➤ Flood protection

The protection against flood, even though it was not defined as an original function of the reservoir, has always been taken into account by the manager of the

reservoir by maintaining part of the reservoir empty at the end of the summer period. 10 Mm³ are preserved during September and October, after which the reservoir is filled up progressively. This corresponds to a flood event with a return period of 10,000 years.

➤ Electricity production

A turbine for electric production, with a capacity of 1300 kW, was added to the reservoir in 1975, producing 6.9 million kWh per year in average, which corresponds to the annual consumption of 1,200 households. The benefits generated by this production are relatively complex to estimate, as the price of electricity changes with the season (summer/winter) and with the time of the day (peak, full, empty hours), so they were not explicitly considered in the model developed.

➤ Characteristics of the reservoir

The Monts d'Orb reservoir is characterized by a normal maximum height of 430 masl associated with a volume of 30.6 Mm³ and an area of 180 ha.

The legal requirement for the Monts d'Orb reservoir are defined in various documents from the declaration of public interest in 1961 for its construction through various decrees taken by the "arrêté préfectoral" that define the water regulation ("reglement d'eau"). These requirements can be summarized as follows:

For the reservoir, the discharge flow from the reservoir must be at least equal to inflow, if this is less than 150 l/s, and must be greater than or equal to 150 l/s if the inflow is higher than 150 l/s.

For the abstractions, the remaining flow after the Réals pumping stations must be greater than or equal to 2m³/s, if the natural inflow is also greater than 2 m³/s, otherwise it must be equal to this natural inflow. In practice, this constraint is not really a limit for now, as the flow is always greater than 2m³/s.

The regulation of the rate of discharge is also defined but is not relevant for a model at the monthly time step. However, the regulation on the quality of the water

discharged by the reservoir limits the volume available to avoid the discharge of sediments. The consequence is that the minimum volume of the reservoir is limited to 6 Mm³ (Chazot, 2011). Since 2006, the rules of operation are those illustrated in Figure H-1, with a minimum of 6 Mm³ and a maximum preserving a sufficient volume in autumn and winter for flood protection.

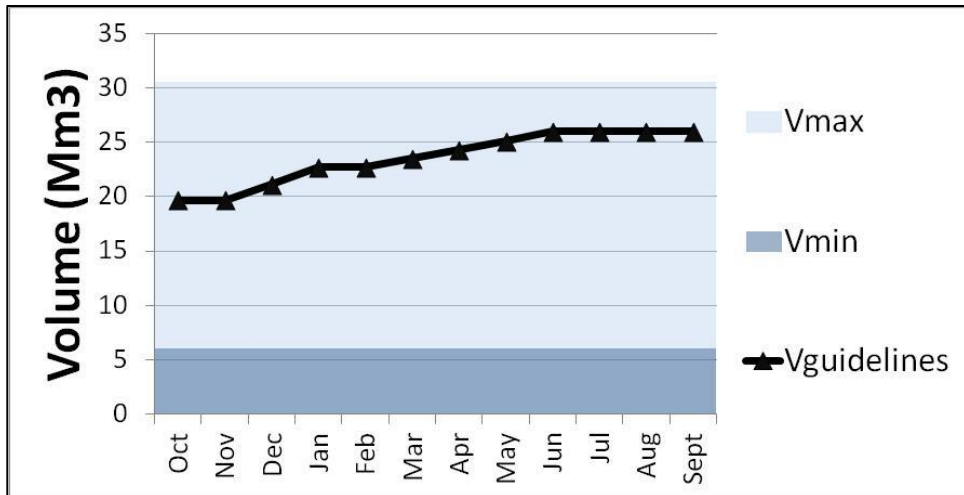

Figure H-1 Rules of operation of the Monts d'Orb reservoir since 2006

- Cost associated with the reservoir:

The company running the reservoir estimates the maintenance cost to be €409,000 annually and the total operation and maintenance and modernization cost to be €690,000 per year.

- Evaporation

Evaporation from the reservoir was calculated based on an estimation of average annual dam evaporation in the south of France (Vachala, 2008) of 1,100 mm per year. Then the monthly distribution was estimated through the distribution of monthly ETP from observed data obtained from the SAFRAN data base (Figure H-2). The impact of climate change was not taken into account in this distribution.

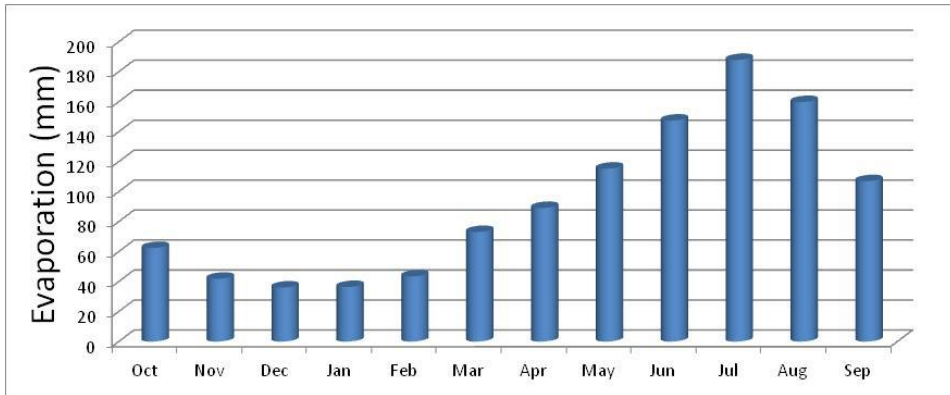

Figure H-2 Monthly evaporation rates on the Monts d'Orb reservoir

Once the monthly evaporation rate had been defined, it was applied to the monthly average surface of the reservoir deduced from the volume of the reservoir through a linear relation established on historical data (Figure H-3).

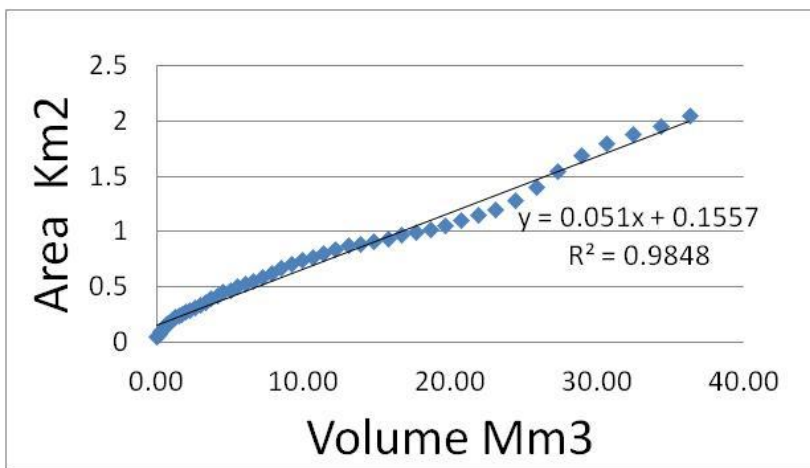

Figure H-3 Area-volume curve for the Monts d'Orb reservoir

The Montahut hydro-powerplant

The Montahut hydropower plant (120 MW, 623 m of High of water discharge) has a significant influence on the flow regime of the Orb River. It brings water from two Atlantic rivers stored in the Laouzas reservoir. Water is discharged after energy production in the Jaur tributaries, a few kilometres upstream of its junction with the Orb River. Judging from EDF (Electricity de France), who manages the plant, the

average annual discharge was 168 Mm³ from 1987 to 2003, which represents about 20% of the total influenced inflow of the Orb River (850 Mm³). However, this discharge is known to be smaller during the low flow season (6 Mm³ in June, 2.8 Mm³ in July and 2.3 Mm³ in August). August is the month with the lowest average discharge, since the plant is usually stopped during the first 15 days of this month. August and September are the two single months when zero discharge can occur. During dry years, the summer discharges are almost zero, in order to maintain minimum flow in the Atlantic rivers. Therefore, this reservoir cannot be considered as a complementary resource to ensure ecological flow in the Orb River during drought periods (Vier and Aigoui, 2012). The discharge from the Montahut power plant is unpredictable as the plant is used by EDF in the event of peak demand. For the requirements of the model, it was estimated that the flow coming from Montahut was 20 % of the observed monthly discharge in average from 1987 to 2003, as had been done for the previous study (Chazot, 2011).

b) Connectivity matrices

In order to optimize the Programme of Measures, the inflow and demand data need to be connected in a consistent framework. The hydrological nodes are connected through river reaches (links) and each urban or agricultural demand is connected to its respective river node. Each inflow is attributed to its respective sub-catchments. The main difficulty to establish the connection between the demand and the hydrological node is that in most of the case the link between the UDU, ADU and the water resource is not clearly established. The same UDU or ADU can rely on various water resources such as groundwater resources independent from the Orb River system or other superficial water resources. The connectivity matrices were established by reviewing the existing studies (Vier and Aigoui, 2011; Chazot, 2011), and were validated by local experts in the case of conflicting data.

➤ UDU-nodes matrix:

This matrix has been defined to connect each UDU to one or more hydrological node given the origin of the water used to supply its demand (Figure H-4). The main problem was found for the UDUs that rely only partially on the Orb water

resources for their water supply. For instance, the UDU of the Aude district outside of the river basin, are supplied by a water transfer from the regional water company BRL, but only relies on this resource to secure their water supply or to supply a part of their demand. They have been assigned connection coefficients ranging from 0.01 when the Orb resources are used only to secure supply to 0.3 or 0.8 for other UDU. These coefficients represent the fraction of the demand supplied by the Orb water resources. Various UDU, even if they are located in the Orb River basin, are using deep groundwater resources, such as deep karsts, to supply their demand; these UDU are considered as not connected to the Orb water resources. Of the 119 UDU demands first elected only 84 appear to withdraw or discharge water on the Orb River. Regarding the return, each UDU has been attributed a return node (Figure H-4). The assignment was also based on prior studies and local expertise. An average return coefficient of 0.7 has been applied to the urban demand to estimate the return, in accordance with the guideline of the river basin authority.

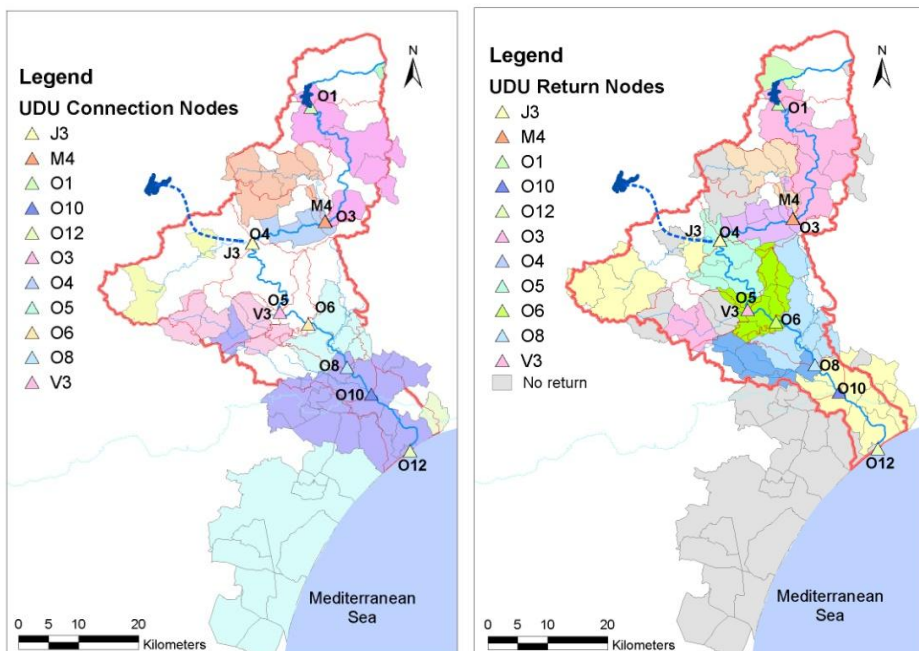

Figure H-4 Map of the connections between the UDU and the nodes of the model for the demand (left) and the return (right)

➤ ADU-nodes matrix

The ADU located upstream, a1 to a8, corresponds to the hydrological zones associated with the nodes n1 to n8 respectively. The demand and return of an ADU was assigned to its corresponding node. The return coefficient of the ADU was assumed to be high as most of the irrigation channel comes back to the river. The assumption is an 80% return flow, as defined in a prior study (Vier and Aigoui, 2011). For the agricultural zone located downstream in the river basin (a9 to a19), supplied by the regional company network for their irrigation, the ADU correspond to administrative districts (canton). Some of these districts are located outside of the river basin, as presented on a map (Figure H-5). The difficulty was in assigning the corresponding hydrological node to each ADU. As for the UDU, this attribution was realized based on expert judgment, as the complexity of the interconnected irrigation system does not allow a clear association of the resources to each ADU. The return from these ADU located downstream in the river basin was considered negligible since the irrigation method is mainly drip and aspersion irrigation and located outside the river basin.

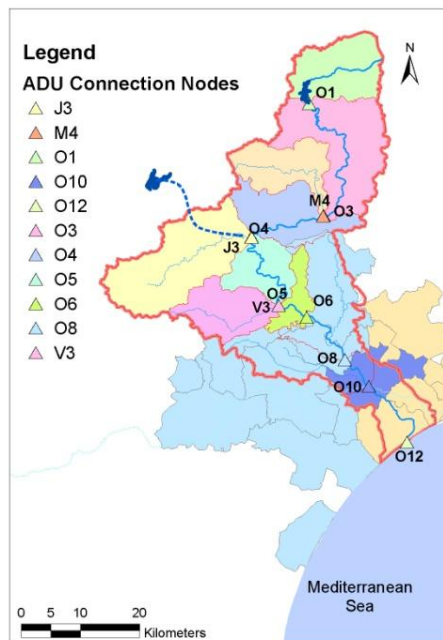

Figure H-5 Maps of the connection between the nodes and the ADU

➤ Inflow-nodes matrix

The sub-basins defined earlier in the hydrological model are used to estimate the inflows at the different nodes of the models. The discharge from the Montahut hydropower plant is assigned to node 6 directly after the confluence of the Jaur and Orb rivers, as in reality the flow released reaches the Jaur just before its connection with the Orb River. The last node corresponds to the last part of the river before reaching the Mediterranean Sea. Each node is mathematically connected to the river reach through one matrix connecting discharge from the node to the river stretch, and one connecting the discharge from the river stretch to the node inflow.

c) Optimization models: objective functions and constraint equations

We first present the model when it is used only to assess the deficit in agricultural demand without the possibility of implementing adaptation measures (water resources management optimization model), and then the full version of the least-cost river basin optimization model on this basis.

1.1. Water resources management optimization model:

Objective function:

(Eq. H. 1) $Minimize \Pi_D = \sum_t \sum_a Def_{a,t}^{T^*}$

Where, t is the time step index (monthly); “a” is the index of the ADU, and $Def_{a,t}^{T^*}$ is the deficit for ADU a at month t with a return period T* lower than T.

Subject to:

➤ Supply of demand:

(Eq. H. 2) $SU_{u,t} = DU_{u,t} \forall u, t$

$$(Eq. H. 3) \quad SA_{a,t} = DA_{a,t} - Def_{a,t}^T - Def_{a,t}^{T*} \forall a, t$$

Where SU and SA are the volume of water supplied at each time step to u and a respectively; DU and DA are the demand of the ADU “u” and ADA “a” at t respectively; $Def_{a,t}^T$ is the variable allowing a 5-year deficit; $Def_{a,t}^{T*}$ is the variable accounting for the extra deficit over that allowed in the 5-year deficit.

➤ Deficit frequency constraint:

$$(Eq. H. 4) \quad \text{If } Def_{a,t}^T \geq 0 \text{ then } DC_{yr} = 1 \text{ else } DC_{yr}=0$$

$$(Eq. H. 5) \quad \sum_{yr} DC_{yr} / N \leq 1/T$$

Where DC is the annual deficit indicator of the year yr; N is the total number of years, and T is the return period fixed by the legislation for an acceptable deficit.

➤ Supply and resources balance:

$$(Eq. H. 6) \quad V_{t,n} = V_{t-1,n} + I_{t,n} + D_{t,n} - SU_{t,n} - SA_{t,n} + R_{t,n} - E_{t,n} \forall t, n$$

Where n is the number of indices of the node; I is the monthly inflow at node n; D is the discharge from n; V is the volume of the reservoir; R is the volume released from the reservoir (only reservoir at n1 else V=0 and R=0, at t=0 we set V=V₀=19.7 Mm³).

➤ Environmental flow constraints:

$$(Eq. H. 7) \quad D_{t,n} \geq E_{t,n} \forall t, n$$

Where E is the level of the in-stream environmental flow requirements at n.

➤ Reservoir constraint:

$$(Eq. H. 8) \quad V_{max,t} \geq V_{t,n1} \geq V_{min} \forall t$$

Where V_{min} and V_{max} are the minimum and maximum volume of the reservoir at n1.

➤ Return:

$$(Eq. H. 9) \quad R_{n,t} = \sum_u SU_{u,t} \times MC_{RU_{u,n}} + \sum_a SA_{a,t} \times MC_{RA_{a,n}} \quad \forall t, n$$

Where MC_RU is the connectivity matrix connecting the return from a supply SU of an UDU u to a node n (respectively ADU).

➤ Evaporation from the reservoir

$$(Eq. H. 10) \quad A_{t,n} = a \times V_{t,n} + b \quad \forall t, n$$

$$(Eq. H. 11) \quad EV_{t,n} = \frac{A_{t,n} + A_{t-1,n}}{2} \times \frac{ER_{t,n}}{1000} \quad \forall t, n$$

Where a and b are two parameters defined by linear regression; A is a positive variable presenting the area of the reservoir (in km²) calculated from the Volume V of the reservoir; ER is the monthly Evaporation Rate defined in mm and therefore divided by 1,000 to calculate the evaporation in Mm³ directly.

d) Least-cost river basin optimization model

The prior equation are either maintained or modified as indicated below.

Objective function:

$$(Eq. H. 12) \quad \text{Minimize } \Pi = \Pi_C + M \times \Pi_D$$

Where: Π_D is defined in Eq B. 1; M is a very large positive number, higher than the sum of the cost of all the other measures;

$$(Eq. H. 13) \quad \Pi_C = \sum_m A_m \times C_m + \sum_t \sum_m V_{m,t} \times VC_{m,t} / N$$

Where, m is the index of the measures; A the activation binary variable; C the equivalent annual fixed cost of the measure; V the volume of water coming from the measures (only for groundwater and desalination projects); VC the variable cost of the measures proportional to the volume. (The equation below presents a detailed version of this equation)

$$(Eq. H. 14) \quad \Pi_C = \sum_{ma} AA_{ma} \times CA_{ma} + \sum_{mu} AU_{mu} \times CU_{mu} + \sum_{mgw} AGW_{gw} \times CGW_{gw} + \sum_{mds} ADS_{mds} \times CDS_{mds} + \sum_{mgw} t_{mgw} \times VGW_{gw,t} + \sum_{mds} t_{mds} \times VDS_{mds,t} + \sum_{mds} VCGW_{gw,t} + \sum_{mds} VCDS_{mds}$$

Where, mu, ma, mgw and mds are indices of the measures of urban or agricultural demand, groundwater or desalination project respectively; t is time step (monthly) index; AA, AU, AGW, ADS are binary activation variables of the measures mu, ma, mgw and mds; CU, CA, CGW, CDS are fixed equivalent annual cost (€) of mu, ma, gw, mds respectively; VGW and VDS are the volume of water in Mm³/month of the measure mgw and mds respectively; VCGW and VCDS are the variable costs of the measures gw and mds in €/Mm³/month divided by the total number of year N of the optimization.

Subject to:

- Demand and supply side measures

$$(Eq. H. 15) \quad SU_{t,u} = DU_{t,u} - \sum_{mu} AU_{mu} \times VU_{mu,t} \times CM_{U_MU_{mu,u}} - \sum_{mgw} VGW_{gw,t} \times CM_{GW_U_{mgw,u}} - \sum_{mds} VDS_{mds,t} \times CM_{DS_U_{mds,u}} \quad \forall t, u$$

$$(Eq. H. 16) \quad SA_{t,a} = DA_{t,a} - \sum_{ma} AA_{ma} \times VA_{ma,t} \times CM_{A_MA_{ma,a}} - Def_{a,t}^T - Def_{a,t}^{T*} \quad \forall t, a$$

Where SU and SA are the supply of u (a respectively) after the activation of the measures; VU and VA are water saving (Mm³/month) for mu or ma respectively; CM_U_MU is a Connectivity Matrix between the “mu” and the demand “u” (Respectively CM_A_MA); CM_GW_U: Connectivity Matrix between the measures “mgw” and the demand “u”, Respectively CM_DS_U.

- Desalination measures:

Capacity and activation constraint: limits the capacity of the desalination plant and the availability of water to connectable UDUs.

$$(Eq. H. 17) \quad \sum_u VDS_{m_{ds},t} \times CM_{DS_U_{m_{ds},u}} \leq ADS_{m_{ds}} \times CapDS_{m_{ds}} \quad \forall t, m_{ds}$$

Where CapDS is the maximum capacity of a desalination plant mds.

- Groundwater measures:

Capacity and activation constraint: limits the capacity of the groundwater project and the availability of water to connectable UDUs.

$$(Eq. H. 18) \quad \sum_{mgw} VGW_{mgw,t} \times CM_{MGW_GW} \leq AGW_{gw} \times CapGW_{gw} \quad \forall t, gw$$

Where CapGW is the maximum capacity of a groundwater project gw.

- Exclusivity constraint: ensures the mutual exclusivity of groundwater projects

$$(Eq. H. 19) \quad \sum_{gw} AGW_{gw} \times MC_{Excl_GW_GW} \leq 1$$

Where MC_Excl_GW_GW is a matrix ensuring the mutual exclusivity of groundwater projects.

Appendix I Comparison IBCEA vs. LCRBOM

In this appendix we present a summary of the comparison between Least-Cost River Basin Optimization (LCRBOM) and Index-based Cost-Effectiveness Analysis (IBCEA) approaches¹². First, the methods are compared from a general methodological perspective, and subsequently through their application in a real case study.

a) Comparison of the methods

The way programmes of measures are selected using Index-Based Cost-Effectiveness Analysis (IBCEA) and Least-Cost River Basin optimization Model (LCRBOM) can be summarized conceptually in the following way (Figure I-1). In the two approaches, the objective is to minimize the total cost (C_T) of the programme of measures selected among measures for each demand unit i , with cost C_i and effectiveness e_i . The methods differ mainly in terms of their time and spatial representation of the problem.

In the IBCEA, the total volume (V_T) to be made available by the implementation of the most cost-effective PoM, is calculated as the difference between the total demand D_T and the available resources R_T (Equation i). This mass balance is assessed for a single time period (e.g. average year, peak conditions) at the basin scale.

In the LCRBOM, given the same objective of minimizing C_T (Eq. ii), the constraints of the optimization problem are defined at a monthly time step and the spatial resolution is often aligned with the water body or sub-catchment scale. Thus, the mass balance constraint (Eq. iii) ensures that at each node (n) and for each time

¹² The comparison is in more details in Girard C., Rinaudo, J.-D., and Pulido-Velazquez M. 2015 Cost-Effectiveness Analysis vs. Least-Cost River Basin Optimization Model: comparison in the selection of water demand and supply management measures at river basin scale. *Water Resources Management*, 29, 4129-4155 <http://link.springer.com/article/10.1007/s11269-015-1049-0>

step (t) the flow going in ($I_{n,t}$) is equal to the flow going out ($O_{n,t}$) and the variation, if any, of the storage in the reservoir ($V_{n,t}$). The mass balance involves the necessary data (time series) and/or calculations to properly represent natural inflows, flow releases from surface reservoirs or other hydraulic infrastructures, and return flows from water supply or stream-aquifer interactions. Water outflow from each water body can include seepages to groundwater, evaporation losses or water withdrawals for consumptive uses. Additional constraints are added to ensure that management targets on environmental flows (Eq. iv) and water deliveries to demands (Eq. v) are met at the desired location and time step. Eq. iv states that the in-stream flow in the water bodies (n) must always (at each t) be higher than minimum environmental flow requirements ($E_{n,t}$). Eq. v fixed the objective for a satisfactory supply ($s_{i,t}$) of the demand ($D_{i,t}$) with the possibility of decreasing the demand by applying measures of effectiveness e_i . At this point, the constraint on water deliveries to the demand can be defined in terms of reliability of the supply, described as the frequency or probability of the system to supply the demand at a given time step. While the IBCEA is performed for a fixed larger time step at a lumped basin scale, the LCRBOM analyses a longer period at a monthly time step, disaggregated at the water body or sub-catchment scale.

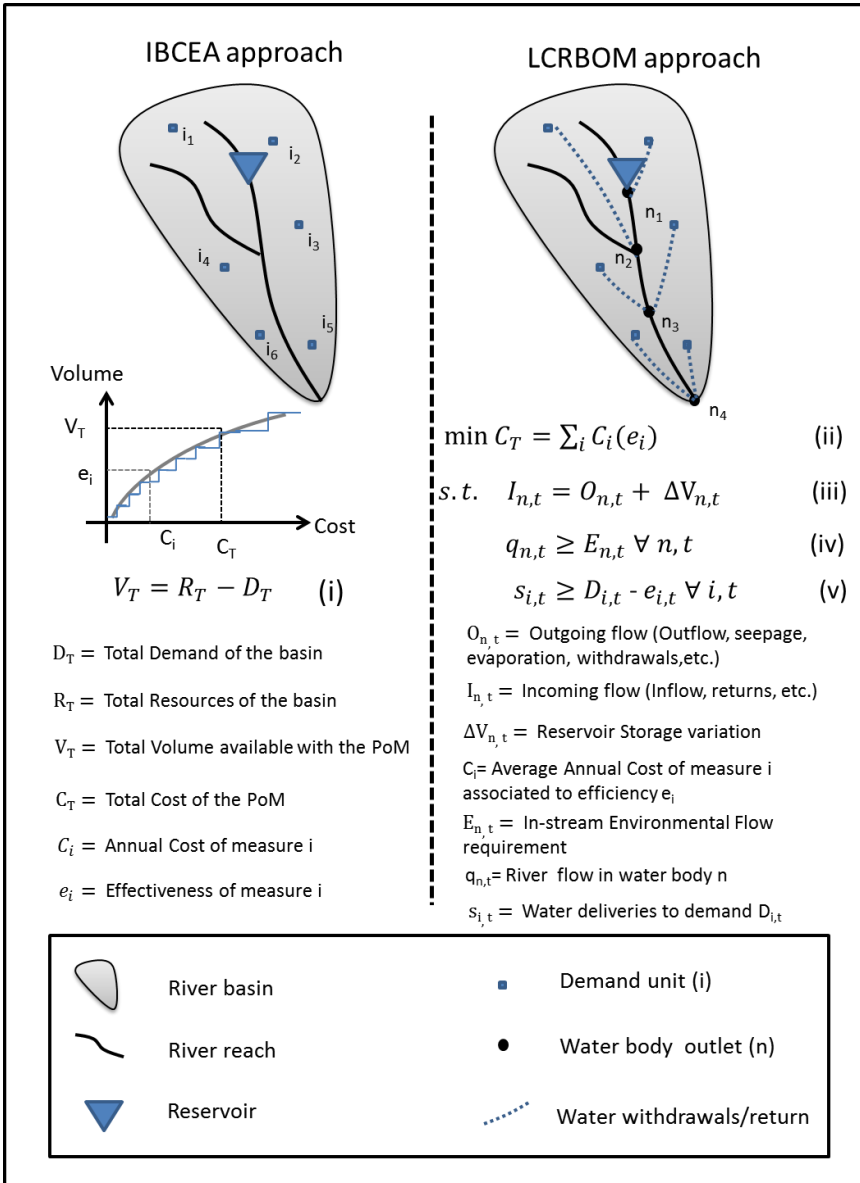

Figure I-1 Comparison of the Index-based Cost-Effectiveness Analysis (IBCEA) and the Least-Cost River Basin optimization Model (LCRBOM)

b) Method for comparing the results of the two approaches

We develop the following approach to compare both methods on the Orb River basin case study. Both the LCRBOM and the IBCEA are used with the purpose of selecting a programme of measures (PoM) at least-cost to achieve management objectives, defined in terms of performance to be achieved by the system under study. We adopt the following notations in this section: PoM' and PoM* respectively refer to the PoM selected by the IBCEA and the LCRBOM, the cost of these PoMs is noted as C' and C^* respectively, and the performance indicator of the system where each PoM is applied as I' and I^* . The performance indicator selected is an Agricultural Demand Reliability Index (ADRI) that corresponds to the minimum deficit that occurs with a return period lower than 5 years. If ADRI equals 0 then, the legal requirement is fulfilled; otherwise ADRI quantifies the percentage of agricultural demand that is not supplied.

We adopted the following step-by-step process for the comparison (Figure I-2):

- ❶ First, the LCRBOM is run to select the least-cost programme of measure (PoM*) associated with a total cost C^* (Step1).
- ❷ In order to compare the two methods on their performance only, we fixed the cost C' to be equal to the one previously defined, $C' = C^*$ (Step 2).
- ❸ The ranking of measures obtained through CEA is then used to select a PoM' with a cost of C^* (step 3).
- ❹ The performance indicators of the two PoMs (I^* and I') are assessed through a river basin optimization model that optimizes the management of the system (reservoir management) under the implementation of each PoM (step 4) for the same hydrological scenario.
- ❺ The performance of each PoM are compared to assess to which extend the objectives are met under each method at a same annual equivalent cost.

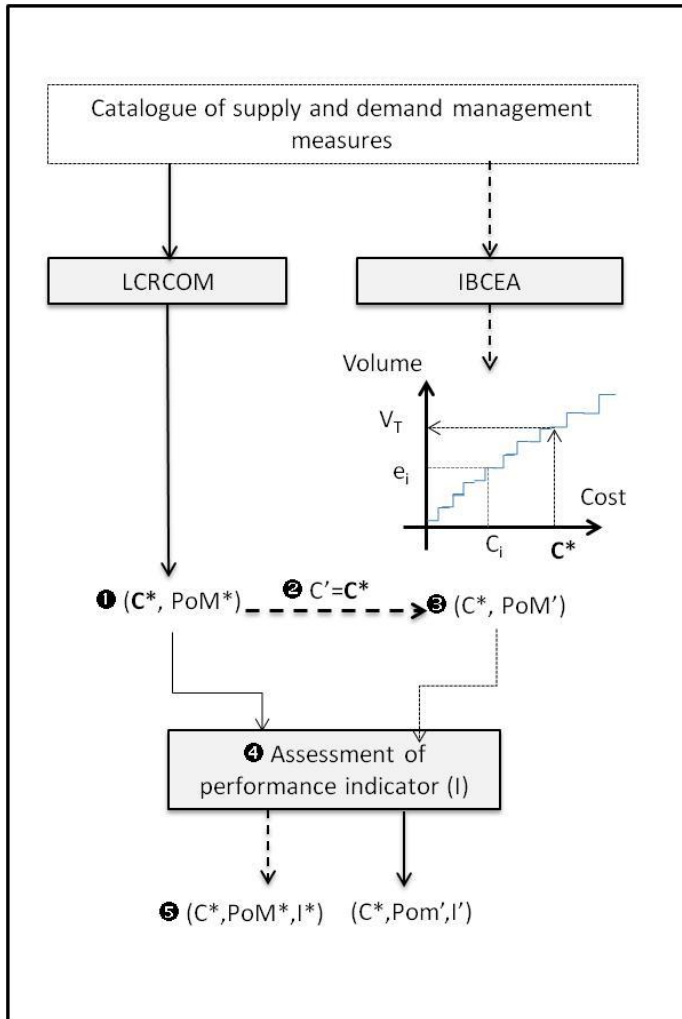

Figure I-2 Step-by-step processes to compare the performance of LCRBOM and IBCEA in the selection of a programme of measures at the river basin scale

c) Results of the comparison

The programme of measures is first selected with the LCRBOM under the future hydrological scenario corresponding to the global circulation models GFDL CM2 (NOAA, USA) for the emission scenario A1B. Then, measures are selected using the IBCEA curve (Section 6.1.1) until reaching the same cost.

The annual equivalent cost of the PoM identified using the LCRBOM is about €2.5M. Implementing the PoM selected through the LCRBOM enables the full supply of the urban and agricultural demand within the legal requirements and the environmental flow targets to be met. Both PoM contain all the agricultural measures to modernize irrigation (MA1 and MA2), and most of the network efficiency improvement measures also (MU1), (Figure I-3 and Table I-1). The PoM from the LCRBOM includes the individual household auditing measures (MU3) located in the upstream tributaries of the River Orb. This illustrates how the spatial distribution of the measures is taken into account in the selection of the measures by the LCRBOM and not in the IBCEA. In the LCRBOM, measures are selected locally to ensure objectives at the local water body level, whereas in a basic IBCEA, measures are selected at the river basin scale without accounting for the upstream-downstream interactions between sub-water bodies. The measures selected by the LCRBOM and applied in the upstream sub-basins to ensure the supply of the demand and environmental flow requirements also benefit downstream of the river basin, where fewer measures are required.

Method	IBCEA	LCRBOM
Agricultural measures	19	19
Urban measures	239	140
Ground water project	1	0
Desalination plant project	0	1
Total number of measures	259	160
Total cost	€2.5M	€2.5M

Table I-1 Comparison of the measures selected by LCRBOM and IBCEA for a same cost

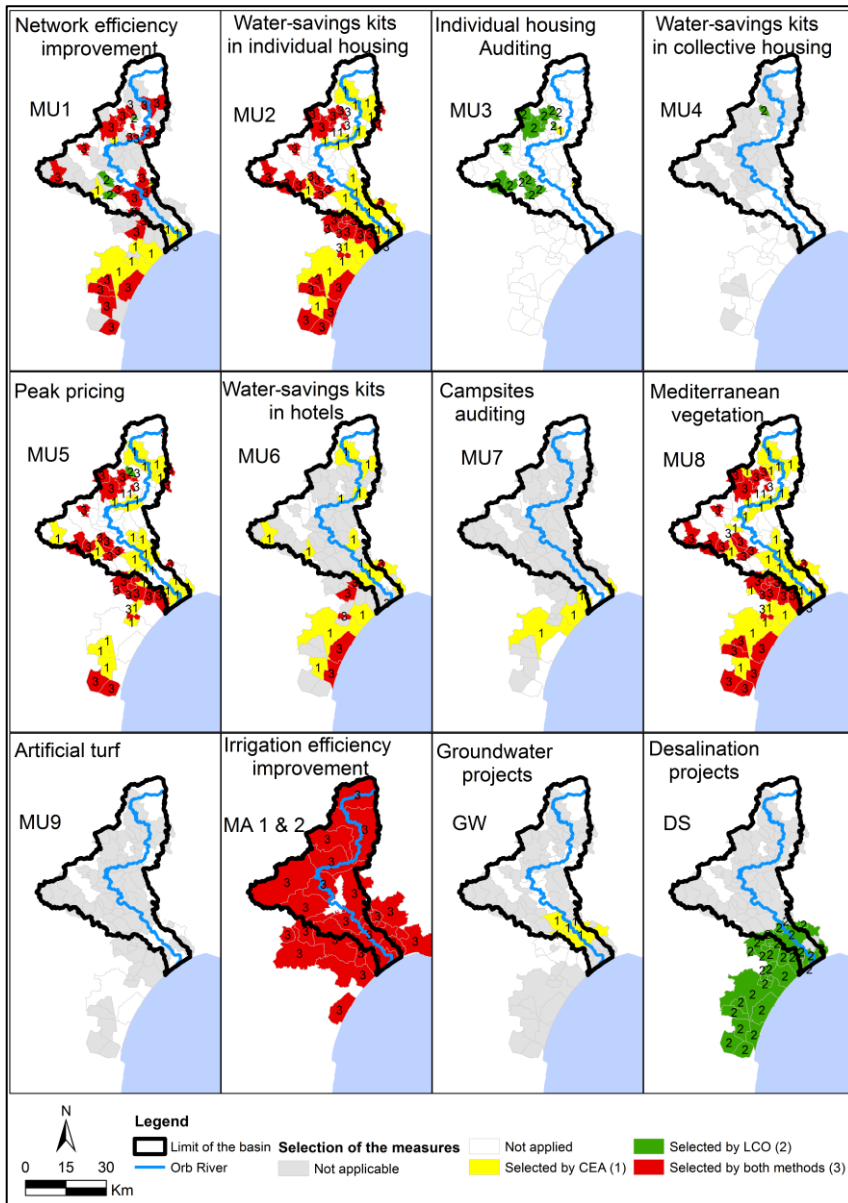

Figure I-3 Comparison of the measures selected by an Index-Based Cost-Effectiveness Analysis (CEA) and the Least-Cost River Basin Optimization Model (LCO) in the Orb River basin.

The performances of each PoM in terms of agricultural demand reliability index (ADRI) were calculated under the same future hydrological scenario corresponding to the global circulation models GFDL. In all cases, the sub-basins corresponding

to the River Orb tributaries, the Mare and the Jaur tributaries (M4 and J3), present a high level of deficit (Figure I-4), corresponding to a structural deficit already acknowledged in these basins (SMVO, 2013) that do not benefit from the reservoir regulation. In the other basins, whereas the LCRBOM PoM enables a deficit to be avoided, implementing the IBCEA PoM results in a deficit in the sub-basins O8 (ADRI=1.2%) and O12 (ADRI=23%). The IBCEA PoM improves the situation, but still fails to meet the objective of supplying agricultural demand without deficit in 4 years out 5 in the downstream part of the basin, as required by the existing regulation. In this sense, the use of the CEA could be misleading, as it does not ensure the most cost-effective solution.

Developing a LCRBOM allows the assessment of the effectiveness of the measures in terms of impacts within the interconnected water bodies in a basin, and not only in terms of pressure reduction, as would be the case in a cost-effectiveness analysis. Unlike the IBCEA, the LCRBOM allows the representation of processes such as return flows, upstream/downstream interactions, or inter- and intra-annual storage capacity of reservoirs, therefore ensuring a more cost-effective selection of measures. The management objectives, such as environmental targets or supply of demand, can be set up at the appropriate spatial and temporal scale. Accordingly, it provides more accurate information about the cost and effectiveness of measures to the decision makers concerned with implementing a programme of measures at the basin scale. However, in practice, different conditions are required for the successful implementation of this kind of approach, regarding the state of knowledge of the system, the data available, the time and capacity to develop the model, use it, and communicate its results. For instance, decision makers need to understand the method for it to be relevant to support a decision. Whereas an index-based ranking of measures is something relatively easy to communicate and explain, the processes of modelling and optimizing require additional efforts for it to be shared and accepted.

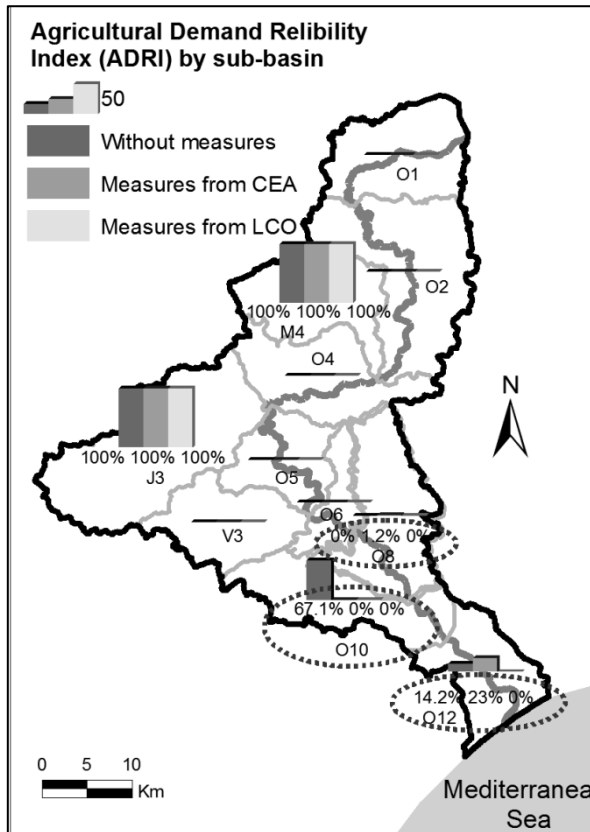

Figure I-4 Comparison of the performances (Agricultural Demand Reliability Index) of the Orb water resources system under three different programmes of measures((1) without measures, (2) applying measures identified using the Index-Based Cost-Effectiveness Analysis and (3) using the Least-Cost River Basin Optimization Model.

Appendix J Cost allocation scenarios

a) List of key informants interviewed on social justice principles

Key informant ¹³	Organization	Organization type	Description and relation with the Orb basin	Coalition
L. Rippert	Orb River water basin management association (SMVOL)	Local watershed council	Management of the Orb River basin	River basin perspective
V. Dubois	Astien aquifer management association (SMETA)	Local watershed council	Management of Astien aquifer (neighbouring the Orb basin)	River basin perspective
P. Barbet	Bezier urban area Water supply utility (CABEM)	Users representative	Water supply of the main urban area in the Orb River basin	3
S. Nogues	Chamber of agriculture of the Hérault district (CA34)	Users representative	Representative of farmers in the area	3
JP Pellagati	Chamber of agriculture of the Hérault district (CA34)	Users representative	Representative of farmers in the area	3
L.Triadou	Aude river basin water management association (SMARR)	Local watershed council	Management of the Aude river basin (benefitting from transfer)	2
R.Obon	Vernazobre water utility (SAEP Vernazobre)	Users representative	Water supply utility of a Orb tributary (upstream)	1

¹³ Interviews have been made individually with key informants. Their points of view do not represent their organization rather we consider that we tried to capture their understanding of the cost allocation problem and the different rationales at stake, but we do not claim any official representativeness

Appendices

F. Guiter	Jaur Water utility (SAEP Jaur)	Users representative	Water supply utility of a Orb tributary (upstream)	1
T. Gisbert	5 valleys water utility (SIVOM 5 Vallées)	Users representative	Water supply utility (upstream area)	1
E. Belluaud	Regional water management company (BRL)	Users representative	Management of the reservoir and supply of farmers and urban users through regional network	2
R. Duflos	Mare water utility (SAEP Vallée de la Mare)	Users representative	Water supply utility of a Orb tributary (upstream)	1
D. Mouret	District authority (CG Aude)	Local government	Representative of the territory benefitting from the transfer outside the river basin	2
J.-J. Meynard	Water district river basin authority (AERMC)	Government agency	In charge of defining charges and allocating subsidies	River basin perspective
F. Lumière	Narbonne water utility (Grand Narbonne)	Users representative	Water supply of the main urban supplied by a transfer from the Orb River basin	2
B. Laura	Narbonne water utility (Grand Narbonne)	Users representative	Water supply of the main urban supplied by a transfer from the Orb River basin	2

b) Stability analysis of the cost allocations

Once cost allocations had been defined following either cooperative game theory axioms or social justice principles, we could compare each allocation by assessing their stability (Shapley and Shubik, 1954), which should reflect their acceptability among the different stakeholders.

One way to quantify the stability of a cost allocation is to estimate the power index of each of the members of the grand coalition. The power index (α_i) of a member i of the grand coalition estimates that the power of i depends on: the additional cost he would have to pay if he left the coalition, and the additional cost other members would have to pay if he left the coalition.

$$\alpha_i = \frac{x_i - x'_i}{\sum_{j \in N} x_j - x'_j} \quad i \in N \text{ (Eq. J.1)}$$

With: x being what member i has to pay in the grand coalition, and x' what he would have to pay if he left the grand coalition (stand-alone).

Following this definition, a high power index value reflects less power or a higher willingness to cooperate in the grand coalition, as leaving the coalition for a member would represent a higher cost for him than for the others.

The stability index (S_α) of a cost allocation is then defined as the coefficient of variation of the power indices of the members taking part in the allocation, quantifying the distribution of powers between the members of the grand coalition. A lower stability index indicates a more stable cost allocation, as power would be more equally distributed between stakeholders.

$$S_\alpha = \frac{\sigma_\alpha}{\alpha} \text{ (Eq. J.2)}$$

The power indices calculated for the different cost allocations (Figure J-1) also reflect the differences between the allocation scenarios. Whereas the allocations based on cooperative game theory (Shapley and Nucleolus) maintain relatively close power indices for each member of the coalition, the other allocations present large differences, with some negative indices for user B, indicating a high

possibility of rejection or no reason to cooperate from an economic point of view. In economic terms, Player C seems to be the user with less power and most willing to cooperate as he is the main beneficiary of the grand coalition and the one with most to lose if this coalition does not form.

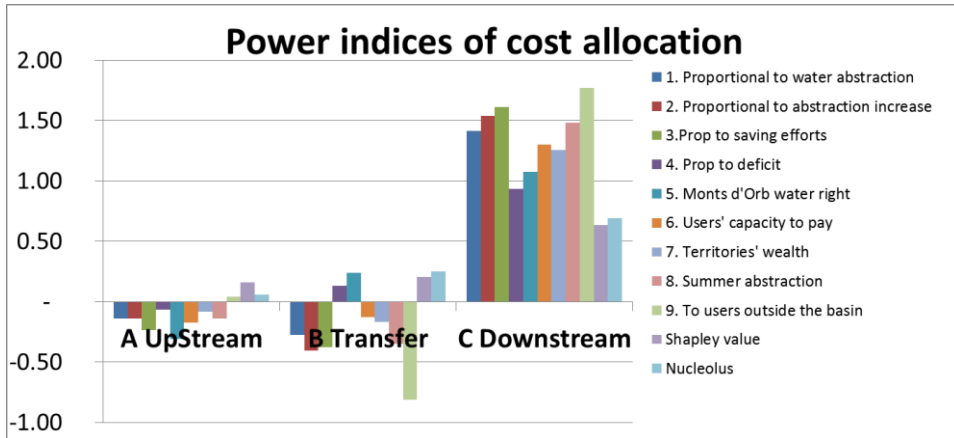

Figure J-1 Power indices of the three members of the grand coalition under different cost allocation schemes

Similar conclusions can be drawn when considering the stability index of each cost allocation scheme (Figure J-2). The Shapley value and the Nucleolus are the most stable from an economic perspective. The least stable allocations are those allocating all the costs to the users outside the river basin (S9).

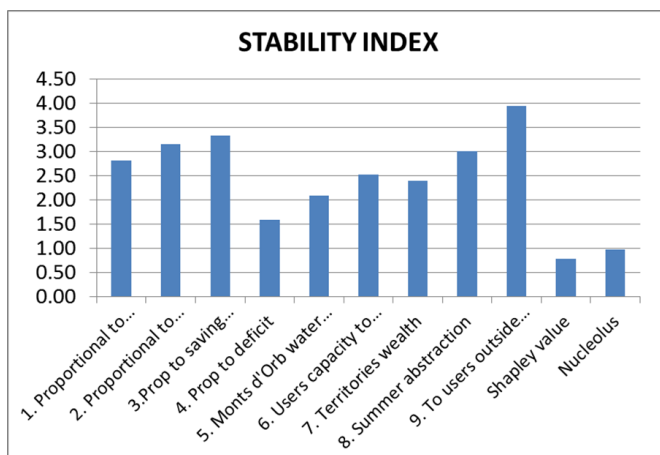

Figure J-2 Stability indices for the different cost allocation schemes

Appendix K Publication license agreements

ELSEVIER LICENSE TERMS AND CONDITIONS

Jul 31, 2015

This is a License Agreement between Corentin Girard ("You") and Elsevier ("Elsevier") provided by Copyright Clearance Center ("CCC"). The license consists of your order details, the terms and conditions provided by Elsevier, and the payment terms and conditions.

All payments must be made in full to CCC. For payment instructions, please see information listed at the bottom of this form.

Supplier	Elsevier Limited The Boulevard, Langford Lane Kidlington, Oxford, OX5 1GB, UK
Registered Company Number	1982084
Customer name	Corentin Girard
Customer address	Universitat Politecnica de Valencia Valencia, Valencia 46022
License number	3679391029570
License date	Jul 31, 2015
Licensed content publisher	Elsevier
Licensed content publication	Environmental Modelling & Software
Licensed content title	An interdisciplinary modelling framework for selecting adaptation measures at the river basin scale in a global change scenario
Licensed content author	Corentin Girard, Jean-Daniel Rinaudo, Manuel Pulido-Velazquez, Yvan Caballero
Licensed content date	July 2015
Licensed content volume number	69
Licensed content issue number	n/a
Number of pages	13
Start Page	42
End Page	54
Type of Use	reuse in a thesis/dissertation
Intended publisher of new work	other
Portion	full article
Format	both print and electronic
Are you the author of this Elsevier article?	Yes
Will you be translating?	No
Title of your thesis/dissertation	Integrating top-down and bottom-up approaches to design a cost-effective and equitable programme of measures for adaptation of a river basin to global change.
Expected completion date	Dec 2015
Estimated size (number of pages)	300
Elsevier VAT number	GB 494 6272 12
Permissions price	0.00 EUR
VAT/Local Sales Tax	0.00 EUR / 0.00 GBP
Total	0.00 EUR

**SPRINGER LICENSE
TERMS AND CONDITIONS**

Jul 17, 2015

This is a License Agreement between Corentin Girard ("You") and Springer ("Springer") provided by Copyright Clearance Center ("CCC"). The license consists of your order details, the terms and conditions provided by Springer, and the payment terms and conditions.

All payments must be made in full to CCC. For payment instructions, please see information listed at the bottom of this form.

License Number	3671440721118
License date	Jul 17, 2015
Licensed content publisher	Springer
Licensed content publication	Water Resources Management
Licensed content title	Index-Based Cost-Effectiveness Analysis vs. Least-Cost River Basin Optimization Model: Comparison in the Selection of a Programme of Measures at the River Basin Scale
Licensed content author	Corentin Girard
Licensed content date	Jan 1, 2015
Type of Use	Thesis/Dissertation
Portion	Full text
Number of copies	1
Author of this Springer article	Yes and you are a contributor of the new work
Order reference number	None
Title of your thesis / dissertation	Integrating top-down and bottom-up approaches to design a cost-effective and equitable programme of measures for adaptation of a river basin to global change.
Expected completion date	Dec 2015
Estimated size(pages)	300
Total	0.00 EUR

**ELSEVIER LICENSE
TERMS AND CONDITIONS**

Jul 29, 2015

This is a License Agreement between Corentin Girard ("You") and Elsevier ("Elsevier") provided by Copyright Clearance Center ("CCC"). The license consists of your order details, the terms and conditions provided by Elsevier, and the payment terms and conditions.

All payments must be made in full to CCC. For payment instructions, please see information listed at the bottom of this form.

Supplier	Elsevier Limited The Boulevard, Langford Lane Kidlington, Oxford, OX5 1GB, UK
Registered Company Number	1982084
Customer name	Corentin Girard
Customer address	Universitat Politècnica de Valencia Valencia, Valencia 46022
License number	3678090003744
License date	Jul 29, 2015
Licensed content publisher	Elsevier
Licensed content publication	Global Environmental Change
Licensed content title	Integrating top-down and bottom-up approaches to design global change adaptation at the river basin scale
Licensed content author	Corentin Girard, Manuel Pulido-Velazquez, Jean-Daniel Rinaudo, Christian Pagé, Yvan Caballero
Licensed content date	September 2015
Licensed content volume number	34
Licensed content issue number	n/a
Number of pages	15
Start Page	132
End Page	146
Type of Use	reuse in a thesis/dissertation
Intended publisher of new work	other
Portion	full article
Format	both print and electronic
Are you the author of this Elsevier article?	Yes
Will you be translating?	No
Title of your thesis/dissertation	Integrating top-down and bottom-up approaches to design a cost-effective and equitable programme of measures for adaptation of a river basin to global change.
Expected completion date	Dec 2015
Estimated size (number of pages)	300
Elsevier VAT number	GB 494 6272 12
Permissions price	0.00 EUR
VAT/Local Sales Tax	0.00 EUR / 0.00 GBP
Total	0.00 EUR

Appendix L Chapitres traduits en français¹⁴

Chapitre 1 Introduction générale

1.1 Adaptation au changement global à l'échelle du bassin versant

Durant la dernière décennie, les agences de bassin et les acteurs de l'eau ont été confrontés à des conditions environnementales, économiques et sociales changeantes. Les conditions climatiques évoluent dans de nombreuses régions du monde provoquant un risque accentué de rareté de l'eau et de sécheresse (Arnell, 2004). Le bassin méditerranéen a été identifié comme un point chaud du changement climatique à l'échelle planétaire (Giorgi and Lionello, 2008; Mariotti et al., 2008), un impact significatif étant projeté sur ses ressources en eau (Iglesias et al., 2007; Bates et al., 2008) et les écosystèmes qui y sont associés (Bangash et al., 2013). Par ailleurs, le changement climatique n'est que l'un des nombreux facteurs à même d'augmenter la pression sur les hydro-systèmes dans un contexte de changement global (augmentation de la population, développement agricole et industriel, changement dans les habitudes de consommation, protection de l'environnement, etc). Dans certain cas, l'impact de ces autres changements peut substantiellement dépasser celui du seul changement climatique sur les ressources en eau (Vorosmarty et al., 2000; Tanaka et al., 2006). Le changement climatique et l'augmentation de la demande alimentaire mondiale mènent à une augmentation ou intensification de l'agriculture irriguée. La demande urbaine augmente aussi sous l'effet de la concentration de la population dans des zones urbaines et de l'émergence de nouveaux modes de consommation (Hunt and Watkiss, 2011), en particulier dans le bassin méditerranéen (Thivet and Fernandez, 2012). Ces tendances ont pour résultat une augmentation de la pression sur les ressources en eau superficielles et souterraines ainsi que sur les écosystèmes qui en dépendent.

¹⁴ As the dissertation is written in English, the French regulation requires providing a translated version into French of the different sections presented in this appendix

En parallèle, la société a des attentes croissantes en termes de protection de l'environnement. Cela se matérialise dans de nombreux cadres législatifs, comme la Directive Cadre sur l'Eau (DCE) de l'Union Européenne, qui fixe l'objectif d'atteindre le bon état des masses d'eau européennes (EU, 2000) et, le plan d'action (Blueprint) de la Commission Européenne pour la sauvegarde des ressources en eau de l'Europe (EC, 2012), qui identifie les directions à suivre pour atteindre l'objectif du bon état, et qui souligne l'intérêt des mesures d'amélioration de la gestion de l'eau entre autres.

Les recommandations pour la mise en œuvre de la DCE dans un contexte de changement climatique suggèrent que les nouveaux schémas directeurs d'aménagement et de gestion de l'eau, et les programmes de mesures qui y sont associés, doivent être testés pour différents climats dans le but d'assurer la robustesse et l'efficacité à long terme des mesures d'adaptation (EC, 2009). Des stratégies d'adaptation sont requises, ce qui soulève des défis politiques et scientifiques (Smith, 1997; Hallegatte, 2009; Biesbroek, et al., 2010; Haasnoot et al., 2013), et génèrent un nombre croissant d'initiatives de recherche et de recommandations politiques dans le secteur de l'eau en particulier (Ludwig et al., 2011; Quevauviller, 2014, EC, 2013).

Deux approches principales sont couramment employées dans la définition de plan d'adaptation au changement climatique. La première commence au niveau global par la définition de scénario d'émission de gaz à effet de serre, pour ensuite parvenir à estimer les impacts du changement climatique à l'échelle locale et permettre la sélection de mesures d'adaptation. Cette approche est ainsi nommée descendante (« Top-down »), (IPCC-TGICA, 2007). Une approche alternative commence par évaluer les différentes composantes de la vulnérabilité sociale au niveau local avant de développer une stratégie d'adaptation. Cette approche est connue comme ascendante (« Bottom-up »). Ces deux approches ont été résumées de manière caricaturale par Dessai et Hulme (2004) de la façon suivante : l'approche ascendante considère l'adaptation avec des humains et ignore largement l'exposition physique, tandis que l'approche descendante ignore les humains et considère avant tout l'exposition physique au changement climatique. Ces approches diffèrent en effet dans la définition de la vulnérabilité au

changement climatique (physique ou sociale), ainsi que dans leurs échelles d'analyse spatiale (locale ou globale) et temporelle (court- et long-terme). Plusieurs auteurs ont souligné les bénéfices liés à l'intégration de ces deux approches de manière à améliorer l'évaluation de la vulnérabilité au niveau local et afin de garantir la robustesse des stratégies d'adaptation et l'interaction avec le processus de prise de décision (Wilby and Dessai, 2010; Mastrandrea et al., 2010; Ekström et al., 2013). Cela renforce ainsi la pertinence des approches existantes visant à intégrer les sciences naturelles et sociales pour résoudre les problèmes liés à la gestion de l'eau, et l'intérêt de poursuivre les recherches dans cette direction (Reuss, 2003; Lund, 2015).

Les mesures d'adaptation sélectionnées doivent être coût-efficaces, mais aussi « durables pour l'environnement, culturellement compatibles et socialement acceptables », leur sélection doit tenir compte des résultats d'évaluation de la vulnérabilité, des coûts et bénéfices, des objectifs de développement, en considérant les acteurs en place et les ressources disponibles » (UNECE, 2009). Les aspects liés à l'efficacité, l'efficience, l'équité et la légitimité sont identifiés comme des facteurs clés pour assurer la durabilité des stratégies d'adaptation (Adger, 2005). Cependant, la manière de considérer ces différents facteurs et leur intégration dans le processus de prise de décision lié à l'adaptation pose encore question, en particulier dans un contexte d'incertitudes élevées associées aux projections climatiques futures, mais aussi aux autres changements des systèmes socio-économiques participant au changement globale (IPCC, 2014).

Définir un plan d'adaptation pour un bassin versant requiert la sélection parmi un éventail de mesures possibles entre différents secteurs (Iglesias and Garrote, 2015; Olmstead, 2013), depuis des mesures d'augmentation de l'offre pour développer de nouvelles infrastructures (eaux souterraines, dessalement, transferts interbassins, réutilisation, etc.), jusqu'à des mesures de gestion de la demande qui permettent des économies d'eau dans les secteurs urbains ou agricoles (Thivet and Fernandez, 2012), en passant par les possibilités de réformes au niveau institutionnel qui permettraient des changements dans l'organisation et les règles de gestion du bassin versant (Roggero, 2015).

Certaines mesures peuvent être mises en place de manière autonome par les différents usagers de l'eau afin de s'adapter à un environnement changeant, mais d'autres ont besoin d'être planifiées par les gestionnaires de bassin en prenant conscience du fait que les conditions ont changé et que des actions sont nécessaires pour garantir le bon état du bassin versant (IPCC, 2007). C'est pourquoi, les gestionnaires de bassin ont besoin d'une méthode pour sélectionner des mesures d'adaptation dans un contexte d'incertitudes liées au changement climatique.

D'un point de vue économique, différentes approches peuvent être appliquées pour sélectionner des mesures de gestion des ressources en eau. Aux États-Unis, l'Analyse Coût-Bénéfice (ACB) est requise de manière standard pour évaluer les projets fédéraux de gestion des ressources en eaux, depuis que la loi de protection contre les inondations de 1936 (US Flood Control Act) en a fait un pré requis pour déterminer si les bénéfices, quels qu'en soient les bénéficiaires, sont supérieurs aux coûts estimés. Cependant, les difficultés liées à l'application de l'ACB pour évaluer des programmes de mesures de gestion des ressources en eau dans des contextes où les interactions physiques et économiques sont complexes, ont fragilisé la confiance des gestionnaires dans les évaluations économiques exhaustives à l'échelle des bassins versants (Ward, 2009). Alternativement, une Analyse Coût-Efficacité (ACE), définie comme une méthode qui compare différentes alternatives dans le but de minimiser le coût de réalisation d'un objectif souhaité (Garber and Phelps, 1997), a souvent été utilisée pour définir des programmes de mesures, en évitant ainsi l'évaluation des bénéfices environnementaux non-marchand (et les controverses associées à leurs méthodes d'évaluation) et des bénéfices secondaires (Griffin, 1998). Dans la continuité de cette méthode, l'approche adoptée en Europe consiste à définir des objectifs environnementaux et de qualité de l'eau en se basant sur des critères biophysiques seulement. Le caractère approprié ou non de l'ACE comme règle de prise de décision pour faire face à la complexité des problèmes de gestion des ressources en eau en comparaison à d'autres types d'analyses possibles (Analyse Coût-Bénéfice, Analyse Multicritère, etc.) pose question (Messner, 2006; Martin-Ortega and Balana, 2012). Cependant, dans cette thèse, nous suivrons les

recommandations existantes au niveau européen, qui demandent aux gestionnaires et planificateurs de réaliser « une analyse économique qui doit contenir assez d'informations pour inclure dans un programme de mesures la combinaison de mesures la plus « coût-efficace » pour atteindre les objectifs environnementaux (EU, 2000).

Différentes méthodes existent pour réaliser une analyse coût-efficacité à l'échelle d'un bassin versant, depuis le simple classement des mesures selon leurs ratios coût-efficacité, divisant le coût des mesures par leur efficacité, jusqu'au développement d'une approche de modélisation intégrée dans le but de représenter la complexité des systèmes de ressources en eau (Heinz, et al., 2007). En effet, dans la littérature sur l'ingénierie des ressources en eau, la question de la sélection de mesures pour la gestion et la planification des ressources en eau a été abordée depuis longtemps comme un problème d'optimisation de l'augmentation de la capacité des infrastructures (défini comme la planification et la programmation des investissements dans de nouvelles infrastructures au cours du temps). Ce problème est analysé au moyen de modèle d'optimisation à moindre coût (Ejeta and Mays, 2005; O'Laoghaire and Himmelblau, 1974; Loucks et al., 1981). Cependant, ces approches font souvent l'hypothèse que la variabilité climatique maintiendra les propriétés statistiques des événements passés et présents. Cette variabilité climatique est habituellement caractérisée de manière stochastique, au moyen de fonction de distribution de probabilités. Le changement climatique remet en cause cette hypothèse, et avec elle la manière conventionnelle de gérer et planifier les ressources en eau, appelant au développement de nouvelles méthodes pour définir des programmes d'adaptation qui pourraient garantir de bonnes performances face à une diversité de futurs possibles.

Un programme de mesures d'adaptation optimal ou robuste élaboré dans un tel cadre d'optimisation consiste généralement en une combinaison de mesures spatialement distribuées, qui implique un grand nombre d'acteurs de différents secteurs. Néanmoins, la plupart des approches basées sur une optimisation ne parviennent pas à considérer les questions liées à l'équité et partage une même hypothèse selon laquelle les différentes parties prenantes vont parfaitement coopérer dans la mise en œuvre de la solution obtenue (Madani, 2010). Cela

correspond à adopter le point de vue d'un planificateur central (« social planner ») à l'échelle du bassin versant pour mettre en place le plan ou l'allocation des ressources la plus coût-efficace, sans prendre en compte les intérêts individuels. En pratique, la mise en œuvre d'un tel programme de mesures requiert l'accord des acteurs pour mettre en œuvre la meilleure option. L'un des facteurs clés dans la définition de la volonté de coopérer est la manière dont est réparti le coût du plan optimum entre les différents participants. Les acteurs n'accepteront de mettre en place des mesures recommandées par un plan coût-efficace, qu'à la condition de considérer que son coût a été réparti de manière équitable entre les participants, posant ainsi la question de l'équité dans la répartition du coût d'un programme de mesures. Dans la littérature sur l'adaptation, la question de l'équité est souvent limitée à l'équité spatiale dans la réduction des émissions de gaz à effet de serre au niveau global, ou à l'équité temporelle liée à l'interdépendance entre les générations futures et la présente (Paavola and Adger, 2006; Paavola, 2008). L'équité dans les processus d'adaptation en cours au niveau local est une question émergente (Thomas and Twyman, 2005; Hughes, 2013; Graham et al. 2015). Il est reconnu que les décisions liées à l'adaptation sont modelées par les décisions antérieures et les cadres institutionnels existants qui déterminent la répartition du pouvoir et des ressources (Adger and Nelson, 2010). Cependant, l'adaptation est déjà nécessaire et des décisions ont déjà besoin d'être prises au niveau local. Ainsi, la question de l'équité doit être posée pour garantir que l'impact du changement climatique ne contribue pas à renforcer les inégalités existantes.

1.2 But et objectifs de la thèse

L'objectif général de cette thèse est de développer une approche intégrant une évaluation « top-down » de l'impact du changement climatique et une analyse « bottom-up » spécifique au contexte dans un cadre cohérent pour définir un programme de mesures d'adaptation en tenant compte des critères d'efficacité économique, de durabilité environnementale, de robustesse au changement climatique et d'acceptabilité sociale à l'échelle d'un bassin versant, dans ce qui est défini comme une approche où le « top-down » rencontre le « bottom-up ».

Pour atteindre l'objectif général de cette thèse, les objectifs spécifiques suivants ont été définis.

Premièrement, intégrer les résultats d'une chaîne de modélisation « top-down », qui évalue l'impact du changement climatique sur les ressources en eau, avec des scénarios de développement et des mesures d'adaptation élaborées au moyen d'une approche « bottom-up » pour sélectionner des mesures d'adaptation au changement global à l'échelle d'un bassin versant.

Deuxièmement, sélectionner des mesures d'adaptation coût-efficaces à l'échelle d'un bassin versant, en considérant et en quantifiant les arbitrages entre différents objectifs de gestion (développement de l'agriculture irriguée, protection de l'environnement et efficacité économique) et aussi dans le but d'identifier des mesures d'adaptation de moindre regret dans un contexte d'incertitude climatique.

Troisièmement, explorer la définition d'une répartition équitable du coût du programme d'adaptation entre les acteurs impliqués dans sa mise en œuvre pour garantir que l'adaptation ne soit pas seulement efficace, mais aussi juste et acceptable.

La question de l'adaptation d'un bassin versant a besoin d'être posée au niveau local pour être à même de faire face au mieux aux impacts locaux du changement global. C'est pourquoi, le cadre méthodologique général développé dans cette thèse est appliqué dans un cas d'étude réel pour illustrer de quelle manière il pourrait être mis en œuvre. Le cas d'étude est le bassin versant de l'Orb, un bassin méditerranéen situé dans le sud de la France, où le changement global est supposé augmenter les difficultés liées à l'alimentation des demandes en eau et au respect des débits environnementaux requis pour l'atteinte des objectifs de la DCE. Cette région doit faire face au taux de croissance de la population le plus important au niveau national, à un développement rapide de l'irrigation de la vigne, et à l'impact du changement climatique sur ses ressources en eau. Le futur de la gestion des ressources en eau est devenu un enjeu stratégique au niveau régional, avec différentes mesures de gestion en préparation.

1.3 Méthode et hypothèses

Le cadre méthodologique général développé pour atteindre les objectifs de la thèse se base sur différentes méthodes et hypothèses qui sont détaillées brièvement dans cette section.

Nous considérons l'impact du changement climatique au niveau du bassin versant sur le régime naturel des écoulements de surface mais aussi sur la demande des usagers. L'impact du changement climatique dépend des projections de climats futurs et des endroits considérés. Ainsi, une chaîne de modélisation appropriée a été développée, en se basant sur des données de climat désagrégées à partir de différents modèles de circulation globale (GCM) combinées avec des modèles hydrologiques et agro-climatiques locaux, en suivant une approche « top-down ». En complément de la gamme d'impacts que pourra avoir le changement climatique, nous considérons que les besoins d'adaptation sont aussi déterminés par l'évolution de la demande en eau dans les différents secteurs, due à d'autres facteurs du changement global, et aussi par les différentes mesures d'adaptation qui peuvent être mises en œuvre. Ces différentes composantes de l'adaptation ont été prises en compte au moyen d'ateliers participatifs de constructions de scénarios (approche « bottom-up ») qui visent à identifier les facteurs du changement global qui détermineront l'évolution des demandes en eau du secteur urbain et agricole, et les possibles mesures d'adaptation.

Les résultats des approches « top-down » et « bottom-up » sont intégrés au moyen du développement d'un modèle intégré d'optimisation de la gestion d'un bassin versant. Le modèle représente la gestion des ressources à l'échelle d'un bassin versant en tenant compte des contraintes physiques et de gestion de l'hydro-système, telles que la répartition de l'eau, la gestion des infrastructures, pour atteindre les objectifs de gestion en terme d'alimentation en eau des usagers urbains et agricoles, et les débits environnementaux minimums. Ces objectifs de gestion sont définis à partir d'exigences légales (objectifs d'alimentation en eau) et de critères biophysiques (objectifs environnementaux). Ainsi, le développement d'un modèle d'optimisation a pour but de sélectionner sur la base d'un critère de coût-efficacité des mesures parmi l'ensemble des mesures de gestion de l'offre ou

de la demande considérées pour s'adapter au changement global à l'échelle du bassin versant. Dans ce cadre d'analyse coût-efficacité, les scénarios d'évolution de la demande ou le niveau des exigences environnementales peuvent être modifiés pour quantifier les arbitrages entre les différents objectifs de gestion, tel que le coût des mesures d'adaptation, le développement de l'agriculture irriguée et le niveau d'exigence environnementale. Ensuite, les performances de différents programmes de mesures peuvent être évaluées pour différentes projections de changement climatique pour identifier un programme de moindre regret dans un contexte d'incertitude climatique.

Dans le but de dépasser les limitations liées à l'adoption de la perspective d'un planificateur central, sous-jacente dans le processus d'optimisation, et qui suppose que les différents acteurs vont coopérer pour la mise en œuvre d'un programme de mesures coût-efficace, l'acceptabilité de la répartition du coût du programme d'adaptation est explorée en termes d'équité. Des scénarios d'allocation des coûts sont définis dans un premier temps au moyen de concepts issus de la théorie des jeux coopératifs et basés sur le principe de rationalité économique. Ensuite, ces résultats sont contrastés avec des scénarios d'allocation des coûts représentant différents principes de justice sociale, qui sont discutés lors d'entretiens semi-directifs réalisés en face-à-face avec des acteurs locaux afin d'obtenir leur vision sur la définition d'une répartition équitable du coût du programme d'adaptation à l'échelle du bassin versant.

Dans l'ensemble, l'une des principales contributions de cette thèse repose dans le développement méthodologique réalisé pour approfondir l'intégration d'une analyse économique appropriée avec la complexité des systèmes de ressources en eau, à la frontière entre l'économie et l'ingénierie des ressources en eau, en combinant, dans un même travail de recherche, des approches bien souvent mises en œuvre par différentes communautés scientifiques. Sa valeur ajoutée réside dans la formulation de recommandations scientifiques pour améliorer l'analyse économique qui aide à la prise de décision dans la définition de stratégie d'adaptation à l'échelle d'un bassin versant.

1.4 Organisation de la thèse et résumé des chapitres

Suite à cette introduction générale, la littérature propre à chacune des parties de cette thèse est introduite dans un chapitre d'état de l'art (Chapitre 2). Les concepts d'approches « top-down » et « bottom-up » pour l'adaptation au changement climatique sont présentées. Ensuite, la famille des modèles intégrés de gestion des ressources en eau, utilisés pour combiner ces deux approches et pour sélectionner un programme de mesures coût-efficace, est présentée. Finalement, la littérature abordant la définition d'une répartition équitable du coût d'un programme de mesures est introduite.

Par la suite, nous décrivons la cadre général utilisé pour intégrer les approches top-down et bottom-up et sélectionner des mesures d'adaptation en prenant en compte les objectifs de coût-efficacité et d'équité dans la répartition du coût (Chapitre 3). Le cas d'étude du bassin de l'Orb en France, où ce cadre général a été développé, est présenté plus en détails dans le chapitre 4. La situation actuelle en termes d'hydrologie, de demandes en eau, d'infrastructures est décrite, ainsi que le contexte institutionnel local.

Les résultats de la mise en œuvre du cadre méthodologique dans le cas d'étude sont décrits dans le chapitre 5 : les scénarios d'évolution des demandes et les mesures d'adaptation, pour l'approche « bottom-up » ; et l'impact du changement climatique sur les ressources en eau au moyen de la désagrégation des données climatiques globales et de la modélisation hydrologique, pour l'approche « top-down ».

Le chapitre 6 présente les résultats d'une première analyse coût-efficacité des mesures d'adaptation, et leurs limitations sont expliqués afin d'introduire les résultats du modèle de gestion des ressources en eau utilisé pour sélectionner un programme de mesures d'adaptation coût-efficace. Les déficits dans l'alimentation en eau des demandes agricoles dus au changement global sont quantifiés et les mesures requises pour une adaptation coût-efficace sont identifiées. Les arbitrages entre le coût d'un programme d'adaptation, le développement de l'agriculture irriguée et les objectifs de maintien de débits écologiques sont évalués pour un

scénario de changement global. Ensuite, les performances de différents programmes de mesures définis pour différentes projections de changement climatique sont comparées pour des projections alternatives, afin d'évaluer leur robustesse (test climatique) et d'identifier une option de moindre regret.

La répartition du coût du programme de mesures d'une manière équitable est finalement abordée dans le chapitre 7. Le problème de la répartition des coûts associés à la définition d'un programme de mesures d'adaptation au changement climatique est formulé dans le cas d'étude considéré. Puis, les résultats des deux approches utilisées pour aborder ce problème, la théorie de la justice sociale et la théorie des jeux coopératifs, sont présentés et mis en parallèle.

Le chapitre 8 discute les résultats obtenus dans le cas d'étude considéré et revient aussi sur les limites et futurs défis à relever associés au cadre général développé.

Afin de faciliter la compréhension de l'ensemble du travail réalisé durant cette thèse, les différents travaux publiés au cours du doctorat ont été combinés et réorganisés pour produire le manuscrit dans sa forme actuelle, en accord avec les co-auteurs de ces différentes publications. Des compléments d'information ont été apportés dans les chapitres respectifs ou dans les différentes annexes pour permettre au lecteur intéressé d'avoir accès à une version plus détaillée et plus facile à lire du travail réalisé. Des parties du texte sont extraites directement des publications en accord avec les politiques relatives aux droits d'auteurs des différents journaux autorisant « les auteurs puissent réutiliser leurs articles, en totalité ou en partie, à de larges fins universitaires, non commerciales telles que la rédaction d'une thèse de doctorat » (voir annexe Licence agreements).

1.5 Contexte de la thèse et publications associées

Les acteurs et décideurs politiques ont été associés au développement de cette thèse au travers de la coopération établie par le Bureau des Ressources Géologiques et Minières (BRGM). En effet, la recherche présentée dans cette thèse a bénéficié du travail préalablement réalisé dans le bassin de l'Orb par l'équipe de recherche du BRGM durant plusieurs projets de recherche successifs tels que le projet Ouest-Hérault, phase I (2007-2008) et phase II (2010-2012)

financé par l'Agence de l'Eau Rhône-Méditerranée-Corse, le conseil régional du Languedoc-Roussillon, et le conseil général de l'Hérault ; et le projet de recherche sur le développement de modèle hydro-économique financé par le BRGM et l'Office Nationale de l'Eau et des Milieux Aquatiques (ONEMA) en 2013-2014 qui ont fourni les ressources nécessaires à l'accompagnement et à la réussite de la thèse.

Durant ma thèse, j'ai été inscrit comme doctorant à l'Université Polytechnique de Valencia (UPV) en Espagne dans le programme de doctorat en ingénierie de l'eau et de l'environnement, et en même temps dans le cadre d'une procédure de co-tutelle de thèse internationale j'ai été aussi inscrit à l'Ecole Doctorale d'Economie et Gestion de Montpellier, rattachée au Centre international d'études supérieures en sciences agronomiques (SupAgro Montpellier, France), ce qui m'a permis d'alterner mes périodes de travail entre la France et l'Espagne.

Durant mon doctorat, j'ai bénéficié d'une bourse du programme de formation des enseignants universitaires du Ministère de l'Education et de la Culture et des Sports d'Espagne (FPU12/03803). Comme mentionné auparavant, les articles suivants ont été publiés dans des journaux scientifiques internationaux à comité de lecture durant la préparation de cette thèse :

- **Girard**, C., Rinaudo, J.-D., Pulido-Velázquez, M., Caballero, Y., 2015. An interdisciplinary modelling framework for selecting adaptation measures at the river basin scale in a global change scenario, *Environmental Modelling & Software*, (69), 42-54. <http://dx.doi.org/10.1016/j.envsoft.2015.02.023>
- **Girard** C., Rinaudo, J.-D., and Pulido-Velazquez M. 2015 Cost-Effectiveness Analysis vs. Least-Cost River Basin Optimization Model: comparison in the selection of water demand and supply management measures at river basin scale. *Water Resources Management*, <http://link.springer.com/article/10.1007/s11269-015-1049-0>
- **Girard**, C., Pulido-Velazquez, M., Rinaudo, J.-D., Page, C., and Caballero, Y., 2015, Integrating top-down and bottom-up approaches to design global change adaptation at the river basin scale, *Global Environmental Change* 34, 132-146 <http://dx.doi.org/10.1016/j.gloenvcha.2015.07.002>.

Chapitre 9 Résumé et conclusion

9.1 Résumé

L'adaptation au changement global à l'échelle d'un bassin versant est un processus complexe qui requiert l'intégration de différentes approches. En combinant des méthodes issues des sciences économiques et des sciences de l'ingénieur appliquées à la gestion des ressources en eau, le travail présenté dans cette thèse intègre les approches « top-down » et « bottom-up » pour développer un plan d'adaptation au changement global à l'échelle d'un bassin versant, qui prend en compte des objectifs de coût-efficacité dans la sélection des mesures et d'équité dans la répartition des coûts de l'adaptation.

L'approche « bottom-up » implique un processus de construction de scénario en appliquant des méthodes prospectives participatives en combinaison avec la modélisation des demandes agricoles et urbaines pour estimer les futurs scénarios de demande. Les mesures d'adaptation locales sont identifiées au moyen d'ateliers avec les acteurs et systématiquement caractérisées en termes de coût et d'efficacité. Dans l'approche « top-down » les données climatiques sont désagrégées à partir de modèles climatiques globaux pour évaluer l'impact sur le régime hydrologique dans des conditions d'incertitudes climatiques.

Les approches « bottom-up » et « top-down » se rencontrent lorsque des programmes de mesures de moindre coût sont identifiés au moyen d'un modèle intégré d'optimisation de la gestion des ressources en eau. Les indicateurs de performances économiques et de garantie de l'alimentation des demandes en eau sont évalués pour différentes projections de climats futurs et pour différents programmes de mesures d'adaptation. Cela fournit une information utile pour évaluer la robustesse de différentes décisions d'adaptation au changement climatique, et pour identifier des mesures de moindre regret.

L'allocation du coût du programme d'adaptation a été abordée par deux approches complémentaires : l'une représente le résultat potentiel d'un processus de

négociation entre les acteurs et utilise des principes de la théorie de jeux coopératifs ; l'autre définit une règle de répartition des coûts en se basant sur différents principes de justice sociale, discutés avec des acteurs lors d'une enquête de terrain. Les questions de la justice et de l'équité sont ainsi considérées lors de la définition de la stratégie d'adaptation.

Le cadre méthodologique a été mis en œuvre dans un cas d'étude réel, le bassin versant de l'Orb dans le sud de la France, pour informer la stratégie d'adaptation à définir au niveau local. Les résultats illustrent l'intérêt de mesures de gestion de la demande comme mesures de moindre regret lors de l'adaptation à un changement global incertain, par opposition à des mesures de gestion de l'offre plus coûteuses en termes d'investissement. Un arbitrage est nécessaire entre le développement de l'agriculture irriguée, la protection de l'environnement et les contraintes budgétaires pour garantir une gestion durable des ressources en eau dans le bassin versant. La relativement bonne capacité d'adaptation du bassin de l'Orb au regard des changements considérés est due aux marges de manœuvres existantes dans la gestion du barrage des Monts d'Orb en amont. Cependant, pour permettre que le processus d'adaptation soit équitable, un problème important reste à résoudre : l'allocation du coût des mesures d'adaptation à l'échelle du bassin. Pour répondre à cette question, il faudra peut-être reconsidérer la manière dont le réservoir a été géré historiquement, et modifier son usage actuel de compensation des transferts réalisés, pour lui permettre d'améliorer aussi la gestion de l'eau à l'échelle du bassin et d'assurer l'équité entre les différents usagers du bassin.

9.2 Conclusion

La principale contribution de ce travail de recherche est qu'il intègre des résultats de différentes approches dans un cadre cohérent pour permettre la sélection de mesures d'adaptation et l'allocation des coûts de l'adaptation à l'échelle d'un bassin versant. Cela permet de dépasser les limites d'une étude d'impact « top-down » conventionnelle en fournissant une manière de la relier à la définition d'un plan d'adaptation au niveau local. Cela permet aussi d'améliorer l'approche « bottom-up » en fournissant des informations additionnelles sur l'ampleur des

changements à espérer et en permettant d'estimer les conséquences de différents plans d'adaptation pour différentes futures conditions (analyse d'arbitrage et de moindre regret). En comparant les résultats de l'application des approches issues de la théorie des jeux et de la justice sociale, cette recherche fournit aussi une vision contrastée qui pourrait permettre de négocier une juste répartition du coût de l'adaptation. Dans l'ensemble, le travail réalisé présente une possibilité pour considérer différents critères clés dans le processus d'adaptation (coût-efficacité, équité, durabilité environnementale, robustesse) qui ont souvent été considérés séparément dans des études antérieures.

La valeur ajoutée de cette approche interdisciplinaire réside dans la combinaison de ces différentes composantes, à la frontière entre l'ingénierie et les sciences économiques. L'intégration des approches « top-down » et « bottom-up » pourrait être une manière de combler l'écart entre l'étude théorique des impacts du changement climatique et la définition pragmatique de stratégie d'adaptation à l'échelle locale. Le modèle de gestion des ressources en eau développé pour réaliser une analyse économique des options d'adaptation et de possibilités de répartir les coûts est, dans ce cas, un élément d'intégration pour une compréhension partagée du problème à résoudre. Cela ouvre la voie à une évaluation intégrée et participative des impacts des changements globaux à l'échelle des bassins versant dans le but de définir des stratégies d'adaptation et de développer dans son intégralité un cycle de gestion capable de s'adapter (adaptive management cycle). Même si la complexité croissante des enjeux liés à la gestion de l'eau dans la perspective des changements globaux semble indiquer un intérêt pour ce type d'approche, son adoption dans les pratiques de gestion de l'eau reste une question à laquelle il est difficile de répondre de manière catégorique. Ce type d'approche ne pose pas seulement des questions en termes de ressources financières à mobiliser pour leurs développements, mais aussi en terme d'acceptabilité et d'appropriation par les décideurs, techniciens, acteurs et même chercheurs, qui ne sont pas tous encore aussi familiers avec ce genre d'approche intégrée et interdisciplinaire.

9.3 Futures recherches

Les développements réalisés durant cette recherche ont fourni diverses contributions pour traiter la question de l'adaptation au changement global à l'échelle d'un bassin versant, ils ont aussi permis de poser de nombreuses autres questions et d'identifier de nouvelles lignes de recherche. En se basant sur les limitations présentées dans le chapitre de discussion, ces différentes lignes de recherches peuvent être résumées de la manière suivante :

A partir de ce qui a été appris durant le développement et l'utilisation du cadre méthodologique au niveau local, il serait intéressant de développer ce cadre à une échelle plus importante pour traiter de la question de l'adaptation dans un bassin versant plus grand (type Rhône) ou à l'échelle d'un système régional plus complexe (le Languedoc-Roussillon). On peut espérer qu'une telle approche serait plus pertinente à une plus grande échelle, là où les décisions stratégiques doivent être prises (par exemple la construction de transfert interbassin) dans un contexte d'incertitude climatique. De plus, les décideurs impliqués dans la planification et la gestion des ressources en eau à l'échelle régionale en France sont probablement plus habitués à la complexité des systèmes de ressources en eau, des processus de planification et des outils de modélisations.

Au niveau local, du point de vue de l'approche "bottom-up", de plus amples recherches pourrait être menées afin d'améliorer l'interaction avec les acteurs lors du développement d'un tel cadre de modélisation intégrée ou pour améliorer la communication au sujet des incertitudes associées aux scénarios futurs. Par exemple, le développement d'une approche de modélisation participative avancée pourrait probablement améliorer l'utilité et l'appropriation du développement d'un tel cadre de modélisation pour la gestion et l'adaptation des systèmes de ressources en eau au changement global. Cela impliquerait de passer d'une approche interdisciplinaire, telle que celle présentée dans cette thèse, à une approche transdisciplinaire.

En ce qui concerne la partie « top-down », une analyse plus en détails des incertitudes et de leur propagation le long de la chaîne de modélisation pourrait être réalisée en considérant les derniers scénarios d'émissions mis à jour, différents GCMs, d'autres méthodes de désagrégations ou de modélisations hydrologiques. Il pourrait être intéressant de s'orienter vers une approche de type analyse du risque, qui se baserait par exemple sur la combinaison de modèles stochastiques générateurs de climat avec des modèles de climats globaux.

D'un point de vue plus large, les déterminants de la vulnérabilité des systèmes de ressources en eau pourraient être explorés plus en profondeur au moyen de l'analyse d'un plus grand nombre de scénario de climat et de développement, en employant des méthodes de découverte de scénario ou d'analyse groupée (cluster analysis). De telles méthodes pourraient permettre d'identifier les seuils critiques dans les différents scénarios, non seulement en termes de variation du climat, mais aussi de développement urbain et agricole, qui pourraient remettre en cause le processus d'adaptation au sein du bassin versant.

Quant au modèle d'optimisation à moindre coût à l'échelle du bassin versant, un développement intéressant serait de quantifier l'impact sur les résultats de la prévision parfaite due à l'optimisation déterministe, en comparant ceux-ci avec ceux de méthodes d'optimisation alternatives de type stochastique ou combinant des modèles de simulation avec des algorithmes génétiques.

L'espace de solution autour du programme de mesure optimum pourrait être exploré pour identifier des solutions de second choix au moyen de l'application de différentes techniques de filtres. Cela permettrait d'évaluer la marge de manœuvre pour une négociation dans la définition des programmes de mesures. Le processus d'optimisation pourrait aussi être amélioré pour inclure le phasage de l'investissement et pour donner plus de flexibilité dans la définition des voies d'adaptation en intégrant la possibilité d'apprendre le long du processus d'adaptation.

Le développement d'un modèle d'optimisation hydro-économique complet incluant des fonctions de demande pourrait aussi permettre d'obtenir des éléments

complémentaires pour l'analyse de l'adaptation au changement global, en évaluant les bénéfices associés à des changements dans la répartition de l'eau, qui n'était pas possible dans cette thèse. Cela permettrait de caractériser aussi les bénéfices associés aux différentes stratégies d'adaptation d'un point de vue économique. La prise en compte de ces bénéfices pourrait à son tour améliorer la définition d'un plan d'adaptation juste et équitable, en identifiant la répartition des bénéfices qui y sont associés.

En ce qui concerne, la répartition des coûts, une première manière d'améliorer l'analyse du problème serait de modifier le modèle d'optimisation pour imposer d'autres contraintes. Celles-ci pourraient définir par exemple des critères d'équité différents pour estimer les arbitrages entre l'équité et l'efficacité d'un programme de mesures. Pour améliorer la prise en compte des incertitudes associées au changement climatique, la définition d'un scénario de répartition du coût du plan d'adaptation pourrait être réalisée pour différentes projections climatiques, illustrant les variations dans la répartition du coût qui pourraient y être liées et les conséquences en termes d'équité. Ensuite, la résolution spatiale de l'analyse pourrait être affinée au moyen du développement d'un modèle basé sur les agents, ou par l'utilisation d'un cadre de modélisation décentralisé pour réaliser l'optimisation à l'échelle des sous-bassins, ou plus fine, qui retranscrirait plus fidèlement les interactions entre les acteurs.

Du point de vue de l'approche utilisant la théorie des jeux, le modèle d'optimisation pourrait permettre aux différents joueurs de modifier leurs stratégies en réponse aux coalitions formées par les autres joueurs, au lieu de considérer qu'ils vont continuer à jouer leur solution autonome. Cela a déjà été réalisé par exemple au moyen d'une approche dite de renforcement de l'apprentissage (« reinforcement learning approach »).

L'analyse de l'allocation des coûts du point de vue de la justice sociale pourrait être améliorée en tenant compte d'autres dimensions de ce concept. Etant donné son importance dans la définition d'une répartition juste et équitable du coût, la justice délibérative, comprise comme la justice dans le processus même au cours duquel les règles d'allocation sont définies, pourrait être une de ces dimensions.

Ensuite, pour aller un pas plus loin dans notre comparaison de différentes approches, on pourrait développer un protocole expérimental pour évaluer la différence entre les résultats des précédentes approches et ce que les acteurs choisiraient dans un cadre expérimental.

Finalement, l'une des questions qui doit encore être abordée est l'intégration de la méthode développée dans un cadre plus ample de gestion pour prendre en compte la capacité d'apprentissage et traiter aussi des questions de gouvernance et de gestion liées au processus d'adaptation. Cela nécessiterait, par exemple, de prendre en compte d'autres mesures d'adaptation ou contraintes liées au contexte légal ou institutionnel, et aussi de développer une meilleure compréhension du processus d'apprentissage et de prise de décision local.