

# ANEXO PLANIMETRÍA

TFG

Arquitectura modular, superando el contenedor marítimo

Alumno: Francisco García Traver  
Tutor: Francisco Miravete Martín

0,85

1,5

1,5

1,5

1,5

0,85

1,8

1,8

1,8

1,8

1,8

1,8



UNIVERSITAT  
POLITÈCNICA  
DE VALÈNCIA

Universidad Politécnica de Valencia  
Grado en Fundamentos de la Arquitectura

## INDICE

PR001. PLANTA DE CONJUNTO.....	5
PR002. ALZADOS LARGOS DE CONJUNTO.....	6
PR003. ALZADOS CORTOS DE CONJUNTO.....	7
PR004. PLANTA DE VIVIENDA.....	8
PR005. SECCIONES A-A' Y B-B'.....	9
PR006. PLANTA DE CUBIERTA.....	10
PR007. ALZADOS CORTOS DE VIVIENDA.....	11
PR008. ALZADOS LARGOS DE VIVIENDA.....	12
PR009. PLANTA Y SECCIÓN MÓDULO ESTUDIO.....	14
PR010. PLANTA Y SECCIÓN MÓDULO HABITACIÓN.....	15
PR011. PLANTA Y SECCIÓN MÓDULO BAÑO.....	16
PR012. PLANTA Y SECCIÓN MÓDULO TERRAZA 1.....	17
PR013. PLANTA Y SECCIÓN MÓDULO TV.....	18
PR014. PLANTA Y SECCIÓN MÓDULO TERRAZA 2.....	19
CT001. SECCIÓN CONSTRUCTIVA.....	20
CT002. FASE DE FABRICACIÓN 1.....	22
CT003. FASE DE FABRICACIÓN 2.....	23
CT004. FASE DE FABRICACIÓN 3.....	24
CT005. FASE DE FABRICACIÓN 4.....	25
CT006. FASE DE FABRICACIÓN 5.....	26
CT007. FASE DE FABRICACIÓN 6.....	27
CT008. FASE DE FABRICACIÓN 7.....	28
CT009. FASE DE FABRICACIÓN 8.....	29
CT010. FASE DE FABRICACIÓN 9.....	30
CT011. FASE DE MONTAJE EN PARCELA 1.....	32
CT012. FASE DE MONTAJE EN PARCELA 2.....	33
CT013. FASE DE MONTAJE EN PARCELA 3.....	34
CT014. FASE DE MONTAJE EN PARCELA 4.....	35
CT015. FASE DE MONTAJE EN PARCELA 5.....	36
CT016. FASE DE MONTAJE EN PARCELA 6.....	37
INST001. PLANTA DE ILUMINACIÓN EXTERIOR.....	38
INST002. PLANTA DE ILUMINACIÓN INTERIOR.....	39
ST001. PLANTA Y SECCIÓN ESTRUCTURA MÓDULO.....	40
ST002. SECCIÓN TRANSVERSAL ESTRUCTURA MÓDULO.....	41
INF001. INFOGRAFÍA EXTERIOR 1.....	42
INF002. INFOGRAFÍA EXTERIOR 2.....	43
INF003. INFOGRAFÍA INTERIOR 1.....	44
INF004. INFOGRAFÍA INTERIOR 2.....	45
INF005. INFOGRAFÍA AÉREA VIVIENDA.....	46
INF006. INFOGRAFÍA AÉREA GRUPAL.....	47

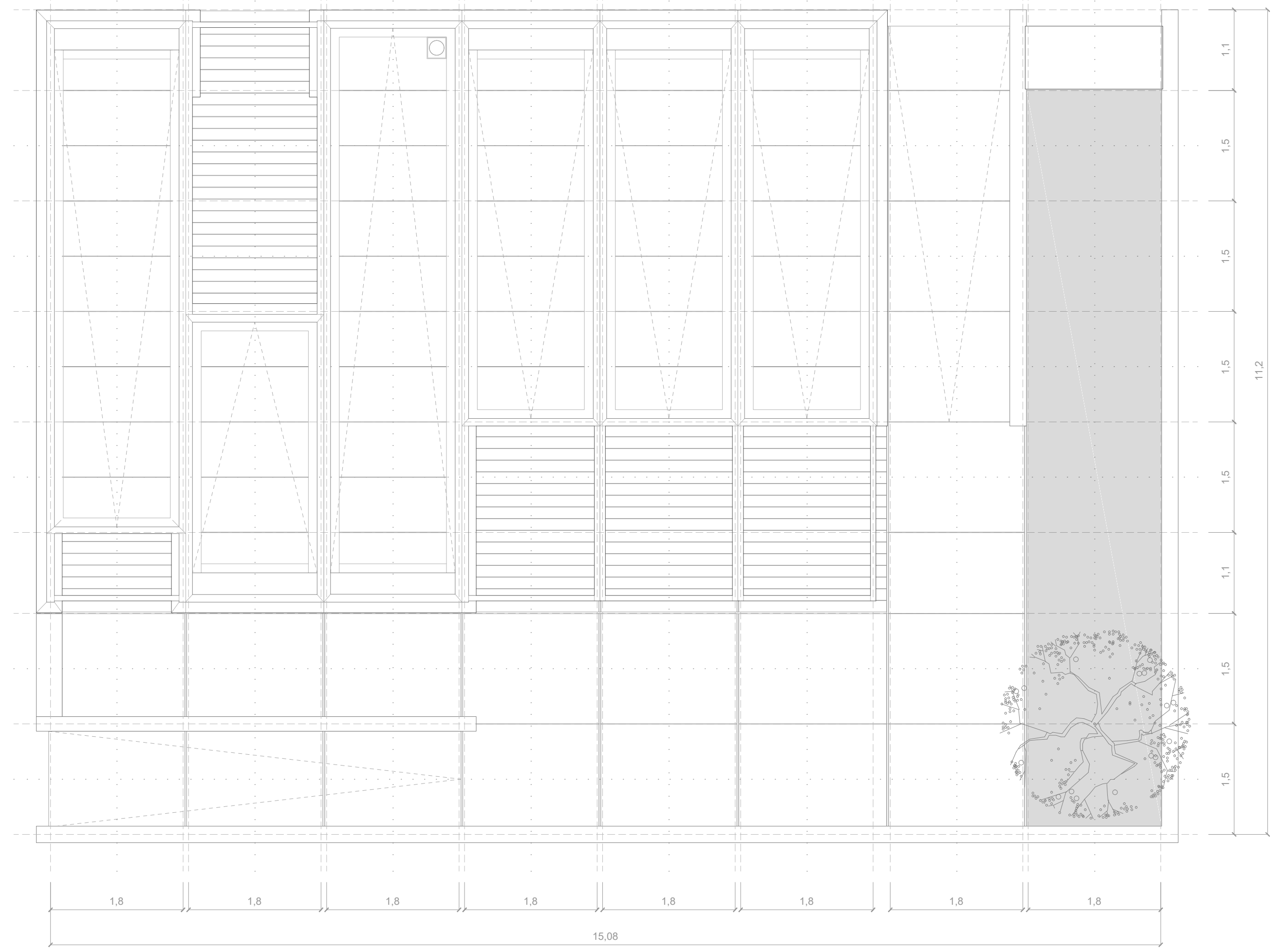

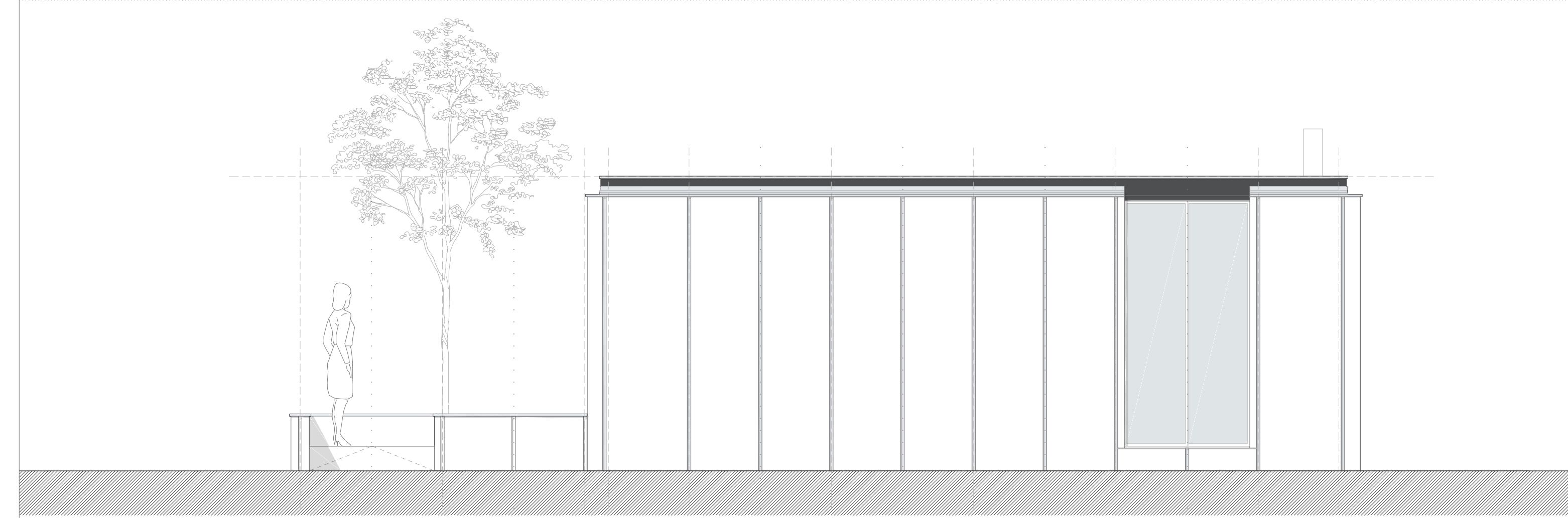
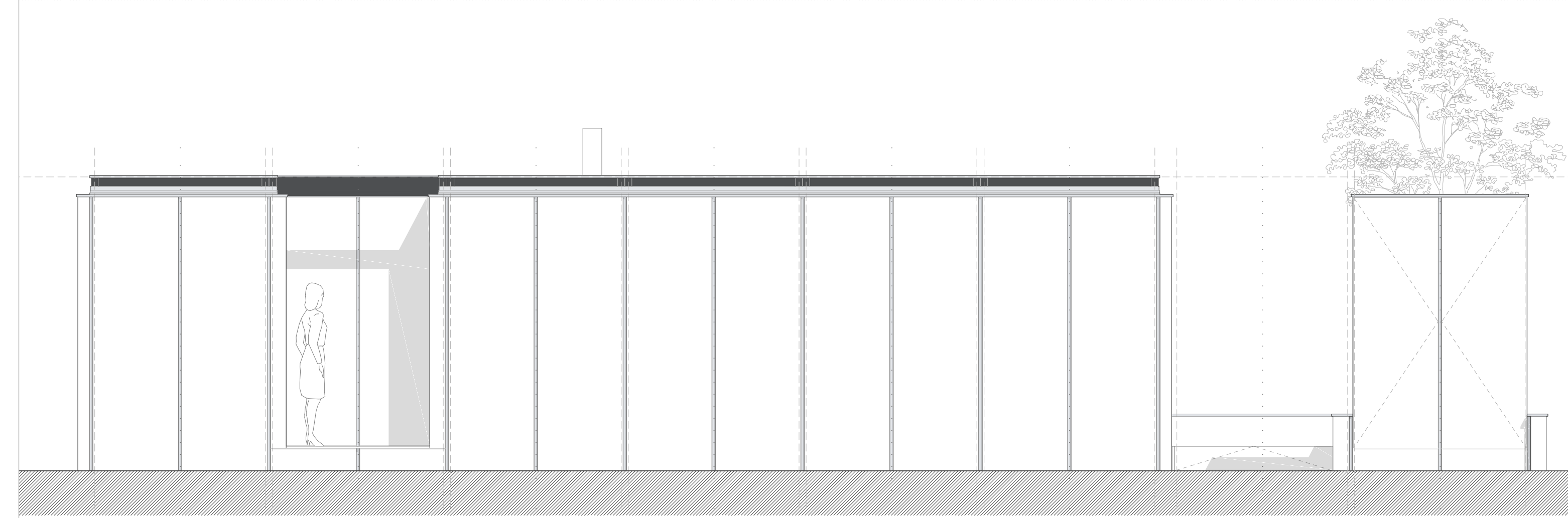
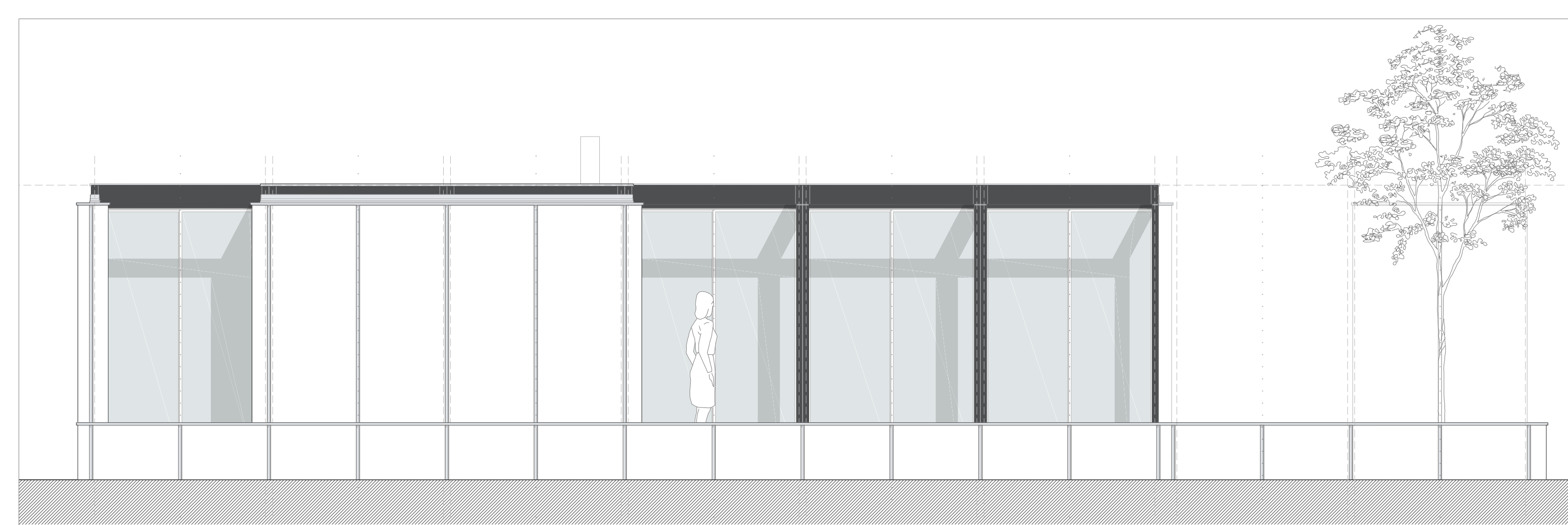



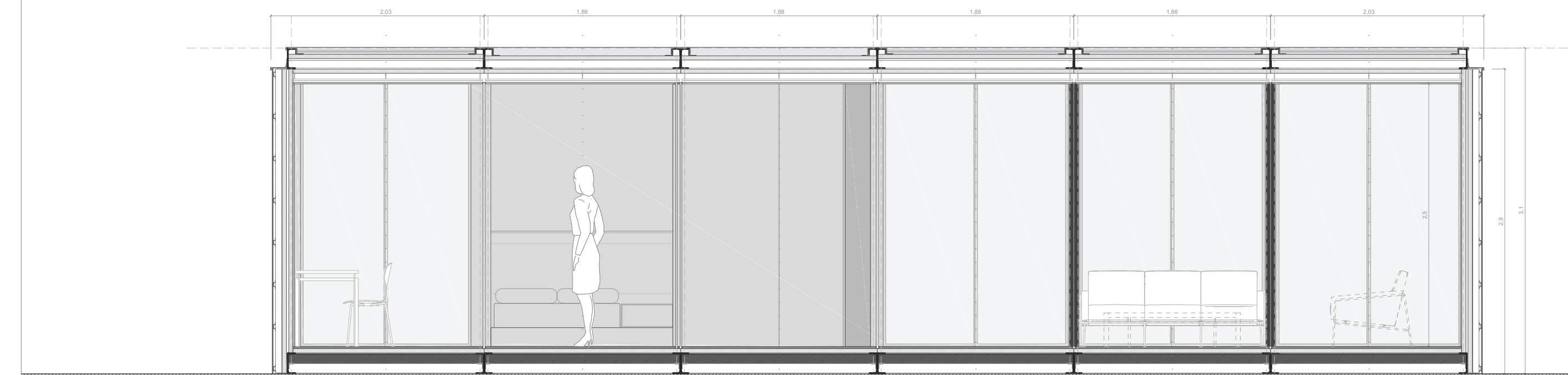
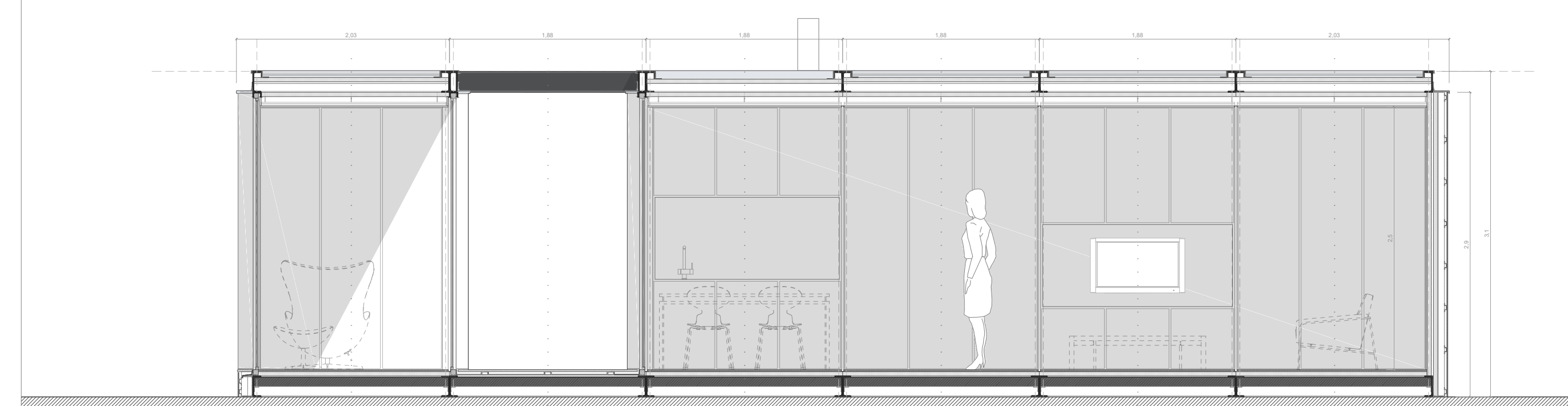
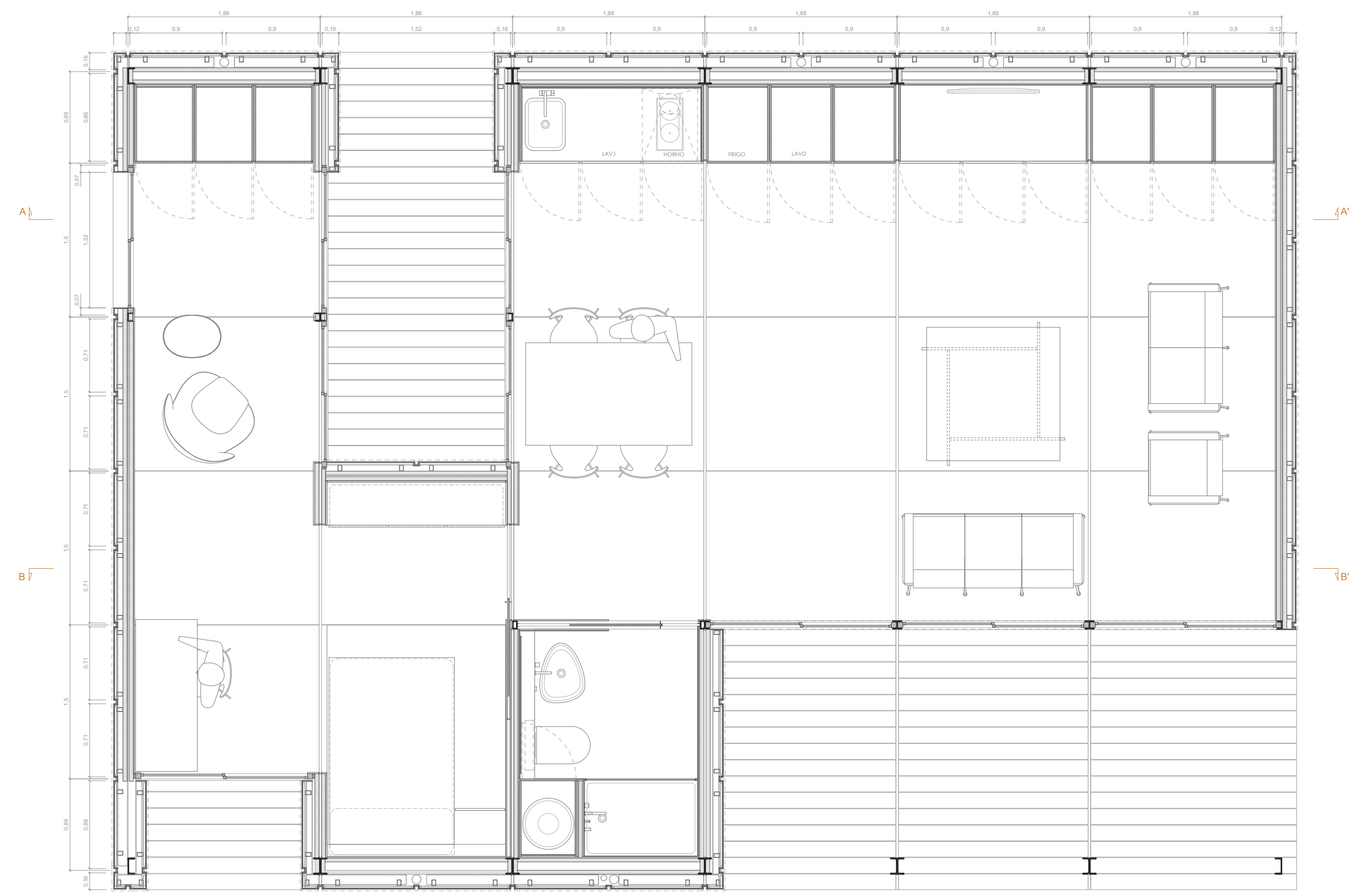

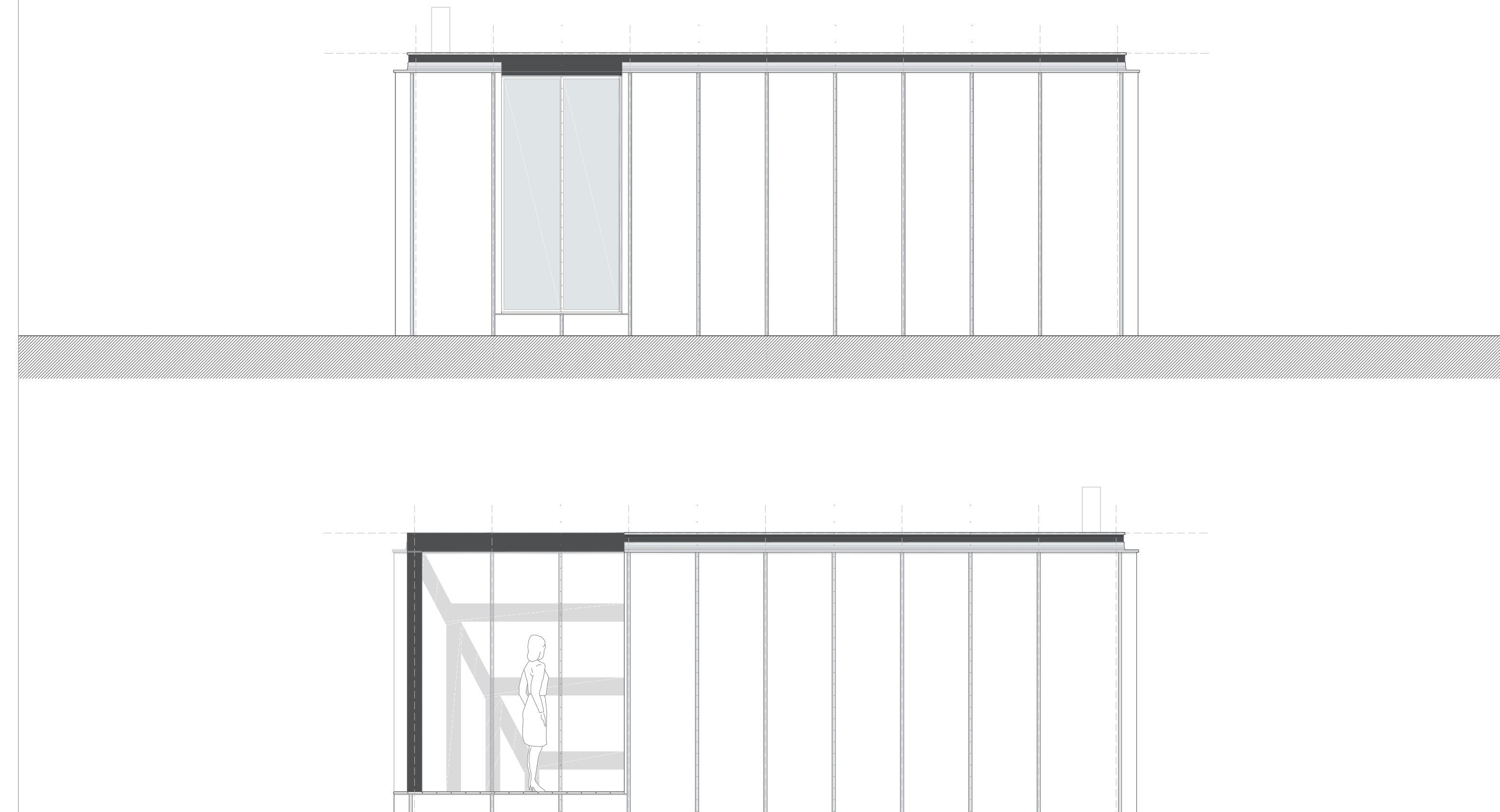

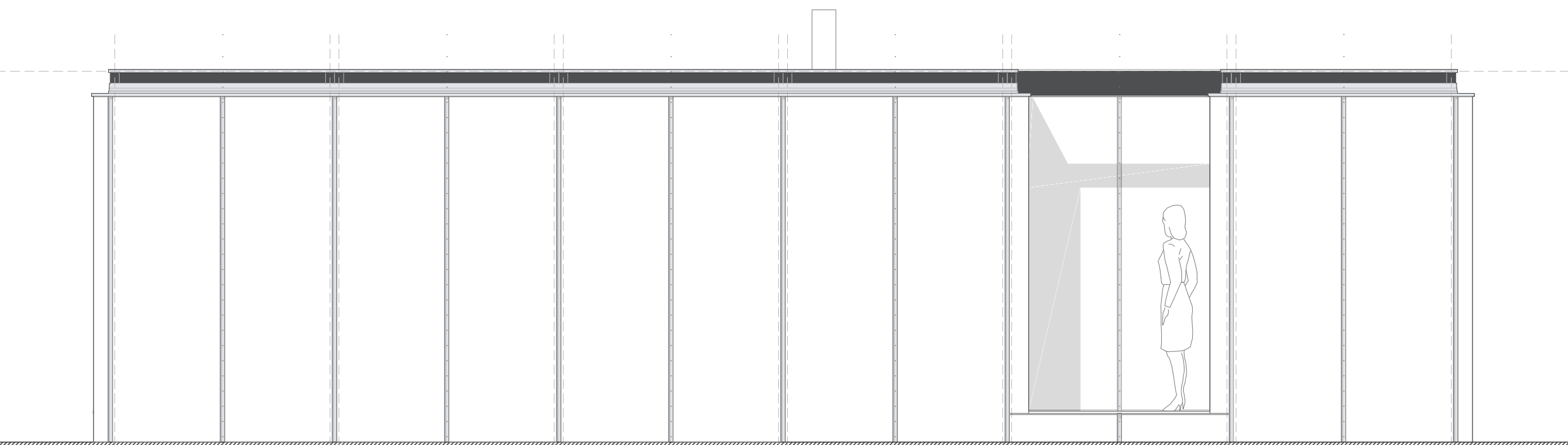
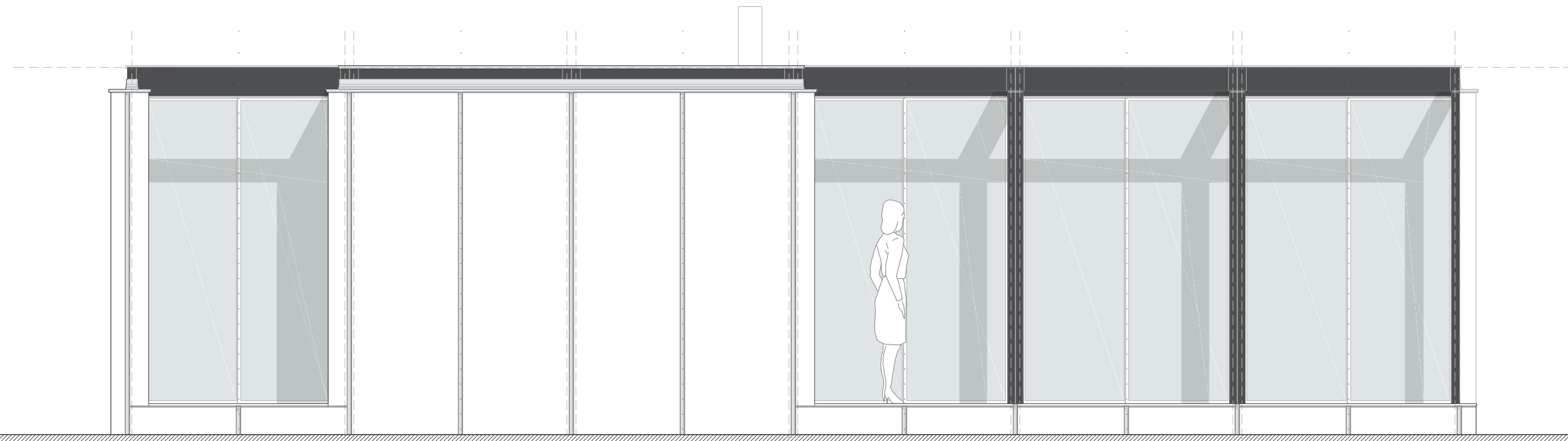

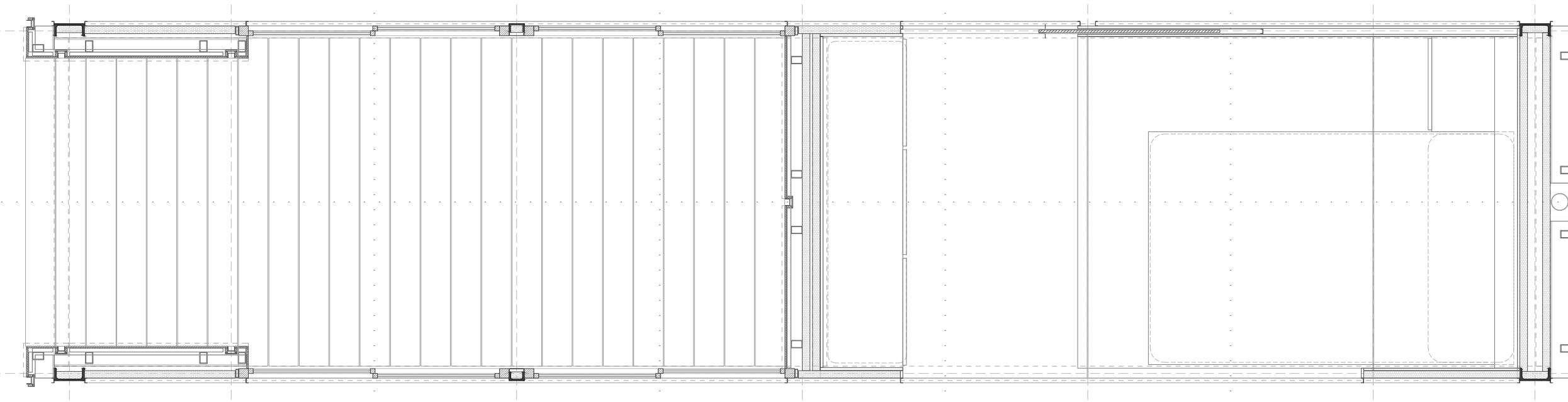
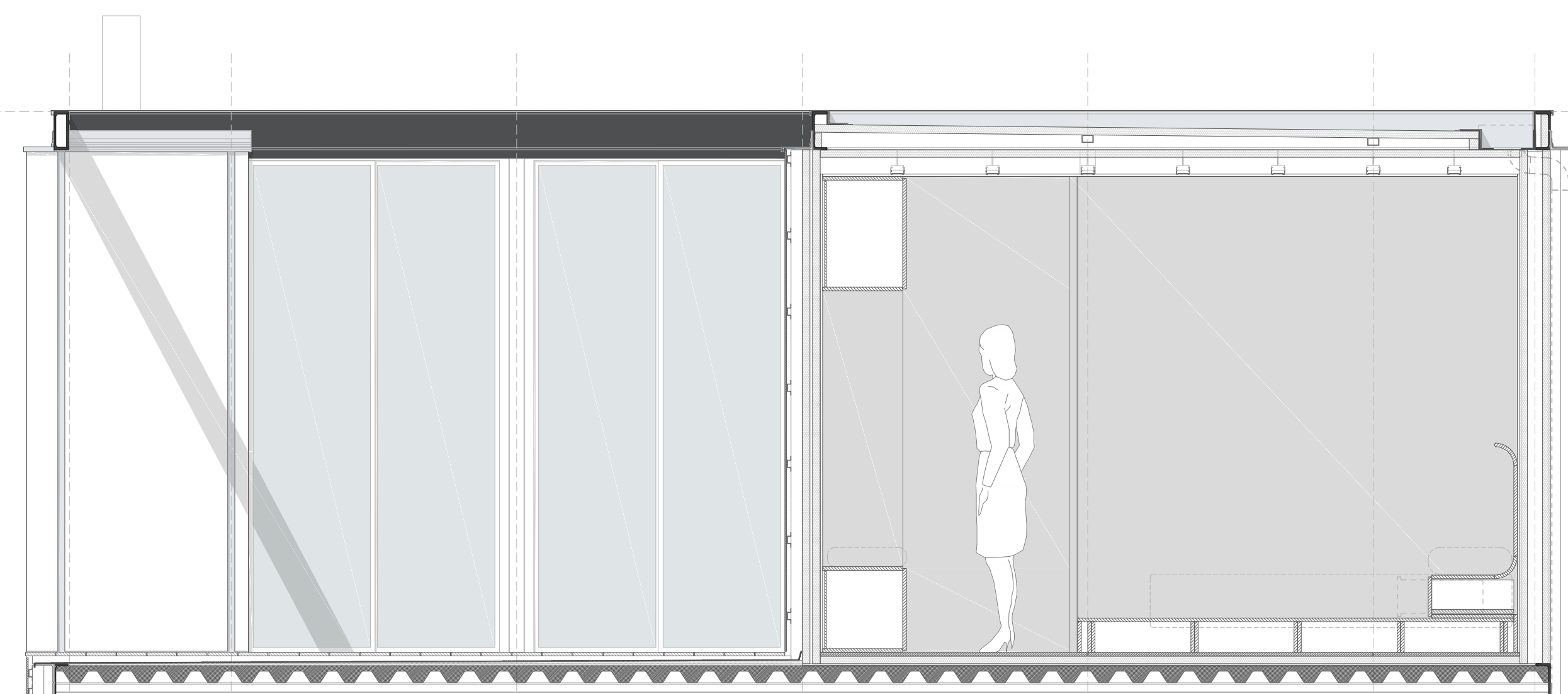
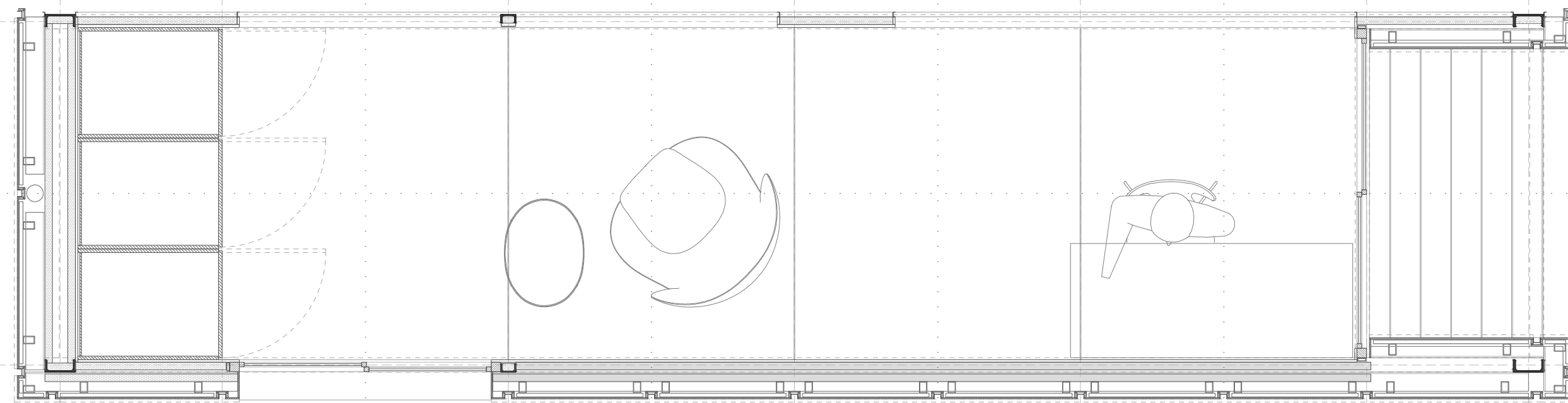
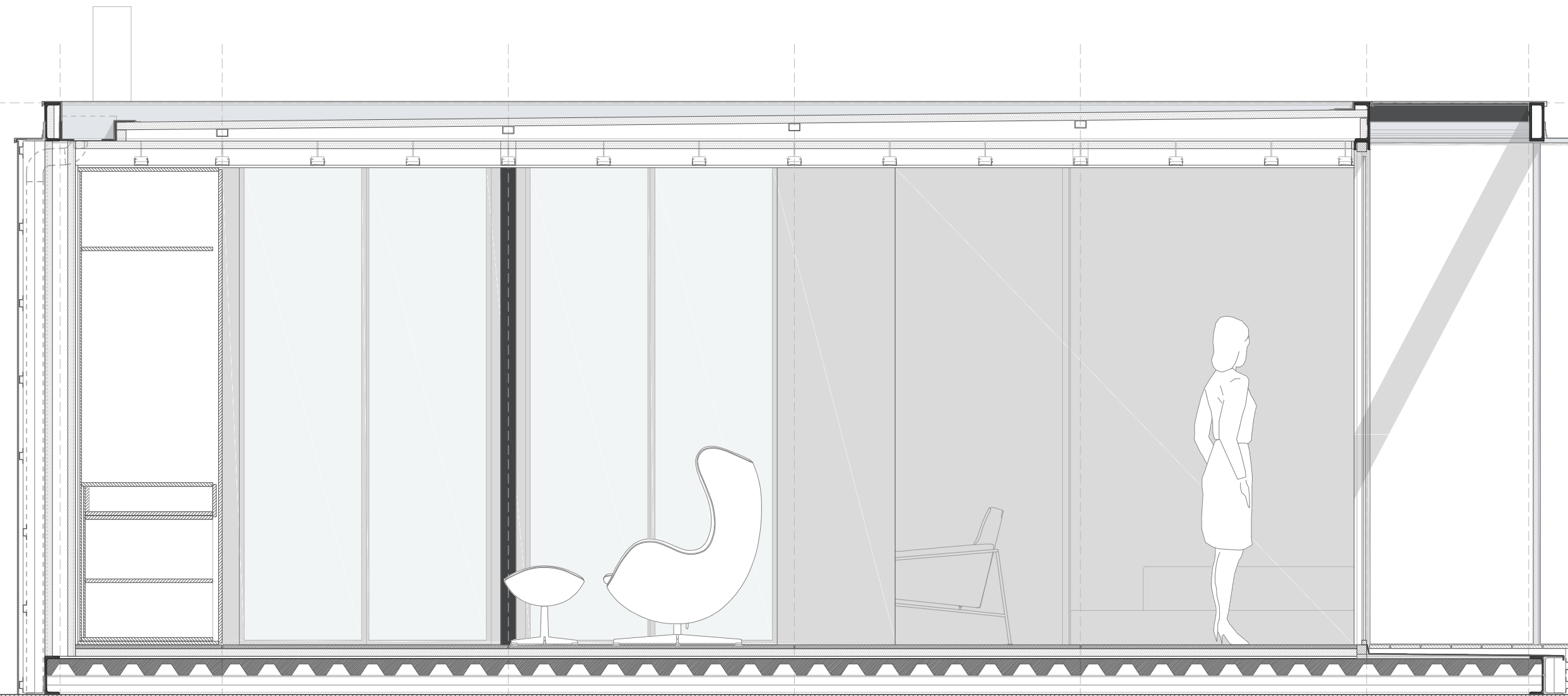



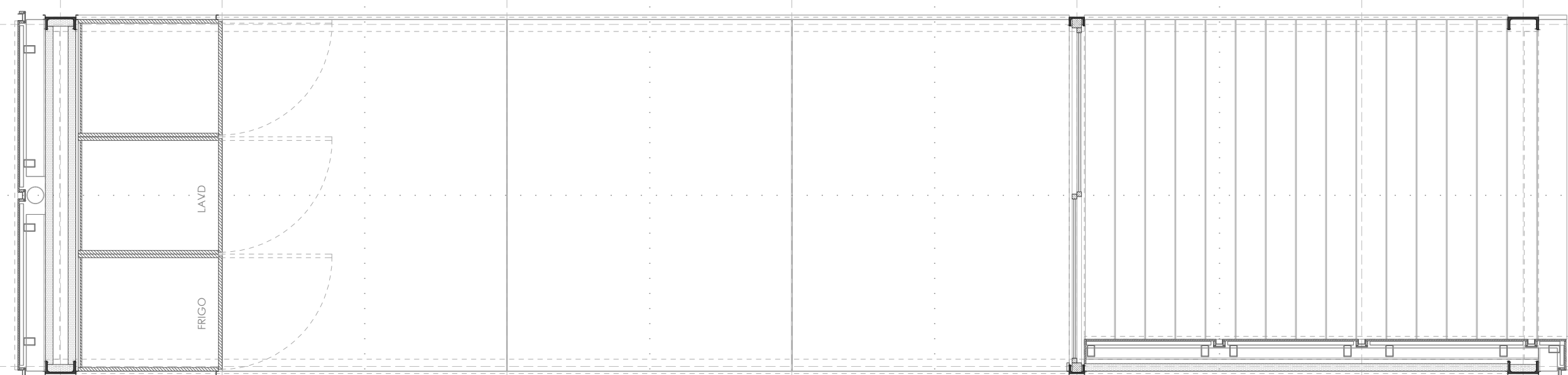
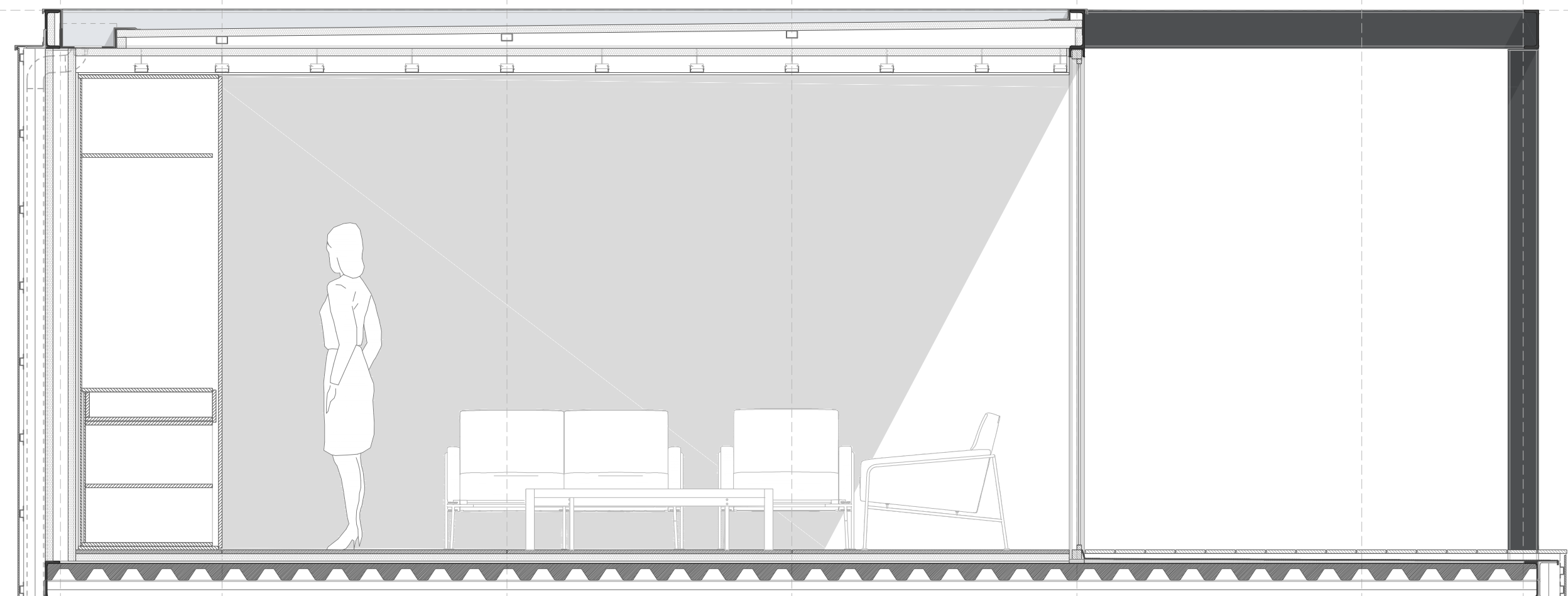
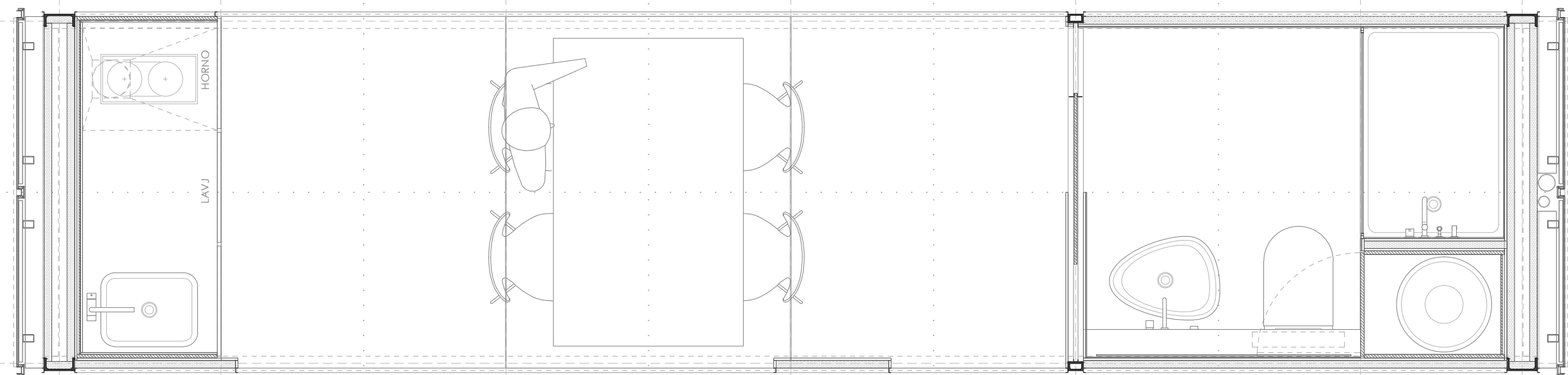
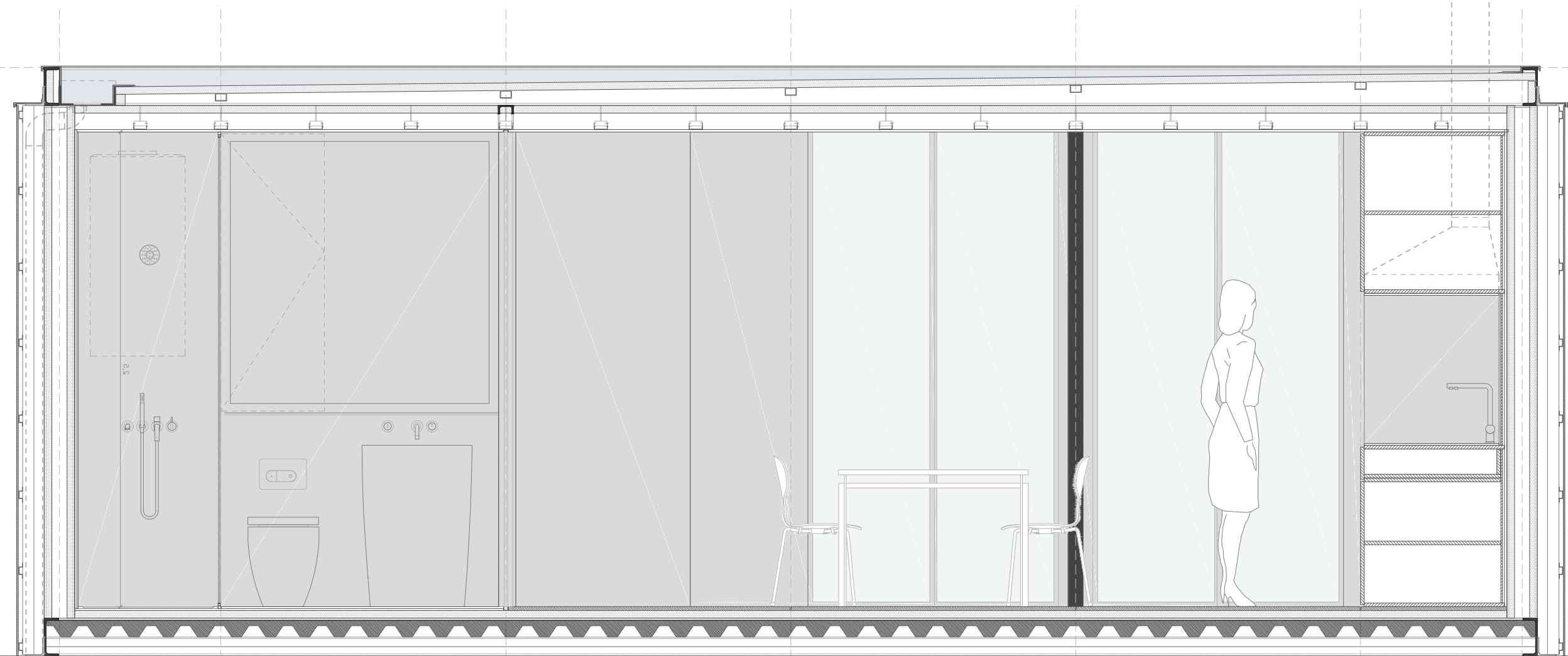

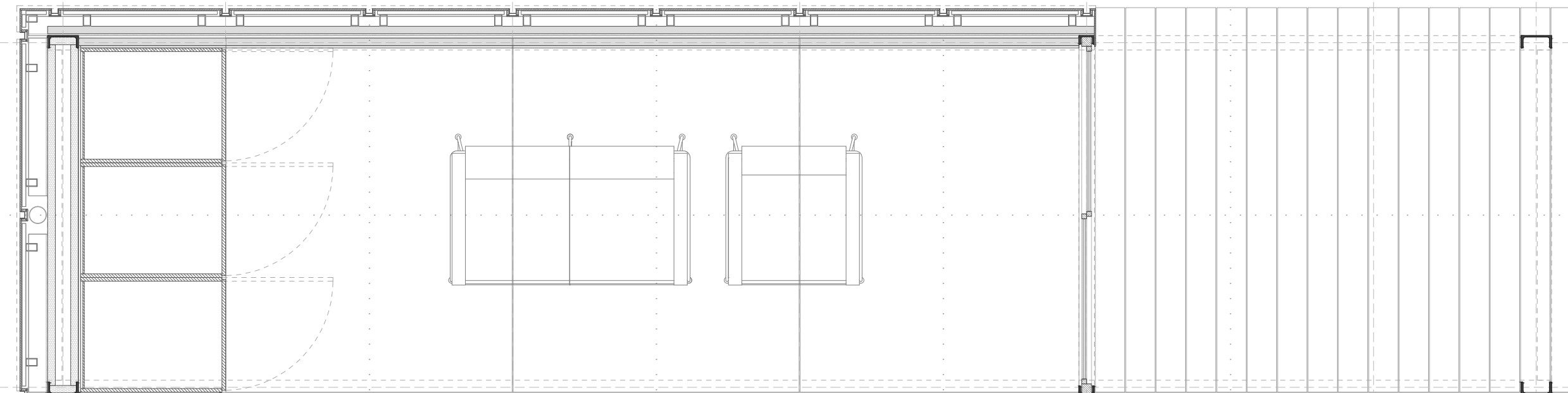
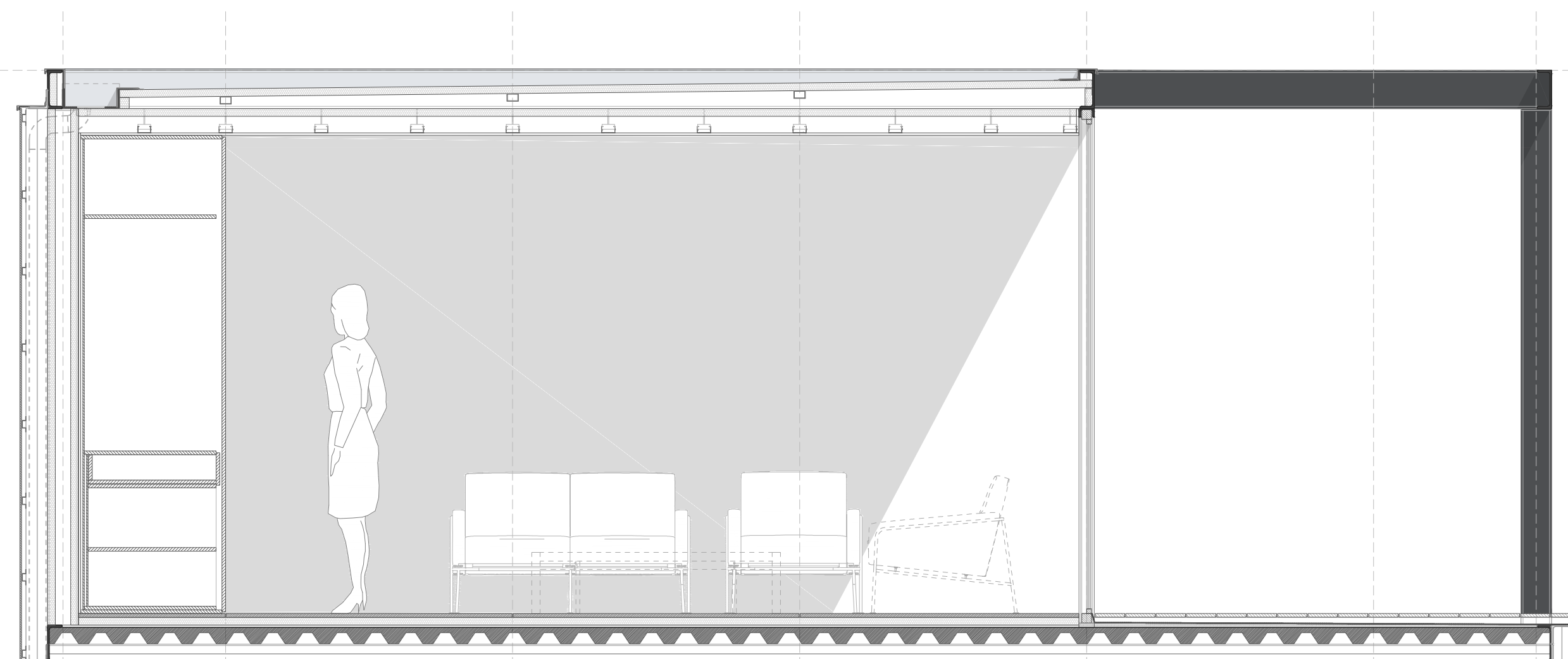
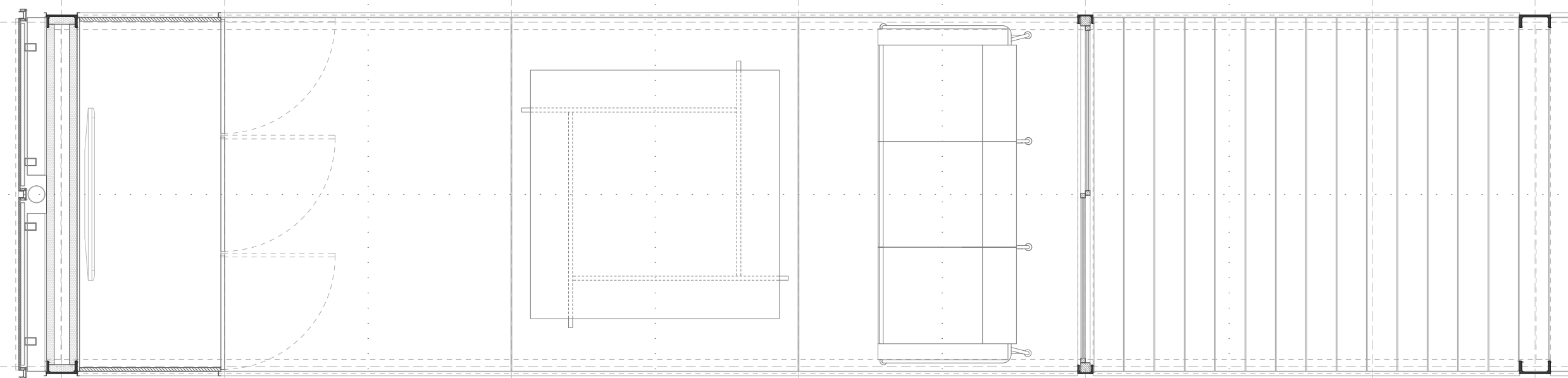
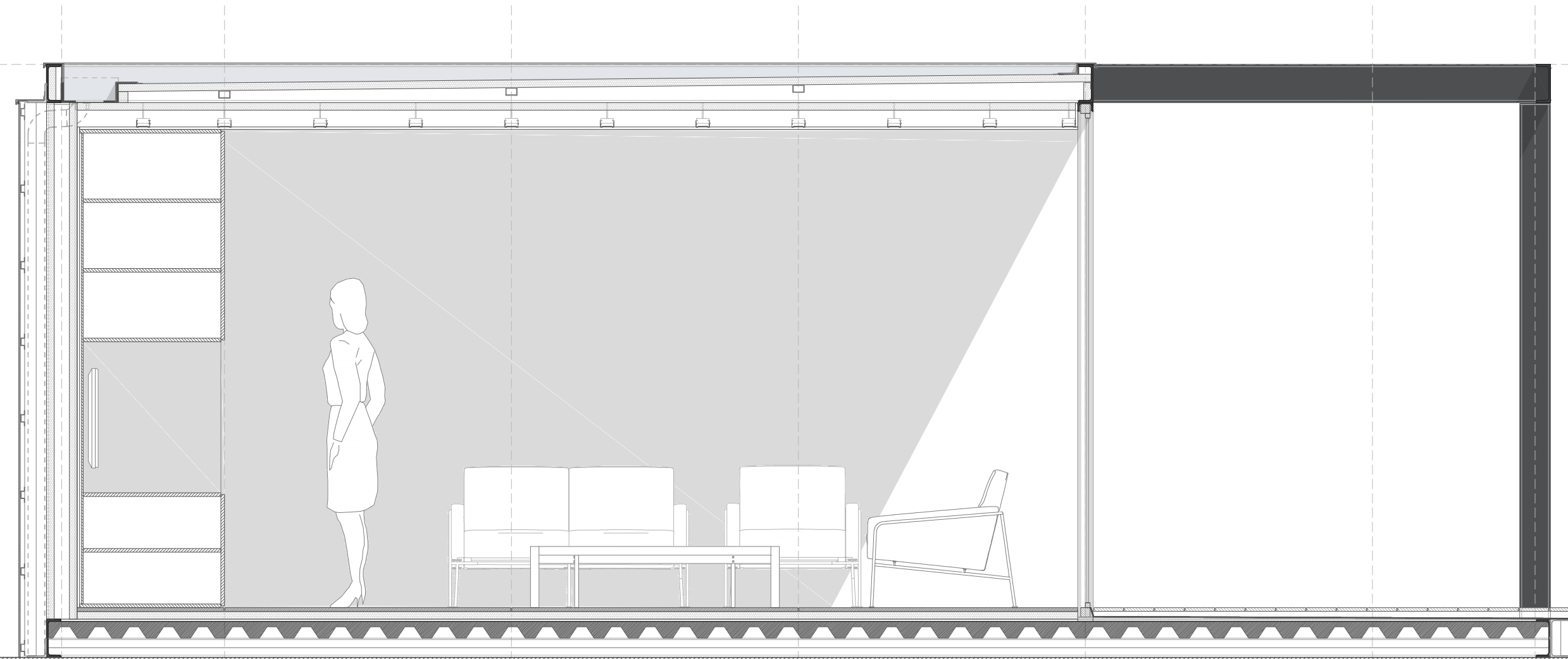



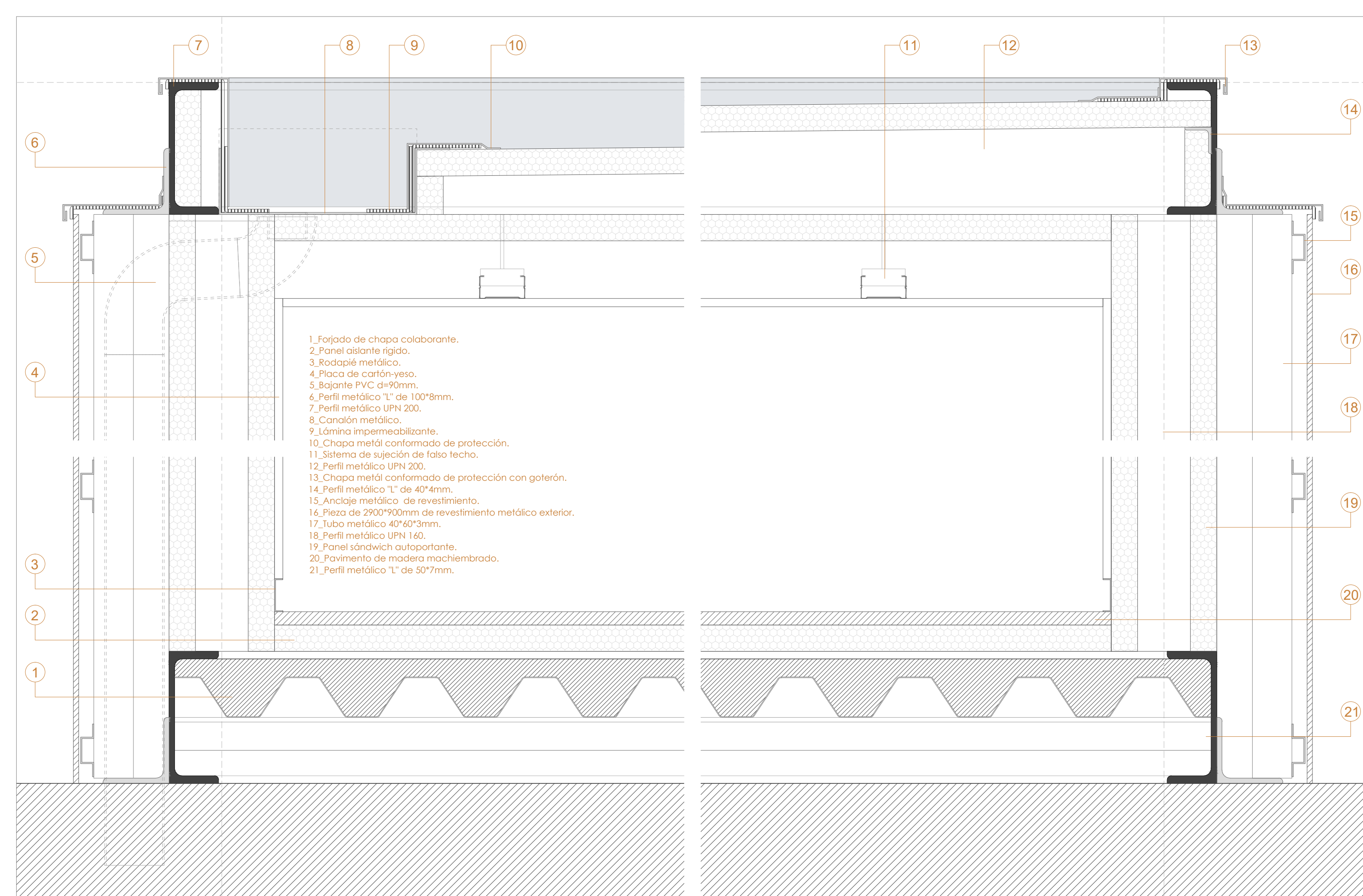

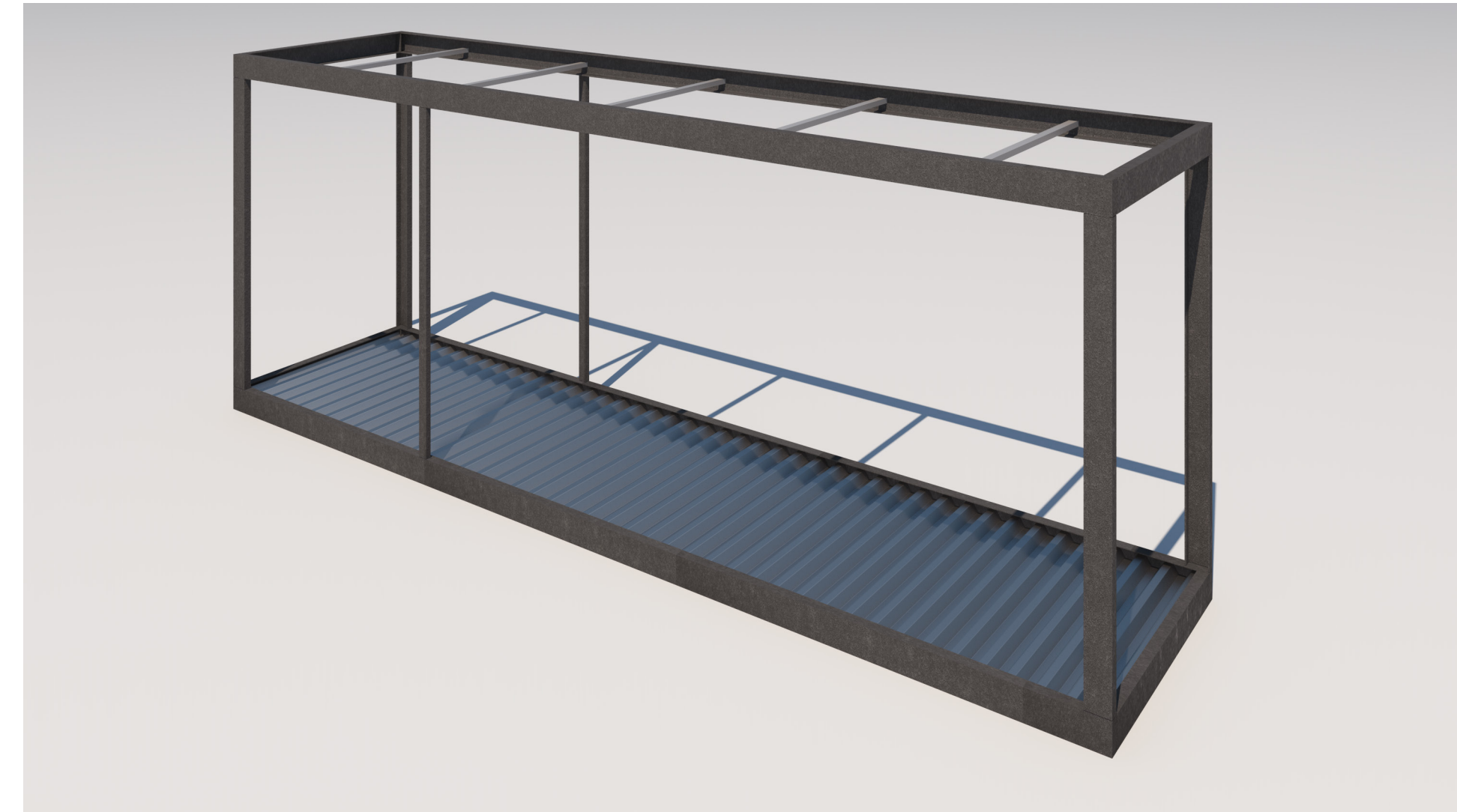
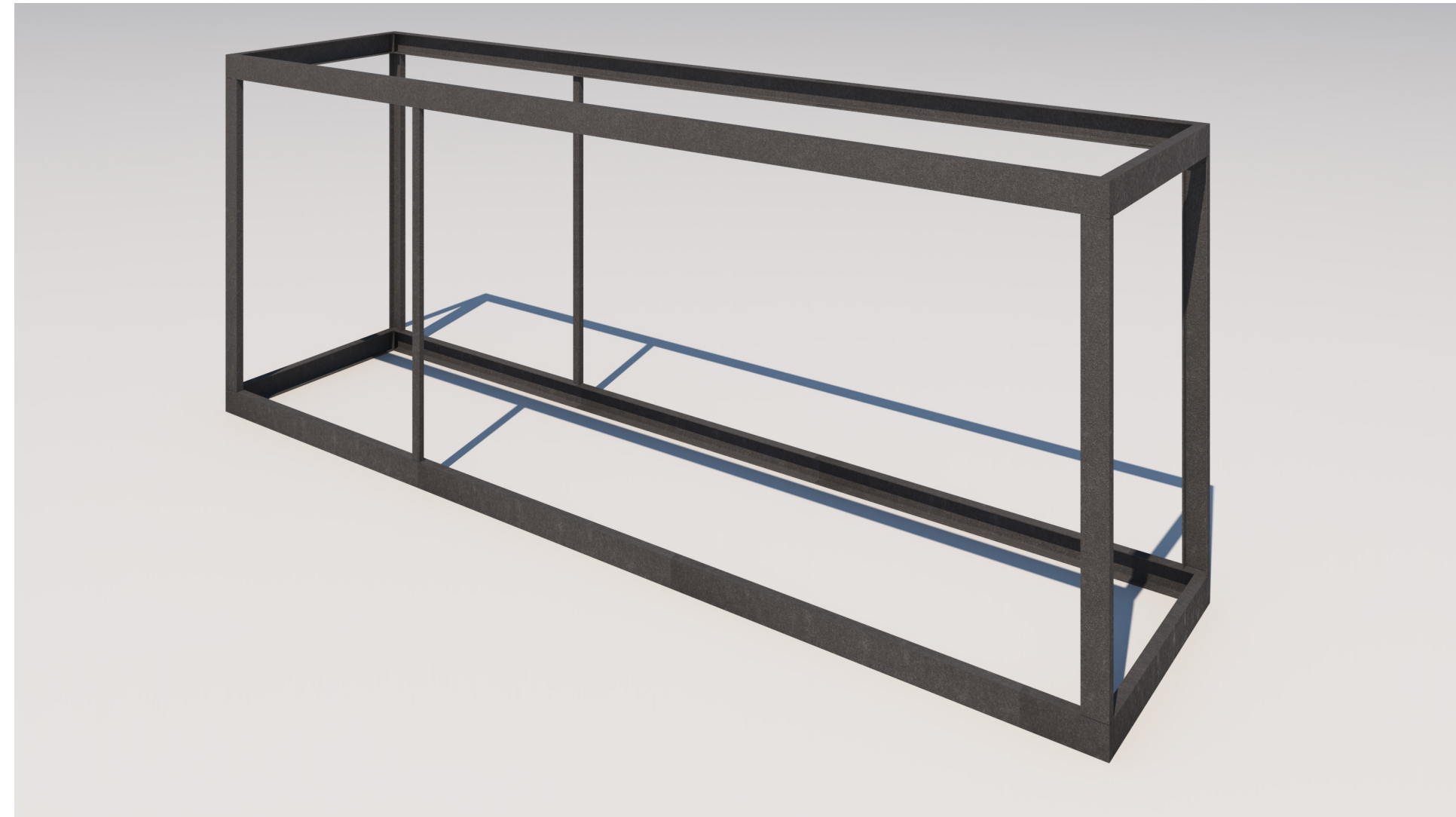

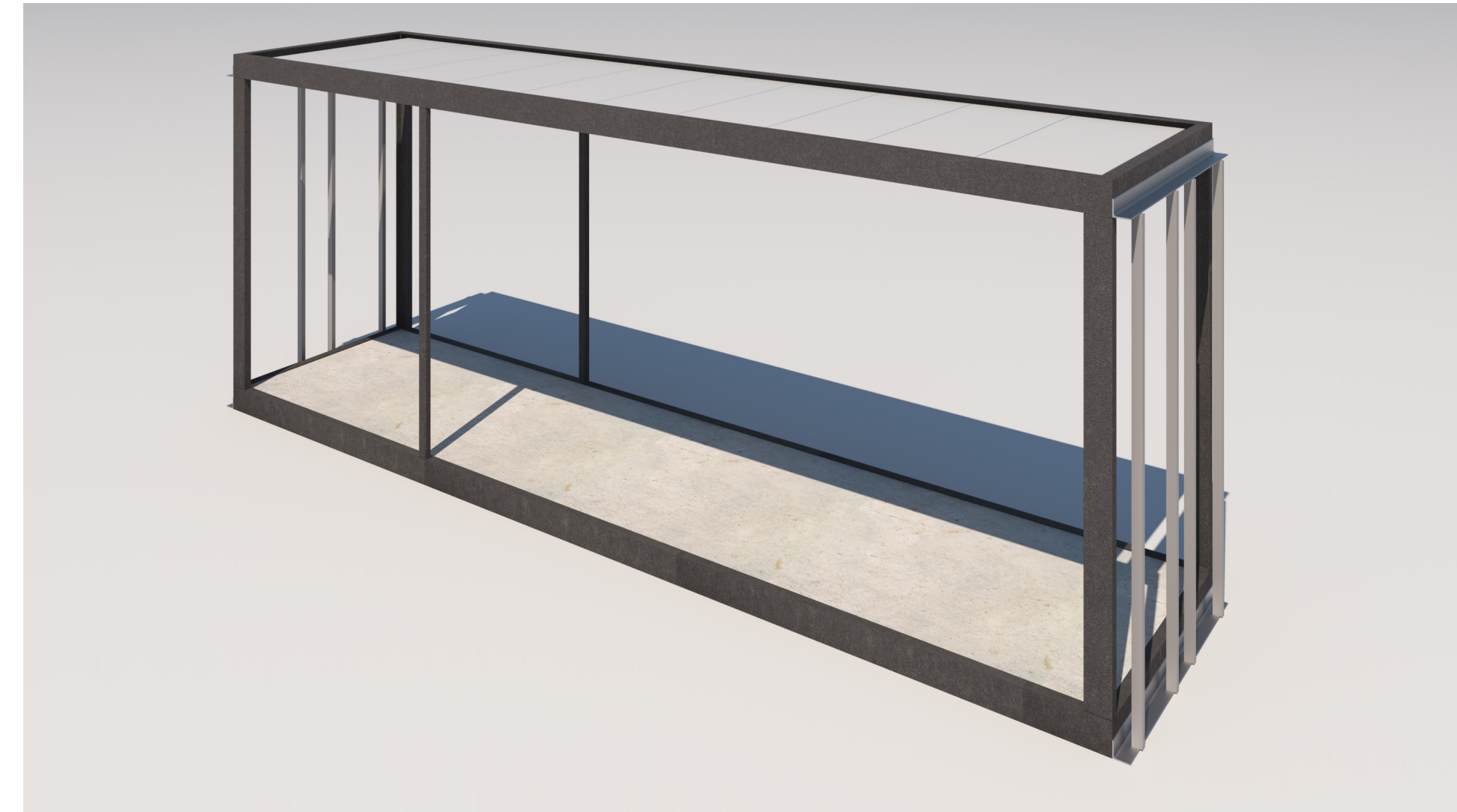
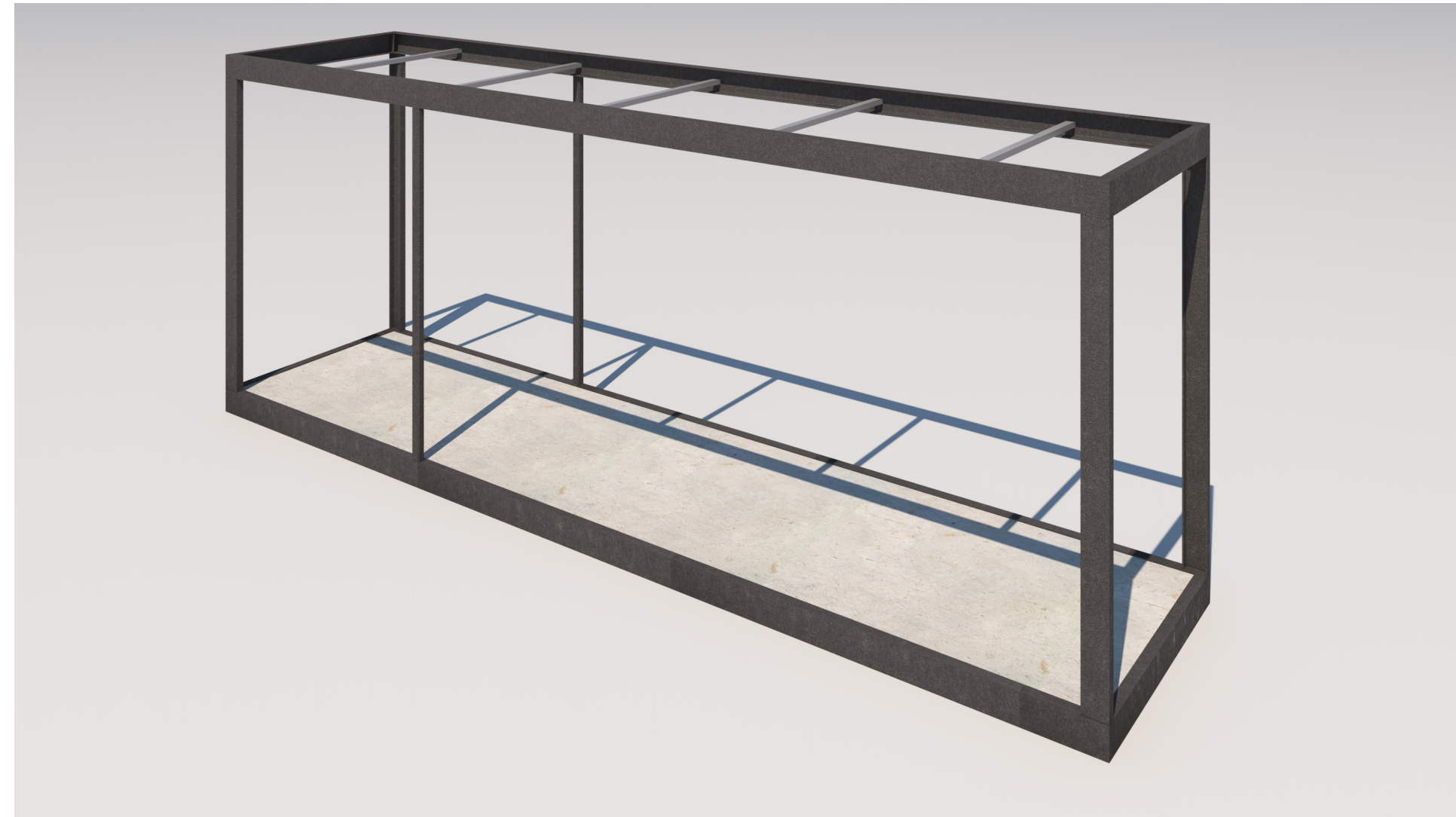



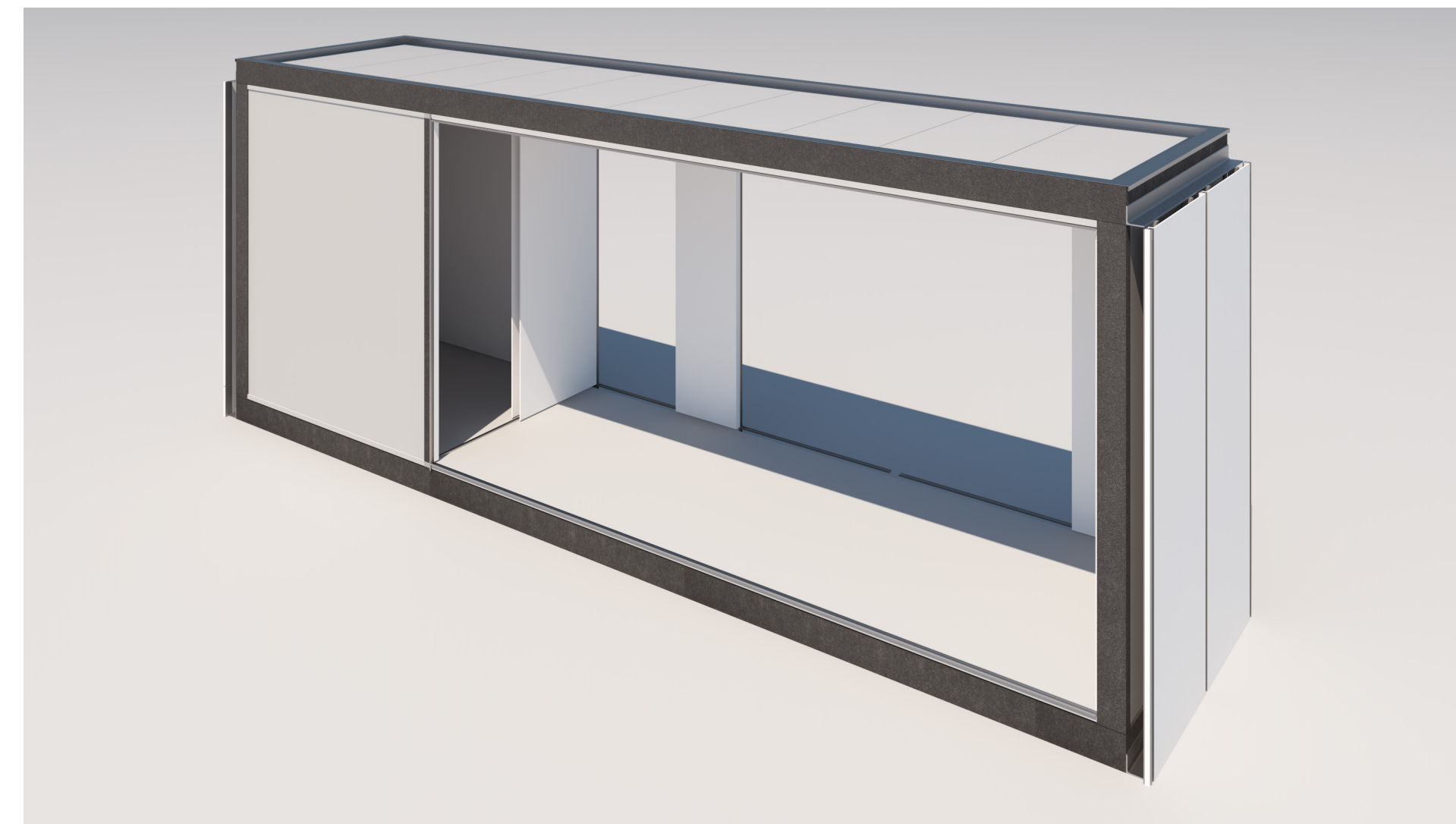
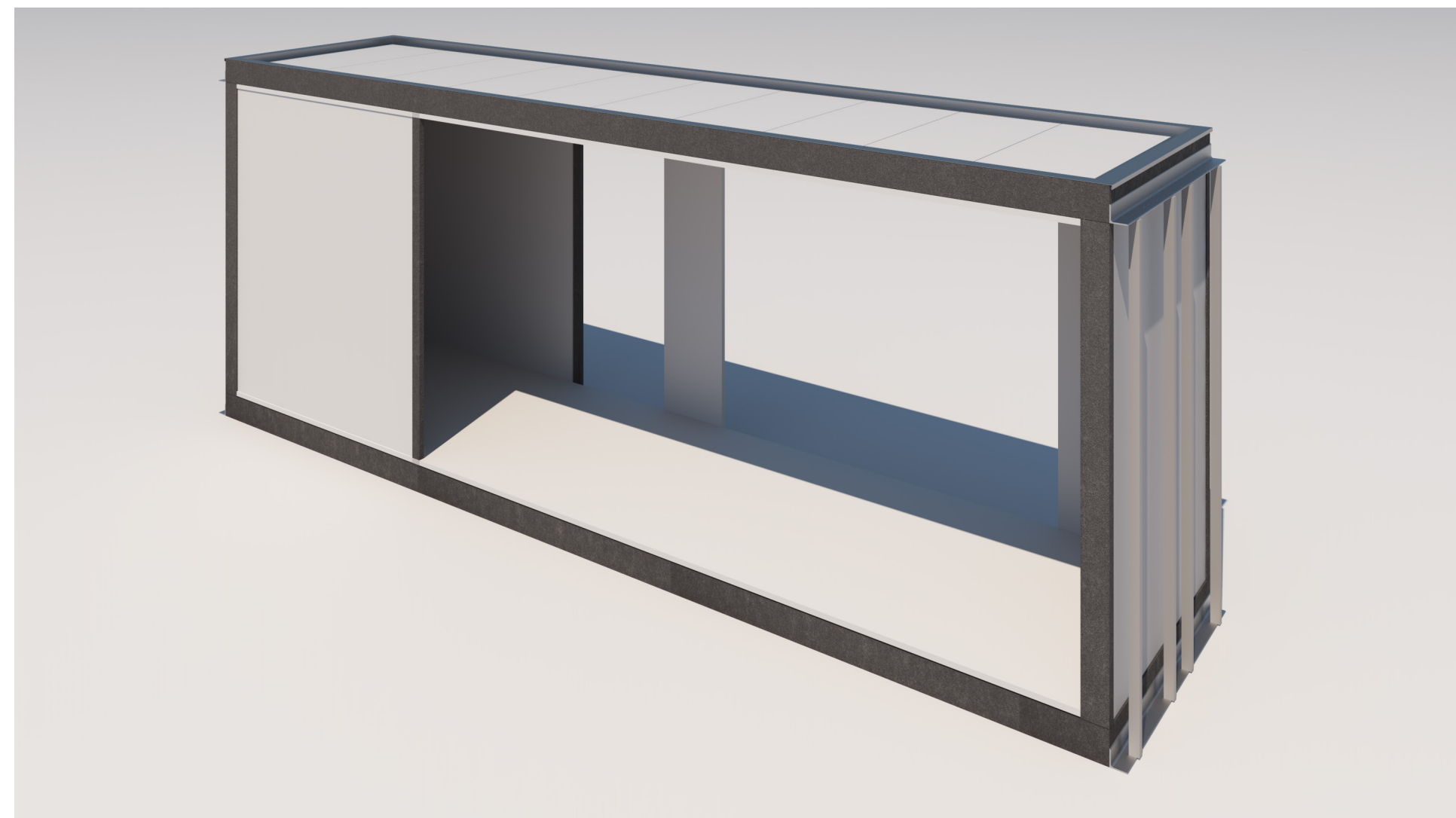

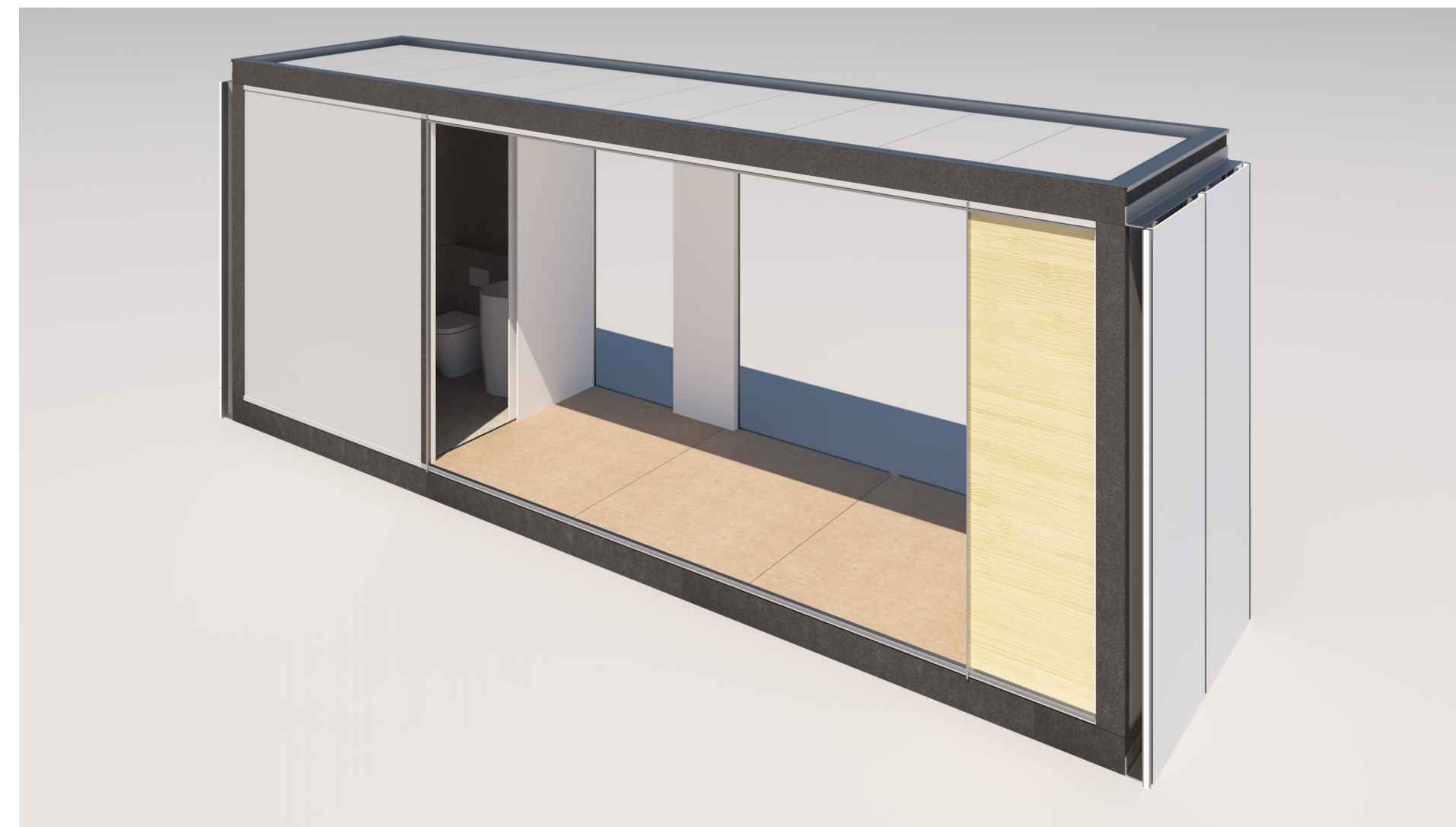
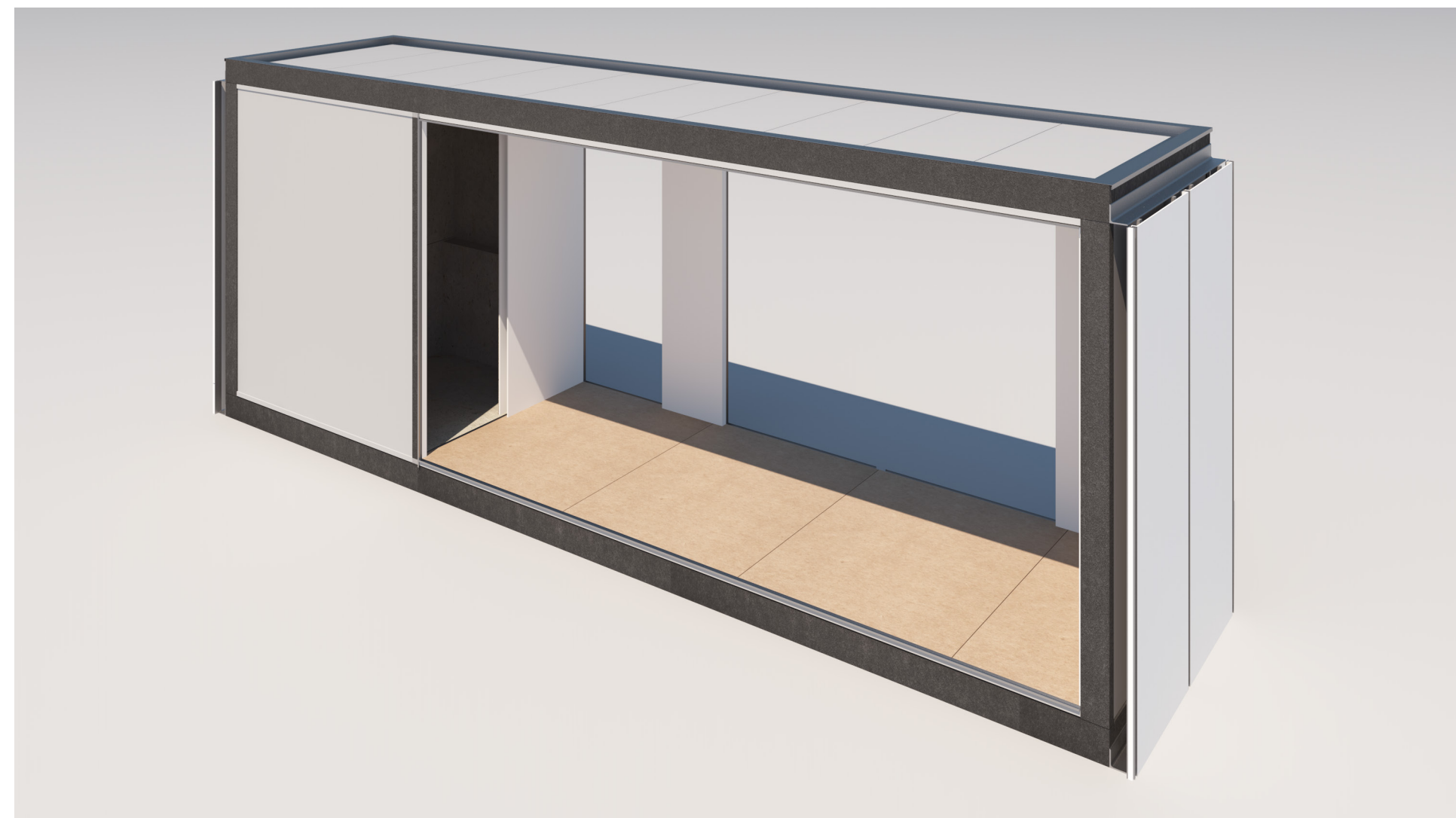

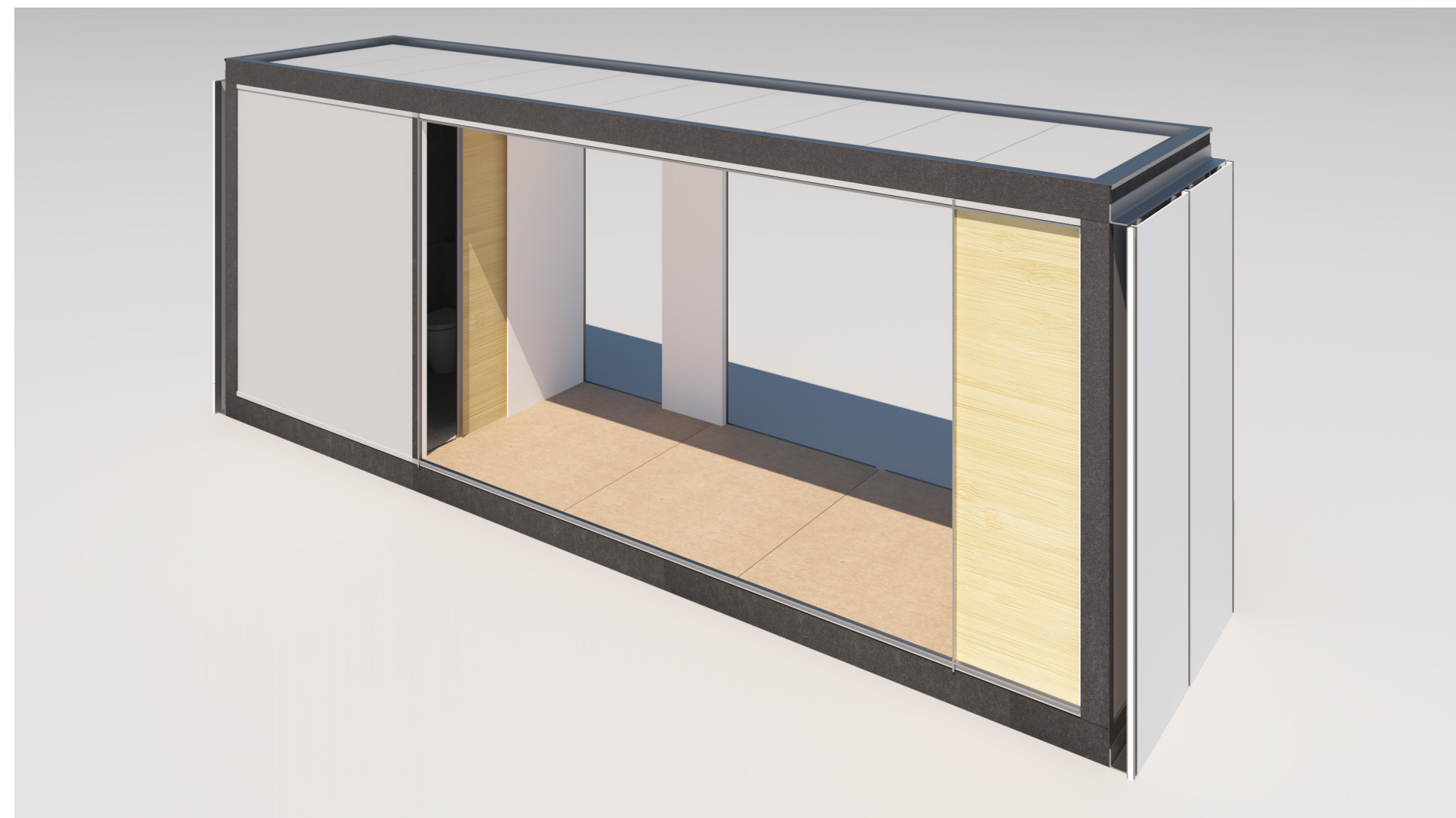



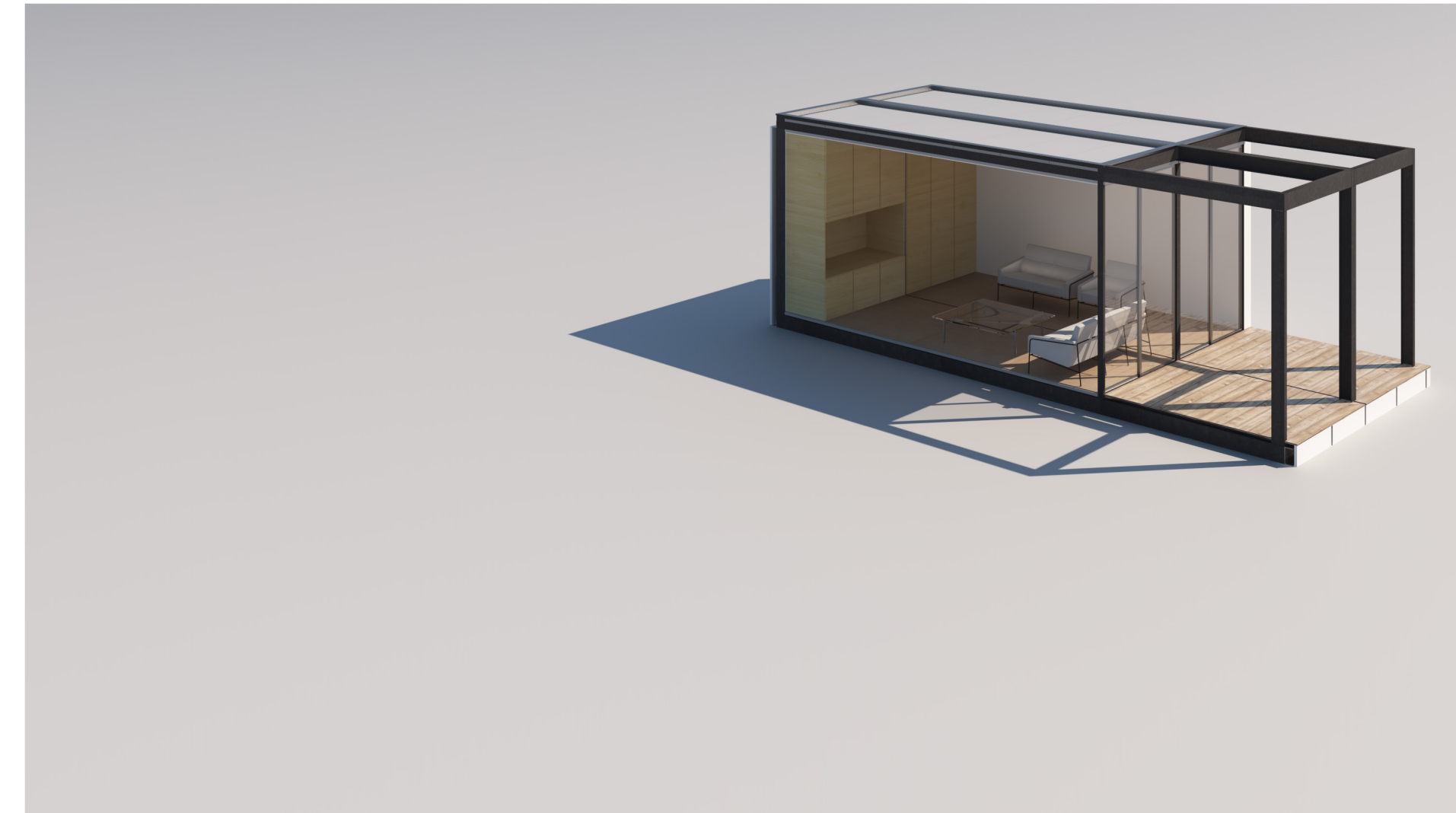
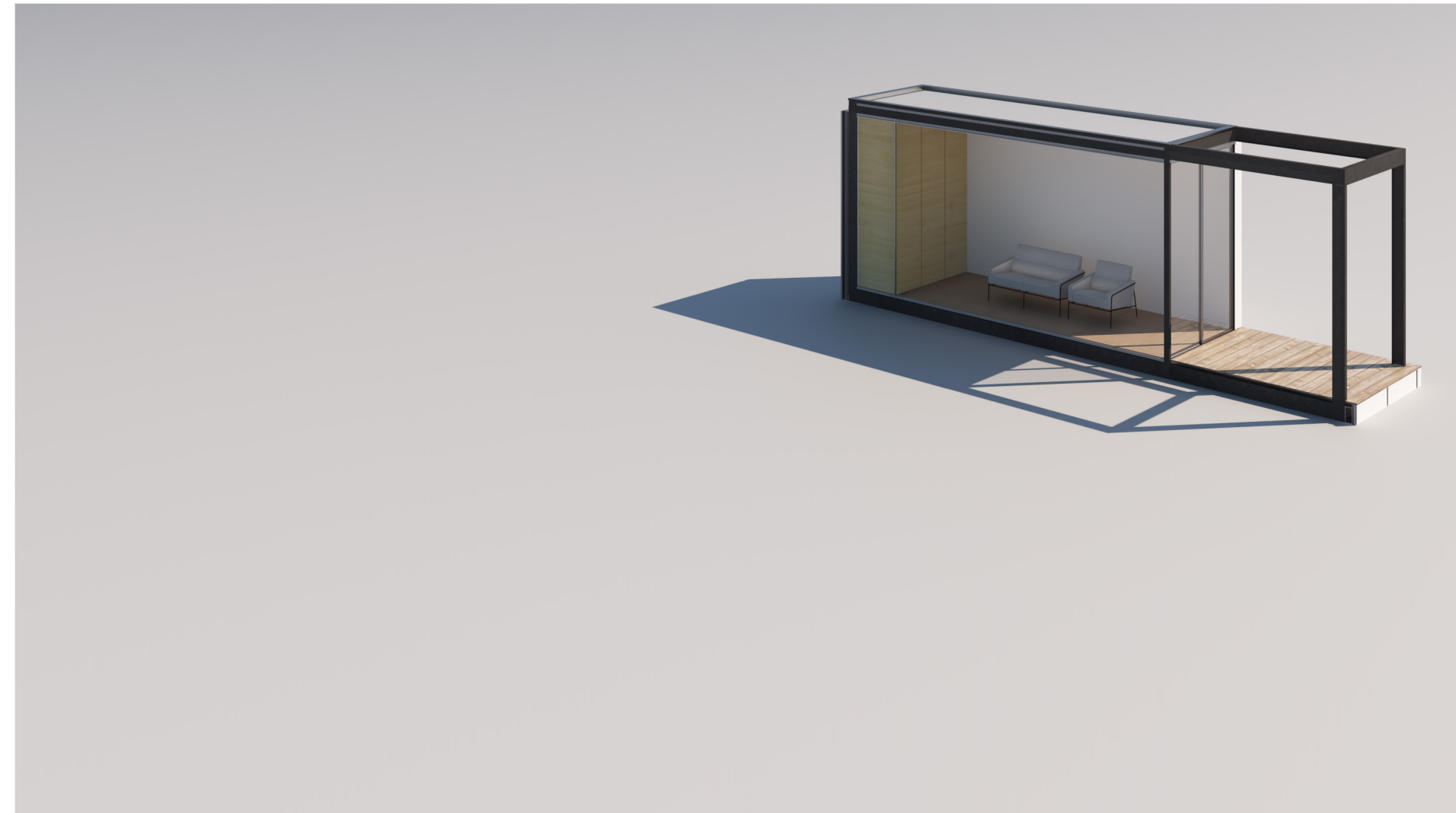

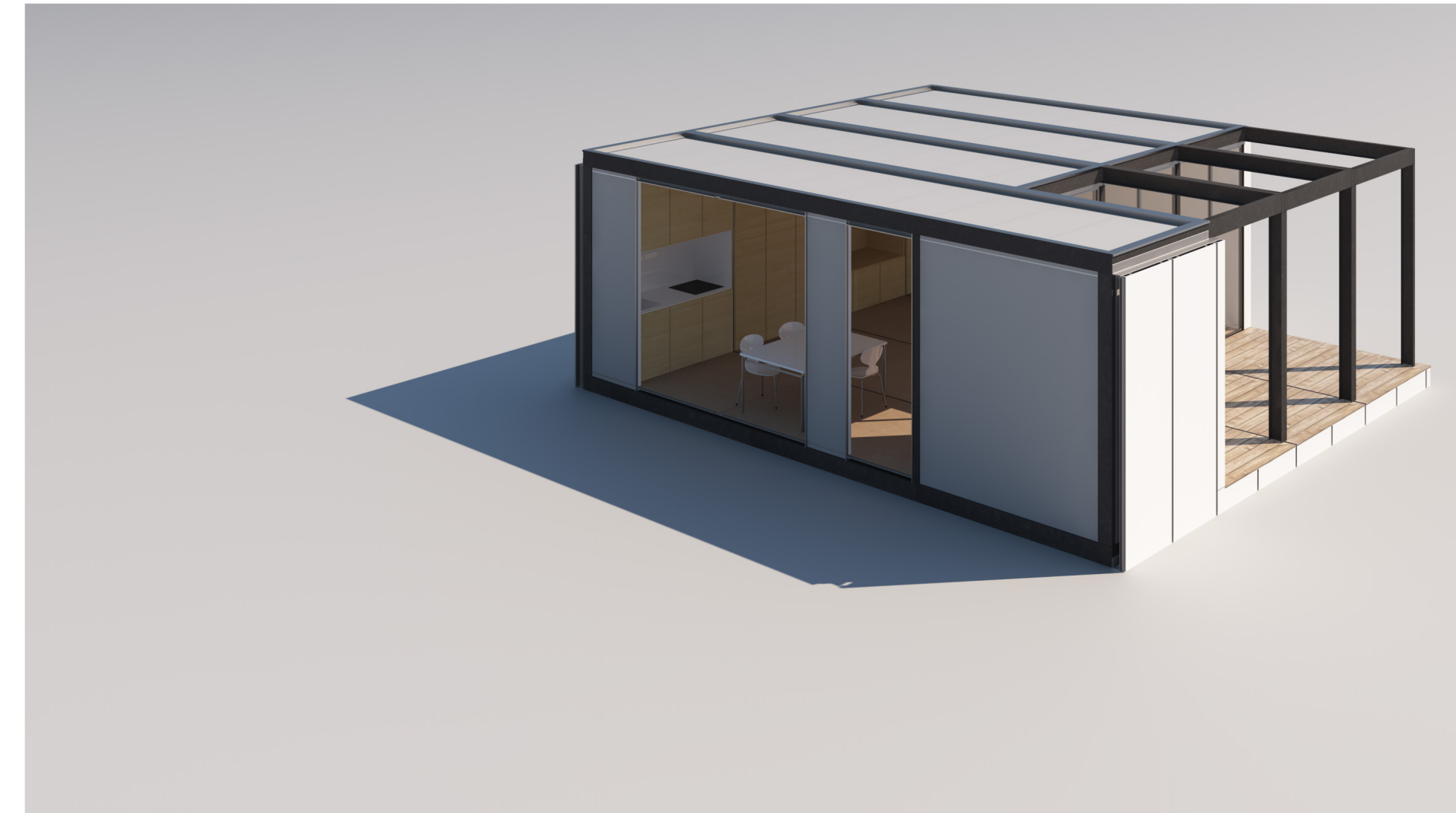
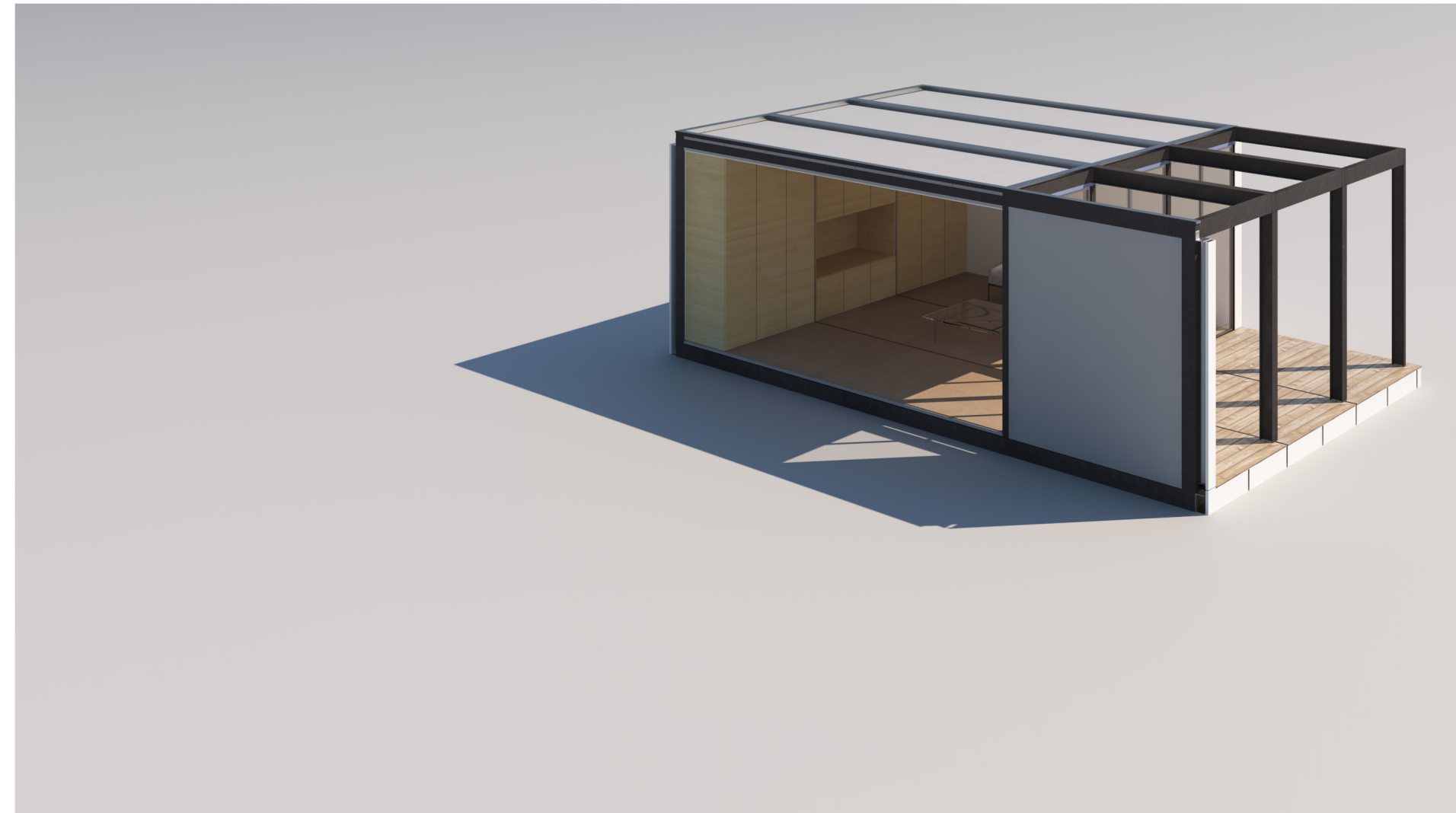

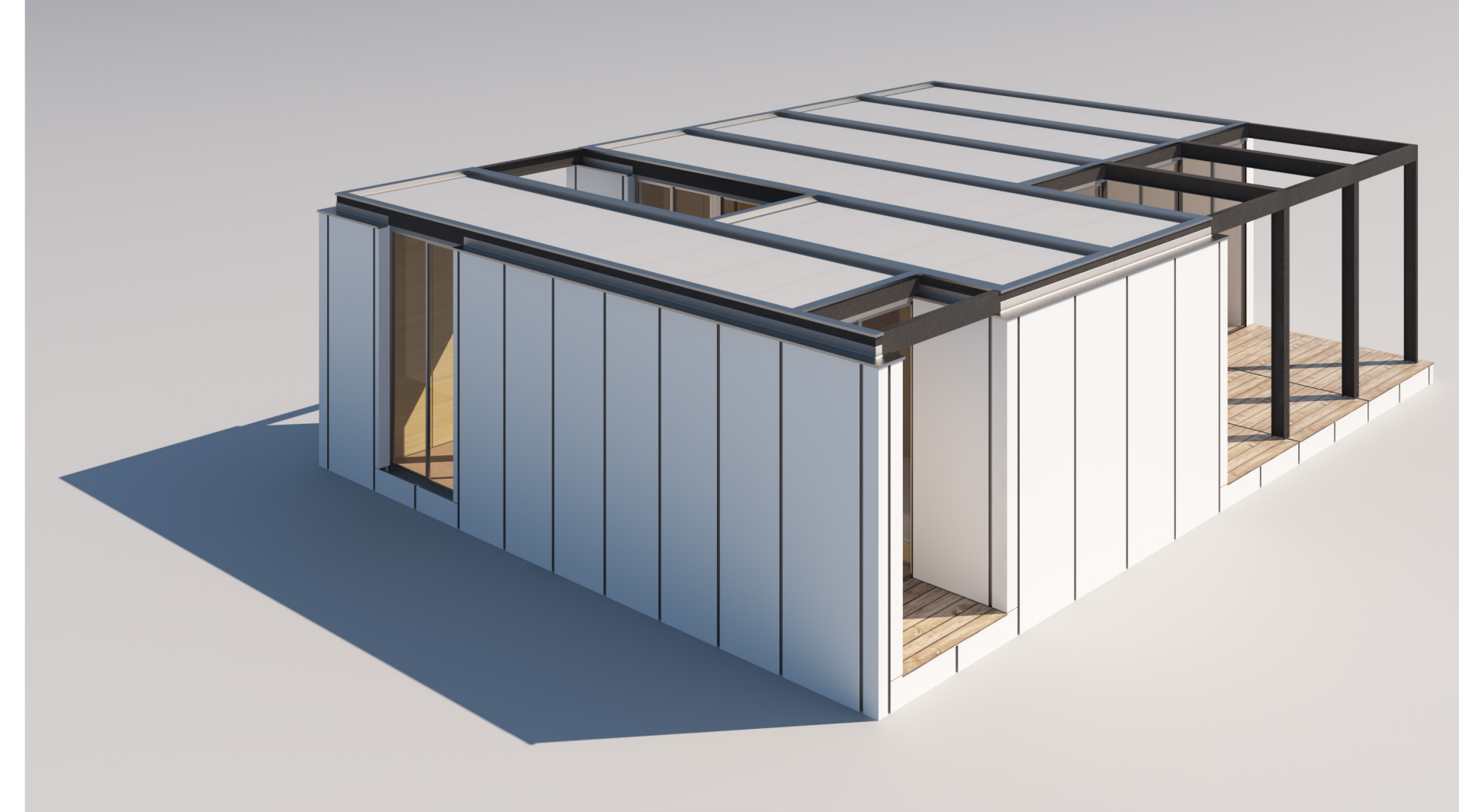
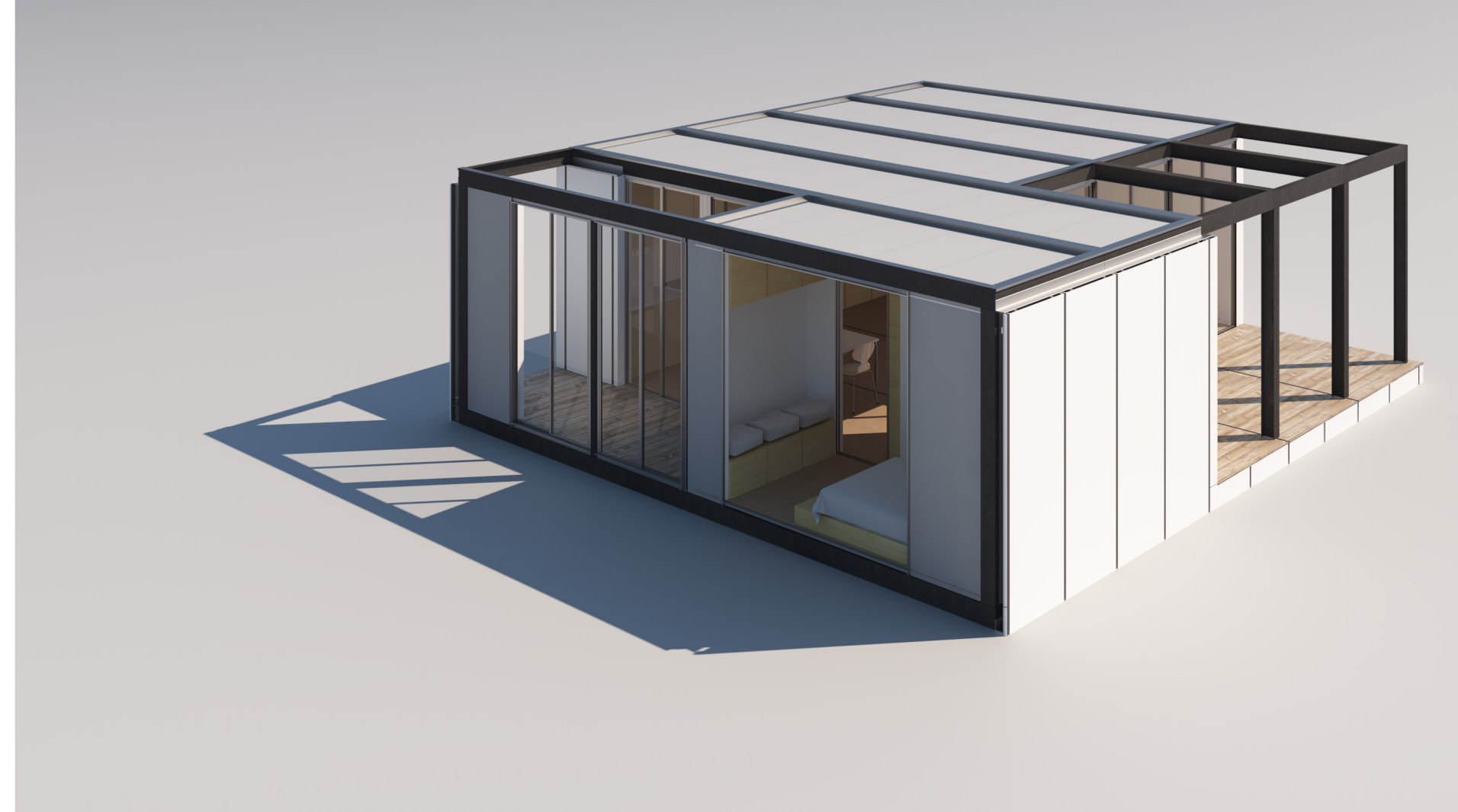

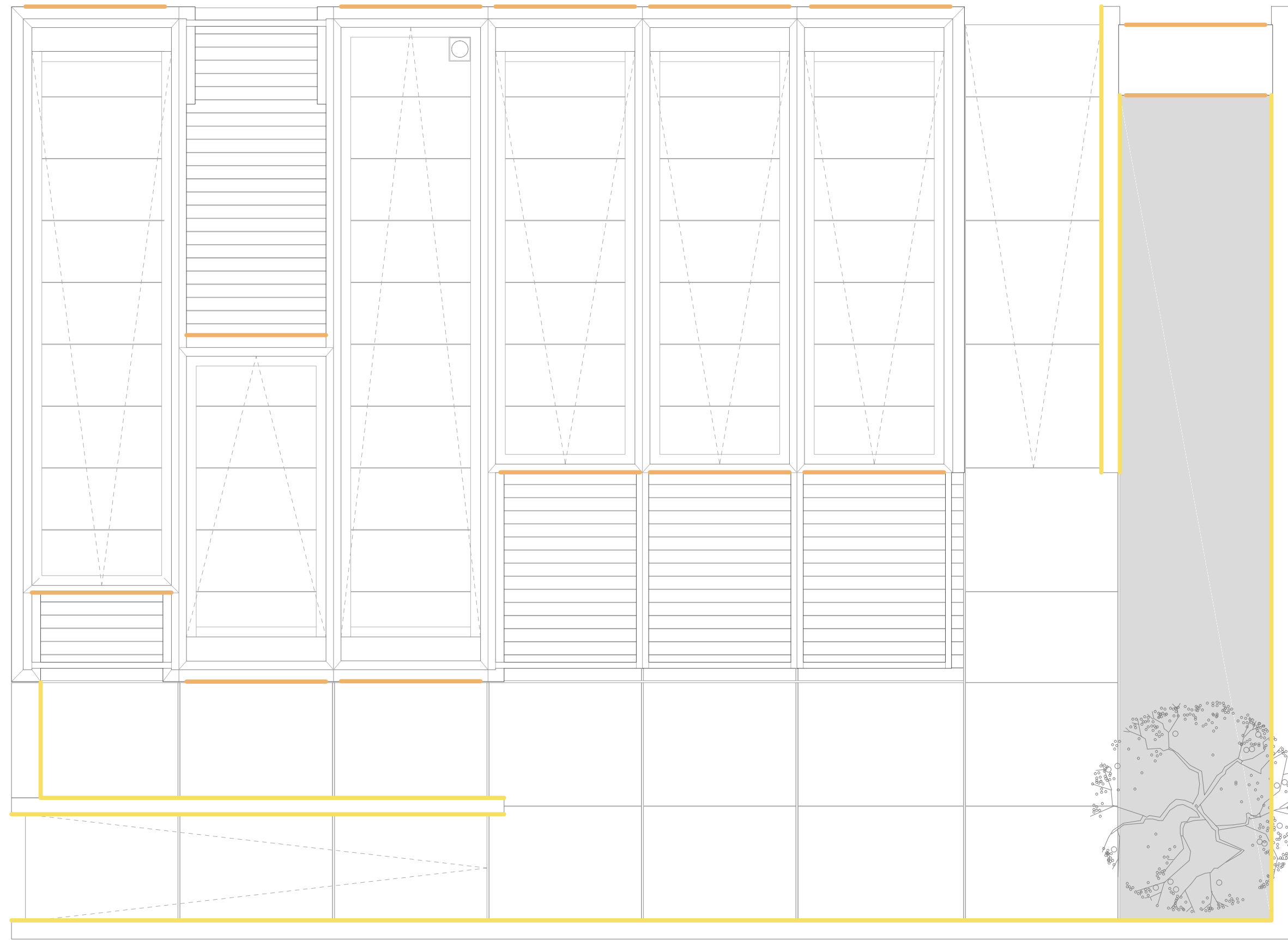

Iluminación lineal LED

Proyector empotrado exterior tubo LED

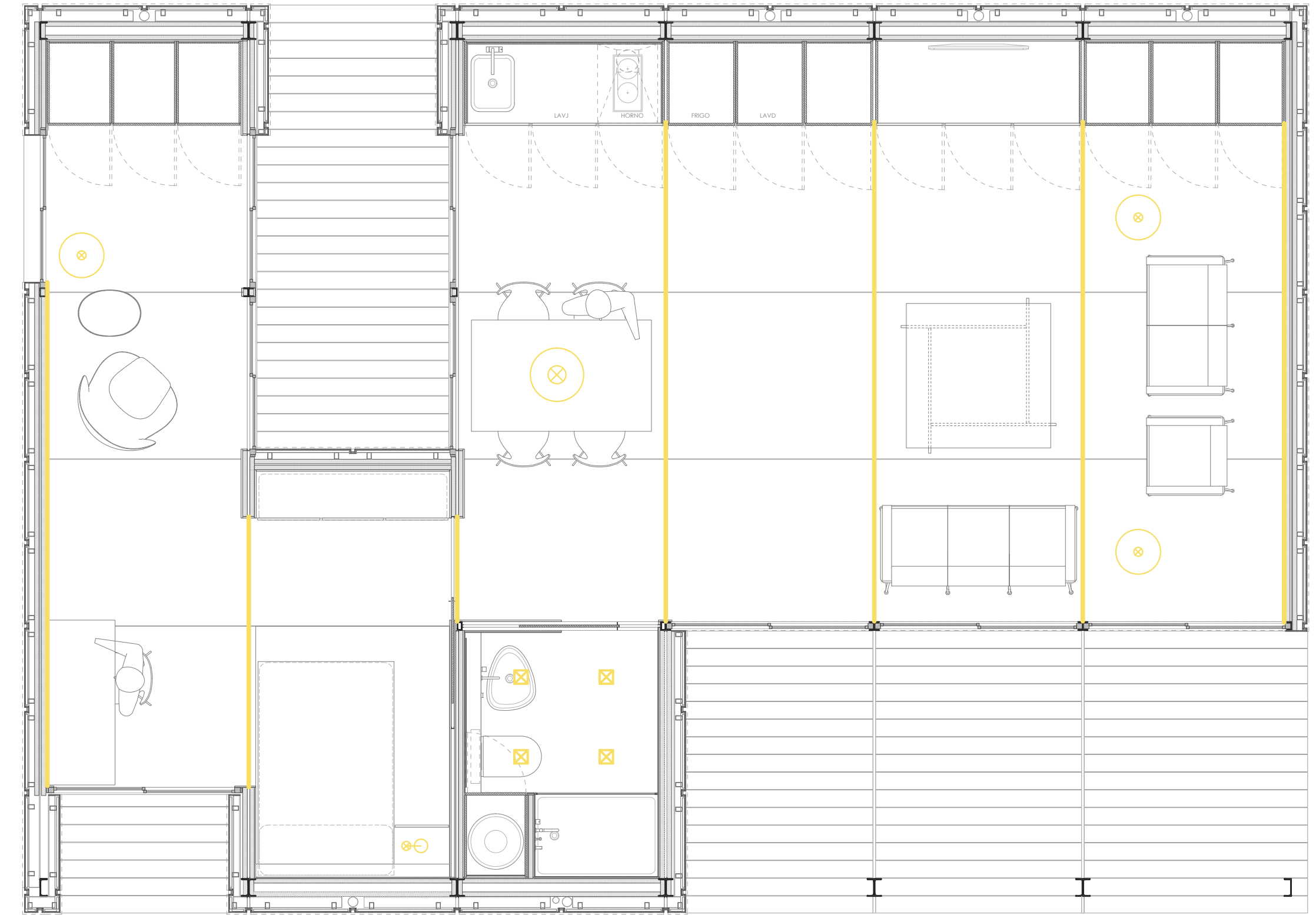

☒ FOCO LED EMPOTRADO EN TECHO

⊙ LAMPARA LED DE SOBREMESA

⊙ LUMINARIA EXENTA DE PIE  
LAMPARA LED

⊗ LUMINARIA SUSPENDIDA DE TECHO  
LAMPARA LED



