

**COVERAGE ESTIMATION FOR THE NEXT-GENERATION
DIGITAL TERRESTRIAL TELEVISION STANDARD ATSC 3.0:
LDM, CHANNEL BONDING AND MIMO**

Gerardo Lorenzo Cifuentes

Tutor: Narciso Cardona Marcet

Director 1: Jordi Joan Giménez Gandía

Director 2: David Gómez Barquero

Final Degree Thesis presented in the School of Telecommunications Engineering of the Universitat Politècnica de València, with the purpose of obtaining the Bachelor's Degree in Telecommunications Technology Engineering

Year 2015-16

Valencia, September, 13th, 2016

Resumen

Este trabajo viene motivado por la necesidad de desarrollar una metodología para la planificación de redes de televisión digital basadas en el nuevo estándar ATSC 3.0, que incluye una serie de tecnologías de transmisión avanzadas como son LDM, Channel Bonding y MIMO. Para ello, ha sido necesario estudiar y comprender el concepto y las características de dichas tecnologías y su implicación en la estimación de cobertura y la capacidad ofrecida.

Para cada una de las técnicas mencionadas, se han realizado estudios de planificación, utilizando una herramienta de estimación de cobertura de software libre llamada SPLAT!, y del IDE Spyder para el tratamiento de los resultados en lenguaje Python y su posterior exportación a mapas visibles en Google Earth. Las áreas de cobertura se han obtenido mediante cálculos de balance del enlace para recepción fija y portable y empleando umbrales de recepción para los distintos modos de transmisión.

Dichos estudios han sido realizados con datos reales de transmisores existentes en la ciudad de Atlanta, EEUU, y empleando mapas de elevación del terreno obtenidos del STS-99 Space Shuttle Topography Mission, tras haber validado un estudio base con los resultados presentados durante el proceso de estandarización de ATSC 3.0.

Resum

Aquest treball ve motivat per la necessitat de desenvolupar una metodologia per a la planificació de xarxes de televisió digital basades en el nou estàndard ATSC 3.0, que inclou una sèrie de tecnologies de transmissió avançades com són LDM, Channel Bonding i MIMO. Per a tal efecte, ha sigut necessari estudiar i comprendre el concepte i les característiques d'aquestes tecnologies i la seua implicació en l'estimació de cobertura i la capacitat oferida.

Per a cadascuna de les tècniques esmentades, s'han realitzat estudis de planificació, utilitzant una eina d'estimació de cobertura de programari lliure cridada SPLAT!, i del IDE Spyder per al tractament dels resultats en llenguatge Python i la seua posterior exportació a mapes visibles en Google Earth. Les àrees de cobertura s'han obtingut mitjançant càlculs de balanç de l'enllaç per a recepció fixa i portable i emprant llindars de recepció per als diferents modes de transmissió.

Aquests estudis han sigut realitzats amb dades reals de transmissors existents en la ciutat d'Atlanta, EUA, i emprant mapes d'elevació del terreny obtinguts del STS-99 Space Shuttle Topography Mission, després d'haver validat un estudi base amb els resultats presentats durant el procés d'estandardització de ATSC 3.0.

Abstract

This thesis is aimed for the necessity of developing a methodology of digital television networks planning based on the new standard ATSC 3.0, which includes a variety of advanced transmission technologies as LDM, Channel Bonding and MIMO are. With that purpose, it has been necessary study and understand the concept and characteristics of those technologies, and their implication in coverage estimation and offered capacity.

For each and every one of the techniques mentioned, planning studies have been made employing a free software estimation coverage tool called SPLAT!, and the IDE Spyder for treating the results in Python language and their subsequent exportation to Google Earth maps. The coverage areas have been obtained with link budget calculations for fixed and portable reception, and using reception threshold for the several transmission modes.

These studies have been performed with real data from existing transmitters in the city of Atlanta, USA, and employing terrain elevation maps from STS-99 Space Shuttle Topography Mission, after having validated a base study with the results presented during the ATSC 3.0 standardization process.

Index

Chapter 1.	Introduction	2
Chapter 2.	Objectives of the Thesis	3
Chapter 3.	ATSC 3.0. The Next Generation DTT Standard	4
3.1	General characteristics	4
3.2	Physical layer architecture	5
3.2.1	Input formatting	5
3.2.2	BICM	6
3.2.3	Framer and Interleaver	7
3.2.4	Waveform generation	8
3.3	Transmission Parameters Configuration	9
3.4	Advanced Transmission Technologies in DTT	10
3.4.1	LDM	10
3.4.2	Channel Bonding	11
3.4.3	MIMO	14
3.5	DVB-T2 comparison	16
Chapter 4.	DTT Planning Methodology	18
4.1	Tools	18
4.1.1	SPLAT!	18
4.1.2	Spyder and Python 's code use	24
4.1.3	MATLAB	28
4.2	Calculations	31
4.2.1	Fixed reception	33
4.2.2	Portable reception	34
4.3	Validation of methodology	35
Chapter 5.	Simulation scenarios	38
5.1	Sites information	38
5.2	LDM and TDM comparison	40
5.3	Channel Bonding	43
5.3.1	Plain Channel Bonding	44
5.3.2	SNR Averaging	49
5.4	MIMO	50
Chapter 6.	Results and discussions	56
Chapter 7.	Conclusions	63
Chapter 8.	Future trends	64
Chapter 9.	Bibliography	65

Chapter 1. Introduction

The growing development of wireless technologies makes it absolutely necessary to guarantee enough transmission capacity for delivering a large number of high-quality services. The improvement of the multimedia contents, with the emergence of cutting-edge technologies, such as 4K UHD TV or the new video coding standard HEVC, is pushing the limits of networks capacity.

In the digital terrestrial television (DTT) case, the importance of improving the spectral efficiency is paramount in order to keep DTT as an attractive and competitive platform with regards to other wireless or cable-based solutions. The digital dividend as a result of the migration of analog to digital television which involves the release of television broadcasting spectrum to the fourth generation mobile broadband services, 4G (800 MHz UHF band, and the upcoming release of the 700 MHz band) has limited the spectrum dedicated to terrestrial broadcasting. Therefore, the enhancement of DTT involves the duty of improving spectral efficiency with the proposal of broadcasting high-rate services in a reduced space in frequency.

Thus, recent digital television standards are focused in enhancing these two transmission aspects, as the ATSC 3.0 case is. This standard developed by the Advanced Television Systems Committee considers these necessities, being possible broadcasting 50 Mb/s rates for the purpose of receiving the best definition contents available nowadays, and having great flexibility with the service wanted to be offered.

In addition, some novel transmission techniques have been developed, in particular different multiplexing modes never implemented at any digital television network. Such technologies are LDM (Layered Division Multiplexing), which permits the allocation of mobile and fixed services in a power-divided manner; Channel Bonding, which makes possible the use of two independent RF channels for a single data stream; and MIMO, which implementation in ATSC 3.0 is based on 2x2 cross polarization antennas approach.

Some simulation scenarios of implementable and coherent cases have been carried out in this thesis in order to assess these technique performances. For that purpose, a validated digital television planning methodology has been developed. Starting from the services wanted to be broadcast and their broadcasting parameters, comparable coverage maps have been obtained for checking the performance and improvements of the use of these brand new techniques introduced in the ATSC 3.0 standard.

Chapter 2. Objectives of the Thesis

The primordial objective of the studies accomplished in this thesis is the assessing of the coverage estimation of new ATSC 3.0 digital television standard transmission techniques: LDM, Channel Bonding and MIMO.

With the determination of achieving the main objective, the following secondary objectives are considered:

- To analyze of the current digital television network coverage estimation methodology.
- To conduct some coverage exercises with the ATSC 3.0 standard and check with previous examples elaborated in the standardization process.
- The study of the new ATSC 3.0 transmission techniques and their coverage implication for implementing real exercises.
- To propose a methodology and concrete study cases to estimate the coverage with those techniques
- To perform first coverage exercises with these techniques with the purpose of estimating their effect in the digital television network implementation.

Chapter 3. ATSC 3.0. The Next-Generation DTT Standard

3.1 General characteristics

ATSC 3.0 is the brand new Digital Terrestrial Television standard developed by the Advanced Television Systems Committee (ATSC). This specification has no compatibility with the already implemented ATSC A/53, known as ATSC 1.0. It provides at least a 30% increase in capacity with the same Signal to Noise ratio (SNR) beyond the previous standard. Consequently, it is destined to be the reference in television broadcasting technology all over the world.

This standard is based on the application of Orthogonal Frequency-Division Multiplexing (OFDM), and the use of linear error correcting code LDPC (Low Density Parity Check).

The physical layer is implemented for providing much more robustness, flexibility and efficiency than the previous standards due to the great technological changes, as non-uniform constellations, more robust LDPC improved codes or technologies such as LDM (Layered Division Multiplexing).

That fact allows broadcasting where a great amount of parameters can be chosen. It can be combined twelve code rates, six modulation orders, sixteen pilot patterns, twelve guard intervals and two types of time interleaving. There are also three multiplexing modes: in the time (TDM), frequency (FDM) and the already mentioned, layered (LDM) domains. In addition, three different types of antenna schemes can be used, as SISO (Single Input Single Output), MISO (Multiple Input Single Output) and MIMO (Multiple Input Multiple Output).

The results of that selection of parameters can be from a very robust noise-immune signal with a rate of 800 Kb/s (6 MHz bandwidth, 8K FFT size, 4-QAM modulation with a 2/15 code rate and a large 300 μ sec guard interval); to a very less robust signal but with a higher rate (32K FFT size, 4096-QAM modulation, 13/15 code rate and a short guard interval of 28 μ sec), providing a 57 Mb/s rate.

ATSC 3.0 allows the parallel decoding of four PLPs (Physical Layer Pipes) per service, which can have different levels of robustness for video, audio or metadata, being 64 the maximum number if they are time multiplexed. In respect of the SNR, the range is from -5.7 dB to 36 dB in a Rayleigh channel representing portable coverage, and -6.2 dB to 32 dB in an AWGN channel, used for fixed service.

The aim of all these configurations is to provide both mobile and fixed television service at the same time, including the rooms in a house, mobile devices or even vehicular reception.

3.2 Physical layer architecture

The architecture is featured by four main parts: input formatting, bit interleaved and coded modulation (BICM), interleaving and framing, and, at last but not least, the waveform generation. The diagram, specifying the process involved in each part, is shown in the next figure.

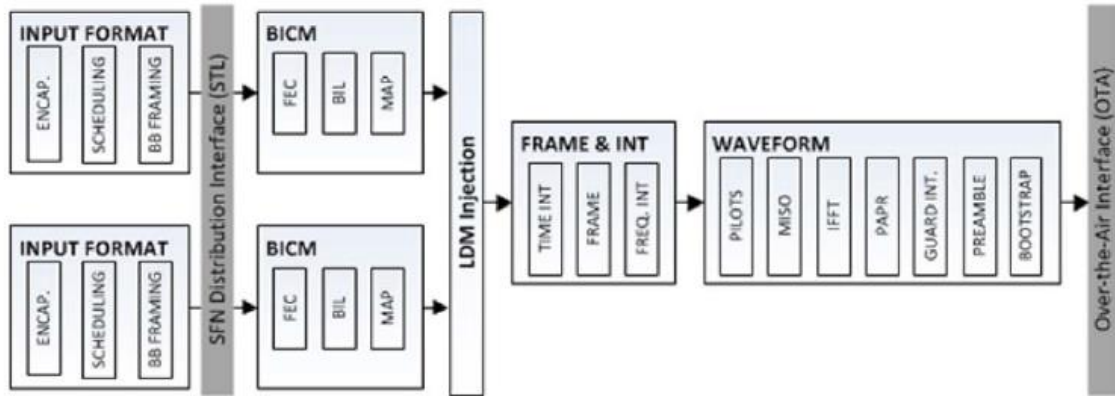

Figure 1. Block diagram of the ATSC 3.0 physical layer in a single RF channel. [1]

3.2.1 Input formatting

This part is formed by three important parts: encapsulation and compression, the Scheduler, and the baseband framing.

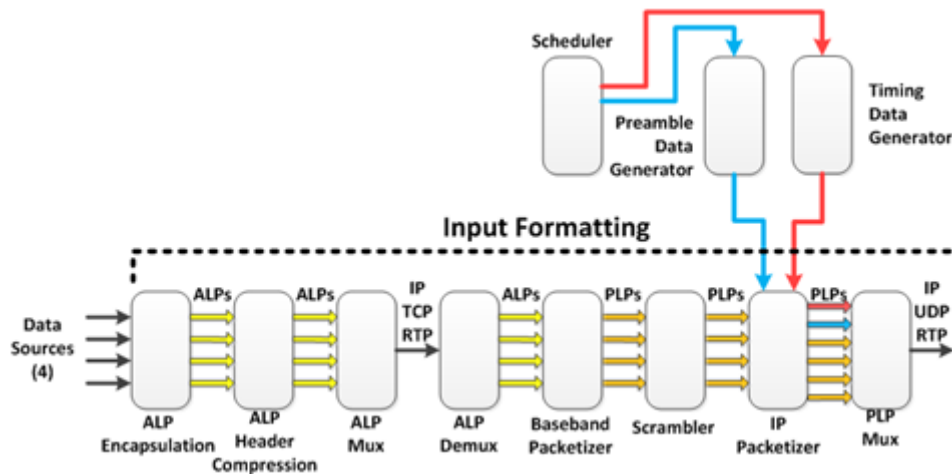

Figure 2. Block diagram of the Input formatting module. [2]

The input formatting encapsulation is based on the use of ALP or ATSC Link-Layer Protocol. This protocol belongs to the second or data-link layer in the OSI layer model, which is formed by a total of seven. ALP provides independence and interoperability between platforms, being able to manage different types of data, as IP packets, signaling packets as RTP or even MPEG-2 TS frames used in DVB-T2.

Afterwards, an encapsulated data stream is given to the Scheduler, and then it behaves both as a multiplexer, and as a baseband configuration manager helped by a system control function. This Scheduler is in charge of managing how ALP encapsulated packets are placed in physical layer resources, obviously limited by the system buffering model and by the defined PLPs.

In respect of the baseband framing, three processes have to be into account: the baseband packet construction, the baseband packet header and the scrambling, as it can be seen below.

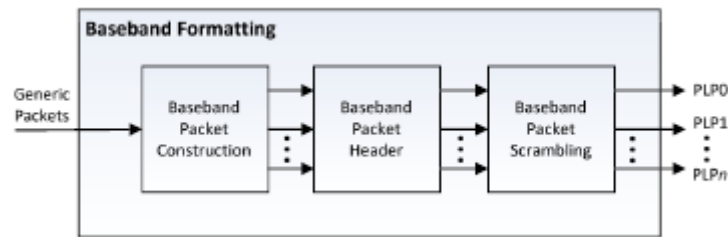

Figure 3. Block diagram of baseband formatting. [1]

Every frame has a fix length defined by the code rate and the length chosen for each PLP.

3.2.2 BICM

After the input formatting, the entire information is sent to the BICM, where FEC (Forward Error Correction) use, bit interleaving and constellation mapping is produced as it is shown in the next diagram.

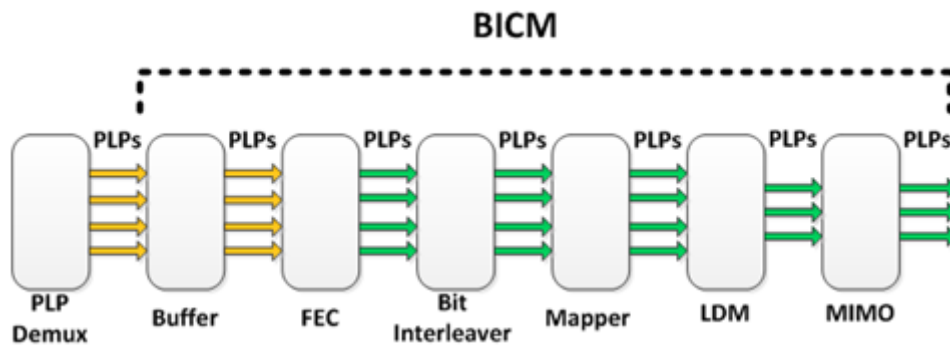

Figure 4. Block diagram of BICM module. [2]

The input of this module is the baseband frame; moreover the output is a FEC frame, formed by the concatenation of the input packet content, in addition to the parity data for FEC error correction, which is formed by an inner code and an outer code.

The inner code feature an LDPC code that provides redundancy in order to get the correct reception of the baseband packets transmitted, whereas the most outer code used is the BCH (Bose,Ray-Chaudhuri and Hocquenghem code), which has error corrections, and also provides detection.

The baseband packet length is determined by the code length and each LDPC code rate, while the FEC frame length only depends on the LDPC code length.

As far as the bit interleaving block, it is said that is formed by a parity interleaver, a group-wise interleaver and a block interleaver as it can be seen in the diagram below.

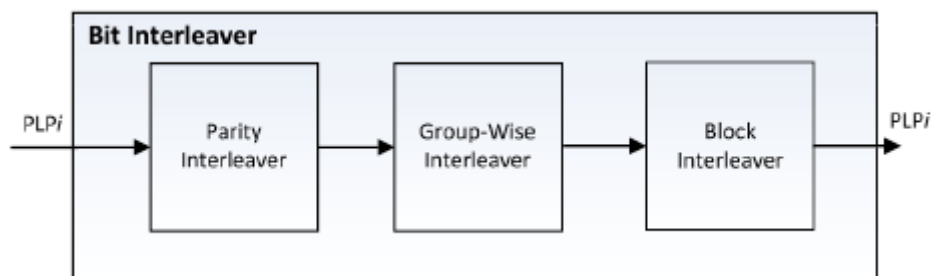

Figure 5. Block diagram of bit interleaver block. [1]

In conclusion for this module, the constellation mapping is produced. Six different orders are defined: a uniform QPSK modulation and five non-uniform, from 16-NUC to 4096-NUC. The non-uniform constellation mapping (NUC) is a method where symmetric QAM constellations are modified in a proper way to close the gap to Shannon limit. This improves noise robustness and minimizes the symbol error rate.

LDM and MIMO modules will be explained in their related section where those technologies are used.

3.2.3 *Framer and Interleaver*

This module features a time interleaver, a framer and the frequency interleaver, as it is shown in the next figure.

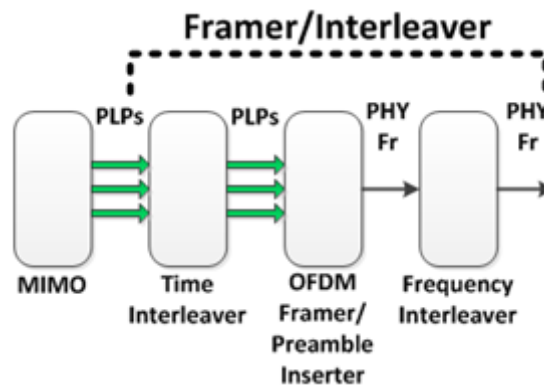

Figure 6. Block diagram of Framer and Interleaver module. [2]

The input of this module is about multiples PLPs, whereas the outputs of the framer are OFMD symbols.

The output of the previous module goes to the time interleaver with the purpose of widening the data through the time to mitigate desynchronized channel errors. For a single PLP use, the information can be widened for certain period of time using a convolutional interleaving; while in a more than one PLP use, it is mandatory the utilizing of an hybrid convolutional-block interleaving in the way shown in the next figure.

The time interleaving memory is about 2^{19} memory units.

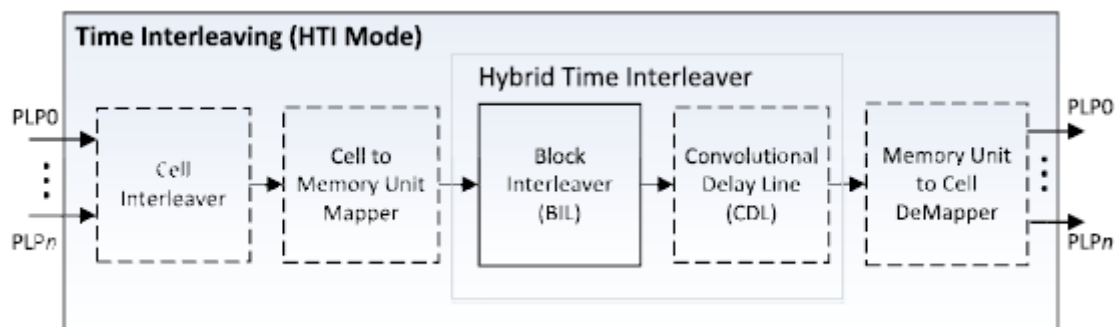

Figure 7. Block diagram of hybrid time interleaving . [1]

Regarding the framer, as it has been previously commented, there are three PLP multiplexing methods: TDM, FDM and LDM. The PLPs information is packeted in sub-frames and frames as the Scheduler orders to. A same frame can be formed by one or more sub-frames.

Each complete frame starts with a Preamble which contains the vital signalization for being found and being PLP data accessible for the receptor.

Previously, the Bootstrap is placed with the most basic information about how to start demodulating. It consists on OFDM symbol series and is a very robust part, since it has to be received by all devices. It can be noticed under -6dB in difficult channels, whereas in AWGN channels, the threshold is close to -9.5dB .

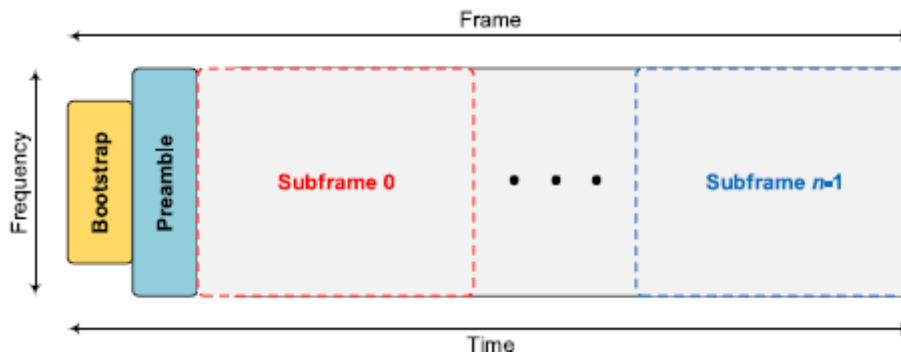

Figure 8. Frames and sub-frames structure. [1]

The frequency interleaving is produced in the entire channel bandwidth for separating stream errors in frequency domain. It is always used for Preamble symbols, but using for sub-frame symbols is also possible.

3.2.4 Waveform generation

This block diagram below shows all Waveform generation components.

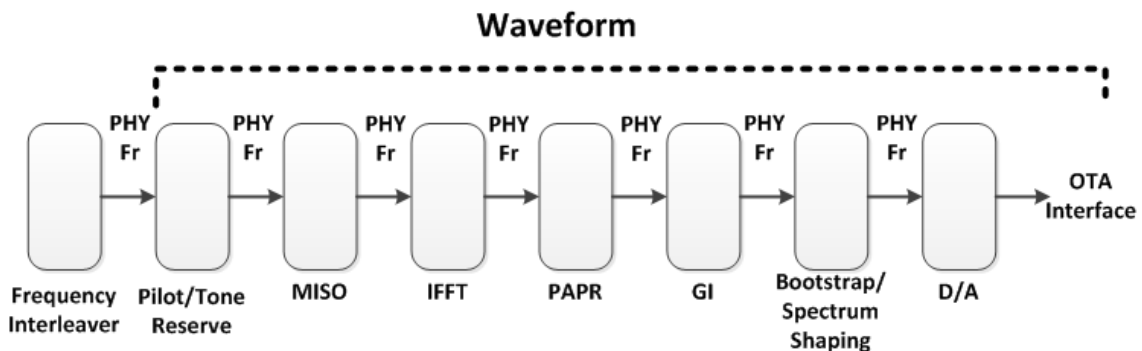

Figure 9. Block diagram of Waveform generation module. [2]

It features the pilots addition, followed by the pre-distortion MISO block, the IFFT block, the PAPR power reduction block, which is optional, and the guard interval insertion block. Finally, the abovementioned Bootstrap is placed at the beginning of each frame.

Pilots are used for frame, frequency and time synchronization, apart from channel estimation and the transmission mode identification. There are sixteen schemes where two parameters are defined: D_x , which is the frequency distance, and D_y , that is the number of symbols that forms a pilot sequence in time domain.

When the pilots addition is produced, an optional MISO filter can be used if the transmitter diversity for a broadcast reception is required to be more robust. A technology called Transmit Diversity Code Filter Set (TDCFS) is employed.

Once that option is considered, IFFT is applied. This converts frequency domain frames to time domain frames.

Afterwards, two optional reduction PAPR technologies (Peak-to-Average Power Ratio) are available: Tone Reservation (TR) and Active Constellation Extension (ACE). When the first is enabled, some OFDM carriers are reserved in order to reduce the PAPR of the waveform produced. Whereas the ACE reduces that PAPR through the modification of transmitted constellation points.

With these data already interleaved, multiplexed and framed, a guard interval (GI) is introduced between symbols with the purpose of protecting against channel reflections, echoes or any desynchronizations during the chosen length, being very relevant in SFN (Single Frequency Network) use. What occupies this guard interval is the cyclic prefix.

In the end, after inserting the guard interval with the cyclic prefix, the Bootstrap is inserted.

3.3 Transmission Parameters Configuration

The next described parameters are the different modifiable elements in a particular ATSC 3.0 transmission mode, as well as fixed, portable, mobile, indoor or vehicular, in order to obtain the correspondent Signal to Noise Rate and its rate.

- Bandwidth: size of the broadcast channel given in megahertz. 6 MHz is the common length, despite of the fact that the standard also defines 7 and 8 MHz.
- FFT size: number of discrete points used in the calculation of the IFFT in the Waveform generation module. Also, the number used to demodulate de OFDM waveform received. ATSC 3.0 defines three sizes: 8K, 16K and 32K.
- Guard interval: time interval inserted between OFDM symbols given in microseconds in order to minimize the interference between symbols, used in the Waveform generation module. They are defined from 27.78 μ sec to 703.70 μ sec in twelve patterns.
- Scattered pilot frequency spacing: Normal or Dense are the values used. The less dense, either in frequency (D_x) or time (D_y), the greatest payload due to the fewer carriers used.
- Scattered pilot time spacing: time separation of the scattered pilots used for channel estimation, given as the number of symbols forming one scattered pilot sequence. The values available are 2 or 4. These two types of spacing, both in frequency and in time, are placed in the Waveform generation module.
- Constellation size: number of points of the QAM signal employed in BICM module. The orders 4, 16, 64, 256, 1024 y 4096-QAM are defined.
- LDPC length: FEC inner code size given in bits in BICM module. It can be 16200 or 64800 bits.
- LDPC code rate: proportion of the stream that is useful, relating to de BICM module. It is given as an integer factor between 2 and 13 over 15.
- BCH: Bose, Ray-Chaudhuri and Hocquenghem FEC outer code used in the BICM module. ON y OFF are the options.
- Frame length: total time-aligned frame length given in milliseconds, being able to be 100, 150, 200 o 250 ms.
- Injection Level LDM: CL injection level in LDM, given in dB compared to the EL. The most value used is -4dB.

These are the values that can be modifiable in *S32-4-031r7-ATSC_3_0_Use_Case_Calculations.xlsx* spreadsheet explained 4.2 section to obtain a payload rate and SNR for AWGN and Rayleigh channels for various study cases.

3.4 Advanced Transmission Technologies in DTT

The following transmission technologies in digital television are the employed in the study cases of this thesis, in order to realize the improvements they can achieve.

3.4.1 LDM

This technology has been contemplated in the physical layer standard of ATSC 3.0 and it is a non-orthogonal multiplexing based on a superposition technology. It is one of the techniques used to multiplex different types of services in a single RF channel, as it is already commented in section 3.2.3.

In comparison with other multiplexing technologies as TDM, LDM occupies the 100% of the time and frequency resources as it is shown in the figure below:

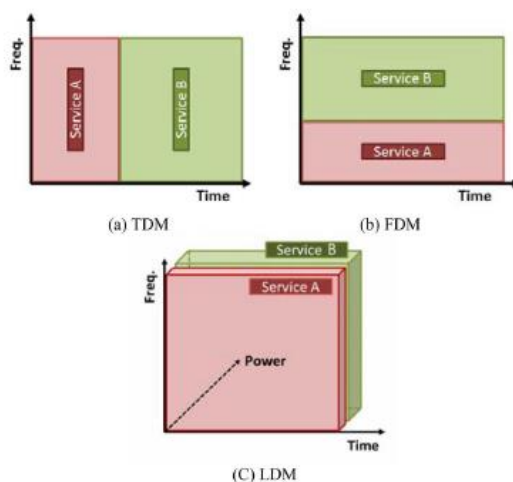

Figure 10. Comparison between multiplexing technologies in time and frequency. [3]

In this technology, multiple broadcasting contents at each layer are undergone different BICM chains for different robustness, and they are injected with different power levels for transmission. This make this technology ideal for providing different types of services, as fixed and portables services can be.

This mode has two layers, the Core Layer (CL) and the Enhanced Layer (EL). The first one can be directly decoded treating the stream of EL layer as additional noise, whereas this layer can be decoded using a signal cancelling technique.

The CL layer is more robust, and it is generally used for mobile service, and the EL layer is destined to service with a higher Signal to Noise Ratio. An example of a transmission employing LDM technology is shown next:

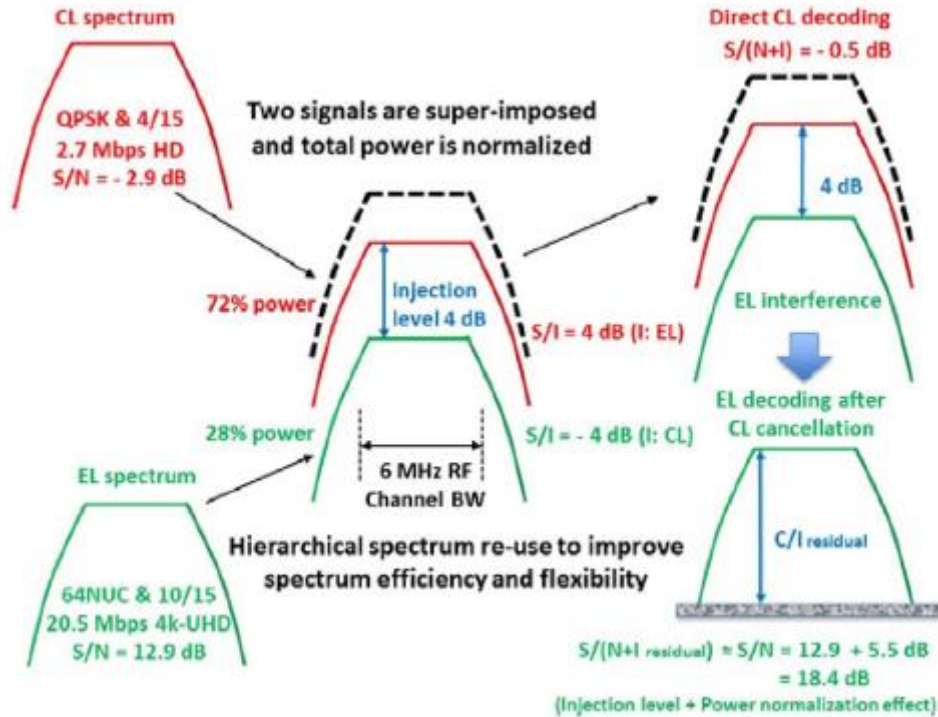

Figure 11. Example of a two layer operation process in LDM. [3]

As it can be seen in the previous figure, in the CL signal a very low code rate and a robust modulation are used with the purpose of providing a mobile or portable service. On the other hand, the EL signal is configured to broadcast 4K-UHD services, aimed to fixed service with high rooftop antennas.

Once the two layers are generated, the two signals are super-imposed with a chosen *injection level*, which addition must always be the unit.

Using the above figure as an example, the -4 dB of *injection level* referred to the CL means that the EL signal is received as interference in CL signal perspective, so, the SIR (Signal-to-Interference Ratio) has the value of 4 dB. Similarly, from EL signal perspective, the SIR is -4 dB, what means that the interference power is much greater than the desired signal.

As it has been previously mentioned, in the LDM receiver the CL signal must be decoded first. Taking into account the -4 dB of *injection level* of the EL signal, the portion of CL part from the total of the transmission is $1/(1 + 10^{-4/10})$, what means a 72%. Therefore, the remaining 28% is allocated to EL signal.

Because of this, the CL signal SNR is reduced $0.72/(0.28 + 1)$, what is 0.56 and imply -2.5 dB. In such way, given the SNR of the CL signal, the SINR of the CL turns out to be -0.5 dB.

After decoding the CL signal, it has to be subtracted from the combined signal, which results in EL signal and noise remains. Then, after the cancellation technique, the required SINR in reception of EL signal is adjusted this way $12.9 - (10 \log(0.28))$, what corresponds to 18.4 dB.

Finally, a practical comparison with TDM can be found in section 5.2.

3.4.2 Channel Bonding

Channel Bonding allows the increasing of peak rates, capacity and coverage. It consists of separating data from single stream in two RF standard channels. At first, it permits exceeding the maximum rate for a single RF channel, but moreover it offers other advantages, as the use of

scalable video in two RF channels can be, or that both channels do not need to be adjacent, but they can even be from different frequency bands.

This technology requires two tuners in the reception side, but shares the most part of the architecture with other technologies as MIMO, explained in section 3.4.3. Furthermore, the generation of wider bandwidths, as for any OFDM system, can be implemented of two different ways: or by carrier aggregation, or by multiple RF channels as it is showed below:

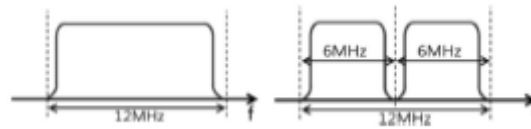

Figure 12. Carrier aggregation on the left side, multiple RF channels on the right side. [4]

The carrier aggregation is the method employed in technologies as LTE or DVB-C2, where the global bandwidth is defined by the number of OFDM sub-carriers accumulated using a particular space. Thus, there is no impact in the signal time characteristics. In this case, there is no need of a guard band due to the orthogonality between carriers, what increases in a small percentage the capacity.

Instead of that, the option usually chosen in Channel Bonding is the multiple RF channels use. Here, the overall bandwidth is de addition of each and every one of the channel bandwidth employed. Nevertheless, in this case a guard band is needed due to the fact that the different channels are no orthogonal. According to some studies, this involves a penalty from 1.5% to 2% of the total capacity.

Despite of that fact, several advantages are provided, as the different physical channel parameters employment in every channel is, or the reusing of Preamble, framer or interleaver. In addition, there are two principal reasons why finally it was used this way:

- Default bandwidths of 6, 7 and 8 MHz are realized already for a single RF channel by bandwidth scalable sampling rates. Bandwidth scalable sampling rates are hard to align to carrier aggregation using a fixed carrier spacing for all different bandwidths.
- This technology must be suitable to channels both adjacent and not adjacent, as it will be described forward in a case with an UHF and a VHF channel. As it is obvious, the carrier aggregation unables that option.

The block diagram of this technology is shown next:

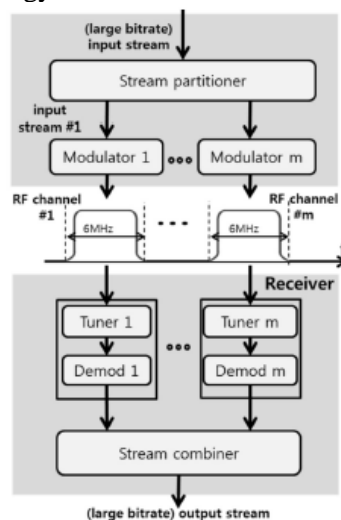

Figure 13. Block diagram of Channel Bonding technology. [4]

The concept is exactly as the previous figure displays. A great data stream is introduced in the transmitter and separated into different sub-streams in the *Stream partitioner*. Every one of these goes through the modulation stage in its respective channel. Here, they are individually modulated and they are given particular values of physical layer parameters depending on the service wanted to be transmitted. Finally, all modulated streams are broadcasted through their RF channel.

Regarding to the receiver side, the implementation can be performed in many different ways. The most direct architecture possible is to use several tuners that receive the already modulated streams. In this case, specifically the one reflected in the previous figure, every tuner provides its output signal to the demodulation stage, where that process is performed. Lastly, the decoded streams of every channel are recombined in the *Stream combiner* in order to obtain the final output stream. Then, Channel Bonding can be considered as a transparent technology. In other words, the final output stream is equal to the input stream in the transmitter.

In ATSC 3.0 each and every one of the two channels is treated as an independent signal. Except for the *Stream partitioner* and the *Stream combiner*, there is no special consideration in the physical layer apart from additional guard bands, synchronization, etc. The transmitter scheme is detail in the following figure:

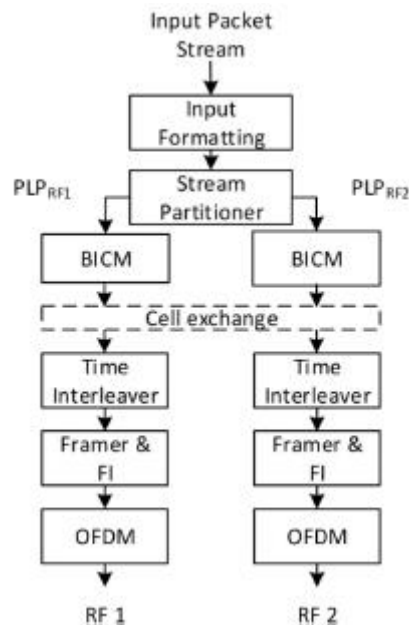

Figure 14. Block diagram of the transmitter in Channel Bonding technology. [4]

As it can be observed, all data packets from a transmitted PLP in Channel Bonding go through the same Input formatting module explained in section 3.2.1, where the baseband packets are made. Afterwards, different modulation and coding modes are assigned to the packets depending on the PLP after the *Stream partitioner* as it has been already commented.

The *Cell Exchange* block is optionally employed according to the Channel Bonding mode chosen, which can be these two:

- **Plain Channel Bonding**: it the simplest solution where there is no interaction between modulators. Then, the *Cell Exchange* is unable. In other words, the BICM output goes directly to the time interleaver.

This allows a totally desynchronized and independent mode for both RF channels. As it has been explained above, different physical parameters for each channel can be selected, so consequently, this Channel Bonding mode is ideal for services with different robustness or for examples in UHF and VHF channels, as it is performed in the study case of section 5.3.

Nevertheless, the main disadvantage is the fact that in the moment when a single channel has an insufficient SNR value or having decoding errors, the recombined final signal will be irretrievable and it will not be able to recover it.

- **SNR Averaged Channel Bonding:** in this case, the *Cell Exchange* is enabled. This mode improves the PLP performance due to a frequency diversity increase in both RF channels based on the QAM coded cell interchange in the *Cell Exchange* module. It is also possible to have different physical layer parameters.

Anyway, ATSC 3.0, in order to reduce the complexity of this mode, limits the PLP rate of each channel to be the same, in addition to the fact that the framer must be synchronized, what involves time synchronization in Bootstrap, Preamble and in the scheduling. What is more, each channel PLP must use the same modulation and codification.

The *Cell Exchange* must be applied at a PLP level. Therefore, every second cell of every BICM is sent to the other transmitted signal. This presents an averaged SNR value between both RF channels, and improvements in the decoding stage.

With respects to the Channel Bonding advantages, as they are detailed at the beginning of this section, two principal use cases are highlighted.

The first is the global capacity increase, because of it is possible to increment a peak rate of a service. Despite of the fact that the PLP concept allows flexibility in order to achieve different *bitrates* or robustness for several services in a single RF channel, obviously, the rate of a PLP cannot exceed the rate of a single channel. Instead of that, with Channel Bonding it is possible to even double that rate.

This increase can be especially useful for services with mobile or portable reception where a small SNR value with a slight Mb/s rate is required, or for fixed reception services where a high rate is needed with the purpose of transmitting HDTV contents. All this without having a SNR value penalty.

The other advantage is the use of different frequency bands, as the VHF/UHF case can be, because of the fact that both employed channels can be adjacent or not. This case can be used when Channel Bonding is combined with the scalable version of H.265 or HEVC encoder, also known as SHVC. This allows the coding between two layers, one with low complexity and resolution (*base layer*) and another with additional information to, among others, improve the quality (*enhancement layer*).

With Channel Bonding, each layer can be transmitted in a single RF channel. The UHF frequency band will be used for mobile and portable service because of its wavelength is shorter and it permits integrating smaller antennas to mobile devices; whereas the VHF band will be used for fixed rooftop reception due to the fact that bigger antennas are required and, in addition, is human made noise immune. An example of this study case can be found in section 5.3.

3.4.3 MIMO

MIMO is a technology already implemented in several wireless communications as Wi-Fi or LTE with the purpose of, either improving the robustness in a transmission by additional space diversity, or increasing the payload transmitting multiple data streams in the same bandwidth through spatial multiplexing. Its use in terrestrial broadcasting can be significant, especially for medium or high SNR values.

Its implementation in ATSC 3.0 is based on the employment of crossed polarizations. In other words, it is a MIMO 2x2 technology where two antennas are used, one vertically polarized and another horizontally polarized, both in the transmitter and receiver side. Furthermore, in the

receiver side, two tuners are needed in order to receive and decode the MIMO signal. This technology is included in ATSC 3.0 what positions it as the first DTT standard including MIMO.

Towards the implementation in an already existing installation, in the transmitter side a new antenna with its corresponding wiring is needed, and a second data stream to broadcast too. The demodulator output is two baseband signals, being one for each antenna, so the RF chain has to be entire doubled.

In regard of the reception side, two crossed polarized antennas are needed, the abovementioned two tuners too, at the expense a higher demapping constellation complexity. If MIMO is used for improving the system capacity, increased peak rates have to be supported. So, if the receiver is ready for the Channel Bonding technology commented in section 3.4.2, the MIMO previous work has already been made, because of this technology also requires the employment of two tuners and the ability of withstand increased peak rates.

If it is wanted the MIMO implementation in fixed rooftop reception, it is also required that the installation adjusts the two data stream reception to the demodulator, what can involve substantial changes in a single antenna already made installation.

The block diagram of a MIMO transmission in ATSC 3.0 is as follows:

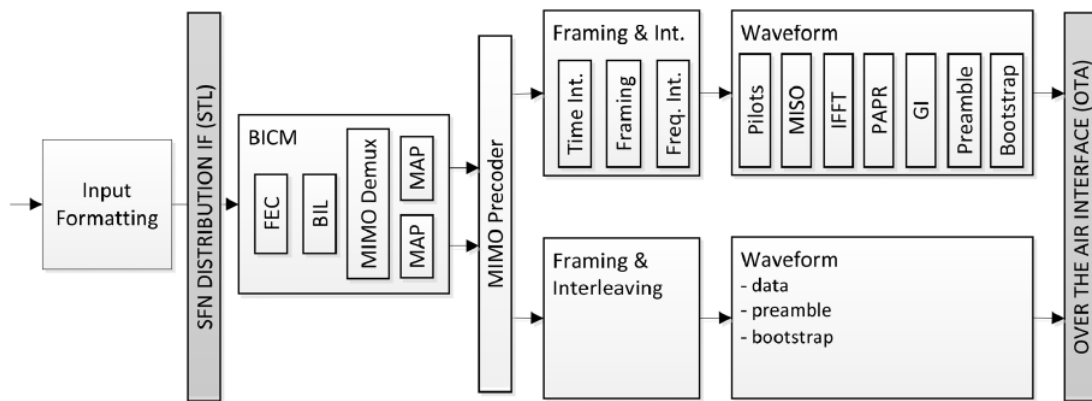

Figure 15. Block diagram of a MIMO transmission in ATSC 3.0. [5]

The two specific MIMO blocks that can be identified are the MIMO demultiplexer and the MIMO Precoder.

As it can be seen in the previous figure, all SISO blocks detailed in section 3.2 are reused, including FEC error correction, interleavers, constellations, etc.

Naturally, all blocks forward the generation of both MIMO streams in the MIMO demultiplexer are doubled, a block for each antenna. In addition, the same configuration in time and frequency interleaving for each stream has to be used.

The only two differences with SISO apart from the specific blocks of the technology treated in this section, are the peculiar pilot patters to achieve the same performance regarding to the echo tolerance and Doppler than SISO; and the necessity of double time interleaving memory due to the fact that each one corresponds to one in SISO.

MIMO is only applicable in ATSC 3.0 in the payload part. It is unavailable neither in Bootstrap, nor in Preamble, being here where its used is advertised. About the use of this technology with Channel Bonding, it is no contemplated in the standard.

3.5 DVB-T2 comparison

This section presents the comparison of essential characteristics between the DVB-T2 standard, developed by Digital Video Broadcasting (DVB), which is the evolution of the previous DVB-T standard, and ATSC 3.0.

All blocks are divided in colors depending on the what type of characteristics are, being general characteristics, input formatting related, BICM related, framing and interleaving related, waveform generation related, and at last but not least, about possible technologies, respectively.

Parameter	DVB-T2	ATSC 3.0
Min – Max. Data Rate 6MHZ	From 5.6 Mbps to 38 Mbps	From 1 Mbps to 57 Mbps
SNR AWGN channel range	From 1 dB to 22 dB	From -6.2 dB to 32 dB
Entry point to the system	P1 of 7 bits with a AWGN SNR of -5 dB	Bootstrap of 24 bits with a AWGN SNR of -9.5 dB
Link Layer Encapsulation	MPEG-2 TS	ALP
Transport Protocol	TS	IP
Multiple PLPs per service	No	Yes, up to 4
LDPC size	16200 and 64800 bits	16200 and 64800 bits
LDPC code rate	1/2, 3/5, 2/3, 3/4, 4/5, 5/6	{2, 3, 4, 5, 6, 7, 8, 9, 10, 11, 12, 13}/15
Outer code	BCH	BCH, CRC or none
Modulation	QPSK, 16QAM, 64QAM, 256QAM	QPSK, 2D-16NUC, 2D-64NUC, 2D-256NUC, 1D-1024NUC, 1D-4098NUC
Rotated Constellation	Yes, optional	No
Time interleaver	Block interleaver	Convolutional interleaver for a single PLP, hybrid convolutional + block for multiple PLPs
Time interleaver size in cells	$2^{19} + 2^{15}$	2^{19} $2^{20} QPSK$
Multiplexing	TDM	TDM, FDM and LDM
Max Frame size	250 ms	5 s
Pilot patterns	PP1 – PP8 (x8) 1.04%-8.33% overhead	SP3_2 – SP32_2 (x16) 0.78%-1.6% overhead
PAPR	TR and ACE	TR and ACE
FFT size	1K, 2K, 4K, 8K, 16K, 32K	8K, 16K, 32K
Extended mode	8KE, 16KE, 32KE	Number of active carriers configurable
Guard interval	1/128, 1/32, 1/16, 19/256, 1/8, 19/128, 1/4	3/512, 3/256, 1/64, 3/128, 1/32, 3/64, 1/16, 19/256, 3/32, 57.512, 3/16, 1/8, 19/128, 1/4

Channel Bonding	No	Yes, with two RFs
MIMO	No	Sí, not mandatory for the receivers
MISO	Alamouti	TDCFS

Table 1. Principal characteristics between DVB-T2 and ATSC 3.0 comparison [2]

Chapter 4. DTT Planning Methodology

In this chapter, the tools and steps to be followed in order to obtain a correct methodology for planning digital television coverage studies are elaborately explained, in addition to a validation study previously performed with the purpose of checking the correct operation of the method.

4.1 Tools

In regards to the studies made in this thesis, three basic tools have been used, and it has been employed as follows.

First of all, the analysis tool for signal, propagation loss and terrain called SPLAT! is used for each transmitter with its own characteristics. An alphanumeric file with the coordinates and their respective signal level is the result of the simulation made with real maps.

After that, they are processed with some Python codes using the Spyder IDE, and a numeric .npy file with a matrix with the signal level, a .kmz map for Google Earth, and a resulting .png are the correspondent outputs.

Before that process, some calculations have to be made in order to know the field strength level beyond it is considered to be covered. This level is overwritten in the Python codes to represent the map as wanted.

Finally, when the map with the wanted signal level threshold is available, the .png is exported to MATLAB to estimate the difference of coverage between studies.

The tools are now following explained.

4.1.1 SPLAT!

SPLAT! is a Radio Frequency Signal Propagation, Loss, And Terrain analysis tool for the electromagnetic spectrum between 20 MHz y 20 GHz, having used the digital television related frequencies of UHF band, and occasionally VHF band, in the study cases made.

It is a free software devised for Linux with what, apart from other applications, some networks can be designed and analyzed, as Wide Area Networks, radio communications, either commercials or amateurs over 20 MHz, microwave studies, interference studies and, like this case is about, signal level and coverage predictions for digital television.

This program, once antenna related and propagation values are introduced, is based on the maps of Space Shuttle Radar Topography Mission to know the terrain characteristics. Besides, it calculates the propagation losses and field strength intensity following Longley-Rice model, also known as Irregular Terrain Model (ITM). This was created for the necessity of planning broadcasting television in the United States in the 60s, being mostly used for channels placed in UHF/VHF bands.

In respect of its appearance, it is a non-graphic interface program, because it consumes so much amount of memory that it was considered unfeasible. Instead of that, some terminal commands are employed with many configurable parameters that will be commented below.

4.1.1.1 Utilities

In addition, there are a series of utilities placed in *utils* folder with necessary tools as these can be:

- **srtm2sdf**: this utility generates SPLAT Data Files (SDFs) prepared to be used in simulations, acquired from elevation data provided by the STS-99 Space Shuttle Topography Mission (SRTM). It can be obtained from this link http://dds.cr.usgs.gov/srtm/version2_1/SRTM3/ and it has to be simply unzipped and employed the command with the same name as the utility, in this way:

```
srtm2sdf N32W082.hgt
```

In this case, the result will be a file called *32:33:82:83.sdf* and it will be placed in the actual working directory.

The name is due to the fact that every .hgt downloadable from the previous link is named with the longitude and latitude at the most South-West point of the area represented. Therefore, the region wanted to be used in the studies must be at North and East of the coordinates represented in the name. Using the previous example, it can be observed that the name N32W082 belongs to the area of the map that covers from 32° to 33° North and from 82° to 83° West.

The amount of maps needed for each simulation is estimated with the *-R* parameter, which will be later appointed, nevertheless, all of them have to be in the working directory where the simulation takes place, or being indicated the path with the *-d* parameter.

If some map is necessary and it is not found in the directory, it is assumed as sea level by the program.

- **usgs2sdf**: in comparison with the previous utility, it also provides the .sdf files needed, although from a Digital Elevation Model (DEM) downloaded from the US Geological Survey.
- **citydecoder**: this utility reads U.S. Census Bureau files in order to create population data that can be imported to SPLAT!, either cities or entire maps.

All these utilities and some more are installed using the command *./install all*, and they can be compiled if there is some change on them with the command *./build all*.

4.1.1.2 Configurable parameters

This is the list of parameters that can be modifiable in a SPLAT! command when a simulation is going to be made, depending on the preferences or type of studies.

SYNOPSIS

```
splat
[-t transmitter_site.qth]
[-r receiver_site.qth]
[-c rx antenna height for LOS coverage analysis (feet/meters) (float)]
[-L rx antenna height for ITM coverage analysis (feet/meters) (float)]
[-p terrain_profile.ext]
[-e elevation_profile.ext]
[-h height_profile.ext]
[-H normalized_height_profile.ext]
[-I ITM_profile.ext]
[-o topographic_map_filename.ppm]
[-b cartographic_boundary_filename.dat]
[-s site/city_database.dat]
[-d sdf_directory_path]
[-m earth radius multiplier (float)]
[-f frequency (MHz) for Fresnel zone calculations (float)]
[-R maximum coverage radius (miles/kilometers) (float)]
[-dB threshold beyond which contours will not be displayed]
[-gc ground clutter height (feet/meters) (float)]
[-fz Fresnel zone clearance percentage (default = 60)]
[-ano alphanumeric output file name]
[-ani alphanumeric input file name]
[-udt user_defined_terrain_file.dat]
[-log logfile.ext]
[-n]
[-N]
[-nf]
[-sc]
[-dbm]
[-ngs]
[-geo]
[-kml]
[-gpsav]
[-metric]
[-olditm]
```

Figura 16. Lista de parámetros modificables al realizar una simulación en SPLAT! [6]

These are explained one by one:

- **-t**: name of the .qth file corresponding to the transmitter, being 4 the top number for Line Of Sight and 30 for covering area.
- **-r**: name of the .qth file corresponding to the receiver.
- **-c**: map of a LOS transmission with a receiver antenna height of X meters.
- **-L**: map of a coverage analysis with a receiver antenna height of X meters.
In this case, a distinction between fixed and mobile or portable reception has to be made. If it is about fixed reception, it will always be a 10 meter antenna height, whereas if it is mobile or portable reception, it will be a 1.5 meter antenna height. [13]
- **-s**: name of the cities or places related files, being 5 the maximum number.
- **-b**: name of the boundaries related files, being 5 the maximum number.
- **-p**: name of the terrain profile graph file to plot.
- **-e**: name of the terrain elevation graph profile file to plot.
- **-h**: name of the terrain height graph file to plot.
- **-H**: name of the normalized terrain height graph to plot.
- **-I**: name of the path loss graph to plot.
- **-o**: name of a topographic map file to generate in .ppm.
- **-u**: name of user-defined terrain file to import
- **-d**: path of the directory where the .sdf files are.
- **-m**: Earth radius multiplier.
- **-n**: do not represent LOS paths in .ppm maps.
- **-N**: do not produce unnecessary reports about sites or obstructions.
- **-f**: frequency for Fresnel zone calculation in MHz.
- **-R**: modify the default range for area prediction or LOS in miles or kilometers.
- **-sc**: represent contour levels in a smooth rather way.

- **-db**: threshold beyond where contours will not be displayed in dB.
- **-nf**: do not plot Fresnel zones in height plots.
- **-fz**: clearance percentage of the Fresnel, being 60 by default.
- **-gc**: ground clutter height in meters.
- **-ngs**: display greyscale topography as white in .ppm files.
- **-erp**: override ERP in .lrp files in Watts.
- **-ano**: name of the alphanumeric output file.
- **-ani**: name of the alphanumeric input file.
- **-udt**: name of the user defined terrain input file.
- **-kml**: generate a Google Earth Kml file.
- **-geo**: generate a georeference file .geo with a .ppm.
- **-dbm**: plot signal levels instead of field strength.
- **-log**: copy command line string to this output file.
- **-gpsav**: preserve all gnuplot temporary working files after SPLAT! execution.
- **-metric**: use metric system rather than imperial units.
- **-olditm**: use older ITM propagation model rather than the newer ITWOM.

4.1.1.3 Mandatory files for simulations

Regarding the simulations made in these studies, for each transmitter study, it is mandatory having the following files with their corresponding characteristics. The Forsyth site, placed in Atlanta, USA, is going to be used to be able to explain it in more detail.

It is vital importance having these five files in the current working directory:

- **.az**, antenna azimuth related, with values from 0 to 360.

1	140	
2	0	1.000
3	1	0.997
4	2	0.994
5	3	0.990
6	4	0.986
7	5	0.981
8	6	0.977
9	7	0.974
10	8	0.970
11	9	0.967
12	10	0.963
13	11	0.952
14	12	0.939
15	13	0.924
16	14	0.908
17	15	0.890
18	16	0.870
19	17	0.848
20	18	0.825
21	19	0.801
22	20	0.776
23	21	0.748
24	22	0.721
25	23	0.693
26	24	0.668
27	25	0.644

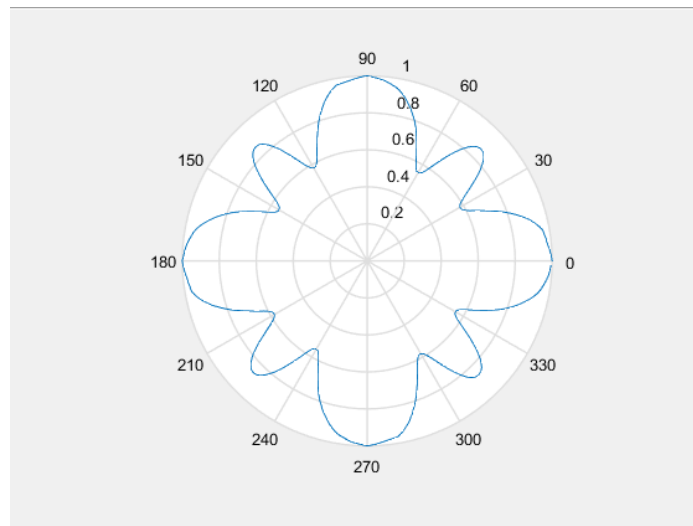

Figure 17. Example of the first values of Forsyth.az file and their total plot in MATLAB.

- **.el**, with antenna elevation values, from -10 to 90.

```

1 0 0
2 -10.00 0.065
3 -9.90 0.058
4 -9.80 0.049
5 -9.70 0.040
6 -9.60 0.030
7 -9.50 0.019
8 -9.40 0.009
9 -9.30 0.008
10 -9.20 0.017
11 -9.10 0.029
12 -9.00 0.040
13 -8.90 0.051
14 -8.80 0.061
15 -8.70 0.071
16 -8.60 0.080
17 -8.50 0.087
18 -8.40 0.094
19 -8.30 0.099
20 -8.20 0.102
21 -8.10 0.104
22 -8.00 0.105
23 -7.90 0.104
24 -7.80 0.101
25 -7.70 0.096
26 -7.60 0.090
27 -7.50 0.082

```

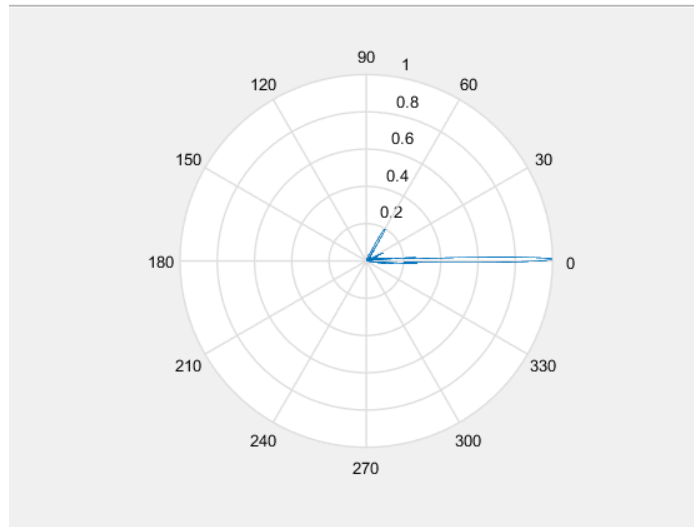

Figure 18. Example of the first values of Forsyth.el file and their total plot in MATLAB.

- **.lrp**, with the propagation related parameters.

```

1 15.000 ; Earth Dielectric Constant (Relative
permittivity)
2 0.005 ; Earth Conductivity (Siemens per meter)
3 301.000 ; Atmospheric Bending Constant (N-Units)
4 615.000 ; Frequency in MHz (20 MHz to 20 GHz)
5 5 ; Radio Climate
6 0 ; Polarization (0 = Horizontal, 1 = Vertical)
7 0.95 ; Fraction of situations
8 0.90 ; Fraction of time
9 152736 ; ERP in watts (250 kW reduced by 2.14 dB to
offset SPLAT EIRP gain) Antenna DIE TUM-04-12/48H-T 0.75
deg EBT 21.42 kW TPO
10
11 Please consult SPLAT! documentation for the meaning and
use of this data.
12

```

Figure 19. Modifiable parameters of Forsyth.lrp file.

Dielectric constant values and Earth conductivity can change according to the terrain where the study takes place:

	Dielectric Constant	Conductivity
Salt water	: 80	5.000
Good ground	: 25	0.020
Fresh water	: 80	0.010
Marshy land	: 12	0.007

Farmland, forest :	15	0.005
Average ground :	15	0.005
Mountain, sand :	13	0.002
City :	5	0.001
Poor ground :	4	0.001

Figure 20. Possible values of dielectric constant and Earth conductivity. [6]

Similarly, the weather can vary from these values:

- 1: Equatorial (Congo)
- 2: Continental Subtropical (Sudan)
- 3: Maritime Subtropical (West coast of Africa)
- 4: Desert (Sahara)
- 5: Continental Temperate
- 6: Maritime Temperate, over land (UK and west coasts of US & EU)
- 7: Maritime Temperate, over sea

Figure 21. Possible weather values depending on the type. [6]

- **.qth**, with antenna coordinates.

```

1 Forsyth
2 33 3 11.27
3 83 56 54.0
4 89.0 meters ; RC-AMSL = 415.7m, FCC site AMSL = 220.6m
  FCC AGL = 88.4m strm site elevation 220.0m AMSL
5

```

Figure 22. Parameters of Forsyth.qth file.

Both line 2 and line 3 are the exact coordinates of the point where the transmitter is. Line 2 is the latitude, 33° 3' 11.27'', whereas the next one is the longitude, 83° 56' 54''.

- **.scf**, used for defining the map colors. It has the present structure:

```

1 ; SPLAT! Auto-generated Signal Color Definition ("Forsyth.scf") File
2 ;
3 ; Format for the parameters held in this file is as follows:
4 ;
5 ; dBuV/m: red, green, blue
6 ;
7 ; ...where "dBuV/m" is the signal strength (in dBuV/m) and
8 ; "red", "green", and "blue" are the corresponding RGB color
9 ; definitions ranging from 0 to 255 for the region specified.
10 ;
11 ; The following parameters may be edited and/or expanded
12 ; for future runs of SPLAT! A total of 32 contour regions
13 ; may be defined in this file.
14 ;
15 ;
16 128: 255, 0, 0
17 118: 255, 0, 0
18 108: 255, 0, 0
19 98: 255, 0, 0
20 88: 255, 0, 0
21 78: 255, 0, 0
22 68: 255, 0, 0
23 58: 255, 0, 0
24 52.207: 255, 0, 0
25 48: 0, 148, 255
26 38: 80, 80, 255
27 28: 0, 38, 255
28 18: 142, 63, 255
29 8: 140, 0, 128
30

```

Figure 23. Parameters of Forsyth.scf file.

As the image shows, it is used for creating a scale of colors in RGB format what is associated to a field strength range. About the previous figure case, the red color has been adjudicated for every field strength level over 52.207 dB μ V/m.

If this file is not available, SPLAT! generates one automatically meantime the simulation is happening.

Obviously, as it can be seen in the foot of every previous figure of this section, the five abovementioned files must have the same transmitter name of the .qth file, in order to be recognizable and being able to read the entire data when the command `-t` is employed.

An example of a simulation can be found in the section 4.3.

4.1.2 Spyder and Python's code use

Spyder, as well as SPLAT!, is an open code platform. It is an Integrated Development Environment IDE which presents many facilities for using Python languages code and is obtained with the installation of Anaconda platform.

It integrates numeric treatment tools as NumPy, SciPy or Matplotlib can be. Those three extensions will be used in these studies, furthermore the fact of being able of incorporating the Simplekml extension to obtain maps.

The graphical user interface is like this:

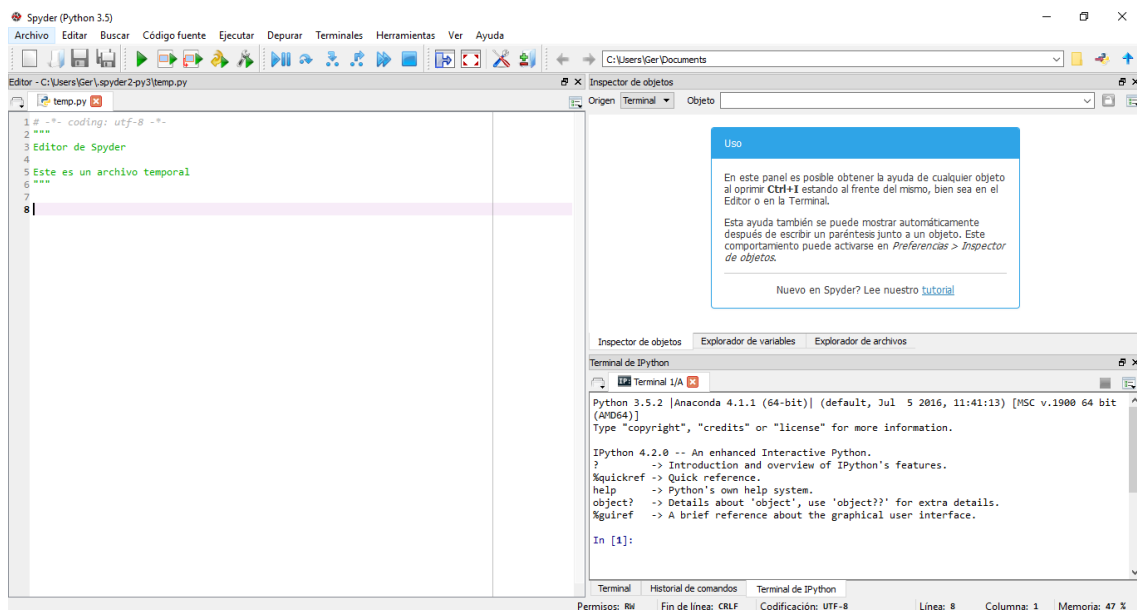

Figure 24. Graphic interface of Spyder IDE.

On one side, on the left part of the figure, there is a window where the text editor to write or edit code is placed. In the top part, there are icons with which many task can be done, as open a new file, save, launch the code or launch it until an interruption.

On the other side, concerning the right part, it is divided in two parts. Above everything, the path of the working directory can be seen. On the top window, there are three options: object inspector; variable inspector, where the value of each variable is shown after the launch, being very useful for debugging; and a file explorer. And, at last but not least, on the bottom part, there is a terminal where the compilation or execution errors can be read.

It is a very simple use IDE, intuitive, that has been employed to make use of these following Python codes:

- *Transmitter_name-SplatProcess.py*: the name of the transmitter can be whatever of the ones employed in these studies.

This code reads lines one by one through the alphanumeric file resulted from the SPLAT! simulation with the name given with the `-ano` command.

As it can be seen in the figure below, the two first lines are the maximum and minimum longitude and latitude of the coverage area there the simulation took place.

```
lon_range= data.readline()
lat_range= data.readline()
lon_max_west= float(lon_range.strip().split(",")[0])
lon_min_west= lon_range.strip().split(",")[1]
lon_min_west= float(lon_min_west.strip().split('\t')[0])
lat_max_north= float(lat_range.strip().split(",")[0])
lat_min_north= lat_range.strip().split(",")[1]
lat_min_north= float(lat_min_north.strip().split('\t')[0])
print (lon_max_west, lat_max_north)
print (lon_min_west, lat_min_north)
```

Figure 25. Part of *Forsyth-SplatProcess.py* file where the maximum and minimum longitude and latitude are read.

Once these coordinates are obtained, there is a for loop that reads the entire document until the end. From the third line of the alphanumeric file, five fields are delimited. The first and the second are the longitude and latitude where an estimation is performed, and the fifth field is the field strength corresponding to that point.

```
for d in data:
    fields= d.strip().split( ',' )
    lat_idx= lat_max_north-float(fields[0])
    lat_idx= int(round((lat_idx)*1200, 0))
    lon_idx= lon_max_west - float(fields[1])
    lon_idx= int(round((lon_idx)*1200, 0))
    fs= fields[4]
    fs= fs.replace('*', '')
    fs= float(fs)
    fs_int= int(round(fs, 0))
    # print (lon_idx, lat_idx, fs_int)
    if ((lon_idx < 4800) & (lat_idx < 4800)):
        a[lat_idx,lon_idx]=fs_int
print ("Finished saving data to Numpy array")
```

Figure 26. Part of *Forsyth-SplatProcess.py* file where Numpy array called `a` is created.

As it can be seen in the previous figure, the coordinates values are obtained, rounded (`lat_idx`, `lon_idx`) and the rounded field strength `fs` value is also obtained.

Finally, the objective is to create a 4800x4800 matrix where all field strength values are placed in the coordinate positions of the matrix. This is definitely exported to a file that turns out to be an array with the name of the maximum and minimum latitude and longitude and the site name, being `82.0-86.0-35.0-31.0-Forsyth.npy` in the example case.

Once this file is obtained, a .kmz map is created where the signal level is represented with a heat map using the `colormap` library, and a .png is exported.

The colors of the map are defined based on this part of the code:

```

def register_own_cmaps():
    cdict = {'red': ((0.0, 0.0, 0.0),
                    (0.005, 0.0, 0.0),
                    (0.2, 1.0, 1.0),
                    (0.3, 1.0, 1.0),
                    (0.4, 1.0, 1.0),
                    (0.5, 0.8, 0.8),
                    (0.6, 0.7, 0.7),
                    (0.7, 0.2, 0.2),
                    (0.8, 0.0, 0.0),
                    (1.0, 0.0, 0.0)),
            'green': ((0.0, 0.0, 0.0),
                    (0.005, 0.0, 0.0),
                    (0.2, 0.2, 0.2),
                    (0.3, 0.7, 0.7),
                    (0.4, 1.0, 1.0),
                    (0.5, 1.0, 1.0),
                    (0.6, 1.0, 1.0),
                    (0.7, 1.0, 1.0),
                    (0.8, 0.8, 0.8),
                    (1.0, 1.0, 1.0)),
            'blue': ((0.0, 0.0, 0.0),
                    (0.005, 0.0, 0.0),
                    (0.2, 0.0, 0.0),
                    (0.3, 0.0, 0.0),
                    (0.4, 0.0, 0.0),
                    (0.5, 0.0, 0.0),
                    (0.6, 0.0, 0.0),
                    (0.7, 0.0, 0.0),
                    (0.8, 0.5, 0.5),
                    (1.0, 0.9, 0.9))},

```

Figure 27. Part of *Forsyth-SplatProcess.py* where the colors of the heat map are created.

The first values of each triplet of each color must start from 0, which is the beginning of the color bar, to 1, which represents the end. The next two values indicate the color at that height of the bar, being 0 the value 0, and 1 the value 256 in RGB mode. In this way, the degraded where there are red at the beginning, and an end up in blue is made, as it can be seen in the figure below.

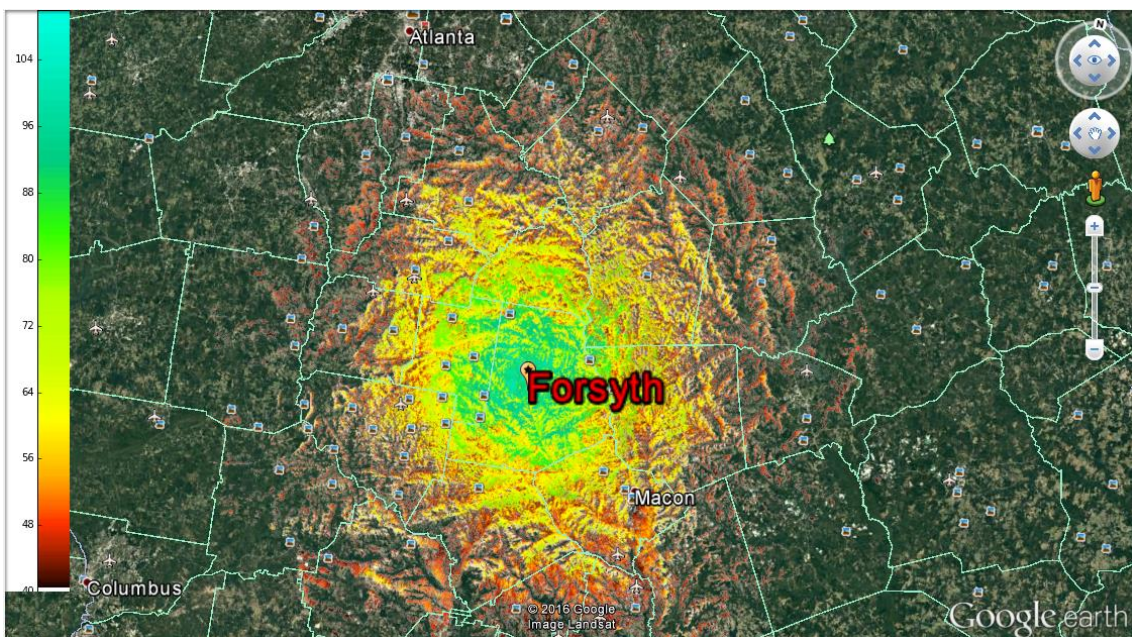

Figure 28. Heat map example with signal level Forsyth.kmz as a result of *Forsyth-SplatProcess.py* execution.

In respect of the coverage, as some points beyond a certain threshold has to be known, and be all represented with the same color, which is a certain way of seeing if there is coverage or not, the color map is performed in this way:

```
def register_own_cmaps():
    cdict = {'red': ((0.0, 0.5, 0.5),
                    (1.0, 0.5, 0.5)),
            'green': ((0.0, 0.0, 0.0),
                    (1.0, 0.0, 0.0)),
            'blue': ((0.0, 0.0, 0.0),
                    (1.0, 0.0, 0.0)),
```

Figure 29. Example of *Transmitter_name-SplatProcess.py* where the entire color map is red.

If a threshold to be represented exists, the field strength showed in the map can be limited:

```
scale_min = 40
scale_max = 110
```

Figure 30. Part of *Forsyth-SplatProcess.py* where the field strength thresholds can be limited.

- *ATL-SFN-Array-Resize.py*: with the purpose of using this code, the five resulting .npv files of each transmitter must be in the working directory to make the SFN Atlanta study case.

What this code performs is reading each array found in every .npv file and converting them at the same size with the same coordinates to make possible the following SFN study. Therefore, in the *82.0-86.0-35.0-31.0-Forsyth.npv* example, finally it will turn out to be *82.0-87.0-36.0-31.0-Forsyth.npv*.

- *ATL-SFN-Array-RSS-Combine.py*: to make possible the use of this code, the five resulting files of the previous code have to be in the current working directory.

Here, the five arrays are combined and a great SFN is creates, following the next formula of the following figure:

$$P_{\text{cell}} = \left[(P_{\text{Tx1}})^2 + (P_{\text{Tx2}})^2 + (P_{\text{Tx3}})^2 + \dots \right]^{1/2}$$

Figure 31. Power addition of each transmitter. [11]

```
ss = pow(10,Gainesville/10)+pow(10,Rome/10)+pow(10,Forsyth/10)+pow(10,Newnan/10)+pow(10,WSB_TV/10)
rss = 20*np.log10(np.sqrt(ss))
```

Figure 32. Power addition of every transmitter in *ATL-SFN-Array-RSS-Combine.py*.

This is finally represented with another heat map. In addition, the threshold is again configurable as the previous transmitter case.

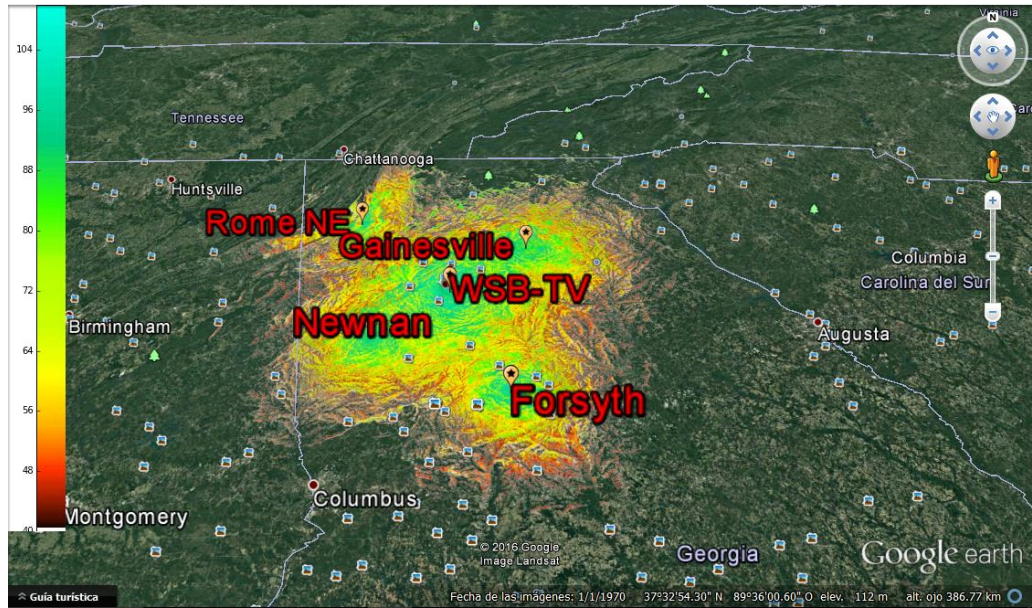

Figure 33. Example of resultant SFN after *ATL-SFN-Array-RSS-Combine.py* use.

4.1.3 MATLAB

This well-known tool is employed in these studies with the purpose of checking the exactly difference of coverage between different simulations.

Taking advantage of the fact that an output file of the execution of the Python code *Transmitter_name-SplatProcess.py* already explained is a .png image with the coverage as it is shown in the figure below, an accurate comparison can be made:

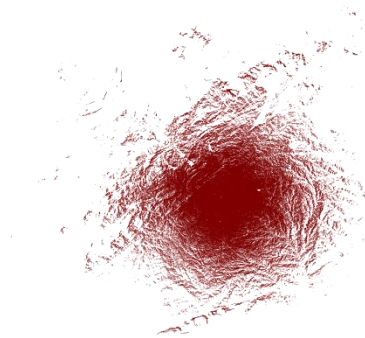

Figure 34. Example of resulting .png image from the execution of the *Transmitter_name-SplatProcess.py* code.

The dimension of this image is 4800x4800 pixels, and when a comparison is made with the same transmitter for each technology, the location is the same.

Regarding to the coverage color, something really important for being able to estimate the coverage afterwards, it is defined as it is shown in figure 29.

This image is imported to MATLAB through its *Import data* option and selecting the correspondent file, named exactly equal to the .npy obtained after the execution of that code.

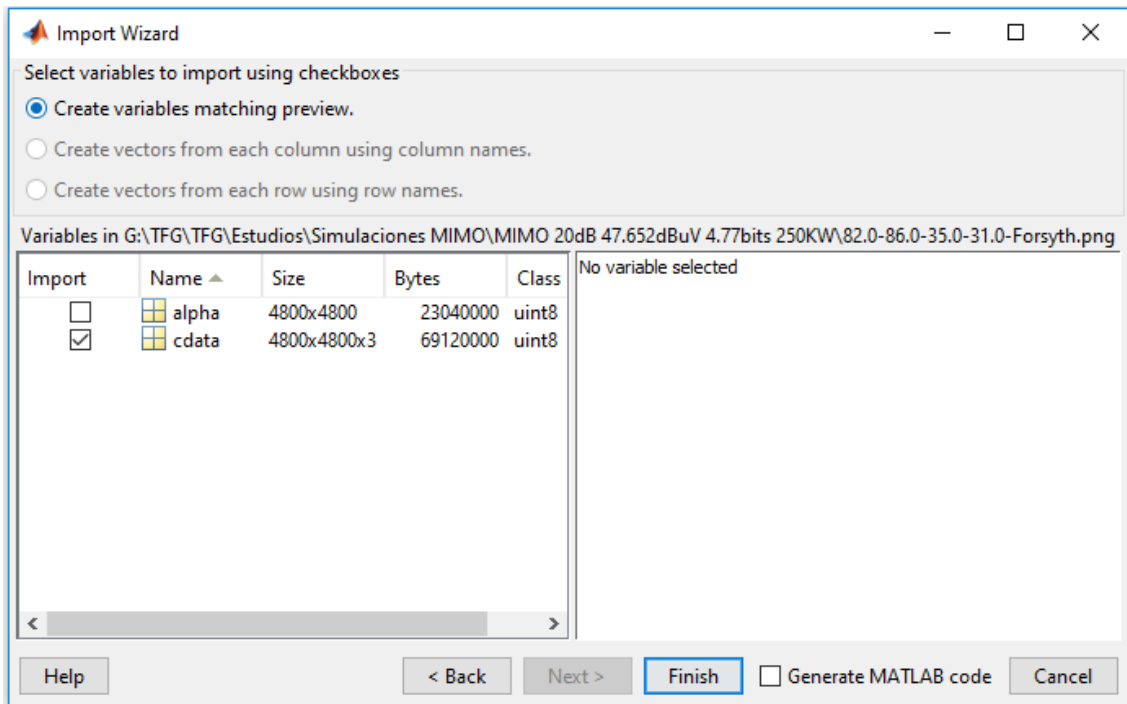

Figure 35. Menu where the .png file is imported to MATLAB.

The variable necessary in this study is *cdata*, which name can be changed, that contains the pixel color information in every image. Its size is 4800x4800x3: the 4800x4800 pixels previously mentioned, and three layer that represent each and every one of the RGB colors.

Using the command `>> imagesc(cdata(:,:,1))`, the image is represented with axis:

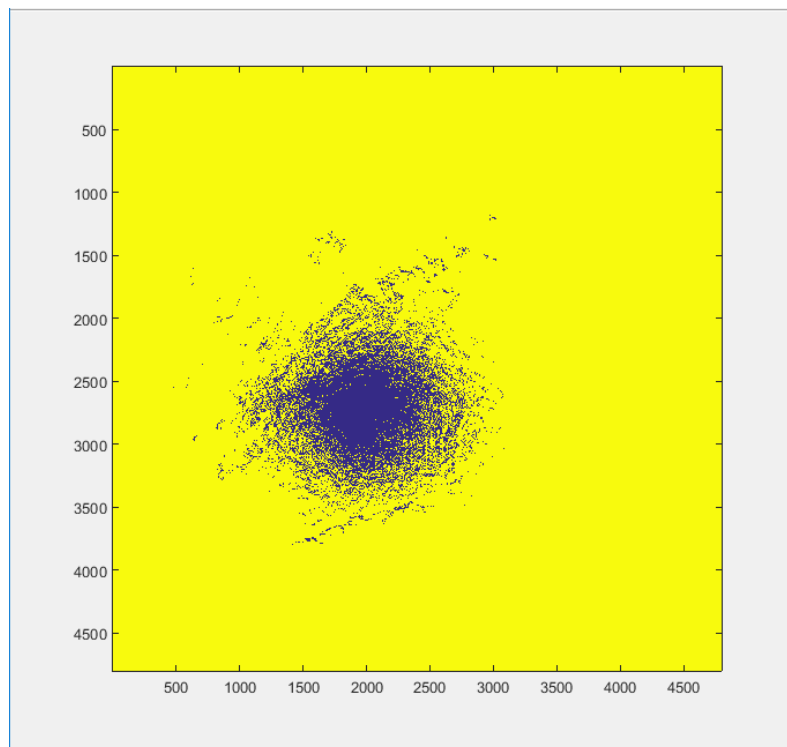

Figure 36. Image obtained after the `imagesc(cdata(:,:,1))` command with figure 34.

This image can be used for making a color checking. As it can be seen in the previous image, a point approximately in the 2500 row and 2000 column will be painted; meanwhile in the 1 row and 1 column, it will be no painted. Being the figure 34 red-painted, layer 1 has to be checked.

```

>> cdata(2500,2000,1)

ans =

    127

>> cdata(1,1,1)

ans =

    255

```

Figure 37. Color checking of pixels in cdata in figure 34.

The 127 result comes from the assignation of the 0.5 value in the map color creation shown in figure 29. Instead, the 255 results come from the fact that the color is black in that pixel, and thus, there is no coverage, being 255 its value in all the three layers.

Also as a verification, it can be seen that in the case where the image is full red, there will be no more other color in that point in layers 2 and 3:

```

>> cdata(2500,2000,2)

ans =

     0

>> cdata(2500,2000,3)

ans =

     0

```

Figure 38. Color checking of the cdata pixels in figure 34 depending on the layer.

Summing up, to facilitate the coverage estimation, all maps from each technology are red, green or blue, with values of 0.5 in the color map creation. Therefore, depending on the color seen in the imagen, it will be counted the amount of points or pixels which value is 127 of the chosen color.

In order to make that count, the next command shown is used:

```

>> A=numel(find(cdata(:,:,1)==127))

A =

    1288816

```

Figure 39. Count of the number of pixels where there is coverage in figure 34.

It is about saving in a variable the number of elements covering all rows and columns of a specific layer with the 127 value, therefore, having coverage.

The maximum number of pixels that can be counted is the result of the operation 4800×4800 , being 23040000 pixels.

With these results, and taking into account that the size and site of the images are the same for each technology, an exact comparison with gaining coverage percentage can be made.

4.2 Calculations

In this section, the calculations needed to do in order to obtain a field strength threshold in dB μ V/m are detailed. With this data, depending on the transmission mode, the receiver and the technologies used, the level beyond where it can be considered of being covered can be obtained.

This value is used both in *-db* command in SPLAT to perform the simulation, as it is explained in section 4.1.1.2, and in the minimum threshold of the code used for .kmz map exportation commented in section 4.1.2, figure 30.

All equations and tables of this section are placed in [13].As the 4.1.1.2 section details, what is related to the receiver height is something the software manage to, through a command.

In order to start with these calculations, a SNR is necessary and it is provided by the amount of configurable parameters described in section 3.3. The resultant SNR is obtained from the *S32-4-031r7-ATSC_3_0_Use_Case_Calculations.xlsm* spreadsheet.

#1	#2					#3	#4	#5				#6	#7	#8	#9	#10						
BW FFT						GI Dx Dy						QAM	LDPC	LDPC	BCH	Frame						
Pick BW, MHz	Pick FFT size					Pick Guard Interval (usec)	Pick Scattered Pilot Dx (frequency)	Pick Scattered Pilot Dy (time spacing)				Pick constellation size	Pick LDPC length	Pick LDPC code rate X/15	on/off	Pick Frame duration ms						
		number of non-zero carriers	Number of pilots	Tu (useful symbol duration, i.e., duration not including pilots)	Continuous fraction	spacing-normal (larger number) or dense spacing	spacing-normal (larger number) or dense spacing	spacing-normal (larger number) or dense spacing														
6	32768	28161	180	4,74E-03	0,00639	148,148	Normal	2	27543,8	0,84057	0,9697	0,8151	1024	10	64800	0,99975	13	0,87	ON	0,99658	200	0,987

Figure 40. Look of configurable transmission parameters of *S32-4-031r7-ATSC_3_0_Use_Case_Calculations.xlsm* spreadsheet.

As a result of the combination of these parameters in bold, a full channel payload and two SNR in dB, one for AWGN (Additive White Gaussian Noise) channel, and another for Rayleigh, are obtained, in addition to the Doppler speed, which will be no necessary in these studies.

Pay load	AWGN	Rayleigh	Doppler	
	SNR	SNR	Doppler speed,	Doppler speed,
Full channel bits per second	Threshold dB	Threshold dB	speed, kph @695 Mhz	mph @695 Mhz
48.013.827	27,62	31,59	79,0	49,1

Figure 41. Example of obtained results of *S32-4-031r7-ATSC_3_0_Use_Case_Calculations.xlsm* spreadsheet.

For these study cases, the AWGN invariant channel in frequency SNR value is used for fixed reception, whereas in the portable reception case, the Rayleigh fading channel SNR value is adopted. This is due to the fact that in fixed reception, the channel characterization is made by white noise, as it can be seen in the figure below:

Modelos de canal: Canal de comunicaciones fijo

➤ Caracterización del ruido:

- Ruido aleatorio siempre presente, con independencia del canal
- Ruido térmico: se denomina **ruido blanco** (potencia espectral plana hasta 10^{13} Hz):
- Ruido blanco limitado en banda:

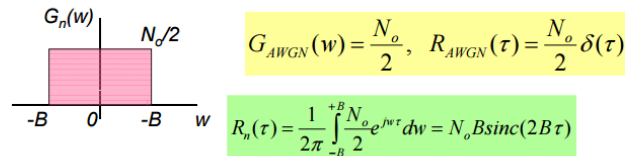

Figure 42. Noise characterization in a fixed channel. [12]

Although in portable reception, where there is no LOS and the multipath fading is present, the Rayleigh distribution is used:

Radio canal móvil

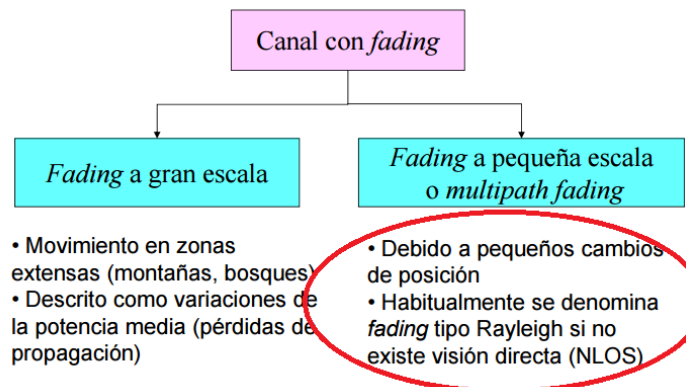

Figure 43. Mobile channel scheme, rounded the case used. [12]

Once the Signal to Noise Ratio of the transmission is acquired, some calculations are made with the purpose of obtaining the field strength threshold relative to that SNR.

Henceforth that value, the P_{smin} is got. In other words, the minimum required power with what the receiver is able to demodulate the transmitted signal. This is calculated with this equation:

$$SNR = P_{smin} - P_n \quad (4.1)$$

P_n is the noise power in dBW, obtained from this expression:

$$P_n = F + 10\log(k * T_o * B) \quad (4.2)$$

Where:

- F is the noise factor, with the value of 6 dB
- k is the Boltzmann constant, that is $1.38 * 10^{-23}$ Ws/K
- T_o is the absolute temperature, that is 290 K
- B is the used bandwidth, being 5.4 MHz in digital television (America UHF 6MHz)

This noise power, common in all these studies, has an exact value of -130.53dBW.

The equal part of these two types of reception is until here so far. Obviously, different parameters are taken into account for each case. Therefore, this section is divided into fixed and portable reception.

4.2.1 Fixed reception

In this case, as it has been previously commented in the section before, the calculations of the minimum required field strength start with the AWGN SNR value, and a P_{smin} acquired.

From this value, the minimum power flux density at receiving place in dBW/m^2 is obtained from this expression:

$$\phi_{min} = P_{smin} - A_a + L_f \quad (4.3)$$

Where:

- L_f are the feeder loss, that depending on the frequency band employed, can have these values:

	Feeder loss (dB)		Reception Mode
	Band III	Bands IV/V	
Rooftop antenna	2	4	Fixed rooftop

Table 2. Feeder loss values in dB in fixed reception depending on the frequency band [9]

- A_a is the effective antenna aperture in dBm^2 , that can be calculated from this expression:

$$A_a = G_{iso} + 10\log\left(\frac{\lambda^2}{4\pi}\right) \quad (4.4)$$

Where:

- G_{iso} is the antenna gain relative to an isotropic antenna. Therefore, it has to be subtracted an amount of 2.14 dB to the chosen value of the following table:

	Gain (dBd)		Reception Mode
	Band III	Bands IV/V	
Rooftop antenna	7	11	Fixed rooftop
Adapted antenna	-2.2	0	Portable Class A and B Mobile Handheld mobile vehicular Class H-C
External antenna*	-13	-5.5	Handheld portable outdoor Class H-A Handheld portable indoor Class H-B Handheld mobile reception H-D
Integrated antenna	-17	-9.5	Handheld portable outdoor Class H-A Handheld portable indoor Class H-B Handheld mobile reception H-D

Table 3. Receiver antenna gains in dBd depending on the frequency band and reception mode [9]

Thus, the chosen value is 8.86 dB for fixed reception.

- λ is the wavelength in meters, calculated from:

$$\lambda = \frac{c}{f} \quad (4.5)$$

Being $c = 3 * 10^8 \text{m/s}$ and f the central frequency of the channel used.

With all these values, the minimum power flux density at receiving places is acquired. Now it is necessary obtaining the minimum median power flux density in dBW/m^2 from this equation:

$$\phi_{med} = \phi_{min} + P_{mnn} + C_l \quad (4.6)$$

Where:

- P_{mnn} is the allowance for man-made noise, which possible values are:

Allowance for man-made noise (dB)			
Urban	Band III	Bands IV/ V	Reception Mode
Relevant value for integrated antenna	0	0	Handheld portable outdoor Class H-A Handheld portable indoor Class H-B Handheld mobile reception H-D
Relevant value for external antenna*	1	0	Handheld portable outdoor Class H-A Handheld portable indoor Class H-B Handheld mobile reception H-D
Relevant value for rooftop antenna	2	0	Fixed rooftop
Relevant value for adapted antenna	8	1	Portable Class A and B, Mobile Handheld mobile vehicular Class H-C

Table 4. Allowance for man-made noise values in dB depending on the frequency band and reception mode. [9]

Thence, in fixed reception, the value of 0 dB will be used.

- C_l is the location correction factor. Its calculation comes from:

For calculating the location correction factor C_l a log-normal distribution of the received signal is assumed.

$$C_l = \mu + \sigma$$

where:

- μ : distribution factor, being 0.52 for 70%, 1.28 for 90%, 1.64 for 95% and 2.33 for 99%;
- σ : standard deviation taken as 5.5 dB for outdoor reception. See § A1.3.7 for σ values appropriate for indoor reception.

Figura 44. Location correction factor calculation. [9]

As these studies are F(95,90) studies, the chosen value is $\mu=1.64$. So, C_l is 9.02 dB.

It has been assumed that a point is covered if a certain field strength threshold is exceeded in the 95% of locations, the 90% time.

Finally, having obtained the minimum median power flux density, the minimum median equivalent field strength in $\text{dB}\mu\text{V}/\text{m}$ is obtained, that will be the coverage threshold for a particular transmission mode. It is got from:

$$E_{med} = \phi_{med} + 10 \log(120\pi) = \phi_{med} + 145.8 \quad (4.7)$$

4.2.2 Portable reception

As it is said in this Calculations section beginning, it starts from the Rayleigh channel SNR value, from what the P_{smin} is obtained.

The next step is the achievement of the minimum power flux density in dBW/m^2 , employing the 4.3 expression. Nevertheless, in portable reception there is no feeder loss contemplated, so the expression is finally this way:

$$\phi_{min} = P_{smin} - A_a \quad (4.8)$$

Where the effective antenna aperture is calculated with the 4.4 expression, modifying the receiver antenna gain to a value of -2.14 dBi according to **Table 3**.

Once the minimum power flux density is got, it is necessary, as in the fixed reception case, to obtain the minimum median power flux density in dBW/m^2 . Equation 4.6 is used with a P_{mnn} value of 1 dB according to **Table 4**.

Lastly, the expression **4.7** is employed to obtain the minimum median equivalent field strength in $\text{dB}\mu\text{V}/\text{m}$ that will be used as a coverage threshold.

4.3 Validation of methodology

In order to perform the validation of the methodology, it has been replicated a previous study made by Doug Loung (NBCUniversal) in the city of Atlanta, USA. The five sites information have been provided: Forsyth, Gainesville, Newnan, Rome and WSB-TV.

The study was the performing of a Single Frequency Network in this region. Therefore, all maps necessary for each and every one of the five transmitters have been obtained, as it is indicated in section **4.1.1.1**, being from $31^\circ\text{N } 81^\circ\text{W}$, to $31^\circ\text{N } 87^\circ\text{W}$ to the West, and to the 36°N to the North.

Once all the maps and the transmitter files are available, a simulation of every transmitter is performed, following the command that can be seen in the .log files also provided. As an example, Forsyth.log:

```
splat -t Forsyth.qth -L 4 -R 161 -db 15 -ano Forsyth-splat-data.txt -log Forsyth.log  
-metric -olditm
```

This command, which can be checked in section **4.1.1.2**, means:

- Making a coverage area study where there is a transmitter called Forsyth, but no receiver antenna is specified. So, there is no LOS study.
- Receiver antenna is 4 meters high.
- Maximum radio coverage is 161 km. This involves that the greater this parameter, the greater amount of maps is needed. When a simulation takes place, SPLAT! warnings if the maps are recognized or not.
- Minimum threshold to represent is 15 dB.
- There is an alphanumeric file output called Forsyth-splat-data.txt with all the simulation results, with coordinates and field strength at that coordinates, being a 500 Mb file.
- Creating a log where the command employed can be read, called Forsyth. Log.
- All the used units are in metric system.
- The old ITM propagation model is used, instead of the newest ITWOM.

The result after several minutes of simulation is a .ppm image where the colors are defined in a .scf file, automatically generated in this case. Also, being the most important part, the abovementioned alphanumeric file is a result of the `-ano` command.

If it is necessary, SPLAT! can export a .kml file where the result can be seen using Google Earth:

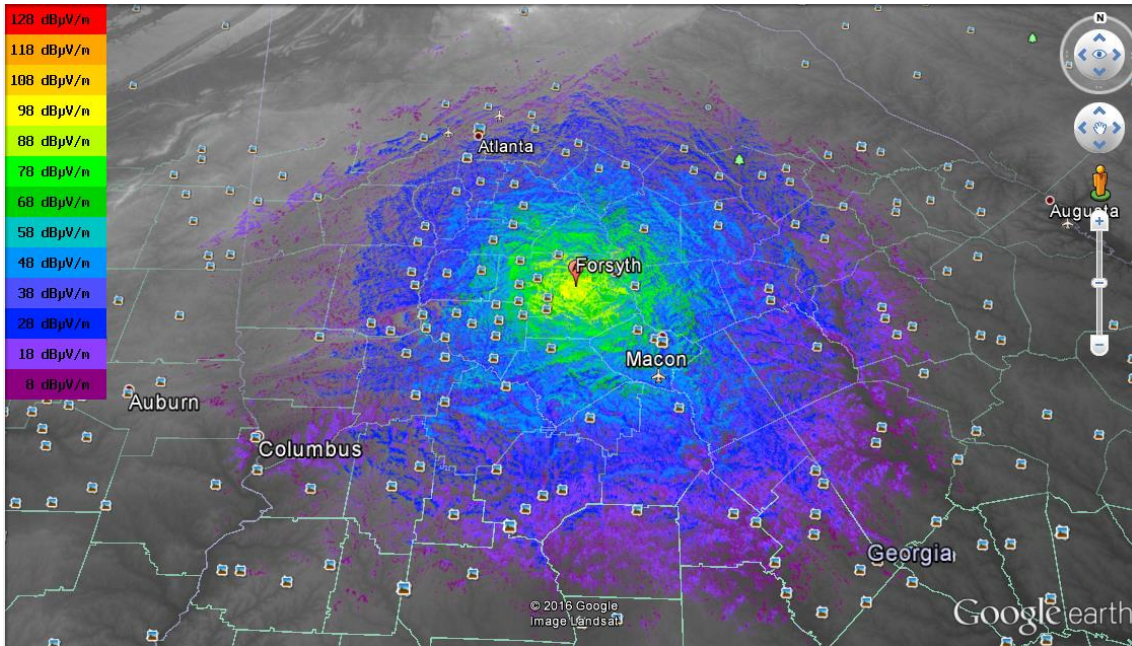

Figure 45. Resulting Forsyth.kml from the simulation of the previous command.

Once the results of each transmitter are obtained, the Python codes commented in section 4.1.2 are employed. Then, after using the *Forsyth-SplatProcess.py* code, it is got a .npz file with all the matrix values with the field strength levels called *82.0-86.0-35.0-31.0-Forsyth.npz* and the .kmz map shown below:

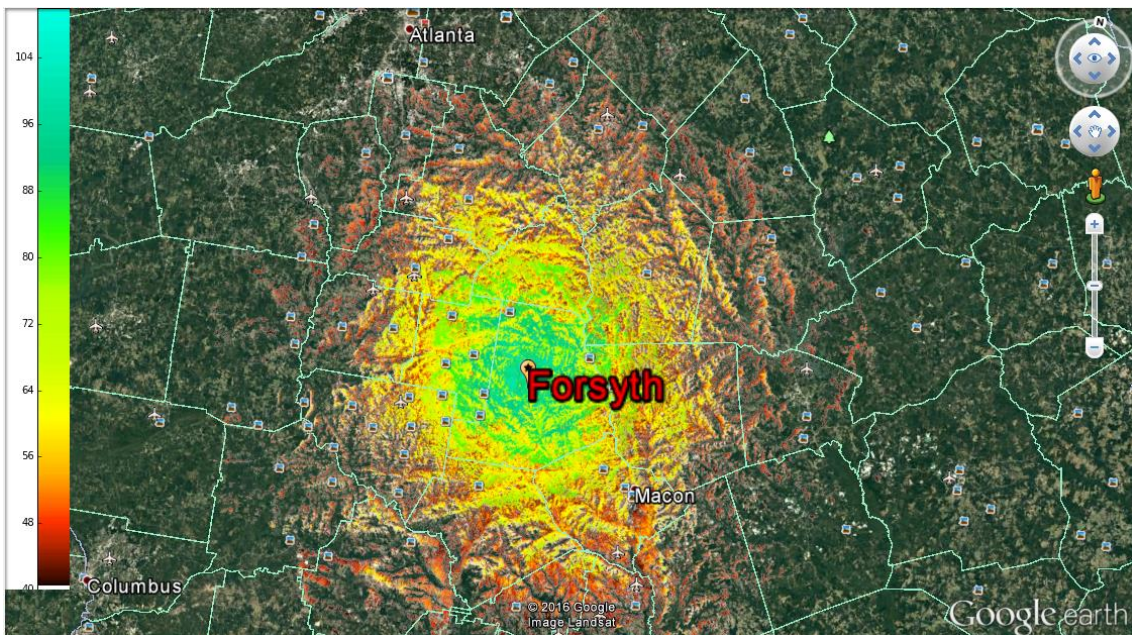

Figure 46. Resulting Forsyth.kmz after the *Forsyth-splat-data.txt* treatment with the *Forsyth-SplatProcess.py* code.

Subsequently, after having all five .npz files, one for each transmitter, they are all converted to the same size and same coordinates with *ATL-SFN-Array-Resize.py* code with the purpose of finally using the *ATL-SFN-Array-RSS-Combine.py* file and check if the resultant SFN is similar to the one performed in the previous study.

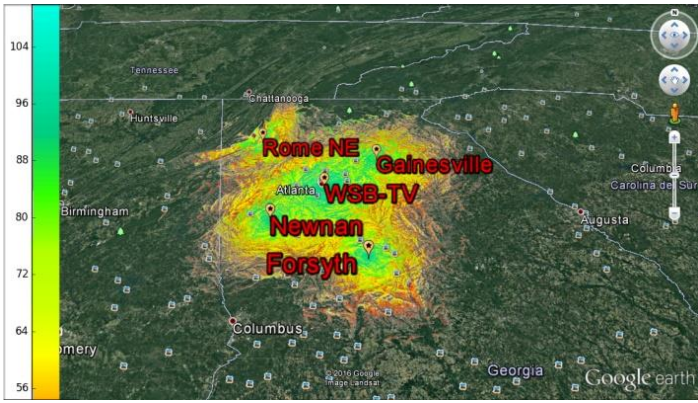

Figure 47. Original study SFN.

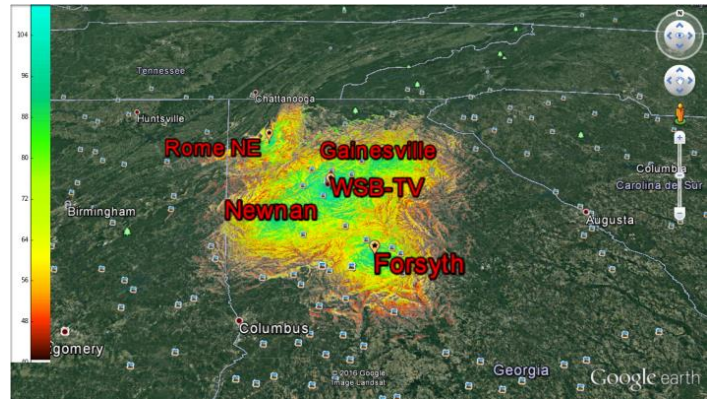

Figure 48. Replicated study SFN

Thus, as it can be appreciated, the images, and therefore the SFN, are identical. So this validates the proposed methodology.

Chapter 5. Simulation scenarios

5.1 Sites information

The five sites employed are placed nearby the city of Atlanta, USA as follows:

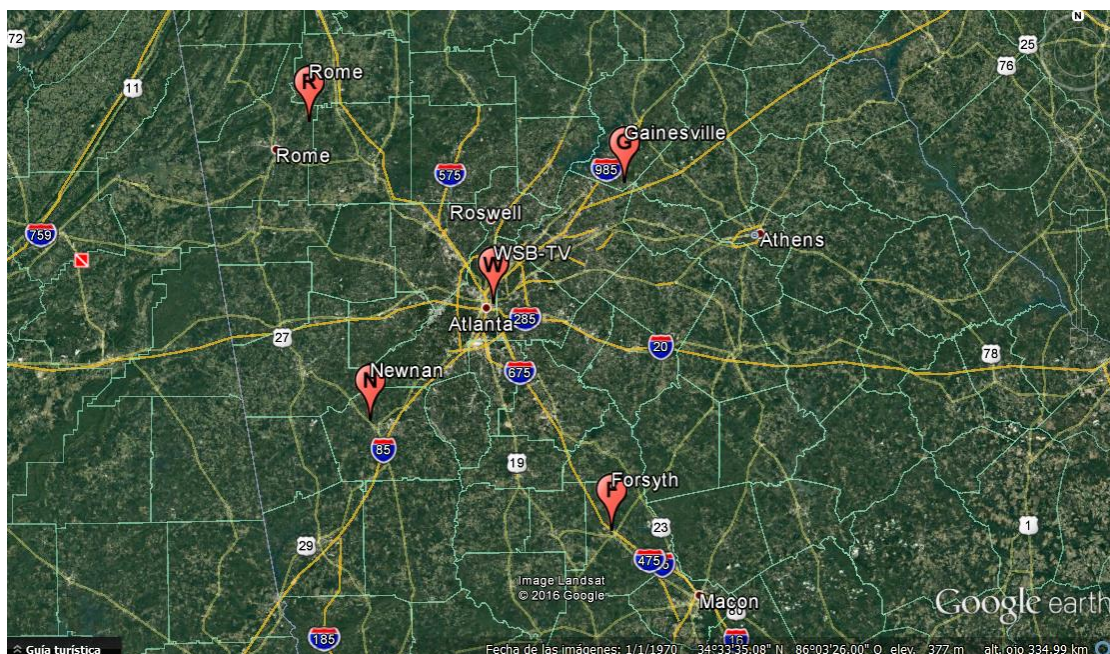

Figure 49. Map of the city of Atlanta, USA with the sites employed with a red mark.

Each site has its own properties, and they are summed up in this table:

	WSB-TV	Gainesville	Newnan	Rome NE	Forsyth
Latitude	33°45'51.4''N	34°07'32''N	33°24'41''N	34°20'35.1''N	33°3'11.27''N
Longitude	84°21'41.7''W	83°51'52.5''W	84°49'48''W	85°02'20''W	83°56'54''W
Ant. Height AMSL (m)	608	576.2	439.9	415.7	220.6
Ant. Height AGL (m)	311	305	183	61	88.4
Ant. Pattern	TFU-30DSC-R O4	TUM-O4-12/48H	TUM-O4-12/48H	TUM-C3-12/36H	TUM-O4-12/48H

Ant. Orientation (deg)	N/A	204	33	122	N/A
ERP (kW)	1000	250	250	250	250

Table 5. Main characteristics of the five transmitters employed. [11]

The TUM-O4-12/48H antenna pattern is the one plotted in figure 17 as an example, and it is the one used for Gainesville, Newnan and Forsyth sites.

Regarding to the WSB-TV and Rome NE antenna patterns, are respectively:

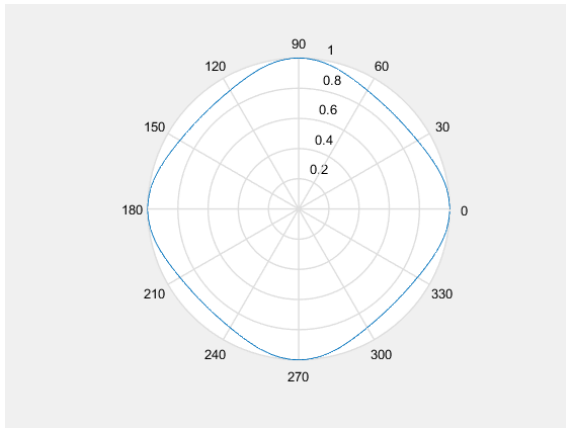

Figure 50. WSB-TV antenna pattern

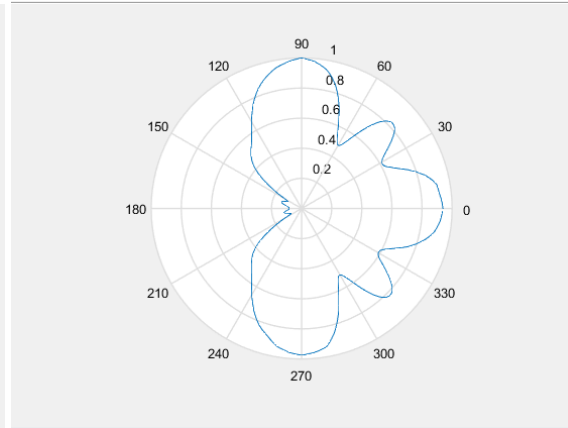

Figure 51. Rome NE antenna pattern

A 3D view of the antennas used in LDM, Channel Bonding and MIMO studies is shown:

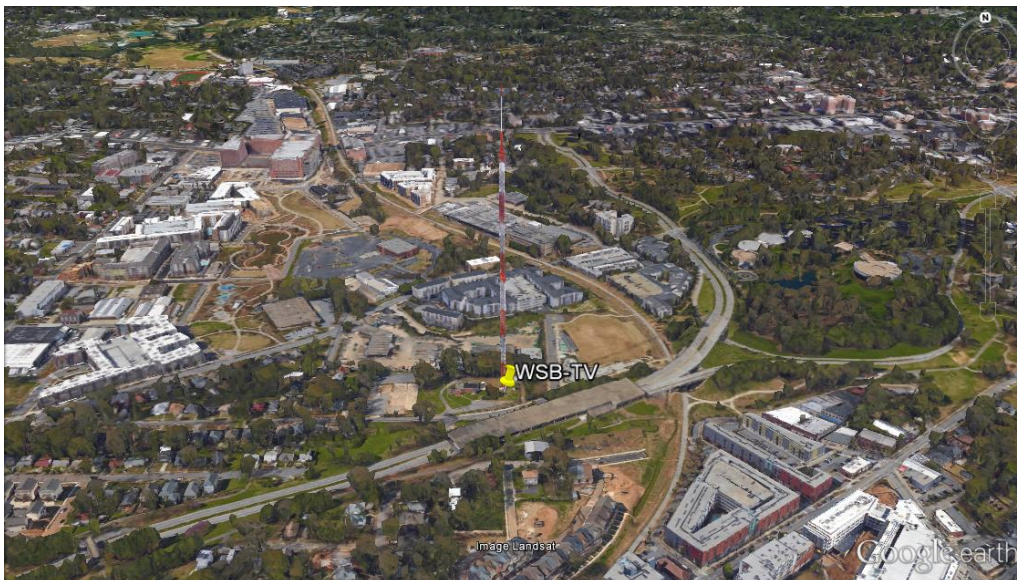

Figure 52. 3D view of WSB-TV antenna used for LDM and Channel Bonding studies



Figure 53. 3D view of Forsyth antenna used for MIMO study

5.2 LDM and TDM comparison

In this section, a simulation of a scenario where two concrete services, one for fixed reception and another for portable reception, are required to provide a particular rate regardless the technology used: LDM or TDM. The WSB-TV is the only site employed.

The main difference between the LDM and TDM multiplexing modes is the use of time resources. Whereas the TDM mode assigns different percentage of time to each service with different robustness, LDM mode uses the 100% of the time and frequency for each one. This is achieved with the employment of a parameter called *injection level*, varying the transmitted signals power. All this process has been commented in section 3.4.1, and it can be graphically seen in figure 10.

Regarding to the specification of the services that are going to be used, a rate of 4.3Mb/s is assumed for portable services, where a program in HD 720p/50 format can be transmitted, considering that in mobile devices there will be no higher resolution programs needed. This rate is obtained using the HEVC CBR encoder and adding 800 Kb/s for audio and the service associated data.

HD 720p/50, H.264 CBR	HD 720p/50, HEVC CBR	HD 720p/50, HEVC statmux (4 or more programmes/pool)
6.0 Mbit/s	3.5 Mbit/s	2.8 Mbit/s

Table 6. Estimated rate for a program in HD 720p/50 format. [15]

Concerning to the fixed service with rooftop reception, a payload of 33.4 Mb/s will be required, where 2 or 3 UHD TV 2160p/50 programs can be transmitted, also with HEVC codification [15].

Therefore, being 4.3Mb/s for portable reception and 33.4Mb/s for fixed reception what is necessary for having the required services available, the minimum field strength where that rates can be obtained has to be calculated.

In this case, a distinction between multiplexing modes has to be made. Respect to LDM, as it uses the 100% of the time resources, a transmission mode with its corresponding SNR threshold

that fulfills those rates will be needed. In contrast, in TDM it depends on the percentage of the time resources dedicated to each service.

With the purpose of making an accurate comparison between these two technologies, in TDM the 30% of the time resources are used for portable services, whereas the 70% remaining is used for fixed service, due to the fact that it has more priority in digital television.

So, in TDM it is needed a transmission mode that is able to provide a rate of 47.714Mb/s at the 100% of the time, so that the 70% of the time a rate of 33.4Mb/s can be achieved. In the same way, for portable service, a payload of 14.33Mb/s will be needed the 100% of the time.

Once the particular rates for each multiplexing technologies are acquired, a correspondent SNR value to each transmission mode has to be obtained, as the section 4.2 details.

With respect to TDM:

- Portable service:

BW	6 MHz	QAM	16
FFT	8192 (8K)	LDPC	64800 bits
GI	111.111 μ s	LDPC (Code Rate)	11/15
Dx	Normal	BCH	ON
Dy	2	Frame	200ms

Table 7. Parameters of the transmission mode employed in portable service in TDM

This provides a 14.363 Mb/s rate, with a SNR in Rayleigh channel of 12.78 dB

- Fixed service:

BW	6 MHz	QAM	1024
FFT	32768(32K)	LDPC	64800 bits
GI	148.148 μ s	LDPC (Code Rate)	13/15
Dx	Normal	BCH	ON
Dy	2	Frame	200ms

Table 8. Parameters of the transmission mode employed in fixed service in TDM

This provides a 48.013 Mb/s rate, with a SNR in AWGN channel of 27.62 dB

In relation to LDM, using -4 dB of *injection level*:

- Portable service:

BW	6 MHz	QAM	4
FFT	16384 (16K)	LDPC	64800 bits
GI	222.222 μ s	LDPC (Code Rate)	7/15
Dx	Normal	BCH	ON
Dy	2	Frame	200ms

Table 9. Parameters of the transmission mode employed in portable service in LDM

This provides a 4.645 Mb/s rate, with a SNR in Rayleigh channel of 7.65 dB

- Fixed service:

BW	6 MHz	QAM	256
FFT	16384(16K)	LDPC	64800 bits
GI	222.222 μ s	LDPC (Code Rate)	13/15
Dx	Normal	BCH	ON
Dy	2	Frame	200ms

Table 10. Parameters of the transmission mode employed in fixed service in LDM

This provides a 34.614 Mb/s rate, with a SNR in AWGN channel of 27.68 dB

As it can be seen, the SNR of both fixed services in TDM and LDM with the chosen parameters are similar. Therefore, a single simulation that can be used as an example for each technology is performed.

Following the steps of section 4.2, once the SNR values of each transmission mode are obtained, the threshold of field strength beyond which it is considered as covered has to be calculated, depending on the type of service.

Finally, the thresholds are the following:

- For fixed reception, both in LDM and TDM: 64.332 dB μ V/m
- For portable reception in TDM: 57.432 dB μ V/m
- For portable reception in LDM: 52.302 dB μ V/m

Thus, the simulation scenarios are as follows. The screen is centered in 34°N y 84°W, being at a human eye height of 300 km.

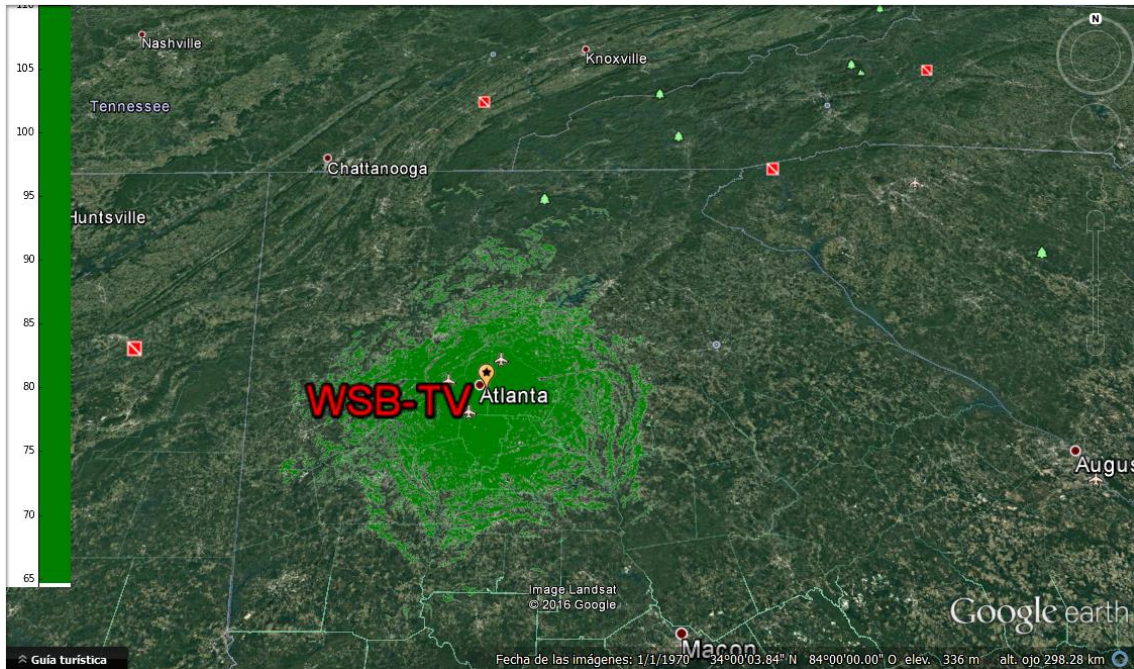

Figure 54. Coverage map of fixed service, both LDM and TDM, with a threshold of 64.332dB μ V/m

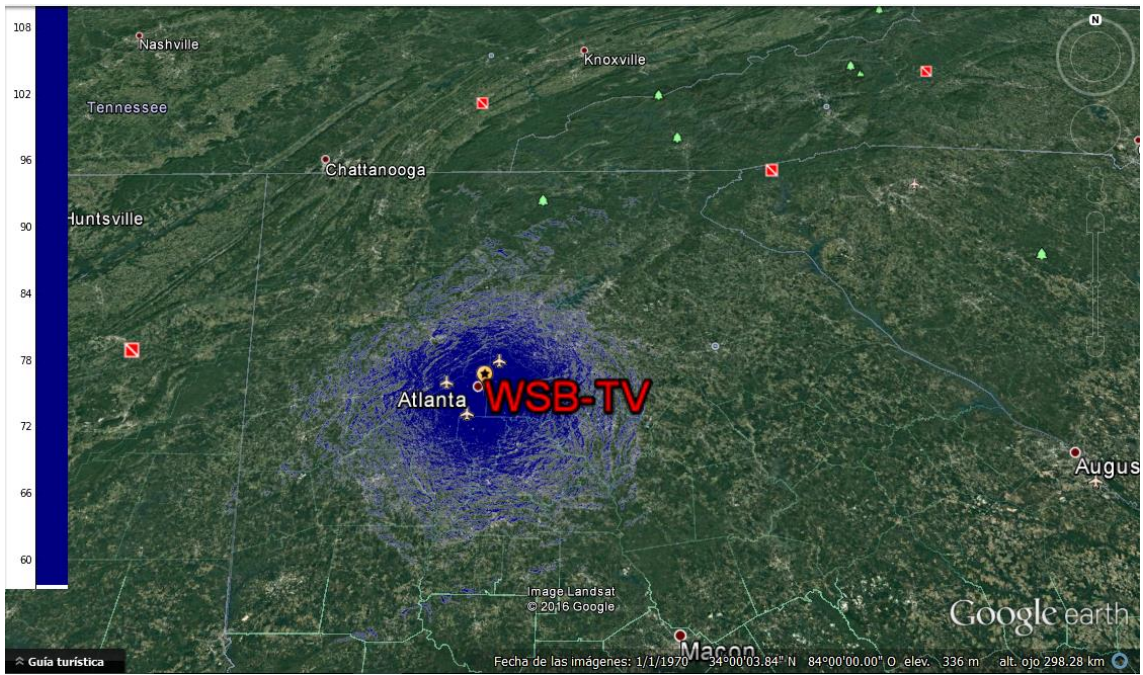

Figure 55. Coverage map of portable service in TDM with a threshold of 57.432 dB μ V/m

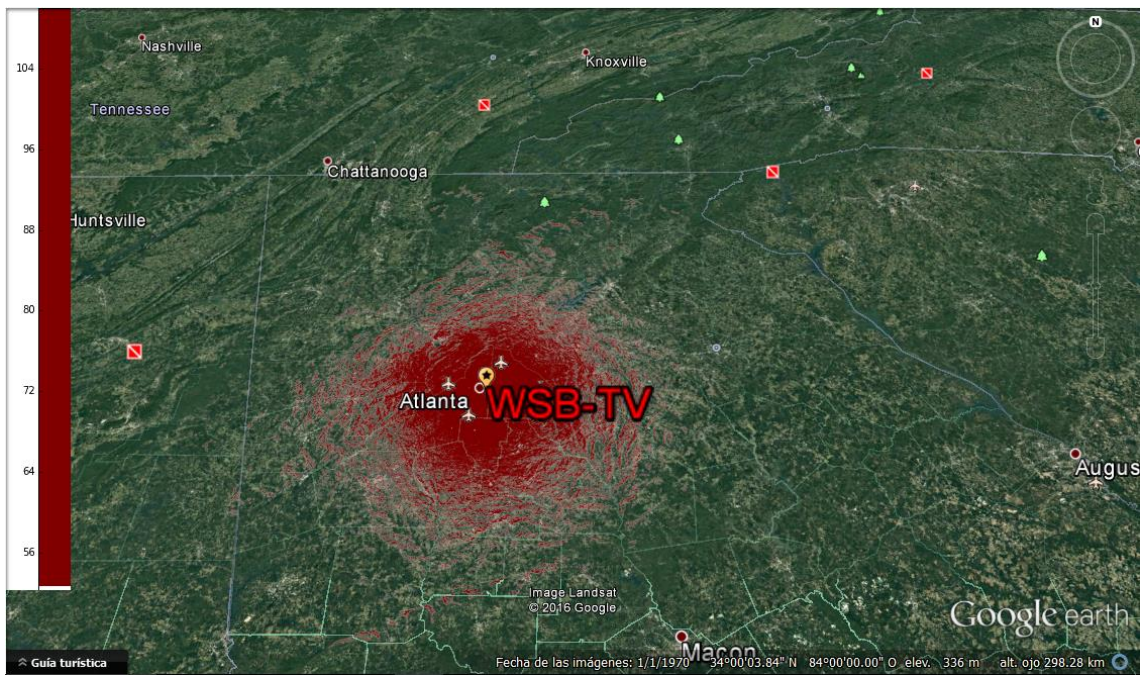

Figure 56. Coverage map of portable service in LDM with a threshold of 52.302 dB μ V/m

5.3 Channel Bonding

In this case, both variants of Channel Bonding that ATSC 3.0 presents are developed, depending on the use of the *Cell exchange* module as it is specified in section 3.4.2. All scenarios of this section will be performed with the WSB-TV transmitter site.

5.3.1 Plain Channel Bonding

With this Channel Bonding alternative, having disabled the abovementioned module, at the moment when one of the two transmitted signals has several failures, the service will be irretrievable.

Two different scenarios depending on the channels employed are performed. Taking advantage of the fact that it is possible to use two non-consecutive channels, a scenario is made using UHF frequencies, and other using UHF and VHF frequencies.

5.3.1.1 UHF-UHF

This is a fixed reception case based. It is used to compare the improvement in high-quality services transmission.

The concept is as follows. Two same-band UHF channels are used transmitting the same type of service, one in each extreme of the band, in order to be able to see the Channel Bonding performance when there are losses related to the frequency.

With the purpose of making this duty, this transmission mode will be used:

BW	6 MHz	QAM	256
FFT	32768(32K)	LDPC	64800 bits
GI	222.222 μ s	LDPC (Code Rate)	9/15
Dx	Dense	BCH	ON
Dy	2	Frame	250ms

Table 11. Parameters of the transmission mode employed for fixed service in Channel Bonding

This provides a 25.5 Mb/s rate, with a SNR in AWGN channel of 15.55 dB

That rate makes able to transmit two HDTV programs and one in UHD, since adding the additional information for each service as audio can be, HDTV 1080p/50 with HEVC coding requires of 5 Mb/s per program as it is shown in table 10, whereas in UHD 2160p/50 HEVC coding requires of 15 Mb/s, as it can be seen in table11.

HD 1080p/50, HEVC CBR	HD 1080p/50, HEVC statmux (5 programmes/pool)
4.4 Mbit/s	3.8 Mbit/s

Table 12. Estimated rate per program for HD 1080p/50 format. [15]

UHD 2160p/50, HEVC CBR	UHD 2160p/50, HEVC statmux (4 programmes/pool)
14.8 Mbit/s	12.0 Mbit/s

Table 13. Estimated rate per program for UHD 2160p/50 format. [15]

Therefore, if two independent SISO 6 MHz bandwidth channels of 25.5 Mb/s without Channel Bonding use are employed, four HD programs and two UHD can be transmitted in total.

Although, if the Channel Bonding technology is used, both 6 MHz channels are employed for the same data stream as figure 13 shows. This makes a total rate of 51 Mb/s that can be used for that four HD and two UHD programs, which will be illogical because of they can be obtained without Channel Bonding technology, or used for a HD and three UHD programs, that without this technology would be unavailable.

Regarding to the channels choice, distant frequencies of the UHF band have been chosen to observe the frequency performance, as it has been already mentioned. In the United States, the available channels for digital television in UHF band are from 14 to 51. So, channels 14 and 50 will be used.

As the channel choice is regardless to the rate, and so the transmission mode and its respective SNR too, it is only reflected in the field strength threshold calculation.

The resulting thresholds are as follows:

- Channel 14, with a frequency of 473 MHz with a 25.5 Mb/s rate: 49.922 dB μ V/m
- Channel 50, with a frequency of 689 MHz with a 25.5 Mb/s rate: 53.189 dB μ V/m

Thus, their respective coverage map will be the next:

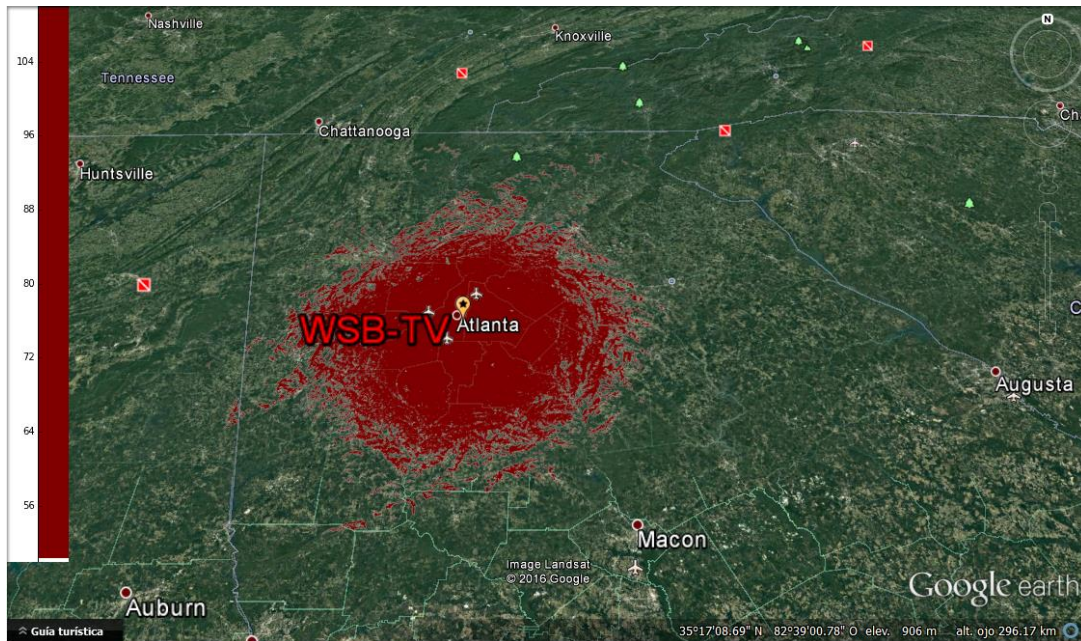

Figure 57. Coverage map of channel 14 with a threshold of 49.922 dB μ V/m

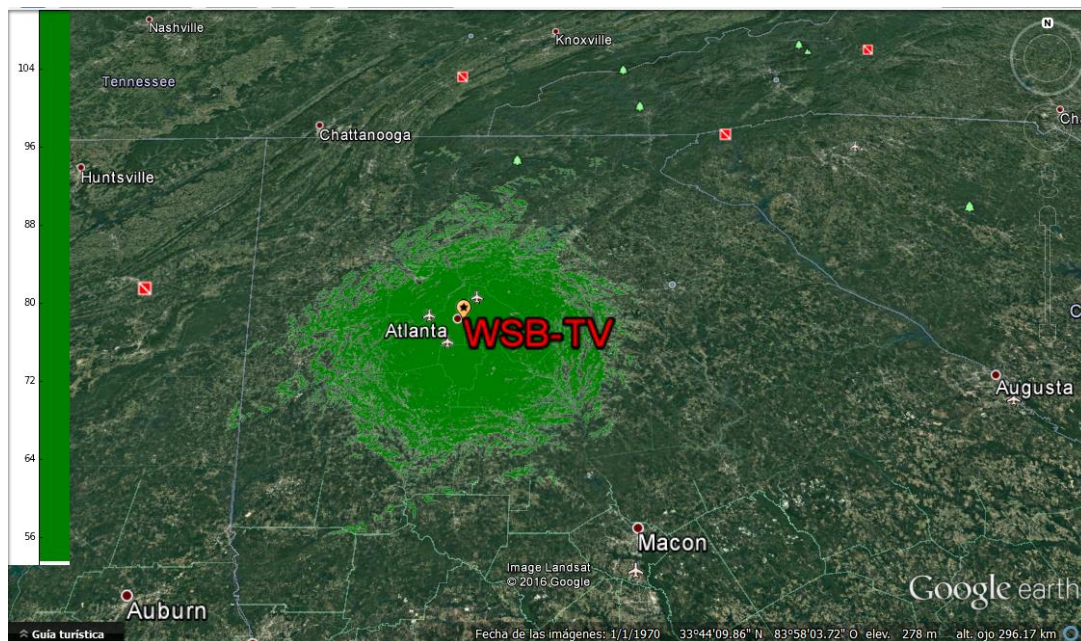

Figure 58. Coverage map of channel 50 with a threshold of 53.189 dB μ V/m

In order to compare this technology, a hypothetical SISO transmission mode with a 51 Mb/s has been calculated to see the coverage loss in comparison with Channel Bonding for a same service.

This transmission mode, with a more central frequency of 615 MHz is as follows:

BW	6 MHz	QAM	4096
FFT	16384(16K)	LDPC	64800 bits
GI	111.111 μ s	LDPC (Code Rate)	12/15
Dx	Normal	BCH	ON
Dy	2	Frame	250ms

Table 14. Parameters of the transmission mode with a 51 Mb/s rate

This provides a 51.2 Mb/s rate, with a SNR in AWGN channel of 30.34 dB.

Its respective threshold of field strength is 66.99 dB μ V/m, and then, its coverage map is as it is showed below:

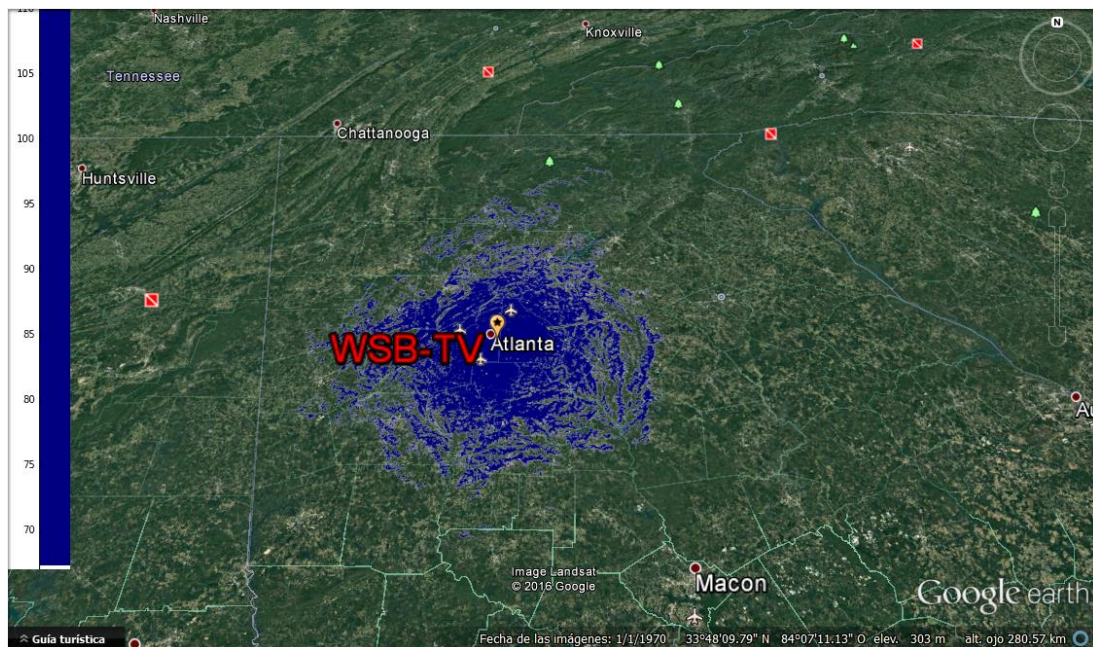

Figure 59. Coverage map of the transmission mode of table 14 with a threshold of 66.99 dB μ V/m

5.3.1.2 UHF-VHF

In this case, two types of services appear, one for portable service in UHF band, and another fixed service in VHF band, due to the reasons explained in section 3.4.2.

Based on SHVC, the portable service in UHF band provides a basic service called A.

For this service, transmission mode of table 9 will be used, employed in LDM. The rate will be the same; neither are the SNR because of the influence of the *injection level* characteristic of that technology. So in this case, the SNR value will be 1.95 dB.

Therefore, its field strength threshold to be covered at a frequency of 615 MHz using channel 38 has the value of 46.602 dB μ V/m. And then, its coverage map is:

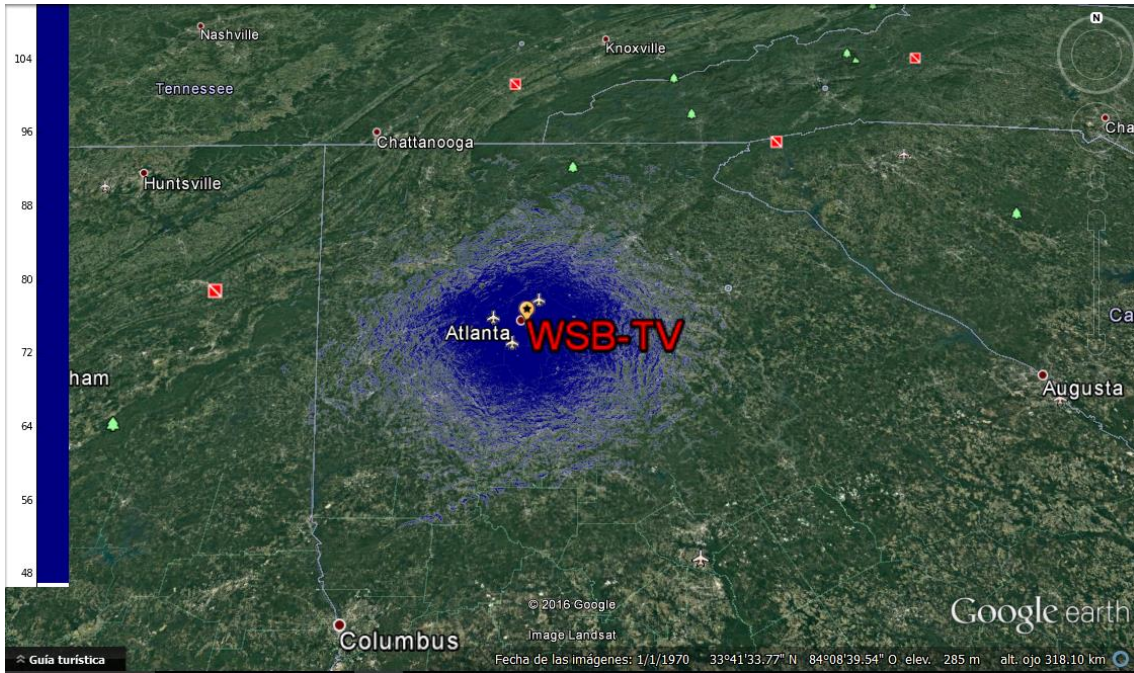

Figure 60. Coverage map of portable service with a 4.3 Mb/s rate with portable reception in UHF band

With the purpose of performing a comparison between different frequency bands with the same service, a portable service with portable reception in VHF band has been used to estimate the supposed coverage gain.

When the frequency is modified, the transmission mode is the same, but the field strength threshold level varies, being for channel 7, 175 MHz, a value of 35.685 dB μ V/m. Its map turns out to be this way:

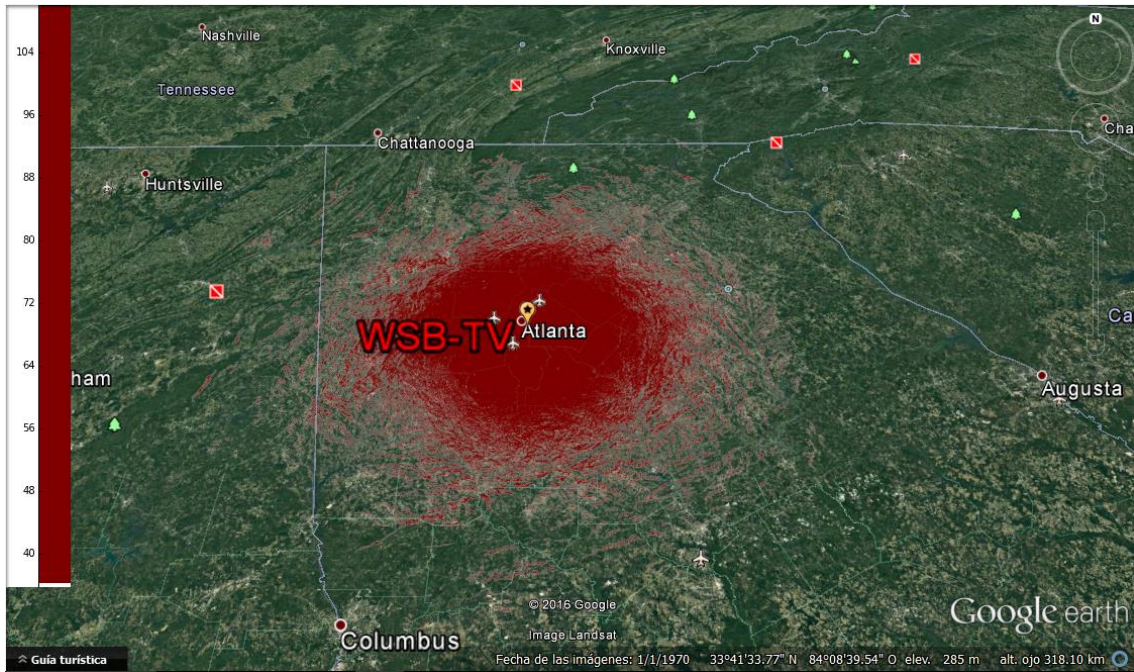

Figure 61. Coverage map of portable service with a 4.3 Mb/s rate with portable reception in VHF band

Regarding to the fixed service in VHF band, it is supposed to transmit a B-A service. Thus, in order to obtain B service, it is necessary to receive in fixed reception the fixed service B-A and portable service A.

$$B = A + (B - A) \quad (5.1)$$

So, it is mandatory receiving the portable service in UHF called A described in table 9, but using the SNR AWGN channel value, not Rayleigh as used, because in that case it was portable reception, and now it is a fixed reception case. Hence, it will have a value of 0.3 dB with field strength threshold of 36.952 dB μ V/m. So its coverage map is shown below:

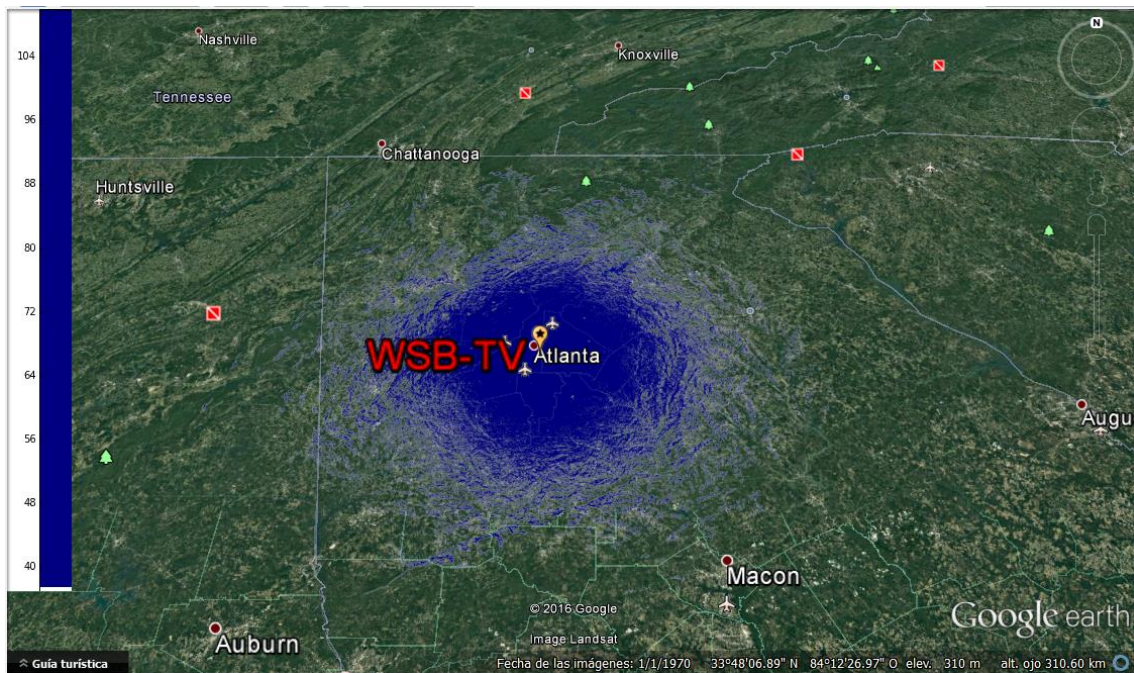

Figure 62. Covering map of the portable service with a 4.3 Mb/s rate with fixed reception in UHF band

In respect of the fixed service B-A with fixed reception, transmission mode of table 11 will be used, and transmitting in this case in channel 7 with 175 MHz has a field strength threshold of 41.285 dB μ V/m, and then its coverage map is:

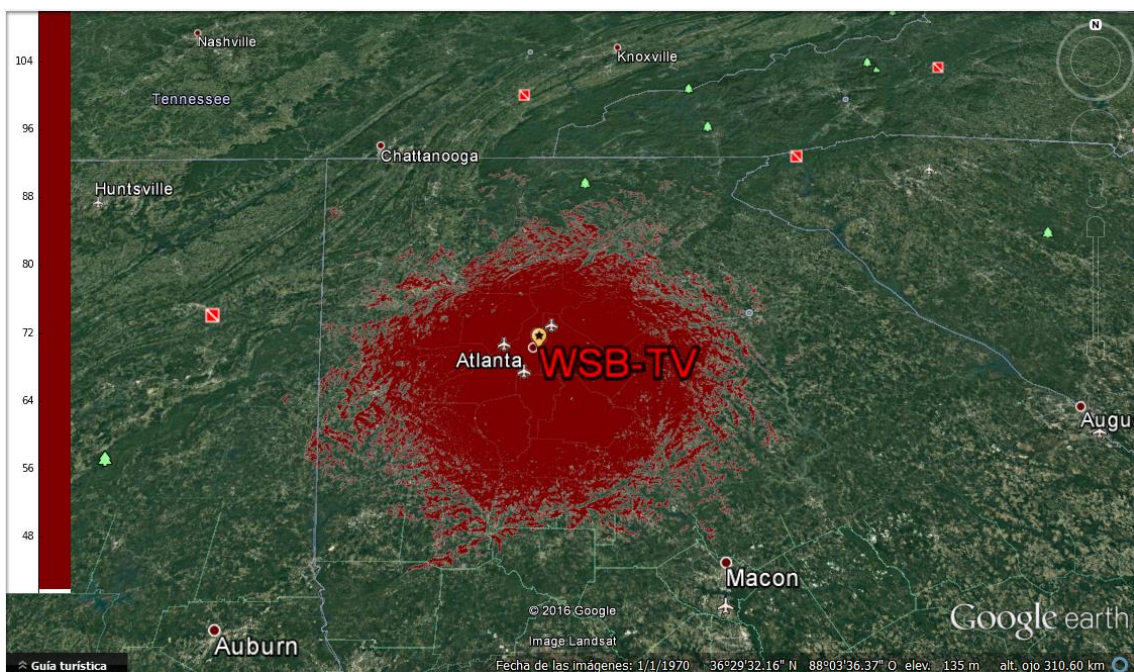

Figure 63. Coverage map of fixed service with a 25.5 Mb/s rate with fixed reception in VHF band

Also in order to compare as the previous service, a simulation scenario where the fixed service is transmitted in the UHF band has been performed, with the only difference of transmitting

through channel 38 with the frequency of 615 MHz. Its correspondent field strength threshold is 52.202 dB μ V/m, and its coverage map is as follows:

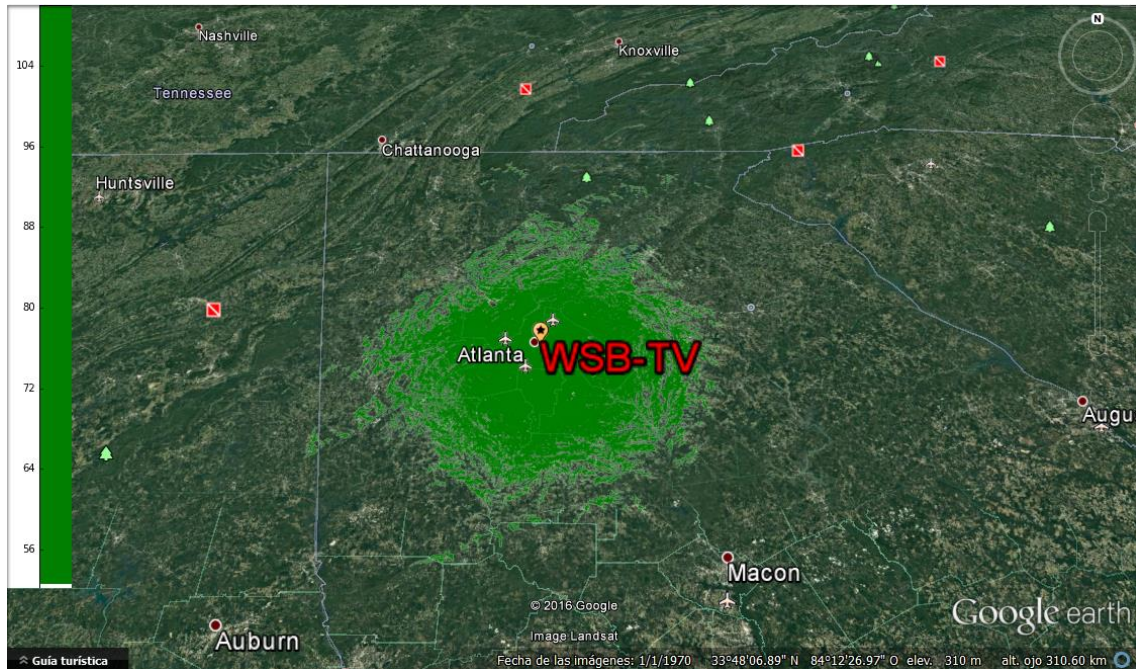

Figure 64. Coverage map for fixed service with a 25.5 Mb/s rate with fixed reception in UHF band

5.3.2 SNR Averaging

In this case, as it is explained in its respective section, ATSC 3.0 limits this technique use to the fact that the MODCOD have to be the same for both channels. With that purpose, it has been studied the improving in this technology with regards to the UHF-UHF Plain Channel Bonding case.

The procedure has been as follows. First of all, the both .npy files obtained with the simulation using the frequencies of channel 14 and 50 have been employed. Then, the matrixes with the field strength values have been averaged this way modifying the *ATL-SFN-Array-RSS-Combine.py* code, exporting the result in a map:

```
WSB_TV473 = np.load("82.0-87.0-36.0-31.0-WSB-TV-473MHz.npy")
WSB_TV689 = np.load("82.0-87.0-36.0-31.0-WSB-TV-689MHz.npy")

ss = pow(10,WSB_TV689/10)/2+pow(10,WSB_TV473/10)/2
rss = 20*np.log10(np.sqrt(ss))
```

Figure 65. Modification of *ATL-SFN-Array-RSS-Combine.py*

Afterwards, the field strength threshold has been obtained using a middle frequency as an approximation, exactly with a 581 MHz value. So, the table 11 transmission mode, broadcasted in a frequency of that value, has a threshold of 51.708 dB μ V/m. Its coverage map is as shown below:

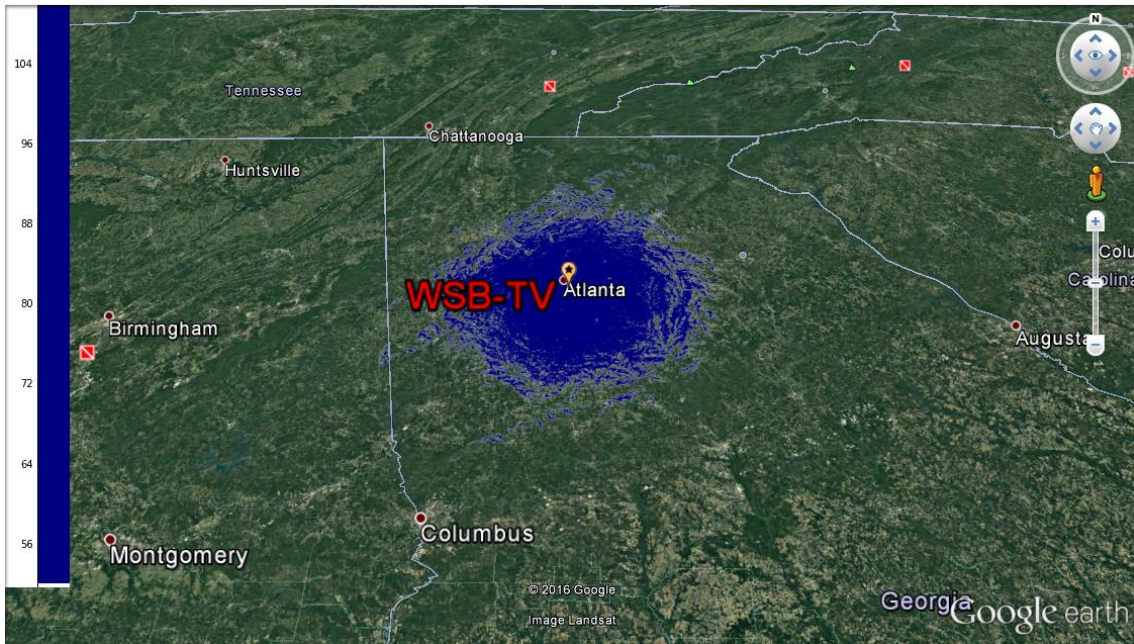

Figure 66. Coverage map for UHF-UHF Plain Channel Bonding case using SNR Averaging

5.4 MIMO

As it is detailed in section 3.4.3, MIMO implementation in ATSC 3.0 is based in a MIMO 2x2 technology with the employment of crossed polarizations, one vertical and one horizontal.

With the objective of checking if there is any difference between the coverage of both polarizations, two simulations of the same transmission mode in the same channel with the WSB-TV transmitter have been made, only changing the polarization parameter in .lrf file as it can be seen in figure 19, obtaining these results.

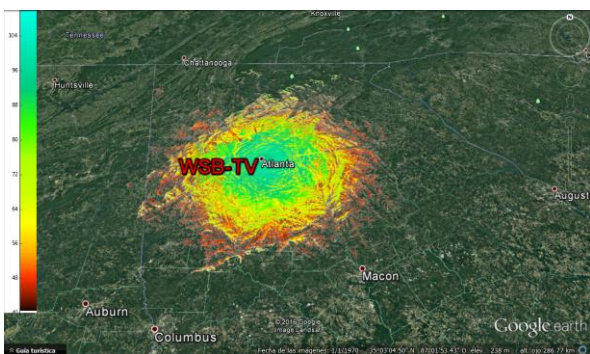

Figure 67. Horizontal polarization study

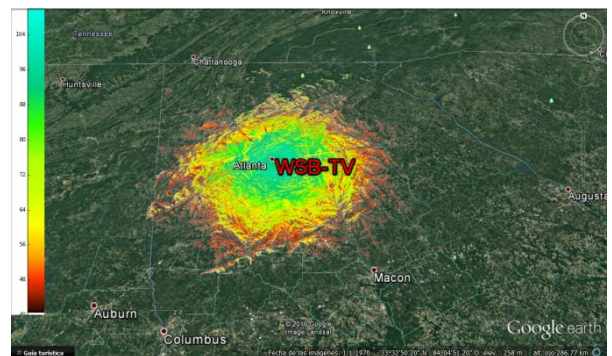

Figure 68. Vertical polarization study

As it can be appreciated in the figures, the results are identical. So, in the coverage studies, the polarization mode used is regardless of what the results are.

In respect of this MIMO technology, a comparison between gain in SNR and capacity with SISO technology in Forsyth transmitter is made. This comparative graph is used.

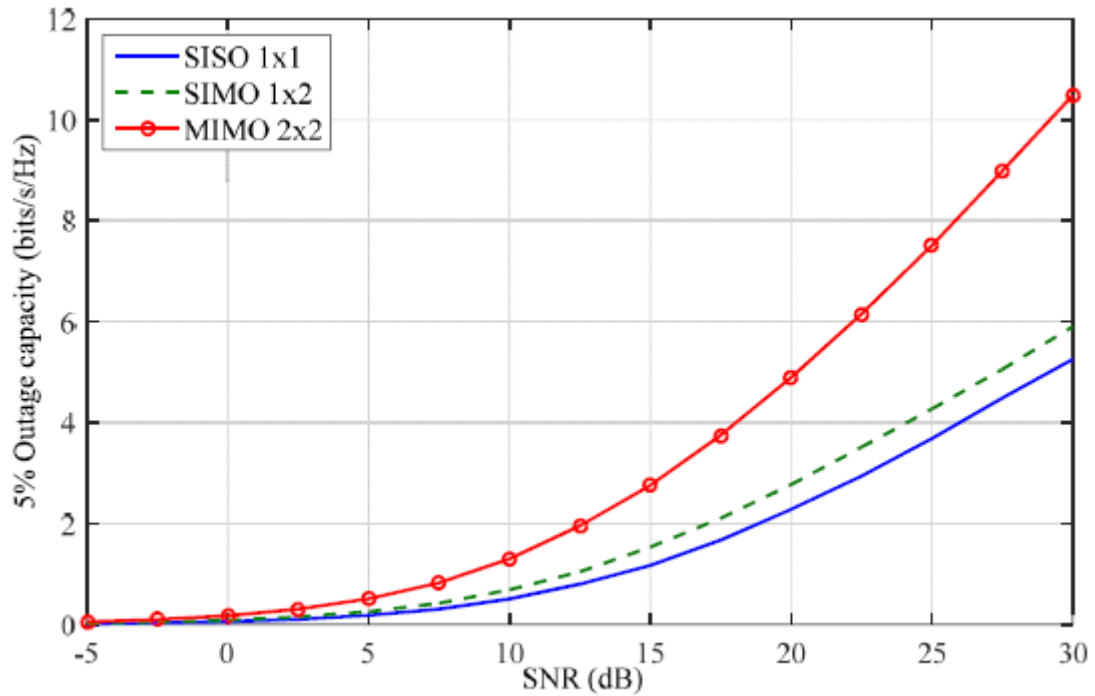

Figure 69. SNR and capacity comparison between SISO, SIMO and MIMO in a MGM channel for rooftop reception [5]

In a MGM channel, the 9 dB of deviation calculated in figure 37 has been already taking into account.

Therefore, in order to perform the comparison, it starts from existent SISO modes which their capacity is known.

	6MHz	64800 LDPC	BCH	256QAM								
	2/15	1/5	4/15	1/3	2/5	7/15	8/15	3/5	2/3	11/15	4/5	13/15
Capacity (bits/s/Hz)	1,0430	1,5763	2,1096	2,6430	3,1763	3,7096	4,2430	4,7763	5,3096	5,8430	6,3763	6,9096
Bit Rate (6MHz) [Mbps]	6,26	9,46	12,66	15,86	19,06	22,26	25,46	28,66	31,86	35,06	38,26	41,46

Table 15. Existent SISO modes with several characteristics and respective bitrate and capacity. [16]

First of all, the SISO mode with 256 QAM modulation and 9/15 code rate is employed. As it can be seen, its capacity in bits/s/Hz is 4.7763. This corresponds to a SNR close to 28 dB in an MGM channel as it can be appreciated in the next figure:

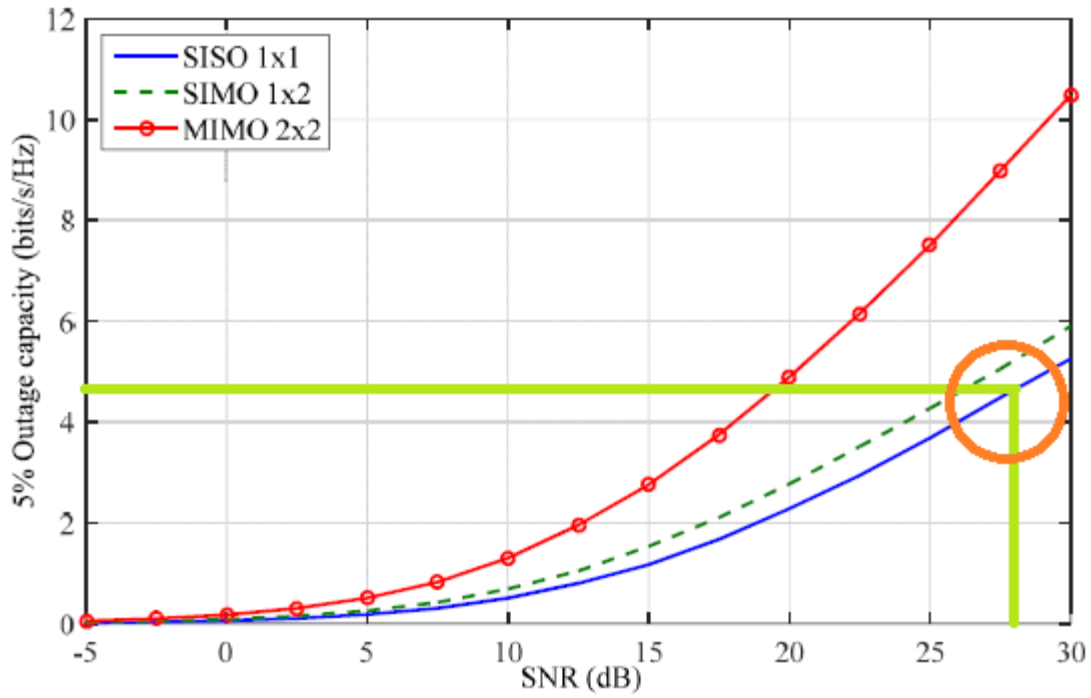

Figure 70. In green continuous, capacity and SNR of SISO mode with 256 QAM modulation and 9/15 code rate in a MGM channel

This mode, using the channel 38 with a frequency of 615 MHz, has a field strength threshold of 55.652 dB μ V/m. So, its coverage map is as follows:

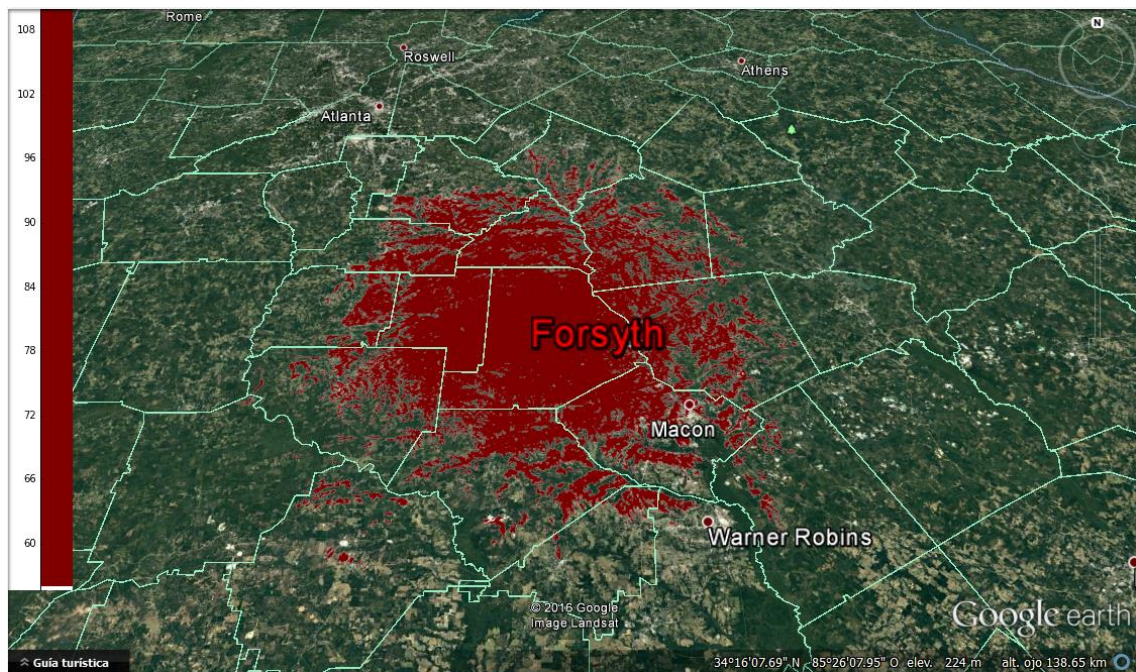

Figure 71. Coverage map of the service with SISO with SNR of 28 dB, capacity of 4.77 bits/s/Hz and a threshold of 55.652 dB μ V/m

Once the coverage in SISO mode is obtained, the comparative is performed in two aspects:

- Maintaining the same coverage, in other words, the same SNR, and transmitting in the same channel, the same field strength threshold. So, the capacity will increase, being in this case a value close to 9.5 bits/s/Hz.

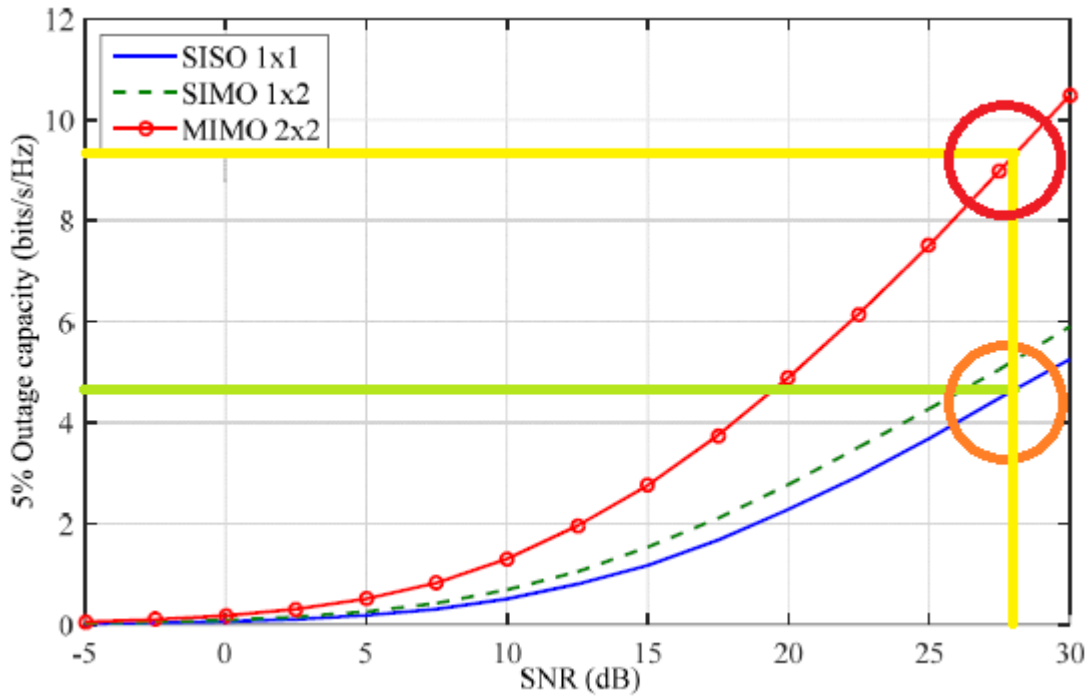

Figure 72. In yellow, capacity and SNR of the MIMO mode with 256 QAM modulation and 9/15 code rate in a MGM channel

- Maintaining the same capacity of 4.7763 bits/s/Hz, compare what SNR reduction is produced with MIMO mode.

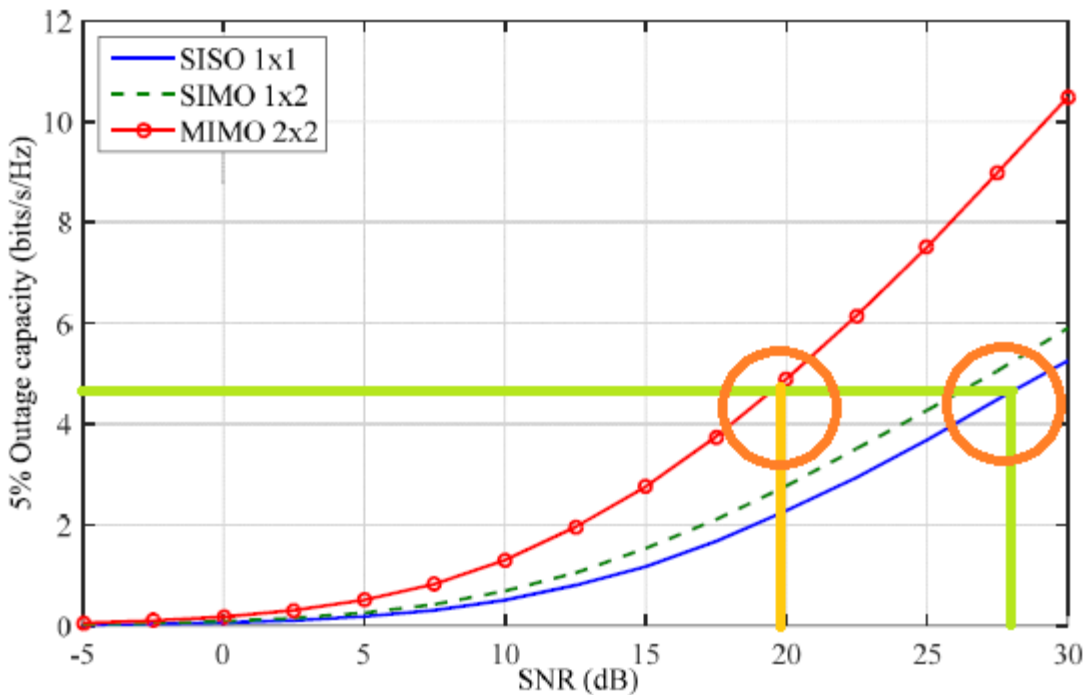

Figure 73. In light orange, SNR of the MIMO mode with 256 QAM modulation, 9/15 code rate in a MGM channel with a capacity of 4.7763 bits/s/Hz

In this case, the SNR is close to 20 dB, what involves using the same channel a field strength threshold of 47.652 dB μ V/m, with a coverage map shown below:

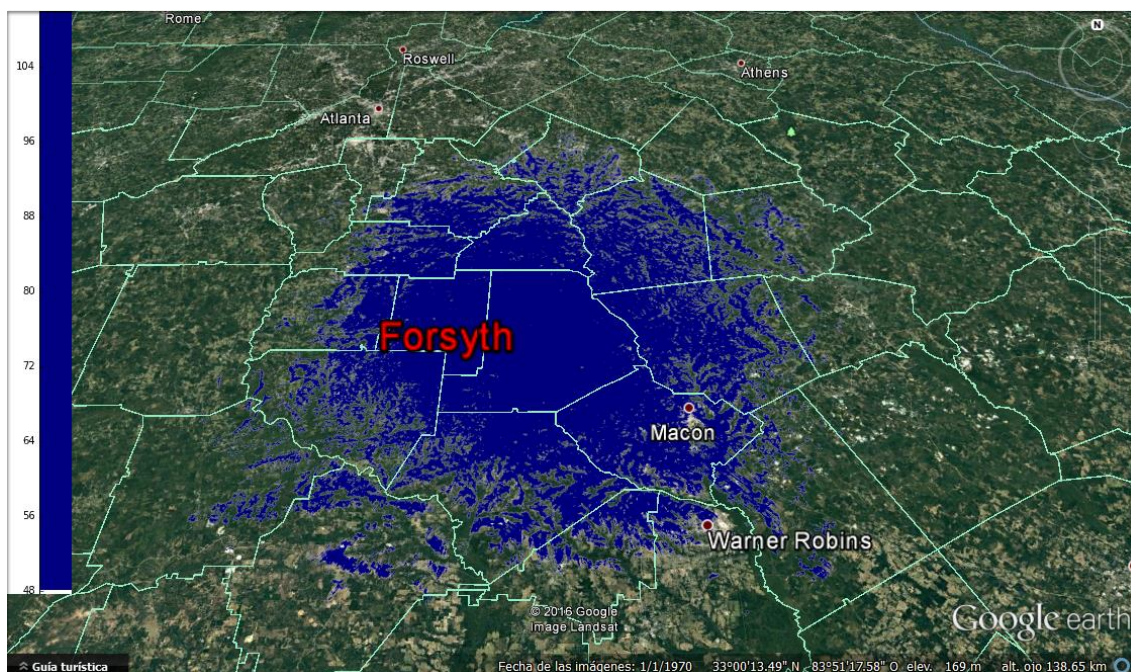

Figure 74. Coverage map of the service with MIMO with 20 dB of SNR, capacity of 4.77 bits/s/Hz and a threshold of 47.652 dB μ V/m

At last, but not least, after the comparative maintaining the capacity or the SNR, a last scenario is made where MIMO is employed using the half of power in the antennas. In other words, the addition of the ERP of both antennas used, vertical and horizontal polarization, is equal to the power employed in SISO.

As it can be seen in table 5, the ERP employed in this transmitter is 250 kW. So a single study has been realized, taking into account the fact that the difference of coverage using different polarization is zero, with an ERP of 125 kW, as it shown in the following figure.

1	15.000	; Earth Dielectric Constant (Relative permittivity)
2	0.005	; Earth Conductivity (Siemens per meter)
3	301.000	; Atmospheric Bending Constant (N-Units)
4	615.000	; Frequency in MHz (20 MHz to 20 GHz)
5	5	; Radio Climate
6	0	; Polarization (0 = Horizontal, 1 = Vertical)
7	0.95	; Fraction of situations
8	0.99	; Fraction of time
9	76208	; ERP in watts (125 kW reduced by 2.14 dB to offset SPLAT EIRP gain)
10		

Figure 75. Forsyth.lrp file used with the ERP reduction

These 76208 watts comes from:

$$125000 \text{ watts} \rightarrow 50.96 \text{ dBdW}, \text{ minus } 2.14 \text{ dB are } 48.82 \text{ dBW} \rightarrow 76207.9 \text{ watts} \quad (5.2)$$

After performing the simulation, maintaining the field strength threshold of 55.652 dB μ V/m used in SISO, the coverage map is this way:

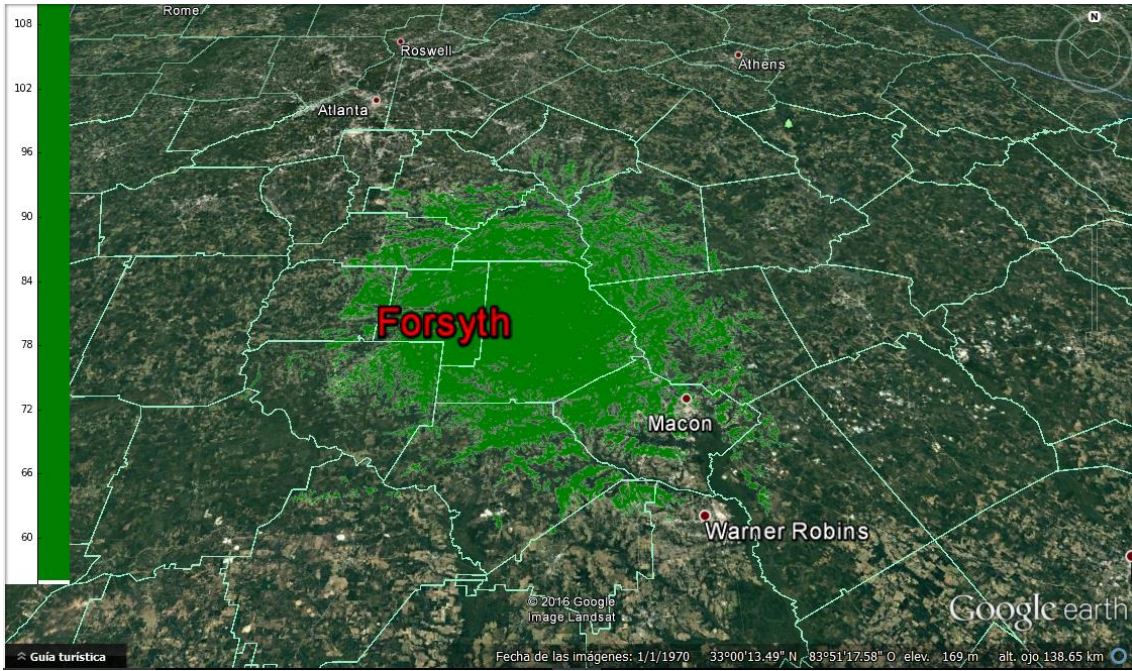

Figure 76. Coverage map of the service with MIMO with a 28 dB SNR, capacity of 9.5 bits/s/Hz and a threshold of 55.652 dB μ V/m, but using the half of the transmitter power.

Chapter 6. Results and discussions

In this chapter, the results of the simulation scenarios commented in the previous chapter are detailed.

LDM

Heading to the LDM case, in the section 5.2, there are important differences between the results in fixed and portable service in respect to the coverage.

Regarding to the fixed service, the same simulation is used for both cases, since their SNR are similar, and then, their coverage. Nevertheless, this is achieved with a very less robust transmission mode in TDM, due to the fact that a higher rate is needed because of the percentage of the time resources, in comparison to LDM, which SNR is influenced by the *injection level* parameter.

As it can be appreciated comparing tables 8 and 10, a same SNR is obtained with a rate of 33.4 Mb/s in LDM employing 256 QAM modulation, in comparison with a rate near to the 48 Mb/s in TDM with a 1024 QAM modulation, that ends up providing the same LDM rate using the 70% time resources. This is due to the fact that the -4 dB of *injection level* in LDM make that only a 28% of the power is dedicated to the fixed service, as detailed in section 3.4.1. As a comparative, the transmission mode of table 10, with no *injection level*, would have a SNR with a value of 22.22 dB in an AWGN channel, instead of the 27.68 dB, but with the same rate.

However, there are substantial differences in respect of the coverage in portable service using LDM technology. As the fixed service is vital in digital television, and if a high percent of time resources is not assigned to it, it would be unavailable. Hence, the portable service has only a 30% of those resources. This involves the requirement of a three times greater rate than the necessary for a specific portable service in this technology. Therefore, as in LDM with a -4 dB *injection level* makes a 72% of power assignment to the Core Layer service, the difference of coverage is appreciable as it can be seen in the image below:

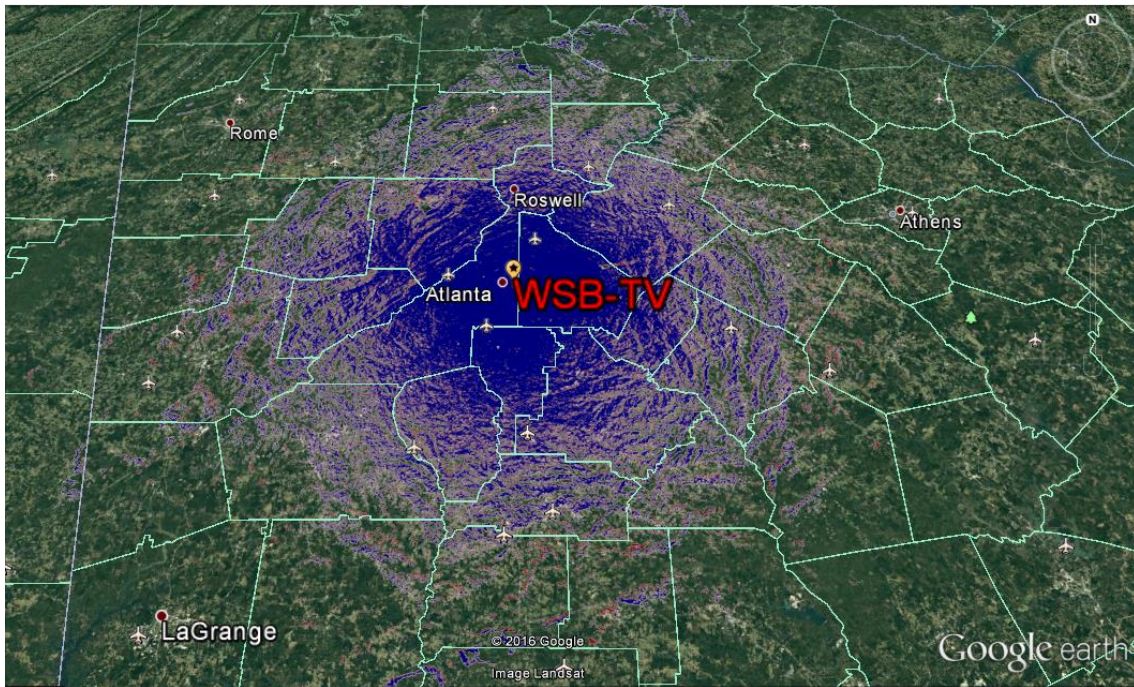

Figure 77. Overlapping of coverage maps with the same rate using LDM (red) and TDM (blue).

Specifically, a coverage gain near to 25.68% in LDM with respect to TDM, because of its more robust transmission mode.

Channel Bonding

Squarely with Channel Bonding, the distinction between the two types has to be made, Plain Channel Bonding with its cases with the use of UHF-UHF and VHF-UHF, and SNR Averaging.

Firstly, two comparisons have to be highlighted in UHF-UHF simulation cases. One in respect of the variation of the coverage in the use of channels from a same frequency band, and another with the use or not of this technology, both in capacity and coverage.

As it is detailed in section 3.4.2, Channel Bonding is based on the division of a great data stream in order to transmit it through two independent channels, not necessary adjacent. In Plain Channel Bonding case, the loss of one of these two channels means the unavailability of the recovery of the original stream, so the service will be lost. Therefore, the coverage of a service with the use of this technology will be defined by the worst coverage of both channels. In other words, the one which has the higher field strength threshold.

Following this criterion, for the employment of two channels for a fixed service in the same UHF frequency band, it has been used the most separated channels in that band in order to study the influence of the frequency in coverage, as it is detailed in the previous chapter.

So the overlapping coverage map is as follows:

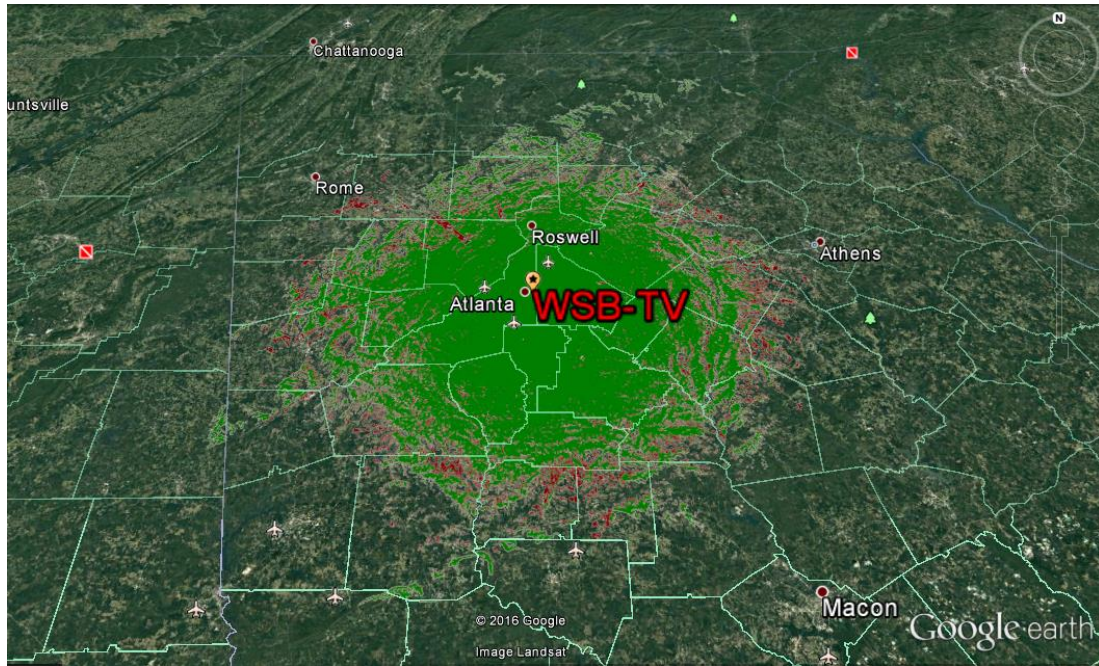

Figure 78. Overlapping of coverage maps of channel 14 (red) and channel 50 (green)

Thus, the coverage map using Channel Bonding with a 51 Mb/s rate, as every of both channels has a 25.5 Mb/s rate, is the green footprint, because of the greater the frequency, the less the coverage. The maximum difference of coverage of two UHF channels transmitting the same mode and same rate is about a 20.5%.

In comparison, if it is required of transmitting the 51 Mb/s payload achieved with Channel Bonding in one single channel, the coverage is going to be so much small due to the fact that the transmission mode is less robust. There is a clear difference between the coverage of a transmission mode with a 25.5 Mb/s rate and one with 51 Mb/s, exactly the one in table 14, as it can be seen next:

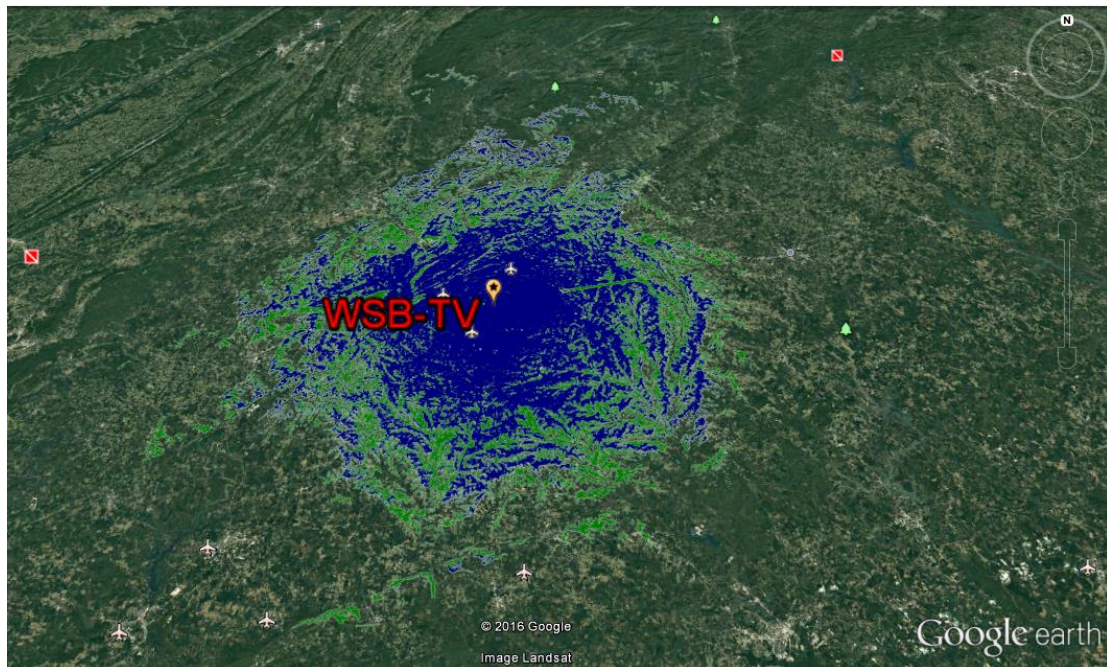

Figure 79. Overlapping of coverage maps using Channel Bonding (green) and without it (blue) for the same rate.

For a fixed service, in this case of 51 Mb/s rate, the coverage gain respect of the use of Channel Bonding technology is about 53.23% in comparison to not using it.

In addition, apart from the gain in coverage, it is important standing out the flexibility that provides as it is commented in section 5.3.1.1. Whereas with two separate channels with no Channel Bonding implementation with a 25.5 Mb/s rate is unavailable to transmit three programs with UHDTV content, due to the fact that a rate of 15 Mb/s for each one is required, with Channel Bonding use is possible because of the combination of both data streams from two channels in order to obtain the 51 Mb/s rate, maintaining in this way the coverage map of the 25.5 Mb/s rate mode.

However, in the VHF-UHF mode case, it is also about mobile reception, as it is detailed in section 5.3.1.2. In this case, the comparison will be the use of each frequency band with every service.

As it is known, the frequency has an influential factor in transmission. So depending on the channel used to broadcast, the reception will be different due to the path losses.

Then, for portable service and portable reception, the comparison between UHF frequency band and VHF frequency band has been made, as it can be seen below:

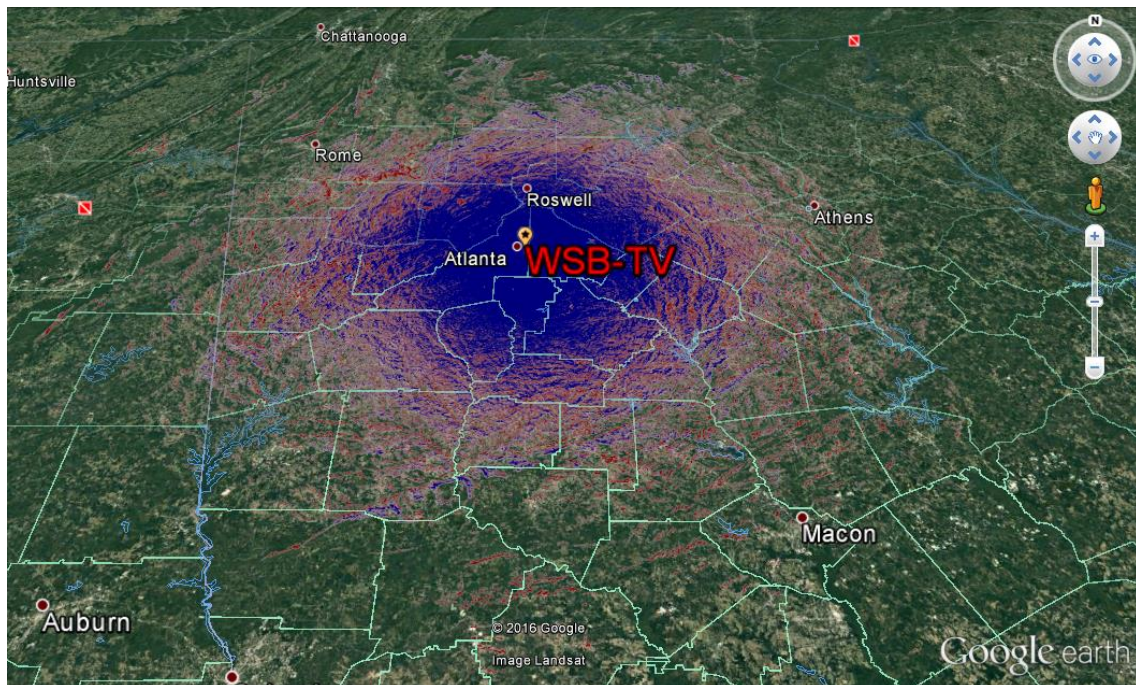

Figure 80. Overlapping of coverage maps using VHF band (red) and UHF band (blue) for portable service and reception.

The difference is an increase of the coverage in an 82.26% using VHF respect to using UHF. Nevertheless, the size of VHF antennas makes unfeasible this option, so UHF is used for portable service.

In the same way, the same case with fixed service has been studied.

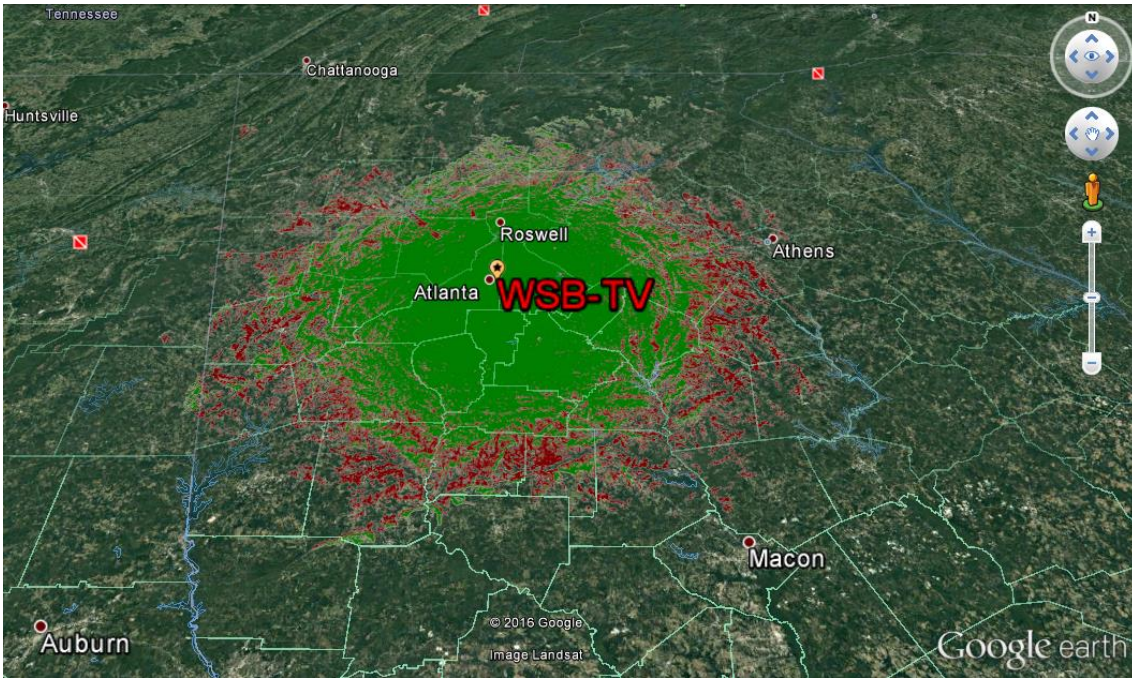

Figure 81. Overlapping of coverage maps using VHF band (red) and UHF band (green) for fixed service and reception.

In this case, the gain is about 47.78%. But the portable service is needed to be received in fixed reception to get the final B service commented on the previous chapter. So, the coverage will be defined by the worst coverage map, as it is a Plain Channel Bonding case. Therefore, the final map is as follows:

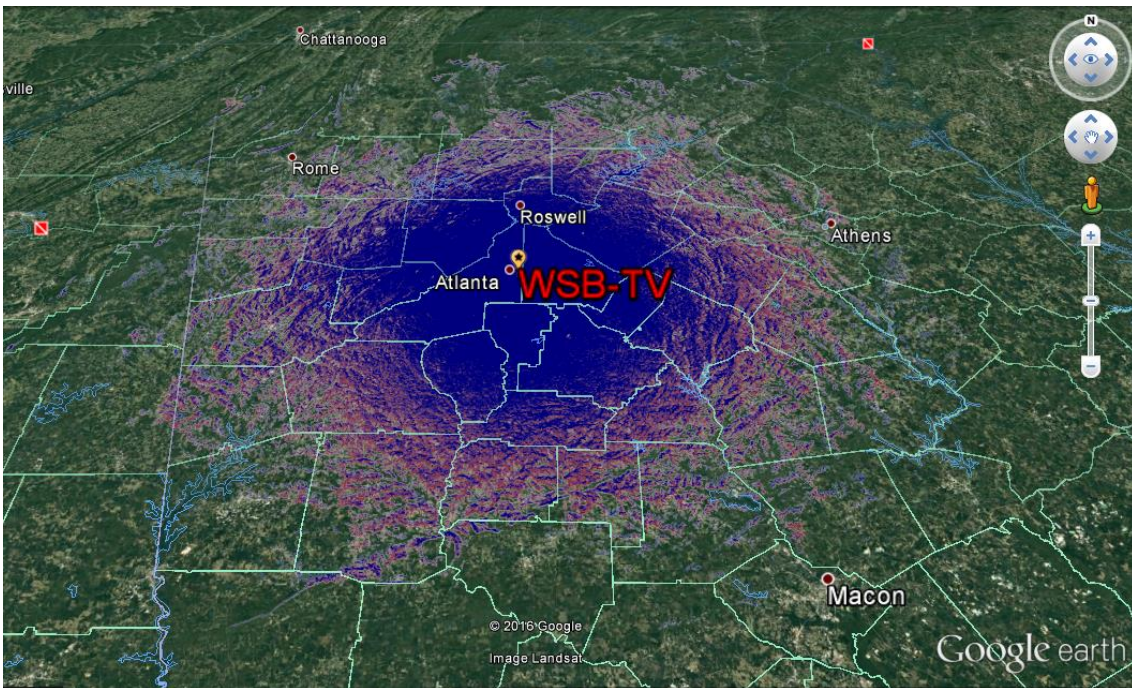

Figure 82. Overlapping of coverage maps using VHF band (red) for fixed service and UHF band (blue) for portable service, both in fixed reception.

Finally, the SNR Averaging case has been studied as explained in section 5.3.2. This mode is used for improving coverage respect from Plain Channel Bonding. As it has been explained, a SNR averaged value is presented. The coverage map is shown next:

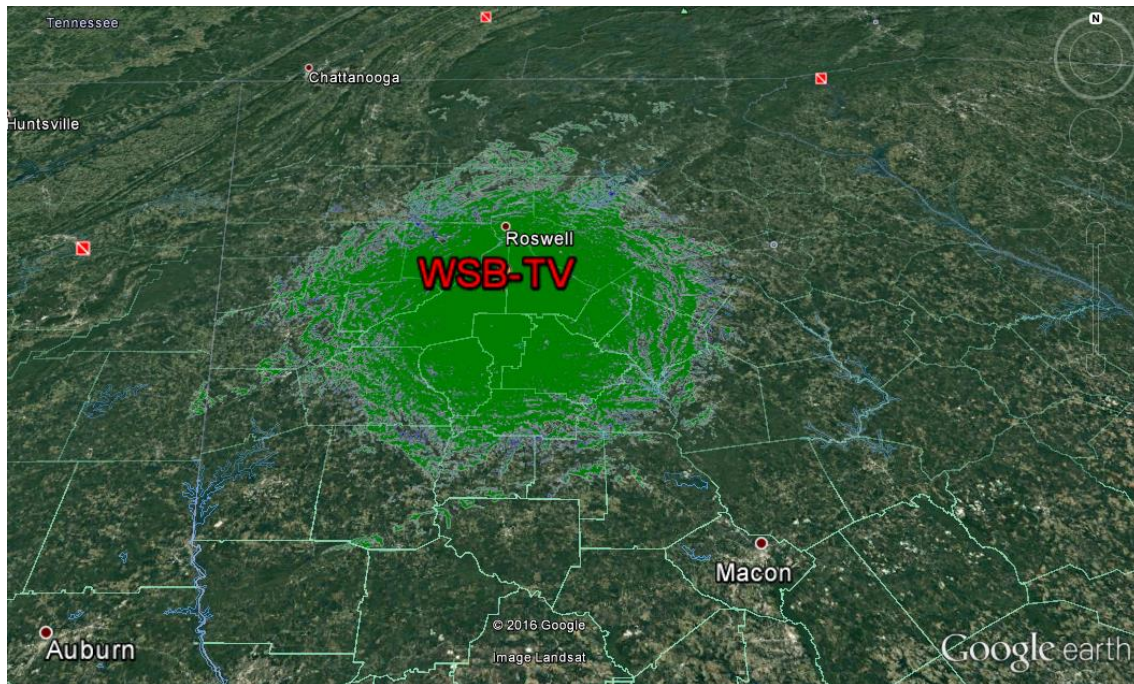

Figure 83. Overlapping of coverage maps using SNR Averaging (blue) and Plain Channel Bonding (green).
 The gain in coverage is approximately about 9.37% in the UHF-UHF case.

MIMO

Last but not least, regarding to MIMO technology, it is known that in ATSC 3.0 is implemented with two different polarized antennas, as it is explained in section **3.4.3**.

At first, a single simulation case was made where only the polarization of the antenna, vertical and horizontal, was changed in both studies. The obtained result has been that in ITM propagation model, there is no coverage variation between them, also because of when the parameter is changed, is changed in both transmitter and receiver antennas.

Then, starting from that idea where a map coverage of a transmission mode using a horizontal polarization is the same as using the same mode but with a vertical polarization antenna, only studies with horizontal polarization antennas have been made.

The comparisons with this technology have been made following the figure **69** graph, which relates capacities and SNR between SISO and MIMO. Choosing an existing transmission mode, specifically one from table **15** and detailed below it, it is observed to have an SNR value of 28 dB and a capacity of 4.77 bits/s/Hz, as it can be seen in figure **70**.

From here, two comparisons have been performed. The first one, with the maintenance of the SNR value for an MGM channel, and seeing what capacity has for a MIMO transmission estimating the same coverage. As it is shown in figure **72**, the resulting capacity is 9.5 bits/s/Hz, being twice the rate of SISO.

Whereas in the second one, based on figure **73**, it is wanted to know what coverage level has a MIMO transmission mode with a capacity of 4.77 bits/s/Hz. It is observed that such transmission mode has an SNR level nearby 20 dB. So, the overlapped coverage map of MIMO and SISO is like this:

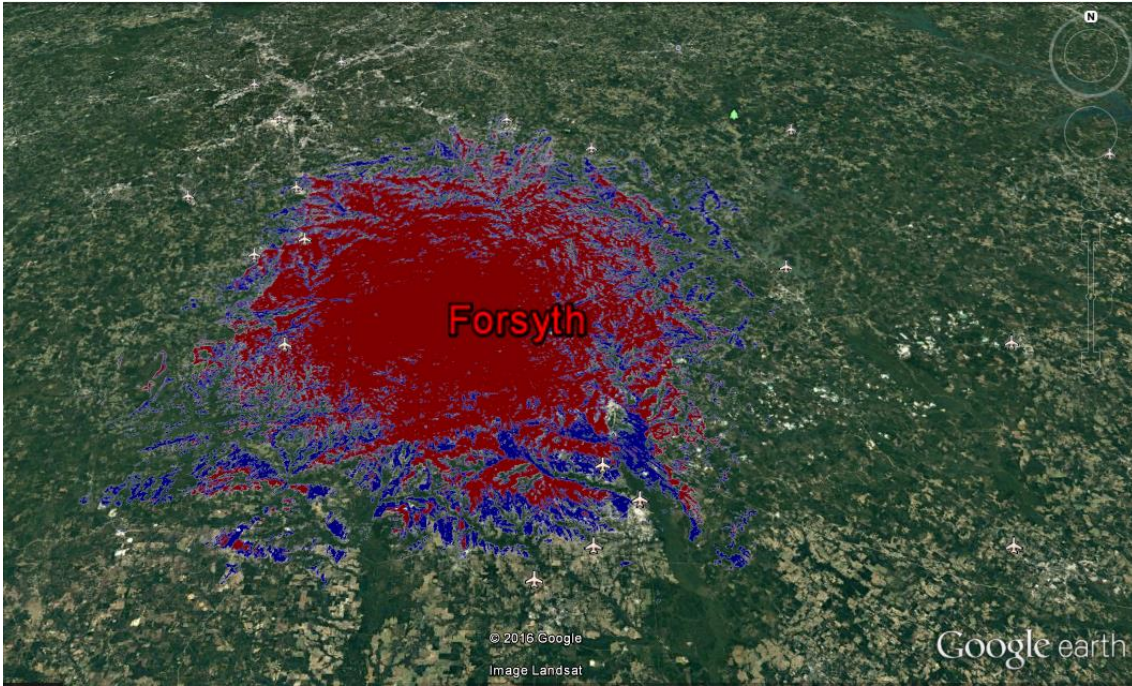

Figure 84. Overlapping of coverage maps using MIMO (blue) and SISO (red) for the same payload.

Therefore, in this concrete transmission mode, the use of MIMO technology involves a coverage gain of 47.20% in comparison to SISO technology use.

Finally, with the purpose of looking for a power saving, a study case has been made where, maintaining the coverage that the mode would have in SISO mode, its performance reducing by a half the ERP of the transmitter antenna has been studied. So, its coverage map is as follows:

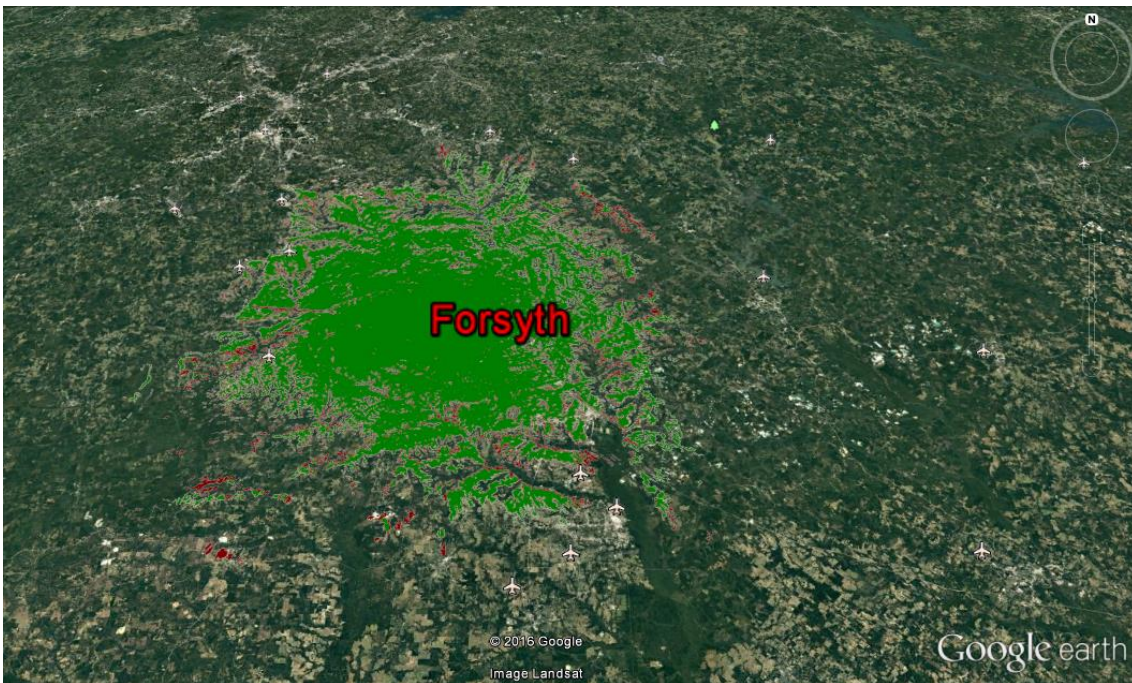

Figure 85. Overlapping of covering maps using MIMO with the half of ERP and a rate of 9.5 bits/s/Hz (green) and SISO (red) for the same SNR with a rate of 4.77 bits/s/Hz

This involves a 25% less coverage in MIMO than SISO, but with a double rate.

Chapter 7. Conclusions

The conclusions derived from the study cases made in this thesis are as follows:

LDM allows broadcast two services in the same channel using the 100% of time and frequency resources through two layers with different power values.

So in this particular case, in comparison with TDM and obtaining the same rates, where an equal SNR for fixed service is achieved with a more robust transmission mode (due to the -4 dB of injection level and the 70% 30% of time resources in TDM), the portable service increases its coverage in 25.68%, which means 5.13 dB of SNR.

Regarding to Channel Bonding, it has the possibility of increasing peak rates with Plain Channel Bonding and SNR Averaging, and also its coverage using the last one.

In respect of the Plain Channel Bonding case using the same UHF frequency band, the maximum coverage difference employing the same transmission mode in this frequency band is approximately of 20.5% because the most separate channels has been used.

In addition, the transmission rate can increase using the technology. It is able to transmit one more 4K UHD TV program using this technology with two 25.5 Mb/s rate channels rather than not using it. Comparing the fact of obtaining the same service broadcast through a hypothetically single channel, the gaining coverage is about 53.23%, 15 dB of SNR.

About the VHF-UHF case, there is a difference of 82.26 % in coverage using VHF frequency band for portable service with portable reception instead of using the UHF frequency band. Nevertheless, there is impossibility due to the size of the antennas for mobile devices.

Difference of 47.78% can be observed in the same case, but fixed service. VHF band is used for fixed service sometimes.

Heading into the SNR Averaging case, this technology is used to improve the coverage of Plain Channel Bonding UHF-UHF case because the same MODCOD has to be used in both channels. So this technology improves the worst channel in the previous case in a 9.37%.

MIMO brings the opportunity of increasing both capacity and coverage. In this concrete case, using the existent transmission mode of 28 dB of CNR, doubles capacity. From 4.77bits/s/Hz to 9.55bits/s/Hz.

Maintaining the same capacity of 4.77bits/s/Hz, it improves the coverage in a 47.20%. 8 dB of CNR, which 3 dB of them are based on the double power use.

And finally, employing the capacity of 9.55bits/s/Hz in MIMO, using the half ERP value in transmitters, there is a penalty in SISO coverage about a 25%.

Chapter 8. Future trends

Regarding the possible continuation of this thesis, it would be essential detailing all the study cases, both with physical layer simulations and measures made in the laboratory. In addition, the performance of simulation with field measures would be important to evaluate the coverage of every transmission technique.

An SFN study of each technology can be made taking into account the SFN distance and echoes where several signals can be considered as a contribution, or interference, employing different transmitters.

Also, an interference study between transmitters in MFN can be performed. The influence of frequencies can be measured in this type of study.

Completing the study cases made in this thesis, populate studies can be made where the amount of people covered can be quantified, requiring census data.

Specific studies can be performed in the area treated in this thesis taking into account the broadcasters preferences. The specifications they can provide can determine the transmission modes in order to make even more realistic studies.

Chapter 9. Bibliography

- [1] Fay, L.; Michael, M.; Gómez-Barquero, D.; Ammar, N. and Winston Caldwell, M. “An Overview of the ATSC 3.0 Physical Layer Specification” *IEEE Trans. Broadcast*, vol. 62, no. 1, pp. 159-171, March 2016.
- [2] Advanced Television Systems Committee “ATSC Working Draft: Core Broadcast Services. Preliminary Report” November 2015.
- [3] Park, S. I.; Lee, J.-Y.; Kwon, S.; Lim, B.-M.; Kim, H. M.; Hur, N.; Myoung, S.; Montalbán, J.; Angueira, P.; Zhang, L.; Wu, Y. and Kim, J. “Low Complexity Layered Division Multiplexing for ATSC 3.0” *IEEE Trans. Broadcast*, vol. 62, no. 1, pp. 233-243, March 2016.
- [4] Stadelmeier, L.; Schneider, D.; Zöllner, J. and Giménez J. J. “Channel Bonding for ATSC 3.0” *IEEE Trans. Broadcast*, vol. 62, no. 1, pp. 289-297, March 2016.
- [5] Gómez-Barquero, D.; Vargas, D.; Fuentes, M.; Klenner, P.; Moon, S.; Choi, J.-Y.; Schneider, D. and Murayama, K. “MIMO for ATSC 3.0” *IEEE Trans. Broadcast*, vol. 62, no. 1, pp. 298-305, March 2016.
- [6] Magliacane, J. “Documentation of SPLAT! in English” <http://www.qsl.net/kd2bd/splat.pdf> [Online]
- [7] Institute for Telecommunication Sciences “Irregular Terrain Model (ITM) (Longley-Rice) (20 MHz-20GHz) <http://www.its.bldrdoc.gov/resources/radio-propagation-software/itm/itm.aspx> [Online]
- [8] Raybaut, P. and Cordoba, C. “Spyder Package Documentation” <https://pypi.python.org/pypi/spyder> [Online]
- [9] Matplotlib, “Pylab example code: custom_cmap.py” http://matplotlib.org/examples/pylab_examples/custom_cmap.html [Online]
- [10] Python Software Foundation, “Python 3.5.2 Documentation” <https://docs.python.org/3/> [Online]
- [11] Kutzner, J. A. and Lung, D. “Predicting ATSC 3.0 Broadcast Coverage” *IEEE Trans. Broadcast*, vol. 62, no. 1, pp. 281-288, March 2016.
- [12] De Diego, M.; “Notes of the subject *Digital Communications*, Bachelor’s Degree in Telecommunications Technology Engineering” 2016
- [13] EBU “Frequency and Network Planning Aspects of DVB-T2” *Tech 3348*, October 2014.
- [14] Hernando Rábanos, J. M. “Transmisión por radio” Editorial Universitaria Ramón Areces, 2008
- [15] EBU “TV Programme Accommodation in a DVB-T2 Multiplex for (U)HDTV with HEVC Video Coding” *TR 036*, March 2016.

[16] Advanced Television Systems Committee “ATSC 3.0 Simple Capacity Spreadsheet” 2016