Self-sufficient floating house for students in Groningen

Materials for upper structure and Modularity

(09/06/2017)

GRADO EN ARQUITECTURA TÉCNICA (MODALIDAD DE INTERCAMBIO-MOVILIDAD)

TRABAJO FIN DE GRADO - CURSO 2016-17

AUTOR:

JORGE R. FORÉS MONTESINOS

TUTOR ACADÉMICO UPV:

[Milagro Iborra]



UNIVERSITAT
POLITÈCNICA
DE VALÈNCIA



ESCOLA TÈCNICA SUPERIOR
ENGINYERIA
D'EDIFICACIÓ

ETS d'Enginyeria d'Edificació
Universitat Politècnica de València

Abstract

Currently in the city of Groningen the number of students is increasing because the education is the city's greater economic activity, therefore is appearing the necessity to create more residences for students. To try not to expand more the residential area, the project aims to take advantage of the water surface available throughout the city.

In addition to solve the need of number of residences the project will be developed from a sustainable point of view. Fortunately the construction sector is realizing the great negative impact it has on the environment and the need to proceed on a different way, there is a clear trend nowadays to produce sustainable buildings, that is, to consume the minimum possible amount of resources during its construction process and in its useful life. Therefore, this trend will be followed by applying this criterion of sustainability as a basic principle of the project.

Throughout this work a project of floating and sustainable student residence will be developed focusing mainly on the analysis and application of the principles of sustainability on the foundation, the choice of materials for its construction and the integration of renewable energies. These will be the three themes that will be developed in more detail and which are expected to provide some improvement or innovation in its application in the project.

Contents

Abstract	iv
Introduction & Background	1
1 Introduction & Background	1
2 Stakeholders	6
3 Location	8
4 Foundations (Gironés)	9
4.1 Statement of Requirements(SoR)	9
4.2 Materials	11
4.3 Forms	13
4.4 Unions	14
4.5 Results of Analysis	15
4.6 Conclusion and Justification	16
4.7 Final Design	16
4.8 Materials used	17
4.9 Drawings	17
4.10 Calculations	18
4.11 Storage	20
5 Materials for Upper Structure (Forés)	21
5.1 Overview	21
5.2 State of requirements – Material selection criterion	21
5.3 Materials	23
5.4 Multicriteria Analysis	28
5.5 Calculations	29
5.6 Final Design	31
6 Supply Systems (Morant)	32
6.1 Overview	32
6.2 Statement of Requirements	32
6.3 Research data. Bioclimatic architecture	33
6.4 Research data. Supply systems	38
6.5 Summary	41

7	Modularity (Forés & Morant)	42
7.1	Overview	42
7.2	Introduction	42
7.3	Degrees of Modularity	43
7.4	Modular System applied	45
8	Environmental impact (Gironés)	46
8.1	Life cycle assessment	46
8.2	Study of environmental impact	46
9	Final Design (Forés & Morant)	48
10	Conclusions & Recommendations	55
A	Statement of Requirements Foundations (Gironés)	61
B	Justification of selection Foundations (Gironés)	65
C	Foundations Full Process (Gironés)	69
D	Calculations Foundations (Gironés)	82
E	Storage (Gironés)	87
F	Material Selection Criterion Upper Structure (Forés)	89
G	Analysis of Materials Upper Structure (Forés)	95
H	Transmittance Upper Structure (Forés)	114
I	Supply Systems (Morant)	119
J	Questionnaires	171
K	Emails Marinetek	176
L	Minutes of Meeting	181
M	Bibliography & References	188

Chapter 1

Introduction & Background

Introduction

Year after year, Groningen is becoming an even more important student city. Both the University of Groningen and Hanze University of Applied Sciences are increasing the number of students and staff. Demand for student housing has become a problem. In order to continue to offer to students an affordable and sustainable way of living in the city from the Kenniscentrum with the client Michael Bosscher came the idea of creating floating structures as accommodation. So the main question to be addressed in this project is: how can existing sustainable engineering technologies be integrated to create a self-sufficient floating houses for students in Groningen?

As an introduction to the context and analysis of the current market situation, some student housing agencies such as SSH or private agents have been consulted to find out what requirements and standards they have and how they can be achieved taking into account the most recent forms of sustainable construction. The construction of floating buildings is an expanding and developing topic. In order to analyze the different constructions already carried out, a study has also been carried out on previous projects that have already been carried out, as there are some companies that are already building individual floating houses in the Netherlands. Also taking into account the apartments of floating students in the city of Copenhagen, since the idea in terms of sustainability and use of space is similar to the one that wants to integrate in Groningen.

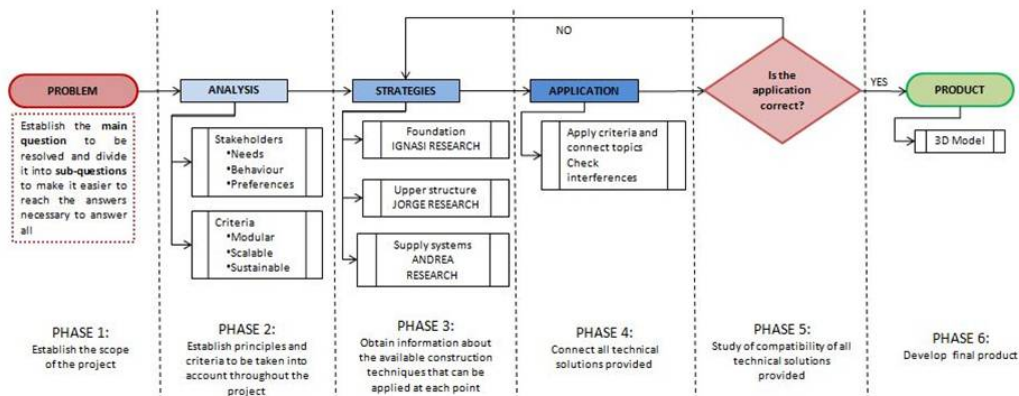

Figure 1.1: Process based thinking

Once the context has been set, four themes will be developed throughout the project that will be studied in more depth to finally combine them into a final product. The established process according to the technical competences is shown in image 1.1. With this process is set an investigation order. First of all, the starting point is the statement of requirements, which means, setting the boundaries for the project. This includes client's requirements, design requirements and boundaries. After this, starts the investigation about the different topics always considering the previous requirements in order to design different design alternatives that later on are going to be evaluated, calculated and drawn. Once all alternatives are explained, the optimal solution will be elected and explained in more detail. Following this process, all four technical competences are achieved.

These four topics are: Foundation, supply systems, building materials and modularity. These themes are developed from the principles that include sustainable and bioclimatic architecture trying to solve different sub-questions related to each theme.

- **Foundation** What kind of foundation can be built considering all client's criteria.
- **Materials** Which materials fulfill the project requirements?
- **Modularity** What strategies are available to make a modular building?
- **Supply Systems** How to make a self sufficient building?

These four themes are linked as the following diagram shows. To try to adapt all topics in the same project, it is aimed to solve the different connection among them.

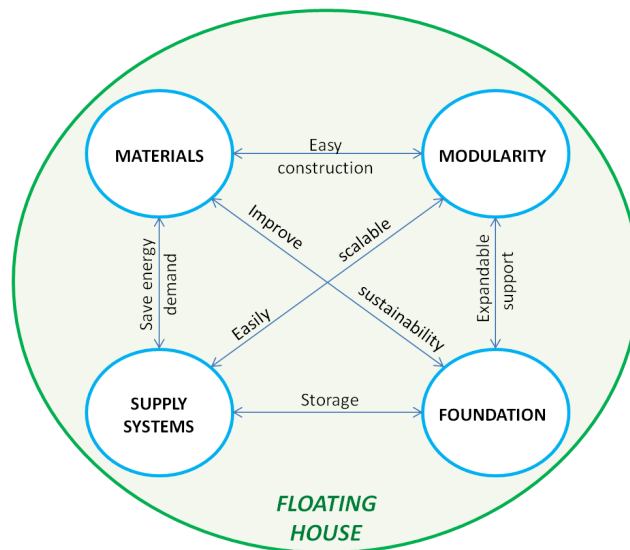

Figure 1.2: Interaction diagram

Regulations

Due to the lack of time and the complexity of investigating all the regulations involved in this project for each country, the group will set some bases for the design phase that later will be adjusted to the specific regulation for every location.

Design Conditions

ROOM	SURFACE (m ²)	HEIGH (m)	STAIR DIMENSION	m
Single room	6,20	2,50	Width	0,80
Double room	13,20		Headroom	2,30
Kitchen	5,60		Riser (maximum)	0,185
Dining room	8,00		Tread	0,23
Living room	9,00		Platform/Landing	0,80x0,80
Kitchen – Dining room	12,60		Handrail (high)	1,00
Living – Dining room	16,00			
Kitchen – Living – Dining room	18,00			
Bathroom	3,00	2,30		
Toilet	1,50			

Figure 1.3: Room specifications and stair dimensions (minimum)

The measures reflected here have been obtained from Dutch and Spanish construction regulations. The complete law can be consulted on the following links.

- "Código técnico de la Edificación". Spain.¹
- "Condiciones de diseño y calidad en la edificación". Spain (Valencia).²
- "Bouwbesluit". The Netherlands.³

Passive house standards

Passive Houses is a building standard that is truly energy efficient, comfortable and affordable at the same time. Following its principles, can be assured a sustainable and adaptable house. A passive house follows the next 5 principles, Depending on the climate zone the building is placed, minimum parameters for each strategy vary.

1. **Thermal insulation:** All opaque building components of the exterior envelope of the house must be very well-insulated.
2. **Passive houses windows:** The window frames must be well insulated and fitted with low-e glazings
3. **Ventilation heat recovery:** Efficient heat recovery ventilation is key, allowing for a good indoor air quality and saving energy.

¹<https://www.codigotecnico.org/>

²http://www.habitatge.gva.es/documents/20558636/90492723/TEXTTO_-+INTEGRADO_ORDEN_+DC09/5318acd9-47bb-4bba-8d17-5f06df1ca75c?version=1.0

³<http://www.bouwbesluitonline.nl/Inhoud/docs/wet/bb2012>

4. **Airtightness of the building:** Uncontrolled leakage through gaps must be smaller than 0.6 of the total house volume per hour during a pressure test at 50 Pascal.
5. **Absence of thermal bridges:** All edges, corners, connections and penetrations must be planned and executed with great care, so that thermal bridges can be avoided.

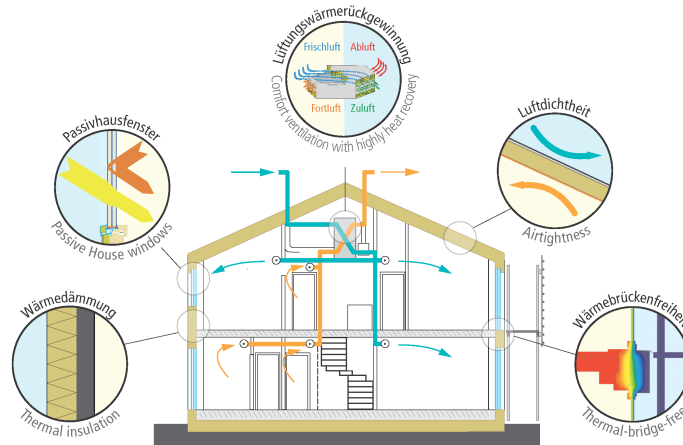

Figure 1.4: ANDREITA DIME UN PIE DE FOTO AQUI

All these principles and criteria will be considered and checked during the study and analysis phase for material and supply systems. At the end, the final solution will accomplish all the requirements to be considered as a passive house (nearly zero-energy building).

European Regulations

- **Directive 2010/31/UE on the energy performance of buildings:**

This Directive promotes the improvement of the energy performance of buildings within the Union. Here is a summary of the main ideas extracted from each article and their relation with the project:

- Article 6 explains the necessity of using energy from renewable energy sources for the supply systems.
- Article 9 states the obligation for every State member to increase the number of nearly zero-energy buildings until 2020, when every new building should have this characteristic.
- Article 11 enacts the need to create an energy certification system that evaluates every building in terms of energy efficiency.
- Annex I explains the methodology to assess every building in matters of energy performance.

- **244/2012/UE supplementing Directive 2010/31/EU**

The methodology framework is specified in the Annex I and III. In Annex III there are several tables as model to assess the energy performance. The framework is used in many softwares to evaluate the energy efficiency in buildings.

Previous Projects

After a brief study inspiration has been found in several projects of different nature: on the one hand, two business models that may be interested in the acquisition of this project; and on the other two building projects (one already executed and one still to be constructed) which serve as a reference and starting point for the investigation of each of the chapters in which this Final Thesis is structured (materials, modularity, supply systems and foundations).

SSH The SSH is one of the student accommodation providers in the Netherlands with more than 19,000 rooms and residences. Since 1956, SSH have been making a case for good accommodations for students and special groups of young people. In order to achieve this, SHH works together a great deal with other organizations as Municipalities, educational institutions, corporations and real estate investors. In Groningen SHH owns 15 buildings to accommodate up to 1550 international, bachelor/master and PhD students in Groningen.

The Student Hotel The Student Hotel was founded in 1982 by Scottish entrepreneur Charlie MacGregor in Amsterdam. Today, The Student Hotel offers fully-serviced, state-of-the-art accommodation in cities throughout Europe. Plans are under way to bringing to life The Student Hotel vision for a network of welcoming hubs where students, young professionals and travelers can make connections across the academic, entrepreneurial and social spectrum. The growth and success of The Student Hotel is the result of strong public-private partnerships with local and international stakeholders.

Urban Rigger During 2016 BIG developed the Urban Rigger project in Copenhagen (Denmark). This project consists on floating, carbon neutral student houses made from reused shipping containers. In addition, the design uses sustainable solutions as hydro source heating, solar power, and low energy pumps.

SchoonShip The objective of SchoonShip is create autarkic houseboats for up to 105 people in 46 houses and one collective space, install 500 solar panel, 30 heat pumps and use 0 gas technologies. SchoonShip will be built in Buiksloterham, a district on the north of Amsterdam where the former port and industrial area were placed.

Chapter 2

Stakeholders

To build innovative constructions like this, several stakeholders are involved in different parts of the project. Here reader can find the most important ones at the design stage.

- **Client** - The building's function is to be housing for students. Since most of them do not have the means to buy a house, the project is carried out by Michael Boscher via Kenniscentrum¹ for the municipality of Groningen. The client wants to develop the idea and try to convince a buyer to buy it.

This client has a significant decision power during the design stage. Its design principles are modularity, adaptability and sustainability. On each design stage, those principles will be taking into consideration plus other technical principles explained on each chapter. The client wants to solve one of the city issues since it is becoming a major student city creating not just living places but also sustainable and floating. The idea of floating appeared in order to use the water spaces throughout the city since the city can barely hand more student houses. On each chapter reader can find a statements of requirements on which is explained in detail its requests.

- **Municipality** - Most construction permissions have to be asked directly to the municipality of Groningen. In order to make things easier, the aim is that their are involved somehow in the stages of the project, either in the construction or in the following use. Taking into account that due to the increasing demand, the need to provide more houses for students is real, the municipality should be interested in developing these kind of ideas. the aim is that they collaborate with the client to adapt the building to the city needs. Also, if the municipality is interested in owning the house for renting to students, the project would have the funds required with relative easiness
- **Students** - The real users of the building. In order to find what their want, random students are going to be interviewed and asked whether or not they would live in a house like this and how they would like the house to be. The results of these interviews will also play and important role in the design stage. Also, it is interesting that students are familiar to the idea of sustainable life. Since they are the residents, they will have to be responsible with the generation and use of energy. Life in a

¹Kenniscentrum Noordruimte is a department of Hanze UAS Groningen which investigates how sustainable and innovative solutions can be applied in the area of the Northern Netherlands and use solutions to real problems by request or own initiative.

sustainable building might differ of what they are used to do previously, that is why everyone has to be aware where they are going and how to deal up with issues that might come. In order to make them willing to come, they need to find an attractive point in the house, it can be either: lower prize or willing to live more sustainable. Their requests will also be considered on each statement of requirements.

- **Construction companies** - One of the points that has to be achieved, is to try to reduce the impact in the environment that causes the construction. In order to maintain the idea of sustainability throughout the project, some requirements will be set to achieve this. Since this type of construction is quite new, there will be an assessment of procedures prior the selection of constructor to meet those requirements.
- **Waterboard Noorderzijlvest** - They are responsible for the water management in the north of The Netherlands. The building is going to be located in "their environment" therefore there might be laws that must be respected specially regarding navigation and natural environment. Although the project pretends to be sustainable and aims to reduce the impact of the construction, there might be some procedures established by the waterboard that must be respected.
- **Financial companies** - In order to obtain the money required for the project, if neither the municipality nor any of the student housing agencies have available the investment required, a financial company has a role to play. A way of financing the project could be a loan which terms have to be agreed in common with all parts.
- **Housing agencies** In case the municipality is not interested in owning a house for students, some student agencies such as SSH might be interested in owning or renting the house and then rent it to students. In case they are interested, they might require extra standards to make it profitable to them. The process of finding a buyer and funding is out of the scope of this project, but however, the idea is just mentioned.
- **aFloat members** This research is carried out by Michael Boscher via Kenniscentrum. a whole multidisciplinary team is researching for the feasibility and improvement of current floating buildings. In order to make a good product, the researches of other members on different topics related to the main issue has to be considered.

Chapter 3

Location

As seen in the images below, the building is located in the East of the city of Groningen (Netherlands). The location was suggested by the client and therefore, a study regarding location will not be executed. In the suggested place, there is a water surface bigger than 2500 meters² thus there is enough space for not interrupting the navigation and place a building. This place offers some advantages in terms of design and comfort for the users. One of them is that allows to locate the building at its optimal place considering the energy generation by solar panels and the comfort of the users at a lower cost. Also it is located closed to the city center and other important places in the city. Recently, the municipality of Groningen forbid to construct floating structures in the inner channels, however, it is still possible and encouraged to construct in the big water surfaces in the outskirts.



Figure 3.1: Overview of the location of the building

Chapter 4

Foundations (Gironés)

During this chapter, there will be an assessment of design options for the foundation including materials forms and unions with the aim of solving the research questions. The main question is: “How to create a self-sufficient, sustainable, floating house for students in Groningen?” A whole list of the subquestions can be found in appendix A The criteria on which will be based the comparative is explained in detail on each section. Different options will be explained and compared including calculations and drawings. Considering all criteria there will be a selection of an alternative with its justification. Once taking into account that option, it will be followed with detailed calculations and drawings. In order to acquire information, the research methods are: desk research for materials, consulting experts for constructive tips and finally questionnaires to potential users of the building to design according to their needs.

Currently, most foundations of floating buildings are done by a big concrete/EPS hull that fits the size of the house on top, the aim of this project is to show a different kind of foundation including storage facilities considering the criteria mentioned in the following section.

4.1 Statement of Requirements(SoR)

As mentioned in chapter 2 there are some requirements by the stakeholders and third party interests. Those requirements are basically: Modularity, adaptability, sustainability, affordability and possibility to expand the idea worldwide. The questionnaires to potential users of the building and its analysis can be found in the appendix J. Moreover, In the appendix A the reader can find a full description of the client, its criteria and third party interest, here there is just a short explanation:

Client

- **Sustainability** Be more sustainable than the existing buildings. All materials must be recyclable and if possible, from sustainable precedence. Each sections will include how it is sustainable. In the appendix A a whole description of the term can be found. The whole life cycle is taken into account considering tools provided by BREEAM and other environmental agencies.
- **Modularity** Evolve to a new level of engineering and being able to create a house that can be expanded and retracted at will. This means that all parts should be of

a standard size and shape in order to fit with the others, like a puzzle.

- **Adaptability** All parts should be able to coordinate with others to make bigger construction and also, the possibility to expand the idea worldwide.

Boundaries

In addition to the client's criteria, there are other restraints in the project. With the help of Marinetek¹ the design principles and boundaries for floating structures were cleared (See appendix K for the emails). The most important boundaries are:

Buoyancy “capable of floating; that can be floated. ”(Oxford dictionary) ² By buoyancy is understood that the material has the ability to resist the loads from the superstructure while floating on the water. Because of this, strong light materials that resist the action of the water and its chemicals are prioritized. The key issues of this topic are: Density of the materials, center of gravity of the whole building and loads from the superstructure.

Storage An extra requirement by the client is the storage within the foundation. Consequently, the idea is to include water tanks, batteries or other facilities in the foundation and not to use space in the upper structure.

Legal Requirements

In this case, the chosen legislation to follow and respect will be: the Dutch Bouwbesluit and the Spanish ”Código técnico de Edificación”. If at any point, legislations contradict each other or use different values for the same issue, the author will choose argumentatively one of them to proceed.

Assumptions and Preconditions

All assumptions made by the author, specially regarding technical issues will be explained on each section.

With Preconditions it is understood the actual conditions of floating buildings. Current methods and technologies will be investigated and assessed. Moreover, all actual given conditions that create boundaries will be explained on each section.

¹One of the world's leading manufacturers of marinas and floating solutions from Finland

²<http://www.dictionary.com/browse/floatability>

Assessment method

Taking into account all previous criteria and the selection methods based on BREEAM³. (see appendix A for full explanation) it is time to quantify the answers on separate topics on a scale. The proposed weights for different criteria are selected according to the estimated importance of the topic considering the client's expected outcome and the author's judgment are shown below. In the appendix B the reader can find an explanation of the reasons why it is done this way.

Solution	Sustainability	Buoyancy	Easy to unite	Durability	Affordability	total
Max. score	30 %	15 %	10 %	15 %	30 %	100 %
Solution 1						
Solution 2						
Solution 3						

Table 4.1: Selection criteria

Design Principles

The principles to follow include all topics mentioned before; respect the client's criteria, make the building suitable for students (Economically and Comfortably), design generically for further expansion of the model, durable, use local technology, use light and strong materials, water and moisture resistance, include safety factors and finally, easy to recycle.

4.2 Materials

Within this section there will be an exposition of all current materials with potential of being used and their suitability or not in the project. In appendix C, reader can find a full exposition of each material described here and other materials rejected. In Appendix B reader can find a justification of the recommendations, here there are just the conclusions.

Concrete

The most used construction material due to its properties, however, there are many issues regarding its sustainability. Around 5 % of global emissions of CO₂ are caused by the production of concrete (Rubenstein, 2012), consequently it is discouraged to use as is it now, but new technologies must be taken into consideration. The use of recycled arid is

³World's leading sustainability assessment method for buildings

becoming popular in Europe⁴, recently, it has been discovered a Bio-receptive concrete⁵, this means that it contains organisms that absorb CO₂ and pollution for producing oxygen. Consequently, **Author recommends its use for covering the blocks if more sustainable materials are not an option.** In The appendix C the reader can find more information regarding concrete. and in appendix B a justification of the recommendation.

EPS

EPS (Expanded Polystyrene) is defined as: "Plastic cellular and rigid material made out of a model of pre-expanded pearls of polystyrene expandable that presents a closed-cell structure filled up with air." EPS is a good, light, durable and cheap material that is becoming important in the engineering industry and floating homes. (Block, unknown year)Its only issue is the petroleum procedure. **Author recommends its use for the inner material of the block considering the procedure of production.** Check appendix C for further information of this material and appendix B for a justification of the recommendation.

Metals

Metals have been being used in the construction sector for a long time hence their importance does not have to be neglected (Ascione, 2015). Metals are not sustainable to produce however their lifespan and possibility to recycle are enormous and the whole cycle has to be considered. In The appendix C the reader can find more information regarding metals.

- **Steel:** Author recommends its use exclusively for the unions of blocks despite being neither sustainable nor innovative and "old-fashioned". It is strong, durable and recyclable. See appendix B for justification.
- **Aluminium:** has similar properties than steel but three times lighter. Its use is recommended for covering the blocks but since it would increase the prize and is not that sustainable in comparative with concrete, it will be the second option but initially, it is dis-encouraged to use at first.

Bioplastics

Bioplastics are a growing trend in eco-architecture and green buildings. The difference between conventional plastics is that they are made out of renewable bio-masses such as vegetable oils, corn or microbiota. instead of petroleum. In other words, they are made from waste or pollutants that in other way, they would end up dumped (Blackwell, 2016).

⁴In Germany, almost half of the materials used for new concrete production are recycled

⁵Created by BiotALab in Architecture school Barlett of University college London

The uses of this bioplastics are more expanded in other industries rather than the construction. Recently, it has been discovered a material called "liquid wood" or Arboform⁶ Its properties are similar to conventional wood ("Admin", 2013).

This material seems to fulfill all criteria from the client, however, since the author could not gather basic details regarding durability in contact with water, **recommends to follow closely the topic and do further research with the aim to develop a proper construction material.** Reader can find more information of the material and also, why is not selected in Appendix C

4.3 Forms

In order to respect the client's idea of modularity and adaptability, the intended result is a combination of blocks that can be easily combined to form bigger surfaces. The starting point of this section is that blocks must not exceed the limits for conventional road transportation. In Europe, those limits are 2,5x4,5x12m. In the appendix C, reader can find more information about exposed forms and others not included in the report. Figure 4.1 shows the different forms explained here.

Rectangular blocks

Many companies use similar shape-blocks to create pontoons or docks. They have logistic advantages such as they are easy to construct, transport and collocate. Moreover, a four-side block has less unions which reduces the cost and time of construction.

For this solution, the expected outcome is a foundation independent of the upper structure made out of blocks and goes separately on all matters. The height of those must be calculated according to the expected loads. It fulfills the criteria of modularity and adaptability since the unions should be done in an easy way and the size of the structure can be modified at any time. **Recommended because of its easiness and cost-effective.** For the project, as 3D image 4.3 shows, the shape has been modified in order to re-distribute efforts and make it easier to unite. However, further research on how to assemble parts and the constructive methods of a single block is needed.

Hexagonal blocks

Similar idea and principles than the rectangular blocks, but in this case, the shape is an hexagon. It has the advantage that is more stable against waves or tides and also, since internal angles are wider, supports better tensions. On the opposite hand, since it has more unions increases the costs and might form a weird shape with wasted/missing space. **Not recommended because waves are not expected to endanger the structure.**

⁶Derived from wood pulp-based lignin and invented by German company Tecnar

Combined foundation

Foundation and upper structure go together, this means that the foundation is made and calculated according to the weight that is going to receive on top. It is a middle stage of the actual scenario and the proposed in previous sections, modularity on a bigger scale. The key points in favor and against are: Different standard sizes depending on the room's use, all parts can be mounted and dismantled at will. Its disadvantages are: The possibility of having different levels due to different weights in separated parts and second and that it might exceed the road transportation limits. In the appendix C the reader can find a full explanation of this topic. **Not recommended because of its complexity of calculations and transport.** However, the author recommends follow the topic closely and further research since it can be an innovative way of constructing for the future. More information regarding the selection process can be found in appendix B.

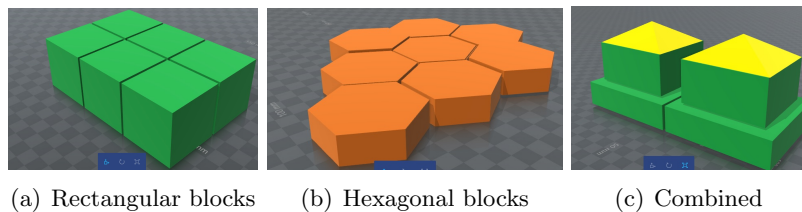

Figure 4.1: Types of forms

4.4 Unions

Depending on the type of blocks and the material used, a different kind of union is required. In this section there is going to be an explanation of possibilities considering different shapes and inside that, how to solve issues that any material might cause. In Appendix C, reader can find a more detailed information.

Unions in modular blocks

Connections between blocks should be identical in order to make easier both the design and constructive procedure. According to the direction of the union, they can be horizontal or vertical.

- **Horizontal** Union goes in the direction of the surface. Currently this is the most used union. Nowadays companies are using steel bars to connect different modules together. They are easier to construct but it might create instability in strong wind or waves since they are placed only on the upper side. Also, they use more material as image 4.2 shows.

- **Vertical** Here the union goes perpendicular to the surface, the image below shows how a disposal could be done (2 bars per side). They have the particularity that strengthens the union against waves or different unexpected weights in the building and might be easier to mount or dismount. **Author recommends this union.**

Unions in full modules

The proposed union for full modules are attachments similar to train wagons which make them really easy to unite and des-unite. The issue to solve is the possible differences in levels. Due to this, the union needs to be strong against flexion forces.

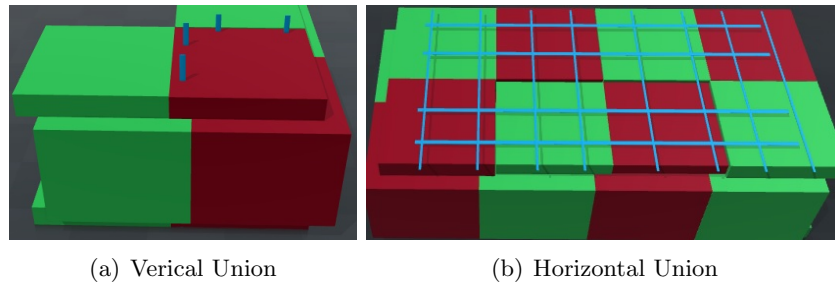

Figure 4.2: Unions proposed

4.5 Results of Analysis

within this section it is aimed to show how author has taken the raw data and used it in the research.

- Questionnaires results and its analysis can be found in appendix J. Its analysis explains the overall design.
- Emails with the company Marinetek and its analysis can be found in appendix K. This information was used to get familiar with the design of floating structures.
- Table 4.1 shows how author took into consideration different boundaries of the project and combined them on a numeric scale. Go to appendix B for explanation and justification of the selected alternatives.
- Section 4.10 shows how data regarding materials has been taken into account to calculate the parameters of the building.
- On previous section is displayed the results of the analysis of materials, forms and unions available. On appendix C, reader can find all information and analysis made about those topics.

4.6 Conclusion and Justification

Author suggests the construction of EPS rectangular blocks covered with glass fiber-reinforced concrete with a must of containing a % of recycled content on it. United with steel bars collocated vertically. In the appendix B, reader can find the table 4.1 filled out with different alternatives and its justification.

1. EPS is a light material that can be found worldwide with great lifespan and possibility to recycle.
2. Since the properties of renewable materials such as "liquid wood" are unknown, the author cannot make that crucial assumptions. Instead of that, it is recommended further research, specially regarding durability, resistance, mechanical properties and economy.
3. Fiber reinforced concrete is a more sustainable alternative than conventional concrete. Author would prefer to choose a more sustainable material, but as seen in appendix B it is the "less bad" among the bad and bio-materials are not an option because of durability issues.
4. Rectangular blocks are the easiest to produce, transport and collocate. In the previous section reader can find the reason why other methods are not selected. For more information regarding the selection process can be found in appendix B
5. Unions made out of steel bars placed vertically as the image 4.2 shows are resistant and durable. Moreover, with the selected shape, blocks and steel bars work uniformly which helps to redistribute efforts.
6. Sustainability has not been more weighted because scope needs to be wide and some other aspects such as time available for the research and affordability also are an issue.
7. The shape of the blocks has been decided so they can collaborate and form a whole unit and so they are easily connected with a vertical union.

the reader can see in the image below a sketch of how the final product will be. In the chapter 4.9 there are more detailed drawings of all options and how to proceed from one single block to a surface.

4.7 Final Design

As explained in section 4.6 foundation is going to be made out of rectangular blocks of 1,8x1,8x2m shaped as the image 4.3 shows, with a 30cm despair in the upper and lower layer for union and distribution of efforts. In the appendix D read can find calculations supporting this decision.

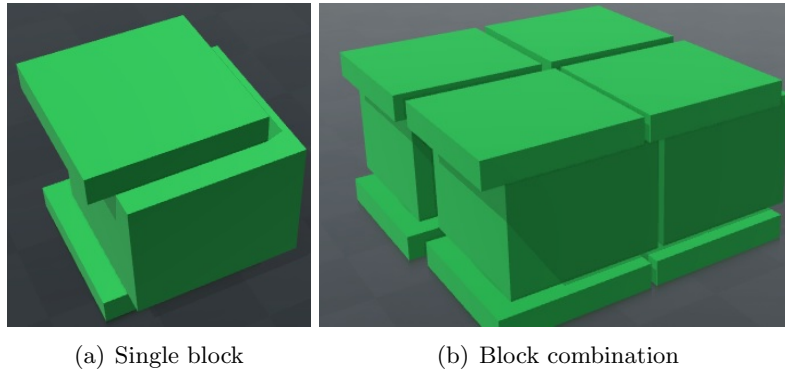

Figure 4.3: Blocks proposed

4.8 Materials used

The study will focus on the impact made by the materials used in the construction. In the appendix C can be found a more detailed explanation of each material and its properties and environmental issues. Moreover, in section 8.1 reader can find a life cycle analysis. The materials used are the most common for floating structures (Wittenberg, 2008).

- **EPS** For this project, roughly it is expected to contain 500 m³ of EPS. Considering that it is 95 % air, it just contains 25m³ of material. Besides, as mentioned before, EPS can be recycled up to seven times. The author recommends its use from recycled form.
- **Concrete** Using concrete as it is might not be sustainable, however, arid and fibers will come from a recycled procedure. Roughly, it is expected to use 1 m³ of fiber reinforced concrete per block.
- **Stainless steel** in bars of θ 20mm and 1.9m long covered on the ending because of durability are required to tight all structure together. The recycling industry of steel is increasing its size, in result, Author would make the exigence that the procedure and steel must be from recycled material.

4.9 Drawings

Blocks are going to be executed according to the design previously mentioned. In the image 4.4, reader can find the details of the construction

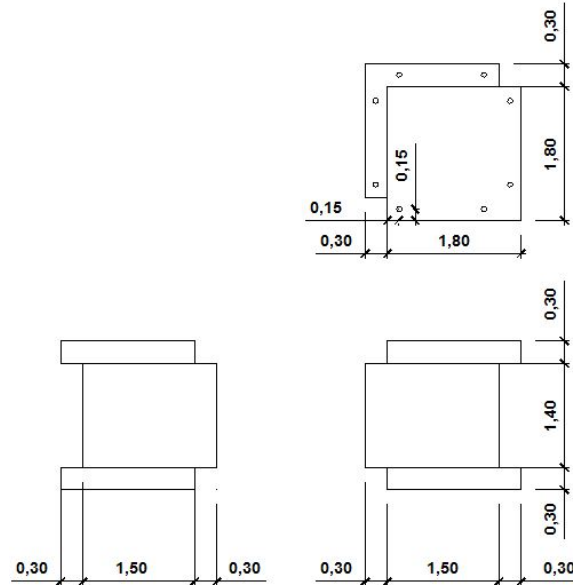

Figure 4.4: Block views in detail

4.10 Calculations

In the appendix D, reader can find a proper description of calculations. This report is just showing the results and key items.

Total loads

This paragraph includes a security factor of 1,35 in permanent loads(Walls,roof,inner walls and floor) and 1.5 in variable loads(Use and snow) because of the uncertainly of the building regarding storage and other issues. (Ministerio de Fomento, 2015)

$$387 + 333,1 + 274,6 + 146,7 = 1140KN \rightarrow 1140 \cdot 1.35 = 1539,5 \rightarrow 11.5KN/m^2 \quad (4.1)$$

Use+Snow loads

$$(2 + 1) \cdot 1.5 = 4.5KN/m^2 \quad (4.2)$$

The total load of the building is $11.5+4.5 KN/m^2= 16 KN/m^2$. Considering it a punctual force, its resultant in the center of gravity is **2139 KN**. For more information, and full process go to Appendix D

Buoyancy

Buoyancy is the vertical force by water that keeps the building floating. In order to increase security, the size of the foundation is going to be 0,5m bigger in all sides of the building.

Buoyancy is calculated by:

$$F_b = V_s \cdot D \cdot g \quad (4.3)$$

Where F_b is the vertical force by water (2139KN), V_s is the volume occupied ($12,3 \cdot 12,8 \cdot H$), D is the density of the fluid (1000 kN/m^3) and g is gravity (9.81 m/s^2). Following the action-reaction principle, F_b is the total load from the building, with this, and considering fixed sizes of the building, the incognito is the height of the building submerged plus a security factor of 0,8.

$$2139 = 9,8 \cdot 12,3 \cdot 12,8 \cdot H \cdot 0,8 \rightarrow H = 1,7 \text{ m} \quad (4.4)$$

In order to make numbers even and easier to design, **The height of blocks is going to be 2m**. A maximum of 1,7 will be submerged and the 0,3 will be an extra security measure. For more information, and full process go to Appendix D

Stability

"A floating object will be stable if its center of gravity (3,2m from the bottom) is below its metacenter ⁷ (8,9m from the bottom)." Since $3,2 \leq 8,9$ the building is stable. For more information, and full process and justifications go to Appendix D

Wind

According to Dutch Regulations (bouwbesluit,2012), wind in the case of study is to consider a value of $1,4 \text{ KN/m}^2$ in any side of the building. In order to calculate the worst case scenario, it calculated in the largest wall (12,8m) throughout its height (3,5m). The calculations show the required reaction from the water to equilibrate the momentum created by wind and the sinking because of it. In distance, the sinking is **Maximum 10cm**. For more information, and full process go to Appendix D

Forces to individual blocks

Blocks are assumed to work as a combination and not individually. On top of the foundation there is going to be a layer to distribute efforts through the surface in case they come differentially, in appendix D, reader can see the assumptions made on this topic and also the calculations that show that a 5 cm thickness of concrete layer is enough for the supporting the building.

⁷Oxford dictionary: "The point of intersection between a vertical line through the center of buoyancy of a floating body such as a ship and a vertical line through the new center of buoyancy when the body is tilted".

4.11 Storage

Foundations are over-dimensioned to cope with any kind of unexpected use. One of those uses is the storage of water, energy or waste within them. Each block can stand approximately 1000 kg of weight and the building would be still stable (see appendix E for details). This means that instead of being fully filled with EPS, blocks can be partially filled with EPS and leave some space within them for storing facilities. In order to be more stable, the heavier they are on the bottom, the more stable the building is. This are some recommendations for storage.

- **Water Supplies** Water tank supplies either for flushing toilets or drinking water can be stored in the foundation blocks. Those specific blocks can be placed under toilets or kitchen. See appendix E for further information.
- **Energy Supplies** Batteries can be also placed in the foundation blocks. Specific blocks with batteries can be placed where they make the building more stable and buoyant.
- **Waste** Some blocks can be equipped with bins to store waste prior the recycling. In order to make things easier, those blocks should be placed on the perimeter.
- **Heating** Blocks with heating technology can also be incorporated.

The recommended distribution by the author for the specific blocks with storage capacity can be also found in E but in conclusion, author just gives the idea since it is a new topic that has not been developed for this kind of foundation but recommends further research to see if it is feasible.

Chapter 5

Materials for Upper Structure (Forés)

5.1 Overview

Which materials fulfil the project requirements? In this chapter the selection of materials for the construction of the upper structure of the student residence will be carried out. The first step is to develop a selection criterion based on the principles demanded by the client, sustainability, adaptability and modularity. In addition, will take into account the design requirements of a floating construction system. To do this, it will be carried out the analysis of the materials currently used in the construction from an ecological point of view, studying their environmental impact throughout their useful life, and we will also study the current materials regarding the function they can perform within the construction system. After this analysis it will be obtained the most appropriate materials, with them will be created different alternatives of enclosures from which its transmittance will be studied to choose the best possible solution depending on the materials that are available in the area where it is going to be carried out the project, in this case Groningen, Netherlands.

5.2 State of requirements – Material selection criterion

Within the requirements given by the client, sustainability, adaptability and modularity, the most determining criterion is sustainability. Nowadays there is a wide variety of materials available for sustainable construction, from simple materials such as wood to other materials that require an elaborate manufacturing process such as steel, but all of them have to fulfil certain characteristics to be considered sustainable.

Sustainable materials are those that last over time, require little maintenance, are environmentally friendly, can be recycled or reused and have low energy consumption during their life cycle, this is one of the main characteristics to be considered sustainable material. That is to say, in general terms, materials that are of natural origin should be used, that their use should lead to a minimum of toxic emissions and that their recycling or dismantling is easy in order to reduce the production of waste and at the same time reduce the consumption of natural resources. The application of these principles complicates the research for materials and in some cases supposes an economic expense superior to the beginning of the project although in the long term it is more profitable. Of course it is difficult to meet all these conditions but in order to get closer we will carry out the following analysis, starting by establishing the selection criteria.

For the selection of materials the requirements imposed by the design of a floating house

have to be taken into account, but it should not be forgotten that sustainable materials have to be protagonists in the design. For this reason, their environmental impact must be taken into account during all phases of the life cycle. The set of these two concepts, life cycle and environmental impact, are those that will produce a criteria for the selection of sustainable materials. In a generic way, the phases of the life cycle and the concepts to be analyzed in each phase will be named in order to be aware of the environmental cost they have throughout it.

The phases of the life cycle of the materials are, **extraction or preparation** of the raw material, obtaining is done by activities that alter landscapes and natural ecosystems, also require energy and emit harmful substances to the environment. Secondly, the process of **transformation**, there are products that require slight transformation actions and others that for their implementation require more complex processes, therefore, more pollutants. Third, transport, transport phase and supply phase produce high pollution rates, so it is advisable to use local products. Fourthly, the **implementation or application** of the construction products requires various actions and auxiliary means. Fifth, **use and maintenance**, maintenance is a set of operations that will ensure the correct operation of the building and ensure its durability. Sixthly, the **Demolition or Deconstruction process**, when the building cannot guarantee its correct functioning, is demolished, totally or partially. Finally, **Reuse or Recycling**, products from the demolition of buildings can be given the possibility of extending their life. During all phases of this cycle, the environmental impact of the materials will be measured with respect to the concepts of **energy consumption, consumption of natural resources, impact on ecosystems, the emissions they generate and their behaviour as waste**. After the analysis of the possible environmental impact of the materials throughout their useful life, a series of guidelines or principles can be determined for the selection of sustainable materials. To consider a material as sustainable it must fulfil many of the following guidelines:

- They must be local materials or their place of production is as close as possible.
- Its origin must be from an environmentally friendly place of production.
- Must be natural or poorly elaborated.
- They come from renewable and abundant sources.
- They must be durable.
- They should not be polluting to the user or to the environment.
- They must be recyclable, reusable or biodegradable and come from recycled materials.
- They must have a low economic cost and be valuable.
- They must have a cultural value in their environment.

In addition to these principles of sustainability, we have to apply other principles required by the design, such as system buoyancy and modularity, so we will try to choose lightweight materials and at the same time their mechanical capabilities allow to develop the project in a simple and adaptable way. The set of these criteria will allow us to choose the correct materials for the development of the superior structure of the project. (For more information read appendix I)

5.3 Materials

Structure

This section will discuss possible materials that may be part of the elements that make up the skeleton of the building. For the construction of pillars and beams, different types of materials such as wood, steel and concrete, of more general use and other less common ones such as adobe, ceramic or stone elements, that can be used as a support element, even Bamboo, material widely used in some Asian countries.

For the selection of the appropriate material, the criterion developed in previous points will be applied.

Starting with steel and concrete, the most widely used materials, it should be said that, although these materials allow to develop the project in a modular way, they cannot be considered as materials suitable for sustainable construction due to their great environmental impact in its extraction and production, in addition they are very heavy materials which makes the project buoyancy difficult as well as constructive solutions made with adobe, ceramic or stone elements. With respect to bamboo it can be said that it is a material that fulfils the requirements of the project but its availability is not very high.

Wood provided from a sustainable production with a seal that certifies it is considered a sustainable material. It also has other advantages because it is material easy to use thanks to its lightness. This also facilitates its transport, loading and assembly. In its production it is possible to elaborate pieces of great lengths and it gives flexibility to the functional and creative organization. It produces greater economy, since it allows short times of work. At the end of the useful life of the construction, it is simple its demolition and reuse the resulting material as fuel if it is not possible to reuse it. If the appropriate variety of wood is selected, cut down, dried and used correctly it has unlimited duration and minimum maintenance.

Against him, say that it is attackable by fire, but still has a good behaviour before him, greater thickness of the pillar, greater insulation. It is also attackable by fungi, insects (worm, termite, moth) and chemical agents. If it is outdoors, it is prone to rot and premature aging. But for all this, there are ecological treatments that protect the wood from each type of attack.

Floor

From the environmental point of view, the most suitable materials for interior floors are, wood, according to the criteria set out above, natural textiles, cork and linoleum, with a control of adhesives and finishing treatments.

There are also pavements composed of stone materials such as stoneware, terrazzo and ceramics. But these materials are very heavy and in a floating system, as in this case, light materials must be imposed, in addition to that these materials offer a very low degree of

modularity and adaptability.

So, wood is again the ideal material, in addition to all the qualities that have been named above, it must be added that there are several systems suitable for sustainable construction, such as OSB boards. These are a type of particleboard oriented and cross-linked in a high performance board. Sandwich panels also have to be named, this one consists of two sides of lining, based on derivatives of wood sustainably managed, and an insulating core based on natural cork, make it the very appropriate solution for pavement. It has become in a ideal solution for a modern and sustainable construction, since it acts at the same time of isolation and structure. It is a very safe and long-lasting product.

Building Envelope

The objective of the building envelope is to cover heating and cooling needs with the least possible energy expenditure, regardless of the outside temperature, for which the building is designed in order to gain all possible solar heat (in winter) and avoid heat gains (in summer). It is possible to achieve this by insulation, dimensions, orientation and adequate openings and also with use of the resources and energy of the environment.

A well-insulated house loses half the heat, and if it is well oriented and with convenient openings it gains three times more energy than a conventional house, so adding both concepts, it is possible to spend six times less energy than in a conventional house.

The envelope of the building includes facades and roof, both are formed by a structural support and a series of contiguous layers in contact, which seek to avoid the passage of rains and try to have the least energy transfer possible. These layers are, outer and inner cladding, waterproofing and insulation.

For the execution of facades and cover, the appropriate materials for the exterior and interior cladding, insulation and waterproofing will be studied separately, giving in this section different solutions.

Exterior and interior claddings

Soil or Adobe Crude soil is used to make blocks, adobes, mud walls and as masonry joints, with no other treatment than drying in the sun.

The adobe is a clay brick uncooked just sun-dried. It is composed of clay and sand, to which additives (straw, lime, etc.) are added according to the type of soil and the climate of the place, thus guaranteeing a greater mechanical resistance of the blocks.

The constructions with adobe have an optimum level of comfort due to the high inertia resulting from the thickness of the walls and the characteristics of the soil. The soil has the ability to regulate the indoor climate, keeping the temperature and relative humidity within the comfort level.

Ceramic The ceramic walls of a sheet are optimum captators, accumulators and transmitters of solar thermal energy to the interior of the enclosure, mainly if they are exposed to the sun in winter. Oriented to the south they are suitable for use in greenhouses, trombe walls and radiant walls. In walls with insulated air chamber this effect is interrupted. There are varieties of formats: solid or perforated bricks and blocks of thermo-clay, Bioblock, among others.

Stone Building with stone has many advantages, such as the durability and simplicity of maintenance of stone walls, high thermal inertia provided that the walls are equal or exceed 50 cm, good protection against the heat of the summer and the soundness. In general the processes of production or transformation that are applied to the stone materials are usually little energy consumers. In contrast, the disadvantages of this construction are the slow execution, the risk of deterioration of the wall due to humidity and the overexploitation and unsustainability of many of the quarries of origin.

Alternative Blocks

- **Arliblock** Light block of porous structure of expanded clay and cement with properties of sound insulation and resistance to fire, in addition to very good thermal characteristics.
- **Climablock** Block formwork of wood shavings conglomerated with cement.
- **Steko Bloque** It is a block of wood of fast construction that simply fits in with one another, is light and easy handling. It can be filled with cellulose.
- **Microtong** Block of microcapillary structure obtained by wood flour which during cooking leaves micro-cavities in the structure.
- **Ytong** They are solid blocks formed by hemp plant fibers, natural hydraulic lime and minerals mixed with water. Its main raw material is hemp.

Wood Gypsum Generally the walls of wood or plaster are composed of an auxiliary structure of wooden frames and covered with panels of fibre-plaster or wood shavings, among others. Some acoustic and thermal insulation material is provided inside the chamber. Its main advantages are the cleanness of execution and the lightness.

Shavings panel, Heracklit: They are thermo-acoustic panels of wood shavings agglomerated with magnesite and are mineralized, cancelling the processes of biological deterioration and increasing their resistance to fire. It is resistant to pressure and bending. It is heat accumulator and absorbent to the noise. Neutral behaviour in front of all building materials and paints of simple elaboration. It is free from harmful substances.

Fibre panel of wood: Composed of wood fibres mixed with water to create a mass that will subsequently dry up acquiring the consistency of the future panel. The panels are open to the diffusion of vapour and regulate the humidity of the air absorbing or expelling, depending on the ambient conditions of the room, up to 20% of its weight

in humidity without losing insulation capacity, the combination of both characteristics influences positively in The ambient conditions of the room. Thanks to their low thermal conductivity, they have excellent qualities for the protection of cold, which is to say for insulation. They avoid the loss of heat and the cold penetration in the inside. Due to its high porosity, high weight and good mechanical rigidity, it is possible to fulfil the requirements as acoustic insulation.

Contralaminated wood board: Panel composed of wood sheets glued and treated under high pressure moulding, to become solid wood large format plates. The rigidity and resistance increase considerably, and the static balance is reached with remarkable simplicity. Depending on the aesthetic requirements, the panels are manufactured in industrial qualities (to coat) and with surface finishes, which allows using them as a closing element both inside and outside. It balances the ambient humidity, absorbing it or releasing it, bringing its value closer to levels suitable for human well-being. It is relatively easy to achieve very high structure fire resistance (from 30 minutes to more than 4 hours). In principle, all the acoustic requirements for a building can be satisfied. It is recyclable and incinerated without releasing dangerous waste. Contralaminated wood panels allow spectacularly short mounting times.

Exterior plates of gypsum-fibre: It is a homogeneous mixture of gypsum plaster and cellulosic fibre from recycled paper, which is mixed with water for setting the plaster, without adding glues or other binders, apart from a slight surface impregnation that allows it to be painted, wallpapered or immediately tiled after its implementation. Due to the homogeneity of its structure, the panel presents the following characteristics: Can be used in wet areas and coated with ceramic parts, without problems. The flexo-tensile strength is very high and constant. The surface hardness even improves traditional plasters, allowing screwing directly. It has a great facility to absorb the humidity of the air and also to yield when the ambient conditions change. It has high capacity of acoustic and thermal insulation. It is ecological, for its raw materials and for its manufacturing process. During it, waste materials are recovered and reintroduced into the production line.

With regard to the covers there are flat, inverted, inclined, landscaped or ecological covers. The project includes a roof with a very slight slope, so the analysis will focus on solutions for flat roofs.

We have to try to avoid the use of plastic or metallic materials, both for the composition of these materials as for their energy cost and their poor behaviour being an important source of thermal transmission.

In the section of flat roofs is considered as best solution the execution of landscaped roof from an environmental point of view. For non-passable flat roofs we recommend finishing with recycled aggregate or mineral gravel as the best option. But the roof of the project must be passable since we will include the installation of solar panels, for this the most recommended solutions are ceramic tile claddings but these solutions are very heavy solutions. Therefore we will analyze in the following point the possible solutions of waterproofing materials to find some more effective solution.

Waterproofing and insulation

In relation to waterproofing and insulation products, it can be affirmed without a doubt that they are key materials in any construction since they serve to isolate the building from the climatic conditions of its surroundings.

In the foreground will study the waterproofing materials which will be placed basically on covers. The materials most used as waterproofing in flat roofs, such as the project, are those that have a greater environmental impact, PVC sheets and, to a lesser extent, classic asphalt sheet. That is why, according to environmental criteria, we must replace the synthetic materials with others that are based on rubber and synthetic polymers, which also confer greater elasticity and durability. Regarding flat roofs the most interesting option would be the rubber sheets (EPDM) and those of polypropylene as well as sheets of modified bitumen of the type SBS, APP. It will try to avoid the use of asphalt sheets and PVC sheet whose recycling is very complicated. Regarding the rubber sheets (EPDM) we will choose as waterproofing system the sheet Firestone UltraPly TPO. The membrane combines in one sheet the strength of the rubber with the heat-soldering ability of a thermoplastic, with excellent characteristics for implementation. The formula of the membrane, free of chlorine, halogen and plasticizers, as well as its joints welded by hot air, contributes to the ecological characteristics of the system. The UltraPly TPO membrane has great durability and can also be easily recycled.

As for the insulating materials we can affirm just as natural materials are preferable to synthetic materials. Nowadays, the use of materials from petroleum, which produce the deterioration of the ozone layer and global warming, is very common, so at this point we are going to name insulators that are sustainable and respectful of the environment, such as glass or rock fibre, cellular glass, and other more environmentally friendly, because they come from renewable sources directly such as cellulose, cork or hemp, flax, wood fibre boards, cotton blankets , Expanded clay, perlite (volcanic rock), vermiculite, sheep's wool and straw.

(For more information read appendix J)

5.4 Multicriteria Analysis

After the study of materials, natural plaster and plaster, ceramic (tiles and bricks), natural insulation (cork, flax, hemp, vegetable fibres, cellulose ...), natural cements or hydraulic lime, wood with guarantees of origin, silicate paints, natural varnishes, etc... can be considered as suitable materials for sustainable construction. Other materials that could be included, but their use would have to be limited, are glass, iron, steel, copper, ecological plastics (pp, PE, PB).

A list of materials that we would have to avoid in the project can be; PVC, aluminium, industrial glues, wood derivatives containing synthetic resins, plastic and synthetic paints, polyurethanes, plasters based on industrial slags, portland cements, synthetic insulation (polystyrene), conventional concrete, wood of dubious origin, stoneware and all those materials that emit toxic gases in their combustion.

Within the suitable materials the wood will be selected as the base element of our project, this material has good structural capabilities and works well as outer cladding. It is also a very clean material during the execution and very light, highly valued quality. For floating systems it is an ideal solution, since they have contraction and dilation movements, where the monolithic solutions would break if they are not executed correctly. It is also a very adaptable material, with it can be developed all kinds of modular systems for construction. In addition, wood is one of the materials that less processes suffer during its production, is used almost in its natural state, this makes it a very ecological material although it must be remembered that it has to come from factories with ecological management and is also a material Which is available everywhere in the world.

To complete the enclosure must include some type of insulation, natural insulation and different types of alternative blocks coming from natural materials are possible solutions. To determine which will be used in the project, will be carried out the study of the transmittance of each one, generating different solutions.

In the case of the cover, some kind of waterproofing should be included, the material selected is Firestone's UltraPly TPO, in this case it is not possible to opt for a totally sustainable material and almost always have to resort to a synthetic material, but we have chosen this solution because it is 100% recyclable and durable, in addition to other features that approach it to be an ecological solution.

5.5 Calculations

Once selected the materials for the envelope of the residence will be designed different types of enclosure calculating their transmittance so that the construction can be certified as passive house according to the criteria established by the "Passive house institute" for the Low Countries, ie , The transmittance of the project envelope must be equal to or less than $0.15 \text{ W / m}^2\text{K}$.

For the calculation of the transmittance of the walls has been established a design of two sheets with an outer cladding of wood 2 cm thick and a chamber of air 2 cm between the two sheets. The table below shows the thickness of the wall Depending on the insulation material used, analyzing all materials of natural origin and discarding the alternative blocks since their transmittance values are given by catalogue and do not reach the established requirements. (For more information read appendix K)

Transmittance calculation

e= thickness (m)	EXTERIOR	SHEET 1		SHEET 2		SHEET 3		SHEET 4		SHEET 5		INTERIOR	THICKNESS OF THE WALL (M)
λ = conductivity (W/mK)		WOOD		WOOD FIBER		AIR CHAMBER		WOOD FIBER		WOOD			
Rse	e	λ	e	λ	e	λ	e	λ	e	λ	Rsi		
U (W/m ² K)	-	0.02	0.04	0.11	0.04	0.02	0.017	0.11	0.04	0.02	0.04	-	
0.14954	0.04	0.5		2.75		0.017		2.75		0.5		0.13	0.28
e= thickness (m)	EXTERIOR	SHEET 1		SHEET 2		SHEET 3		SHEET 4		SHEET 5		INTERIOR	THICKNESS OF THE WALL (M)
λ = conductivity (W/mK)		WOOD		CORK		AIR CHAMBER		CORK		WOOD			
Rse	e	λ	e	λ	e	λ	e	λ	e	λ	Rsi		
U (W/m ² K)	-	0.02	0.04	0.11	0.04	0.02	0.017	0.11	0.04	0.02	0.04	-	
0.14954	0.04	0.5		2.75		0.017		2.75		0.5		0.13	0.28
e= thickness (m)	EXTERIOR	SHEET 1		SHEET 2		SHEET 3		SHEET 4		SHEET 5		INTERIOR	THICKNESS OF THE WALL (M)
λ = conductivity (W/mK)		WOOD		CELLULOSE		AIR CHAMBER		CELLULOSE		WOOD			
Rse	e	λ	e	λ	e	λ	e	λ	e	λ	Rsi		
U (W/m ² K)	-	0.02	0.04	0.11	0.039	0.02	0.017	0.11	0.039	0.02	0.04	-	
0.14646	0.04	0.5		2.82		0.017		2.82		0.5		0.13	0.28
e= thickness (m)	EXTERIOR	SHEET 1		SHEET 2		SHEET 3		SHEET 4		SHEET 5		INTERIOR	THICKNESS OF THE WALL (M)
λ = conductivity (W/mK)		WOOD		EXPANDED CLAY		AIR CHAMBER		EXPANDED CLAY		WOOD			
Rse	e	λ	e	λ	e	λ	e	λ	e	λ	Rsi		
U (W/m ² K)	-	0.02	0.04	0.3	0.11	0.02	0.017	0.3	0.11	0.02	0.04	-	
0.15057	0.04	0.5		2.73		0.017		2.73		0.5		0.13	0.66
e= thickness (m)	EXTERIOR	SHEET 1		SHEET 2		SHEET 3		SHEET 4		SHEET 5		INTERIOR	THICKNESS OF THE WALL (M)
λ = conductivity (W/mK)		WOOD		COTTON		AIR CHAMBER		COTTON		WOOD			
Rse	e	λ	e	λ	e	λ	e	λ	e	λ	Rsi		
U (W/m ² K)	-	0.02	0.04	0.09	0.03	0.02	0.017	0.08	0.03	0.02	0.04	-	
0.14591	0.04	0.5		3		0.017		2.67		0.5		0.13	0.23
e= thickness (m)	EXTERIOR	SHEET 1		SHEET 2		SHEET 3		SHEET 4		SHEET 5		INTERIOR	THICKNESS OF THE WALL (M)
λ = conductivity (W/mK)		WOOD		MINERAL WOOL		AIR CHAMBER		MINERAL WOOL		WOOD			
Rse	e	λ	e	λ	e	λ	e	λ	e	λ	Rsi		
U (W/m ² K)	-	0.02	0.04	0.11	0.04	0.02	0.017	0.11	0.04	0.02	0.04	-	
0.14954	0.04	0.5		2.75		0.017		2.75		0.5		0.13	0.28
e= thickness (m)	EXTERIOR	SHEET 1		SHEET 2		SHEET 3		SHEET 4		SHEET 5		INTERIOR	THICKNESS OF THE WALL (M)
λ = conductivity (W/mK)		WOOD		CELLULAR GLASS		AIR CHAMBER		CELLULAR GLASS		WOOD			
Rse	e	λ	e	λ	e	λ	e	λ	e	λ	Rsi		
U (W/m ² K)	-	0.02	0.04	0.18	0.065	0.02	0.017	0.18	0.065	0.02	0.04	-	
0.14869	0.04	0.5		2.77		0.017		2.77		0.5		0.13	0.42
e= thickness (m)	EXTERIOR	SHEET 1		SHEET 2		SHEET 3		SHEET 4		SHEET 5		INTERIOR	THICKNESS OF THE WALL (M)
λ = conductivity (W/mK)		WOOD		SHEEP WOOL		AIR CHAMBER		SHEEP WOOL		WOOD			
Rse	e	λ	e	λ	e	λ	e	λ	e	λ	Rsi		
U (W/m ² K)	-	0.02	0.04	0.16	0.06	0.02	0.017	0.17	0.06	0.02	0.04	-	
0.14954	0.04	0.5		2.67		0.017		2.83		0.5		0.13	0.39
e= espesor (m)	EXTERIOR	SHEET 1		SHEET 2		SHEET 3		SHEET 4		SHEET 5		INTERIOR	THICKNESS OF THE WALL (M)
λ = conductividad (W/mK)		WOOD		WICKER		AIR CHAMBER		WICKER		WOOD			
Rse	e	λ	e	λ	e	λ	e	λ	e	λ	Rsi		
U (W/m ² K)	-	0.02	0.04	0.12	0.045	0.02	0.017	0.13	0.045	0.02	0.04	-	
0.14831	0.04	0.5		2.67		0.017		2.89		0.5		0.13	0.31

5.6 Final Design

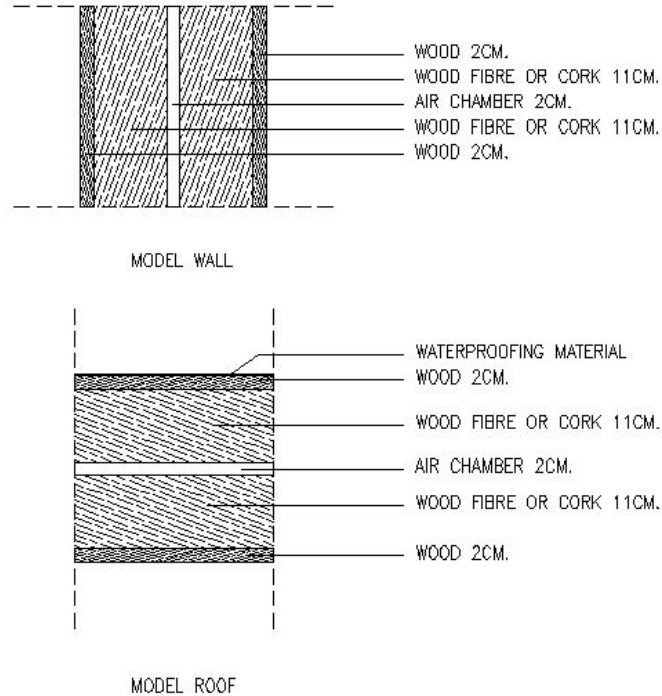

Figure 5.1: Final design

It has been chosen as a constructive solution for the enclosure composite walls of two sheets with a thickness of 28cm. With this enclosure made of wood as outer cladding and cork or wood fibres as thermal insulation is possible to fulfil the requirements demanded by the project. Including the Firestone UltraPly TPO sheet as waterproofing on the roof.

This enclosure achieves a transmittance less than $0.15 \text{ W} / \text{m}^2\text{K}$ with wood and cork, the most environmentally friendly materials. Besides these materials are very light and adaptable, the characteristics of these materials allow to have them in different dimensions and to continue working comfortably w. They are exceptional materials for their use, they are very clean and allow the construction in dry, which adds to the constructive systems the capacity to be disassembled for its reuse or recycled.

During the project the concepts of sustainability given by Breeam have been taken into account, but this tool is more useful for an evaluation after the execution of the project than during its design phase. Therefore it has not provided much help. This enclosure widely fulfills and reaches the requirements of sustainability and the requirements of the project, for this reason it has been selected to be applied in the project.

Chapter 6

Supply Systems (Morant)

6.1 Overview

Nowadays energy consumption is an influential point in our life. Lighting a lamp, cooking, taking a bath or using the computer are daily actions that require energy. A conscious consumption must be based on two pillars. One is the production of energy using renewable sources and the other is to reduce the consumption to the minimum necessary.

The use of traditional energy production systems (as fossil fuels or nuclear energy) implies the depletion and deterioration of the environment, overheating of water in rivers and coasts, high pollution rates in cities or creating deposits for radioactive elements. To face this situation, renewable energies acquire a primordial, necessary and urgent role. Renewable energies are considered as inexhaustible sources of energy and clean energies, which means, zero or low environmental impact.

The energy consumption in a building depends on many factors: the climatic zone where the building is located, the quality of the building systems, the level of insulation, the degree of equipment, the use given to them, etc. All of them have in common that their operation contributes to the consumption of natural resources, in some cases water consumption, in other energy consumptions or both at the same time.

After a brief analysis of a conscious consumption, some questions have been made to try to solve this problem. The extended version can be consulted at the Appendix I.

Those questions have helped to focus the solution in two ways; use techniques and standards of construction that reduce consumption, and include energy and supply systems that allow the disconnection of the building from the supplying network.

For further information, please check Appendix I. Overview.

6.2 Statement of Requirements

Client

The project pretends to follow the idea of Michael Bosscher to develop an off-grid, self-sufficient student home in Groningen. The focus of the research will be the integration of the different services and systems within the construction of the building. Mr. Bosscher has state three main requirements:

- **Modularity:** the building has to be able to grow both in length and high.

- **Sustainability:** the building has to be self-sufficient, has to reduce its carbon footprint and ecological impact.
- **Scalable:** the building has to be adaptable to every and each part of the world.

In this chapter, the fundamental criterion is self-sufficiency: to be able to design an autonomous building and off-grid. To achieve it, a number of design and supply proposals will be studied, which will help to reduce consumption and obtain energy in a sustainable way.

Legal Requirements

This project will be subject to international and national regulations regarding design, functionality, technology and construction. Due to the international character of this project and the difficulty of covering all the regulations that would apply to it, it is decided to establish generic measures based on European directives.

For further information, please check Appendix I. State of Requirements.

6.3 Research data. Bioclimatic architecture

Bioclimatic architecture consists on the design of buildings taking into account the climatic conditions and taking advantage of available resources (sun, vegetation, rain, winds) to reduce environmental impacts and attempting to reduce energy consumption. Bioclimatic Architecture is, in short, an architecture adapted to the environment, sensitive to the impact it causes to the nature, and that tries to minimize the energy consumption and with it, the environmental contamination.

Orientation

Orientation is the specific positioning of an object respect to the cardinal points. Orientation is a decisive factor in the construction of housing due to the need to take advantage of solar radiation.

The choice of orientation is included within a series of measures called passive solar design. Passive solar design represents one of the most important strategies for replacing conventional fossil fuels and reducing environmental pollution in the construction sector. In passive solar building design, windows, walls, and floors are made to collect, store, and distribute solar energy in the form of heat in the winter and reject solar heat in the summer.

These principles will be achieved through the following basic strategies:

- Orientation of the building: For the Northern hemisphere the ideal orientation is the South with a deviation of up to 30° East or West, to maximize the solar gain. The receiving facade must be free any obstacle that prevents direct radiation to the building.

Orientation	Main rooms as bedrooms and common rooms should be orientated to the South (maximum 30° SW-SE deviation). Shared facilities as kitchen, toilets and laundry room should be orientated to the North.
Windows location	The biggest masses of glass should be placed on the south facade. In the north facade hollows should be reduced.
Passive solar energy	The study of this strategy will be carried out in other section of the project.
Solar protections	To reduce the amount of heat during summer, solar protection will be placed over the windows. (check the following section)

- Selection and location of windows: Heating with passive solar energy is simple; just let the sun enter into the house through the windows.
- Taking advantage of passive solar energy: In cold climates, the strategy of passive solar heating consists of orienting most of the facade hollows to the south. This strategy has no additional cost besides a proper project planning.
- Solar protection: The height of the sun in summer is higher than in winter. They allow protection against overheating in summer but allow the sun to pass during winter.

In Appendix I.Orientation weather information about the specific location can be found.

After all the research here is a table with the design main ideas that will be taken into account in a further stage of the project.

Solar Protection

There are several solutions to prevent heat to entrance into the house. All these solutions are called Solar Protectors and there are many models available in the market: overhangs, awnings, slats, deciduous vegetation, reflective sheets,...

As solutions for this project, window retractions and eaves have been chosen. Window retraction is easily implemented into the design and reduces the entrance of solar radiation. Eaves provide solar protection and are easy to integrate into the design. Eaves can be formed as an extension of the roof which is translated into a reduction of costs and improves sustainability.

For further information, please check Appendix I.Solar protection.

Ventilation

As part of the bioclimatic strategies being applied, the ventilation flow must be studied in order to reduce or even eliminate the use of mechanical refrigeration systems. Since the project is located in a cold climate, the need for mechanical ventilation for cooling is very small, but still, the study of passive ventilation systems such as cross ventilation should be taken into account in this project.

The study of the ventilation tries to establish which are the wind flows that run through the selected location (speed and direction) and to determine strategies that allow its use in the design of the floating building. To do this, the following steps will be followed in the study phase:

- Determine the speed and direction of winds per year.
- Sectorize spaces according to uses. Concentrate high-heat-emitting spaces.
- Design proper windows.
- Ventilate buildings at night.
- Ensure good thermal insulation.

As a solution for the ventilation several design proposals have been developed. Here is presented the chosen solution:

An air chamber will be created in the roof through which wind will flow. At the same time, each room will have a small chimney that will allow interior air to go outside. Wind flow will create a suction of the interior air removing the heat. The ventilation system has two modes of operation, first a continuous cooling system can be used, in which the air enters through the windows or through the aerators incorporated in them and exits to the outside through a valve located in the ceiling of the rooms. On the other hand, it can operate in a conventional way, preserving the same air located inside the house, following a continuous recirculation, and allowing the circulation of hot air through the entire building.

For further information, please check Appendix I.Ventilation.

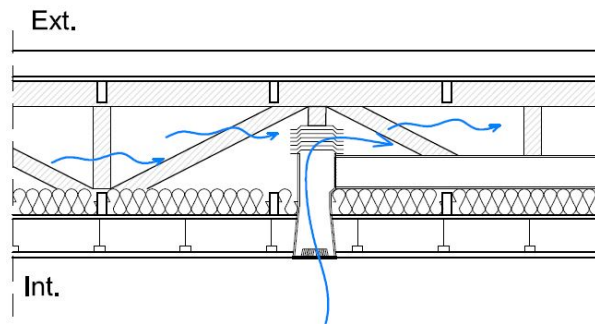

Figure 6.1: Cooling system

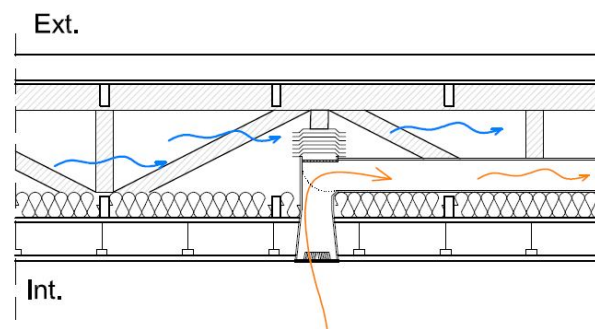

Figure 6.2: Circulating system

Rainwater harvest/water reutilization

In April 2017, the total water consumption in the world this year is around 3.390.958 millions of litres. This shocking data gives the idea of searching for new ways of consuming water in a sustainable way. Two strategies have been developed: Rainwater harvesting and Water reutilization.

Rainwater harvesting: rainwater that is captured from the roofs of buildings. Can be used for water gardens, livestock, irrigation, domestic use with proper treatment, indoor heating for houses etc. And can provide around 50 per cent of a family's water needs. The capacity of a rainwater harvesting system depends on the amount of rainfall, size of collection area, storage capacity, and the household's level of demand for water.

Water reutilization: water originally used for a specific purpose that can be reused for a new one. The water can come originally from a purified source or from rainwater. The water reutilization system will be separate from the rainwater harvesting system although they will be very similar (pipes, filters, tank,...).

The building design will take into account the information related to this section. The design will considered the roof as a source for catching rainwater and reducing the purified

water consumption. It will also consider the option of integrating a water reutilization system to increase the reduction of water consumption.

For further information, please check Appendix I. Rainwater harvesting/Water reutilization.

Thermal mass

Air conditioning systems (whether heating, cooling or both) are a focus of importance for bioclimatic architecture because they are typically the most energy consuming systems in buildings. Following the study of passive houses with passive solar designs, the design of the building's envelope has a very important role: it must allow the solar energy to be efficiently used without the use of special mechanisms, such as photovoltaic cells or solar panels.

To ensure the correct design of the envelope, the following basic strategies will be studied:

- **Decrease in energy losses:** A passive solar home must be well insulated and sealed, avoiding leaks (high-performance carpentry, high levels of insulation and reduce thermal bridges).
- **Heat Storage:** Constructive elements made of concrete, masonry, or even water can absorb and accumulate heat during sunny days and release it slowly when temperatures drop.

Some methods to assure heat through thermal masses are:

- **Direct Gain:** Sun can be collected through windows and retained by floor thermal masses.
- **Non-ventilated accumulation wall:** Trombe wall that consist on a wall is built on the winter sun side of a building with a glass external layer and a high heat capacity internal layer separated by a layer of air.
- **Ventilated accumulation wall:** similar to the previous one but it incorporates orifices in the upper and lower part of the wall to facilitate the transference of heat.
- **Attached greenhouse:** consist on glass enclosures built on the south side (for the northern hemisphere and north for the southern hemisphere) of the building
- **Heat accumulation roof:** use the roof surface to capture and accumulate the energy of the sun.
- **Solar collection and heat accumulation:** combining the direct gain by windows with solar collectors of air or hot water to accumulate it under the floor.

Despite all the solutions available, this strategy cannot be included into the design. Lightness criteria included in other chapters as Materials and Foundations makes not feasible the incorporation of any methods.

For further information, please check Appendix I. Thermal mass.

6.4 Research data. Supply systems

Even using bioclimatic architecture there are some energy consumptions that cannot be covered in a sustainable way. That is why studying and analysing additional supplies become important. In order to create a self sufficient building, the research of the supply system will be carried out to find a sustainable solution and available at the market. Renewable energies are the best option to solve this issue.

Water supply

Water supply is one of the major challenges to be faced. If substantial savings are achieved in water consumption, a more sustainable construction model will be accomplished. To carry out this objective, here there are some strategies to follow:

- Consumption reduction
- Efficient appliances.
- Rainwater and water reutilization

These strategies will be applied in three important points of this theme: cold water, hot water and heating. These three factors will determine the way water is supplied and if it is possible to reduce its consumption.

Cold Water

Taking into account the distribution of water consumption obtained in the previous section, and European regulations that stand that the consumption of domestic water must come from purified sources that meet the sanitary standards; the supply of water (both cold and hot) will be made from certified companies that comply with European regulations.

Hot water

For several daily uses the use of hot water is required. After all the research and analysis, the system chosen for this project is a mixed system. This system will consist on hybrid panel, to take advantage of the sun radiation to heat water; an accumulation tank, to store hot water for a later use; and the instant system develop by Heatworks company. The hybrid panel will provide the primary consumption and the Heatworks system will provide the exceptional consumptions (night, cloudy days,...). The hot water will be stored into the tank for later uses.

Heating

In cold climates the demand for heating during the winter can be very high. To reduce its demand, the following design criteria will be taken into account:

- Good continuous thermal insulation.
- Adequate sizing of windows.
- Installation of windows with triple glazing of low emissivity and PVC joinery or with rupture of the thermal bridge.
- Opening of windows during the hours of higher temperature during the winter.
- Installation of curtains that retain the interior heat during the hours of lower temperature.

Even so, installing a heating system is necessary. From the point of view of comfort, heating with an underfloor heating system gives higher levels of comfort. In short, instead of heating with a very hot spot, as radiators do, heat is distributed equally through the house. It has also been proven that when heated with underfloor heating, temperature of the thermostat can be reduced, maintaining the same level of thermal comfort and improving air quality, as it will be less dry. During summer, cool water can circulate through the underfloor system, cooling the whole house.

The construction and design of the entire plumbing system is not part of this project due to its complexity. Sustainability, modularity and adaptability criteria must be followed in the further research of this topic.

For further information, please check Appendix I. Water supply.

Electricity supply

To reduce the environmental impact and improve the sustainability of each significant aspect of the building design, and obtaining electricity is an important point.

- Efficient consumption: reduce energy losses by changing habits.
- Efficient Appliances: install A+++ rated appliances.
- Free energy: obtain energy by renewable sources.
- Power Storage: store energy excesses and use them during low production hours.

After a long research, it has been established a daily consumption of 46kW per 8 people. To cover this demand several solutions have been studied. All of them are related to renewable energies as solar power, wind power, hydropower, geothermal energy, biomass or marine power. After analysing carefully each of them hydropower, geothermal energy and biomass have been rejected. None of them can be included into the design. Marine power will not

be part of the design because for the specific location (Groningen), there is no waves or tides that can be used to produce energy. But this kind of energy production must be considered for other locations.

As a solution, a mixed system has been chosen: Taking into account the need for heating water, a mixed system of hybrid panels and wind turbines will be developed. 24 hybrid panel placed in two rows would produce up to 28,32kW per day. The rest can be covered by 2 wind turbines that would produce 24,12kW. The total amount of electricity would be around 52,44kW. The idea of placing two wind turbines is to prevent the lack of electricity during cloudy days. During those days, storage energy in batteries will be used.

For further information, please check Appendix I.Electricity supply.

6.5 Summary

	Bioclimatic architecture
Orientation	Best orientation to the South (maximum deviation 30°). Bigger windows to the South. Smaller to the North. Use protection over windows.
Solar Protection	Eaves are easy to incorporate to the design. Each eave length will be determined into the design phase. Windows will be placed aligned to the inner sheet of the facade.
Ventilation	Space sectorization. Windows high should reach the ceiling. Windows must incorporate micro-openings. A double sheet roof will be created following Proposal 5.
Water reutilization	Catch rainwater for non-purified uses. Use reused water as well. Create separated systems for rainwater and reused water (filters and tanks mostly). Create an external floating tank.
Thermal mass	Dismiss strategy due to big weight load.

	Supply systems
Water systems	Cold water: off-grid building is not permitted. A connection to the network is mandatory. Hot water: mixed system has been chosen. Hybrid panel + Heatworks + accumulation tank. Heating: electricity and air heating have been dismissed. Reused water can be used for this purpose. An underfloor system will be developed.
Electricity supply	Reduce losses by changing habits. Use renewable energy and efficient appliances. Mixed system: 24 hybrid panels + 2 wind turbines. Batteries storage by TESLA Inc.

Chapter 7

Modularity (Forés & Morant)

7.1 Overview

Modular architecture, why choose it? The modular architecture consists of the design and management of systems composed of separate repetitive elements (modules), similar in size, shape and functionality. These can be connected to each other, replaced or added together. All of this has as objective the optimization of the resources by means of the standardization of the constructive methods and their components.

7.2 Introduction

The modular design is the design based on the reticular modulation of spaces that allow optimizing the construction time and because they are transportable, disassembling and reorganizable, they allow to drive multiple functionalities and their reuse thanks to their adaptability to a new use different from the one they were manufactured. Modular design is an attempt to combine the advantages of industrialization with customization.

The novelty of the modular architecture is that you can replace or add any of its components (or modules) without affecting the rest of the system. The opposite of modular architecture is the integrated architecture, where there are no clear divisions between components.

Modular architecture is at the same time simple and complex. Simple because you can add modules where it is necessary and each module fits in the building without having to make adjustments on the general design. And it is complex because each module must be able to fulfil multiple functions as well as an independent function, while it must maintain the strict limits of form and size of the module.

Modules in the modular architecture must be functional to sound, space efficient, aesthetically pleasing and flexible enough to form a variety of configurations. Advantages offered by this construction system are:

Prize This system offers a very tight price and much lower than the one that is accustomed in the traditional market. Thanks to the industrialization of the process, the occurrence of unforeseen events can be minimized. The price agreed in the contract is the final price, without any variation.

Top Quality Like all industrialized qualities and finishes are under control, vices or constructive defects are not found in the future. When built in a controlled environment and with standardized guidelines, the control over the quality of the product is complete and fully meets the criteria set for its certification. In the same way, structures of perfect geometric precision and of great resistance are obtained, since they use materials of high quality able to support the transport to which they must undergo.

Delivery Team One of the most distinguished characteristic are delivery times, which are substantially reduced, in our case being able to enjoy the house in a much shorter period than in traditional construction.

Energy Efficiency Energy consumption is very similar to traditional constructions because the same resources can be used. The modular building system, due to its industrialization, is more environmentally friendly than the traditional construction during its useful life. These modules at the end of their useful life are not demolished, they can be deconstructed.

Adaptation to needs/ Customization It is possible to expand the house according to your needs at any time, it is a tremendously versatile and customizable architecture. Versatile in the sense that it is usable in permanent and temporary installations; In addition, it arrives at remote places, in which to construct a conventional building is not possible. Customizable because its constructive system allows to add, replace and eliminate modules, as well as to support all types of terminations.

Modular buildings can be enlarged or reduced by the addition or removal of certain components. This can be done without altering the larger portions of the construction. Modular buildings can also experiment changes in functionality using the same process of adding or removing modular components.

Minimum Work in Destination/ Rapidity The systematization and industrialization of the processes is able to reduce the time of production with respect to that of a conventional building and, consequently, to minimize the costs. Construction systems are usually dry assemblies, which makes it simpler and faster.

7.3 Degrees of Modularity

1. Modular: It means the home is being constructed in three dimensional boxes or "modules" at the factory. Materials are shipped to the factory where the home BEGINS in form of larger components, can be divided by rooms or even a module can be the whole house. These components (modules) are transported to the home site where the contractor will permanently attach them to each other with the foundation.

Once completed on your site, to modular home is practically indistinguishable from a common home.

2. Panelled: A panelled home is wall-mounted and shipped to the site, instead of in boxes or modules. Transportation costs are often more favourable, but this method requires more on site work.
3. Prefabricated: This simply means that the home or parts of it were prefabricated before they arrived at the site. The pieces are usually smaller than in the panelled system, making more repetitive the assembly system using more time in the site work. Roof trusses are a great example of prefabrication in homes.

7.4 Modular System applied

For the project is going to be opted degree one of modularity for the foundation, since the foundation is the part of the construction that will receive the efforts of the flotation in water and for this it is advisable that the pieces are as large as possible to achieve great stability and reduce the number of pieces required, reducing the number of anchors and joints. In contrast to the upper structure a panel system is to be used, to optimize truck transport and on-site assembly.

This allows us to have all the advantages of modularity in our project and thus offer a system totally adaptable to any need, offering different sizes of rooms to which any use can be destined since, due to its assembly system, the Enclosure allows the installation of any plumbing and electricity system to give the desired functionality for each room.

Chapter 8

Environmental impact (Gironés)

Within this chapter there is going to be a brief assessment of the impact to the environment not only caused by the building as a whole unit but also caused by the different materials used.

8.1 Life cycle assessment

Concrete In order to produce concrete, cement is the main component that affects the sustainability. In order to obtain it is necessary to calcine limestone and cement. To produce 1 m³ of concrete, it is required minimum 33 MJ of electricity, and it emits 1,5 kg CO₂ to the atmosphere. Also, the transport must not be neglected.

To assess the life cycle it is necessary to consider the global warming potential, eutrophication potential, acidification potential, toxicity and energy consumption. If arid and raw material can come from a recycled method, the emissions and energy consumption would be clearly reduced (Sjunnesson, 2005).

EPS Energy consumption to produce EPS can be returned up with its lightness, strength and insulation properties therefore is not that unsustainable. Transportation costs can be neglected and the only issue is the production of new material. Roughly, it costs 9 MJ per m³ of EPS (Mattson, 2012).

Steel Steel has the particularity that can be recycled infinite times almost on its totality. It consumes 20-50 MJ to produce 1 Kg of new steel and 6-15 MJ to recycle it. The transport costs depend on the amount transported and the distance, but it is similar to concrete (Widman, unknown year).

8.2 Study of environmental impact

Within this section is aimed to describe the main environmental impacts that the building might cause as a whole according to Leopold matrix (Ponce, unknown year).

- **Noise** Student population in the area might increase noise levels in the region, which may mean a disturbance for the fauna and other neighbors. Author recommends acoustic insulation and regulations.

	Impact	Measure to solve
Noise	Affection to the neighborhood and fauna(Negative, indirect, non cumulative and persistent)	Acoustic insulation materials plus legislation to limit noise
Water Pollution	dumping of pollutants during either the construction phase or the use phase (Negative, direct, cumulative and persistent)	Force residents not to dump anything on the water and take measures during the construction phase.
Aquatic fauna	Placing a building in the water may affect fish and other animals living there (Negative, indirect, cumulative and persistent)	Try to create facilities for animals in other places rather than in the surroundings of the building
Aquatic Flora	The location of the building might change the sun receiving zones of the area, which will affect the flora living there (Negative, indirect, cumulative and persistent)	Include materials that do not degrade under water effects and do not change the situation
Overall Quality	Possible dumping of pollutants plus increase of residents in a non residential area	Legislate regarding dumping and pollutants

Table 8.1: Environmental impacts and measures

- **Water Pollution** Human activities might result in a pollution of water. It can be during the construction, were some waste can be dumped unconsciously or during the use phase, were students can throw garbage to the water. water pollution might affect the following topics.
- **Aquatic Fauna** Little living forms might find an inconvenience to find a building on the side of the canal. Author recommends further investigation on the living forms of the lake before the construction and after to see how are they affected.
- **Aquatic Flora** Same as fauna
- **Overall Quality** Considering the disturbances mentioned before plus the addition of the increase of residents in an area not residential, it might mean a lose of species and increase of waste.

Chapter 9

Final Design (Forés & Morant)

Within this chapter is shown in a visual way how different topics have been developed. Although a proper design was not intended for this project, a proposal has been made to show simply and graphically different themes linked together. In following pages reader can find four A3 posters and each shows a representative version of each theme. Finally another A3 poster shows how all parts have been linked together, although creating a full innovative design was not part of the project plan.

In following pages it is shown the conclusions of each theme according to satisfy the connections between topics. A new relationship diagram has been developed to show the final solutions applied.

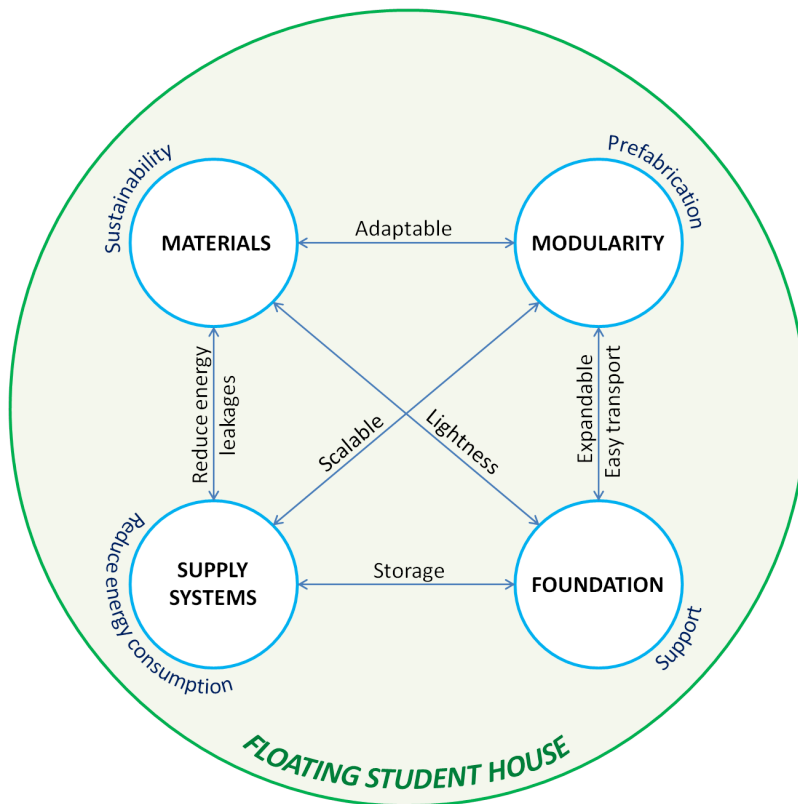

Figure 9.1: Diagram

As it is shown foundation has accomplished the requirements of support, using light materials, creating "new land" to build by adding modular blocks and creating space for storing supplies. As a conclusion for the selection of materials wood and natural materials have been selected. It accomplish the sustainability requirement and also collaborate with the lightness of the building while the enclosure helps to reduce the consumption of energy building. Regarding to modularity, a paneled system has been developed to fulfill the modularity requirements for the upper structure whereas for the foundation has been chosen a modularity system that allows maximize the dimensions of the blocks to reduce the number of pieces and joints. The modular foundation helps to create new land and expandable surface and does not condition upper structural design. For this specific proposal, a rectangular design has been chosen in order to maximize the gross floor area and reducing the number of foundation blocks used For the final theme, supply systems, the reduction of energy consumption has been achieved through the bioclimatic strategies. The use of proper insulation has helped to the reduction of energy leakages whereas the modular design of the foundation has allowed to use some block to storage water and batteries.



FINAL PRODUCT: FOUNDATION

- EPS is a light material that can be found worldwide with great lifespan and possibility to recycle. With EPS, and its lightness, the connection between foundations and materials is accomplished. For this project it is aimed to find sustainable and light materials.
- Since the properties of renewable materials such as "liquid wood" are unknown, the author cannot make that crucial assumptions. Instead of that, it is recommended further research, specially regarding durability, resistance, mechanical properties and economy.
- Fiber reinforced concrete is a more sustainable alternative than conventional concrete. Author would prefer to choose a more sustainable material, but it is the "less bad" among the bad and bio-materials are not an option because of durability issues.
- Rectangular blocks are the easiest to produce, transport and collocate. Also, with this kind of blocks, it links the foundations and modularity. Those blocks can be easily transported by road and also, easy to add. The shape of the blocks has been decided so they can collaborate and form a whole unit and being united by vertical unions.
- Unions made out of steel bars placed vertically as the image shows are resistant and durable. Moreover, with the selected shape, blocks and steel bars work uniformly which helps to redistribute efforts.
- Sustainability has not been more weighted because scope needs to be wide and some other aspects such as time available for the research and affordability also are an issue. However, some sustainable processes can be added into the project.
- Supply systems and foundations have been linked via storage. In order to add storage facilities, foundations are over-dimensioned and each block can support an extra 1000kg of water, electricity supplies or waste.
- Blocks are considered to work as a whole and not as units. The only calculated topic individually is the amount of concrete per block. Stability, buoyancy and wind have been calculated considering the whole building.

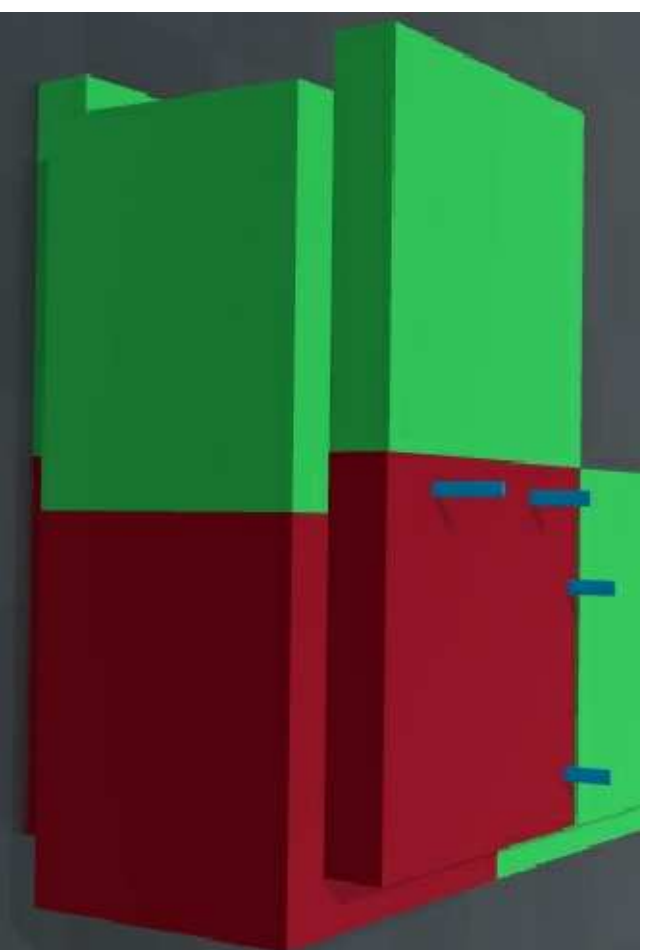
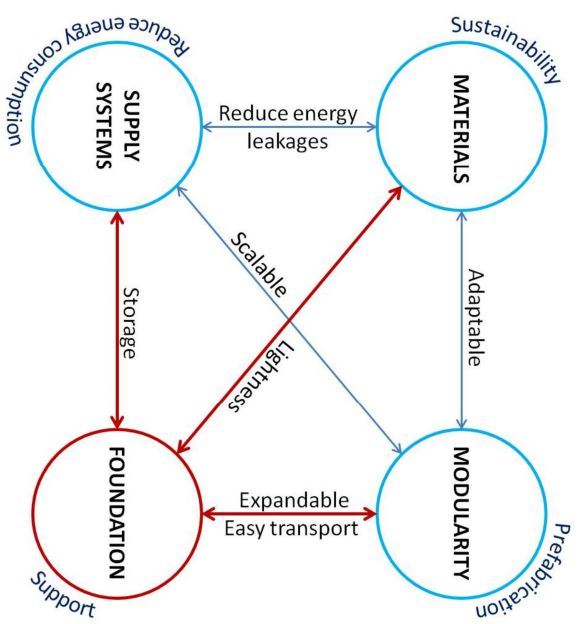

3D model of foundation block and connections

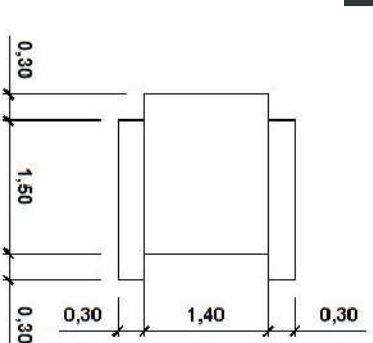
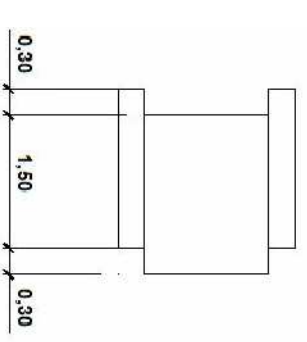
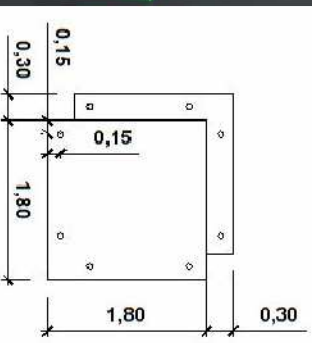
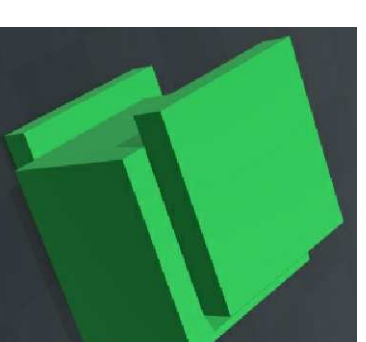

Plant, elevation, side face and 3D model



FINAL PRODUCT: MATERIALS

For the execution of walls and roof of the residence it has been chosen as a constructive solution for the enclosure composite walls of two sheets of wood and cork or wood fibres with a thickness of 28cm. Including the Firestone UltraPly TPO sheet as waterproofing on the roof, one of the most sustainable waterproofing material that can be found today in the market.

The wood is the main material in the execution of the upper structure, it is the material that best meets the criteria required by the client. The wood is a material that is used almost in its natural state and also has other qualities that make it very sustainable, its mechanical capabilities allow to apply it perfectly to any design, it is very adaptable and very advisable for a modular system because its dry set up allows assembly and disassembly very easy, besides it is a very light material to work, is very comfortable and fast. This quality also contributes to the buoyancy of the complete system, since it is a floating system the weight of the structure must be as light as possible. This is a design requirement that must be taken into account, it is very important.

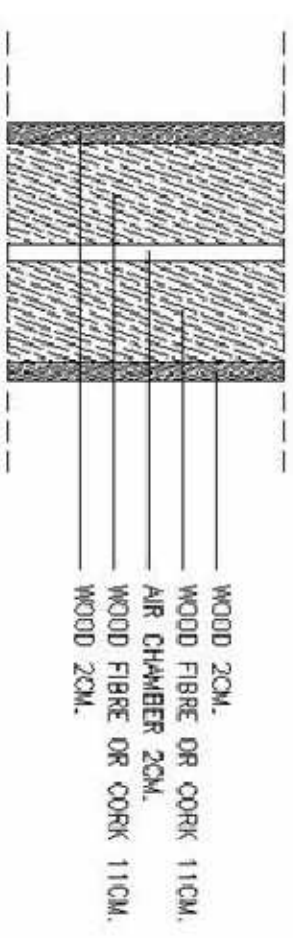

MODEL WALL

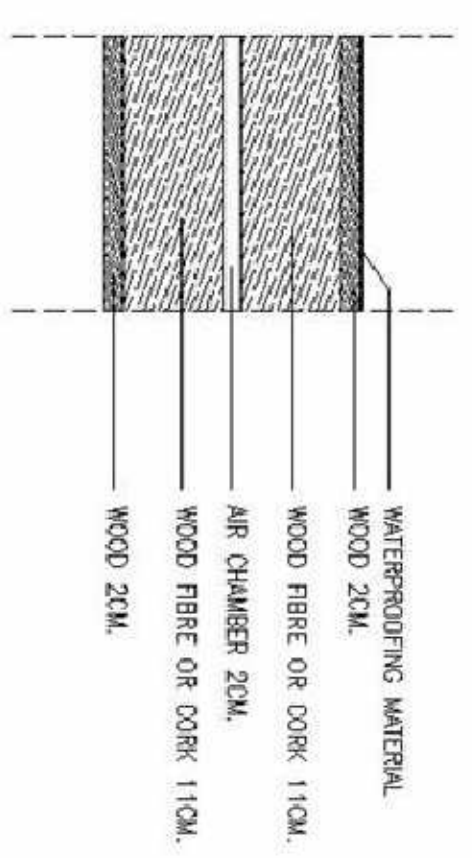

MODEL ROOF

ee thickness (m)	EXTERIOR	SHEET 1	SHEET 2	SHEET 3	SHEET 4	SHEET 5	INTERIOR	THICKNESS OF THE WALL (M)
λ conductivity (W/mK)	Rse	e	λ	e	λ	e	λ	Rsi
U (W/m ² K)	-	0.02	0.04	0.11	0.04	0.02	0.04	-
0.14954	0.04	0.5	2.75	0.017	2.75	0.5	0.13	0.28

ee thickness (m)	EXTERIOR	SHEET 1	SHEET 2	SHEET 3	SHEET 4	SHEET 5	INTERIOR	THICKNESS OF THE WALL (M)
λ conductivity (W/mK)	Rse	e	λ	e	λ	e	λ	Rsi
U (W/m ² K)	-	0.02	0.04	0.11	0.04	0.02	0.04	-
0.14954	0.04	0.5	2.75	0.017	2.75	0.5	0.13	0.28

Transmittance calculations

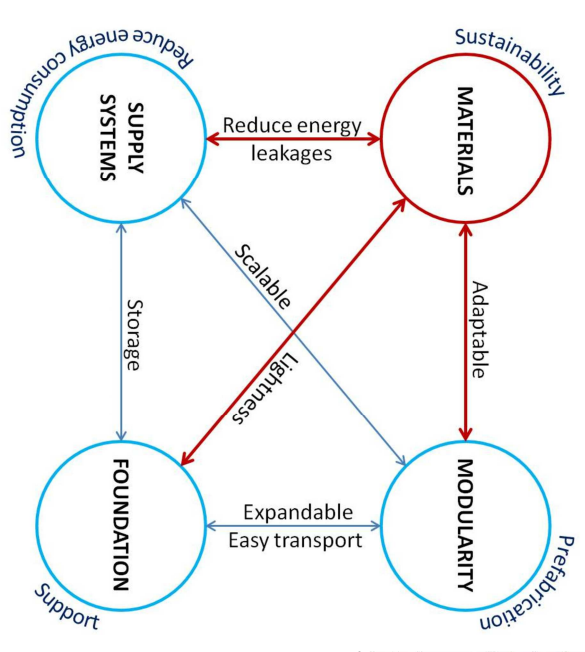

Facades + Upper structure

For these and other qualities the structure and the envelope of the building will be executed with wood, to complete the enclosure and to be a good thermal insulation two sheets of 11cm of thickness are included that can be of fibres of Wood or cork, depending on the availability of the material. With this two-leaf enclosure it is possible to comply with the requirement to have a thermal transmittance less than or equal to 0.15 W / m2K and thus be considered a passive house, which means that losses of heat are minimized thus reducing the necessary energetic consumption of the house to maintain an adequate level of comfort inside.



FINAL PRODUCT: SUPPLY SYSTEMS

ORIENTATION

1. For the specific location in Groningen, the perfect orientation is South with 30° maximum deviation.
2. Common spaces have been placed to the North.

SOLAR PROTECTION

3. Eaves and window retractions have been integrated into the design.

VENTILATION

4. Windows reached the ceiling to maximize the entrance of solar radiation and fresh air.
5. An air chamber has been created on the roof to force wind to pass through so it can generate an airflow. This airflow will create a suction effect that can be used to ventilate every room through a chimney system.

WATER REUTILIZATION

6. Rainwater harvesting: catch rainwater through the roof. Filter it before use.
7. Water reutilization: reuse water for non-purified purposes.
8. Storage: buoyant tank attached to the building or use some parts of the foundation.

WATER SUPPLY

9. Cold water: sewage needed. Off-grid building not permitted.
10. Heat: underfloor system supplied by reused water.
11. Hot water: hybrid panels + accumulation tank + Heatworks.

ELECTRICITY SUPPLY

12. Hybrid panels + wind turbines. Hybrid panels inclination = 90° - average sun elevation september-march = 90° - 21,15° = 68,85°
13. Batteries: placed at the air chamber or in some parts of the foundation.

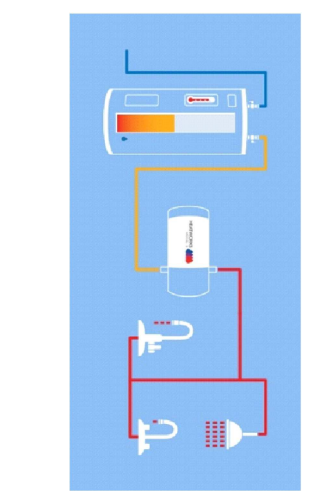
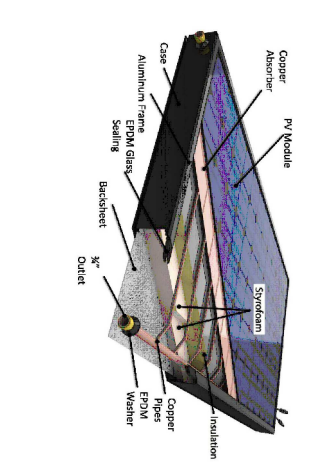
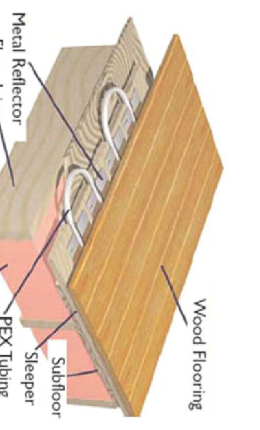
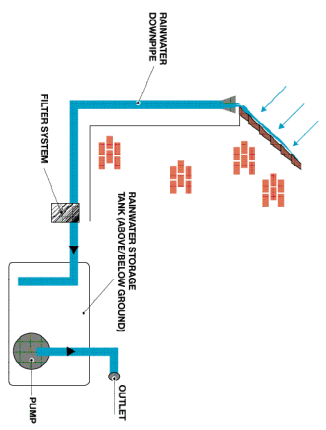
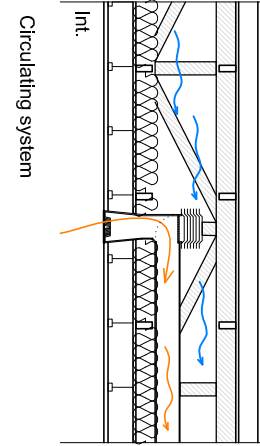
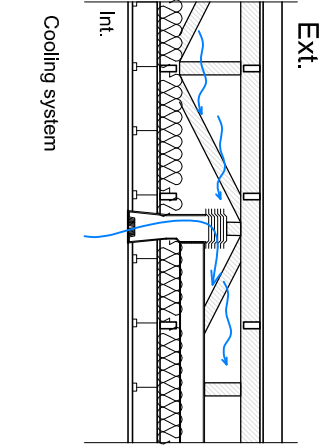
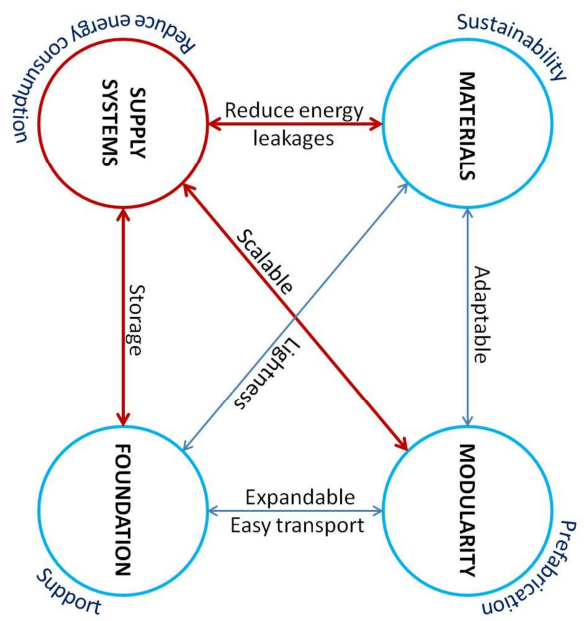



FINAL PRODUCT: MATERIALS

Modular design is an attempt to combine the advantages of industrialization with customization in a construction system. The modular design is the design based on the reticular modulation of spaces that allow optimising the construction process in different degrees.

This allows having all the advantages of modularity, it means that total price of the project is going to be established before it starts, maintaining the quality and the execution and delivery times, with a sustainable and adaptable construction. Our project offers a system totally adaptable to any need, offering different sizes of rooms to which any use can be destined for. Due to its assembly system, the enclosure allows the installation of any plumbing and electricity system to give the desired functionality for each room. So if the needs and uses of the building are changing the building can be easily adapted, adding or removing rooms.

For modularity of the foundation, it is advisable that the pieces are as large as possible to achieve great stability and reduce the number of pieces required; which means reducing the number of anchors and joints as well, since the foundation is the part of the construction that will receive the efforts of the flotation in water.

In contrast, for the upper structure a panelled system is going to be used. It means that the residence is going to be wall-mounted and shipped to the site, instead of in boxes or modules, to optimize truck transportation and on-site assembly.

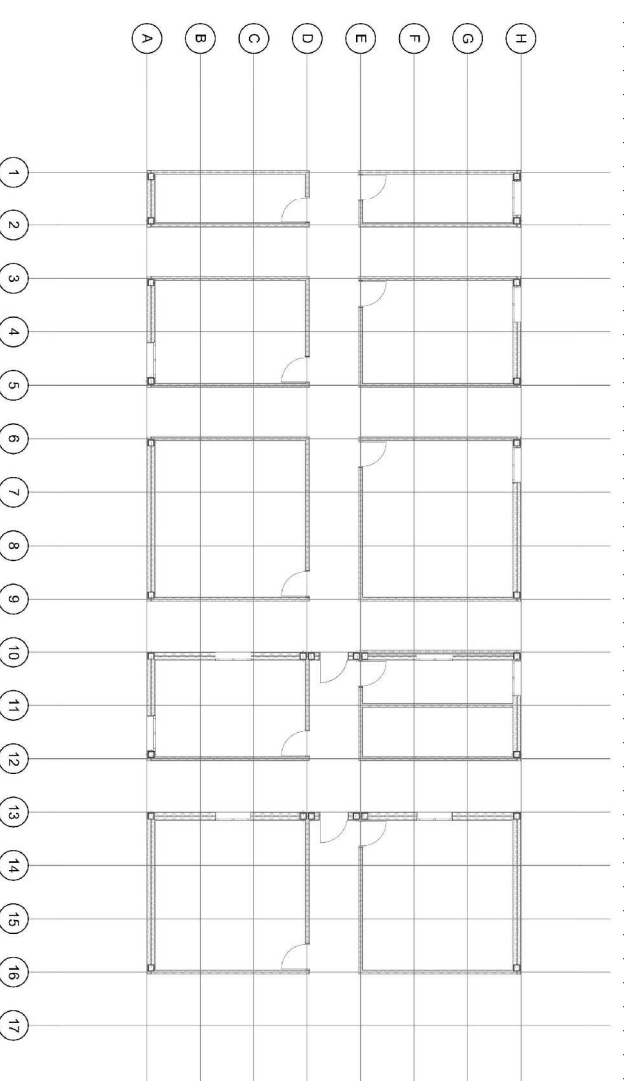
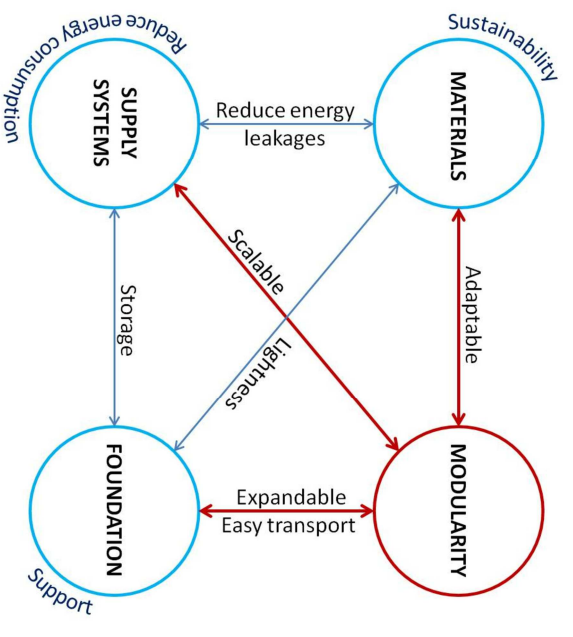

Modules available: 12,60x1,80; 12,60x3,60; 12,60x5,40m.

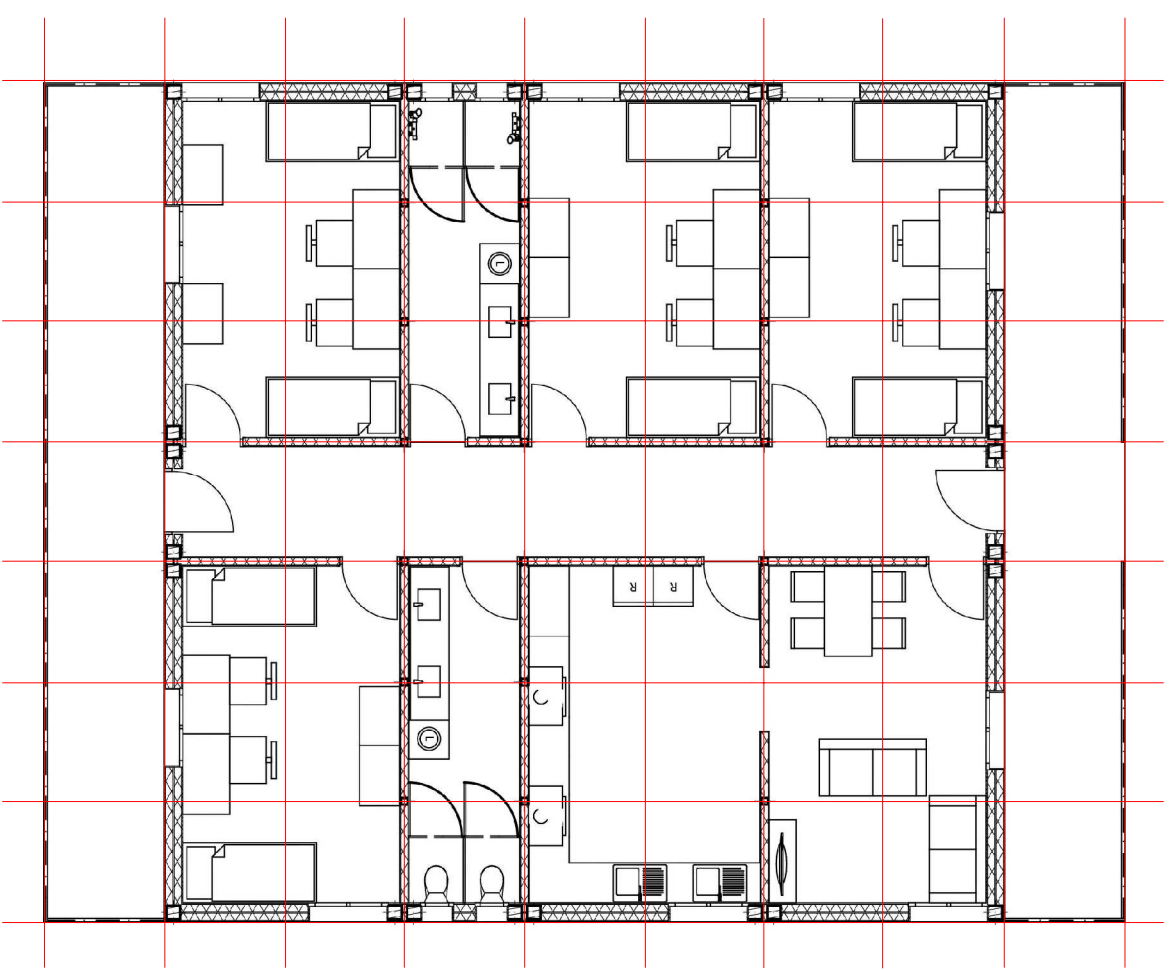

Ground floor distribution. Red net symbolizes the arrangement of foundation blocks

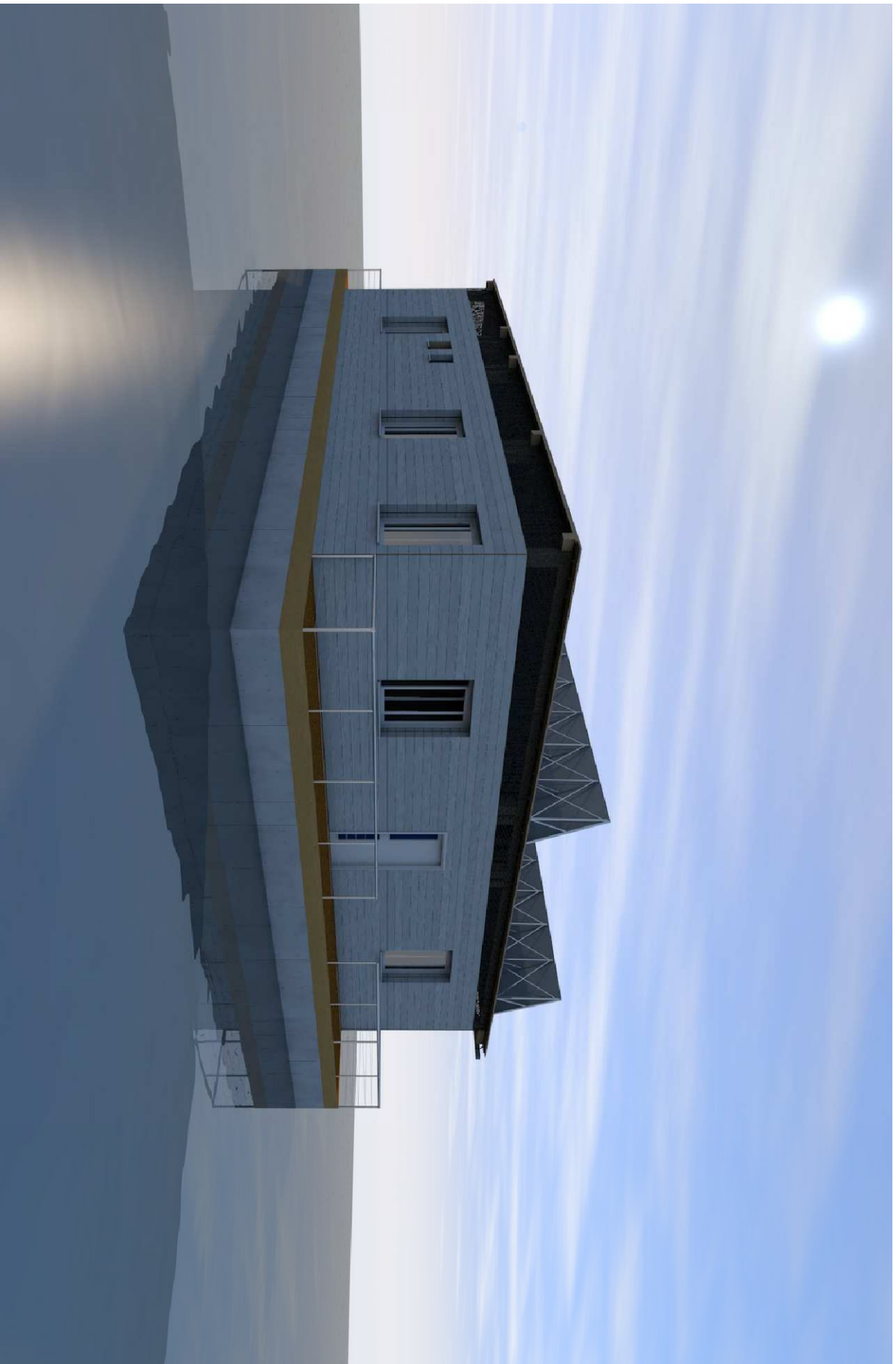

FINAL PRODUCT:

The residence is designed with the requirements agreed with the research center and these, at the same time, have been contrasted through a survey that has had the participation of 63 students who live or have ever lived in student residences. According to these criteria the residence will accommodate 8 students, the rooms are double, according to the survey students do not care sharing room and it helps to optimize spaces. Most students would like to share bathrooms, shower and kitchen with a maximum of 4 students so the residence include two separate full bathrooms and a double kitchen with lounge. The survey also shows that students prefer to live in a sustainable home if they do not have extra costs and would also be willing to change their lifestyle to take actions that reduce energy consumption and thus not harm the environment.



Foundation perspective

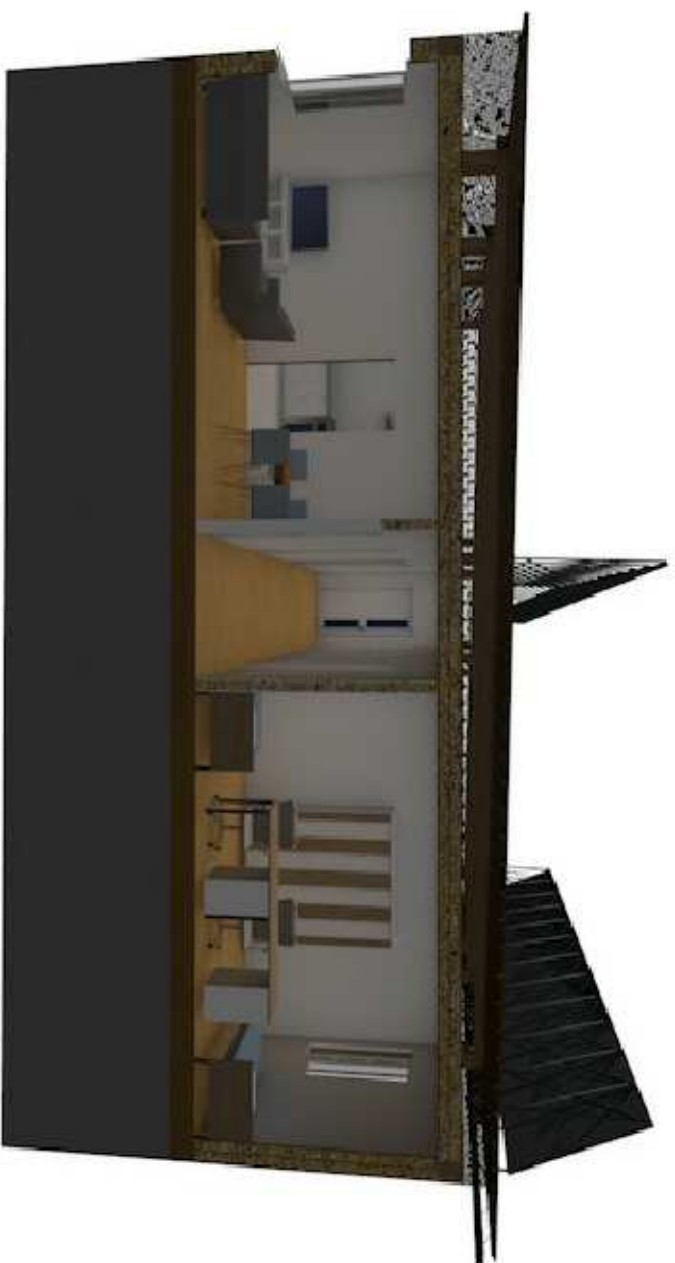

Cross Section perspective

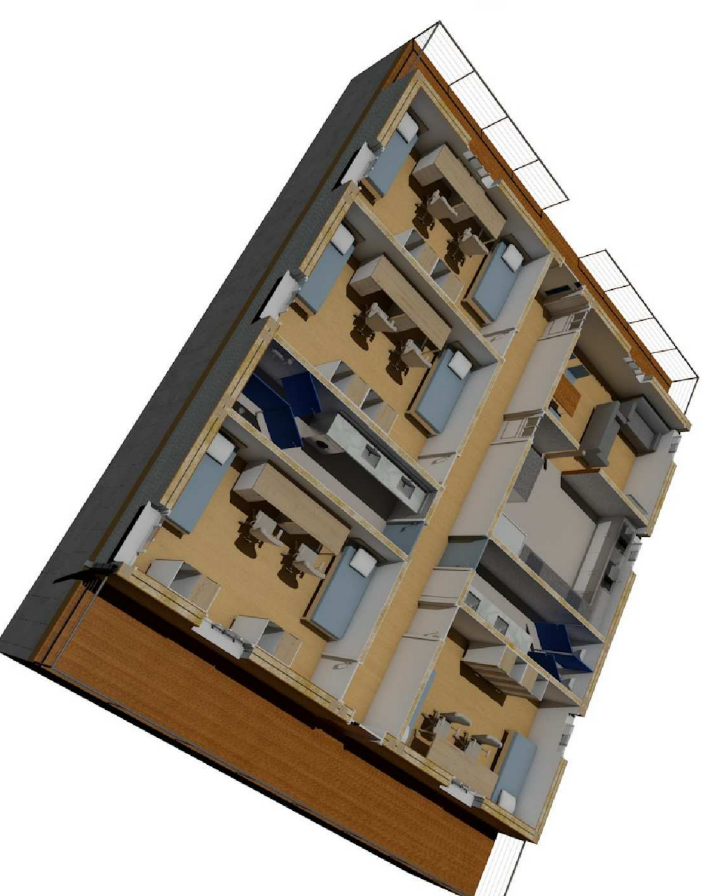

Ground floor Section perspective



Ground floor

Chapter 10

Conclusions & Recommendations

This project has been a starting point for student floating houses therefore it needs further research in many topics mentioned here. The project was aimed to solve a problem in the city of Groningen while investigating new sustainable solutions. With this project shows a first solution but of course it is not perfect and some aspects need to be improved.

Foundation The idea of modular foundation blocks has been explained here for the first time ever. In order to make a profitable business out of it, some more research has to be done. The most innovative aspect in the foundations has been the shape of the blocks that can be combined like a puzzle, on the other hand, sustainability needs to be more innovative because the materials used are the most common for floating structures and not the most sustainable to produce.

For further research author recommends to do an entire project of sustainable materials such as "liquid wood" and its durability in contact with water for the application in a foundation. Also, it is recommended to focus on technical aspects such as detailed calculations, how the building will perform against efforts considering the technical aspects. Finally, the idea of storage is barely mentioned in here, this can give to a whole new level of investigations such as how to design the blocks with detail, and how to interact better with the supply systems.

Materials & Modularity During the selection of materials sustainability has been chosen as the most determining principle, therefore the most appropriate option is wood and natural products, besides the wood offers very interesting mounting advantages. Nowadays are appearing companies that are developing alternative blocks based on natural and recycled materials but are not considered sustainable because most of them use cement as binder, which is not environmentally friendly. This blocks are a very interesting option since they are in the development phase and sure that better options will appear soon and as wood alternative blocks are also adaptable materials to any design.

With respect to modularity the design has been simplified to maximize its efficiency, since it was not the objective of the project, so there is a great margin of improvement. The chosen system is simply designed with transportation and assembly in mind, ie minimizing costs and assembly times. So as the design of the residence is very simple modular systems chosen are not very complex, so this topic can be developed widely.

Supply Systems Bioclimatic architecture strategies were developed for the specific location of Groningen. Even if those strategies depends on the specific climatic condition of an specific location, the principles explained in each section can be scalable for any location in the world. This lack of adaptability can be seen as an inconvenience but knowing these techniques may suppose an added value for the living comfort standards. In this specific topic some recommendations can be done. Thermal mass is an interesting strategy to be developed. Unfortunately, due to the floating characteristic of this project, can not be included. But a deep research on materials may open a new subject for investigation.

During the study of supply systems food and waste topics were discarded following the advice of the supervisor and the reader of this project. Those two topics represent new fields of study for further research. Including food production represents a new way to reduce the impact of human habits of consumption. About waste management, nowadays there are many project investigating about this topic (compost toilets for example), but in order to create an off-grid house, national regulations will to be checked. Is some countries this aim will not be possible, as in The Netherlands where a sewage connection is mandatory.

Full Product The full product developed has been done according to the limitations of time and help, some aspects could have been improved whereas some others are good enough.

For further research in the topic of floating structures authors recommend to go deeper in the idea of the storage, see what can be done and how the mentioned idea can be developed. Following the idea of sustainability, it is advised to keep going investigations of sustainable materials valid for construction industry in collaboration with other departments and companies to have more resources and external collaboration. Another important topic to follow would be the application of this idea worldwide, how techniques and solutions can differ from the implemented in Groningen, Netherlands which may lead to a study of the market and not just an engineering project. Focusing more in the design, this project did not focus on a innovative design as a whole, just implement new methods into a conventional building. The next step would be to focus exclusively on the design and form an innovative building for the views, which is more an architectural issue rather than an engineering.

Personal Reflection Ignasi Gironés

The competences needed to fulfill were chosen thinking about the kind of project I wanted to do. There were some requirements by the client and some restraints on the project therefore it seemed quite obvious that a statement of requirements needed to be written. Once all those boundaries were pointed out and since this kind of project has never done before, there was needed to think of possible alternatives regarding materials, shapes and unions. With the description of those alternatives and the further selection, fulfills competences two and three. Lastly, with the calculations and drawings of the selected alternative, fulfilled the last technical competence. In order to fulfill them, I was reading the indicators and try to do a similar thing in the project.

Those competences were useful since I have never had to write down all those project restraints and never done such a research for possible alternatives. It not just helped me with improving my creative thinking but also, applying all the research into alternatives for a product was a challenge since it is what is done for real engineering. Storage was the most difficult because it has never done before in a floating structure. The decision making process was the most innovative for me. The goal was to come up with a floating foundation using innovative materials and technology, unfortunately, I could not have been that innovative as I wanted to be but at least I set the goals for further research.

In order to proceed with the report. The first thing to do was analyze the client's idea and the questionnaires. We created them by ourselves according to the responses that were going to be more useful for designing the size of the building. We wanted to do a real prototype so with those questionnaires we were giving the project more realism. Afterwards, we knew what we wanted to do but still needed to find out how we wanted to achieve it. I did some research consulting companies that do similar projects and trying to find how current techniques could be applied here. With some imagination, I came up with the shape of the blocks. That shape has never been used for foundation blocks and I think it works perfectly with the different loads and forces from the building. Thanks to the research of current materials and products I could came up with this. However, it needs further research.

Once all the information was acquired, it was time to write down. I considered that the first thing to write down (After the statement of requirements, that came first) was the material analysis, once it was known what materials were to use, it was time for the shape and union method. After knowing those parameters, it was time to calculate stability, block measures to fit with the expected outcome of the house and to draw the details.

General competences were acquired working within the aFloat team. It was interesting to collaborate with such a large group and also, obtaining vision from different people to the same objective. It helped me personally to widen my vision and come up with better ideas. They were accomplish by being a multidisciplinary international group of people and also by doing presentations and meetings.

Personal Reflection Jorge Forés

Among the three components of the work team we selected the competences, these are those that we consider that represent a logical process to carry out during the project. The first one is to prepare a state of requirements and checking designs on this basis, this phase has helped us to set a starting point because for us the concept we have developed has been quite new.

The first was to analyze requirements demanded by the client and analyze some similar designs that had already been developed around the world, we also conducted a survey to try to understand the needs and tastes of students to try to satisfy the needs of the future user. In my particular case, having to make the selection of the most appropriate materials for the upper structure of the residence, the concepts that directly affect the selection are sustainability, collaboration with the energy saving, the lightness to favour the buoyancy And the modularity of the system.

Once set the context and starting point we can start with the second competition, preparing alternatives and options. To offer different alternatives I have carried out an analysis of the materials that are currently used in the construction and seeing which of them are able to adapt to the needs of a floating structure, this point has been the most complex and where I have learned the most due to the great breadth of the subject and the amount of information processed. It has been a very long and very interesting process, opening me to the world of sustainability and floating homes. The next step was to come to some conclusion, that is to meet the third selected competition, evaluating and selecting alternatives and options. This step has not been easy, you cannot always meet all the requirements, for this reason is necessary the fourth competence, detailing, calculating and drawing. In compliance with this competence, the selection carried out during the third competition is justified by technical data. These last two competences together are the result of the research process.

Having selected these four technical competences allowed us define the process to be followed during the project and at the same time has also helped us to comply with the first general competence selected; model, system and process-based thinking. We have perfectly defined the process that we have carried out step by step. The organization has been key to reach the objectives set and this system is applicable to any type of research. This organization is what has led us to achieve the last two competencies; Communicating and collaborating. The planning and prior organization of the project has allowed us to work as a group very easily, we have been collaborating with an international group of students with whom we have held meetings to exchange impressions even with some of them we have been working together continuously. It has been a very good and positive experience, but also the communication among the three components of our particular project has been perfect, the final product of our research had to integrate the theme developed by each one and the interferences have been perfectly resolved and none of the three parties have been affected. Personally, these general competences have been the most that I have enjoyed, within the work group have been developed many disciplines focused on the same objective, it has been very enriching to know other points of view and other ways of working.

Personal Reflection Andrea Morant

At the beginning of this course, I took the subject of Sustainable Cities. There I learned the importance of creating and designing spaces and buildings in a sustainable and environmentally friendly way. On the other hand, every day more and more news came up about the reduction of natural resources and the excessive daily energy expenditure generated by human beings. These two ideas were the starting point when I decided what my Final Thesis would be: home supply systems.

When I explained my idea of Final Thesis to Professor Mr. J. Tipping, he advised me to participate in a bigger project on Sustainable Floating Houses (aFloat team). This project would be carried out by Mr. M Bosscher (the client) in collaboration with Kenniscentrum, a research center affiliated with the Hanze University of Applied Sciences. The idea of investigating the supplies needed for a floating home caught my attention because in my country of origin, Spain, this type of buildings is not known. For the realization of this project I counted with the participation of Jorge Forés, in charge of material's study, and Ignasi Gironés, in charge of the foundation's study.

The project is structured according to the logical procedure of process-base thinking: to propose a problem, to undo it in sub-themes, to look for information for each sub-topic, to analyze information, to propose different solutions, to evaluate solutions according to the requirements and to obtain a final product.

At the beginning of the project, some requirements were established by the client to carry out the project. These included that the building must be sustainable, modular and could be adapted and built anywhere in the world. Despite these requirements, the design of the building required certain boundaries to be designed. These boundaries were agreed between the project editors, the client, the aFloat team and our supervisor Mr. A. van Oost. Although these boundaries were very logical, the editing group decided to test them by an online survey among students (target group). The results fitted perfectly with the assumptions made at the beginning, so the parameters of number of people, ratio people / bath and people / kitchen were set.

Once that part was finished, each member of the group began their individual work. I did a first search of information to see what was available and to know how to structure my work. After a few days I came to the conclusion of dividing it into two parts: bioclimatic architecture and supply systems. Each part responds to a different need, in the first place, to reduce consumption and losses in an efficient and sustainable way from a conscientious design, and in a second place to ensure the energy supply for the rest of the consumption uncovered with renewable energies in order to obtain a self-sufficient building.

For the Bioclimatic Architecture part I studied several strategies that allowed to reduce the consumption of heating and cooling, through the creation of a good architectural design. From each strategy several design proposals were devised. They were evaluated according to their sustainability, their modularity and their adaptability. In many cases other criteria were applied such as environmental impact, aesthetics, the carbon footprint produced or its interaction with other elements of the design (materials / foundation). All solutions are listed in the summary of Chapter 5.

In the Supply Systems part were contemplated four supplies to study: water, energy, food and waste. Due to the lack of time, and following the advice of my supervisor (Mr. A. van Oost) and my reader (Mr. J. Tipping), I decided to reduce that list to only two, water and energy. For each supply I did a search on how much is consumed and what should be taken into account to reduce it. Following these initial conclusions, I made several proposals for solutions and evaluated them following a process similar to the one mentioned above. Finally I came to the conclusion of a final design, which includes an approximate calculation for its future execution. The final solution can be checked in the summary of Chapter 5.

With this project I have learned that establishing a good design can easily solve the problem of energy supplies. And even though drinking water supply is not allowed to be obtained from unregulated sources, we are getting closer and closer to obtaining a self-sufficient and environmentally friendly home in both materials and energy. Despite not having addressed the issue of food supply and waste management, both are of great importance these days and should be taken into account for future research.

Appendix A

Statement of Requirements Foundations (Gironés)

In this chapter there will be an exposition of the client's idea of the project and how to achieve it. Moreover, the stakeholders' wishes will also be explained. There will be an explanation of the current situation regarding the client and research questions addressed in this theme.

Client

The client, (Michael Boscher via Kenniscentrum) want to create a floating house for students considering the need of the municipality to build more houses for students. The three principles that the building must fulfill are: Sustainability, modularity and adaptability.

Sustainability “the preservation of the environment as well as critical development-related issues such as the efficient use of resources, continual social progress, stable economic growth, and the eradication of poverty.”¹ Within this project, the criteria of sustainability will be applied mainly on material selection since it is the part of the construction process where it can make more the difference between other projects. The boundaries on the sustainability regarding materials are the following:

- **Resource efficiency** → How much does it cost to produce and how worth is it to use it
 1. Recycled content: What % of it can be taken from recycled materials.
 2. Natural/Renewable: Harvested naturally such as wood
 3. Locally available: Availability of this material in the region. The closer the material is produced, the lower the carbon print and the costs.
 4. Producing method: Resources needed to its production and the emissions issued during the process.
 5. Recyclable: What % of it can be turned into new materials
 6. Durable: The key issue on a foundation. The material must be durable without any maintenance. The lifespan required is 50 years.

¹<https://www.lafargeholcim-foundation.org/AboutPages/what-is-sustainable-construction>

7. Water conservation: Does it help to reduce the water consumption?

- **Indoor air quality** → Does it mean any risk for the living in the inside?
 1. Toxicity: No cancer particles must be found at any moment of the lifespan.
 2. Emissions: The chemical emissions during the manufacturing process and during the lifespan must be minimal.

Buoyancy “capable of floating; that can be floated. ”² By floatability is understood that the material has the ability to float on the water and resist the loads from the superstructure. Because of this, strong light materials that resist the action of the water and its chemicals are prioritized. The key issues of this topic are:

- **Specific weight** The weight and volume of the foundation influences the selection of material and shape. The heavier the material the deeper in the water the building is going to rest.
- **Center of gravity** In order to calculate the stability of the building, the center of gravity needs to be the lower as possible. the lower is expected to be considering the whole building, the higher the score.
- **Loads from superstructure** These loads cannot be controlled but it might be an issue where to place heavy items.

Modularity Currently, houses and buildings are designed at one piece, this means that once the building is designed and constructed, only small modifications can be made. What the client wants is evolve to a new level of architecture and engineering and being able to create a house that can be expanded and retracted at will. This means that all parts should be of a standard size and shape in order to fit with the others, this is on certain way, like a puzzle.

Adaptability This topic goes in relation to the previous one. In order to reduce the use of materials and the impact, the more adaptable the materials are, the better. Adaptable means that all parts should be able to coordinate with others to make bigger construction. This means that the unions between the forms must be done in a fast secure way. They shall not cost a significant amount of money or resources. The different systems may vary between materials and shapes.

²<http://www.dictionary.com/browse/floatability>

Third party interests

Not only there is the need to fulfill the client's expectation but also the interests from third-party-stakeholders. All stakeholders and their needs and requirements have been mentioned in chapter 2. The responses of the questionnaires show the preferences of potential residents and are displayed and discussed in appendix J

Feasibility

Besides the requirements (Both by the client and third parties), the project needs to be economically feasible, this means that on every activity done, there needs to be a study of feasibility. This will be done considering the market in Groningen and by the help of experts. On each chapter can be found a separate analysis of the topic. Since the purpose of the building is to serve students, the monthly rent they are expected to pay is around 300€ (See annex with questionnaires). This gives some restrictions at the time of designing. Some alternatives might compile most of the previous criteria but they must be competitive in Groningen's market.

Problem and research questions

The subquestions that are going to help solving the main problem are:

1. What is sustainability?
2. Which criteria can be apply?
3. What are principles of sustainability
4. How make it sustainable?
5. What materials can be used?
6. What materials are sustainable?
7. What materials are being used nowadays?
8. What is modularity?
9. How can it be modular?
10. What strategies are available?
11. How make it floating?
12. What kind of foundation can be built?
13. What system can be used?
14. Can the building grow in height (more than one floor)?

All of this subsections mentioned above, are helping to create the expected outcome, therefore, all of them are going to be answered on its correspondent chapter.

BREEAM tool

Author does not have permission to access the BREEAM Mat 01 calculator ³since it is required to be a licensed assessor. However, there still will be an assessment according to BREEAM. At the design stage, the methodology required is the following:

- Confirm that at least three mandatory building elements have achieved a Green Guide rating of A+ to D for each building envelope. The mandatory requirement applies to 100% of the area for each element.
- Where an exact match of a specification cannot be found in the green guide, it is necessary to find similar specification.
- For specifications that address a function which is not typical for the element, e.g. security, severe exposure, unusual loading or structural conditions, refer to the Code Service Provider. If in doubt, or if no similar specification is available, the assessor should contact the Code service provider for a bespoke rating.
- Where credits are sought, performance must be calculated using the method described in the calculation procedures.

³Spreadsheet developed by BREEAM to assess materials and constructions

Appendix B

Justification of selection Foundations (Gironés)

In this part of the appendix is going to be displayed the table 4.1 but with all different options which might be selected in order to justify the final decision. As explained in the main document, the weights of each section are selected according to BREEAM criteria, plus own judgment of what is suitable for a student house.

Justification of selection

Considering the results for the different parts of the foundation, the best material to build the foundation blocks is EPS, however, since by itself the score in durability is really low, it needs to be protected. The second highest score is by concrete, which has a great durability. Due to this, blocks are going to be made out of EPS plus a cover of reinforced concrete. The thickness of the layer will be calculated in appendix D. Considering the scores of the table B.1 is dis-encouraged to use bio-plastic because there is not enough information regarding them. PVC is rejected because of its low score in sustainability and metals, due to its sustainability and buoyancy. All in all, **Author would prefer to use greener materials, but there is not information available**

Secondly, the shape is going to be rectangular since it is way easier to construct, transport and collocate. Besides, the exploitation is more efficient (Space given/space used).

Lastly, unions are going to be made out of vertical steel bars since it is the best solution. The thickness and length is going to be calculated in appendix D. Again, the same issue as for the main material, metals are not sustainable to produce but if they come from recycled form, damage is reduced. If another greener material with same features was available, author would recommend it instead of steel.

Selection Criteria explanation

- **Sustainability** Following BREEAM criteria considering the whole life cycle of the material. This includes the whole process of fabrication, transport and recycle of the solution. Includes how much energy is required for its fabrication, what natural resources are used and the possibility of including recycled material and posterior recycle. 30 % because is one of the key issues.

- **Buoyancy** Considers the density of the solution and evaluates if it is suitable for a floating building. % because is not that important but still the building needs to float.
- **Easy to unite** How easy is to combine with other solutions considering forms, shapes and materials. Same weight of the buoyancy for similar reasons. Adaptability and modularity are achieved with easy unions.
- **Durability** Considers lifespan of the material. For a foundation is required that the materials stand the effects of water without maintenance. It could be higher, but since it is a prototype, it is not the main criteria.
- **Affordability** Price estimation for the selected alternative compared with the others. Same importance as the sustainability because the aim is to host students, who might have limited incomes, therefore, the costs cannot be high.

Materials

The selection of these numbers has been a mixture of author’s judgment, BREEAM criteria and expert’s opinion. BREEAM criteria and other environmental tools have been consulted and studied. Although author did not have permission to access the calculation tools, reading the codes and the recommendations, could gather an idea of what is more sustainable and the processes. Also, to contrast this information, experts on the topic were consulted to corroborate this information. Considering the limitations, it has been done what was more suitable to the project’s length and time available. A justification of the table B.1 is the following:

Solution	Sustainability	Buoyancy	Easy to unite	Durability	Affordability	total
Max. score	30 %	15 %	15 %	10 %	30 %	100 %
Concrete	10	4	12	10	25	61
EPS	17	15	12	6	20	70
PVC	7	7	12	5	15	46
Steel	12	1	12	8	10	43
Aluminum	12	3	12	9	10	46
Bioplastics	20	10	5	4	10	49

Table B.1: Selection criteria of materials

1. • Concrete is unsustainable to produce but there are some improvements recently that can help to improve the process. Recycled arid, bio-concrete are examples.

- EPS despite coming from petroleum is approximately 95 % air and can be recycled.
 - PVC is not sustainable to produce, comes from petroleum but can be recycled.
 - Metals despite being unsustainable to produce, can be recycled continuously, slightly less than the half of the score because of that.
 - Bioplastics are the most sustainable because they are made out of waste and they can be recycled. but some processes are still unclear and can be improved, that is why 20/30
2. The higher or lower graduation of buoyancy is dependent on the density of the material. The lighter the material the higher the qualification. This data is purely objective.
 3. Almost all conventional materials can be combined and work with each other with the exception on the bioplastic that since it is quite new, it is an incognito how will work. This answer is based on the Author's criteria
 4. Durability considers the lifespan with no maintenance. The longer, the higher the qualification. This data is objective.
 5. Affordability, as explained before is just a comparative between them and the relative cheapest is the highest. This data is objective.

Forms

An explanation of the table B.2 is the following:

Solution	Sustainability	Buoyancy	Easy to unite	Durability	Affordability	total
Max. score	30 %	15 %	15 %	10 %	30 %	100 %
Rectangular	25	10	15	0	25	75
Hexagonal	25	13	10	0	20	68
Combined	15	13	13	0	15	66

Table B.2: Selection criteria of forms

1. The sustainability compares the use of material and its profitability within the project and also, how sustainable is to transport and install. This is based on the Author's criteria. Combined foundation has lower scale because it is more difficult to transport it and requires specific machinery.

2. Buoyancy is based on the inertia of the section and the volume. The bigger both of them, the more buoyant. This data is objective.
3. Easy to unite compares the number of unions and how easy are to execute. This is based on the Author's criteria.
4. Durability does not influence form selection.
5. Affordability compares the price of fabrication, transport and collocation based on the Author's criteria and experts on the topic¹.

Unions

A justification of the table B.3

Solution	Sustainability	Buoyancy	Easy to unite	Durability	Affordability	total
Max. score	30 %	15 %	15 %	10 %	30 %	100 %
Vertical	20	10	13	5	25	73
Horizontal	15	13	10	7	20	65
Combined	20	13	13	5	15	66
Perimeter	15	13	5	5	10	48

Table B.3: Selection criteria of Unions

1. Sustainability considers how much material is needed to produce it. It is based on Author's criteria. Vertical unions are easier to install and the machinery required is less specific.
2. Buoyancy evaluates how heavy is the union, the position and how would it respond to all kind of stresses. It is based on Author's criteria
3. A higher score in easy to unite evaluates the time and cost of the union. Based on Author's criteria and the actual market.
4. Durability shows the lifespan on the union in relation to the price. It is based on Author's criteria and actual market solutions.
5. Affordability shows the price in relation to other solutions. This is based on expert's criteria that were consulted.

¹Companies such as Marinetek (Finland) or Dura Vermeer (Netherlands) gave the author and idea

Appendix C

Foundations Full Process (Gironés)

During this chapter, there will be an assessment of materials used in current foundations of floating buildings. Moreover to that, some materials with potential of being used will be also assessed. The criteria on which will be based the comparative is explained in following sections. After comparing all possible materials there will be an assessment of the shapes and forms of the foundation blocks. Since one of the main criteria is the modularity, foundation blocks need to be easily combined to make bigger surfaces. Different options will be explained and compared including calculations and drawings. After explaining both materials and forms, there will be a selection of an alternative with its justification. Once taking into account that option, it will be followed with detailed calculations, drawings, rough cost estimation and environmental impact. Sustainability is one of the key criteria and shall be taken into account on every step.

Materials

Within this section there will be an exposition of all current materials with potential of being used, there will be an explanation of their properties and their suitability or not in the project. The criteria to make the selection has been explained in the previous section but the author would like to remark that the most important issues are the sustainability and the affordability. At the end of the chapter, the table explained before will be filled out with the different options regarding materials.

Concrete

Traditionally, concrete has been the most used construction material due to its properties, however, there are many issues regarding its sustainability. Around 5 % of global emissions of CO₂ are caused by the production of concrete. Although there is room for improvement and recycle, the construction sector should have less dependency on concrete. However, the use of recycled arid is becoming popular in Europe, specially in Germany, where almost half of the materials used for new concrete production are recycled.

Concrete for floating structures Concrete is being used for heavy marine structures. Vertical dikes are a good example of it. Most hard constructions regarding coastal protection are made out of steel reinforced concrete, some of them are floating such as breakwaters, docks or wind power plants. The benefits of the concrete in floating structures are:

- Resistant to corrosion due to salty water
- Low cost of maintenance
- Durable up to 70 years
- Lower costs in compare to steel
- Low center of gravity which helps stability
- High mass of the moment of inertia helping stability
- Good insulation

Concrete for floating homes Considering all advantages pointed out before, it is understandable that many floating homes all over the world have their foundation made out of a steel reinforced concrete hull. This homes have the particular advantage that they include a basement since the concrete has to go deep into the water to find the equilibrium position. Recently, some companies are including the use of EPS in the concrete to create the so-called flexbase ¹. Moreover to the problems regarding sustainability, using a concrete hull might not meet the client requirements of sustainability and adaptability since the house has to be fully designed and constructed at once and not being able to be modular.

Conclusion The use of concrete (as it is now) is dis-encouraged by the client and other environmental-friendly researches, however, its properties make it the most used material for its good-quality and cheap products and also, there is room for improving the actual technologies and procedures.

EPS

EPS (Expanded Polystyrene) is defined as: "Plastic cellular and rigid material made out of a model of pre-expanded pearls of polystyrene expandable that presents a closed-cell structure filled up with air." Once expanded, the final product is 98 % air, odorless, non pollutant and recyclable. Its mechanical properties according to the manufacturer "Insulation Technology Inc." can be found in image C.1.

EPS is the main material of floating homes. It started to being used by a collaboration of the Dutch floating home constructor "Dura Vermeer" and the EPS producer "Kingspan Unidek". The reasons why is becoming extremely popular among floating structures are:

- **Durability** It can last without any treatment up to 20 years, but, if a 1.25" coat of polyethylene is added, the lifespan can reach up to 80 years. Since durability is the main criteria of a foundation, most durable option shall be taken into serious

¹Created by Dura Vermeer and Kingspan Unidek

Specification Reference: ASTM C 578-92			Type I	Type VIII	Type II	Type IX
Property	Units	ASTM Test				
Density, minimum	(pcf)	D 303 or D 1622	0.90	1.15	1.35	1.80
Density Range			0.90-1.14	1.15-1.34	1.35-1.79	1.80-2.20
Thermal Conductivity	at 25 F BTU/(hr.)	C 177 or C 518	0.23	0.22	0.21	0.20
K Factor	at 40 F (sq.ft.)(F/in.)		0.24	0.235	0.22	0.21
	at 75 F		0.26	0.255	0.24	0.23
Thermal Resistance	at 25 F at 1 inch		4.35	4.54	4.76	5.00
R-value*	at 40 F thickness		4.17	4.25	4.55	4.76
	at 75 F		3.85	3.92	4.17	4.35
Strength Properties						
Compressive 10% Deformation	psi	D 1621	10 - 14	13 - 18	15 - 21	25 - 33
Flexural	psi	C 203	25 - 30	30 - 38	40 - 50	50 - 75
Tensile	psi	D 1623	16 - 20	17 - 21	18 - 22	23 - 27
Shear	psi	D 723	18 - 22	23 - 25	26 - 32	33 - 37
Shear Modulus	psi	—	280 - 320	370 - 410	460 - 500	600 - 640
Modulus of Elasticity	psi	—	180 - 220	250 - 310	320 - 360	460 - 500
Moisture Resistance						
WVT	perm. in	E 96	2.0 - 5.0	1.5 - 3.5	1.0 - 3.5	0.6 - 2.0
Absorption (vol.)	%	C 272	less than 4.0	less than 3.0	less than 3.0	less than 2.0
Capillarity	—	—	none	none	none	none
Coefficient of Thermal Expansion	in./in.)(F)	D696	0.000035	0.000035	0.000035	0.000035
Maximum Service Temperature						
Long-term exposure	'F	—	167	167	167	167
Intermittent exposure			180	180	180	180
Oxygen index	%	D 2863	24.0	24.0	24.0	24.0

* R-value means the resistance to heat flow. The higher the R-value, the greater the resistance to heat flow.

Figure C.1: Characteristics of EPS

consideration. It does not present nutritional value, hence it is not attacked by fungus or bacteria.

- **Light Weight** EPS is made up to 95-98 % air. This makes it extremely useful for a foundation of floating buildings because of floating issues. The density values may vary between 10 to 35 Kg/m³
- **Insulation** A floating building is surrounded by water and therefore, humidity. In order to make the house sustainable and not use too much energy for heating in winter, it is crucial to have good insulation. Due to its closed air cells EPS has a low thermal conductivity. Moreover, it presents qualities to absorb impact noise. Considering other insulating materials, it presents the best quality/prize ratio.
- **Water Resistant** Despite being most of it air, the absorption of water by the cells is minimal. Moreover, its chemical resistance makes it suitable to resist all kinds of chemical agents that might be on water and the pass of time. Fungus and bacteria cannot grow easily on EPS. If a resistance layer is added, the probability of bacteria grow is almost null. Lastly, it has big resistance to humidity. Even in water-submerged, the absorption values vary between 1-3 % of its volume.
- **Mechanic Resistance** The compression resistance varies between 15 and 70 KPa, this makes it useful for a foundation of a 1-2 store building if it works in collaboration

with steel reinforced concrete. In addition it presents good properties of traction and flexion.

- **Chemical Resistance** EPS shows resistance against most acids (in less than 50 % of purity), sea water, alcohols and soaps.
- **Versatility** It can be made in any size or shape and it has been proved its compatibility with a wide range of materials including concrete and metals. Due to its lightness it is really easy to transport and collocate saving money in the process.
- **Recyclable** EPS is 100 % recyclable to other forms of the same material. It is esteemed that almost 50 % of new EPS forms, come from recycled material.
- **Sustainability** Although it comes from petroleum, the total extractions of petroleum that are dedicated to all plastic production are barely 4% of the total extractions, this makes there is even more room for improvement. In addition, EPS does not contain CFC's or HCFC's and does not mean risks for environment and health. The transformation process does consume little energy and does not generate waste.

Despite the big advantages it present, there are some disadvantages that must not be neglected.

- EPS comes from petroleum, sustainability is one of the criteria by the client, despite its benefits, the non-use of petroleum derived materials is encouraged by the client.
- If someted to thermal variations, it might suffer from expansion, the expansion varies between 0.05-0.07 mm/mK^o Also, the upper limit is 20kPa when exposed to a 80°C temperature.
- Although it resist most acids, it shows problems when in contact of alkaline solutions, organic solvents, hydrocarbon, artificial oils (Silicon, paraffin, Vaseline..) and gasoline. In this products, EPS might present either contraction or dissolve.
- As most organic materials, polystyrene foam is flammable, in reality, it depends in which conditions is submitted. Once passed the 100°C, it starts to soften and to melt slowly. During this process, even if exposed to direct sun radiation, it might emit flammable gases. However, it meets the European requirements regarding fire security.

Conclusion EPS is a good, light, cheap material that is becoming important in the engineering industry. The only issue is the petroleum procedure. It will be compared to other materials using the selection criteria mentioned before. Whether or not will be used will be discussed later.

PVC

PVC (Polyvinyl chloride) is among the three synthetic plastics most used all over the world. For construction, it is used the hard PVC. The properties which will make it suitable for the foundation are:

- **Low density** The density varies between 1300-1450 kg/m³ which makes it just a bit heavier than water.
- **Mechanical Properties** Hard PVC has an elastic modulus of 1500-3000 MPa and a compression resistance of 52MPa, this makes it quite useful and stiff.
- **Fire properties** PVC starts to decompose at the temperature of 140°C, at that value, starts the decomposition, and at 160°C, starts the melting.
- **Chemical properties** PVC is resistant to most acids, salts, bases, alcohols and oils. That is why it is commonly used as piping material. It can only be degraded with big quantities of acetone or other solvents, but the damage would be small.
- **Durability** Most PVC manufactured now has a lifespan of 50 years, although this number can be increased with some additives. It can be recycled seven times up to a lifespan of 140 years.

Despite the advantages, the inconveniences of PVC regarding sustainability and health are important.

- **Sustainability** Despite being 57 % salt, PVC comes from petroleum and the procedure methods are quite un-sustainable in which include toxic chemicals and dioxins. Moreover, its additives are also non-sustainable to produce.
- **Health issues** One dioxin used to produce PVC might develop cancer and hormone disruption

Conclusion Considering everything mentioned above, PVC is a cheap good material that could be useful for covering the blocks in case the inner material is weak against water effects. Since the use of PVC for structural designs is not spread, some extra texts never done before might have to be done. Due to this, the author only proposes its possible use for covering the foundation blocks in case that the inner material is more susceptible and due to sustainability issues, only if the PVC comes from a recycled process and never from a brand-new product.

Metals

Metals such as aluminum or steel have been being used in the construction sector for a long time hence their importance does not have to be neglected. It is known that the production of metals is not sustainable but on the other hand their durability can be great and their possibility of recycling is wide. In the following sub sections, the most common will be explained and at the end, a conclusion will be exposed.

Steel

Steel has been being used in construction because of its durability, affordability and versatility. The reasons are:

- **strong** Compared to other construction materials, steel has the best ratio of strength to weight and also it stands both compression and tension forces
- **Durability** Steel is fire resistant thus does not provide fuel in case of fire and also, since it is not organic, it does not rot. This reduces the conservation costs.
- **Recyclable** Steel that is produced nowadays contain about 60 % of recycled steel. This number can be increased in following years since new techniques are available.
- **affordable** Since there is a huge steel industry, the prices are competitive worldwide.

However, steel presents several inconveniences for its use on a floating structure such as its weight, and also, since the client wants the to be sustainable and innovative, the production of steel might be "old fashioned." The author recommends its use exclusively on steel bars for the unions of blocks.

Aluminum

Aluminum has similar properties than steel, however it is important to remark some properties:

- **Lightness** Aluminum density is almost 3 times lower than steel. Since no big forces need to be supported by the metal, and the building needs to float, weight needs to be considered.
- **Corrosion resistance** While steel needs to be protected against corrosion, aluminum resists it by itself.
- **Recyclable** Theoretically, aluminum is 100 % recyclable and the proportion of recycled aluminum in Europe is higher than the steel (85 % in construction sector)

- **Health issues** While steel is known to have any affection to the health and safety, aluminum does. In high doses can affect the blood-brain barrier and some people might be allergic to it.
- **Effects on environment** Despite being harmless, aluminum might cause effects on plant growth on acid soils.

Conclusion Metals are not sustainable to produce however their lifespan and possibility to recycle are enormous compared to other materials but on the other hand they are strong and affordable. As said before, the author recommends steel for the reinforced bars to tight the different parts of the structure together while aluminum is a possibility for covering the outside part of the blocks in case the inner material does not stand the effects of water.

Bioplastics

Bioplastics are a growing trend in eco-architecture and green buildings. The difference between conventional plastics is that they are made out of renewable bio-masses such as vegetable oils, corn or microbiota. instead of petroleum. In other words, they are made from waste or pollutants that in other way, they would end up dumped.

The uses of this bioplastics are more expanded in other industries rather the construction, however, there is enough room for improvement. Recently, it has been discovered a thing called "liquid wood" or Arboform ² Its properties are similar to conventional wood. The main features of this product are:

- Lignin from paper production is mixed with natural fibers and additives and gives a product mechanically similar to wood
- With the additives one can modify properties
- The recycle of this material still being discussed but basically depends on the proportion of fibers, cellulose and additives.
- can be processed with injection moulding, extrusion, calendering, blow molding, deep drawing or pressing into moulded parts, half-finished product, sheets, films oder profiles.³
- Tensile and compressive stress might vary between 22-60MPa, with a similar behavior than wood.

The disadvantages regarding this materials focus mainly on durability, chemical resistance and affordability.

²Derived from wood pulp-based lignin and invented by German company Tecnar

³Taken from Tecnar product description

- Since it was invented in 2013, there have not been many investigations regarding durability. Its use is more for daily products rather than construction materials.
- Its fabrication is not worldwide spread, therefore not in many places one can get this material with the desired features.
- A foundation has to resist without any maintenance for the whole lifespan. It is unknown how it will behave in the future specially being constantly in contact with water.

Conclusion This material seems to fulfill all criteria from the client, however, it is still an incognito whether can be used as a serial construction material. Currently there is just one construction made out of liquid wood, in Stuttgart, Germany. The author recommends to follow closely how the investigations go, get in contact with experts and then decide if it is usable. If other materials are not an option, it seems to be feasible paying special attention to the durability.

Forms

Once exposed the different materials which are potential to be used, the following issue to solve is the shape of the foundation. In order to respect the client's idea of modularity and adaptability, the intended result is a combination of blocks that can be easily combined to form bigger surfaces. The starting point of this section is that blocks must not exceed the limits for conventional road transportation. In Europe, those limits are 2,5x4,5x12m. Without entering in detail regarding the materials, in following subsections there will be an exposition of solutions with sketches and an analysis of their advantages and disadvantages.

Rectangular blocks

The first idea that comes into mind when thinking about modular constructions is to make rectangular blocks that can be easily combined such as in a marina dock. Many companies use similar shape-blocks to create pontoons or docks. They have logistic advantages such as they are easy to construct, transport and collocate. Moreover, a four-side block has less unions which reduces the cost and time of construction.

For this solution, the expected outcome is a foundation independent of the upper structure made out of blocks. The height of those must be calculated according to the expected loads. It fulfills the criteria of modularity and adaptability since the unions should be done in an easy way and the structure can be made bigger or smaller at will. Since it is independent from the upper structure it goes separately on all matters. The purpose of this is to create a system that supports the loads from above and to be independent.

Hexagonal blocks

Similar Idea and principles than the rectangular block, but in this case, the shape is an hexagon. The constructive methods, transport and collocation are identical. the advantages and disadvantages in relation with the rectangular blocks are:

Advantages

1. When combined with other hexagons, is more stable against the effects of waves and wind due that unions are oriented in three different directions instead of two.
2. Internal angles are wider, which are better to support tensions and more resistant.

Disadvantages

1. More difficult to construct due to technical limitations in certain places. Construct rectangles is always easier.
2. The presence of more joints increases both costs and time.

3. A combination of hexagonal blocks might form a final shape of the base that might be "unusual"

Combined foundation

This section contemplates the possibility of applying the criteria of modularity on a bigger scale. Foundation and upper structure go together, this means that the foundation is made and calculated according to the weight that is going to receive on top. It is a stage in the middle of the actual scenario and the proposed in previous sections. The key points are:

- There are different standard sizes for foundation depending on the room, this means that all rooms have same size and can be added as one full piece.
- Every part of the house can be mounted and dismounted at will.
- Foundations are calculated according the estimated weight that is going to receive on top, however, they must be at the same level.

As mentioned before, this solution is a step in the middle between current floating houses and the original idea of the client. Advantages and disadvantages of this method against the blocks are:

Advantages

1. The building can be expanded at will since the client can add as many different parts making the mounting process really easy.
2. Since parts of foundation are bigger, it reduce the number of unions, which reduces time and costs.
3. Construction will be done entirely on workshop, increasing the quality.

Disadvantages

1. Making different parts of the building separately with independent foundation might create difference between levels of the house, special attention in the calculations must be paid.
2. Transportation might be and inconvenience if the European road limitations are exceeded.
3. If many different parts are combined, there will be "double walls" between parts of the house with the waste use of material it means.
4. It might require the use of a perimeter cable to tight all parts of the building.

Conclusions

Depending on how to interpret the idea of modularity and scalability one or other option would be the selected. Apparently all of them fulfill the criteria at different levels. Blocks accomplish the criteria on a deeper state, on the foundation stage. Foundation and upper structure go separated therefore the foundation is constructed first and afterwards goes to construction on top whereas in combined foundation those items go together. Without entering in any detail of material or logistics, the author considers having a terminated product and then launch it and attach it to other elements is more innovative and adds the peculiarity that the house can be mounted and dismounted at will.

Moreover, if the construction of the upper structure is taken into account, authors of those topics regarding the upper structure consider that terminated blocks fulfill more their criteria and they would prefer an adaptable building rather than a separated one.

Unions

Depending on the type of blocks and the material used, a different kind of union is required. In this section there is going to be an explanation of possibilities considering different shapes and inside that, how to solve issues that any material might cause.

Unions in modular blocks

Modular blocks have the particularity that they form a bigger uniform surface. Connections between blocks should be identical in order to make easier both the design and constructive procedure. According to the direction of the union, they can be horizontal or vertical.

Horizontal union

Here the union goes in the direction of the surface. Currently this is the most used union. Nowadays companies are using steel bars to connect different modules together.

Advantages

1. It is easier to construct since the unions are placed on top or bottom and all the blocks can be identical in all sides.

Disadvantages

1. As seen in the image, unions are placed only in the upper side of the blocks, which might create instability in case of strong wind and/or waves.

Vertical union

Here the union goes perpendicular to the surface, the image below shows how a disposal could be done. They have the particularity that strengthens the union against waves or different unexpected weights in the building.

Advantages

1. Makes the final product stiffer against differential vertical loads.
2. Might be easier to mount and dismount at will

Disadvantages

1. Blocks are not uniform on all sides depending on the vertical union.
2. It might be difficult to prepare the blocks for this kind of union regarding durability issues.

Unions in full modules

Full modules have the particularity that are already a designed and terminated product. This means that when attached to other modules, are already a part of the building. The proposed union for this modules are attachments similar to train wagons that can be mounted and dismounted at will as the image shows.

Advantages

1. Makes them really easy to mount and dismount at will
2. Units are completely independent and work individually and combined.

Disadvantages

1. It might be a complex and expensive method.
2. It might be difficult to prepare the blocks for this kind of union regarding durability issues.

Perimeter unions

This kind of union is a perimeter tensed cable that tightens all parts together. If demonstrated that any of the previous method is capable enough to safely tight all parts, this solution is not necessary. However, it is being used in some constructions and will give an extra of stiffness to the building, and also, to redistribute the efforts in all the surface.

The inconvenient it presents is regarding the principle of adaptability. Once set, it is difficult and expensive to un-tight it. This means that if the client wants to add more parts to the building, the perimeter cable has to be upgraded.

Appendix D

Calculations Foundations (Gironés)

In this part of the appendix is going to be displayed the whole calculation process. For the whole process the foundation is considered to work as an unique form.

Loads

The following bullets shows the material selected and its weight according to the Spanish código técnico de la Edificación.

Foundation+Floor

$$(0,4 + 2 + 0,5) \cdot 11,3 \cdot 11,8 = 387KN \quad (D.1)$$

Where;

- 0,4 KN/m² Weight of the selected floor
- 2 KN/m² weight of the platform
- 0,5 KN/m² Expected weight of the foundation

Walls

$$(2 \cdot 0,15 \cdot 3,5 + 2 \cdot 8 \cdot 0,11 \cdot 3,5) \cdot (11,8 \cdot 2 + 11,3 \cdot 2) = 333,1KN \quad (D.2)$$

Where 3,5 11,3 11,8 are the mesures of the building and 0,15 8 the weights of the material.

The inner walls are considered an uniform spread force of 1.1 KN/m², which in all surface is 146.7 KN

Roof

$$(2 \cdot 0,15 + 2 \cdot 8 \cdot 0,11) \cdot (11,3 \cdot 11,8) = 274,6KN \quad (D.3)$$

Where;

Action combination in Ultimate State limit

Total Dead loads:

$$387 + 333,1 + 274,6 + 146,7 = 1140KN \rightarrow 1140 \cdot 1.35 = 1539,5 \rightarrow 11.5KN/m^2 \quad (D.4)$$

Use+Snow loads

$$(2 + 1) \cdot 1.5 = 4.5 \text{KN/m}^2 \quad (\text{D.5})$$

The total load of the building is $11.5+4.5 \text{ KN/m}^2 = 16 \text{ KN/m}^2$. Considering it a punctual force, its resultant in the center of gravity is **2139 KN**.

	Unit Weight	Thickness	Length	Wide	Total
Use+Snow	2+1(Kn/m ²)	na	11,3	11,8	x
Floor+Foundation	2.9	na	11.3	11.8	387KN
Roof	2*(0.15+8)	na+0.11	11.3	11.8	274,6
Walls	x	x	x	x	x
Total					x

Table D.1: Loads Upper structure

Buoyancy

Buoyancy is the vertical force by water that supports the building on top of it. In order to increase security, the size of the foundation is going to be 0,5m bigger in all sides of the building. Buoyancy is calculated by:

$$F_b = V_s \cdot D \cdot g \quad (\text{D.6})$$

Where F_b is the vertical force by water(2139KN), V_s is the volume occupied, D is the density of the fluid (1000kN/m³) and g is gravity (9.81 m/s²). Following the action-reaction principle, F_b is the total load from the building, with this, and considering fixed sizes of the building, the incognito is the height of the building submerged plus a security factor of 0,8.

$$2139 = 9,8 \cdot 12,3 \cdot 12,8 \cdot H \cdot 0,8 \rightarrow H = 1,7m \quad (\text{D.7})$$

In order to make numbers even and easier to design, **The height of blocks is going to be 2m**. A maximum of 1,7 will be submerged and the 0,3 will be an extra security measure.

Stability

To calculate stability, the first thing to do is calculate the center of gravity of the building. Considering symmetry of forms and loads, the only parameter to calculate is the vertical position of the center of gravity.

Center of Gravity Assuming symmetry on both axis in the plant view, the calculation of center of gravity gets easier. The procedure is to calculate the weight of the roof, walls, floor and foundation and then calculate the position of the center.

Roof:

$$0,15 \cdot 2 \cdot 11,3 + 2 \cdot 8 \cdot 11,3 \cdot 0,11 + 1 \cdot 11,3 = 346,6 \quad (\text{D.8})$$

Walls:

$$0,15 \cdot 3,5 \cdot 2 + 2 \cdot 8 \cdot 3,5 \cdot 0,11 = 7,21 \quad (\text{D.9})$$

Floor:

$$2,4 \cdot 11,3 + 2 \cdot 11,3 = 49,72 \quad (\text{D.10})$$

Foundation:

$$0,5 \cdot 2 \cdot 11,3 = 11,3 \quad (\text{D.11})$$

Position of center of gravity from the bottom of the foundation:

$$y = \frac{34,6 \cdot 5,5 + 7,21 \cdot 3,75 + 4,9 \cdot 72,2 + 11,3 \cdot 1}{34,6 + 7,21 + 49,72 + 11,3} \rightarrow \mathbf{y=3,2m} \quad (\text{D.12})$$

Once calculated the center of gravity, the calculation of stability can proceed. The principle in which is addressed stability is: A floating object will be stable if its center of gravity is below its metacenter. Metcenter is defined as:” The point of intersection between a vertical line through the center of buoyancy of a floating body such as a ship and a vertical line through the new center of buoyancy when the body is tilted”¹. Distance to metacenter from center of buoyancy²(In our case, around $C_b=0,5-0,8m$ from the bottom) is calculated with he formula:

$$MB = I/V_s \quad (\text{D.13})$$

Where MB is the distance to calculate, I the minimal inertia from the horizontal section taken in the water surface and V_d the volume displaced of water.

$$I = \frac{1 \cdot B \cdot A^3}{12} \quad (\text{D.14})$$

where $A \leq B$

In this case:

$$I = \frac{1 \cdot 12,8 \cdot 12,3^3}{12} = 1984,9m^4 \quad (\text{D.15})$$

$$V_s = 1,5 * 12,8 * 12,3 = 236m^3 \quad (\text{D.16})$$

$$MB = 1984,9/236 = 8,4m \quad (\text{D.17})$$

¹Definition by Oxford dictionary

²Center of gravity for the volume of water which the house displaces

If, $MB+C_b$ is higher than the center of gravity, the building is stable by itself.

$$0,5 + 8,4 \gg 3,2 \quad (D.18)$$

The building is stable.

Wind

According to Dutch Regulations, wind in the case of study is to consider a value of $1,4 \text{ KN/m}^2$ in any side of the building. In order to calculate the worst case scenario, it is going to be calculated in the largest wall throughout its height (3,5m) The assumptions made are the following:

1. Building is fixed on plant view, it can only move up and down
2. Wind forces generate sinking on the opposite side of the blowing in order to make water support the wind forces.
3. Sinking will be calculated taking moments in the bottom of the foundation and considering the \sum moments equals 0
4. Sinking creates a lifting force with triangle distribution as the image shows which resultant is at $2/3$ of the length.

With all mentioned, the lifting reaction produced by wind is:

$$3,5 \cdot 1,4 \cdot (1,5 + 1,75) = F \cdot 2,5 \rightarrow F = 6,37 \text{KN} \quad (D.19)$$

Considering the force acts in a triangular distribution as the image above shows, it is proceed to calculate the values on the edges.

$$6,37 = \frac{13,3 \cdot x}{2} \rightarrow x = 0,96 \text{KN} \quad (D.20)$$

Considering an uniform sinking, the distance lowered by the wind is:

$$6,37 = 1 \cdot 9,8 \cdot 12,3 \cdot x \rightarrow x = 0,05 \text{m} \quad (D.21)$$

Since the sinking is null in the side where the wind is blowing and the sinking is not uniform, going back into a triangular distribution, the sinking is **Maximum 10cm**

Block calculations

Blocks need to support as a combination but also individually. In order to design the thickness of the concrete layer, there will be an assessment of individual forces with the following assumptions.

- Despite EPS has some compressive resistance, it will be neglected in the process, making the concrete cover the only structural element.
- Concrete used in the process is assumed to have a characteristic resistance of 25MPa.
- Weight is uniform spread through the surface.
- Unions would only need to support differential forces and flexing forces, however, those forces are neglected since structure is supporting the weight uniformly and it is out of the scope of this project.
- There are 88 blocks

Compressive forces As calculated before, the weight of the building is 2139 KN. Considering the assumptions made before, each block has to support 24,3 KN. For durability issues, block is assumed to have a 5cm thickness concrete layer. In following formulas, it will be checked whether or not is enough.

Concrete area in perpendicular to the forces

$$A = 4 \cdot 1,8 \cdot 0,05 \rightarrow A = 0,36m^2 \quad (D.22)$$

$$0,36m^2 \cdot 25000KN/m^2 = 9000KN \quad (D.23)$$

As seen, the cover can clearly support the the weight of the building without any problem.

Appendix E

Storage (Gironés)

As explained in the statement of requirements, the client wants to explore the possibilities within the foundation for storage. Since it is new topic, author will give an idea of what can be done in this project, but also recommends further research on the ideas explained.

As seen in the calculations (appendix D) the security coefficients used for the project give plenty of room for variations. If those coefficients are deleted, the total loads of the building are:

$$1140 + 3 \cdot 12,3 \cdot 12,8 = 1612,3KN \quad (E.1)$$

This is a 25 % less load than the calculated for the foundation. Also, the water resistance is reduced 20 % if we suppress those factors and recalculate how much spare weight the building can stand with the current foundation the results are:

$$F_b = 9,8 \cdot 12,3 \cdot 12,8 \cdot 1,7 \rightarrow F_b = 2622,9KN \quad (E.2)$$

This means that the building has a spare capacity of 1010,6 KN. Which is more than enough for storing facilities. Blocks are assumed to be 1,8x1,8x2m made out of EPS and covered by concrete. With this new exact calculation, it shows that blocks can be filled just half way of EPS hence leave room for storing. Depending on where the block is placed and what is going to held in it, thickness of the concrete needs to be re-calculated/strengthened.

water supplies

Rainwater can be stored withing the foundation for toilet flushing, if assuming that the house will have 88 blocks, each block can stand an average of 1148,4 liters of water, this is quite a large amount of water. Blocks with tank facilities can be placed in selected placed of the house such as the edge of the building to store rainwater and also, under the toilets to store the water that has to be flushed. Each block can be equipped with a tank of 1 m³ of water plus a small pump. In the space between foundation and upper structure there can be the pipes necessary to transport the water from one place to another. Author recommends further research regarding depuration of water and structural calculations.

Energy supplies

Same rule from the water supplies apply for the energy supply. Some blocks instead of being completely filled out with EPS can be filled half way. As calculated before, each block

can stand approximately 100Kg of weight. Blocks including batteries can be placed under kitchen or where structurally, make the building more stable. Since the author will not make an study of available batteries, just gives the idea and recommends further research.

Waste

Waste systems can also be placed within the foundation. Different blocks can handle with different kinds of waste (glass,paper,organic...) When they are full, they can be taken away by the waste company. Those blocks should be placed on the perimeter to make the task of emptying them easier. The task of un-mounting the block for emptying the waste might be difficult, but further research is advised.

Heating

Heating can also be installed within the foundation and use materials suitable for heating or cooling the house. Since it is out of the scope, author just gives the idea that it might be possible and recommends further research to see if it feasible.

Possible distribution

The figure below shows the distribution of blocks proposed by the author. As seen, depending of the storage use, they are placed under one place or another.

Conclusion

Since it is a topic never researched for a floating structure, author recommends to follow how can the construction of floating blocks be addressed more into a storage blocks.

Appendix F

Material Selection Criterion Upper Structure (Forés)

APPENDIX F: Material Selection Criteria

For the selection of materials will take into account the requirements imposed by the client and the design of a floating construction system, as a principle more imfluent should not forget that sustainable materials have to be protagonists in the design. For this, the environmental impact during all phases of the life cycle of the materials must be taken into account. The interference of these two concepts, life cycle and environmental impact, are those that will produce a criterion of choice of sustainable materials. So, these concepts will be developed in depth.

Life cycle

In a generic way, we will summarize the phases of the life cycle of products used in construction, offering, in a simple way, comments about the quality and the environmental cost during its manufacturing process, implementation, phase of use, demolition or dismantling and recovery / treatment of the waste.

Extraction and preparation of the raw material

The raw material used in the production of construction products comes from the surface of the earth, minerals, plant and animal species. For its extraction mechanical processes and cutting processes are carried out, this preparation alter landscapes and natural ecosystems. This processes and also transportation to the factory require energy and emit harmful substances into the environment, being this first phase one of the most impacting, which justifies the need of recycled materials.

Transformation

There are products available on the market that require slight transformation actions, basically consisting of cutting in format, such as natural stone products or wood, and others, which for their implementation and acquisition of properties that guarantee their quality, Need more complex processes, with a high consumption of energy, water, and chemical additives.

FUSION – BOILING

In transformation processes where the raw material needs to be boiled, high volumes of fuel are used and greenhouse gases, particles and substances harmful to human health are emitted into the atmosphere. Industries are trying to reduce the impacts of this phase of the process, through the use of renewable energy, alternative fuels, systems and filters to reduce emissions, tree planting, etc., but above all research is aimed at getting quality products to reduce cooking temperatures, and reusing products from the deconstruction of buildings and infrastructures.

MILL, MOULD, DEFINITION OF FORMATS

The products applied in paste form, are supplied in powder, as in the case of cement, lime or gypsum. In milling process of the raw material energy is used, pollutants are emitted and much heat and particles are generated. Large volumes of water are used for placement and curing on

site and also particles are emitted into the air and into the ground, washed away by water, causing alterations in the environment. Shapes of blocks, plates or profiles are made by cutting, extrusion, rolling, injection or casting, all mechanical processes, which require energy and water, therefore have a negative impact on the environment.

FINISHINGS-TREATMENTS

Manufactured products do not always meet the specific requirements of their use in a constructive element, so it is necessary to apply superficial treatments of protection, reinforcement or modification of properties, for example:

- Application of color, textures, etc.
- Protection against weather, corrosion or abrasion
- Protection against living organisms such as xylophages, molds, etc.
- Reinforcement against efforts

This last stage of the manufacturing process can reduce the negative impacts of previous phases, but it can also introduce impacts that the product itself does not have, making it particularly important to assess whether it is necessary to reinforce or treat the products we are going to be used in construction.

Transport

During the transportation and delivery phase of construction products, high pollution rates occur and high volumes of fuel are required, so that one of the most significant measures in any sustainable performance is to use local products, also positively influencing this Economy and local employment rates.

The impact of transport depends on several factors such as the load, speed, type of fuel used, means of transport and vehicle conditions.

Implementation

The implementation of the construction products requires different actions and auxiliary resources, based on the format of the product, and according to its application is in the form of paste or rigid or semi-rigid format.

The products that are applied in paste can arrive at work premixed or they can be manufactured in situ mixing the material supplied in powder with water and beating it to guarantee its homogeneity. Once mixed it is poured between formwork or applied on the face, so that after a setting phase (chemical reactions) solidifies to become an artificial stone. This is the case of Gypsum, Lime, Cement and Concrete.

In the case of rigid products, once staked and cut, they are placed with mortar, adhesive, anchors, screws, or by welding, using in some cases auxiliar structures.

During implementation is essential to reduce the amount of energy, water and emissions of particles, gases and harmful substances to the environment and avoid excessive noise.

Use and Maintenance

Maintenance is a set of operations to be carried out during the life of the building and is conceived as a preventive measure that will ensure the proper functioning of the building and guarantee its durability. These operations will be simple or complex depending on the types of products used, the construction systems, the intensity of use of the building and the environment to which it is exposed.

Those products and systems that require less maintenance during the life of the building will be more sustainable.

Demolition – Deconstruction

When the building can not guarantee compliance with the basic requirements demanded by the regulations, in terms of safety and service, it is demolished, total or partial. The demolition or de-construction of a building must ensure that intact products can be recovered and that sufficient material can be obtained for recycling and reuse, avoiding toxic substances.

Paste is difficult to separate from the walls, which is a disadvantage when reusing or recycling of ceramic bricks and blocks on which the mortar were applied.

Systems mechanically anchored to auxiliary structures or facings are more easily reusable in their entirety.

Reuse – Recycled

Products from the demolition of buildings and infrastructures can be reused in some cases or recycled in others, giving them the possibility of extending their useful life and mitigating in time the damage that was caused in the environment with their manufacture, commissioning and use.

To consume responsibly in construction we must use products with high percentages of recycled or reused.

Environmental impact

Once the life cycle of materials has been described, it is necessary to mention 5 points in which we can focus on the impact that they cause on health and the environment throughout their lives:

Energy consumption

Using materials with low energy consumption throughout its life cycle will be one of the best indicators of sustainability. Stone materials such as gravel or sand, and others such as wood, have the best energy performance, and plastics and metals are the most negative.

Consumption of natural resources

Large-scale consumption of certain materials may lead to their disappearance. It would be an interesting option to use materials that come from renewable and abundant resources, such as wood.

Impact on ecosystems

The use of materials whose resources do not come from sensitive ecosystems is another point to consider. Like bauxite that comes from tropical forests to make aluminum or tropical woods without guarantees of their origin.

Emissions generated

The ozone layer was reduced, among other reasons, by the emission of chlorofluorocarbons

For example, materials such as PVC, due to their polluting emissions of furans and dioxins, are being banned in more and more uses, such as the supply of water for human consumption.

Behavior as waste

At the end of their useful life, materials can cause serious environmental problems. The impact will be lower or higher according to its destination (recycling, incineration, direct reuse)

The subsequent use of wooden beams, old ceramic tiles or metallic material for scrap is very appreciable.

Guidelines for material selection

After analyzing the factors that influence the possible environmental impact of the materials throughout their useful life, we can determine a series of guidelines or principles to follow for the selection of sustainable materials. To consider a material as sustainable it must fulfill many of the following guidelines:

- They must be local materials or their place of production is as close as possible
- Its origin must be from an environmentally friendly place of production
- Must be natural or poorly elaborated
- that they come from renewable and abundant sources
- Must be durable
- Must not be polluting to the user or to the environment
- They must be recyclable, reusable or biodegradable and must be recycled
- Must be adjustable and adaptable to a particular model
- They must have a low economic cost and be valuable
- They must have a cultural value in their environment

In addition to these principles of sustainability, we have to apply other principles demanded by the design and by the customer, such as system buoyancy and modularity. The set of these criteria will allow us to choose the correct materials for the development of the superior structure of the project.

Appendix G

Analysis of Materials Upper Structure (Forés)

APPENDIX G: Analysis of sustainability of materials currently used in construction

Wood

Wood is one of the most ecological and sustainable materials, it is a natural and organic product and once used the wood can be recycled or used again in the form of biomass or manure, its environmental impact is very low.

Wood is considered one of the most sustainable materials as long as some requirements are met. Firstly, if it is treated it has to be with products of plant origin such as resins, otherwise these products are usually very dangerous for both the environment and man. These products may be non-degradable, possess harmful substances and even carcinogenic. Secondly we must ensure that its origin is a forest area with sustainable management, for it there are different certificates and stamps.

It is recommended to consume local wood, coming from a nearby factory so that its transport has the least possible environmental impact and at the same time to foment the local economy. If it is not possible, it is recommended to use wood from other countries that also have an appropriate management. It is advisable to avoid the use of wood from tropical countries that are overexploiting this resource and always ensure that they have some kind of certification that guarantees its correct extraction within a sustainable framework.

Metals

The most used metals in the construction are steel and aluminum, the greater environmental impact of the materials is carried out during their transformation process, since they require a high energy consumption, but at the same time they are materials 100% recyclable and in Their recycling process consume much less energy. The surface finishing and protection treatments applied to them also imply a great environmental impact, require protection treatments based on highly contaminated iron or galvanized paints, they also produce the emission of harmful substances, although there is some system based on natural products. On the other hand, it is also necessary to take into account that they are materials with very good mechanical qualities, resist the same load with less amount of material.

There are metals that should be avoided like zinc and lead as it is being exhausted, in addition the latter is a toxic material and its residues have to be controlled due to the risks they produce. With respect to aluminum its environmental impact is very high, it is a material that comes from bauxite, coming from nature, to obtain it is necessary to deforest large areas of forests. Extraction produces very high energy consumption and this means large emissions of CO₂ into the atmosphere. During its transport gases are also emitted to the atmosphere and during its processing to obtain the final product also,

since a very high melting point (1000 degrees centigrade) is needed, to reach this temperature a huge amount of energy is needed. It is one of the most polluting industrial processes but on the other hand it can be recycled as many times as desired.

The environmental impact of steel is not far from the impact of aluminum, since it is obtained from iron with a minimum carbon content, this iron is also extracted from nature and for its processing also requires a lot of energy.

Both steel and aluminum are 100% recyclable without reducing their quality. Their recycling cycle is practically unlimited but due to the large quantities that are used they make them one of the biggest consumers of energy.

Plastics

Plastic materials are widely used in construction because of their properties, such as: durability, strength, lightness, cost effectiveness and can be used in different parts of the work: pipes, insulation, windows, waterproofing, etc. Their environmental impact is very high, as they are obtained from the distillation of the oil. The extraction of oil has a great environmental impact, because it is a natural non-renewable resource, for its extraction and transformation requires a lot of energy, since it is necessary to build oil rigs and drilling wells as well as pipelines for transportation, it is a Very polluting and harmful to the environment.

The most widely used plastic materials are: PVC, PE and PP, PUR / PIR, XPS and EPS. The XPS and the EPS. They are used as thermal insulation, expansion joints, formwork blocks, etc. Its chemical composition is identical, the difference between them is that the extrudate (XPS) has a closed bubble structure and this gives it the ability to get wet without losing properties.

As a positive aspect to say that it is a 100% recyclable material. PP and PE are two plastic polymers that are used for pipes of different uses such as: potable water, waste water, sea water, sanitation network, irrigation, or to make waterproofing sheets. Apart from oil, natural gas is also used, which emits CO₂ into the atmosphere after combustion.

On the other hand PE is PVC is one of the most widely used plastic materials globally, due to its characteristics since it is a very resistant material, during its life cycle does not rust or corrode, therefore no It needs maintenance and its useful life is high. It is mainly used for pipes and carpentry. As far as its environmental impact is concerned, it is the plastic that best behaves with the environment, since 100% of the oil does not depend on its production, it also consists of sodium chloride (sea salt), 57% , This translates into a lower energy expenditure for its production. It is not biodegradable, like all other plastic products, but if it is recyclable, both wastes in the manufacture of profiles and carpentries as demolition wastes are 100% recycled.

Paints

The paints have a very varied composition, pigments, resins, solvents, etc., many of them are derived from petroleum. Products that can substitute the original hydrocarbons

for natural components have been developed, producing ecological and natural paints. An important aspect is that using natural paints does not have to increase our budget.

The purpose of the paintings is to provide a finish to the element on which it is applied, providing color and shine and sometimes with the aim of protecting from external agents, so in many cases are necessary and used in large areas what makes it necessary to use their ecological variants to minimize their impact on the environment.

Stones, conglomerates and artificial stones

In general, stone materials show a small impact. The most notorious impact occurs in the extraction stage, due to the variation that results in the terrain, the change of landscape and ecosystems. And especially because of its massive use, this type of material is the one that causes major problems in the collapse of landfills.

Generally, the use of local materials is suggested, since, due to their weight, transferring them implies a high energy consumption. The greatest benefit lies in its long duration, one of the maxims of sustainable materials.

Nowadays, thanks to the appearance of regulations regarding waste management, initiatives are emerging to market recycled aggregates for refilling and for the manufacture of mortars and concretes.

Concrete (coarse and fine aggregates and cement) has a rather large impact, but its specific high heat makes it very necessary to use passive strategies for the use of solar radiation (thermal inertia). Within the stone, it is worth mentioning the recycled concrete, reducing the emission of debris and being able to reuse it for a new construction. But its use is not widespread.

The massive use of conventional concrete in foundation and structure advises its optimization. That is, an exhaustive knowledge of the resilient capacity of the terrain will allow us to dimension the foundations so that we avoid an excess in the use of material. Concrete is created from the combination of gravel and sand, cement and water. There are several solutions to minimize the environmental impact of concrete, such as use less concrete and reinforcement, extend the life span as much as possible, to obtain a greater amortization, use of cements obtained from processes that consume less Energy in its manufacturing process or having in its composition raw materials that produce less, use of category A1 cements due to their low slag content, incorporation of recycled aggregates from construction and demolition waste, use of recycled water, use of Steels from recycled waste.

In the European Union there is a voluntary regulation called EMAS that recognizes those organizations that have implemented an Environmental Management System (EMS). If we follow all these principles we could consider concrete as sustainable, but it is very complicated. Another option is to use bioconcrete, which has the same components as traditional concrete except that the binder used is lime, is lightened by husks or sawdust and part of the gravel is replaced by light aggregates such as "Arlita" or "perlita". It is a lighter concrete and has insulating qualities, so it is less harmful to the environment. It is not very common and is not usually used.

In relation to cement it must be said that it consumes a lot of energy during its life cycle, especially in its production phase, and can be dangerous to health. For this reason precautions must be taken in handling to prevent both inhalation of dust and burns or irritation that may occur on contact with the skin. With regard to its procurement process it has a very negative environmental impact, requires a lot of energy for its manufacture, the raw materials have to be extracted from nature and transported to the processing plants, this action is already producing an energy expenditure, since the Amounts of material are high. In addition, other negative impacts of cement occur in the following processes, eg handling and storage (particles), grinding (particle), furnace cooling and slag (particulates, monoxide and carbon dioxide, sulfur oxides, nitrogen) And water contains high PH, suspended solids and dissolved solids such as potassium and sulfate. Cement production causes approximately 7% of carbon dioxide emissions in the atmosphere. So we can say that it is not a sustainable material because of its great high negative environmental impact and the large amount of energy needed for its production.

Another material very used in the construction is the natural gypsum. It is a natural and ecological material, low environmental cost and found abundantly in nature, recyclable and with many applications in construction. It has good insulating properties and protection against fire. It comes from the dehydration of gypsum stone that is crushed and scorched transformed into hemihydrate gypsum, it is reduced to dust, and which is kneaded in work with water. It forges and hardens in a short time. It has a low energy consumption throughout its life cycle. However, towards the end of its life cycle it contaminates other stone materials due to its water absorption capacity. So, if it is sustainable since it is a natural material and can be recycled and reused, its environmental impact is only visual and transport.

As with plaster, lime is a recyclable material and respectful of the environment. It has good qualities in terms of plasticity and hardness, and also benefits the breathability of the facings. It has various applications and serves as a coating on mortar and stucco. Baked clay It has different applications, it is used for the manufacture of bricks, tiles, blocks, slabs, etc. These materials must be cooked to achieve greater stone consistency. Special care must be taken with this process, because the energy needed to carry it out is not very high although its massive use causes it to increase substantially. The cooking must be carried out at a temperature below 950 ° to preserve the characteristics offered by this material, such as hygroscopicity, good thermal inertia or insulation. At the end of its life cycle it can be recycled and used in different types of pavements. Lime has been a material widely used in construction throughout history as a binder.

As for the environmental impact of lime, the negative aspect is that it is extracted from nature and this produces a visual and environmental impact since it causes a modification of the landscape and the ecosystem, as it happens with the natural stone or plaster. During the firing of the lime CO₂ is emitted, but the installations are considerably smaller than those of cement manufacture, therefore these emissions are smaller and less significant, just as the cooking temperature is also much lower. During the extinguishing of the lime there is also the expulsion of water vapour, since it is an exothermic reaction, but this water vapor is harmless.

So it is sustainable, it is an ecological conglomerate and its environmental impact is only visual. It is considered one of the most environmentally friendly construction materials, since the amount of CO₂ emitted in the manufacturing process is absorbed in the carbonation phase during commissioning, it is completely recyclable.

It is also necessary to analyze the clay, this is obtained from the nature, in mines by means of excavation processes, therefore the environmental impact during its extraction is translated in the modifications that occur in the landscape and ecosystem. At the end of its life cycle it can be recycled and reused. So it is considered a sustainable material, from it are obtained artificial, ceramic stones.

Within the ceramic materials used for construction there is a great variety, but all have a common origin, clay. Ceramic materials are made from high fusion inorganic (non-carbon) products, that is to say clay and after passing a process of extraction, preparation of the paste, mixing and kneading, molding, drying and firing the product is obtained final. There are different types of ceramic materials that we use in construction such as: bricks, tiles, tiles, stoneware, porcelain, etc.

The environmental impact of these products focuses mainly on the production stage, the drying and cooking processes. In the cooking ovens and during their production gases of SO₂, CO₂, NO_x, CO, F and Cl are emitted, that depend so much of the raw material as of the fuel used. The wastes generated during the manufacturing process are reused as raw materials in the manufacturing process itself.

Glass

Glass is a compound of silicates, mainly from quartz and sand, which melt at an elevated temperature. It is a sustainable material since it can be recycled to 100% by means of the reflow process, the manufacture of glass using recycled glass saves 68% of energy and 50% of the water required in the manufacturing process. In addition there is a 20% decrease in air pollution and 50% water pollution, in addition the recycled glass has the same qualities as the original. It has an almost infinite useful life, this makes its maintenance to be minimum. It is a raw material easy to extract and abundant and also its extraction process is not harmful to the environment. The biggest drawback is the impact produced during the melting process. Glass is a material that is obtained from high-temperature, 1500 degrees Celsius, SiO₂ silicates (quartz and sand) along with borates and phosphates. The environmental impact of glass lies mainly during the melting process as the furnaces used to melt the raw material consume a lot of energy, and the consumption of this energy translates into atmospheric emissions of both gases and particles, between these emissions (2tonels per 1 ton of glass produced), the emission of particles can contain heavy metals (arsenic, lead, cadmium, etc.), depending on the raw materials used.

So even if there are harmful emissions to the atmosphere, glass is 100% recyclable material, and if its percentage of recycling is also 100%, it could be one of the materials with the lowest environmental impact.

Analysis of the materials according to the function they can perform

Structure

In this section we will discuss the possible materials that may be part of the elements that make up the skeleton of our building. For construction of pillars and beams, it is possible to use different types of materials such as wood, steel and concrete, of more general use and others less common such as adobe, ceramic or stone elements, which can work as a support element, even Bamboo, material widely used in some Asian countries.

For the selection of the appropriate material, the criterion developed in previous points will be applied.

Starting with steel and concrete, the most widely used materials, it should be said that, although these materials allow to develop the project in a modular way, they can not be considered as materials suitable for sustainable construction due to their great environmental impact. In their extraction and production, they are also very heavy materials which hinders the buoyancy of the project as well as constructive solutions made with adobe, ceramic or stone elements. With regard to bamboo it can be said that it is a material that accomplishes the requirements of the project, but its availability is not very high, as the constructive solution should be as global as possible wood will be used in the project for sustain the structure.

Wood, as we have said before, always that it comes from a sustainable production and has a seal that certifies it will be considered a sustainable material. It also has other advantages because it is a material of easy handling thanks to its lightness. This also affects its ease in transportation, loading and assembly. In its production it is possible to elaborate pieces of great lengths and also it gives flexibility to the functional and creative organization. It produces greater economy, since it allows short times of work. At the end of the useful life of the construction, it is simple to demolish and use the resulting material as a fuel in the event of non-reuse. Selecting the right variety, cutting it, drying it and using it correctly has an unlimited life and minimal maintenance. The secret is selecting the right wood and putting it right.

Against it, we must say that It is attackable by fire, but still has a good behaviour before him, the greater thickness of the pillar, greater insulation it is an organic material, it is attackable by fungi, insects (worm, termite, moth) and chemical agents. If it is in the outside, it is susceptible to rot and premature aging. But for all this, there are ecological treatments that protect the wood from each type of attack.

Floors

From an environmental point of view, the most suitable materials for interior floors are the wood, fulfilling the criteria explained in previous points, natural textiles, cork and linoleum, with a control of adhesives and finishing treatments.

There are also pavements composed of stone materials such as stoneware, terrazzo and ceramics. But these materials are very heavy and in a floating system, as in this case, light materials must be imposed. In addition to that these materials offer a very low degree of modularity and adaptability.

With regard to wood, it is again the ideal material, in addition to all the qualities that have been named above, it is necessary to underline that there are several systems very suitable for sustainable construction, such as OSB boards, these are a type of Particle board oriented and cross on a high performance board. The surface is formed with long thin slabs of wood oriented in the direction of the length of the board. The sheets of the inner layer of the board are placed randomly or crosswise. This method ensures dimensional stability and very high mechanical performance. During the production process, this type of board allows an efficient use of the wood logs using 100% against 55% of the agglomerated board, another type of board of very widespread use, which translates into a responsible use of the raw Materials. OSB boards are excellent building materials for many reasons. Among them we can highlight its mechanical strength, its rigidity, insulation, ability to absorb different stresses, usable in both dry and wet environments, easy to handle and easy to put into operation, and has no knots or weaknesses. Sandwich panels also have to be named, which because of the nature of the materials used, make it a 100% natural product. It consists of two sides of lining, based on derivatives of the wood sustainably managed, and an insulating core based on natural cork, make it the most appropriate solution for pavements as well as for other constructive elements. It has become the ideal solution for a modern and sustainable construction, since it acts at the same time of isolation and structure. It is a very safe and long-lasting product.

In general terms, wood does not seem to be the best element capable of absorbing sound, intimately linked to the concept of mass and specific weight. But its structure of fibers and pores behaves just like a real sponge for the sound of a wide frequency. In addition to this, it must be said that these systems save on structure, due to their lower weight, and are economical methods, since they save on labor for their ease and fast process of assembly on site.

Building envelope

The objective of the building envelope is to cover the heating and cooling needs with the least energy expenditure, regardless of the outside temperature, for which the building is designed in order to gain all possible solar heat (in winter) and avoid The heat gains (in summer).

It is possible to achieve this by insulation, dimensions, orientation and adequate openings and use of the resources and energy of the environment.

A well-insulated house loses half the heat, and if it is well oriented and with convenient openings it gains three times more energy than a conventional house, so adding both concepts, it is possible to spend six times less energy than in a conventional house.

The envelope of the building includes facades and roof, both are formed by a structural support and a series of contiguous layers in contact, which seek to avoid the passage of rain, in the case of the roof especially, and try to have the least transfer of Possible energy. These layers are, outer and inner coating, waterproofing and insulation.

The good insulation of the facades and the roof will undoubtedly affect the energy consumption, both cooling and heating. For the execution of facades and roof, the appropriate materials for the exterior and interior coating, insulation and waterproofing will be studied separately, giving different solutions in this section.

Exterior and interior coatings

With respect to façades nowadays much of the structural elements are of reinforced concrete, such as beams, pillars and forgings, are particularly abused, especially prestressed reinforced concrete joists, which contain steel with a permanent tension-torsion, when in many cases Can be replaced by self-supporting walls, trusses, arches and vaults. In conventional construction, all exterior building enclosures are usually the same regardless of orientation. Bioconstruction tries to provide different solutions for each enclosure, adapted to its situation, since the orientations create different needs in each case. Thus, for example, the walls to the north must be very isolated, while in the south, what interests us is the accumulation of heat. In buildings of common use it is convenient to place the insulation on the outer sheet of the enclosure, whereas in buildings of specific use it is better to adopt insulation solutions inside the chamber.

- Walls of a sheet

The one-sheet enclosures are optimal collectors, accumulators and transmitters of the solar thermal energy to the interior of the enclosure, mainly if they are exposed to the sun in winter. Oriented to the south are suitable for use in greenhouses, trombe-walls and radiant walls. Higrotérmicamente the wall of a layer works of staggered form, as far as losses and profits is concerned.

SAND OR ADOBE

Sand is one of the oldest materials and the most used by man to build. Crude sand is used to make blocks, adobes, walls, walls and as joints for masonry, with no other treatment than drying in the sun.

The adobe is an uncooked mud brick dried in the sun. It is composed of clay and sand, to which additives (straw, lime, etc.) are added according to the type of sand and the climate of the place, thus guaranteeing a greater mechanical resistance of the blocks.

Mudwall is a technique that consists of building walls with compacted earth inside a mold or form of wood. For issues related to sustainability, comfort and energy efficiency of buildings, the mudwall began to gain ground and to prove advantageous in relation to the current construction (concrete and brick). The sand is easily accessible. It comes generally from the excavations for the execution of foundations, swimming pools or warehouses, reason why its environmental impact is almost null. The constructions in mudwall have an optimum level of comfort due to the high inertia resulting from the thickness of the walls and the characteristics of the sand. The sand has the ability to regulate the indoor climate, keeping the temperature and relative humidity within the comfort level. Mudwalls make it difficult for heat to enter in summer: the daily heat wave transmitted to the wall is attenuating and shifting in time, reaching the interior only when the outside temperature is lower. In winter, these walls make it difficult to escape from the heat due to the high thermal inertia of the earth.

CERAMIC

The ceramic walls of one sheet are optimum sensors, accumulators and transmitters of solar thermal energy to the interior of the enclosure, mainly if they are exposed to the sun in winter. Oriented to the south are suitable for use in greenhouses, trombe-walls and radiant walls. In walls with isolated air chamber this effect is interrupted.

Termoclay: It is a ceramic material that is presented in block form of lightened clay. The clay mixture contains granular components inside that are gassed during cooking, providing uniform porosity throughout the piece. Precisely this cell geometry is that improves its mechanical behaviour and its acoustic and thermal insulation; In turn, allows it to be used as a single-sheet wall, without resorting to multilayer solutions. It is used to give thermal mass as a structure and / or enclosure.

Its technical characteristics are:

It performs well as thermal and acoustic insulation, thanks to the porosity of the block. The lack of vertical joints, its large format, the horizontal joint with rupture of thermal bridge and the use of insulating mortar improves this situation. The one-sheet wall of termoclay reaches adequate values of thermal insulation, lag, damping and thermal inertia. Regarding to mechanical resistance, the union with the mortar is perfect due to the good adhesion with the ceramics and groove. Fire resistance is high for any thickness. It behaves well against moisture due to the interruption of the capillaries by the cells; however, the impermeability depends on the coating, which must be carefully executed. Condensation usually occurs.

Biobloc: This block is made of 100% natural clay and has an exclusive design that allows a high compressive strength, while incorporating a chamber inside to increase thermal inertia and thermal and acoustic insulation of the building element. It is a material of easy placement, with a great durability and stability to the fire and the humidity. If the inner chamber is filled with natural cork granulate, an ideal solution of load walls with insulation on a single sheet is achieved, allowing the inner face to serve as a thermal accumulator, reducing the thermal variations inside the house and increasing the comfort. In addition to the above, it also fulfils the following functions:

Structural element for several floors, high acoustic damping, high thermal inertia, perfect fire barrier, quick construction, allows operators to work with greater comfort and speed, saving execution time and avoiding double partitions.

It is ecological, the use of these materials contributes to the protection of the environment, since they are natural products that can be recycled and later reused without any environmental impact. It is also an economical solution, it allows a considerable reduction of labour and waste materials, allowing a significant energy saving throughout the life of the building. Also being 100% natural materials, a total transpiration is achieved while not producing any kind of allergy or toxic fumes as can occur with synthetic materials.

STONE

Building with stone has many advantages, such as the durability and simplicity of maintenance of stone walls, high thermal inertia whenever walls equal or exceed 50 cm, they are good protection against summer heat and sound. In general the processes of processing or transformation that are applied to the stone materials are usually little energy consumers. In

contrast, the disadvantages of this construction are the slow execution, the risk of deterioration of the factory due to humidity, and the overexploitation and unsustainability of many of the quarries of origin. The stone can be used as a structural element, forming load-bearing walls, or as an outer sheet or sealed in non-loadable enclosures. There are different equipment or systems of placement of the stone: ashlar, masonry, masonry, mixed systems, etc. The stone resists well to compression but less to traction and, therefore, is ideal for walls more than for wide horizontal planes and void openings. To solve this problem the old builders used bows and domes to distribute the load.

ALTERNATIVE BLOCKS

Arliblock: Light block of porous structure of expanded clay and cement, with its disadvantages. With acoustic insulation properties and fire resistance, in addition to thermal characteristics, due to its low transmission coefficient and its high thermal inertia, from which environmental benefits are obtained. The incorporation of current cements, make this block that is not recommended in bioconstruction, if incorporated in this project is due to the possibility of doing it with ecological and low pollution cements and / or lime mortars. The solid Arliblock is used to construct load walls of up to 3 floors, insulating and resistant. Among its many properties: thermal inertia, thanks to the thermal insulation provided by the countless air bubbles of expanded clay, which contributes to energy saving. Excellent acoustic performance due to the internal structure of air filled microcells and the resistant surface crust. This material has highly flame retardant properties that do not emit toxic gases in contact with a flame. Hygiene and environmental health, the walls constructed with these blocks are permeable allowing the transfer of the inner fog to the outside, do not produce superficial condensations and do not contain fibrous organic materials.

Other qualities are mechanical resistance and stability, quick and simple placement due to its size, shape and light weight and no specialized labour is required for installation.

Applications: according to the selected format, they can be used as enclosure in dwellings or in industrial buildings, for the construction of load walls or for dividing walls.

Climablock: Formwork block of wood shavings conglomerated with cement. The base material that forms it, the wood shavings, is dehumidified by calcium silicate in order to achieve resistance to mold and prevent rot and insect or rodent attack. One of the characteristics of this material is the migration of water vapour as a result of its alveolar structure and allows the active respiration of the building, quickly evacuating indoor moisture to the outside, improving the quality of the air that is breathed in the spaces Created with this type of block. Applications: the system is designed for lifting exterior and interior walls. It is very suitable in places with noise problems.

Steko Block: It is a block of wood for fast construction that simply fits one with another, is light and of easy handling. It can be filled with cellulose.

Ytong: These are blocks of cellular concrete, mineral material cured in an autoclave that is obtained from silica sand, cement, lime and water, the latter being responsible for the typical microalveolar structure that is generated during the manufacturing process. This type of block does not give off odours or harmful dust, which protects the health of the operators during the

execution and of the end users of the house or building. The hygrothermal characteristics of the material provide a very high climatic comfort that translates directly into a sense of well-being and guarantee sanitation in the habitable environments. In addition, the high thermal insulation of the Ytong considerably reduces the energy consumption associated with air conditioning. The elements of this system of construction allow reducing to the maximum the thermal bridges, being a solid and homogeneous material with isotropic properties. It is non-combustible (fire reaction class A1), due to its mineral nature and strong thermal resistance, Ytong cellular concrete is particularly well adapted to all fire protection applications. It has a high compressive strength that varies according to the density of the material, for this reason the load walls are characterized by their homogeneity and being able to withstand high loads, allowing the construction of multi-storey structures. The porosity of the cellular concrete makes this a material with high absorption of acoustic energy, as long as not apply coatings that close the pore. It is a recyclable material.

Cannabric: Solid block formed by vegetal fibres of hemp, natural hydraulic lime and minerals mixed with water. Its main raw material, hemp, makes it a material with great insulating capacity against the cold. Its heavy components, minerals, give it the strength and thermal mass needed to protect it from heat. The mechanical strength of the block, the petrification of hemp fibres in relation to lime and minerals, is another important factor in the progressive increase of resistance in the material. It allows the transpiration and the diffusion to the water vapour between the interior and the exterior of the building, which makes it a material capable of compensating and balancing the environmental humidity avoiding the moist and cold spaces. It does not cause condensation either on the surface or inside the wall. The lime also grants hemp fibre, the necessary defence against the attack of fungi and parasites. Applications: the block allows its use in the execution of structural walls for any type of building. It can also be used in the formation of interior partitions.

· **Walls of several sheets**

CERAMICS

Conventional ceramic bricks single and double, hollow and solid, or blocks previously seen will be used. Their placement is suitable for both the outer and inner or both, and should always be attached through staggered stainless steel hooks.

STONE

With the same characteristics that the enclosures of a leaf both placed in dry as received with mortar of lime, unlike its thickness. They will have a smaller thickness since they will be united, through keys, to the inner sheet that can be of ceramics, facing of fibre-plaster or panels of fibre of wood.

WOOD

They are usually composed of an auxiliary structure in the form of wooden frames and covered with fibre-plaster panels, fibres and wood chips, among others. Some acoustic and thermal insulation material is provided inside the chamber. Its main advantages are the cleanness of execution and the lightness. It is an ideal solution for wood slabs that have contraction and

expansion movements, where the monolithic solutions would crack if they will not be executed correctly.

Shavingboard, Heracklit: They are thermo-acoustic plates of wood chips agglomerated with magnesite and are mineralized, annulling the processes of biological deterioration and increasing their resistance to fire. Through a pressing process, the chips are bonded together to form a stable, strong, compact and durable structure. It is resistant to pressure and bending. Open to broadcast. It is heat accumulator and absorbent to the noise. Neutral behavior in front of all building materials and paints of simple elaboration. It is free from harmful substances.

Wood Fibre Panel: Composed of wood fibres mixed with water to create a mass that will subsequently dry up acquiring the consistency of the future panel. It is respectful of the environment, since the wood as raw material comes from sustainable factories and the pieces of wood come from the wastes of sawmills. It is recyclable, as long as other impurities do not contaminate it, they can be re-submitted to the processing process. The panels are open to the diffusion of steam and regulate the humidity of the air absorbing or expelling, depending on the ambient conditions of the room, up to 20% of its weight in humidity without losing insulation capacity, the combination of both characteristics influences positively in the environmental conditions of the room. Thanks to their low thermal conductivity, they have excellent qualities for the protection of the cold, which is to say for the insulation of this, they avoid the loss of heat and that the cold penetrates in the interior. Due to its high porosity, high weight and good mechanical rigidity, it is possible to meet the requirements as acoustic insulation.

Fira-gypsum plasters: It is a homogeneous mixture of gypsum plaster and cellulosic fibre from recycled paper, which is mixed with water for the setting of gypsum, without adding glues or other binders, besides a slight surface impregnation. It can be painted, wallpapered or tiled immediately after its commissioning. Due to the homogeneity of its structure, the panel has the following characteristics: It can be used in wet areas and coated with ceramic tiles, without problems. The flexo-tensile strength is very high and constant. The surface hardness even improves to that of the traditional plasters. It has a great facility to absorb the humidity of the air, and also to yield it when the environmental conditions change. It has high capacity of acoustic and thermal insulation. Panel for fire-resistant constructions, A2- s1- d0 classification has been achieved. It is a product that transpires, permeable. Due to the absence of glues and binders it does not give off odours and toxic fumes, even in the presence of fire. It is ecological, for its raw materials and for its manufacturing process, during it the waste materials are recovered and re-introduced into the production line.

Laminated Wood Board: Board composed of wood sheets glued and treated under high moulding pressure, to become large format solid wood boards. The stiffness, resistance increase considerably, and the static balance is achieved with remarkable simplicity. The laminated wood opens up completely new possibilities with respect to the transmission of loads. The loads can not only be transmitted in one direction but can be transmitted in any direction by giving the boards a stability that the laminated beams do not have. The semi-isotropy makes the wooden panels laminated very effective elements for the design of laminar structures. Depending on the aesthetic requirements, the panels are manufactured in industrial qualities (for coating) and views, which allow us to use them as a closing element both inside and outside. Enclosures that are completely permeable to vapour diffusion can be achieved, without the risk of interior condensation. It balances the ambient humidity, absorbing it or releasing it, bringing its value closer to levels suitable for human well-being. It is relatively easy to achieve very high structure

fire resistance (from 30 minutes to more than 4 hours). In principle, all the acoustic requirements for a multi-storey building can be satisfied. It is recyclable and incinerated without releasing hazardous waste. Counter-laminated wood panels allow for dramatically short assembly times.

ALTERNATIVE BLOCKS

Already cited above used in either of the two sheets or both.

With regard to roofs; flat, inverted, inclined, garden or ecological roofs shall be taken into account.

Firstly we will talk about the inclined roofs in which we have in the market different types of finishes, being the use of the majority tile either in its ceramic or prefabricated version of concrete. Within this field the most sustainable solution is to equip our roof with the use of tiles recovered from another construction. As far as possible, we must avoid the use of glazed tiles or stoneware, as it is necessary to use more energy than the simple tile. If we have a slope on our overcrowding, opting for the slate is also a good solution, as is the case for high mountain dwellings. The only important consideration is to ensure that it has been adequately controlled in terms of extraction processes.

We must avoid the use of plastic or metallic materials, both in terms of the composition of these materials and their energy cost and their poor behaviour being an important source of thermal transmission.

In the section of flat roofs the best solution is considered to be the execution of an environmentally-friendly roof. For non-transitable flat roofs we recommend finishing with recycled aggregate or mineral gravel as the best option. If our deck is passable we prefer preferential ceramic tiles, if possible of rustic type made with natural products, clay tiles etc. Only in the latter case will we choose finishes with asphalt sheets seen as self-protected.

The solutions mentioned above are usually very heavy solutions, the roof tiles or garden roofs are very heavy construction systems for a floating system. Therefore we will analyze in the following point the possible solutions of waterproofing materials to find some more effective solution.

Waterproofing and insulation

In relation to waterproofing and insulation products we can say without a doubt that they are key materials in any construction since they fulfil the function of isolating the building from the climatic conditions of its surroundings.

We will speak in a close-up of the waterproofing materials which we will basically place on decks. They are also often used in plant structure starts to avoid moisture by capillarity. For roofs, we have to differentiate between sloped and flat roofs. Whenever we have a sloping roof with enough slope we can obviate the need to install some type of waterproofing sheet.

The materials most used as waterproofing in flat roofs and walls are those that present a greater environmental impact, the PVC sheets and, to a lesser extent, the classic asphalt fabric. That is why according to environmental criteria we must replace the synthetic materials with others that are based on rubber and synthetic polymers, which also confer greater elasticity and durability. As for flat roofs the most interesting option would be the rubber sheets (EPDM) and those of polypropylene as well as sheets of modified bitumen of the type SBS, APP. We will try to avoid the use of asphalt fabrics and PVC sheet whose recycling is very complicated. With respect to rubber sheets (EPDM) we can find products such as Firestone's UltraPly TPO waterproofing system, this flexible thermoplastic polyolefin membrane (FPO) for covers is made with the incorporation of an ethyl-propylene rubber to A polypropylene matrix and is assembled by inserting a polyester mesh. The membrane combines in one sheet the strength of the rubber with the heat-sealing ability of a thermoplastic, with excellent characteristics for commissioning. It is also a roof waterproofing membrane that reflects the heat and therefore is energy efficient. Its light-colored surface reflects the sunlight before absorbing it and converts it to heat energy, which results in a reduction in the cooling costs of the building in warm, sunny climates. The membrane formula, free of chlorine, halogen and plasticizers, as well as welded joints by hot air, contributes to the ecological characteristics of the system. Firestone's UltraPly TPO membrane contains no plasticizers or flame retardant halogen substances, providing excellent resistance to ultraviolet and ozone. The membrane also has a high resistance to the appearance of fungi and the most common chemical substances in roofs, all this attributes give great durability and also allow be easily recycled. In addition, Firestone's UltraPly TPO membrane manufacturing facilities have been awarded the ISO 14001 certificate, proof of the company's commitment to environmental protection.

As for insulating materials, we can also say that natural to synthetic materials are preferable. Nowadays it is very common the use of materials from the petroleum, that produce the deterioration of the ozone layer and the global warming, having a great impact on the environment, on these materials we have spoken previously so, at this point we are going To speak of insulators that are indeed sustainable and environmentally friendly, such as glass fibre or rock, cell glass, and other more environmentally friendly, since they come from renewable sources such as cellulose, Cork or hemp.

CORK

It is a renewable natural resource extracted from the cork bark. The agglomerates of cork are made with cork granulate, agglutinated with each other by the natural resin of the cork, by means of cooking process. They can be applied in slabs or crushed, the latter as filler in enclosures or in decks mixed with mortar and applied as a compression layer in a certain thickness. It has unbeatable qualities. Unlimited durability, insect-free and highly resistant to chemicals. It is the lighter organic insulation (0.85 kg / m²), has a very high vapour diffusion (between 5 and 10 U) and one of the lowest moisture absorption percentages (<0'3%). Besides being very good thermal and acoustic insulation, it has very good mechanical resistance (compression, dilation, flexing). Recyclable and without any addition of glue.

HEMP

Hemp (cannabis) is a plant used throughout the world for thousands of years. Its use is very varied, from food, cosmetics, textiles, cardboard, building materials, for industry (brake pads and fuel for cars), industrial oils and, especially, as a renewable energy source. Regarding its

production, it has a fast growth, does not need much water, it avoids the erosion of the sand and even improves its quality (in wheat crops increases its production in 500kg / Ha), being refractory to the pests it is not necessary to use of pesticides. From the fibres contained in the stem of the hemp, together, an excellent thermal insulation is manufactured used in construction. It can be used as thermal insulation in walls, ceilings, floors, sloped roofs and support wooden beams in walls (sleeper). Inconvenience: do not place in damp areas, only on walls that are accompanied by waterproof, breathable sheets. Besides being an excellent thermal insulation, it has a good hygrometric adjustment without loss of insulation qualities, it is perfectly adapted to the irregularities of the frame to guarantee quality insulation, it is not irritating, recyclable, and it has good mechanical resistance, stable in Time and natural resistance to insects and rodents. Its application in construction as blankets, flakes, felt or blocks of pressed earth.

LINEN

Flax fibres not used in the textile industry. Its transformation is through the wetting with the borax salts, carding and layer superposition obtaining wadding, spraying with sodium silicate, drying, cutting, wrapping and packaging of different formats. Properties that it possesses: excellent thermal and acoustic insulation, good hygrometric regulation capacity without loss of the insulating qualities, it adapts perfectly to the irregularities of the frame to guarantee a quality insulation, it is not irritating, recyclable, it has good mechanical resistance and stable in time. It is sold in blanket, roll or panel. They are fixed with some staple plastic parts.

WOOD FIBER BOARD

It is excellent because it is made from the remains of the forest industry, the water used in mixture is recovered in the pressing, agglomerated by the lignin itself of the wood without additives. They are insulation, ecological and economic. The porous structure of its fibres favours the diffusion of vapour and boards can "breathe", are able to absorb sound waves and greatly improve the impact noise damping. They can absorb large amounts of water keeping their character of dry material. Not irritant, not toxic, recyclable or usable as fuel. In order to show their optimum insulation capacity it is advisable to mount them in the dry state. There are about twelve models for different applications: filling of cameras, waterproof under tile, floating floors, with track included for platform, for false ceilings and as support of plasters.

COTTON BLANKETS

They come from waste from the textile industry or cotton fields and by processes of transformation consisting of wetting and pressing of the fibres. There are several companies that manufacture thermal and acoustic insulation to be used in the construction sector. Applications: As acoustic and thermal insulation. Depending on the final finish of the product, it is used in insulation that requires little thickness, in enclosures or machinery where a great acoustic absorption is required, in constructions that require a great fire resistance, as absorber of noise impact in soils and ceilings, or for avoids thermal losses in water tanks or pipes. They have the lowest coefficient of thermal conductivity: 0'029 Kcal / h m. It is a recyclable and biodegradable material. It contains no toxic substance.

CELLULOSE

The cellulose, carbohydrate isomer of starch, is the fundamental component of the skeleton of vegetables. Cotton, for example, contains 99% cellulose, and wood between 40 and 50%. The pure cellulose is white and with great mechanical resistance; cotton fibres, for example, can withstand tensions up to 80 kg / mm². Cellulose is obtained from straw or wood. In order to separate the cellulose from the wood fibres the trunks are disintegrated and the fragments are cooked with calcium bisulphite. The resulting mass is washed and passed to a defibrillator cell, where the components are separated. The dough is diluted with water, it is passed through a grinder. Subsequently, it is sieved, thickened and dried, acquiring the shape of a carton. It is insoluble in most ordinary solvents. The main importance of cellulose is its quality of raw material for the manufacture of paper, explosives, plastics and synthetic fabrics.

The cellulose used in construction as insulation, is obtained from the paper of newspapers that are not sold, 100% cellulose treated with boric salt therefore 100% vegetable. It has different ways of application: blowing by special machine or in blanket. It can be placed in roofs, forged and in chambers between partitions. Its main characteristics include hygroscopic qualities, resistance to decomposition, the possibility of recycling or reuse, its high mechanical resistance and insolubility in most ordinary solvents. Installed in large areas is the most economical of organic insulation. Being based on a vegetable raw material is biodegradable, compostable and innocuous. Fire classification M3, like that of all vegetables, limits its use in houses with more than two floors.

EXPANDED CLAY

Geologically the clay is a sedimentary rock impermeable of dusty structure. The resistance that gives the process of drying and cooking after mixing with water have made this a material used in all times for the manufacture of ceramic pieces: Tiles, bricks, tableware, crockery, etc.. On vegetable roofs can be used as a substitute for drainage gravel, mixed at 50% with the substrate, reducing the weight of the cover by half, favouring the growth of plants and protecting them from frost or excessive evaporation. It is insulation with high thermal conductivity (0.073Kcal/hm°C) and with a high percentage of humidity absorption (20%). Its classification to fire is M0. It is a lightweight material, reducing by 70% the weight compared to other aggregates and maintaining a very strong structure. It is highly resistant to compression and other mechanical stresses due to its clinkerized structure and the hard and resistant crust of its surface. It does not emit gases or bad odours, it does not affect the chemical substances, it resists frost and abrupt changes of temperature. It does not deteriorate or suffer any changes over time.

Applications: as an insulation in the filling of chambers, floors, consolidation of slabs, roofs, light fillings, prefabricated (blocks, vaults, roofing plates, etc.), gardening, etc..

MINERAL WOOLS

Materials such as mineral wool already have their place in construction, are used as insulation because it has good acoustic and thermal characteristics and a favourable protection against fire. They come from mineral fibres such as silica sand and basaltic rock. They can be of two types: rock wool and glass wool. They are little permeable to solar radiation so care must be taken when using them.

CELLULAR GLASS

Hard and generally translucent or transparent material resulting from the solidification of the molten mixture of siliceous sands, lime and sodium or potassium carbonate, which have a vitrifying, fluxing and stabilizing function respectively. It is a poorly conductive material of heat and electricity. It resists ordinary chemical agents and is attacked by hydrofluoric acid. It has the best result in 0% moisture absorption and its classification to the M0 fire makes it non-combustible.

Applications: as thermal insulation in walls, ceilings, floors, etc. Fire insulation. False ceilings in places of high relative humidity or corrosive environment and false ceilings in places of necessary asepsis.

PERLITE AND VERMICULITE

Mineral used as acoustic and thermal insulation in construction. Perlite is a volcanic rock composed of 65 to 75% silicon dioxide, 10 to 20% aluminium oxide, 2 to 5% water, and small amounts of soda, potash and lime. It is characterized by its foliated structure and its presentation in yellowish crystalline plates that can measure up to and more than 228'6mm long and 152'4 thick. This brilliant slide presentation converts its surface into a large reflector of solar radiation, which disperses the heat and increases the thermal insulation capacity in the material. It will be applied as chamber fillings, prefabricated insulating and light, insulating plasters. Fire classification M0. And chemically withstand high temperatures without any alteration. It is not hygroscopic, that is, it does not absorb moisture.

SHEEP WOOL

It is a thick, curly and soft fibre that covers the skin of the sheep. Its extraction, through the shearing, takes place once a year between the months of May and June. The use of wool as insulation material implies a treatment consisting of a wash with biodegradable soap and a subsequent treatment with boric salt to strengthen and protect the fibre against the attack of xylophages while increasing its resistance against combustion. After this the carding is performed. It absorbs humidity when it is excessive and releases it when the environment is dry. It is difficult to find an insulator that regulates humidity: this wool can fix 33% of its weight in water and restore it when drying without losing its thermal capacities. Its composition in keratin makes it a low combustible material and with the highest ignition temperature of all natural fibres. It is a very elastic material that grants fabrics made with it the property of non-wrinkles. Taking into account the need to reduce energy consumption and the emission of carbon monoxide to the atmosphere, wool has a very positive energy balance in that its production has reduced energy consumption, it avoids transport costs because it is a Local materials and their use greatly reduces energy costs. It is recyclable.

It will be applied as filling of chambers between partitions, insulating strips in facades and roofs, in acoustic ceilings and in pipes, deposits and solar panels.

STRAW

It is a non-marketed insulation. It is a poor conductor of heat, so it keeps the temperature inside the buildings stable. Good insulation, cheap and used in self-construction.

There are several application techniques: make certain size plates or cast directly on the wooden paneling of the deck. It is mixed with thick lime grout, with some sand and straw. It can also serve as a construction system, in the shape of straw bales, providing a great thermal and acoustic insulation quality, in itself.

Appendix H

Transmittance Upper Structure (Forés)

APPENDIX H: Transmittance

Once the materials for the residence envelope have been selected, different types of enclosures will be designed by calculating their transmittance, the concept of transmittance is used to express the insulation capacity of a particular constructive element formed by one or more layers of materials.

The thermal transmittance (U, but also denominated like U-Value in some places) is the measurement of the heat that flows by unit of time and surface, transferred through a constructive system. In the International System it is measured in units W/m^2k or W/m^2C .

In addition to calculating the transmittance of the enclosures these will be designed to accomplish with the principles and algorithms so the construction can be certified as passive house according to the criterion established by "Passive house institute" for Netherlands. The Passive House Institute (PHI) is an independent research institute that has played an especially crucial role in the development of the Passive House concept, the only internationally recognized, performance-based energy standard in construction.

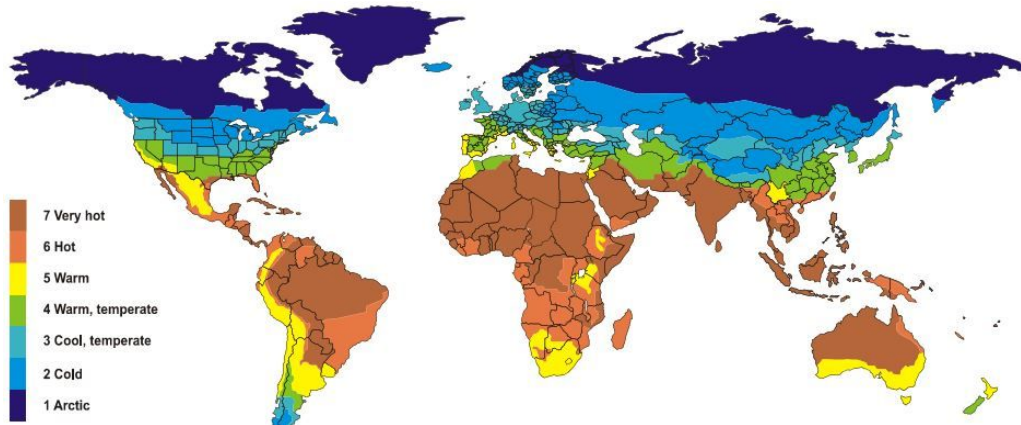

Climate zone	Hygiene criterion	Comfort criterion	Efficiency criteria		
			U-value of the exterior building component $U_{opaque} * f_{PHI}^2 \leq$	Purely opaque details $f_{Rsi=0.25 m^2K/W} \geq 3$	Absence of thermal bridges $\Psi_a \leq 4$
	$f_{Rsi=0.25 m^2K/W} \geq 3$	U-value of the installed window ¹ \leq	U-value of the exterior building component $U_{opaque} * f_{PHI}^2 \leq$		
	[-]	[W/(m ² K)]	[W/(m ² K)]	[-]	[W/(mK)]
1 Arctic	0.80	0.45 (0.35)	0.09	0.90	0.01
2 Cold	0.75	0.65 (0.52)	0.12	0.88	
3 Cool, temperate	0.70	0.85 (0.70)	0.15	0.86	
4 Warm,temperate	0.65	1.05 (0.90)	0.25	0.82	
5 Warm	0.55	1.25 (1.10)	0.50	0.74	
6 Hot	None	1.25 (1.10)	0.50	0.74	
7 Very hot	None	1.05 (0.90)	0.25	0.82	

The project will be developed in Groningen, Netherlands, so it has to meet the parameters of line 3 “Cool, temperate”, therefore the transmittance of the project envelope must be equal to or less than $0.15 W/m^2k$.

Transmittance calculation

e= thickness (m)	EXTERIOR	SHEET 1		SHEET 2		SHEET 3		SHEET 4		SHEET 5		INTERIOR	THICKNESS OF THE WALL (M)
λ = conductivity (W/mK)		WOOD		WOOD FIBER		AIR CHAMBER		WOOD FIBER		WOOD			
	Rse	e	λ	e	λ	e	λ	e	λ	e	λ	Rsi	
U (W/m²K)	-	0.02	0.04	0.11	0.04	0.02	0.017	0.11	0.04	0.02	0.04	-	
0.14954	0.04	0.5		2.75		0.017		2.75		0.5		0.13	0.28
e= thickness (m)	EXTERIOR	SHEET 1		SHEET 2		SHEET 3		SHEET 4		SHEET 5		INTERIOR	THICKNESS OF THE WALL (M)
λ = conductivity (W/mK)		WOOD		CORK		AIR CHAMBER		CORK		WOOD			
	Rse	e	λ	e	λ	e	λ	e	λ	e	λ	Rsi	
U (W/m²K)	-	0.02	0.04	0.11	0.04	0.02	0.017	0.11	0.04	0.02	0.04	-	
0.14954	0.04	0.5		2.75		0.017		2.75		0.5		0.13	0.28
e= thickness (m)	EXTERIOR	SHEET 1		SHEET 2		SHEET 3		SHEET 4		SHEET 5		INTERIOR	THICKNESS OF THE WALL (M)
λ = conductivity (W/mK)		WOOD		CELLULOSE		AIR CHAMBER		CELLULOSE		WOOD			
	Rse	e	λ	e	λ	e	λ	e	λ	e	λ	Rsi	
U (W/m²K)	-	0.02	0.04	0.11	0.039	0.02	0.017	0.11	0.039	0.02	0.04	-	
0.14646	0.04	0.5		2.82		0.017		2.82		0.5		0.13	0.28
e= thickness (m)	EXTERIOR	SHEET 1		SHEET 2		SHEET 3		SHEET 4		SHEET 5		INTERIOR	THICKNESS OF THE WALL (M)
λ = conductivity (W/mK)		WOOD		EXPANDED CLAY		AIR CHAMBER		EXPANDED CLAY		WOOD			
	Rse	e	λ	e	λ	e	λ	e	λ	e	λ	Rsi	
U (W/m²K)	-	0.02	0.04	0.3	0.11	0.02	0.017	0.3	0.11	0.02	0.04	-	
0.15057	0.04	0.5		2.73		0.017		2.73		0.5		0.13	0.66
e= thickness (m)	EXTERIOR	SHEET 1		SHEET 2		SHEET 3		SHEET 4		SHEET 5		INTERIOR	THICKNESS OF THE WALL (M)
λ = conductivity (W/mK)		WOOD		COTTON		AIR CHAMBER		COTTON		WOOD			
	Rse	e	λ	e	λ	e	λ	e	λ	e	λ	Rsi	
U (W/m²K)	-	0.02	0.04	0.09	0.03	0.02	0.017	0.08	0.03	0.02	0.04	-	
0.14591	0.04	0.5		3		0.017		2.67		0.5		0.13	0.23
e= thickness (m)	EXTERIOR	SHEET 1		SHEET 2		SHEET 3		SHEET 4		SHEET 5		INTERIOR	THICKNESS OF THE WALL (M)
λ = conductivity (W/mK)		WOOD		MINERAL WOOL		AIR CHAMBER		MINERAL WOOL		WOOD			
	Rse	e	λ	e	λ	e	λ	e	λ	e	λ	Rsi	
U (W/m²K)	-	0.02	0.04	0.11	0.04	0.02	0.017	0.11	0.04	0.02	0.04	-	
0.14954	0.04	0.5		2.75		0.017		2.75		0.5		0.13	0.28
e= thickness (m)	EXTERIOR	SHEET 1		SHEET 2		SHEET 3		SHEET 4		SHEET 5		INTERIOR	THICKNESS OF THE WALL (M)
λ = conductivity (W/mK)		WOOD		CELLULAR GLASS		AIR CHAMBER		CELLULAR GLASS		WOOD			
	Rse	e	λ	e	λ	e	λ	e	λ	e	λ	Rsi	
U (W/m²K)	-	0.02	0.04	0.18	0.065	0.02	0.017	0.18	0.065	0.02	0.04	-	
0.14869	0.04	0.5		2.77		0.017		2.77		0.5		0.13	0.42
e= thickness (m)	EXTERIOR	SHEET 1		SHEET 2		SHEET 3		SHEET 4		SHEET 5		INTERIOR	THICKNESS OF THE WALL (M)
λ = conductivity (W/mK)		WOOD		SHEEP WOOL		AIR CHAMBER		SHEEP WOOL		WOOD			
	Rse	e	λ	e	λ	e	λ	e	λ	e	λ	Rsi	
U (W/m²K)	-	0.02	0.04	0.16	0.06	0.02	0.017	0.17	0.06	0.02	0.04	-	
0.14954	0.04	0.5		2.67		0.017		2.83		0.5		0.13	0.39
e= espesor (m)	EXTERIOR	SHEET 1		SHEET 2		SHEET 3		SHEET 4		SHEET 5		INTERIOR	THICKNESS OF THE WALL (M)
λ = conductividad (W/mK)		WOOD		WICKER		AIR CHAMBER		WICKER		WOOD			
	Rse	e	λ	e	λ	e	λ	e	λ	e	λ	Rsi	
U (W/m²K)	-	0.02	0.04	0.12	0.045	0.02	0.017	0.13	0.045	0.02	0.04	-	
0.14831	0.04	0.5		2.67		0.017		2.89		0.5		0.13	0.31

For the calculation of the transmittance of the walls has been established a design of two sheets with an outer facing of wood, 2 cm thick, and a chamber of air 2cm between the two sheets, the table above shows the thickness of the wall depending on the insulation material used, analyzing all materials of natural origin and discarding the alternative blocks since their transmittance values are given by catalogue and do not meet the established requirements.

Calculation of thermal transmittance of enclosures in contact with the external air

This calculation is applicable to the opaque part of all enclosures in contact with outside air such as facade walls, roofs and floors in contact with the outside air.

Thermal transmittance U ($W/m^2 \cdot K$) is given by the following expression:

$$U = \frac{1}{R_T} \quad (1)$$

R_T total thermal resistance of the component [$m^2 \cdot K/ W$]

The total thermal resistance R_T of a component constituted by thermally homogeneous layers is calculated by the expression:

$$R_T = R_{SI} + R_1 + R_2 + \dots + R_n + R_{SE} \quad (2)$$

being,

$R_1, R_2 \dots R_n$ Thermal resistances of each layer defined according to the expression (3) [$m^2 \cdot K/W$]

R_{SI} y R_{SE} The surface thermal resistances corresponding to the indoor and outdoor air respectively, taken from table 1 according to the position of the enclosure, direction of the heat flow and its location in the building [$m^2 \cdot K/ W$].

In the case of a component consisting of homogeneous and heterogeneous layers the total thermal resistance R_T is calculated by the procedure described in section 3. The thermal resistance of a thermally homogeneous layer is defined by the expression:

$$R = \frac{e}{\lambda} \quad (3)$$

being,

e The thickness of the layer [m]. In the case of a layer of variable thickness, the average thickness is considered.

λ The thermal conductivity of the material composing the layer

Table 1 Surface thermal resistances of enclosures in contact with the outside air in $m^2 \cdot K/ W$

Position of the enclosure and direction of the heat flow	R_{SE}	R_{SI}
Vertical or sloped enclosures on the horizontal > 60° and horizontal flow	0.04	0.13
Horizontal enclosures or with slope on the horizontal ≤ 60° and upflow (Roof)	0.04	0.1
Horizontal and Downflow Scaffolds (Floor)	0.04	0.17

The air chambers can be characterized by their thermal resistance, according to the following typologies:

a) Non-ventilated air chamber: one in which there is no specific system for the flow of air through it. An air chamber that has no insulation between it and the outside environment but with small openings to the outside may also be considered as a non-ventilated air chamber if those openings do not allow air to flow through the chamber and do not exceed:

i) 500 mm^2 per m of length counted horizontally for vertical air chambers

ii) 500 mm^2 per m^2 of surface for horizontal air chambers.

The thermal resistance of the non-ventilated air chambers is defined in Table 2 according to their thickness. Intermediate values can be obtained by linear interpolation. Values are applicable when the camera:

- is bounded by two surfaces parallel to each other and perpendicular to the direction of the heat flow and whose emissivity is greater than 0.8
- have a thickness less than 0.1 times each of the other two dimensions and not more than 0.3 m
- do not have air exchange with the indoor environment.

Table 2 Thermal resistances of air chambers in $\text{m}\cdot\text{K}/\text{W}$

e(cm)	Without ventilation	
	horizontal	vertical
1	0.15	0.15
2	0.16	0.17
5	0.16	0.18

Appendix I

Supply Systems (Morant)

APPENDIX I. SUPPLY SYSTEMS

1.1.OVERVIEW

Nowadays energy consumption is an influential point in our life. Every day new data warns about climate change, the decline of fossil resources, the pollution of the environment or the rising cost of fossil fuels. This reality has forced the society to reconsider the habits of consumption and production acquired in the last century. Lighting a lamp, cooking, taking a bath or using the computer are daily actions that require energy. Obviously energy must be consumed to evolve, but that energy consumption has to be based on two pillars. One is the production of energy using renewable sources and the other is to reduce the consumption to the minimum necessary always with responsible and sustainable policies in all fields. People must be more efficient.

Nowadays, nuclear energy, fossil fuel energy, biomass energy (mainly wood combustion) and hydropower, meet the majority of the world's energy demand, with oil and coal being the mostly used. The use of these resources implies the depletion and deterioration of the environment, as a consequence of the construction of major works of considerable environmental impact, such as power plants, overheating of water in rivers and coasts generated by nuclear power plants, creation of deposits for radioactive elements, and of a large emission of small volatile particles that provoke acid rain, further aggravating the situation of the environment: natural sites defoliated, cities with high pollution rates or the disappearance of animal and plant species. Energy has passed through history, from being an instrument at the service of the human being to satisfy his basic needs, to be the great threat that looms over the planet. In summary, three are the problems that have led us to the excessive consumption of energy: first, a deterioration of the environment; secondly, a gradual depletion of natural resources; and thirdly, an irrational imbalance in the distribution of consumption and use of energy. To face this situation, renewable energies acquire a primordial, necessary and urgent role both in its application and in the diffusion of its use.

The energy availability of renewable energy sources is bigger than conventional energy sources, but their use is rather scarce. These types of energy are considered as inexhaustible sources of energy, but have the peculiarity of being clean energies, defined by the following characteristics: their systems of energy use imply a zero or low environmental impact, its use has no potential added risks, indirectly represent an enrichment of the natural resources, the proximity of the centers of energy production to the places of consumption can be viable in many cases, and represent an alternative to the conventional sources of energy.

The energy consumption in a building depends on many factors: the climatic zone where the building is located, the quality of the building systems, the level of insulation, the degree of equipment, the use given to them, etc. All of them have in common that their operation contributes to the consumption of natural resources, in some cases water consumption, in other energy consumptions or both at the same time. Thus, any measure that is used to improve efficiency will help to reduce the bill and the consumption of natural resources. Employing certain equipment or strategies would allow to cover the needs and to be able to offer the services that a building demands with a much smaller use in the consumption of resources.

To study and analyze these two issues, some questions have been asked:

- Which criteria can be applied?
- How make a building self-sufficient?
- Why make a building self-sufficient?
- How can consumption be reduced?
- What strategies are available?
- How can renewable energies be included?
- What consumption can be supplied?
- Which energy systems are more suitable?

These questions will give the starting point to set the requirements that will asses this research.

Self-sufficient buildings are those that do not need external energy supplies, that is, they are able to generate and consume their own resources in a zero balance. The idea of creating a building of these characteristics is born of the requirements of the client and the European Directives about energy efficiency, which establish that from 2021 it will be mandatory for all new buildings to be nearly zero energy buildings (2010/31 / EU) . For the construction of a self-sufficient building will be required a comprehensive study of techniques and standards of construction that reduce consumption, and energy systems and supply that allow the disconnection of this building from the supplying network. For the study of the techniques and the standards of construction, the principles of the Passive House Institute will be taken as reference. This institute certifies buildings that meet very strict requirements on the reduction of heat losses and air leaks that significantly increase energy consumption. In addition, various bioclimatic architecture strategies will be studied to reduce consumption. With these two measures is sought to reduce losses and consumption to the minimum possible.

When consumption cannot be minimized or eliminated, the use of renewable energy production systems will be considered. To do this, the supplies needed to consider a building habitable will be studied. Efforts will be made to reduce the number of supplies by maximizing specific supply needs.

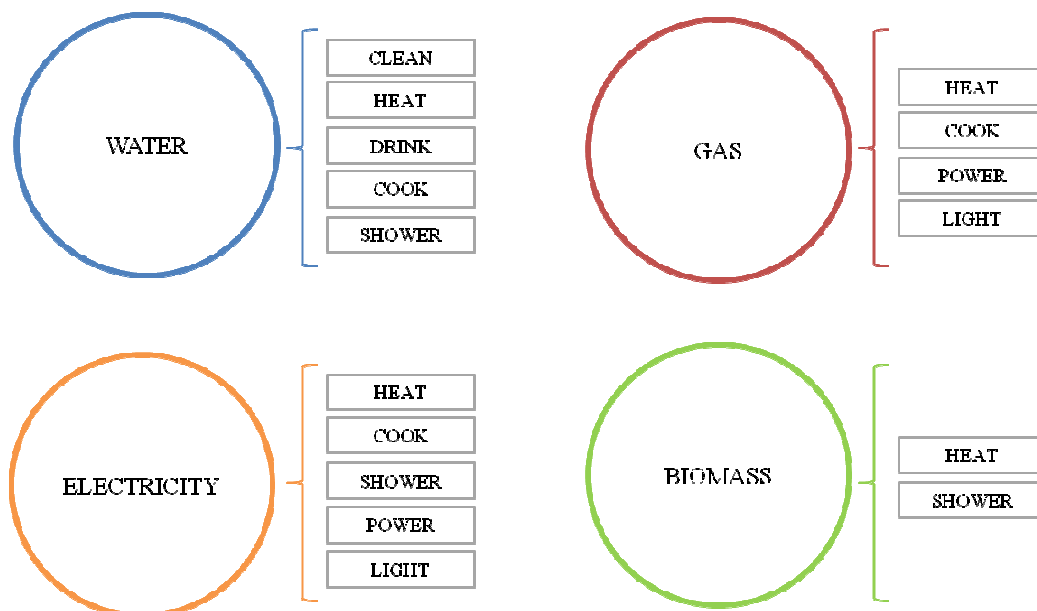

After the analysis carried out in the scheme, it is determined that the supplies to be analyzed will be the electric energy and water since both cover the greatest number of uses.

Food supply and waste management have not been studied because of the short duration of this study. Both topics can mean a separate study topic that can be carried out by another research team.

1.2.STATE OF REQUIREMENTS

To assess all the information analyzed, some requirements are stated. All the information will be evaluated following the principles mentioned below. In some cases, even if a proposal fits all the requirements, it can be dismissed following the advice of other chapters to avoid any disturbance between study fields (supply systems – materials – foundation).

1.1.1. Client

The project pretends to follow the idea of Michael Bosscher to develop an off-grid, self-sufficient student home in Groningen. The focus of the research will be the integration of the different services and systems within the construction of the building.

Mr. Bosscher has stated three main requirements:

- Modularity: the building has to be able to grow both in length and high.
- Sustainability: the building has to be self-sufficient, has to reduce its carbon footprint and ecological impact.
- Scalable: the building has to be adaptable to every and each part of the world.

In this chapter, the fundamental criterion is self-sufficiency: to be able to design an autonomous building and off-grid. To this end, a number of design and supply proposals will be studied, which will help to reduce consumption and obtain energy in a sustainable way. The reduction of both the environmental impact and the carbon footprint will be achieved as a result of the implementation of the criterion of self-sufficiency (less consumption + clean energy = less environmental impact + less carbon footprint).

The idea of creating a sustainable and autarkic building means that it can be developed anywhere on the planet. Even so, some considerations about the design or the need for energy should be made for each particular location.

In addition, the typology of this building is student housing. This makes necessary to take into consideration the needs of future clients. The main concern of students is money. They want that the general expenses of their house are not elevated, reason why the incorporation of systems that reduce the consumptions and systems that produce energy in a sustainable way is an important criterion.

1.1.2. Legal requirements

This project will be subject to international and national regulations regarding design, functionality, technology and construction. Due to the international character of this project and the difficulty of covering all the regulations that would apply to it, it is decided to establish generic measures based on European directives.

Regarding the design and construction of the building, the requirements established by the Passive House Institute will be taken into account:

- Ensure good thermal insulation.
- Use windows with insulated frames and low emissivity crystals.
- Ventilation heat recovery.
- Reduction of air infiltration.

- Absence of thermal bridges.

In the section about technology which this chapter is related to, several directives have been found that apply to it.

- Directive 2010/31 / EU on the energy performance of buildings
- 244/2012 / EU supplementing Directive 2010/31 / EU by establishing a comparative methodology framework for calculating cost-optimal levels of minimum energy performance requirements for buildings and building elements

Both are related to energy efficiency and establish various measures that should be taken into account during design:

- The use of high energy efficiency systems will be considered.
- The number of nearly zero energy buildings should be increased. From 2021 will be mandatory.
- All buildings must have an energy certificate that evaluates them in terms of energy efficiency.
- The annexes of the regulations determine methodologies for the evaluation of energy efficiency systems.

1.3. RESEARCH DATA. BIOCLIMATIC ARCHITECTURE

As it has been said at the beginning, reducing consumption is a must in every building. Achieving that reduction through bioclimatic strategies seems the smartest starting point.

Bioclimatic architecture consists on the design of buildings taking into account the climatic conditions and taking advantage of available resources (sun, vegetation, rain, winds) to reduce environmental impacts and attempting to reduce energy consumption. Bioclimatic construction is an imperative in our society so that the energy consumption is lower than in conventional buildings.

The objective of the bioclimatic exercise is always the same, to achieve within the house the best possible climatic conditions for as long as possible even if at the exterior conditions vary. Do not get too cold during winter or too much hot in summer, having a good air circulation, proper lighting, proper thermal and sound isolation, use non pollution materials and creating a comfort, pleasant and healthy space are the basics strategies that bioclimatic architecture aims to. Bioclimatic Architecture is, in short, an architecture adapted to the environment, sensitive to the impact it causes to the nature, and that tries to minimize the energy consumption and with it, the environmental contamination.

Several strategies related to sun, wind and water will be studied.

1.1.3. Orientation

Orientation is the specific positioning of an object respect to the cardinal points. Orientation is a decisive factor in the construction of housing due to the need to take advantage of solar radiation. The advantages / disadvantages of each orientation in the Northern Hemisphere are mentioned below (these characteristics are inverse in the Southern Hemisphere).

- Orientation North: This orientation receives the sunlight directly in summer; in winter the amount of light is much reduced, especially in the early hours in the morning and in the last hours of daylight. This orientation is recommended in hot areas. The house will be cooler and will not need to use the air conditioning. As opposed, the house will have deficiency of natural illumination during great part of the year.
- Orientation East: This type of orientation is recommended for homes in any climate zone. The sun affects mainly in the early hours in the morning, until noon, during practically the whole year. The sun in the early hours of the day is not so aggressive and during the day its incidence is reduced, which causes that in the afternoons the house is fresher.
- Orientation west: This orientation presents advantages and disadvantages for both climates (warm and cold) depending on the season in which they are. During summer the sunlight hits the house from noon to sunset, which translates into an increase of temperatures. The house is cooler during the morning, but warmer after noon. This can benefit homes in cold climates but harm those in warm climates. During the winter, the sunlight briefly affects this orientation due to the shortage of hours of sun, which translates into a reduction of temperatures and affects the buildings inversely during summer season.
- South orientation: Highly recommended in areas where it is cold most of the year. The sun always gives, directly, all day and all seasons. The highest solar incidence occurs during the central hours of the day. This orientation should be avoided in warm climates.

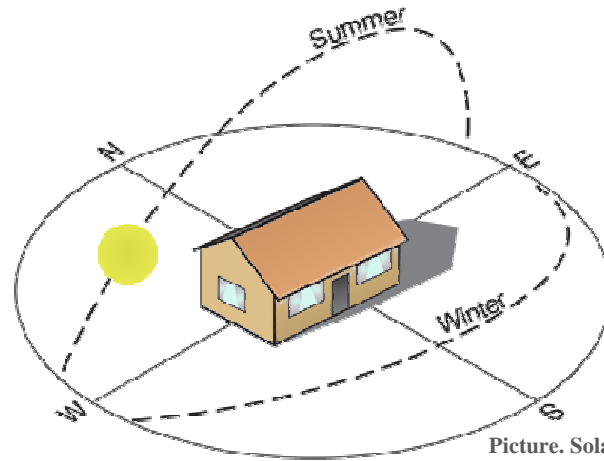

Picture. Solar path [Google images]

The choice of orientation is included within a series of measures called *passive solar design*. Passive solar design represents one of the most important strategies for replacing conventional fossil fuels and reducing environmental pollution in the construction sector. In passive solar building design, windows, walls, and floors are made to collect, store, and distribute solar energy in the form of heat in the winter and reject solar heat in the summer. The goal is to enable the building to be more energy efficient and to offer higher standards of visual, thermal and health comfort for the occupants.

The main function of a passive solar building is to reduce the demand for auxiliary energy, mostly electricity. This is achieved through designs where the building and its solar system are closely linked. These systems can be used for heating, cooling and lighting.

Here are the four principles of use, which will give an idea about how to implement a passive solar design:

1. Daytime solar catchment: solar energy is collected and converted to heat (through big glasses or other techniques).
2. Heat storage: heat collected during the day is stored inside the building for future use (through thermal masses).
3. Heat distribution: stored heat is distributed to rooms or areas that require thermal conditioning (through radiation, convection or conduction).
4. Heat conservation: heat is retained in the building for as long as possible (through proper isolation).

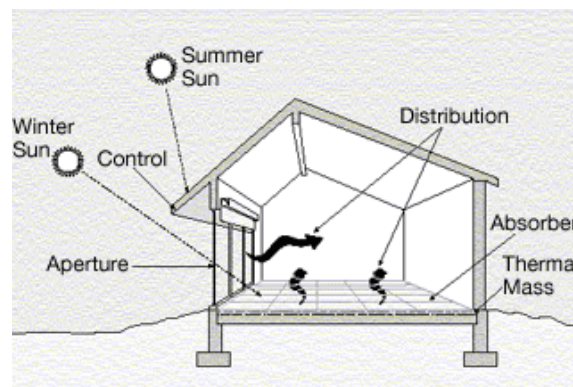

Picture. Passive solar design principles [Ref 03]

These principles will be achieved through the following basic strategies:

1. Orientation of the building: For the Northern hemisphere the ideal orientation is the South with a deviation of up to 30° East or West, to maximize the solar gain. In the Southern Hemisphere, the proper orientation will be the North with the same deviation as the Southern hemisphere. The receiving facade must be free of tall buildings, evergreen trees and any obstacle that prevents direct radiation to the building.
2. Selection and location of windows: Heating with passive solar energy is simple; just let the sun enter into the house through the windows. It is a question of properly dimensioning the windows of the facade to maximize the entrance of solar radiation and to reduce the nocturnal losses. This is a delicate balance because allowing the entrance of radiation, also encourages its exit. New window technologies, which include selective layers, have reduced those losses by increasing the insulation properties of windows to help maintain the heat where it is needed.
3. Taking advantage of passive solar energy: In cold climates, the strategy of passive solar heating consists of orienting most of the facade hollows to the south. However, in hot climates, it would be prudent to blind the southern facade and insulate it properly to avoid overheating. This strategy has no additional cost besides a proper project planning. Higher energy glass surfaces can be installed as long as a thermal mass is expected to accumulate excess energy to release it during overnight.
4. Solar protection: The height of the sun in summer is higher than in winter. Well-balanced eaves or awnings are an effective option to optimize the heat gain. They allow protection against overheating in summer but allow the sun to pass during winter. Landscaping with deciduous vegetation helps to shade in summer the windows located to the south, east and west, preventing the gain of summer heat.

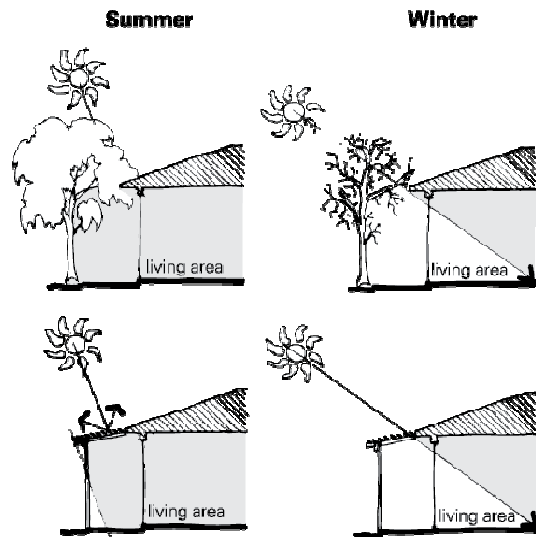

Picture. Solar protection examples [Google images]

All these strategies are related to the Passive House principles explained in an early section. Other strategies as isolation and thermal mass will be studied in their own section.

1.1.3.1. Weather analysis for the location

Weather patterns are an important factor for the design of the building. The weather differs during the year. For the design of the unit an analysis will be made per different season during a year. The weather information is gathered from the KNMI database and the “SunEarthTools” website for the rotation of the sun.

At the beginning of this project, the group made a tour through the city of Groningen to look for inspiration and possible locations. After visiting few places, and following the indications of the client Michael Bosscher, the location was selected at Noorderhaven. Below is some weather data about the specific location of this project that will help with the orientation analysis needed.

The following graph contains the different weather aspects and the data of it. The numbers represent an average day in the different months for the last 10 years. In other sections, graphs like the following are used as well to help with the analysis.



Picture. Hours of sunshine, Percentage of sunshine and Global radiation graph [Ref. 01]

The graph above is made with the data from the KNMI weather records from Eelde. It shows the average hours of sunlight in the last ten years. It also shows what percentage that is of the possible sunlight for a day. These values are important for the units. The hours of sunlight have influence on solar panels on the roofs and for the passive solar which is a big part of the unit design.

1.1.3.2. Sun path and elevation

As has been said at the beginning, knowing the position of the sun will give an idea of which is the best orientation to take advantage of the bigger amount of solar radiation.

The graph shows the sunset and sunrise directions and the path of the sun during summer and winter. With information about the average sun hours per day per month, useful information for the shape and location of the building can be found. When it is clear where the most sunlight is per day, the orientation of the unit can be chosen. The sunlight during winter and autumn has to be used as much as possible, in order to gather more natural heat into the house. During spring and summer, more shadow is necessary to keep the building as cold as possible.

The KNMI records show different sun related aspects, for example the amount of sun hours. However it does not show the sun path during the day and the direction of sunrise and sunset. This data can be checked in the *solar path graphic* and the *elevation graphic*.

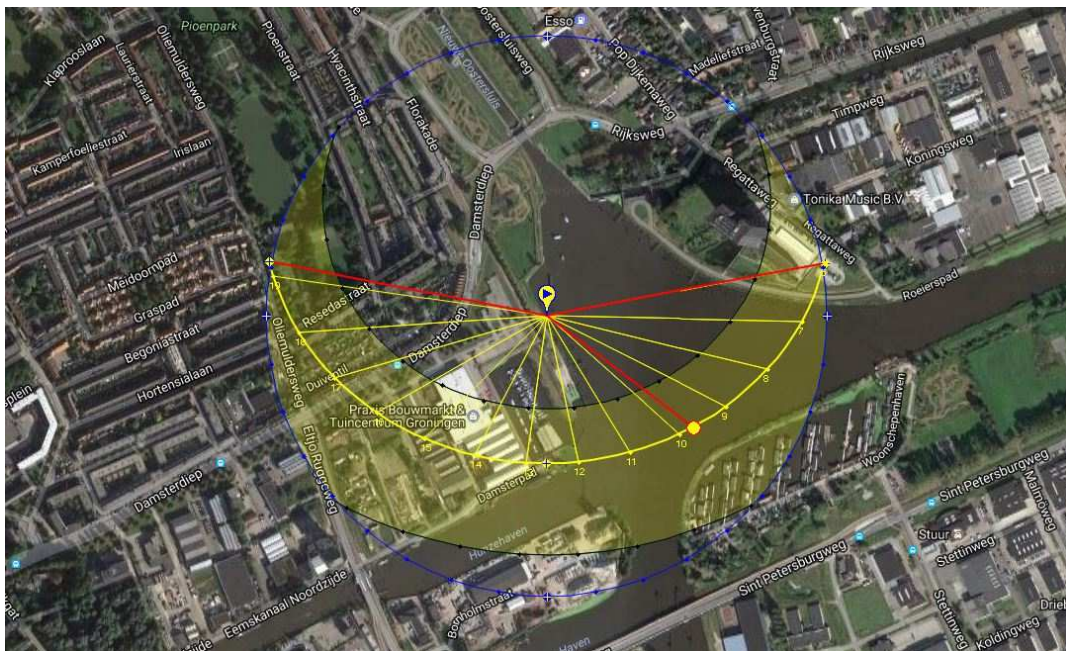

Picture. Sun path and sun rays [Ref 04]

This picture shows for the specific location the position of the sun through a year. The yellow curved line is the sun path for the exact day this information was found. The yellow straight lines show the position of the sun for a specific hour. This data is better shown at the following graph.

name:
 lat.: 53.2234886
 lon.: 6.5945435
 date: 04/04/2017
 time: 09:43 gmt0
 azim.: 127.16°
 elev.: 30.93°

SunEarthTools.com

- 21/06/2017
 - 04/04/2017
 - 21/12/2017

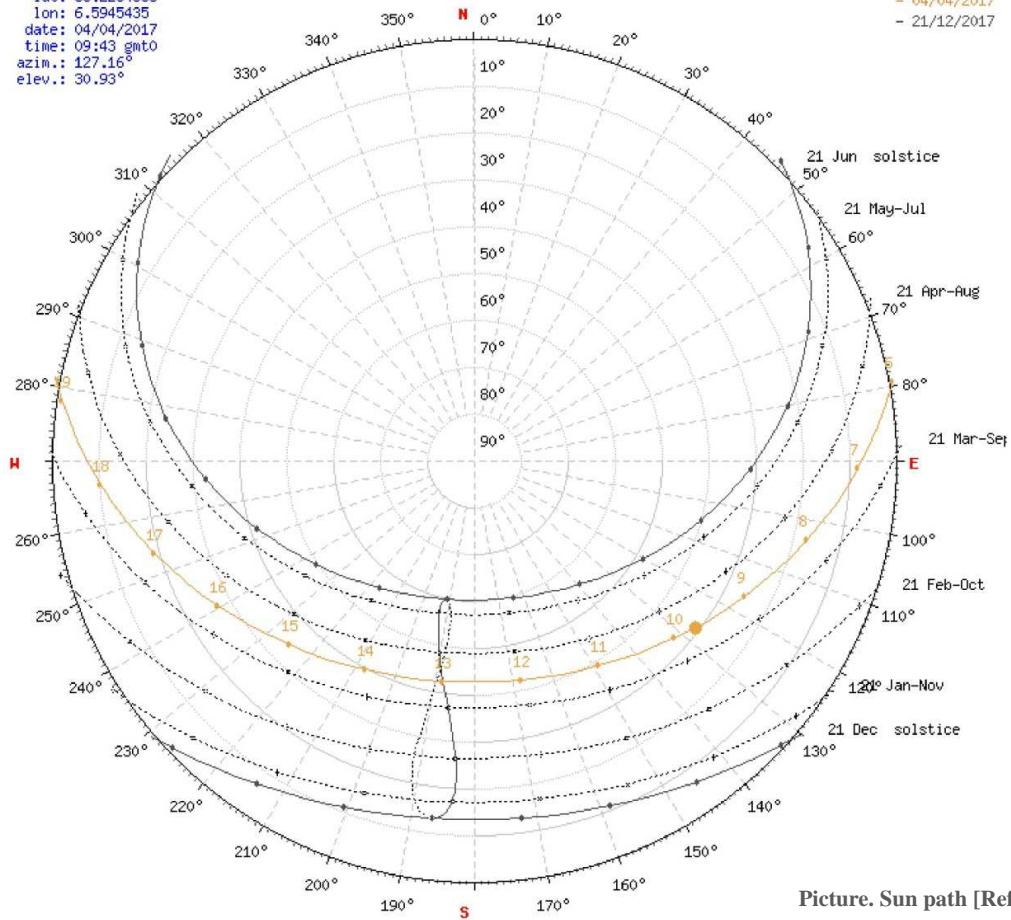

Picture. Sun path [Ref 04]

This graphic shows every position the sun takes in a year. The day this graphic was taken is displayed in a yellow line. The solstices (winter solstice 21st December and summer solstice 21st June) are presented in a continuous line while other significant dates are marked in a dot line. The loop shown represents the position of the sun for a specific hour during the same year. As it can be seen, depending on the season the sun takes different positions for the same hour.

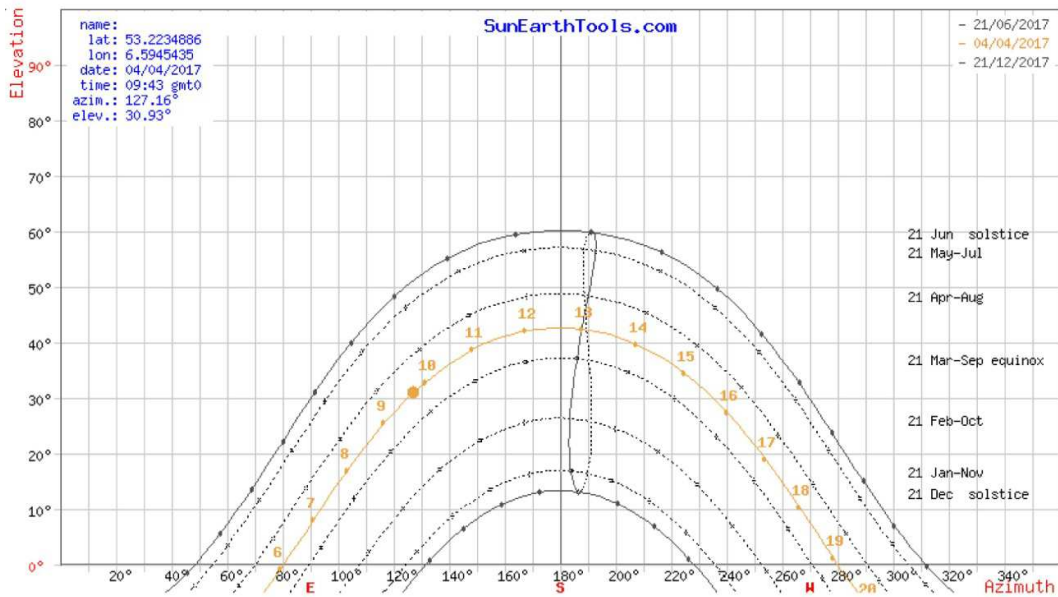

In this graphic is represented the sun elevation during a year. It means how high the sun is for every hour per day in a year. As it can be seen, during winter the sun is in a lower position (13°) than during summer (60°). This can be used as an advantage for heating the building in a natural way, using solar radiation and also gives the idea of installing some solar protections to prevent excess heat during summer.

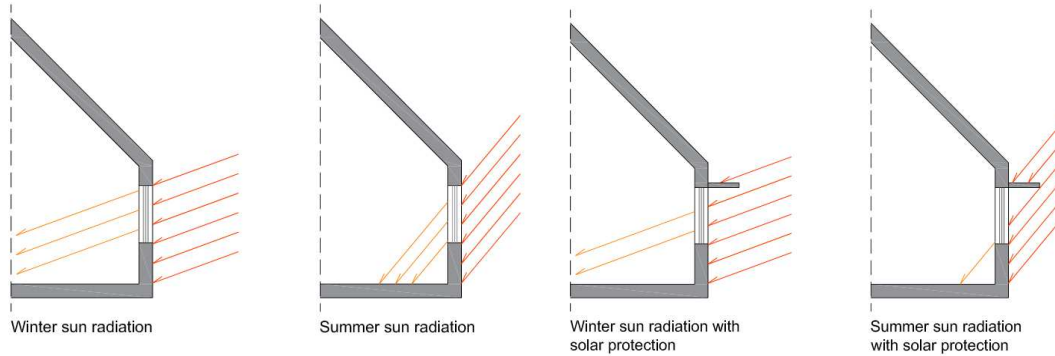

Picture. Solar radiation [own source]

Picture. Solar radiation with protection [own source]

This two draws series show how using solar protections the solar radiation can be minimized as willing.

1.1.3.3. Conclusion

After taking into account all the weather data, can be concluded that the chosen location has many advantages for the construction of this project. Is well communicated to the city centre, there are no tall building near that can present a shadow issue, the amount of solar radiations is enough during summer and the wide variation of sun elevation between summer and winter will benefit the use of protections.

During the design phase of the building all these strategies will be taken into account to create the most sustainable building as possible. Below there is a table that will summarize the most important ideas about orientation, taking into account the chosen location.

Orientation	Main rooms as bedrooms and common rooms should be orientated to the South (maximum 30° SW-SE deviation). Shared facilities as kitchen, toilets and laundry room should be orientated to the North.
Windows location	The biggest masses of glass should be placed on the south facade. In the north facade the hollows should be reduced.
Passive solar energy	The study of this strategy will be carried out in other section of the project.
Solar protections	To reduce the amount of heat during summer, solar protection will be placed over the windows. (check the following section)

1.1.4. Solar protection

As it has been said before, using sun radiation for heating is important. But during summer can cause a rise on the amount of refrigeration. That is why using solar protections is so important. Here there are different proposals for protections. All these methods can be combined.

Eaves and overhangs

As part of the architecture of the building, eaves and overhangs can be designed to allow the passage of solar rays during the winter but prevent them during the summer. To determine the optimal length, the sun's elevations must be considered during both summer and winter stations.



Picture. Overhang [Google images]

Window retract

This solution can also come integrated into the design. It is simply necessary to place the window on the inner sheet of the facade and take advantage of the difference of its thickness to produce shady areas during the summer.



Picture. Window retraction [Google images]

Awnings

It is an easy solution to implement. Simply put an awning over the existing window and raise or lower the awning according to the need of the user.



Picture. Awning [Google images]

Slats

This type of protection is quite effective, especially in large buildings with glass facades. It has the peculiarity of absorbing and reflecting solar radiation but without damaging the entrance of natural light inside the building. In the case of mobile slats, allows the reorientation of light according to the needs and the time of year. Nowadays there are several designs of this solution that can be placed both vertically and horizontally, mobile or fixed, metal wood or glass, which is an aesthetic addition.



Picture. Slats [Google images]

Reflective sheets

In the market is easy to find several types: interior, exterior, reflective and insulating. The reflective sheets (mirror type) are the most suitable for summer, while offering effective protection against ultraviolet rays and also against the curious.



Picture. Mirror reflective sheet [Google images]

Deciduous vegetation

It is the solution more respectful with the environment. Using deciduous trees allow the entrance of light during the winter and avoid its entrance during the summer. It is a solution used for many years. The selection of the vegetation must be made taking into account the native species and the climate.

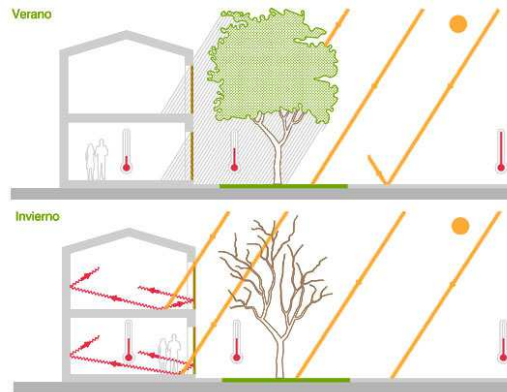

Picture. Deciduous vegetation working [Google images]

As a summary of this section here is an evaluation of each solution according to the criteria established. Every solution is scored for each criterion in order to know how well do they fit in.

	Modularity	Scalability	Sustainability	Total
Eaves and Overhangs	✓	X	✓	✓
Window retract	✓	✓	✓	✓
Awning	✓	✓	X	✓
Slats	✓	✓	X	✓
Reflective sheets	✓	✓	X	✓
Deciduous vegetation	X	X	✓	X

Due to the nature of this project (floating houses) deciduous vegetation has been excluded because the difficulty of growing over the foundations and the risk that it may cause to its duration and stability. Reflective sheets has been eliminated due to the high cost of this solution and because is the less sustainable solution. Awning are excluded as well as they are not an original idea and do not provide other utilities.

For the design of this project will be taken into account the eaves, overhangs, windows retraction and slats solutions. An analysis of the benefits or problems for each solution is developed next.

1.1.4.1. Solution's analysis

Here is an analysis of the solutions available in the market at this moment for each proposal.

Eaves and overhangs

There are no “different solutions” as it has been said before, eaves and overhangs are schemed during the design phase. For this project they are a perfect solution to reduce solar radiation in terms of carbon footprint, environmental impact and cost of production because they are made as an extension of the roof and with the same materials. The modularity solution developed in this project allows creating eaves.

Window retraction

This solution is, as the previous one, easy to develop and it has no more cost than taking it into account during the design phase. In this project, all the windows will be placed aligned to the inner sheet of the façade. The difference of tightness between the facade and the window will help to reduce slightly the entrance of solar radiation.

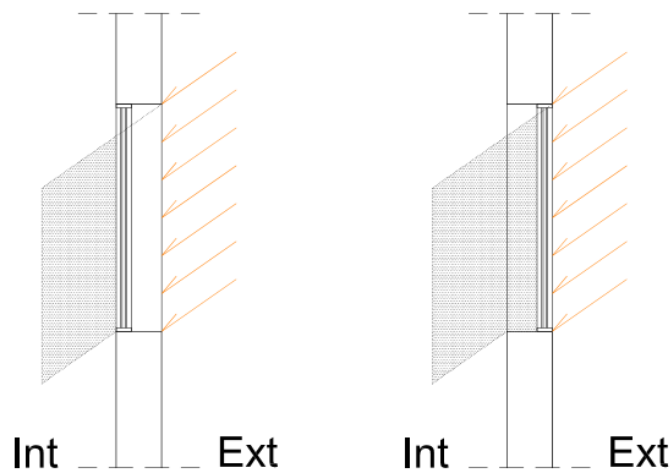

Picture. Window retraction [own source]

Slats

There are multiple solutions available in the market. The general characteristics are compiled into the following table. Among all the differences that define each system, is needed to make some definitions and analysis before.

MATERIALS:

Wood

Some examples of used wood are Douglas Pine and Pacific Red Cedar. Larch wood, Robinia, Chestnut and Thermally-modified pine can also be applied. These woods should be obtained from controlled forest plantations. Other species of wood can be used, based on special requirements and avoiding the use of tropical or exotic woods.



Picture . Wood slats [Ref 06]

HPL

These are flat panels made of thermo-hardened resins, evenly reinforced with fibres based on wood and manufactured at high pressure. The panels have an integrated decorative surface and are extremely resistant to outdoor conditions. This is a solid, durable material.

HPL finishes



Picture . HPL slats [Ref 06]

The HPL panels are available in a wide range of colours, effects and textures, depending on each manufacturer.

Aluminium

The aluminium used should be extruded aluminium profiles, with UNE AW-6063 (T5) or UNE AW-6060 (T5) alloys and comply with the UNE-EN 755-2 & UNE-EN 573-3 control standards. All the accessories should be made of UNE AW-5754 alloy. Aluminium finishes.

Depending on the manufacturer colours available will differ. Some manufacturers offer both matt and glossy finishes. For anodised products, a wide range of shades is possible. The process applied should be based on the European Qualanod Standard.



Picture. Aluminium slats [Ref 06]

Glass

Glass can be used to form slats with different colours, surface finishes, patterns and coatings to meet specific design requirements. They can be integrated into a mobile or fixed system. Photovoltaic cells can be integrated into the glass (either by attaching them onto the reverse side of the glass panels or by laminating them between two sheets of glass) so is possible to generate electricity at the same time as providing shading.

Photovoltaic Cells:

- Maximum solar protection
- Excellent lightness
- Electric energy production
- Transparent photovoltaic cells

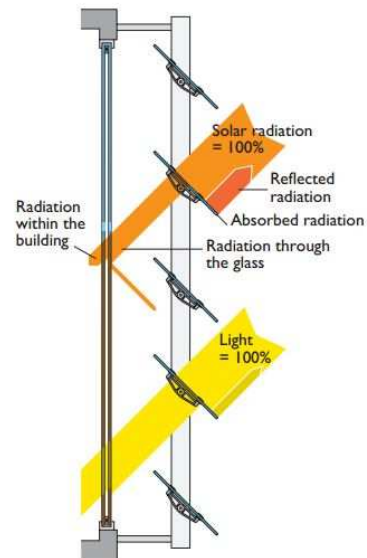

Picture. Glass slats sunlight radiation [Ref 06]

Fabric

This system offers many configurations, both in the colour choice and material choice. Fabric options include: PVC, Teflon glass fibre membrane, Silicon glass fibre membrane - ETFE (coloured or translucent) and ETFE (screen printed).



Picture. Fabric slats [Ref 06]

OPENING:

Here is described every construction solutions develop to open the window.

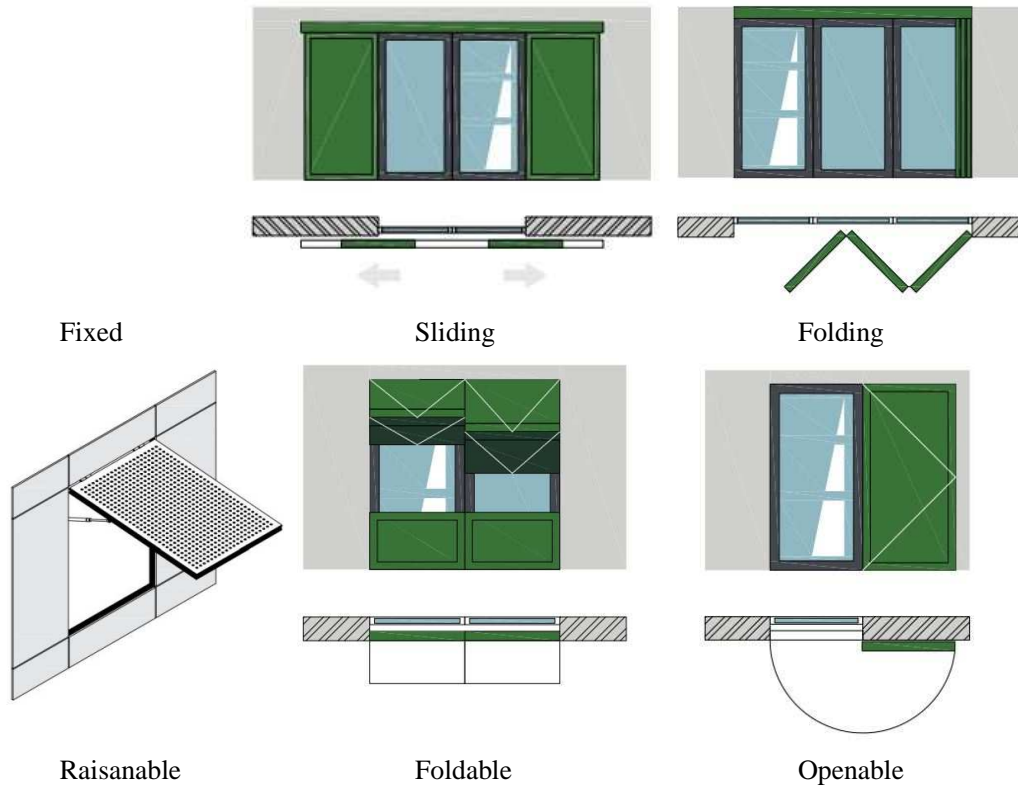

Picture. Examples of window opening [Ref 05]

Here is the table with the general characteristics for every slats system available:

MATERIAL	INSTALLATION	MODEL	MOBILE/FIXED SLATS	OPENING	EXTRA
WOOD	Vertical	Lattice	Mobile	All	Manual/Mechanical drive
			Fixed	All	Various slat sizes
		Screens	Mobile	Fixed	Manual/Mechanical drive
			Fixed	Fixed	Various slat shapes
	Horizontal	Screens	Mobile	Fixed	Various slat shapes

		Overhang	Fixed	Fixed	Various slat shapes
HPL	Vertical	Lattice	Mobile	All	Manual/Mechanical drive
			Fixed	All	Various slat shapes
		Sunscreens	Opaque	All	Various designs
			Fixed	Fixed	Angle position fixed (0° - 60°)
ALUMINIUM	Vertical	Lattice	Mobile	All	Manual/Mechanical drive
			Fixed	All	Various slat shapes
		Sunscreens	Opaque	All	Various designs
			Mobile	Fixed	Manual/Mechanical drive
	Horizontal	Sunscreens	Fixed	Fixed	Various slat shapes
			Mobile	Fixed	Manual/Mechanical drive
		Overhang	Fixed	Fixed	Various slat shapes
			Mobile	Fixed	Manual/Mechanical drive
GLASS	Vertical	Sunscreens	Mobile	Fixed	Mechanical drive
			Fixed	Fixed	Various finishes
	Horizontal	Overhangs	Fixed	Fixed	Photovoltaic cells
			Fixed	Fixed	Various finishes
					Photovoltaic cells

Examples of slats:



Picture. Models of slats: lattice fix, lattice opaque, sunscreens horizontal and vertical [Ref 07]

1.1.4.2. Conclusion

After all this analysis, all of these solutions have been chosen to be part of the design:

- Eaves and overhangs are easy to implement into the design and follow all the states of requirements.
- Window retraction will be developed into the design.
- Slats are good systems to implement into the design because glass slats can incorporate photovoltaic cells to produce energy. However, slats will not be included in the final design since with the incorporation of eaves the problem of solar radiation is solved in a more affordable way.

1.1.5. Ventilation

As part of the bioclimatic strategies being applied, the ventilation flow must be studied in order to reduce or even eliminate the use of mechanical refrigeration systems. Since the project is located in a cold climate, the need for mechanical ventilation for cooling is very small, but still, the study of passive ventilation systems such as cross ventilation should be taken into account in this project.

The study of the ventilation tries to establish which are the wind flows that run through the selected location (speed and direction) and to determine strategies that allow their use in the design of the floating building. To do this, the following steps will be analysed in the study phase:

- Determine the speed and direction of winds per year.
- Sectorize spaces according to uses. Concentrate high-heat-emitting spaces.
- Design proper windows.
- Ventilate buildings at night.
- Ensure good thermal insulation.

1.1.5.1. Wind analysis

The following graph contains the wind speeds and the average directions.

- Wind speed shows which directions are the most suitable to take into account and if they could be used for other purposes as electricity generators. This last idea will be studied in a further stage.
- Wind direction gives the idea of where to create holes to allow the entrance of fresh air to renovate and ventilate every room.

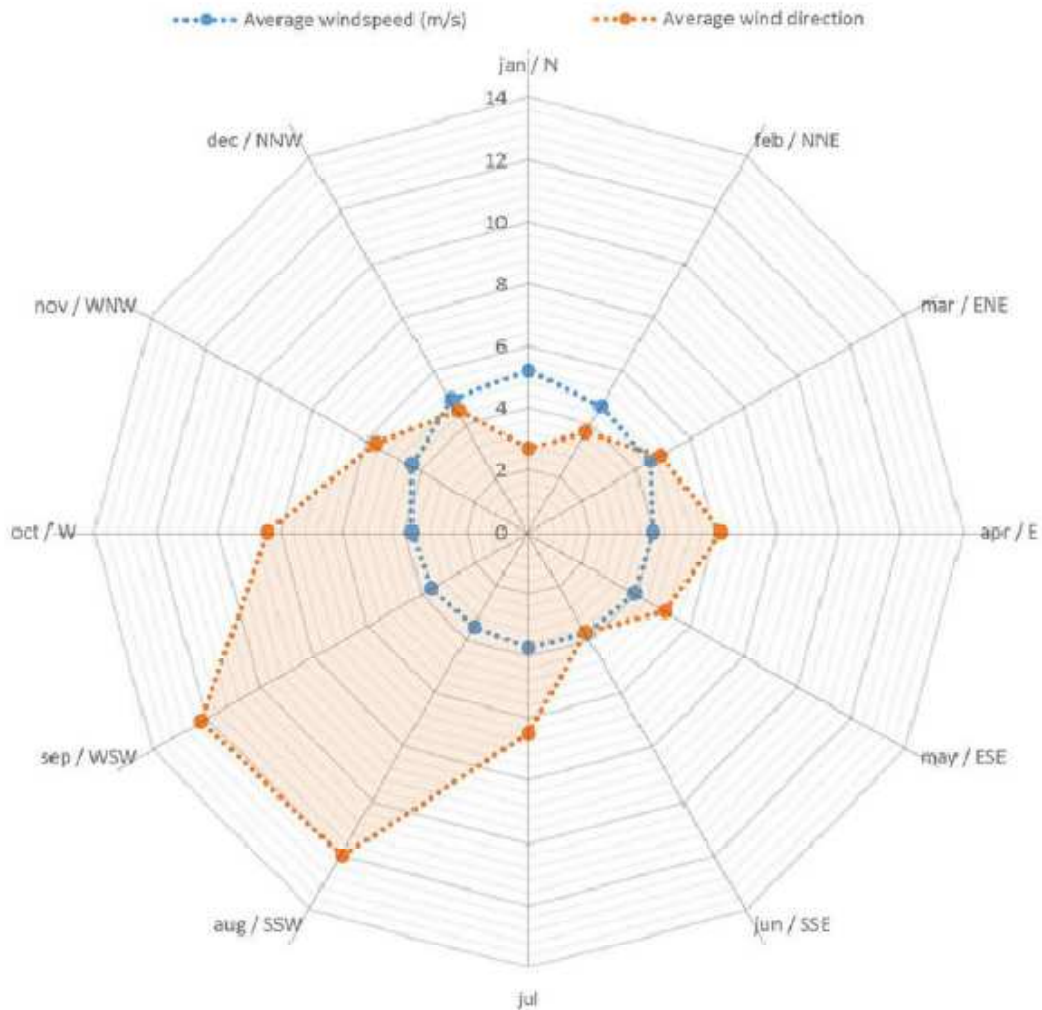

Picture. Average wind speed and Wind direction [Ref 01]

As it has been said, the building is located in a cold climate, so the refrigeration problem is not an issue. In the other hand, ventilation is always a comfort concerning for the design. Spring and summer are the hottest seasons, when the maximum temperatures and the longest sun hours are presented. During these seasons designing a good ventilation system is a must.

Winter and autumn are not critical seasons due to the cold weather, but creating a proper ventilation system can help not just to create a more comfort space but a redirecting heating system.

As the graph shows, wind principal direction is South-west. The wind speed is equilibrated during the year around 4,20m/s. This data will be taken into account into the final design.

1.1.5.2. Space sectorization

During the design phase the principle of sectorizing spaces according to their use will be taken into account (eating, sleeping, cooking, washing, etc).

This sectorization will help to create specific spaces for specific uses. It will help as well to the design of the whole building, its distribution and to the relationship among the people who will live there. Concentrate high-heat-emitting spaces will determine which rooms will need extra

care for the determination of the minimum ventilation. For example, the kitchen will not only need ventilation to avoid heat but to evacuate smells produced by cooking.

Space	Kitchen	Common room	Laundry room	Bathroom	Hall	Bedroom
Appliance	Oven Stove Toaster Kettle Fridge Freezer	TV Stereo Computer Cell phone Vacuum cleaner	Washing machine Dryer	Hair dryer Razor	Vacuum cleaner	Stereo Computer Cell phone Hair dryer Vacuum cleaner
Hours/day	4.00	2.00	2.00	0.50	0.25	6.00
Simultaneity	0.85	0.30	0.50	0.50	1.00	0.60
Score	3.40	0.60	1.00	0.25	0.25	3.60

The table shows an approximation of which spaces will have the building and which appliances are the most common to use in each space. The Hours/day parameter shows how much time are used all the appliances contained in one space per person. The Simultaneity parameter reflects the probability for all the appliances to be used at the same time. With these data is easy to find which spaces are the most heat-emitting ones.

Spaces as kitchen and bedroom are determined to be the most concerning spaces in terms of heat-emitting spaces. In these spaces is needed to be more careful into the design of the ventilation system.

1.1.5.3. Windows dimensions

Adequate ventilation could be reached through a proper design of the facade holes. Through knowing the wind direction and the need of fresh air, window dimensions can be established. Other guidelines that may influence the final design of the building are:

- The practicable area of the windows should reach the ceilings to allow the hot air accumulated in the upper part of spaces to escape.
- Windows should incorporate possibilities of micro-opening for ventilation. If it is not possible, walls should incorporate these gaps.

These recommendations will be taken into account into the final design.

1.1.5.4. Ventilation at night

During summer it is necessary to provide adequate night ventilation that provides the maximum airflow avoiding the accumulation of diurnal heat. Ventilation can be significantly improved by the installation of a solar chimney. During the day ventilation should be minimal. Thus, being cooler, walls and ceilings will act as a barrier to the entrance of solar radiation and the interior heat will be basically produced by the human body and appliances.

In winter, however, ventilation should be restricted both during the day and at night. Ventilation may be done indirectly by means of solar chimneys or other equivalent means such as wall gaps.

1.1.5.5. Ways of ventilation

Direct ventilation

Direct ventilation is commonly called cross ventilation. Cross ventilation occurs where there are different pressures between one side of a building and the other. The airflow goes from one side of the building to the other, even in vertical direction, due to the effect of the pressure differences. High-pressure wind produces suction of low-pressure winds creating airflow due to convection.

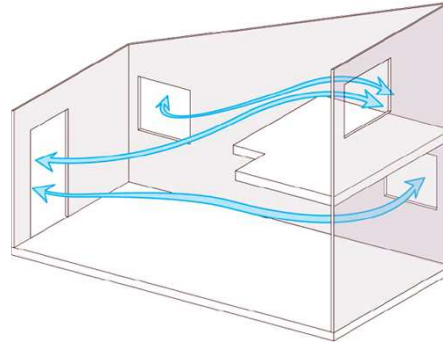

Picture. Cross ventilation [Google images]

Indirect ventilation

Indirect systems are used when direct system is not possible. There are many indirect ventilation systems as:

- Solar chimney: A solar chimney is a way of improving the natural ventilation of buildings by using convection of air heated by passive solar energy. The solar chimney consists of a black-painted chimney. During the day solar energy heats the chimney and the air within it, creating an updraft of air in the chimney. The suction created at the chimney's base can be used to ventilate and cool the building below. Solar chimneys are particularly effective in climates that are humid and hot. They are most efficient when they are tall and wide, but not very deep.

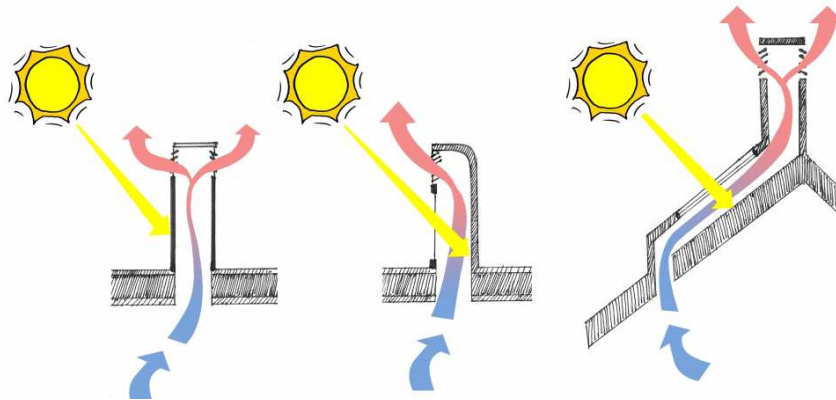

Picture. Solar chimney examples [Ref 08]

- Trombe wall: This system is usually used for heating instead of ventilating but it can be used as well for this purpose. It works based on the difference in density of hot air and cold air, which causes airflows in one or another direction depending on the open flaps. These airflows heat or cool interior spaces by introducing or extracting hot air from the building or rooms where the trombe wall is installed.

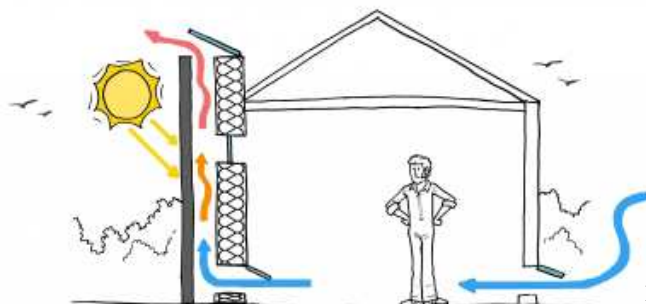

Picture. Trombe wall [Ref 08]

- Venturi effect: Venturi effect is not a ventilation system but a physics principle that can be applied to solve this problem. The Venturi effect is the reduction in fluid pressure that results when a fluid flows through a constricted section (or choke) of a pipe. This means that when the section reduces, wind speed increases. This gives the idea of creating an intermediate air chamber in the roof trough which air will flow. This chamber will have a decreasing section that will help to ventilate thanks to the Venturi effect. With this system, it will be easier to fresh the top part of the building.

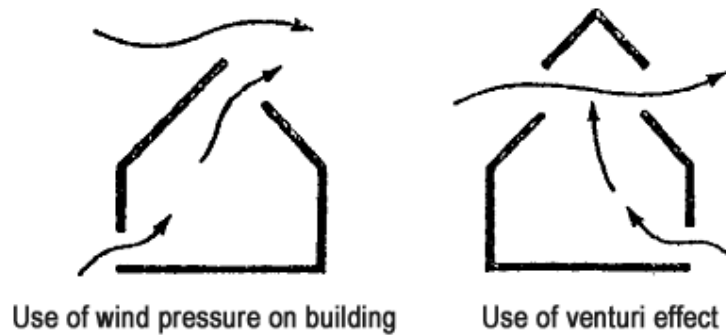

Picture. Venturi Effect explanation [Google images]

1.1.5.6. *Design Proposals*

Proposal 1: Arrange the openings facing each other in the main wind direction to favor the airflow. This measure is the easiest to implement in an open design in which the areas of use are not separated by walls.

In this case, due to the community residential character of the building, it is impossible to carry out this proposal. Users will have individual rooms compartmentalized with a distributor hallway. Due to the existence of so many walls, cross ventilation cannot be included in this design.

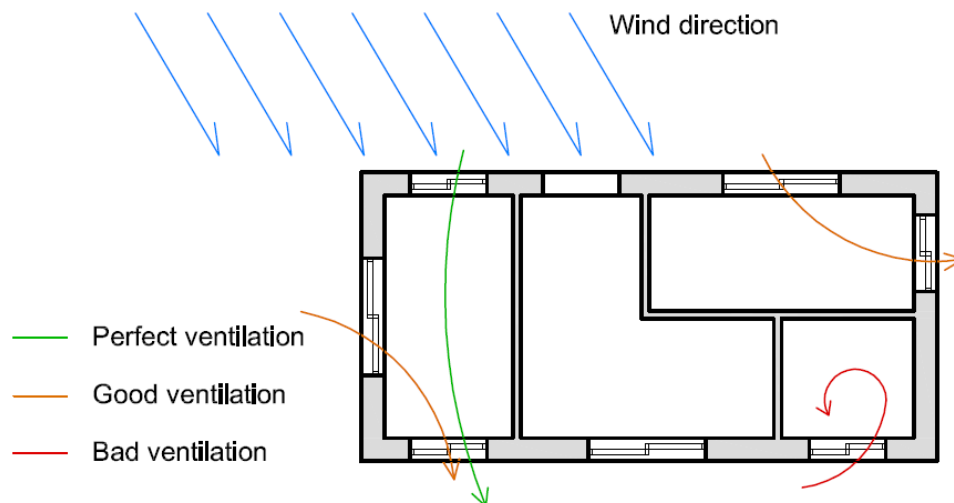

Picture. Cross ventilation [own source]

Proposal 2: Taking advantage of the high incidence of wind in this region, a ventilation system that allows the extraction of hot air through the cover is proposed. This system is based on the idea of solar chimney. This system will need to create a pipe net to extract all the hot air from the rooms and conduct them to the general chimney at one of the edges of the building. The solar chimney has to be as high as possible to favour the difference of temperature between inside and outside air, so convection may be produced.

This solution is environmental friendly because follows the solar passive design principles. Is a solution that does not need energy supplies to work and provides a natural way to solve the problem. But, due to the modular character this project is based on, this solution cannot be carried out. For each module an individual chimney should be build and this will generate a construction problem (chimneys proximity will alter their work, modularity criteria will not be accomplished, etc) and will raise the cost of the entire project.

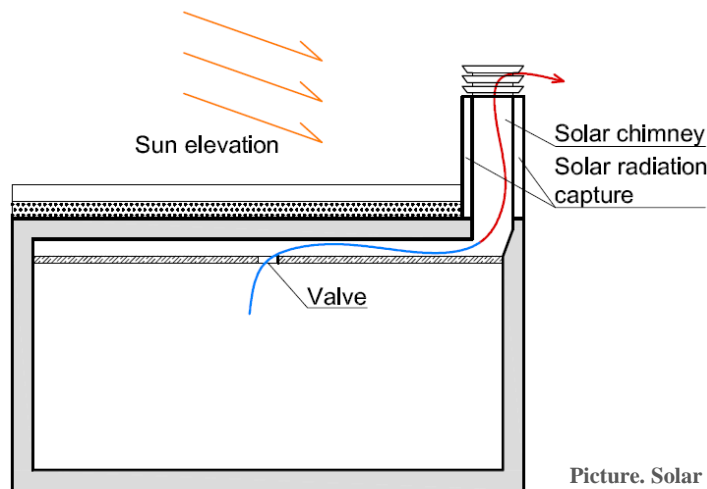

Picture. Solar chimney [own source]

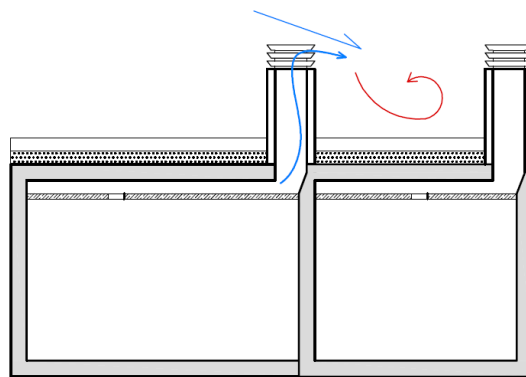

Picture. Solar chimneys interaction [own source]

Proposal 3: Create a trombe wall on the facade. A glass surface or similar will be place over the exterior facade of each room. The main problem of this solution is the need of a thermal mass to capture heat. These masses are very heavy and this may cause a flotability problem. Due to the heating character of this solution, this proposal will be further studied into the Heating section.

Proposal 4: Use the Venturi effect by creating a decreasing section air chamber roof so the airflow increases its speed. Hot air has lower density than cool air, so it tends to accumulate in the ceilings. If a cool air breeze runs through the roof, it will help to cool the upper stocked hot air.

This solution will refresh the room but will not solve the ventilation problem because there is not an air exchange.

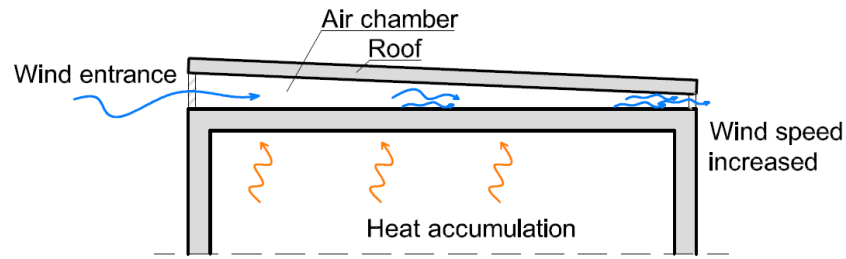

Picture. Venturi effect roof [own source]

Proposal 5: Mix Proposal 2 and Proposal 4. An air chamber will be created in the roof through which wind will flow. At the same time, each room will have a small chimney that will allow interior air to go outside. Wind flow will create a suction of the interior air removing the heat. The ventilation system has two modes of operation, first a continuous cooling system can be used, in which the air enters through the windows or through the aerators incorporated in them and exits to the outside through a valve located in the ceiling of the rooms. On the other hand, it can operate in a conventional way, preserving the same air located inside the house, following a continuous recirculation, and allowing the circulation of hot air through the entire building.

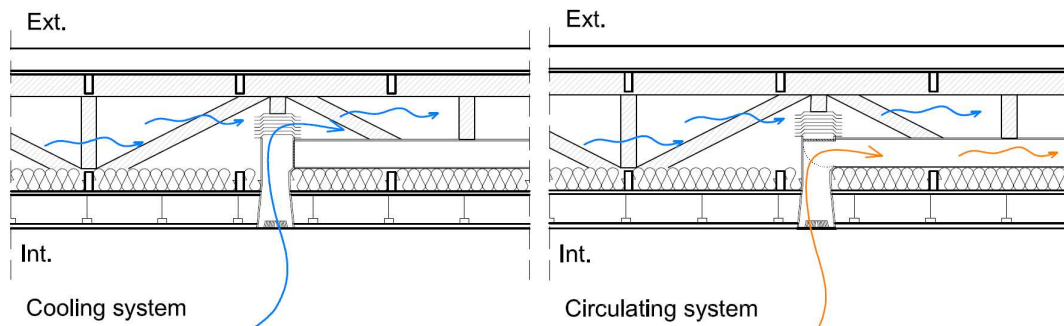

Picture. Proposal 5. Cooling system operation [own source]

Picture. Proposal 5. Circulating system operation [own source]

1.1.5.7. Conclusion

Proper ventilation is a comfort issue that has to be taking into account into the design of every building. In this project will be carried out the solution explained into the Proposal 5. This decision has been taken following the criteria established at the beginning of this chapter. This solution is the best because has two ways of operating, allows refrigeration and ventilation, and heat circulation. Besides, this system is included into the roof and will not create a bad aesthetic impact.

During the design phase the exact solution will be explained, but will follow the explanation contained in this section.

1.1.6. Water reutilization

In April 2017, the total water consumption in the world this year is around 3.390.958 millions of litres. This shocking data gives the idea of searching for new ways of consuming water in a sustainable way. Two strategies have been developed: Rainwater harvesting and Water reutilization.

1.1.6.1. Rainwater harvest

Harvested Rainwater is rainwater that is captured from the roofs of buildings on residential property. Harvested rainwater can be used for water gardens, livestock, irrigation, domestic use with proper treatment, indoor heating for houses etc. Rainwater harvesting can provide around 50 per cent of a family's water needs. This not only saves water, but saves money and reduces our impact on the environment.



The capacity of a rainwater harvesting system depends on the amount of rainfall, size of collection area, storage capacity, and the household's level of demand for water.

Picture. [Google images]

1.1.6.2. Rainfall

To study how much water can be collected from rain, here are some data that will help. The graph for the rainwater shows the average amount of precipitation every month for the last ten years. By collecting water and use it for functions such as toilet, shower and growing, information about the rainfall is important to gather. It is necessary to know how much rainwater can be collected per year; in order to calculate how much more will be needed or how much water will remain. The graph also includes the average humidity level during the years. The ideal humidity level in a unit is between 40% and 60%. The outside humidity is almost always higher than this ideal value. This means that it will be necessary to take measures for the humidity if the outside air is used in the design.

As the graph shows, during autumn (October-January) and May and July rains more than the rest of the year. Designing a proper roof to allow catching all the rain water will be necessary during the design to reduce the amount of water consumption. Choosing the storage tank will be done estimating the storage needed for the lower rain months.

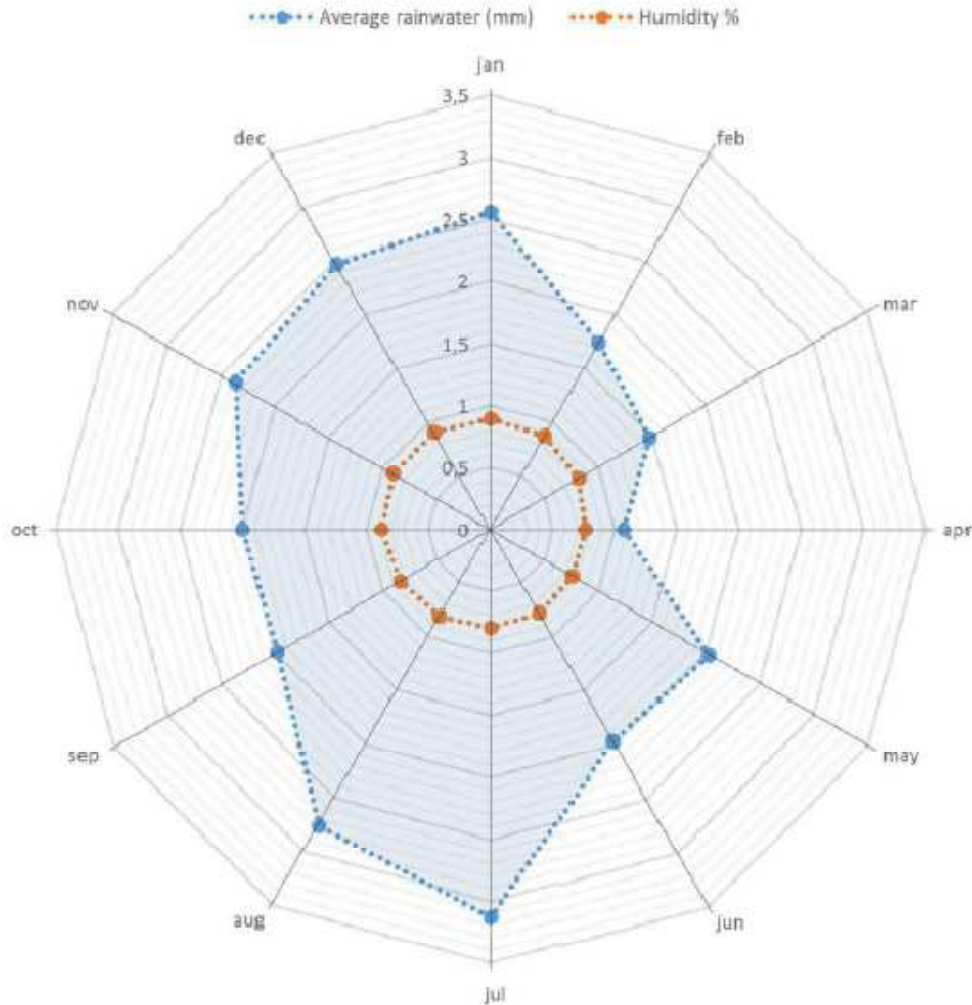

Picture. Average rainwater and Humidity [Ref 01]

1.1.6.3. Collection area

The bigger, the better as it is said. As big is the collection area, much rainwater can be harvested. Depending on the type of roof, other problems may surge:

- Dirtiness. Dead insects, animal's droppings, garbage, pollution or other examples may be found on the surface of the roof and may harm the quality of water.
- Drainage system. Depending on the roof, it can have incorporated an initial drainage system that will avoid bigger depositions to contaminate rainwater.
- Maintenance. Green roofs have more maintenance work that tiles for example. Problems as rodents and pigeons nesting, mosquitoes, algae growth, insects can be present in some roof typologies...

1.1.6.4. Water demand

A conserving household may use 113- 182 litres of water per person per day in Europe. The following graph shows a typical water use by person per day in The Netherlands (data from 2008).

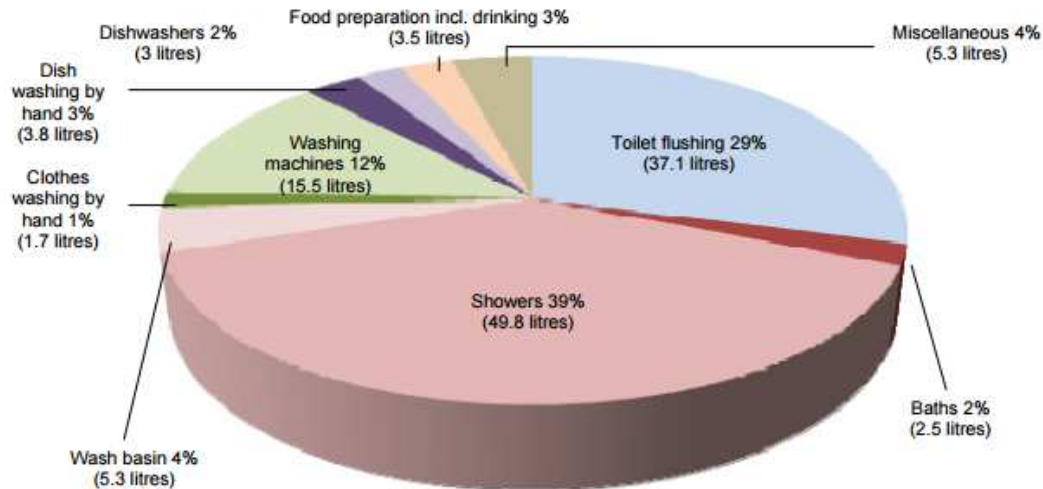

Picture. Water consumption per person per day [Ref 13]

As it can be seen, most of the water consumption is made among showers (39% of the total consumption), toilet (29%) and washing machines (12%).

The Council of European Union established in 1998 the Council Directive 98/83/EC about the quality of water for human consumption. In this regulation is established two interesting point for this research:

- “Water intended for human consumption” concept: all water either in its original state or after treatment, intended for drinking, cooking, food preparation or other domestic purposes, regardless of its origin and whether it is supplied from a distribution network, from a tanker, or in bottles or containers.
- Member States shall take the measures necessary to ensure that water intended for human consumption is wholesome and clean. Water will be considered clean when is free from any micro-organisms and parasites and from any substances which, in numbers or concentrations, constitute a potential danger to human health as it is specified in the Council Directive appendix.

This means that harvested rainwater cannot be used for household purposes, even if it is purified, due to lack of certainty about its purity.

But even though, harvested rainwater can be used for many purposes as allotment gardens, thermal energy storage, car washing, toilet flushing, washing machines and landscape irrigation.

1.1.6.5. Storage capacity

Taking into account the data from above, is easy to estimate an average of 147,50l per person and day as water consumption. But that amount can be divided into purified water and non-purified or reused water as:

Purified	L	Non-purified/reused	L
Bath	2,50	Toilet	37,10
Shower	49,80	Washing machines	15,50
Wash basin	5,30	Heating by water	To determine
Clothes hand-washing	1,70		
Hand dishwashing	3,80		
Food preparation	3,50		
Total	66,60	Total	52,60
	55,87%		44,13%

Making this comparison is easy to see that even using harvested rainwater for toilet flushing and washing machines, the water saved ascends up to almost the half of consumption. In addition water used for wash the dishes and shower/baths can be reused for non purified purposes, also reducing the amount of water needed to catch from rainfall.

For the design of the tank several ideas came up:

- Surface storage: this is the easiest idea to implement, placing a tank on the surface of the house. The tank may be placed in some place that will not damage the daily life as the roof or some place at the kitchen. The main problem with this proposal is that it will occupy much space into a reduced building and that may produce some load problem to the foundation.
- Storage into the foundation: The foundation is made of EPS and concrete. This combination is calculated to support more weight than expected. This gives the opportunity of cut the amount of EPS and creates some space for storing. Not all the foundation block will be needed to be empty, just few ones placed next to the toilet and washing machines.
- Buoyant tank: storing big masses of water may cause a problem of buoyancy at the building. This means that bigger foundation or other measures will be needed. To prevent these problems, an external water tank is considered. This tank will be connected to the building by a flexible pipe and will be floating next to it.

When the rainwater harvesting/water reutilization system is developed, the tank proposal will be determined.

Water tank dimension's estimation:

If water reutilization is taken into account the whole capacity it is estimated a reduction of 35% of rainwater. This reduction is produced from the reutilization of shower/bath and wash the dishes water. The capacity is estimated for a period of 30 days for 8 people:

$$52,60L \text{ per person and day} * 8 \text{ residents} * 30 \text{ days} * 0,65 = 8.205,60L \rightarrow \underline{2 \text{ tanks of } 4200L \text{ each.}}$$

Nowadays the common capacity for many models goes from 500L to 5000L.

1.1.6.6. Rainwater system components

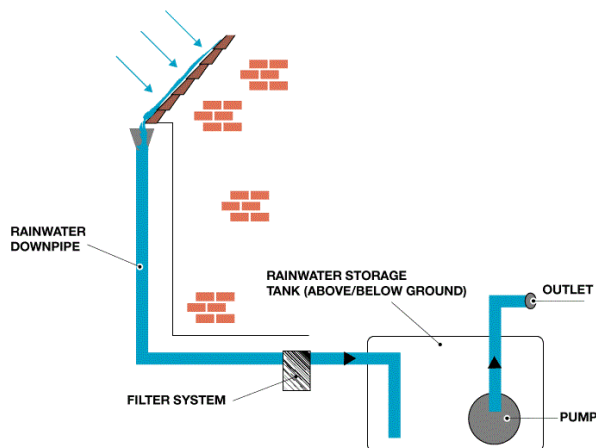

The illustrative design of the basic components of roof top rainwater harvesting system is given in the typical schematic diagram.

Picture. Rainwater harvest diagram [Google images]

The system mainly constitutes of following sub components:

- Catchments
The surface that receives rainfall directly is the catchment of rainwater harvesting system. It may be terrace, courtyard, or paved or unpaved open ground. The terrace may be flat RCC/stone roof or sloping roof.
- Transportation
Rainwater from rooftop should be carried down through water pipes or drains to the storage/harvesting system. Water pipes should be UV resistant (ISI HDPE/PVC pipes) of required capacity. Water from sloping roofs could be caught through gutters and down take pipe.
- Filter
Two filters, one to remove the bigger pollution, sometimes is called pre-filter; and another one for the small pollution.
- Tank
As said at *Storage Capacity* there are many models available at the market. With a quick research on the internet is easy to find many models with different characteristics.

1.1.6.7. Water reutilization

As it has been said before, non-purified water cannot be used for domestic uses. But the water used for those domestic uses can be reused for non-purified water uses as water gardens, car washing, toilet flushing, etc reducing the amount of water needed to harvest.

To achieve this objective, a separate filter and storage system will be needed in terms of cleaning the reused water with more effort. Must be remembered that this water may contain in many cases soap, biological remains, chemical products, etc. The water reutilization system will be very similar to the rainwater harvesting system. After the first use of the harvested rainwater, it will be considered as reused water and will have another treatment in order to be used a second time. After this second chance, the water will be discarded to avoid healthy problems related to the proliferation of bacteria and other organisms that can damage health.

1.1.6.8. Conclusion

Due to the relevance of reducing the amount of water consumed per person and day, rainwater harvesting techniques will be considered into the design of the building.

The design of the roof will take into account the recommendations mentioned below to favour the harvest of rainwater. The components of the system will be analysed and evaluated in detail in a further investigation. Their presence in this report is just to provide a general idea of which elements will be needed for the system.

Implementing the whole design a reduction of almost the half of the consumption will be achieved, improving the sustainability of the building and decreasing the energy bill.

1.1.7. Thermal mass

Air conditioning systems (whether heating, cooling or both) are a focus of importance for bioclimatic architecture because they are typically the most energy consuming systems in buildings. Following the study of passive houses with passive solar designs, the design of the building's envelope has a very important role: it must allow the solar energy to be efficiently used without the use of special mechanisms, such as photovoltaic cells or solar panels.

To ensure the correct design of the envelope, the following basic strategies will be studied:

1. Decrease in energy losses: A passive solar home must be well insulated and sealed, avoiding leaks. By reducing heat losses and gains through the thermal envelope, the remaining heat loads can be effectively managed by passive solar techniques. The points to keep in mind are to include high-performance carpentry, use of high levels of insulation and reduce losses by thermal bridges.
2. Heat Storage: Thermal mass, or heat-storing materials, is an essential part of passive solar design. Constructive elements made of concrete, masonry, or even water can absorb and accumulate heat during sunny days and release it slowly when temperatures drop. This phenomenon reduces the effects of the temperature difference between the exterior and the interior of the house. Although even on bad weather days the sun provides passive heating, long periods of cloudy days often require a reserve heat source. The optimum proportions of thermal mass and glass surface, depending on the climate, can be used to prevent summer overheating and minimize energy consumption.

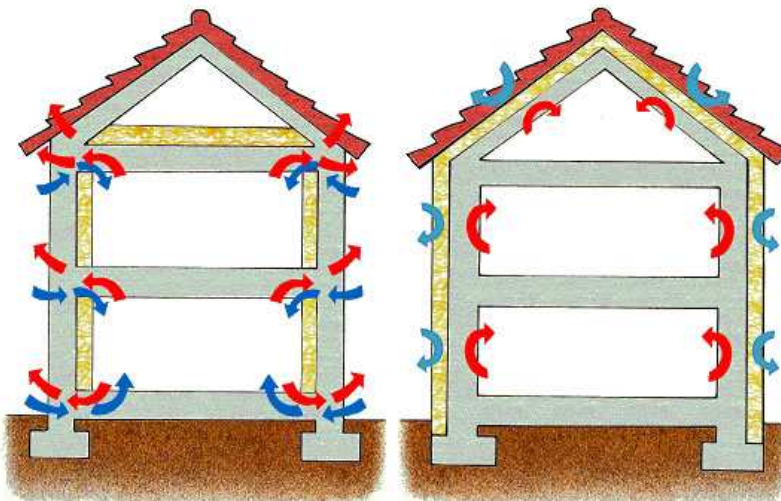

Picture. Thermal bridge house vs. well insulated house [Ref 26]

Buildings designed by passive solar design allow the capture and exchange of heat by the use of building materials that allow the accumulation of heat in its thermal mass, such as concrete, brick masonry, stone, adobe, wall, cement floor or water, among others. This is due to basic physical principles such as conduction, radiation and convection of heat. In addition it is necessary to use a correct thermal insulation to conserve the heat accumulated during the hours of lower temperature.

To minimize heat losses, buildings are designed to be compact. This means that very open, multi-wing or spine-shaped designs should be avoided by preferring more compact and centralized structures.

Windows are used to maximize the entry of light and energy from the sun to the indoor environment while minimizing loss of heat through glass (poor thermal insulation). In the Northern Hemisphere it involves installing larger glazed surfaces to the south, blinding the northern facade to the maximum. This strategy is suitable for very cold climates. In warm to tropical climates, other strategies are used, such as the installation of solar protections that reduce solar uptake during hot seasons. The use of double hermetic glazing reduces heat loss by half, although its cost is significantly higher.

An option to prevent wind action from reducing heat exchange is the planting of evergreens vegetation in those orientations where strong winds prevail.

1.1.7.1. Temperature analysis

In the Orientation section, sun path and elevation have been studied in order to know how much solar radiation the location receives. Wind, sun path and elevation and temperature are significant graph that need to be taken into account into this section. The graphs contain different aspects of the weather patterns. For this section, temperature values are also needed to do a proper analysis.

The temperature graph shows the values for the maximum, minimum and average temperature for a day in the different months for the last ten years.

Since creating the perfect temperature (18 to 21 degrees) inside the house is an important part when building houses nowadays, researching this is useful to find the perfect design for the building. Placing thermal masses or big glass opening in a specific orientation the ideal/most comfortable temperature can be guaranteed.

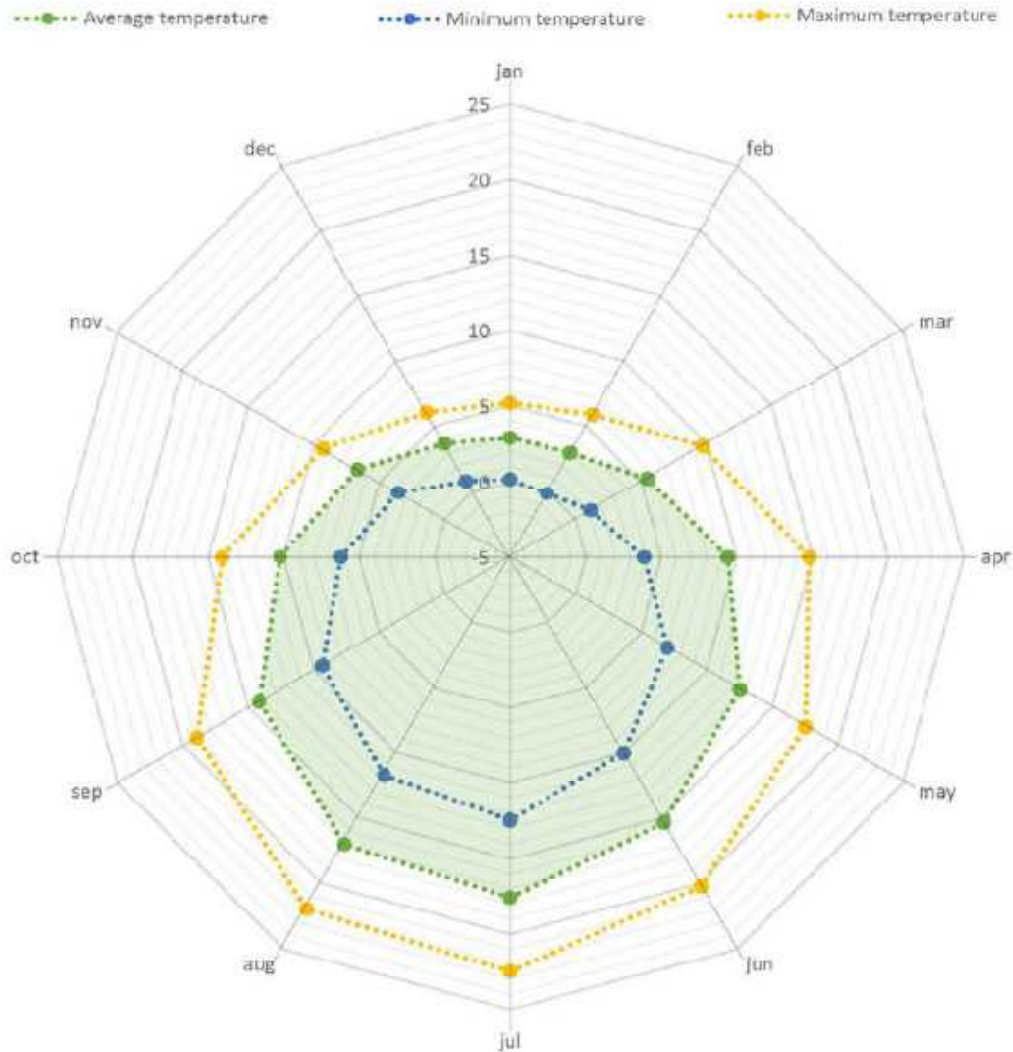

Picture. Average temperature, minimum temperature and maximum temperature [Ref 01]

1.1.7.2. Heat transference

- Conduction: heat moves between two objects that are in direct contact with each other, such as when a sun-heated floor warms your bare feet.
- Convection: heat transfer through a fluid such as air or water, and passive solar homes often use convection to move air from warmer areas into the rest of the house.
- Radiation: emission or transmission of heat in the form of waves or particles through space or through a material. Darker colours absorb more heat than lighter colours, and are a better choice for thermal mass in passive solar homes.

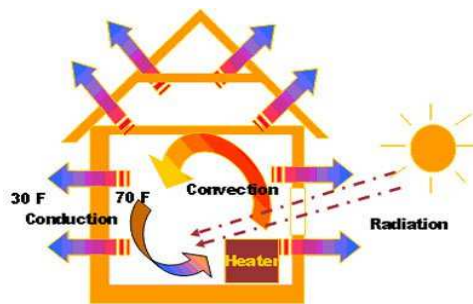

1.1.7.3. Heat gain classification

Here are presented many methods to ensure heat through thermal masses.

Direct gain

Direct gain is the heat from the sun being collected and contained in an occupied space. This heat can be retained by the building's thermal mass, or can be avoided with reflective materials. Sun can be collected through windows and retained by floor thermal masses. These materials then warm people in the room by conducting heat to them directly, by warming air which carries heat by convection, and by reradiating their heat.

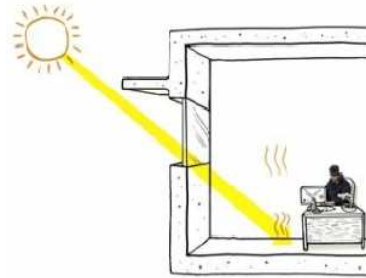

Picture. Direct gain [Re 24]

Non-ventilated accumulation wall

Also known as Wall Trombe, it is a wall built of stone, bricks, concrete or even water painted black or a very dark colour on the outside face. To improve the capture takes advantage of a property of glass that is to generate a greenhouse effect, in which visible light passes through the glass and upon reaching the wall heats it emitting in this process an amount of infrared radiation that is contained by the glass. This is why the temperature of the air chamber between the wall and the glass rises.

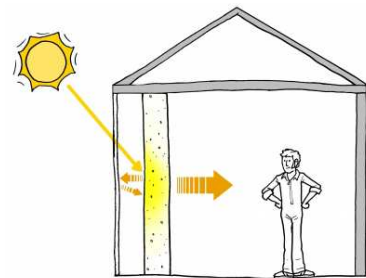

Picture. Non-ventilated wall [Ref 24]

Ventilated accumulation wall

Similar to the previous one but it incorporates orifices in the upper and lower part of the wall to facilitate the transference of heat between the wall and the environment through convection and radiation.

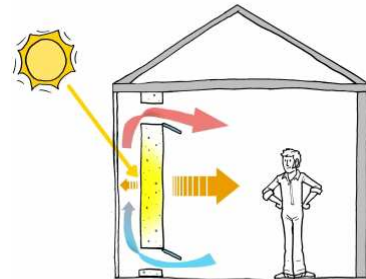

Picture. Ventilated wall [Ref 24]

Attached greenhouse

Consist on glass enclosures built on the south side (for the northern hemisphere and north for the southern hemisphere) of the building. Depending on the weather and the intended use, there may be a separation wall with the inhabited part of the building or other storage. It serves to stabilize the temperature both in the greenhouse and in the house. The temperature inside the greenhouse can suffer great variations between day and night, that is why it is not very useful as a house if a suitable control is not used (some curtains or just an auxiliary heating system). Greenhouses can adopt a wide range of geometric shapes, with four glazed walls (including the roof), or opaque sides. In order to take advantage of the heat energy accumulated in the greenhouse, fans can be installed to drive the air to the interior of the house.

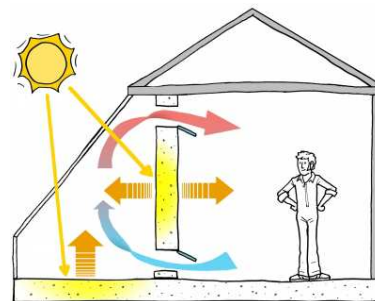

Picture. Greenhouse [Ref 24]

Heat accumulation roof

In certain latitudes it is possible to use the roof surface to capture and accumulate the energy of the sun. Also known as solar ponds require complex mobile devices to prevent the escape of heat during the night.

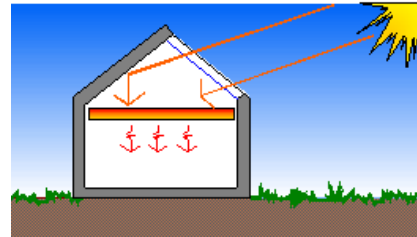

Picture. Accumulation roof [Google images]

Solar collection and heat accumulation

It is a more complex system and allows combining the direct gain by windows with solar collectors of air or hot water to accumulate it under the floor. Similar to the ventilated accumulator wall, the heat is brought to the interior environment. Properly dimensioned allows to accumulate heat for seven or more days.

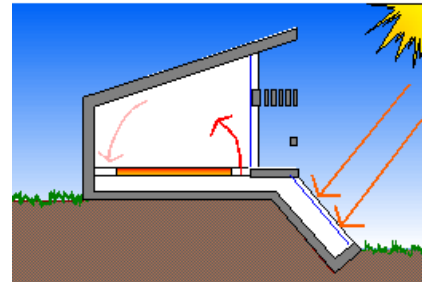

Picture. Solar collection [Google images]

1.1.7.4. Design proposal

Proposal 1: Non-ventilated wall

The implementation of this proposal is not feasible. It requires a wall that can retain heat, which means the creation of walls of high density and weight such as concrete, masonry, cape or water, among others. These walls damage the design of the floating house because they would require more foundation to support their load. Therefore, this solution has been discarded.

Proposal 2: Ventilated wall

This proposal is quite similar to the previous one and has the same problems. The only difference would be the creation of an air chamber with a dark surface that can generate more heat but without retaining any heat. The construction materials for the facade are wood related. They are not good materials for storing heat but are good for isolating. The advantage of this system is that can be used for ventilating as well but the small chamber will not generate as much heat as needed. Because of that, this solution is rejected.

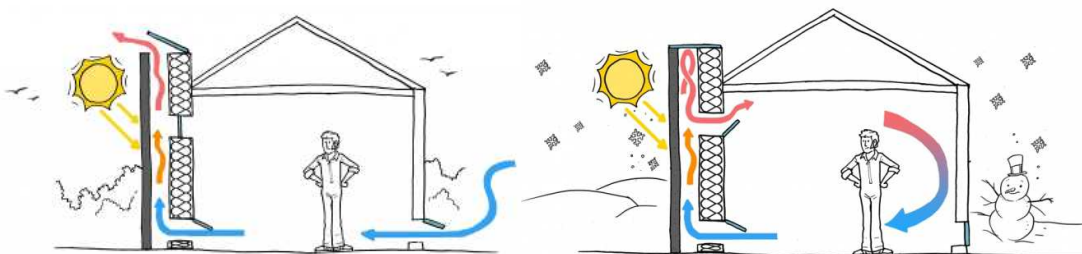

Picture. Trombe wall. Cooling vs Heating [Ref 24]

Proposal 3: Attached greenhouse

Creating a space to gain heat is a good idea. If you add the idea of using that space for other purposes as growing or terrace, it becomes a great idea. The work of this solution is the same as a ventilated wall but with a bigger air chamber.

The design of the building could include a covered terrace that can be used as an attached greenhouse to produce heat. The main problem would be the distribution of that heat through the entire building. An air-heat system with fans or other mechanism has to be installed. The integration of this proposal into the final design will be determined during the design phase.

Proposal 4: Accumulation roof

This proposal may be the best of all. Creating a glass surface on the roof and designing a thermal mass for the ceiling, the heating problem could be solved. The problem to develop this solution is the need to install solar/photovoltaic panels to reduce the electricity/hot water consumption. The installation of those panels will be further studied in other section, but their presence makes the feasibility of this proposal impossible.

Proposal 5: Solar collection and heat accumulation

This system permits a proper heat transfer from below to above (hot air has lower density than cool air and tends to go up). But requires a proper design that cannot be introduced into this project.

The particularity of the floating foundation makes non-viable this proposal. Creating a solar collection chamber on the lowest part of the house becomes impossible on water. And in addition, the chamber under the house should be continuous, damaging the modularity concept this project is based on.

1.1.7.5. Conclusion

Creating a system to generate sustainable heat is essential for a passive house. Air conditioning systems consume bigger amounts of energy and with these methods that consumption can be reduced. Most of the passive solar systems to produce heat are based on the accumulation of that heat in a mass able to free heat during the lowest temperatures hours. That is why incorporating this strategy to the design of a floating house is not a good idea. The criterion of lightness followed in other chapters (materials and foundation) makes these proposals not feasible. This entire section will not be contemplated at the design.

1.4. RESEARCH DATA. SUPPLY SYSTEMS

Even using bioclimatic architecture there are some energy consumptions that cannot be covered in a sustainable way. That is why studying and analysing additional supplies become important. Energy, water, food and waste are the principal supplies that must be researched according to the habits in a building (cook, heat, light, power, water, food production, waste...). Due to the lack of time and following the indications of the Supervisor and the Reader of this project, *waste* and *food* have been eliminated of the research.

In order to create a self sufficient building, the research of the supply system will be carried out to find a sustainable solution and available at the market. Renewable energies are the best option to solve this issue.

1.1.8. Water supply

Water supply is one of the major challenges to be faced. If substantial savings are achieved in water consumption, a more sustainable construction model will be accomplished. To carry out this objective, here there are some strategies to follow:

- Consumption reduction
- Efficient appliances.
- Rainwater and water reutilization

Consumption reduction

Consumption of domestic water can be reduced by using more efficient appliances and by maintenance that prevents accidental water leaks. Reducing this consumption not only saves water, but also saves energy to heat part of it. In non-sanitary uses, the consumption of drinking water can be suppressed if previously treated wastewater is reused. Water supply facilities can be made more sustainable by using more environmentally friendly materials. The simplest and cheapest measure, and what better results will give, possibly is to incorporate plumbing elements into water saving systems. Savings between 30 and 40% can be achieved. Some systems would be:

Faucets	Flow regulator
	Cold opening
	Aerator
	Flow limiter
Shower	Aerator
	Reduction of diffusion area
	Flow limiter
	Flow regulator
	Flow switches
Toilet	Discharge interruption
	Flowcharts /timer
	Electronic discharge
	Discharge interruption

Efficient Appliances

Most of the services that demand water from our homes are appliances, especially dishwashers and washing machines. The market has developed more efficient equipment that can achieve interesting water and energy savings. Appliances must be rated as A or above according to European regulations about Energy Efficiency.

Rainwater and water reutilization

Another option for saving water would be the use of gray and rainwater. This topic has already been discussed in the section on rainwater harvesting and water reutilization.

These strategies will be applied in three important points of this theme: cold water, hot water and heating. These three factors will determine the way water is supplied and if it is possible to reduce its consumption.

1.1.8.1. Cold water

As has been said in the Rainwater harvesting / water reutilization section, a person's daily consumption is more or less 113- 182 liters of water in Europe. Due to European regulations, the consumption of domestic water must come from purified sources that meet the sanitary standards set in these regulations.

Conclusion

Taking into account the distribution of water consumption obtained in the previous section, the domestic water supply would be about 66.60L per person per day. This supply will be made from certified companies that comply with European regulations.

Purified	L	Non-purified/reused	L
Bath	2,50	Toilet	37,10
Shower	49,80	Washing machines	15,50
Wash basin	5,30	Heating by water	To determine
Clothes hand-washing	1,70		
Hand dishwashing	3,80		
Food preparation	3,50		
Total	66,60	Total	52,60
	55,87%		44,13%

Due to the existence of these regulations, the construction of an off-grid house is impossible.

The construction and design of the entire plumbing system is not part of this project due to its complexity. Sustainability, modularity and adaptability criteria must be followed in the further research of this topic.

1.1.8.2. Hot water

For several daily uses the use of hot water is required. To obtain it, a heat source is necessary. Following the principles of sustainability and reduction of the carbon footprint, several ways of obtaining hot water will be studied:

Hot water generation systems

INSTANTANEOUS SYSTEMS:

These are systems that heat water instantly when it is demanded. Its most important disadvantages are the amount of water and energy wasted until the water reaches the desired temperature at the destination, the increasing consumption and the deterioration of the

equipment each time the boiler is switched on and off when there is hot water demand. For homes with low demand this is the ideal system because it saves energy by not having to keep hot water in an accumulator.

Gas boiler

It consists of a coil through which circulates water. Water is heated by a flame located in the lower part and fueled by gas. The gases produced from the combustion are evacuated to the outside by an appropriate conduit.

In order to reduce the diversification of energy and housing supplies, the option of installing a gas boiler has been eliminated. Its installation does not present any significant advantage that will overcome the disadvantages of its installation (new supply, greater contamination, danger of explosion, ...).

Electrical boiler

Smaller size than the gas, the water coil is surrounded by an electric resistance. They do not reach the power of the gas and have the same limitations as gas boilers. In return they do not require being located in a ventilated place.

Pellets heater

There are two types of pellets heater: air heater and water heater. In the case of a water pellet stove, some of the heat is transferred to the room where it is located through an air stream, and another part, most of it, is transferred to the water of a heating circuit that can be connected to (radiators, showers, radiant floor, etc.), so with the same device the whole house can be heated. Logically, water heaters are more powerful, versatile and also more expensive, because they are more complex and have larger components and capacity. The

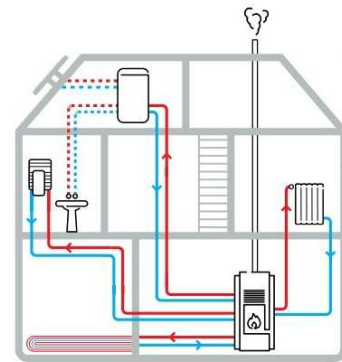

main problem of this solution is that more dirt is generated, they serve for small houses and that it is necessary storage and purchase of the pellets.

Picture. Pellets installation diagram [Google images]

Heatworks

Heatworks company launched in 2014 his first tankless water heater model. Nowadays they have developed their third model. The device is attached to the pipe and heats water instantly. It works on heating water through graphite electrodes that use water as a resistor, increasing its temperature more quickly and less energy consumption. This new systems saves 10% of water and 40% of energy because its ability to



heat water instantly so it is not needed to wait for the cold water to turn hot. It can be used as the main heating system or as a support to improve the current heating system.

Picture. Heatworks Model 1 [Google images]

Hot water heat pumps

Hot water heat pumps are devices that evaporate and condense a refrigerant in a closed circuit in the same way as air conditioning heat pumps do. The great advantage of using heat pumps is that electricity consumption can be reduced by half to heat the water. But its cost is far superior to the electric term. In warm or temperate climates with stable consumption, the heat pump can be amortized in about 3 years. In the same climate, but with irregular consumption, the amortization period rises to 7-8. Instead, for cold climates, your installation may never be cushioned. Therefore, this option has been discarded.

ACCUMULATION SYSTEMS:

In the systems of accumulation the continuous ignitions and shutdowns of the boiler are avoided, since it works of continuous form; Allows to use the hot water simultaneously in two different points; being a centralized system, less power is needed to bring hot water to the set of users and are easily combinable with the systems of solar capture.

Water heating collectors

A solar water heater uses the energy of the sun to heat a liquid, which transfers the heat to a accumulation tank. The panels have a receiving plate and ducts, attached to it, through which liquid flows. This plate is usually covered with a selective layer of black color. The heated liquid is pumped to an energy exchanger apparatus where the heat gives way and then flows back to the panel to be reheated.

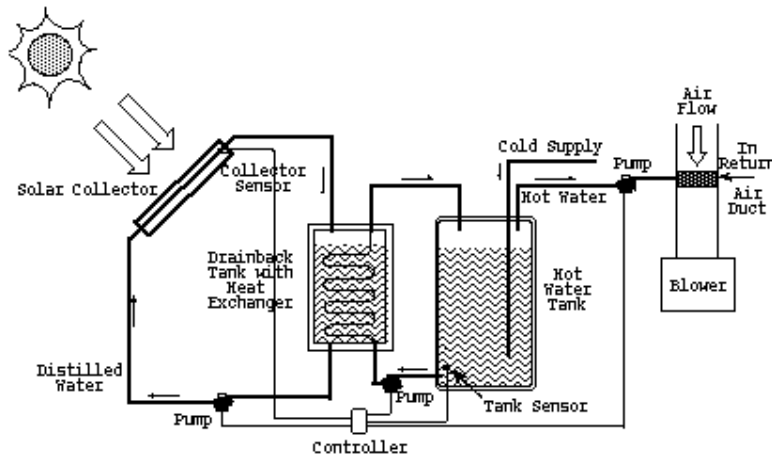

Picture. Water heating collector diagram [Google images]

Hybrid thermal-photovoltaic solar panel:

Hybrid panels for domestic use are a recent innovation. They consist on a concentrator of solar rays that greatly increases the performance of the plates, but this is not its most remarkable feature. What really stands out from these apparatus is that it simultaneously generates heat and electricity, which means that homes can use this resource to produce hot water, heating and electricity. It has two functions:

1. Generate electricity - Photovoltaic cells in the absorber convert part of the solar radiation into electricity just like a conventional solar panel. Its effectiveness is 20% although it varies according to the model.
2. Generate sanitary hot water- To use both as hot water and heating. When solar radiation hits a photovoltaic solar panel, only a small part of it is transformed into electricity. Most of the solar radiation is transformed into heat, just as it happens in any black surface exposed to the sun. The solar concentrator takes advantage of that heat

production of the photovoltaic panel to heat water as if it were a solar thermal collector. This heat, through a suitable hydraulic circuit is evacuated from the panel and stored in a heat-insulated tank for later use.

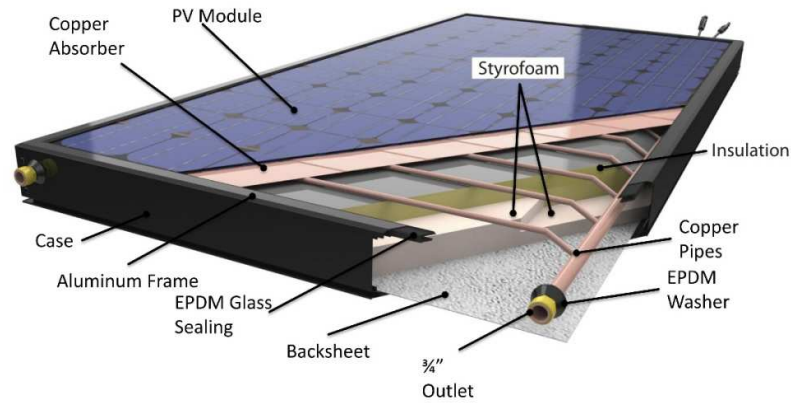

Picture. Hybrid panel cross section [Google images]

MIXED SYSTEMS:

As an alternative to the two most used systems are the mixed type: they combine a certain accumulation of hot water for use throughout the day, but also have an instant production system.

Conclusion

After all this analysis, the system to include in this project is a mixed system. This system will consist on hybrid panel, to take advantage of the sun radiation to heat water; an accumulation tank, to store heated water for a later use; and the instant system develop by Heatworks company. The hybrid panel will provide the primary consumption and the Heatworks system will provide the exceptional consumptions (night, cloudy days,...). The hot water will be stored into the tank for later uses. The construction and design of the entire plumbing system is not part of this project due to its complexity. Sustainability, modularity and adaptability criteria must be followed in the further research of this topic.

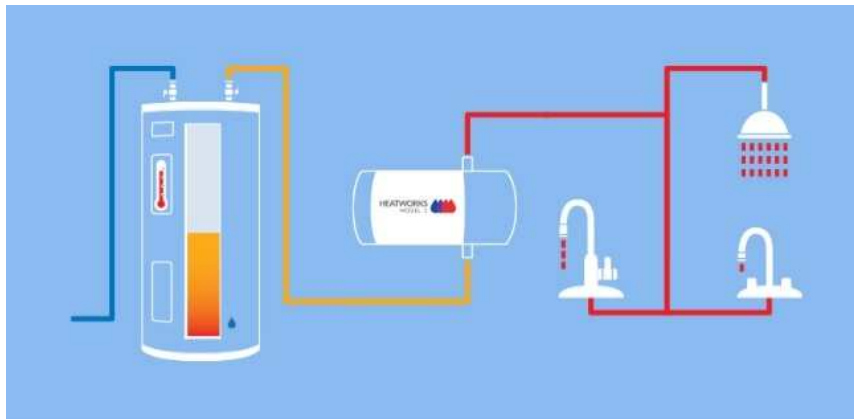

Picture. Diagram of hot water system. The hot water heated by hybrid panels is stored at the accumulation tank. when the temperature at the tank goes down, the Heatworks system heat the water instantly. [Google images]

1.1.8.3. Heating

In cold climates the demand for heating during the winter can be very high. To reduce its demand, the following design criteria will be taken into account:

- Good continuous thermal insulation.
- Adequate sizing of windows.
- Installation of windows with triple glazing of low emissivity and PVC joinery or with rupture of the thermal bridge.
- Opening of windows during the hours of higher temperature during the winter.
- Installation of curtains that retain the interior heat during the hours of lower temperature.

Even so, installing a heating system is necessary. Heating can be done by air or water. In order to reduce the electrical load of the building a water based heating system will be investigated. Water heating systems are so called because they use water as a heat carrier between the generation system and the emitters located in the room to be heated. The hot water generated is transported through a network of pipes.

Distribution Systems

The heated fluid transports the thermal energy from the generator to the emitters through pipes. The set of pipelines with the necessary accessories to make transport effective form the distribution system, which can be:

- Monotubes Radiators or terminal elements connected in series
- Bitubes: Radiators or terminal elements connected in parallel
- Inverted return: The terminal elements return in the same order as they received the outflow pipe. It is intended in this way that all elements have the same length of travel between go and return and therefore the same loss of load. The system is very ingenious and effective when all the terminals are equal and of the same power.

Emission systems

The emitter system is formed by the terminal elements that receive the heat transported and transmit it or exchange it with the ambient air.

- The radiator: Is the most common emitter. It can be of different materials and formats.
- Underfloor heating: This system uses as emitter the floor of a room, whose surface is heated by the transmission of heat from plastic tubes embedded in it and through which hot water circulates from the generation of the system.
- Fan coil: They consist of one or two water batteries and a low pressure fan. They are used more like emitters in air-conditioning to cover the two loads; heating and cooling, but can eventually be used for heating only with a single hot water battery.

Conclusion

From the point of view of comfort, heating with an underfloor heating system gives higher levels of comfort. In short, instead of heating with a very hot spot, as radiators do, heat is distributed equally through the house. It has also been proven that when heated with underfloor heating, temperature of the thermostat can be reduced, maintaining the same level of thermal

comfort and improving air quality, as it will be less dry. During summer, cool water can be circulated through the underfloor system, cooling the whole house.

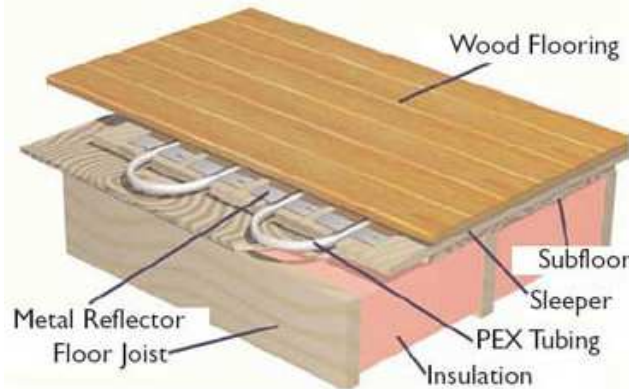

Picture. Underfloor heating cross section [Google images]

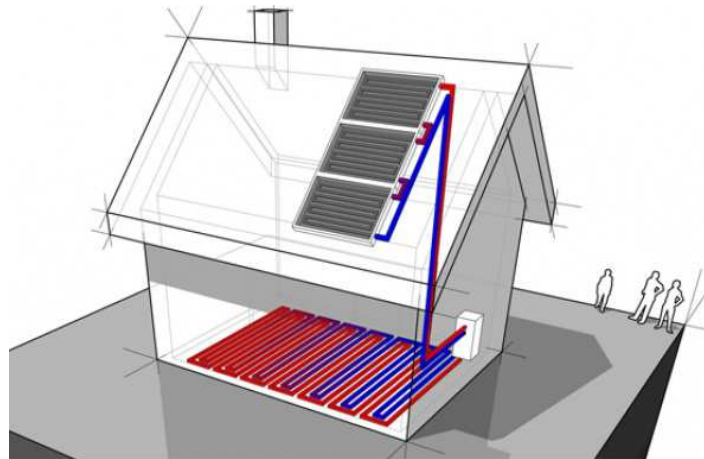

Picture. Underfloor heating + hybrid panels + accumulation tank [Google images]

1.1.9. Electricity supply

Nowadays, the human being needs electricity to live. All their daily actions are conditioned by the consumption of this resource. This project aims to reduce the environmental impact and improve the sustainability of each significant aspect of its design, and obtaining electricity is an important point. The use of renewable energies has become a turning point in our consumption habits. It is for that reason that, following the established indications in the overview of this chapter, a study of the consumption habits and the possibilities of clean energy production will be performed to reduce the energetic consumption in electricity.

Here are some strategies easy to follow that will set the bases for studying:

- Efficient consumption

The habits of a person can significantly influence the consumption of a home. Do not leave lights on, switch off appliances correctly when it is not been used or adjust the power of the

appliances to the needs are some habits easy to adopt and that will significantly reduce wasted electrical consumption (electricity consumed but not used).

- Efficient Appliances

The selection of efficient appliances (category A or higher) greatly helps to reduce electrical consumption. In Europe, all appliances must have a label that expresses their consumption and efficiency. Appliances with grade A +++ are the best rated in relation to consumption/production.

- Free energy

The installation of photovoltaic panels or wind turbines is a free energy source that can be used and included in the design of a home. To include these measures is necessary a study of solar radiation and winds. This analysis has been done in other sections (Orientation and Ventilation respectively), so it is possible to ensure that its installation is adequate.

- Power Storage

After installing panels or wind turbines, it is common to install batteries that store the excess energy during the productive hours to be able to release it during times of greater demand or less possibility of capture.

1.1.9.1. Energy consumption

An estimation of the daily, monthly and annual consumption of a set of habitual household appliances in a conventional house has been made.

All connection power data has been obtained from the product voucher's of the manufacturing companies attached at the end of this Appendix. It has also been considered a reduction of power since these devices do not always work at 100% of their energy demand for the entire time of use.

Likewise, because the use of some appliances is not continued and the probability of a simultaneous consumption is reduced, their real power will be reduced to obtain consumption more in line with reality.

ELECTRICAL APPLIANCE	REAL POWER (W)	REDUCED POWER (W)	HOURS	DAILY CONSUM. (kWh)	MONTH CONSUM. (kWh)	YEAR CONSUM. (kWh)
KITCHEN						
Oven A+	930	600	0,67	0,40	12,06	146,73
Cooktop	4600	1500	1,50	2,25	67,50	821,25
Microwave	1450	750	0,16	0,12	3,60	43,80
Kettle	2750	750	0,40	0,30	9,00	109,50
Toaster	900	600	0,40	0,24	7,20	87,60
Washing machine A+++	-	-	-	0,37	11,25	135,00
Drying machine A+++	-	-	-	0,48	14,67	176,00
Fridge/Freezer A+++	-	-	-	0,43	13,00	156,00
Extractor hood A+	-	-	-	0,10	2,89	34,70
Vacuum cleaner A	-	-	-	0,08	2,33	28,00
LED lights	19	-	4,00	0,08	2,28	27,74
LIVING ROOM						
Television LED A++	-	-	-	0,17	5,17	62,00
LED lights	17	-	4,00	0,07	1,98	24,09

BEDROOM						
Computer/Laptop	37	-	2,00	0,07	2,22	27,01
Cellphone	-	-	-	0,02	0,75	9,00
LED lights (x2)	10	-	4,00	0,04	1,20	14,60
BATHROOM						
Hair dryer	2100	700	0,34	0,24	7,14	86,87
Shaver	2000	700	0,25	0,18	5,25	63,88
LED lights	17	-	4,00	0,07	1,98	24,09
COMMON SPACES						
LED lights	17	-	4,00	0,07	1,98	24,09
TOTAL (kWh)				5,76	173,45	2101,95

Comments on consumption:

- The reflected appliances have been chosen from the experience of the drafters of the project as well as having agreed with the client Michael Bosscher.
- For the estimation of the consumption, have been chosen appliances of high energy efficiency with category A or superior, according to the stipulated by the European regulation.
- LED TV consumes 40% less electricity than plasma or LCD TV.
- LED lighting are simply light bulbs that consume about 7-10 times less than one of incandescence (filament), 1.5-3 times less than those of low consumption, do not contain mercury and last a lot longer.

The data reflected in the table shows that **a person's monthly consumption is around 175kWh**. This data is very useful for the sizing of the electricity installation, the installation of solar collectors and the number of batteries. Extrapolating the data obtained to the total number of people who will live in the building (**8 people** according to the Requirements section), a **daily consumption is around 46kW and a monthly consumption of 1400 kW** is estimated.

In order to ensure a continuous energy supply, sustainable devices will be installed to obtain "free" energy and efficient batteries will be considered to storage the energy generated for times of scarcity.

1.1.9.2. Free energy

As explained at the beginning of this section, the use renewable energy is a substantial energy saving for any home. Some options that can be incorporated into the design are briefly studied and discussed below. For its analysis will take into account all the information exposed in other sections and chapters.

First of all, a brief summary of every renewable energies will be done:

- Solar power: is the conversion of energy from sunlight into electricity or heat through panels.
- Wind power: is the use of air flow through wind turbines to mechanically power generators for electric power.
- Hydropower: is power derived from the energy of falling water or fast running water, which may be harnessed for useful purposes. Due to the buoyancy character of this

project, this option has been rejected as creating a falling water facade may cause problems of stability, weight and will need specific materials to be developed.

- Geothermal energy: uses the heat generated and storage into the Earth to create electricity. The interior of the Earth is hot and the temperature increases with depth, which is why introducing this option into the design is almost impossible.
- Bio energy: consist on getting energy by burning wood or other organic matter. Burning biomass releases carbon emissions, around a quarter higher than burning coal, but has been classed as a "renewable" energy source because plants can be regrown. Due to the sustainability requirement established, biomass will not be studied because the carbon emissions.
- Marine energy: is energy carried by ocean waves, tides, salinity, and ocean temperature differences. The movement of water in the world's oceans creates a vast store of kinetic energy.

Here there are some proposals for each renewable energy studied that may be included into the design.

SOLAR POWER:

Photovoltaic solar panels

Photovoltaic solar energy is the one obtained by means of the direct process of transformation of the energy of the Sun into electrical energy. This transformation is done using a device called solar cell which is mounted on panels. The photovoltaic cells can be monocrystalline or polycrystalline. Monocrystalline cells are formed by a single continuous crystal structure instead of many little crystal particles. These types of cells have higher efficiency rates than polycrystalline, which helps reducing energy consumption.

As already seen in the Orientation section, the use of these cells is not restricted to the form of panels. They can be found in finishing layer of a façade, tiles or in sunscreens. These applications allow to increase the number of installed cells and at the same time reduce the number of panels to be installed (the weight of the installation is reduced).

Hybrid thermal-photovoltaic solar panels

These panels have already been explained in the Water Supply section. In any case, they will be studied and analyzed from the point of view of electric power.

Hybrid panels for domestic use are a recent innovation. They consist on a concentrator of solar rays that greatly increases the performance of the plates, but this is not its most remarkable feature. What really stands out from these apparatus is that it simultaneously generates heat and electricity, which means that homes can use this resource to produce hot water, heating and electricity. It has two functions:

3. Generate electricity - Photovoltaic cells in the absorber convert part of the solar radiation into electricity just like a conventional solar panel. Its effectiveness is 20% although it varies according to the model.
4. Generate sanitary hot water- To use both as hot water and heating. When solar radiation hits a photovoltaic solar panel, only a small part of it is transformed into electricity. Most of the solar radiation is transformed into heat, just as it happens in any black surface exposed to the sun. The solar concentrator takes advantage of that heat production of the photovoltaic panel to heat water as if it were a solar thermal collector. This heat, through a suitable hydraulic circuit is evacuated from the panel and stored in a heat-insulated tank for later use.

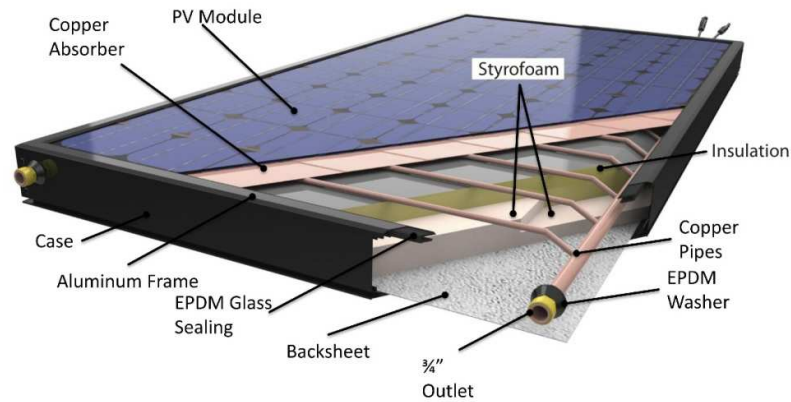

Picture. Hybrid panel cross section [Google images]

Some companies like Ecomesh are improving the properties of hybrid panels with the incorporation of inert gas chambers that improve their performance.

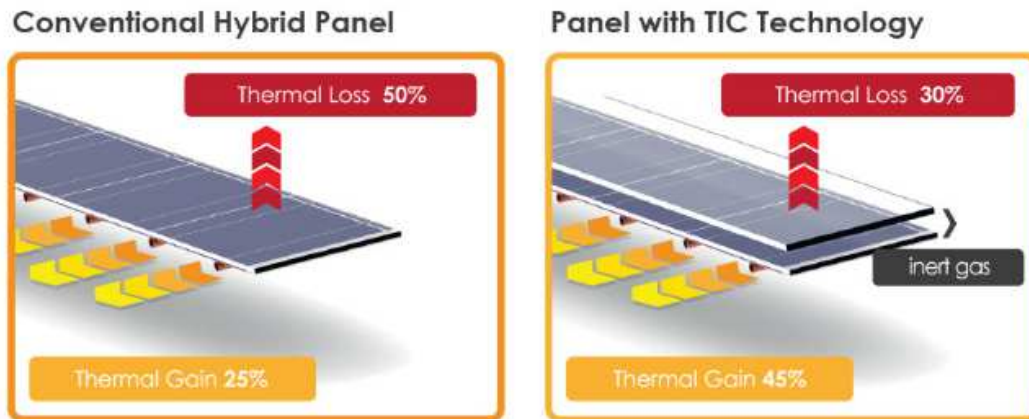

*Values for Standard Test Conditions (STC) (1000 Wm² and 25°C)

Picture. Ecomesh hybrid panel comparison [Ref.41]

For the final design the incorporation of these panels has been taken into account. The total number of panel, its positioning and further design is explained below.

WIND POWER:

Wind turbines

A wind turbine is a device that converts the wind's kinetic energy into electrical power. They are not popular as solar panels but in windy areas, the energy extracted can contribute up to 80% of the consumption or even reach 100% of the electrical needs.

Although the price of domestic wind turbines usually ranges around 3000-6000€ the cheapest ones and up to 20000€ the most expensive ones, it is easy to take advantage of wind power because the energy produced by a wind turbine depends on wind speed elevated to



Picture. Domestic wind turbine [Ref. 40]

the cube (power = wind speed³). But for a detached house it is necessary to install powers between 1 and 4 kW, 10 kW if it is the case of a community of neighbours. Here are some considerations about wind turbines:

- Being in the houses themselves, the electricity generation is very close to the points of consumption, reducing the losses by transportation and distribution.
- They do not require strong winds to start producing energy. The development of this technology has been able to start generating electricity with start speeds of 1 m/s.
- The costs of operation and maintenance are very small due to its simplicity.
- Its smaller size means that its environmental impact is also very small.
- Some higher power turbines can generate noise, vibration and turbulence.
- In an urban environment, the wind is faced with many obstacles (buildings, trees ...), which translates into winds with high turbulences that are transformed into lower production.

The major inconvenience of incorporating this proposal is that the turbulence can be felt with greater incidence in a floating structure and therefore damage the life of the residents. On the other hand the weight of the turbines can cause an increase the depth of the foundation. To prevent those problems, many smaller wind turbines could be installed instead of a bigger one.

MARINE ENERGY

This energy can be used to generate electricity that feeds homes, transportation and industry. The main types are:

- Wave power: energy of the waves.
- Tidal power: energy from moving masses of water.
- Current energy: consists on the use of the kinetic energy contained in the marine currents. The uptake process is based on kinetic energy converters similar to wind turbines using in this case underwater installations for water currents.
- Ocean thermal power: it is based on the use of the thermal energy of the sea based on the difference in temperature between sea surface and deep water. The use of this type of energy requires that the thermal gradient be at least 20°.
- Osmotic power: is the energy of the salinity gradients.

For the specific location of Groningen, this renewable energy cannot be used. There are no waves, tides or currents. The temperature of water is quite equilibrated due to the little depth of canals and something similar occurs to the salinity of the water.

Here are some forecast data of Delfzijl, a harbour city close to Groningen.

Wave Conditions			
Day		Wave Height	Sea Surface Temperature
Tue	 Small waves	0.9 m	13°C
Wed	 Small waves	0.9 m	13°C
Thu	 Calm	0.7 m	13°C
Fri	 Calm	0.6 m	13°C
Sat	 Calm	0.7 m	13°C

Picture. Wave height and Water temperature [Ref. 44]

		High Tide	
		Time	Height
Wed	Tide Set One	11:42 AM	3,45 m
	Tide Set Two	11:58 PM	3,64 m
Thu	Tide Set One	12:34 PM	3,53 m
	Tide Set Two		
Fri	Tide Set One	12:50 AM	3,65 m
	Tide Set Two	01:22 PM	3,58 m

Picture. Tides High [Ref. 44]

As it can be seen, waves have little height, the difference between tides is reduced and the water temperature is always the same. For other locations, marine power may be a sustainable way to obtain power.

1.1.9.3. Calculations

For each proposal, some estimation about number of panels/turbines, power produced and other facts are going to be evaluated. These calculations are merely as orientation, reason why the final design of the electrical installation must be done in later phases and will not be contemplated in this project.

	Power (W/panel)	Hours working (h)	Power produced (Kw)	N° panels needed
Photovoltaic panels	240,00	4,72	1,13	40,68
Hybrid panels	250,00	4,72	1,18	39,05
	Power (kW/h)	Hours working (h)	Power produced (Kw)	N° turbines needed
Wind turbines	0,67	18,00	12,06	3,82

The number of panels has been calculated to generate the electricity needed in a single day for 8 people (46kW).

With this easy estimation some conclusions can be made:

- Wind turbines are the most suitable option to produce electricity. With less number of devices, the same amount of power can be generated. Wind turbines can produce energy during day and night.
- Hybrid panels are better option than photovoltaic panels. They both produce almost the same amount of electricity, but hybrid panel heat water in addition.

1.1.9.4. Energy storage

Continuing with the design of self sufficient house, it will be necessary, since it is intended to build an off-grid house, to supply the building on days when the two systems of electricity generation cannot function.

Since it is very rare that there is not solar radiation and wind flow are not able to run the wind turbine systems, it is established the case that the power generation system will be able to store energy in batteries that meet the demands for at least 3 days.

This battery system will also cover the peak demands of electricity during the night. These electric demands are usually much smaller and will always have the wind turbine system which, if the wind allows it, will be able to cover the demand and store the electrical energy in the battery system.

There are several market proposals about batteries but the most famous one is the Powerwall developed by Tesla Inc. This battery has an inverter included, so it will not be necessary to install another one. As part of the electricity installation and, having in mind that will be installed generators, it is necessary to have an inverter. The inverter converts the variable direct current (DC) output of a photovoltaic solar panel or wind turbine into a utility frequency alternating current (AC) that can be fed into a commercial electrical grid or used by a local, off-grid electrical network.



Picture. Powerwall [Ref. 43]

A single Powerwall can storage up to 13,50kWh. In this case 10 Powerwalls will be needed to cover the requirement of 3 days without any electricity production. Those batteries can be placed at the air chamber of the roof or into some foundation blocks.

1.1.9.5. Conclusion

Reducing the consumption of electricity must be the principal concern of every building. By reducing its consumption and losses, costs can be cut, the environmental impact can be decreased and the carbon footprint can be reduced. By using renewable energy and integrating them into the design, creating an off-grid house is one step closer to achieve.

To accomplish all these objectives, a design proposal has been developed:

Taking into account the need for heating water, a mixed system of hybrid panels and wind turbines will be developed. 24 hybrid panel placed in two rows would produce up to 28,32kW per day. The rest can be covered by 2 wind turbines that would produce 24,12kW. The total amount of electricity would be around 52,44kW. The idea of placing two wind turbines is to prevent the lack of electricity during cloudy days. During those days, storage energy will be needed.

The design of a proper installation and the selection of every and each device is reserved for an intense further design and do not will be done in this project.

1.5.SUMMARY

As a summary of all the investigation carried out, here there are the main ideas and conclusions achieved. All these ideas will be developed into the final design.

BIOCLIMATIC ARCHITECTURE	
Orientation	Best orientation to the South (maximum deviation 30°). Bigger windows to the South. Smaller to the North. Use protection over windows.
Solar Protection	Eaves are easy to incorporate to the design. Each eave length will be determined into the design phase. Windows will be placed aligned to the inner sheet of the facade.
Ventilation	Space sectorization. Windows high should reach the ceiling. Windows must incorporate micro-openings. A double sheet roof will be created following Proposal 5.
Water reutilization	Catch rainwater for non-purified uses. Use reused water as well. Create separated systems for rainwater and reused water (filters and tanks mostly). Create an external floating tank.
Thermal mass	Dismiss strategy due to big weight load.
SUPPLY SYSTEMS	
Water supply	Cold water: off-grid building is not permitted. A connection to the network is mandatory. Hot water: mixed system has been chosen. Hybrid panel + Heatworks + accumulation tank. Heating: electricity and air heating have been dismissed. Reused water can be used for this purpose. An underfloor system will be developed.
Electricity supply	Reduce losses by changing habits. Use renewable energy and efficient appliances. Mixed system: 24 hybrid panels + 2 wind turbines.

Appendix J

Questionnaires

In following pages, reader can see the answers of random potential users of the house. In addition to the client's requirements, the answers will set the standards of the house, measures, facilities and overall reaction to the house.

As seen in the overall of responses below, almost % of the students asked, would live on a floating home. This shows that the idea of creating floating houses for students might work since there are people willing to live on them. Also, the second one shows that if the rent price is not increased, there is a will of becoming more sustainable. Both answers meet the client's idea and strengthens the point of creating houses for students in the water areas of the city.

Going through the design criteria. The size of the building was determined by the following questions. People are not willing to share facilities with more than 7 residents and around 60 % of people would share room. Due to this, authors decided to create the house with two double bedrooms ($X \text{ m}^3$) and two single rooms ($X \text{ m}^3$). Toilets are shared 3 people each. Also, a significant amount of responses show that people would like a common room to socialize with their house mates. That is why individual rooms are quite big thinking about the people who rather a bigger room but also, there is a common room. Seems that most people would agree with the proposed design and almost all kind of responses are taken into account. In the distribution map, reader can see graphically how those answers were taken into consideration and how the responses meet the design.

Going to the energy consumption question, shows again that most people are willing to change their habits to be more sustainable. Again, the client's idea is strengthened by the will to improve.

Questionnaire about sustainable floating houses for students

63 responses

Would you like living on a floating home? (63 responses)

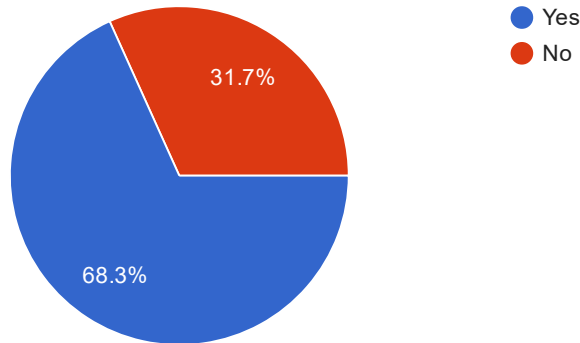

Would you like to live on a sustainable house paying the same rent you pay now (more respectful to the environment)?

(63 responses)

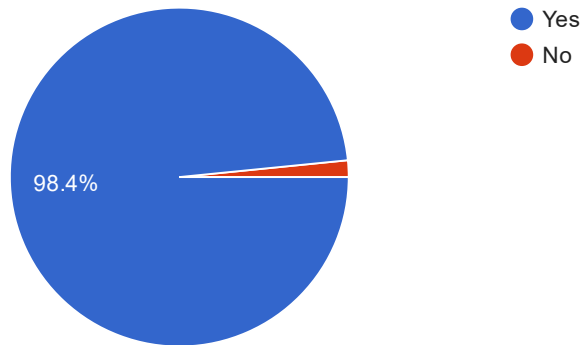

With how many people would you mind to share kitchen? (63 responses)

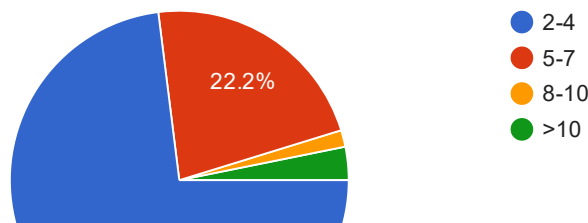

With how many people would you mind to share showers? (63 responses)

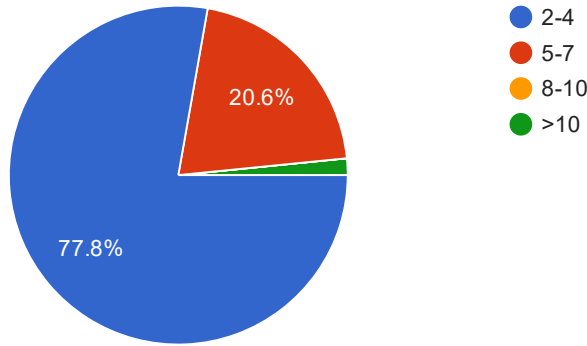

With how many people would you mind to share toilets? (63 responses)

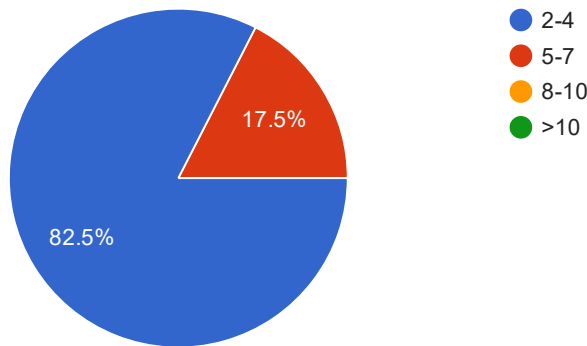

Would you mind to share room if the price went down? (63 responses)

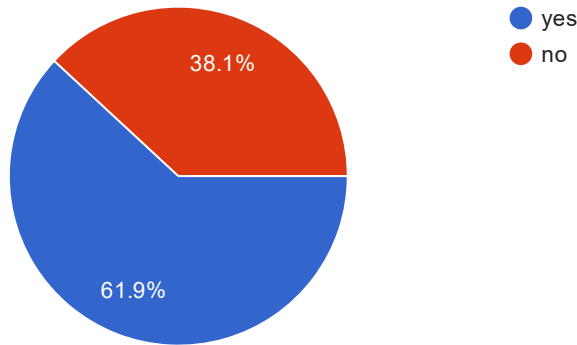

Based on your previous answer, how big would you like your room to be? (63 responses)

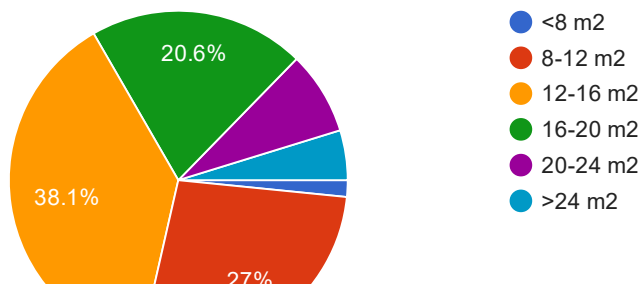



Would you prefer a bigger room or a shared common room? (63 responses)

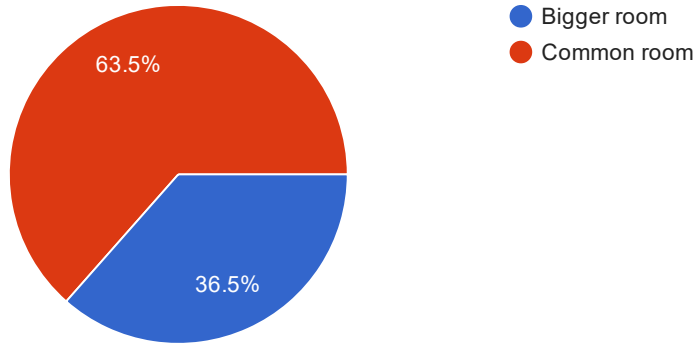

Would you carry out actions to reduce the energy consumption?

(63 responses)

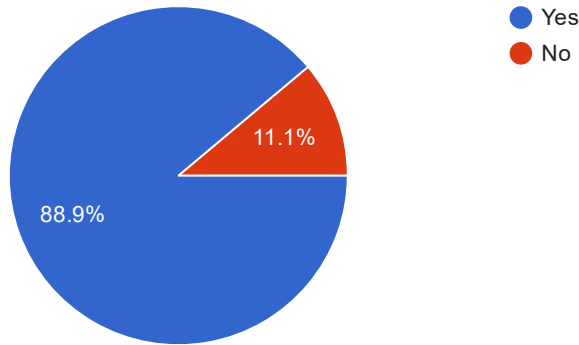

What do you consider more important? (63 responses)

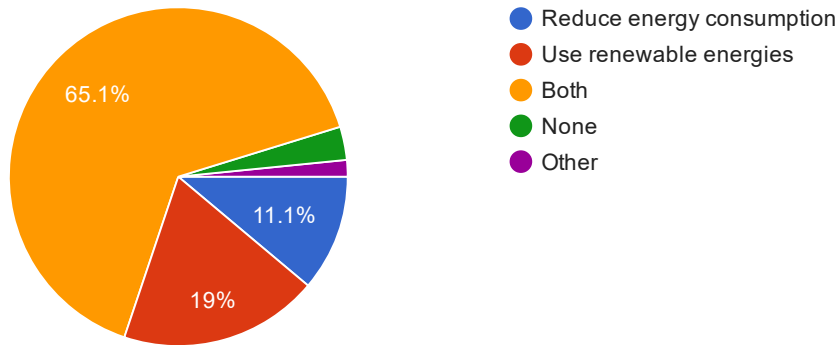

Would you like to separate waste? (63 responses)

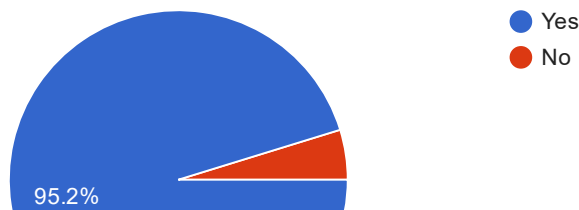



Taking into account your responses, how much would you pay per month according to the market in Groningen

(63 responses)

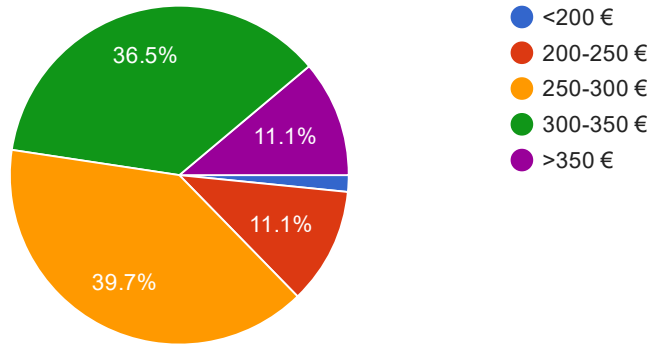

Number of daily responses

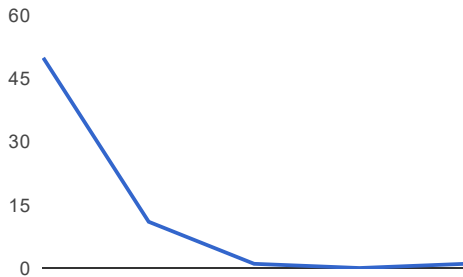

This content is neither created nor endorsed by Google. Report Abuse - Terms of Service - Additional Terms



Appendix K

Emails Marinetek

As a part of the research process, a floating structures company was consulted, the emails written are in the following pages. The proper order to read them is from the bottom to the top. What author wanted to obtain was the way of constructing a pontoon made out of blocks. Despite being slightly different than this project, some ideas could be considered. Also, the details of the unions were useful to find out how block construction are done currently. Considering this response plus all other data researched, author came up with its own design.

RE: floating structures

Jussi Boman <Jussi.Boman@marinetek.net>

Wed 05/04/2017 16:20

To: Gironés Cádiz I, Ignasi <i.girones.cadiz@st.hanze.nl>;

Hi Ignasi,

With the floating structures we have usually used the steel structure that I mentioned in previous mail to connect the pontoons together. The main benefit with that solution is that the building is easy to place on top of that frame. Also the forces from the buildings weight are we going thru the steel frame to the pontoon and then we can be sure that the forces will be located on the correct locations of the pontoon.

I'm aware of the cable fixings and I'm sure that it's also one potential solution but we haven't used it that much. I have heard that cable might become longer with time. We prefer to use long threaded bars for similar pontoon fixing. The threaded bars are going thru the pontoons and between the pontoons we have plastic or rubber blocks. Below is a couple of drawings to explain this.

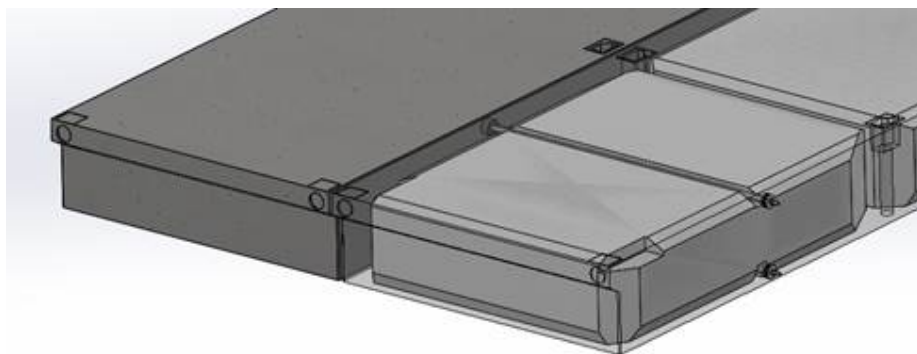
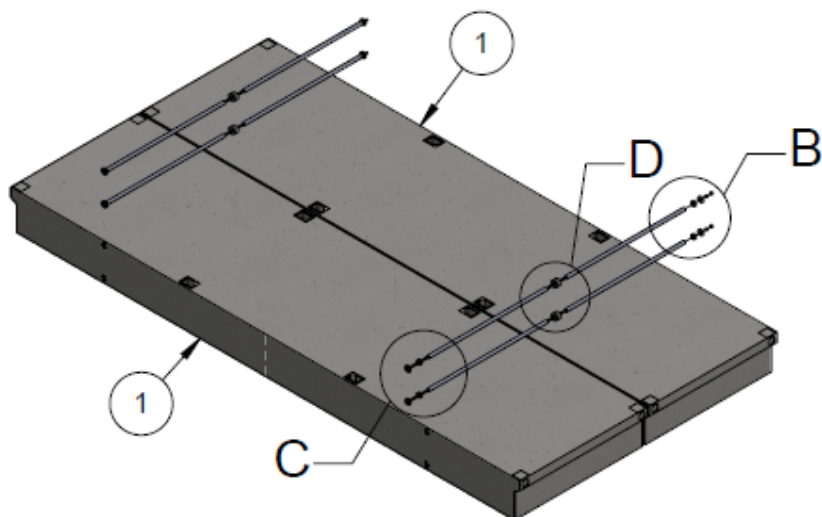

Good luck with your thesis!

BR, Jussi

From: Gironés Cádiz I, Ignasi [mailto:i.girones.cadiz@st.hanze.nl]
Sent: 5. huhtikuuta 2017 14:56
To: Jussi Boman
Subject: Re: floating structures

Dear Jussi,

Thank you for your kind reply and your explanations. I am aware of the existence of Bluet but I wanted to contact you because I am curious about how you unite the different parts and also, to shed light from a different angle. In my case, one of the requirements is the modularity, in other words, the client wants us to create a foundation for homes as it was a "Lego" construction, blocks that can be easily connected into bigger forms. One of the key points is obviously the unions between parts, hence I wanted to ask you how you proceed from a single block to the creation of pontoons.

As I have spotted in your website <http://marinetek.net/blog/products/pontoons/all-concrete/> you have EPS-concrete blocks and you anchor them, I would like to know whether you recommend or not the use of a perimeter pre-stressed cable to tight all parts together in addition to the unions between blocks. I have already some ideas by myself but I would like to compare to what you do to see if it is feasible or not, in any case I intend to copy any existing solution.

I would like to remark that my interests are purely academic since I have found some trouble when trying to access to detailed information.

Thank you again for your time,

Kind regards

Ignasi Gironés

[All-Concrete Pontoons - Marinetek](http://marinetek.net)

marinetek.net

For boat mooring and general purpose use. Marinetek All-Concrete represent the latest know-how in pontoon technology and are the most widely used structural concrete ...

From: Jussi Boman <Jussi.Boman@marinetek.net>
Sent: 03 April 2017 11:06:40
To: Gironés Cádiz I, Ignasi
Subject: RE: floating structures

Dear Ignasi,

Thank you for contacting us!

Our main products are concrete pontoons and therefore we're mainly using those as foundation of the floating houses. We use basically our standard marina pontoons for the floating houses. Our pontoons are made of steel reinforced concrete and EPS. From here you get more information of our concrete pontoons:

<http://marinetek.net/products/pontoons/>. Normally we connect pontoons side by side with steel frame on top of the pontoons and the house will be on top of that steel frame. Pumps etc. can be installed inside the pontoons. Below is an example drawing for this kind of a platform and attached is a few pictures to get better understanding of this structure.

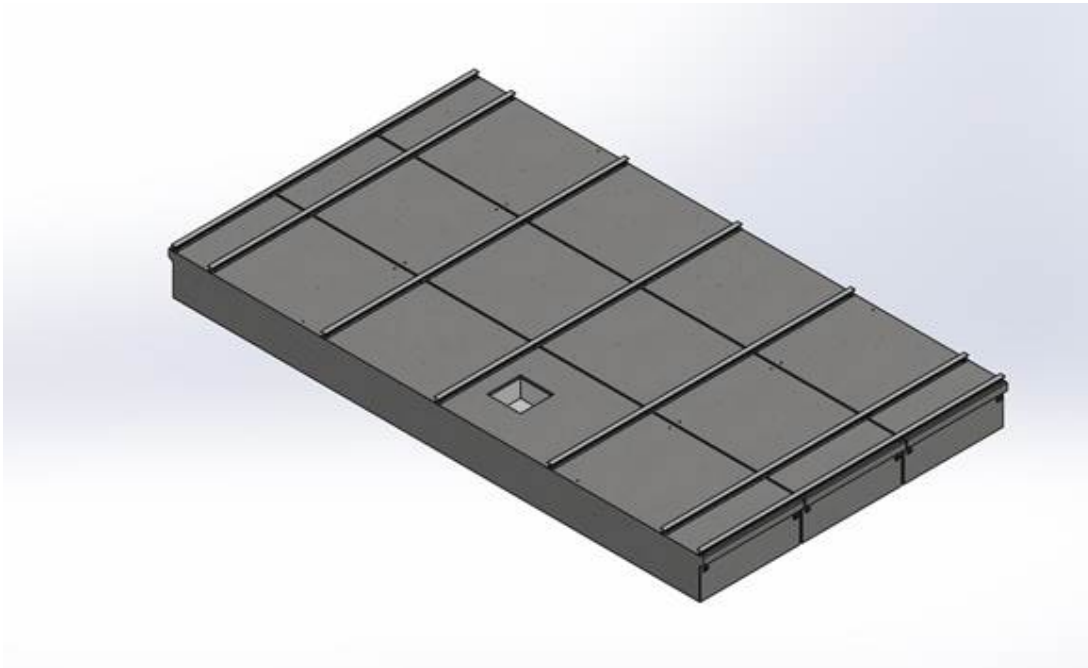

The most important things with the platform designing are the buildings weight and the center of gravity. We also need to know live loads etc. to be sure that the house floats in balance.

Marinetek is focusing more to Marinas and just to the platforms of the floating solutions but if you're interested more about the structures on top of the pontoon you could contact our partner company Bluet ([www.bluet.fi]www.bluet.fi). Bluet is specialized in floating construction solutions.

Hopefully this short answer helps you and don't hesitate to contact me if you have further questions!

Terveisin / Best regards,

Jussi Boman

Team Leader of Design and Engineering
Marinetek Finland Oy

Mob +358 50 368 5163

Tel +358 9 682 4100

Fax +358 9 682 41030

Skype jussi_boman

MARINETEK 

Vattuniemenkatu 3
00210 Helsinki
Finland

[marinetek.fi]marinetek.fi

[marinetek.net]marinetek.net

From: Info

Sent: 31. maaliskuuta 2017 13:40

To: Jussi Boman

Subject: FW: floating structures

From: Gironés Cádiz I, Ignasi [<mailto:i.girones.cadiz@st.hanze.nl>]

Sent: 30 March 2017 13:28

To: Info

Subject: floating structures

Dear Sir or Madam,

I am a Spanish student of Bsc in civil engineering currently doing my final thesis about floating buildings, more specifically, about the foundations of a floating house for students in Groningen (Netherlands)

As I have spotted in your website, you provide services and solutions regarding this topic. Nowadays I am doing research about different materials and solutions that can be implemented in the foundation. As I have researched, most foundations are made out of concrete or plastic hull and EPS. Since sustainability is one of the main criteria by the client, I would like to ask you what kind of measures do you implement and if you use a different material or procedure more sustainable that can be implemented.

All in all, if you could tell me a little bit about how do you design the foundation and if you apply the criteria of sustainability I would be more than grateful.

I understand that you might not give me confidential information but I would like to remark that my interests are purely academic.

Best wishes,

Ignasi Gironés

Appendix L

Minutes of Meeting

Minutes of meeting

Date: February 12th, 2017

Time: 11:30

Room: Water lab

Present:

Ignasi Girones

Jorge Forés

Andrea Morant

Absent:

-

Welcome

Let's keep the spirits high and work hard for making a good project plan, a good project plan will make things easier.

What did we do?

- Project Planning (ready)
- Scope (ready)
- Background information
- Gathering data

How is it going?

Good.

What is planned?

Project plan and set scope

Questions for coaching 6-12-2016

- 2.1: Stakeholders
- 3: How to obtain data regarding sustainability

Minutes of meeting

Date: February 27th, 2017

Time: 13:00

Room: Water lab

Present:

Ignasi Girones

Jorge Forés

Andrea Morant

Absent:

-

Welcome

Last week we had feedback and coaching session. We work hard every day, we are up to date with our plan. What is more we have few days to spare if something goes wrong.

What did we do?

- Add more stakeholders, correct mistakes from previous week, add more information according to the advice of teacher
- Research of materials
- Choose of alternatives
- First drawings and calculations

How is it going?

Everyone researching what to do and project plan is done

What is planned?

Prepare exposition of project plan and keep going

Questions for coaching 13-12-2016

- None

Minutes of meeting

Date: March 20th, 2017

Time: 12:00

Room: Water lab

Present:

Ignasi Girones

Jorge Forés

Andrea Morant

Absent:

-

Welcome

Last week we had feedback, project plan exposition and coaching session. After asking a lot of questions, we solved our problems. We work hard every day, we are up to date with our plan.

What did we do?

- Finding current technologies
- Start writing about materials
- Propose options for everything
- Calculate alternatives

How is it going?

A bit more delayed than the expected but fine

What is planned?

Working individually on our separate parts, according to the statement of requirements.

Minutes of meeting

Date: April 10th, 2017

Time: 12:00

Room: Water lab

Present:

Ignasi Girones

Jorge Forés

Andrea Morant

Absent:

-

What did we do?

- Email experts on the topic and consult innovative research
- Working on the selected alternative

How is it going?

We are happy we've completed some major things, everyone has its alternative selected and we just need to write down everything

What is planned?

Finish calculations, drawings, and start thinking about the layout of the project, how to interact different parts. We had to change some stuff to make all parts equal.

Minutes of meeting

Date: May 8th, 2017

Time: 12:00

Room: Water lab

Present:

Ignasi Girones

Jorge Forés

Andrea Morant

Absent:

-

Welcome

Working on the final details of the project.

What did we do?

- Put everything together,
- Look for inconsistencies

How is it going?

It is quite well going. Finding a good solution was not very easy and took some time, but now we think we have a good alternative. Still need a way to calculate details of some parts

What is planned?

Find a common solution and see if all competencies are fulfilled

Questions for coaching 04-05-2017

- Are the calculations properly done?

Minutes of meeting

Date: May 20th, 2017

Time: 12:00

Room: Water lab

Present:

Ignasi Girones

Jorge Forés

Andrea Morant

Absent:

-

Welcome

Everyone is done on the individual parts, now we are writing the main report and common parts. Last week we have did a lot of things and delivered good work. Fortunately we did not had to change our idea again so we made good progress. The coming week we will try finish the project on Wednesday.

What did we do?

- Interact with other members of the team
- Storage
- Transmittance
- Method Statement
- Planning for the final issues

How is it going?

Almost done, we are a bit worried about the competencies because we have never done it, but with the help of our reader and supervisor we are making it work. It is going good. All motivated to finish fast because it is a pretty hard project and we have had a lot of changes during the project. The different parts we are working on, make all good progress and are leading to an end.

What is planned?

- Layout in LaTeX
- Put everything together
- Look through it to find inconsistencies
- Give for final feedback

Questions

-

Appendix M

Bibliography & References

LIST OF REFERENCES AND BIBLIOGRAPHY

FOUNDATIONS

- {<http://www.dictionary.com/browse/floatability>
- Rubenstein, 2012, Emissions from cement industry, State of the planet, <http://blogs.ei.columbia.edu/2012/05/09/emissions-from-the-cement-industry/>
- Block, unknown year, Expanded polystyrene, Plastics Europe, <http://www.plasticseurope.org/what-is-plastic/types-of-plastics-11148/expanded-polystyrene.aspx>
- Ascione, 2015, Common metals in the construction industry, Continental steel & tube company <https://metalspecialist.continentalsteel.com/blog/common-metals-in-the-construction-industry>
- Blackwell, 2016, Bioplastics and the construction industry, Barbour product search, <https://www.barbourproductsearch.info/bioplastics-and-the-construction-industry-blog000278.html>
- Unknown, 2013, Bioplastic advances innovative, green architecture, Polymer solutions, <https://www.polymersolutions.com/blog/bioplastic-advances-innovative-green-architecture/> · All concrete pontoons Marinetek <http://marinetek.net/blog/products/pontoons/all-concrete/> · Floating homes <http://www.floatinghomes.ltd.uk/floating-foundations.html> · Flexbase <http://www.flexbase.eu/en/projects/> · Wittenberg, 2008, Floating houses, bBuild, <http://blog.buildllc.com/2008/07/floating-houses/> · Amphibious housing <http://amphibioushomes.weebly.com/current-use.html>
- Unknown, 2014, Green building materials, Cal recycle, <http://www.calrecycle.ca.gov/greenbuilding/materials/>
- Happold, 2012, Sustainable materials, Designing buildings https://www.designingbuildings.co.uk/wiki/Sustainable_materials
- Unknown, unknown year, Moulding polystyrene, BPF, http://www.bpf.co.uk/Plastipedia/Processes/Moulding_EPS.aspx
- Ponce, unknown, La matriz de Leopold para el impacto ambiental, http://ponce.sdsu.edu/la_matriz_de_leopold.html
- Ministerio de Fomento, 2015, Código Técnico de Edificación, Ministerio de fomento, <https://www.codigotecnico.org/> · bouwbesluit, 2012, <http://www.bouwbesluitonline.nl/>
- Sjunnesson, 2005, Life assessment of concrete, Lund University, <http://lup.lub.lu.se/luur/download?func=downloadFile&recordOid=4468239&fileOid=4469176>
- Mattson, 2012, Life cycle impact assessment-a study of the EPS method for use within SCA, Chalmers University of Technology <http://publications.lib.chalmers.se/records/fulltext/168240/168240.pdf>
- Widman, unknown year, Experiences from life cycle assessment on steel and concrete composite bridges, The Swedish Institute of Steel Construction (SBI), Stockholm, Sweden and Lulea University of Technology, Dept of Steel Structures, Lulea, Sweden <http://www.irbnet.de/daten/iconda/CIB8517.pdf>

MATERIALS

- a) Materiales sostenibles en la edificación (*Sustainable building materials*), Mamen Miñan Arenas 2012
<https://riunet.upv.es/bitstream/handle/10251/17708/TESI-Materiales%20sostenibles%20en%20la%20edificaci%C3%B3n.%20Residuos%20de%20C.pdf?sequence=1>
- b) Materiales de construcción sostenible (*Sustainable building materials*)
http://www.construmatica.com/construpedia/Materiales_de_Construcci%C3%B3n_Sostenibles
- c) Guía de materiales para la construcción sostenible (*Guide to materials for sustainable construction*)
https://www.google.nl/url?sa=t&rct=j&q=&esrc=s&source=web&cd=3&ved=0ahUKEwjn_6_j76rSAhVBB8AKHUL5Bc0QFggsMAI&url=https%3A%2F%2Fwww.coatmu.es%2Fdescarga.php%3Fdocumento%3Dfd1332504912.pdf&usg=AFQjCNG_MKTCFhLRtXOiuJSEt1YvLCCg&sig2=gQzX7beLZn-BVNrIcMMdrw
- d) Arquitectura sostenible, ¿Que materials usa? (*Sustainable architecture, what materials does it use?*)
<http://www.sostenibilidad.com/materiales-sostenibles-construccion>
- e) La construcción sostenible (*Sustainable construction*)
<http://habitat.aq.upm.es/boletin/n4/apala.html>
- f) Materials de construcción sostenibles (*Sustainable building materials*)
http://www.eoi.es/wiki/index.php/MATERIALES_DE_CONSTRUCCI%C3%93N_SOSTENIBLES_en_Construcci%C3%B3n_sostenible
- g) Guía básica de la sostenibilidad en la edificación (*Basic guide to sustainability in building*)
https://www.google.nl/url?sa=t&rct=j&q=&esrc=s&source=web&cd=10&ved=0ahUKEUwjn_6_j76rSAhVBB8AKHUL5Bc0QFghaMAk&url=https%3A%2F%2Fupcommons.upc.edu%2Fbitstream%2Fhandle%2F2099.1%2F12146%2FMem%25C3%25B2ria.pdf&usg=AFQjCNHtSRjhGY9SeuTJZaForhECX3YBSA&sig2=Rsj6r6PbaW7IWdWX4o1E5Q
- h) Transmitancia (*Transmittance*)
https://es.wikipedia.org/wiki/Transmitancia_t%C3%A9rmica
- i) Cerramientos sostenibles (*Sustainable enclosures*)
http://www.construmatica.com/construpedia/Cerramientos_Sostenibles
- j) 10. Arquitectura y construcción sostenibles (*Sustainable architecture and construction*)
http://www.interempresas.net/Cerramientos_y_ventanas/Articulos/45078-Arquitectura-y-construccion-sostenibles.html
- k) Productos y técnicas sostenibles (*Sustainable Products and Techniques*)
<http://www.tecnicas-sostenibles.es/183>
- l) Sistemas constructivos sostenibles (*Sustainable building systems*)
http://www.construmatica.com/construpedia/Sistemas_Constructivos_Sostenibles
- m) Tabla de transmitancias térmicas de cada material (*Table of thermal transmittance of each material*)
<https://beyondsustainablearchitecture.files.wordpress.com/2013/08/cuadro-comparativo-de-aislamiento-termico-vegetales.jpg>
- n) Productos aislantes de madera (*Wood insulation products*)
<http://www.biohaus.es/productos/gutex.php>
- o) Aislamientos térmicos de origen vegetal (*Thermal insulation of vegetable origin*)
<https://beyondsustainable.net/2013/11/13/los-aislamientos-termicos-de-origen-vegetal/>
- p) La vivienda sostenible (*Sustainable housing*), Beatriz Santa-Cruz Hellín (2014)
- q) Bioconstrucción y arquitectura bioclimática para la ejecución de vivienda ecológica unifamiliar (*Bioconstruction and bioclimatic architecture for the execution of ecological single-family housing*), Héctor Ortiz Arnau (2016)
- r) Materiales sostenibles para la edificación (*Sustainable materials for building*), Alejandro Ortega Villar (2015)

- s) Vivienda tradicional VS vivienda sostenible (*Traditional housing VS sustainable housing*), Doniel Bohigues Vallet (2011)
- t) Materiales para Arquitectura Sostenible. Participación de los materiales en la Sostenibilidad (*Materials for Sustainable Architecture. Participation of materials in Sustainability*), Claudio Bordini
- u) Bioclimatismo y su aplicación a fachadas (Bioclimatism and its application to facades), Ampar Martínez Sanz (2014)
- v) Estudio y análisis de cerramientos de alta eficiencia energética (Study and analysis of enclosures of high energy efficiency), Escarlata Lucas Navalón (2011)

SUPPLY SYSTEMS:

1. Síscar, M., Udemá, F., Janssen, D. (2016) Orientation Study. Sustainable Cities (2016-17). Sunshine, radiation, wind climate data.
2. Energy.gov, Energy Saver. Passive Solar Home Design (2017).
<https://energy.gov/energysaver/passive-solar-home-design>
3. Wikipedia. Passive Solar Building Design (2017).
https://en.wikipedia.org/wiki/Passive_solar_building_design
4. SunEarthTools. Sun position (2009-2017).
https://www.sunearthtools.com/dp/tools/pos_sun.php?lang=en
5. Tamiluz, Arquitectura solar. Products. Spain.
http://www.tamiluz.es/productos/EN-adjustable-louvres-shutters-brise_soleil-blade-sunshades-fixed.html
6. Tamiluz, Arquitectura solar. Catalog. (Spain)
<http://www.tamiluz.es/catalogo-general/#53/z>
7. Colt. Products (2017).
<http://www.colt.es/productos-protecci%C3%B3n-solar.html>
http://www.colt.es/tl_files/pdf/Miscellaneous/Solar%20Shading/Shadoglass%20and%20Shadovoltaic%20solar%20shading%20systems.pdf
8. Autodesk Sustainability Workshops. Natural ventilation (2011-2015).
<https://sustainabilityworkshop.autodesk.com/buildings/stack-ventilation-and-bernoullis-principle>
9. Wikipedia. Solar Chimney (2017).
https://en.wikipedia.org/wiki/Solar_chimney
10. Wikipedia. Trombe wall (2017).
https://en.wikipedia.org/wiki/Trombe_wall
11. Wikipedia. Venturi effect (2017).
https://en.wikipedia.org/wiki/Venturi_effect
12. Síscar, M., Udemá, F., Janssen, D. (2016) Orientation Study. Sustainable Cities (2016-17). Rain water climate data.
13. International comparisons of domestic per capita consumption. Environment Agency by Aquaterra (2008).
<http://webarchive.nationalarchives.gov.uk/20140328084622/http://cdn.environment-agency.gov.uk/geho0809bqtd-e-e.pdf>
14. Worldometer. Water consumption statistics (2017).
<http://www.worldometers.info/water/>
15. Dr.ir. J.A.M.H. Hofman, Dr.ir. M. Paalman.(2014) Rainwater harvesting, a sustainable solution for urban climate adaptation?
<http://edepot.wur.nl/345625>
16. Council Directive 98/83/EC of 3 November 1998 on the quality of water intended for human consumption
<http://eur-lex.europa.eu/legal-content/ES/TXT/?uri=celex%3A31998L0083>
17. Homepower. Home efficiency, Design and Construction (1987-2017).
<https://www.homepower.com/articles/home-efficiency/design-construction/well-water-rainwater?v=print>
18. Morant Chiva,A., Lu,L., Li, Q., Bonnema, R., Immink, H. (2016) Report case for floating house. Sustainable Cities (2016-17).
19. García, J., Van der Molen, K., Vos, M., Koster, R. (2016) Autarkic student house. Sustainable Cities (2016-17).

20. Síscar, M., Udema, F., Janssen, D. (2016) Orientation Study. Sustainable Cities (2016-17). Temperature climate data.
21. Energy.gov, Energy Saver. Passive Solar Home Design.
<https://energy.gov/energysaver/passive-solar-home-design>
22. Wikipedia. Passive Solar Building Design (2017).
https://en.wikipedia.org/wiki/Passive_solar_building_design
23. Passive Solar Design (2017).
<http://passivesolar.sustainable-sources.com/>
24. Autodesk Sustainability Workshops. Passive heating (2011-2015).
<https://sustainabilityworkshop.autodesk.com/buildings/trombe-wall-and-attached-sunspace>
25. Wikipedia. Trombe wall (2017).
https://en.wikipedia.org/wiki/Trombe_wall
26. Mariano Bueno. Proyecto RECONSOST (2017).
<http://www.mariano-bueno.com/2010/12/03/449/>
27. Fundación ecología y desarrollo. Guía práctica de tecnologías ahorradoras de agua para viviendas y servicios públicos. ISBN: 978-84-88949-46-2.
28. Sitio solar. Portal de energías renovables (2013).
<http://www.sitiosolar.com/panel-solar-hibrido-termico-y-fotovoltaico/>
29. PhD Chemisana Villegas, D. Diseño y caracterización de un concentrador térmico-fotovoltaico cuasi estacionario para integración arquitectónica.
30. DanSolar. Hybrid solar panel (2017).
<http://dansolar.dk/en/hybrid-solar-panel/>
31. M. A. Gálvez Huerta (2013). Instalaciones y Servicios Técnicos. Madrid: Sección de Instalaciones de Edificios.
32. Gizmodo. Este pequeño aparato calienta, al instante, el agua de cualquier grifo.
<http://es.gizmodo.com/este-pequeno-aparato-calienta-al-instante-el-agua-de-1517645964>
33. Energy.gov, Energy Saver. Water heating.
<https://energy.gov/energysaver/water-heating>
34. DanSolar. Hybrid solar panel (2017).
<http://dansolar.dk/en/hybrid-solar-panel/>
35. Wikipedia. Photovoltaic thermal hybrid solar collector (2017).
https://en.wikipedia.org/wiki/Photovoltaic_thermal_hybrid_solar_collector
36. Wikipedia. Wind turbine (2017).
https://en.wikipedia.org/wiki/Wind_turbine
37. Twenergy. Energía eólica (2017).
<https://twenergy.com/a/aerogeneradores-domesticos-1807>
38. Torres, F. Cómo he adaptado mi casa para pagar menos electricidad. Moviendo cubos (2017).
http://moviendocubos.com/2017/he-adaptado-casa-pagar-menos-electricidad/#Aprovechar_la_energia_gratuita
39. Varinia. ¿Cuánto cuesta una instalación mini-eólica doméstica? Varinia.es (2008)
<http://varinia.es/blog/2008/09/21/%C2%BFcuanto-cuesta-una-instalacion-mini-eolica-domestica/>
40. Ecomesh. Panel ecomesh (2017).
<http://ecomesh.es/ecomesh/>
41. Dualsun. Products (2017).

- <https://dualsun.fr/en/product/2-in-1-solar/>
<https://dualsun.fr/wp-content/uploads/DualSun-EN-Datasheet.pdf>
42. Semtive. Residential (2017).
<https://semtive.com/residential/>
43. Tesla. Energy. Powerwall (2017)
<https://www.tesla.com/powerwall>
44. MyForecast. Marine reports (2017)
<http://www.myforecast.com/bin/tide.m?city=71130&metric=true&tideLocationID=T5088>
45. Wikipedia. Renewable energy (017).
https://en.wikipedia.org/wiki/Renewable_energy

Energy consumption: appliances vouchers

46. Beko: Tumble Dryers (007-2017). Turkey.
<http://www.beko.co.uk/8kg-tumble-dryer-dph8756>
47. Balay: Electrodomésticos, Lavadoras. Spain.
<http://www.balay.es/catalogo-electrodomesticos/lavadoras/libre-instalacion/3TS986X?breadcrumb=freestandingwashingmachines>
48. Balay: Electrodomésticos, Frigoríficos. Spain.
<http://www.balay.es/catalogo-electrodomesticos/frigorificos-y-congeladores/combinados/libre-instalacion/3KSP6865?breadcrumb=bottomfreezers>
49. Balay: Electrodomésticos, Campanas. Spain.
<http://www.balay.es/catalogo-electrodomesticos/campanas-extractoras/decorativas-pared/3BC897XMA?breadcrumb=wallchimneyhoods>
50. Balay: Electrodomésticos, Placas inducción. Spain.
<http://www.balay.es/catalogo-electrodomesticos/placas/inducccion/3EB865MQ?breadcrumb=induction>
51. AEG: Kitchen, Cooking, Oven.
<http://www.aeg.co.uk/kitchen/cooking/ovens/>
52. El Corte Inglés: Electrodomésticos, Aspiradoras (1947-2017). Spain.
<https://www.elcorteingles.es/electrodomesticos/A19085419-aspirador-hoover-reactiv-rc25-con-sistema-ciclonico-y-tobera-para-mascotas/>
53. LG: Appliances, Microwaves (2009-2017).
<http://www.lg.com/uk/support/support-product/lg-MH7042X>
54. Bosch: Home appliances, Toaster (2017).
<http://www.bosch-home.co.uk/products/kettles-toasters/toasters/TAT8613GB.html#tab4>
55. Bosh: Home appliances, Kettle (2017).
<http://www.bosch-home.co.uk/products/kettles-toasters/kettles/TWK7601GB.html#tab4>
- LG. TV/Audio/Video. TVs.LED TVs (2009-2017).
<http://www.lg.com/us/tvs/lg-49LJ5100-led-tv>
56. Asus. Products. Laptops (2017).
<https://www.asus.com/Laptops/X555QG/specifications/>
57. Xataka. Mviles(2017).
<https://www.xataka.com/moviles/no-imaginas-el-dinero-que-te-cuesta-cargar-el-smartphone>
58. Babylliss. Dryers (2017).
<https://www.babylliss.co.uk/dryers/salonlight-2100-red.html>

59. Remington. Productos cuidado masculine. Cortapelo (2017).

<http://es.remington-europe.com/hombre/cuidado-masculino/cortapelos/precisioncut-precision-steel-hair-clipper-hc5300.html>

MODULARITY

60. Diseño modular (*Modular design*)
https://es.wikipedia.org/wiki/Dise%C3%B1o_modular
61. N1 Diseño modular
<http://disenomodular.com/>
62. Vitale loft, arquitectura modular
<http://www.vitaleloft.com/arquitectura-modular-en-vitale-loft/>
63. Modular home
<http://www.modularhome.es/casas-prefabricadas/dise%C3%B1o/>
64. Pinterest
<https://es.pinterest.com/explore/casas-prefabricadas-de-dise%C3%B1o-948237735435/>
65. Arquitectura modular (*Modular architecture*)
https://es.wikipedia.org/wiki/Arquitectura_modular
66. Arquitectura modular (*Modular architecture*)
<http://www.arkiplus.com/arquitectura-modular>
67. ABCmodular
<http://abcmodular.com/>
68. Arquitectura modular ¿Por que elegirla?, (*Modular architecture, Why choose it?*)
<http://www.agi-architectsblog.com/arquitectura-modular-por-que-elegirla/>
69. Apiltec modular
<http://www.apiltec.es/ventajas-arquitectura-modular/>