



Tesis Doctoral

Diseño y caracterización de sensores para la medida de parámetros químicos y biológicos mediante *Organic Thin-Film Transistors*



UNIVERSITAT
POLITÈCNICA
DE VALÈNCIA

Presentada por Clara Pérez Fuster

Dirigida por:

Dr. D. Eduardo Garcia Breijo

Dra. Dña. Laura Contat Rodrigo

Valencia, diciembre 2018



UNIVERSITAT
POLITÈCNICA
DE VALÈNCIA

Diseño y caracterización de sensores para la medida de parámetros químicos y biológicos mediante *Organic Thin-Film Transistors*

Tesis Doctoral:

Presentada por Clara Pérez Fuster

Dirigida por:

Dr. D. Eduardo Garcia Breijo

Dra. Dña. Laura Contat Rodrigo

Valencia, diciembre 2018

AGRADECIMIENTOS

Quisiera expresar lo que siento llegado este momento de depositar esta tesis, pero es muy difícil de describir, solo las personas que me conocen saben que ha sido un deseo que siempre me acompañaba y parecía imposible de conseguir. La satisfacción que me produce haber logrado que esta meta sea hoy una realidad se la debo a muchas personas. Destacar sin duda a mis directores Eduardo García y Laura Contat, cada uno a su manera me ha ayudado, animado y no han permitido que tirará la toalla. Agradecer personalmente a Eduardo su paciencia y la confianza que depositó en mi cuando hablamos por primera vez y me propuso esta línea de investigación que finalmente ha dado su fruto.

Por otro lado, y no menos importante ha sido la gran ayuda que me ha dado José Vicente, que fue quién me introdujo en el grupo de investigación *ged+ps* (group of electronic development and printed sensors). Siempre ha estado a mi lado demostrando una gran generosidad al ayudarme sin dudar preparando nuevos transistores, arreglando el equipo y disponible siempre, haciendo fácil lo difícil. También quiero decir que todos los miembros del grupo me han hecho sentir como una más y me han animado hasta el final.

También quiero agradecer a Paula García, que fuesen más amenas todas las tardes que compartimos en el laboratorio realizando experimentos.

A los integrantes del Lab. 2.6 del IDM, así como las colaboraciones puntuales con diferentes grupos de investigación, que me han prestado sus instalaciones y equipos; así como su ayuda en la preparación de las sustancias utilizadas en los experimentos y la realización de medidas paralelas con otras técnicas homologadas para validar los resultados. Dichas colaboraciones puntuales han sido: con el departamento de Tecnología de alimentos de la UPV, en concreto con el profesor Dr. Raúl Grau Meló y con la Dra. Berta Gómez-Lor del Instituto de Ciencia de Materiales de Madrid del *Consejo Superior de Investigaciones Científicas*. El trabajo desarrollado en los artículos ha sido posible gracias a los distintos proyectos de investigación de financiación pública dentro del marco de proyectos del Ministerio de Educación y Ciencia del Gobierno de España/Fondos FEDER (grant number MAT2015-64139-C4-3-R (MINECO/FEDER)) y Fondos de la Generalitat Valenciana (grant number AICO/2015/103).

Finalmente quiero dedicarles esta tesis a mis hijos; gracias a su ayuda, sus palabras de ánimo y su ilusión he conseguido mantener la llama que me ha dado fuerzas para seguir hasta el final, y a todos los que, aunque ya no están, siempre me han creído capaz de conseguir las metas que me propusiera.

RESUMEN

La **Electrónica Orgánica** ha experimentado un gran avance en las últimas décadas, desde que en los años 70 se descubrieran los polímeros conductores. Las características únicas de los semiconductores orgánicos, han permitido el desarrollo de dispositivos electrónicos flexibles y con múltiple funcionalidad, mediante técnicas de fabricación a temperatura ambiente y bajo coste. Uno de los campos en los que estos dispositivos orgánicos han despertado mayor interés es el de su aplicación como sensores.

En particular, los sensores basados en los denominados **Transistores Orgánicos** de película delgada (OTFT's) han experimentado un gran desarrollo debido a sus múltiples ventajas, como simplicidad, elevada sensibilidad, y posibilidad de miniaturización. Existen dos tipos principales de OTFT's: Transistor Orgánicos de Efecto de Campo (OFET) y Transistor Electroquímico Orgánico (OECT).

Los OECT's constan de tres electrodos (surtidor, drenador y puerta), un semiconductor orgánico (OSC), y un electrolito en contacto con el semiconductor. El funcionamiento de los **sensores basados en OECT's** se basa en la modulación de la corriente del canal por dopaje o de-dopaje electroquímico desde el electrolito, cuando se aplican tensiones de puerta. Los OECT's resultan especialmente adecuados como sensores químicos debido a su capacidad de operar en medios acuosos. En este trabajo, se han desarrollado OECT's basados en el OSC PEDOT:PSS mediante tecnología *Screen-printing*. Los transistores se han diseñado variando su geometría, parámetro del que depende la sensibilidad del sensor. Mediante la caracterización eléctrica de los OECT's, se ha podido determinar la geometría óptima en función del analito a detectar. Finalmente, se ha comprobado experimentalmente la validez de estos OECT's como sensores de cationes de diferentes tamaños y de ácido ascórbico, obteniéndose resultados muy satisfactorios.

Los OFET's, se han preparado depositando el OSC sobre el dieléctrico y para obtener el canal cuya corriente se modula con la tensión aplicada al electrodo de puerta. En la mayoría de los **sensores basados en OFET's**, el semiconductor está expuesto al analito. Su funcionamiento se basa en la modificación de la corriente del canal por dopaje o captura de cargas en presencia del analito. En este trabajo, se han desarrollado OFET's basados en *TIPS-Pentacene* mediante las tecnologías *Drop-casting* y *Spin-coating*. Tras establecer la mejor técnica de deposición del semiconductor orgánico se han caracterizado eléctricamente los OFET's.

La **caracterización eléctrica** de estos transistores orgánicos es fundamental para optimizar su uso como sensores químicos. No obstante, las propiedades únicas de los OSC's dificultan la caracterización eléctrica de estos dispositivos con los equipos comerciales actuales, diseñados todos ellos para la caracterización de transistores de Silicio. Para suplir esta necesidad, se ha diseñado un equipo para la caracterización de transistores orgánicos, utilizando componentes comerciales de bajo coste y un software desarrollado específicamente para la determinación de los parámetros característicos de OECT's y OFET's fijados en la norma estándar IEEE 1620-2008.

ABSTRACT

Organic Electronics has been extensively developed along these past decades, since the discovery of conducting polymers in the 1970s. The unique features that these organic semiconductors can offer have allowed the development of many electronic devices with mechanical flexibility and multiple functionalities, using low-temperature and low-cost fabrication technologies. These organic devices have attracted considerable interest for their use in many fields, especially for sensing applications.

In particular, **Organic Thin-Film Transistors** (OTFTs) have paved the way towards the fabrication of efficient sensors due to their many advantages, such as simplicity, high sensitivity, and facile miniaturization. OTFTs can be classified into two types of transistors: Organic Field Effect Transistors (OFET) and Organic Electrochemical Transistors (OECT).

The essential components of an OECT are an organic semiconductor film, three electrodes (source, drain and gate), and an electrolyte bridging the semiconductor and the gate electrode. The operation of an **OECT-based sensor** lies on the modulation of the channel current by electrochemical doping or de-doping from the electrolyte, when gate voltages are applied. OECTs have attracted considerable interest for their application as chemical sensors due to their ability to operate in aqueous environments. In this work, PEDOT: PSS-based OECTs have been prepared by *Screen-printing*. The effect of the geometry on the sensor sensitivity has been investigated by comparing OECTs with different channel and gate areas ratio. The electrical characteristics of the OECTs have been used to determine the geometry that optimizes their performance for sensing different analytes. Finally, the use of these OECTs for the detection of cations and ascorbic acid has been experimentally assessed, with satisfactory and promising results.

The OFET's have been prepared by depositing the organic semiconductor on the dielectric and thus obtain the channel whose current is modulated by the voltage applied to the gate electrode. In most of the **OFET-based sensors**, the semiconductor is exposed to the analyte. Their operation is based on the modification of the channel current by charge doping or trapping due to the analyte. In this work, OFETs based on TIPS-pentacene have been prepared by *Drop-casting* and *Spin-coating*. The best technique for deposition of this organic semiconductor has been initially identified. Then, the electrical characteristics of these OFETs have been determined.

The **electrical characterization** of these organic transistors is essential for their optimization as chemical sensors. However, the unique properties of organic semiconductors render difficult the electrical characterization of these transistors with current commercial devices, since these have been all designed for characterizing Si-based transistors. A device which allows for systematic characterization of organic transistors has been designed therefore, using low-cost commercial components and a software that has been specifically developed for the determination of the reporting parameters for OFETs and OECTs, as specified in the IEEE 1620-2008 standard.

RESUM

La Electrònica Orgànica ha experimentat un gran avanç en les últimes dècades, des que en els anys 70 es descobriessin els polímers conductors. Les característiques úniques dels semiconductors orgànics, han permès el desenvolupament de dispositius electrònics flexibles i amb múltiple funcionalitat, mitjançant tècniques de fabricació a temperatura ambient i baix cost. Un dels camps en què aquests dispositius orgànics han despertat més interès és el de la seva aplicació com a sensors.

En particular, els sensors basats en els denominats Transistors Orgànics de pel·lícula prima (OTFT s) han experimentat un gran desenvolupament a causa dels seus múltiples avantatges, com simplicitat, elevada sensibilitat, i possibilitat de miniaturització. Hi ha dos tipus principals de OTFT s: Transistor Orgànics d'Efecte de Camp (OFET) i Transistor Electroquímic Orgànic (OEET).

Els OEET's consten de tres elèctrodes (sortidor, drenador i porta), un semiconductor orgànic (OSC), i un electròlit en contacte amb el semiconductor. El funcionament dels sensors basats en OEET's es basa en la modulació del corrent del canal per dopatge o dedopatge electroquímic des del electròlit, quan s'apliquen tensions de porta. Els OEET's resulten especialment adequats com a sensors químics per la seva capacitat d'operar en mitjans aquosos. En aquest treball, s'han desenvolupat OEET's basats en el OSC PEDOT: PSS mitjançant tecnologia Screen-printing. Els transistors s'han dissenyat variant la seua geometria, paràmetre del qual depèn la sensibilitat del sensor. Mitjançant la caracterització elèctrica dels OEET's, s'ha pogut determinar la geometria òptima en funció de l'analit a detectar. Finalment, s'ha comprovat experimentalment la validesa d'aquests OEET's com a sensors de cations de diferents mides i d'àcid ascòrbic, obtenint-se resultats molt satisfactoris.

Els OFET's, s'han preparat dipositant el OSC sobre el dielèctric per obtenir el canal i la corrent es modula amb la tensió aplicada a l'elèctrode de porta. En la majoria dels sensors basats en OFET's, el semiconductor està exposat al analit. El seu funcionament es basa en la modificació del corrent del canal per dopatge o captura de càrregues en presència de l'analit. En aquest treball, s'han desenvolupat OFET's basats en TIPS-Pentacene mitjançant les tecnologies "Drop-càsting" i "Spin-coating". Després d'establir la millor tècnica de deposició del semiconductor orgànic s'han caracteritzat elèctricament els OFET's

La caracterització elèctrica d'aquests transistors orgànics és fonamental per optimitzar el seu ús com a sensors químics. No obstant això, les propietats úniques dels OSC's dificulten la caracterització elèctrica d'aquests dispositius amb els equips comercials actuals, dissenyats tots ells per a la caracterització de transistors de silici. Per suplir aquesta necessitat, s'ha dissenyat un equip per a la caracterització de transistors orgànics, utilitzant components comercials de baix cost i un programari desenvolupat específicament per a la determinació dels paràmetres característics de OEET's i OFET's fixats en la norma estàndard IEEE 1620-2008

ÍNDICE

Capítulo 1. Introducción y Objetivos.....	1
1. Introducción.....	3
1.1. Sensores Químicos Basados en Transistores Orgánicos.....	3
1.2. Semiconductores Orgánicos Utilizados en la Fabricación de Transistores.	8
1.3. Funcionamiento y Estructura Básica de un OECT.	10
1.3.1. Características I_{DS} vs. V_{DS}	13
1.3.2. Tipos de OECT'ss.....	14
1.4. Funcionamiento y Estructura Básica de un OFET.....	19
1.4.1. Características I_{DS} vs. V_{DS}	21
1.4.2. Caracterización Eléctrica del OFET.....	23
1.5. Fabricación de Transistores Orgánicos.....	27
1.5.1. Fabricación de OECTs Basados en PEDOT:PSS.....	27
1.5.2. Fabricación de OFETs Basados en <i>TIPS-Pentacene</i>	28
1.6. Bibliografía complementaria.....	30
2. Objetivos.....	31
3. Referencias Bibliográficas.....	33
Capítulo 2. Publicaciones.....	37
1. <i>Characterization of Screen-Printed Organic Electrochemical Transistors to Detect Cations of Different Sizes</i>.....	39
2. <i>Screen-printed Organic Electrochemical Transistors for the detection of ascorbic acid in food</i>.....	53
3. <i>Inexpensive Measuring System for the Characterization of Organic Transistors</i>.....	71
Capítulo 3. Conclusiones.....	83
1. Conclusiones de los Resultados Obtenidos.....	85
2. Producción Científica: Publicaciones, Congresos y Proyectos.....	86
3. Líneas Futuras.....	87

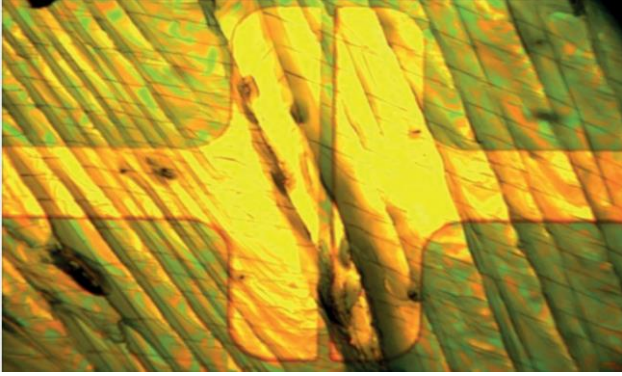

Capítulo 1: Introducción y Objetivos

En este capítulo se describe el estado del arte actual en el área de desarrollo de sensores químicos basados en *Organic Thin-Film Transistors* [OTFT] que han servido de base y punto de partida de esta tesis, la cual se presenta en forma de artículos indexados en revistas científicas en el Capítulo 2. Al final de este Capítulo 1 se exponen los objetivos que se han fijado al inicio de la tesis y que han determinado el trabajo desarrollado en ella.

1. INTRODUCCIÓN

Según la *Internacional Union of Pure Applied Chemistry* (IUPAC) (1991) [1], un **sensor químico** es un dispositivo que transforma información química (desde la concentración de una muestra específica hasta el análisis de la composición total), en una señal analíticamente útil. En muchos casos, en un sensor químico, la información química se convierte en información eléctrica. Según Wolfbeis [2], estos sensores deben ser dispositivos de pequeño tamaño capaz de informar, continua y reversiblemente, de una concentración química.

El sensor consta de dos partes (figura 1.1), una es el receptor que reconoce el analito, otra es el transductor que transforma la información química en información eléctrica.

- El **receptor** modifica sus propiedades al interactuar con el analito, y este cambio afecta a la respuesta del transductor variando su señal eléctrica de salida. Los receptores usados normalmente en sensores químicos utilizan capas finas que interactúan con el analito mediante mecanismos tales como adsorción, intercambio de iones y reacciones químicas.

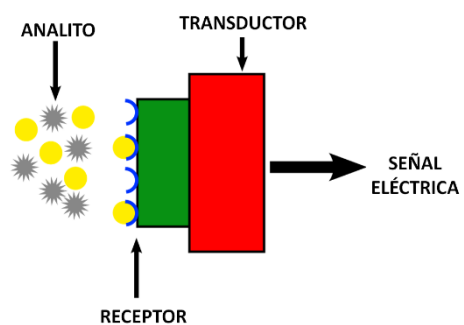

Fig. 1.1. Sensor Químico.

- El **transductor** transforma la energía que lleva la información química de la muestra en información útil analíticamente. La señal de salida del transductor puede ser variaciones de corriente o de tensión eléctrica.

La unión del receptor y del transductor constituye el sensor que proporcionará la información deseada.

1.1. Sensores Químicos Basados en Transistores Orgánicos

Hoy en día, existe una gran demanda de análisis químicos en diversos campos como los diagnósticos médicos, la industria agroalimentaria, etc. En los últimos años, han aparecido en el campo de la electrónica materiales orgánicos que permiten la fabricación de dispositivos de bajo coste para su aplicación como sensores químicos, los cuales podrían cubrir una gran cantidad de necesidades demandadas.

El descubrimiento de la conducción de los polímeros conjugados en la década de 1970 allanó el camino para un nuevo tipo de electrónica basada en **semiconductores orgánicos** en lugar de silicio, llamada **electrónica orgánica**. La electrónica orgánica es una rama de la electrónica que, a diferencia de la tecnología tradicional del silicio, permite fabricar dispositivos y circuitos electrónicos mediante procesos y materiales de bajo coste.

Entre los diversos dispositivos electrónicos orgánicos que se han desarrollado, destacan los **transistores orgánicos**. El transistor, desde un punto de vista electrónico, es la base de la industria electrónica presente. La fabricación de transistores siempre ha sido compleja y tradicionalmente ha requerido costosos recursos. El desarrollo de los transistores orgánicos ha abierto una gama de nuevas posibilidades debido a su fabricación relativamente fácil y la amplia variedad de semiconductores orgánicos que la industria química puede ofrecer. Una de las aplicaciones más prometedoras de los transistores orgánicos es su uso como sensores.

En general, los transistores basados en silicio se pueden dividir en transistores bipolares y transistores de efecto de campo [3]. El primer transistor de efecto de campo (*Field Effect Transistor*, FET) fue patentado en 1930, y más tarde, el primer metal-óxido-semiconductor-FET (*Metal-Oxide-Semiconductor-FET*, MOSFET) fue diseñado en 1960. En 1987, [4] informó del primer **transistor de efecto de campo orgánico** (*Organic Field Effect Transistor*, OFET) basado en un polímero de tiofeno. Hoy en día, la mayoría de los OFETs se construyen como transistores de película delgada (*Thin-Film Transistor*, TFT) que permiten la miniaturización de su diseño. Estos transistores se conocen como **transistores de película delgada orgánicos** (*Organic Thin-Film Transistor*, OTFT). Al igual que su equivalente TFT basado en silicio, el OTFT es un dispositivo eléctrico de tres terminales con una arquitectura similar. La puerta está conectada al sustrato, que generalmente es de silicio oxidado térmicamente. La capa activa (polímero semiconductor o semiconductor orgánico) se deposita encima de la capa aislante que cubre la puerta. La fuente y el drenador están conectados en lados opuestos de la capa activa, formando el canal (figura 1.2).

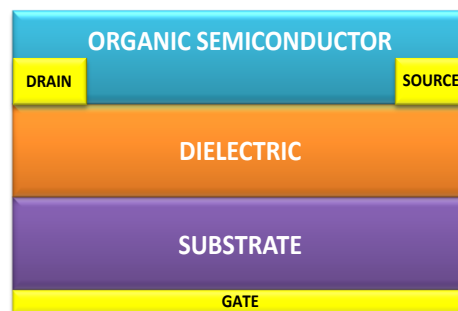

Fig. 1.2. Estructura de un OTFT.

Cuando se aplica una tensión (V_{DS}) entre el drenador (*Drain*) y el surtidor (*Source*) del transistor, fluye una corriente eléctrica (I_{DS}) entre estos dos electrodos mediante el transporte de portadores de carga. Esta corriente está modulada por el campo eléctrico (V_{GS}) aplicado al semiconductor orgánico a través del tercer electrodo de puerta (*Gate*). En los semiconductores orgánicos, los portadores de carga pueden ser electrones (carga negativa/tipo n), huecos (sin electrones, carga positiva/tipo p) o ambos (bipolar).

Dependiendo del mecanismo utilizado para lograr la modulación las OTFT pueden clasificarse en dos tipos principales [3]: Transistores de Efecto de Campo Orgánico

(OFET) y Transistores Electroquímicos Orgánicos (*Organic Electrochemical Transistor*, OECT).

I. Transistor de Efecto de Campo Orgánico (OFET). Como TFT, los OFETs se componen de tres electrodos (fuente, drenador y puerta), un semiconductor orgánico y un dieléctrico (entre la puerta y la capa activa). Se pueden distinguir cuatro estructuras OFET básicas (figura 1.3), dependiendo de la posición de los electrodos de puerta y surtidor/drenador:

- a) contacto inferior/puerta inferior.
- b) contacto inferior/puerta superior.
- c) contacto superior/puerta inferior.
- d) contacto superior/puerta superior.

En la mayoría de los OFETs utilizados en aplicaciones de sensores, la capa de semiconductor activa está expuesta al analito que causa la modulación de la corriente por dopaje de carga o atrapamiento. Por lo tanto, los sensores basados en OFETs generalmente se diseñan con configuraciones *BOTTOM GATE* (puerta inferior) o *TOP GATE* (puerta superior).

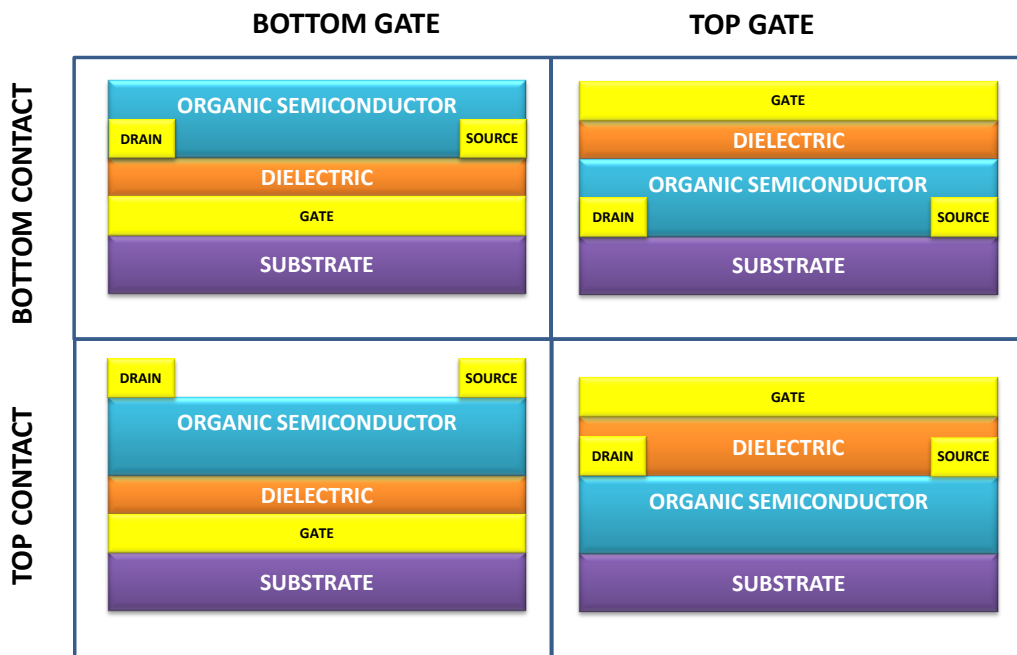

Fig. 1.3. Diferentes arquitecturas de transistor OFET.

II. Transistor Electroquímico Orgánico (OECT). En estos transistores, se usa un medio electrolítico en lugar de un dieléctrico entre la puerta y el semiconductor orgánico (figura 1.4). Los OECTs también se pueden considerar OFETs que operan al inducir una reacción de reducción u oxidación, que produce cambios en el valor de la corriente que va del drenador al surtidor, cuando se aplica una

tensión de entre la puerta y el surtidor. Los OEETs pueden funcionar como celdas electroquímicas de tres terminales en las que los electrodos de surtidor, drenador y puerta desempeñan las funciones del electrodo de trabajo, el contra-electrodo y el electrodo de referencia, respectivamente.

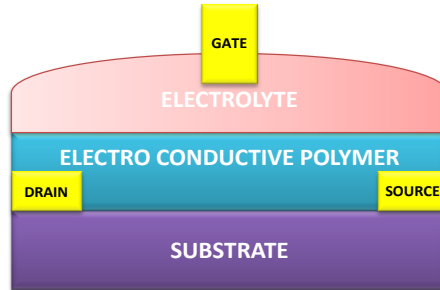

Fig. 1.4. Arquitectura de transistor OEET.

En base a estos dos tipos principales de OTFT, han surgido otros tipos más específicos de OTFT: OFET con electrolito (EGOFET), OFET sensibles a Ion (ISOFET), FET higroscópico-aislante (HIFET) y FET con carga orgánica (OCMFET)

III. Transistor de Efecto de Campo Orgánico con Protección Electrolítica (EGOFET). Como en los OEETs convencionales, en estos transistores, la compuerta está separada del semiconductor orgánico por un electrolito (sólido o líquido) (figura 1.5). Debido a la generación de una doble capa eléctrica en la interfaz del semiconductor electrolito-orgánico, los EGOFTs presentan una capacidad muy alta que permite la operación de bajo voltaje.

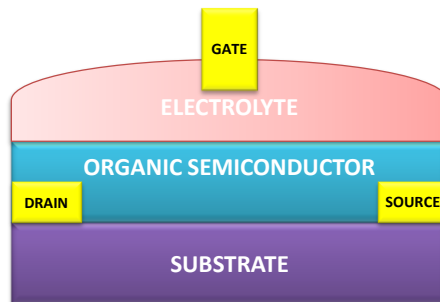

Fig. 1.5. Arquitectura de transistor EGOFT.

IV. Transistor de Efecto de Campo Higroscópico-aislante (HIFET). Este dispositivo tiene la capacidad de aprovechar la humedad ambiental mediante el uso de un dieléctrico de puerta higroscópico que permite que los iones se muevan libremente a través de él. Estos iones pueden interactuar electroquímicamente y/o electrostáticamente con el semiconductor en la interfaz dieléctrica-

semiconductora. Esto, a su vez, da como resultado la modulación actual a través del semiconductor, variando V_{GS} .

- V. **Transistor de Efecto de Campo Orgánico Sensible a los Iones (ISOFET).** La estructura de estos dispositivos es muy similar a la de los EGOFETs; pero los ISOFETs también tienen una capa dieléctrica que aísla el electrolito del semiconductor (figura 1.6). Esta estructura permite evitar la degradación del semiconductor.

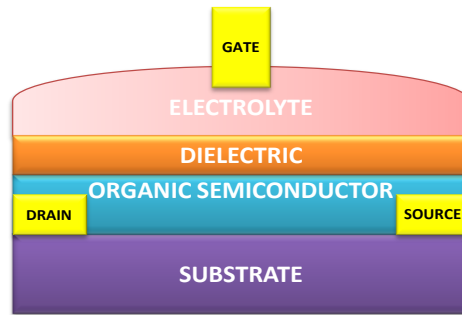

Fig. 1.6. Arquitectura de transistor ISOFET.

- VI. **Transistor de Efecto de Campo Modulados por Carga Orgánica (OCMFET).** La arquitectura de OCMFET se basa en la configuración de ISOFET. La diferencia radica en el uso de dos electrodos puerta. Uno de ellos, llamado *Control Capacitor* o *Reference Gate*, polariza el dispositivo. El otro, llamado *Floating Gate*, está conectado al área de detección (*Sensing Area*), sobre la cual se acumula la carga en función de la cantidad de analito (figura 1.7).

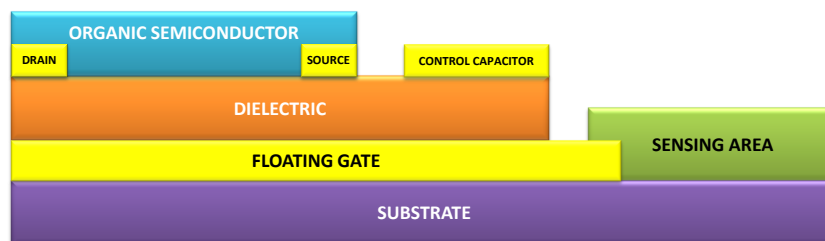

Fig. 1.7. Arquitectura de transistor OCMFET.

Todos estos transistores orgánicos se pueden usar como **sensores de iones**. Para ello, se requiere que un componente del dispositivo tenga sensibilidad y selectividad hacia un determinado analito. En los últimos años, se han investigado los OFETs como sensores de iones debido a la variación en la conductividad de algunos semiconductores orgánicos frente a ciertos iones. Por otro lado, los OECTs también han atraído una atención considerable para las aplicaciones de sensores de iones desde la década de 1980. Estos sensores operan haciendo uso de los cambios de conductividad experimentados por el semiconductor orgánico, ya sea debido a su oxidación/reducción o a cambios en su configuración que ocurren en presencia del analito. En ocasiones, la funcionalidad

química de un componente de estos dispositivos electrónicos orgánicos es necesaria para su uso como sensores de iones. La adaptación química para lograr propiedades específicas puede aplicarse no sólo al semiconductor, sino también a las capas metálicas y aislantes. El alma de esta tesis se centra en el diseño y caracterización de OEET's para su utilización en la detección de iones químicamente relevantes en medio acuoso y la fabricación y caracterización de OFET's para la detección de gases.

1.2. Semiconductores Orgánicos Utilizados en la Fabricación de los Transistores

Los semiconductores orgánicos (OSC) son moléculas pequeñas o polímeros **conjugados** (figura 1.8), debido a la alternancia de enlaces carbono-carbono simples y dobles en la molécula o en la cadena principal del polímero. Los dobles enlaces se forman cuando los átomos de carbono se enlazan a través de sus orbitales híbridos sp^2 , generando enlaces covalentes σ en un plano, y dejando fuera del plano a los orbitales 2p no híbridos. El solapamiento de orbitales 2p de carbonos adyacentes puede formar orbitales π muy deslocalizados. Los orbitales π ocupados (HOMO) son equivalentes a la banda de valencia de un semiconductor inorgánico, mientras que los orbitales π^* vacíos (LUMO) son análogos a la banda de conducción. En los semiconductores orgánicos, el transporte de carga entre moléculas requiere un solapamiento adecuado de los orbitales π de moléculas adyacentes. Su conductividad eléctrica se debe al movimiento de los portadores de carga en estas uniones conjugadas π , que pueden ser de dos tipos: electrones y huecos.

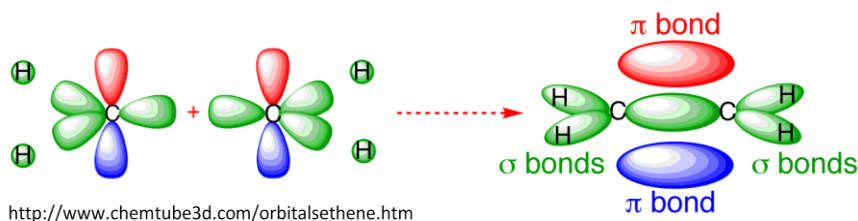

Fig. 1.8. Moléculas Conjugadas.

La conductividad eléctrica de los semiconductores orgánicos puede modificarse introduciendo impurezas. El proceso de adición de impurezas a un semiconductor intrínseco (puro) se denomina **dopaje**. Las sustancias dopantes más adecuadas dependen en cada caso, de las propiedades atómicas tanto del semiconductor como del dopante. En general, las sustancias dopantes se clasifican como aceptores o donantes de electrones. Los semiconductores dopados con sustancias dopantes donantes de electrones se denominan de **tipo-n**, puesto que en estos materiales el transporte de carga principal es de electrones. Por otra parte, los semiconductores dopados con sustancias aceptores de electrones se denominan de **tipo-p**, ya que el transporte de carga es principalmente de huecos.

Los semiconductores más destacados son [5]:

- **Trans-poliacetileno (TPA)** fue uno de los primeros polímeros semiconductores en ser utilizado, mediante un dopaje químico tipo-p, que mejoró su comportamiento incrementando la conductividad en un factor de 10^8 .
- **Polipirroles y Polianilinas** son dos familias de semiconductores, ampliamente investigadas, que junto con el poliacetileno se pueden encontrar de forma natural en algunas melaninas.
- **Poli-p-fenileno (PPP) y Poli-p-fenileno vinileno (PPV)** ambos polímeros son electroluminiscentes, por lo que se utilizan como emisores de luz orgánicos. A diferencia de otros polímeros, el PPV es fácil de procesar en películas delgadas altamente ordenadas, mejorando la conductividad.
- **Politiofenos.** Esta familia de polímeros, además de presentar una muy buena conductividad eléctrica, también presenta propiedades crómicas, es decir, cambian de color como respuesta a un cambio de estado en una reacción redox, un cambio de potencial o temperatura.
- **Pentaceno.** Los acenos, o poliacenos son hidrocarburos aromáticos policíclicos formados por anillos de benceno unidos entre sí de forma lineal. Sus representantes de mayor tamaño tienen un potencial en los campos de la química y la ingeniería electrónica. El pentaceno ha sido incorporado a los transistores orgánicos de efecto de campo ampliamente.

En la fabricación de los transistores orgánicos objeto de la presente tesis se han utilizado el PEDOT:PSS y el *TIPS-PENTACENE*.

a) **PEDOT:PSS**

El polímero semiconductor elegido para la fabricación de los OECTs objeto de estudio de esta tesis, ha sido el **PEDOT:PSS** (*poli(3,4-etilendioxitiofeno)-poli(estireno sulfonato)*). El PEDOT:PSS está formado a partir de un semiconductor intrínseco de politiofeno (PEDOT) cargado positivamente, dopado con un polímero de poliestireno ácido sulfónico (PSS) con iones sulfonato cargados negativamente (figura 1.9). El PSS se añade en exceso, de tal forma que una parte de los aniones sulfonato quedan descompensados, obteniéndose un semiconductor dopado de tipo-p. Además de actuar como dopante, el PSS sirve como contraión para estabilizar las suspensiones acuosas, ya que el PEDOT por sí mismo es insoluble.

Actualmente, existen varias empresas que comercializan PEDOT: PSS en diferentes formatos que se adaptan a los distintos métodos de fabricación (*ink-jet, screen-printed,*

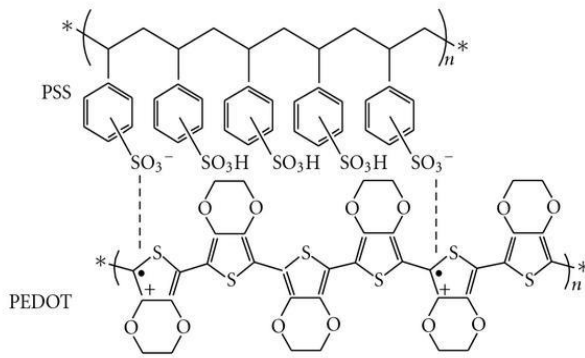

Fig.1.9. Estructura química del PEDOT: PSS.

spray, etc). Este semiconductor se caracteriza por su alta conductividad, excelente estabilidad térmica, buena estabilidad en medio acuoso en un amplio rango de pH, fácil procesabilidad y biocompatibilidad; todo ello, hace que sea uno de los semiconductores más utilizados en la fabricación de transistores orgánicos, en particular de tipo OECT.

Algunas aplicaciones del PEDOT:PSS como sensor químico se han reportado en relación a la detección de iones como Ca^{2+} [6], K^+ [7], Ag^+ [8], iones metálicos [9], y algunas moléculas como la Glucosa [10].

b) TIPS-PENTACENE

Para la fabricación de los OFETs objeto de estudio de esta tesis, se ha elegido como componente orgánico electrónico el *6,13-bis-(triisopropilsililetinil) Pentacene*) también conocido como *TIPS-pentacene*, cuya estructura molecular se muestra en la figura 1.10. El *TIPS-Pentacene* se usa ampliamente como una molécula pequeña de alto rendimiento para aplicaciones OFET, con una movilidad superior a $1 \text{ cm}^2 \cdot (\text{V} \cdot \text{s})^{-1}$. Tiene una excelente solubilidad en una gama de disolventes orgánicos comunes y una buena estabilidad ambiental, lo que facilita su procesamiento en dispositivos.

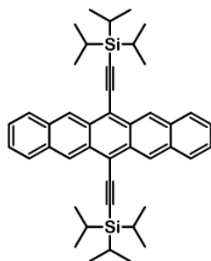

Fig. 1.10. Estructura química del Tip_PENTACENE.

Al tratarse de un sólido, es necesario disolverlo utilizando alguno de los disolventes recomendados. Esta disolución se deposita mediante diferentes técnicas y forma una fina película semiconductor que cuya conductividad varía en presencia de gases, siendo esta característica la que lo convierte en sensor.

Algunas aplicaciones del pentaceno como sensor químico se han reportado para la determinación de pH [11].

1.3. Funcionamiento y Estructura Básica de un OECT

En un OECT, la conductividad del polímero semiconductor PEDOT:PSS se puede modular por oxidación-reducción. Mientras que su estado oxidado (PEDOT^+) es altamente conductor (estado dopado), su forma neutra PEDOT^0 es menos conductora (estado de-dopado). El paso entre ambos estados se puede producir al añadir un analito, M^+ y aplicar un potencial que favorezca la siguiente reacción redox del PEDOT:PSS:

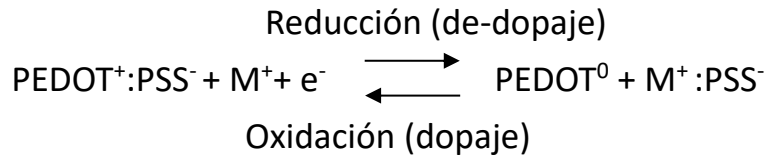

Conductor (PEDOT⁺) → Semiconductor neutral (PEDOT⁰)
 Color transparente ← Color azul oscuro

Para explicar este modo de funcionamiento electroquímico de un OECT, se considerará la celda mostrada en la figura 1.11, que consta de dos electrodos de PEDOT:PSS en contacto con un electrolito que contiene el analito, M⁺. Al aplicar una diferencia de potencial entre los dos electrodos, el ánodo de PEDOT⁰ se polariza positivamente al perder electrones que son atraídos hacia la fuente (terminal positivo de la pila), por lo que los cationes del analito M⁺ son repelidos y migran hacia el electrolito en dirección al cátodo. En el cátodo, la corriente iónica se convierte en corriente eléctrica y el PEDOT⁺ se reduce a PEDOT⁰, produciéndose el efecto contrario al del ánodo. En definitiva, la corriente eléctrica que llega al PEDOT:PSS se convierte en una corriente iónica, que se transporta por el electrolito hasta el otro electrodo, donde se produce la reacción inversa, completando el proceso redox.

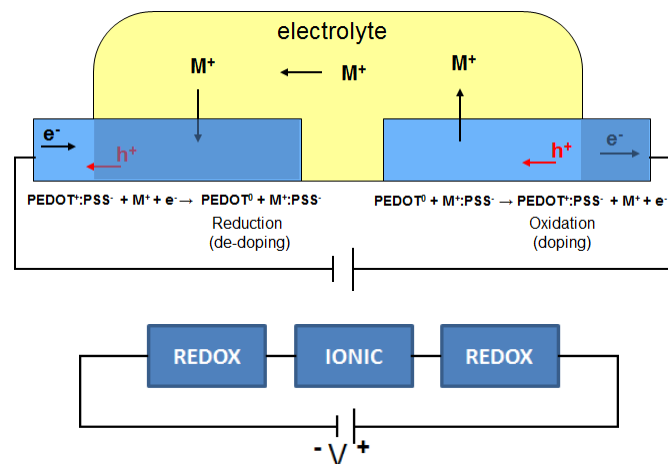

Fig. 1.11. Circuito electroquímico (estructura 2). [12]

Si se modifica la estructura (figura 1.12, llamada estructura 1) y se deposita sobre ambos electrodos un film homogéneo formando un canal, al cubrirlo con el electrolito y aplicar un potencial, se generará un gradiente electroquímico a lo largo del film semiconductor, y otro entre el film y el electrolito.

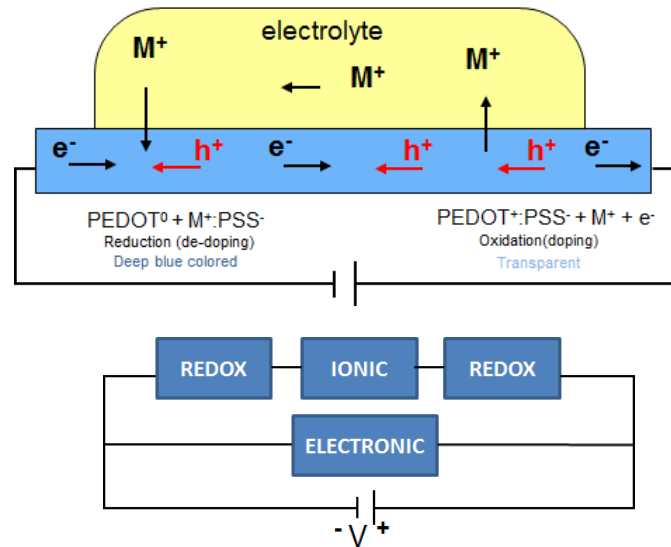

Fig. 1.12. Circuito electroquímico y electrónico (estructura 1). [12]

Se podría decir que hay dos vías paralelas para los portadores de carga: por una parte, a través del electrolito mediante una reacción redox del analito con el PEDOT: PSS, hasta que el potencial electroquímico sea uniforme y se alcance el equilibrio. Paralelamente, en el interior del film se formará un gradiente de concentración de portadores de carga. Cuando la reacción redox con el analito alcance el equilibrio electroquímico, sólo habrá un transporte de cargas entre el ánodo y el cátodo en el interior del film. Si se varía el potencial de polarización aplicado entre los electrodos (V_{DS}) se puede observar que, a partir de un determinado valor, la corriente se mantiene constante, aunque se siga incrementando el potencial V_{DS} . En ese momento, el transistor entra en la zona de saturación, de forma análoga a lo que ocurre con los transistores de efecto campo (MOSFET) basados en silicio.

Basándose en las dos estructuras anteriores, se obtiene el diseño un transistor electroquímico OECT. Como se muestra en la figura 1.13, los OECTs son dispositivos de tres terminales: la puerta (G), el drenador (D) y el surtidor (S). Tanto la puerta como el canal que une el surtidor con el drenador están fabricados con PEDOT:PSS.

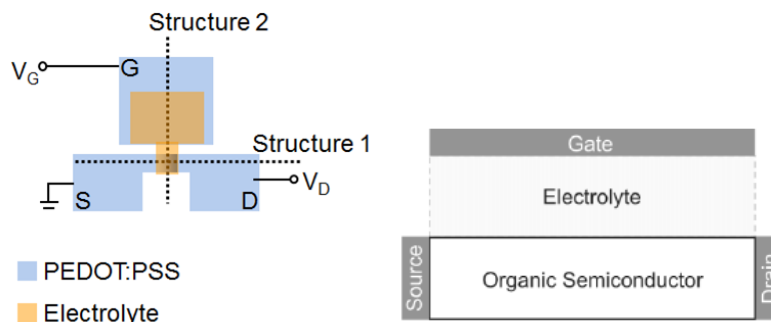

Fig. 1.13. Estructura de un OECT con PEDOT:PSS. [12] y [13]

1.3.1. Características I_{DS} - V_{DS}

Las características de salida I_{DS} - V_{DS} de un OECT se muestran en la figura 1.14. En el **primer cuadrante** ($V_{DS}>0$, $I_{DS}>0$), el transistor se comporta linealmente cuando $V_{GS}=0$. Si esta tensión V_{GS} aumenta, el canal se reduce, por lo que la impedancia aumenta y la corriente disminuye. Por otra parte, para una misma V_{GS} , si la tensión V_{DS} aumenta, la corriente también aumenta, comportándose como una resistencia.

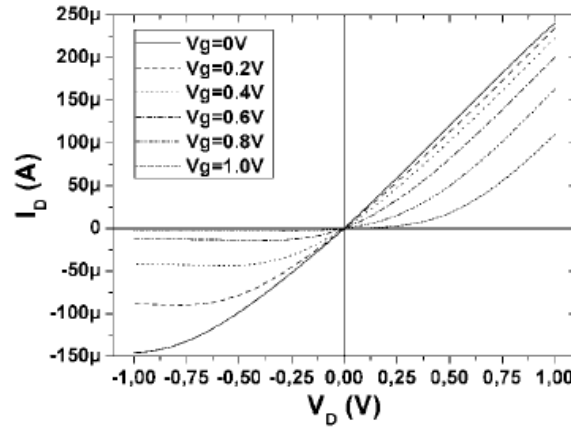

Fig. 1.14. Característica de salida del OECT de PEDOT:PSS. [12]

En la figura 1.15 se muestra el proceso dinámico en esta región ohmica, en esta situación los iones y cationes de la disolución no interactúan con el PEDOT:PSS y la corriente del canal varía tal como se ha explicado en el párrafo anterior.

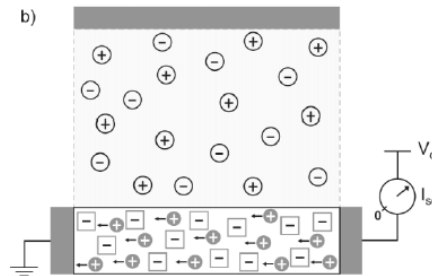

Fig. 1.15. OECT sin polarización de puerta. La corriente se determina por la conductividad intrínseca del semiconductor orgánico. [13]

En el primer cuadrante, se pueden identificar dos tipos de **regímenes de trabajo**. El primero se da cuando $|V_{DS}| < |V_{GS} - V_T|$. En este régimen, el comportamiento del transistor viene descrito por la siguiente ecuación:

$$I_D = G \left[1 - \frac{V_{GS} - V_{DS}}{V_T} \right] V_{DS} \quad (1)$$

Donde la G es la conductancia del OECT (que depende de su movilidad, el ancho, el largo y la profundidad del canal) y siendo V_T la tensión de *pinch-off*.

El otro régimen ocurre cuando $|V_{DS}| > |V_{GS} - V_T|$, para el cual se cumple:

$$I_D = G \left[V_{DS} - \frac{V_{GS}}{2V_T} \right] \quad (2)$$

En el **tercer cuadrante** ($V_{DS} < 0$ y $I_D < 0$), las curvas obtenidas son las correspondientes a un transistor de tipo MOSFET. En esta zona, también hay dos tipos de comportamiento del transistor. Aplicando una tensión $V_{GS} > 0$, se produce el **de-dopaje**: los cationes del electrolito interactúan con el semiconductor, de forma que cada catión produce un de-dopaje de PEDOT:PSS pasando a ser una molécula neutra (figura 1.16).

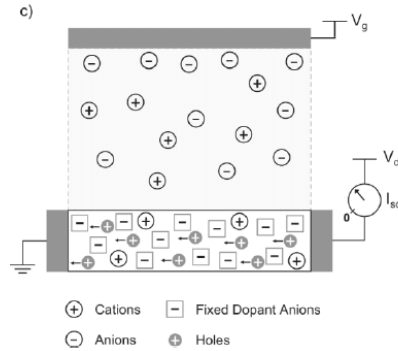

Fig.1.16. OECT cuando se polariza la puerta la corriente es determinada por el dopado/de-dopado del semiconductor orgánico. [13]

Al igual que en los MOSFETs, el OECT se comporta en **saturación** cuando se cumple que $|V_{DS}| \geq |V_{GS} - V_T|$, siendo la tensión de drenador mínima para estar en saturación: $V_{DS}^{sat} = V_{GS} - V_T$. Dependiendo de la longitud del canal, puede haber o no una variación de la I_D más allá de la saturación. En canales largos, la región de deplexión no variará apreciablemente con V_{DS} , y la I_D se mantendrá constante. Si el canal es suficientemente corto para que la zona de deplexión se amplie con la V_{DS} , la corriente I_D en saturación continuará aumentando. Para una tensión $V_{DS} \leq V_{DS}^{sat}$, el OECT se encuentra en **zona ohmica**, y la I_D responde a la siguiente ecuación:

$$I_D = -\frac{G \cdot V_{GS}^{sat 2}}{2V_T} \quad (3)$$

Es en este tercer cuadrante donde el **OECT se utiliza como sensor**, por tener en este cuadrante el comportamiento de un transistor, es decir de un amplificador.

1.3.2. Tipos de OECTs

Los OECTs basados en PEDOT:PSS pueden operar de dos formas distintas: como **convertidores de ion a electrón** o como **sensores electroquímicos** [14]

a) Convertidores de ion a electrón.

En el caso de convertidores de ion a electrón, la aplicación de una tensión de puerta positiva induce una corriente iónica transitoria en el electrolito. Los cationes del electrolito se introducen en el polímero conductor y lo de-dopan (figura 1.17), produciéndose una disminución de I_D . Por tanto, en este caso, el OECT convierte una corriente iónica transitoria en un cambio de I_D .

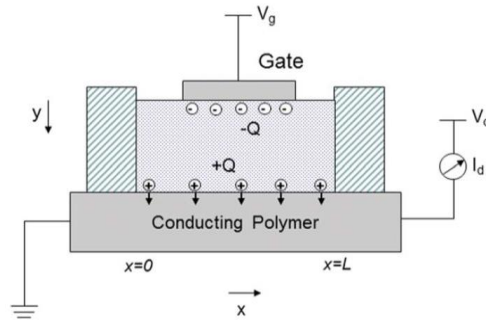

Fig. 1.17. Esquema del OEET con la distribución de cargas en el electrolito después de la aplicación de una tensión de puerta positiva [14].

La figura 1.18 explica la distribución de potenciales en un OEET de este tipo, asumiendo que el canal es el potencial de referencia (siempre que V_{DS} sea más pequeña que V_{GS}).

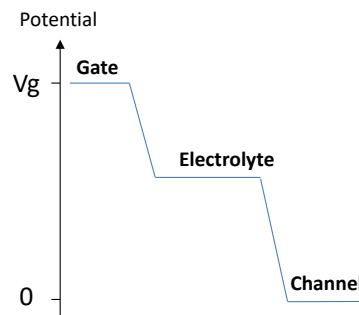

Fig. 1.18. Distribución de potenciales en el OEET.

El **potencial del electrolito** está determinado por las capacidades asociadas con la formación de la doble capa en la puerta. Así su valor será:

$$V_{sol} = \frac{V_{GS}}{1 + \frac{c_{ch}A_{ch}}{c_gA_g}} \quad (4)$$

Donde C es la capacidad por unidad de área, A es el área, y los subíndices **ch** y **g** se refieren al canal y a la puerta, respectivamente.

Esta ecuación se cumplirá siempre que el material de la puerta y el canal sean polarizables. Con puertas de Platino u Oro es bastante aproximada, pero no lo es tanto con puertas de PEDOT:PSS, porque los iones penetran en el polímero de-dopándolo. Si se asume además que las capacidades del canal y la puerta son parecidas, el potencial del electrolito sólo dependerá de la relación entre las áreas de canal y puerta ($\Upsilon = A_{ch}/A_g$).

Cuanto mayor sea el área de puerta (Υ menor), más se aproxima el potencial del electrolito al potencial de la puerta (figura 1.19). Esto conlleva una caída de potencial considerable entre el electrolito y el canal, lo que a su vez provoca una fuerte modulación de la corriente del canal I_D (figura 1.20).

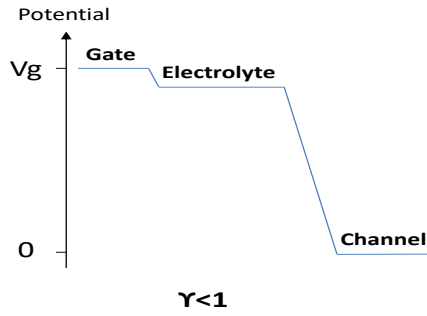

Fig. 1.19. Distribución de potenciales en el OEET para puertas con áreas mayores que áreas de canal.

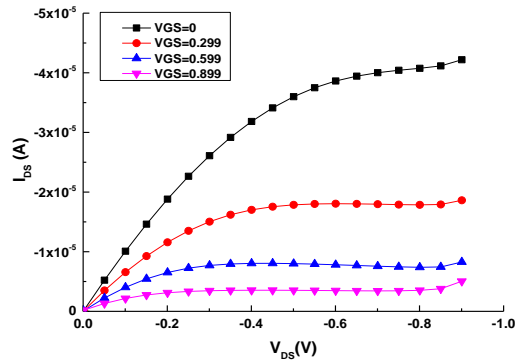

Fig. 1.20. Modulación de corriente de canal con áreas de puerta grandes ($\gamma < 1$).

Hay que destacar que si se usase un electrodo de puerta no polarizable (como Ag/AgCl), no habría caída de potencial entre el electrolito y la puerta (independientemente de la relación de áreas), lo que provocaría una situación similar a la de utilizar un electrodo de puerta polarizable con área de puerta grande.

La corriente de canal en este estado puede expresarse por la siguiente ecuación:

$$I_{DS} = -G \frac{(V_{GS} - V_p)^2}{2V_T} \quad (5)$$

En el caso de que el área de puerta fuese menor que el área de canal ($\gamma > 1$), el potencial del electrolito estaría más próximo al potencial del canal (figura 1.21). En este caso la modulación de corriente es muy debil (figura 1.22).

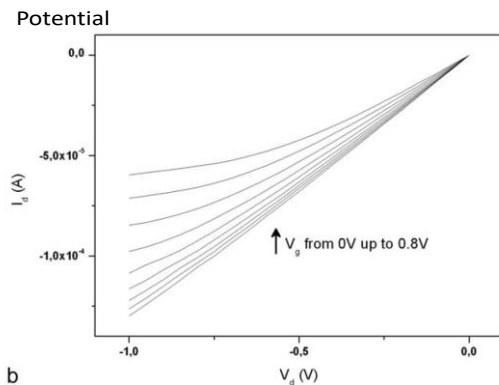

Fig. 1.22. Modulación de corriente de canal con áreas de puerta pequeñas ($\gamma > 1$) [14]. menores que áreas de canal.

En la figura 1.23 se muestra la la variación de la corriente de canal en función de la tensión de puerta y de la relación de áreas de puerta/canal. Se observa una fuerte variación de la corriente en el caso $\gamma < 1$, es decir un área de puerta mucho mayor que el área de canal.

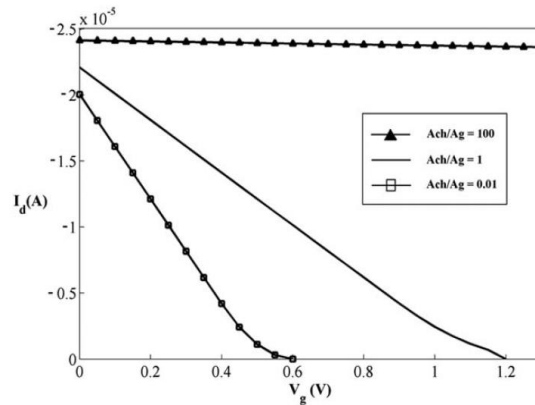

Fig. 1.23. Función de transferencia según γ (0.01, 1 y 100).

En conclusión, para convertidores de ión a electrón, la primera regla de diseño es que **el electrodo de puerta sea mucho más grande que el canal** o que se utilice un **electrodo de puerta no-polarizable**.

b) Sensores electroquímicos.

En este caso las reacciones de transferencia de carga entre las especies en el electrolito y el electrodo de puerta, cambian el potencial del electrolito lo que provoca un cambio en la corriente de canal. En este tipo de transistores la puerta es como un electrodo de trabajo, que mantiene constante el potencial. La transferencia de carga entre el analito y la puerta está relacionada por la siguiente ecuación:

$$V_{analito} = \frac{kT}{ne} \ln[c] + cte \quad (6)$$

Donde k es la constante de Boltzmann, T es la temperatura, e es la carga fundamental, C la concentración del analito y la constante (cte) engloba a otros potenciales.

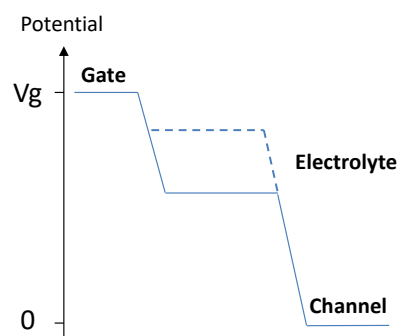

Fig. 1.24. Distribución de potenciales en el OECT al introducir el analito en la disolución.

El potencial del electrolito se incrementa en presencia del analito; es decir, la adición de analito provoca una disminución de la caída de potencial puerta/electrolito, y el consiguiente aumento de la caída de potencial de la interface electrolito/canal. Como resultado, la corriente I_{DS} varía con la concentración del analito (figura 1.24).

Si se considera un OECT donde se aplican tensiones de puerta lo suficientemente pequeñas como para prevenir la electrolisis del agua, **en ausencia de analito**, no hay transferencia de carga entre el electrolito y el electrodo de puerta (régimen no farádico). En este caso, el potencial del electrolito viene determinado por las capacidades de la doble capa entre la puerta y el canal:

$$V_{sol} = \frac{V_{GS}}{1 + \frac{c_{ch}A_{ch}}{c_gA_g}} = \frac{V_{GS}}{1 + \gamma} \quad (7)$$

No obstante, **al añadir el analito**, los electrones fluyen hacia el electrodo de puerta, y la caída de potencial entre la puerta y el electrolito decrece, como se ha comentado anteriormente. Esta contribución farádica viene descrita por la ecuación de Nernst. Dado que el potencial de puerta permanece constante, el potencial del electrolito pasa a ser:

$$V_{sol} = \frac{V_{GS}}{1 + \gamma} + \frac{kT}{ne} \ln[c] + cte \quad (8)$$

Se asume con esta ecuación que el electrolito está tamponado (la concentración de protones es constante). El primer término representa la contribución no-farádica y depende sólo de la V_{GS} y la relación γ , mientras que el segundo término representa la contribución farádica descrita por la ecuación de Nernst.

La corriente que fluye por el canal para una tensión concreta V_{DS} depende sólo del potencial del electrolito [15] y viene dada por la expresión:

$$I_{DS} = -G \left(1 - \frac{V_{sol}}{V_T} + \frac{V_{DS}}{2V_T} \right) V_{DS} \quad (9)$$

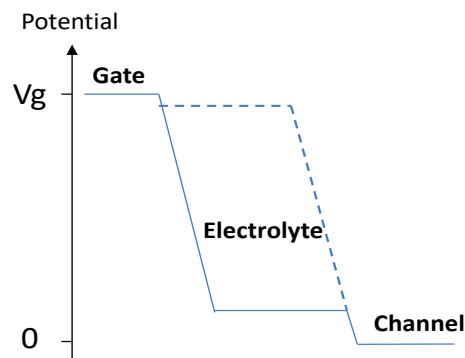

Fig. 1.25. Distribución del potencial en OECT con electrolito tamponado y sin analito (régimen no-farádico, línea continua) y con analito (régimen farádico, línea discontinua).

Tal como se ha comentado anteriormente, en el caso de un OECT en régimen no-farádico (simplemente tamponado), el potencial del electrolito está próximo al potencial del canal

(figura 1.25). En ese caso, hay una modulación de corriente muy débil. Pero si se añade el analito, el potencial del electrolito se incrementa hasta aproximarse al potencial de puerta. En ese caso, la adición del analito provoca una gran modulación de la corriente de canal. Esto implica que interesa un potencial de electrolito base (sólo tamponado) lo más próximo al potencial del canal, y esto sólo se consigue con una Υ alta, es decir con un **área de puerta pequeña**.

De todo lo anterior se puede concluir que para OECTs que trabajan como sensores electroquímicos interesa **un área de puerta menor que el área de canal** ($\Upsilon > 1$), ya que esta geometría aumenta la sensibilidad [16].

En el caso de la **corriente de puerta** I_{gs} , esta resulta de los efectos capacitivos y/o de reacciones redox. Puede ser usada como indicio del tipo de operación que se está produciendo en el OECT. En la figura 1.26 se muestra el efecto sobre la corriente de puerta de un régimen farádico y no farádico. En el régimen farádico se produce una corriente de puerta debido a los procesos redox que se producen en ella, mientras que en el régimen no-farádico no hay corriente por la puerta ya que se comporta como un condensador. El tipo de régimen viene determinado por el material de puerta, que puede ser polarizable o no polarizable dando lugar a un régimen u otro.

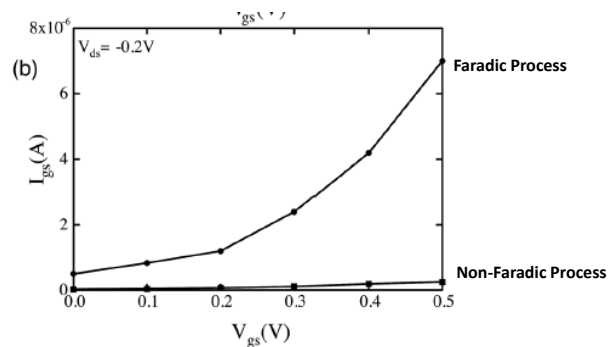

Fig. 1.26. Respuesta de la corriente de puerta frente a distintos procesos [17]

1.4. Funcionamiento y Estructura Básica de un OFET

Los OFET's, son otro tipo de transistores orgánicos; según la revisión publicada de L. Torsi [18] constituyen otros de los nuevos dispositivos desarrollados en el marco de la tecnología electrónica orgánica [19]. Los materiales típicos para su fabricación incluyen polímeros como el poli-(3-hexil-tiofeno) (P3HT) y la trifenilamina alquil-sustituida (PTAA), y oligómeros como el pentaceno y sus derivados solubles [20]. La estructura típica de un OFET se puede apreciar en la figura 1.27, el sustrato suele ser de SiO_2 sobre el que se deposita mediante distintas técnicas el material de puerta (normalmente Au), sobre la puerta se dispone el material aislante que también suele ser un dieléctrico orgánico y sobre este el semiconductor orgánico, formando así la estructura típica de un transistor MOSFET de puerta aislada.

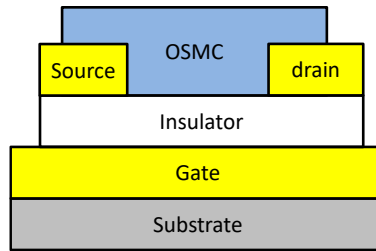

Fig. 1.27. Estructura típica de un OFET.

Antes de entrar en los detalles del funcionamiento del sensor OFET, es importante anticipar que la detección de OFET es una tecnología libre de etiquetas gracias a su simple esquema de detección, (solo una molécula de captura inmovilizada en la interfaz de del transductor), y también es altamente repetible. El uso de un OFET como sensor, en su configuración más simple, implica la exposición directa del semiconductor orgánico a la atmósfera a analizar. En este caso, el semiconductor actúa como material de transporte electrónico y como capa de detección. Si se tiene en cuenta que un OFET es capaz de generar una amplificación de corriente, una vez que el OFET se exponga a un gas, si éste modifica la respuesta eléctrica del transistor, se puede lograr una amplificación de la respuesta de detección. También se ha demostrado que es sensible y, tras una adecuada funcionalización con receptores biológicos, puede ser también selectivo. Los OFET se propusieron por primera vez como sensores químicos a finales de los años ochenta, estudiando sus características eléctricas [21], determinación de la movilidad [22] y una posteriormente revisión publicada pocos años después de estos [23].

El comportamiento de los OFETs es similar al de los transistores MOSFETs basados en silicio. En los semiconductores orgánicos de tipo-p, el dispositivo trabaja polarizando negativamente el drenador (D) y la puerta (G), siendo el terminal de referencia el surtidor (S) (figura 1.28). En ambos contactos, se aplican los potenciales V_{DS} y V_{GS} , respectivamente. Esta configuración se llama *surtidor común*. Al aplicar los potenciales, se forma un canal de cargas positivas entre el surtidor y el drenador.

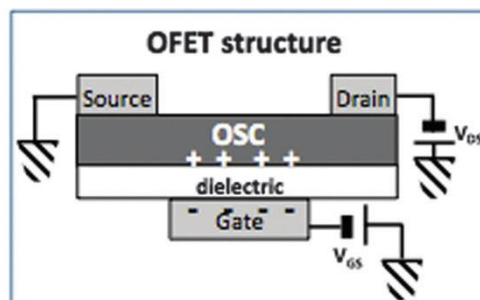

Fig. 1.28. Esquema de una estructura de dispositivo OFET típica [18].

En la figura 1.29-a, se representa las estructuras de la banda de la puerta de metal, el aislante (puerta dieléctrica) y el semiconductor orgánico (OCS) cuando no hay tensión de puerta. Las pocas cargas positivas en el OSC se deben a la presencia de dopantes de tipo-p. Al igual que la mayoría de los transistores de película fina, los OFETs funcionan en el

llamado modo acumulación. Como resultado, se genera una corriente I_{DS} que es baja en estado desactivado ($V_{GS}=0$) y alta en el estado activado (V_{GS_ON}). El cambio entre los dos regímenes de transporte se logra mediante el contacto entre la puerta y el semiconductor orgánico que forma el canal. Ambos están acoplados capacitivamente a través de la capa dieléctrica, permitiendo que las cargas se acumulen y queden confinadas en la interface entre el semiconductor y la capa dieléctrica. Mediante la aplicación de una tensión negativa V_{GS} , se controla la acumulación de cargas positivas en esta interface y, una vez fijada una tensión V_{DS} , la corriente I_{DS} fluye entre los electrodos fuente y drenador. En otras palabras, la tensión negativa V_{GS} aplicada, genera un campo eléctrico en la capa dieléctrica que produce una flexión en la banda de transporte del semiconductor (figura 1.29-b). Cuanto mayor es la tensión negativa de la puerta, mayor es la densidad de carga acumulada, y mayor la intensidad I_{DS} , por lo que, bajo estas condiciones de operación, se considera que el transistor funciona en **modo acumulación**.

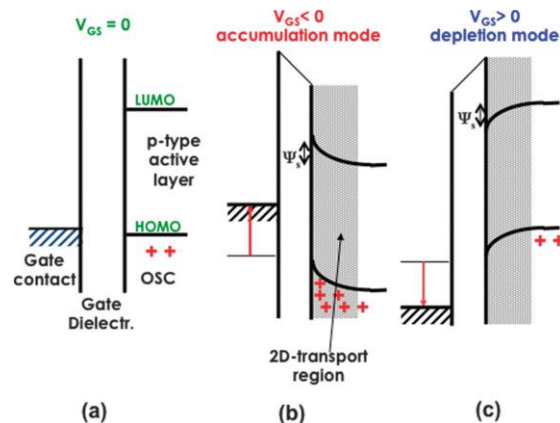

Fig. 1.29. Diagrama de bandas de la estructura de semiconductor orgánico tipo p:
 (a) puerta cero ($V_{GS} = 0$), (b) acumulación ($V_{GS} < 0$) y (c) depleción ($V_{GS} > 0$). [18]

Para un semiconductor de tipo-p, si se aplica una tensión V_{GS} positiva, el campo eléctrico repele las cargas positivas y causa el doblamiento de la banda de transporte del semiconductor, acelerando las cargas positivas hacia su parte superior (figura 1.29-c). La región del canal se agota y la corriente I_{DS} se reduce, alcanzándose el **modo agotamiento**.

Esta descripción básica del funcionamiento de un OFET, pone de manifiesto que estos transistores orgánicos son dispositivos interfaciales. La interacción entre el dieléctrico y el semiconductor orgánico es compleja y aún no se comprende por completo. No obstante, se percibe claramente que las propiedades de la interfaz dieléctrico/semiconductor influyen de diferentes maneras en el transporte y la movilidad de los portadores de carga.

1.4.1. Características I_{DS} - V_{DS}

Como se ha comentado, a medida que se aplica una tensión V_{GS} , se establecen las condiciones para la acumulación de carga. No obstante, el flujo de corriente I_{DS} no comienza hasta que se alcanza un **voltaje umbral** de puerta (V_T), que corresponde al

valor de la tensión de puerta necesario para alcanzar el estado activado del transistor. En los transistores de película delgada:

$$V_T = \frac{Q_{deep}}{C_{ox}} \quad (10)$$

Donde Q_{deep} es la densidad de carga (cargas atrapadas en el canal), y C_{ox} es la capacitancia del dieléctrico por unidad de área.

El conjunto de corrientes I_{DS} de un OFET se mide en función de V_{DS} , correspondiendo cada curva a una tensión V_{GS} prefijada (figura 1.30). A bajos valores de tensión entre drenador y surtidor ($|V_{DS}| < |V_{GS} - V_T|$), las curvas se caracterizan por una región lineal donde la corriente I_{DS} sigue la ley de Ohm, siendo proporcional a V_{DS} para una V_{GS} fija (**régimen lineal** o zona óhmica). En este régimen, el campo generado por la puerta V_{GS} es mucho mayor al generado por V_{DS} a lo largo del canal.

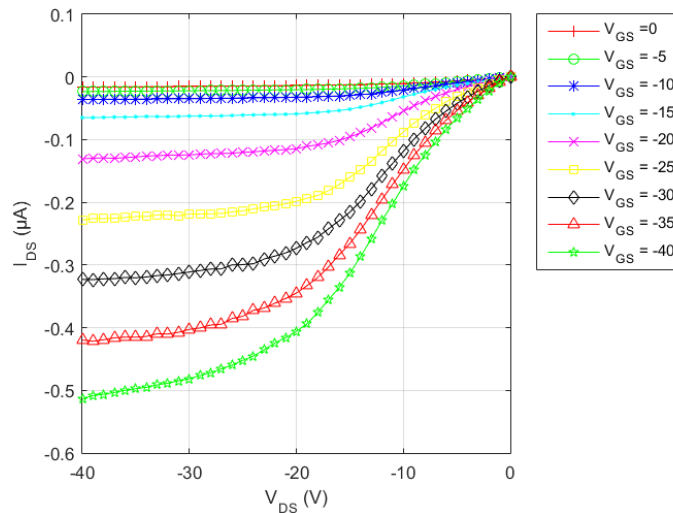

Fig. 1.30. Características I_{DS} vs. V_{DS} de un OFET realizado con TIPS-Pentacene.

A medida que el voltaje V_{DS} se hace más negativo, las cargas positivas se acumulan en el canal, hasta que se alcanza un punto en que se agotan en la región de contacto con el drenador. En ese momento, el campo a lo largo del canal generado por V_{DS} es mucho mayor que el generado por la puerta V_{GS} . La formación de esta región agotada en $|V_{DS}| > |V_{GS} - V_T|$ genera un *pinch-off* en el canal y el flujo de corriente queda limitado a un valor constante I_{DS_SAT} (**régimen de saturación**).

Las curvas características I_{DS} - V_{DS} se pueden ajustar a un modelo simplificado de dispositivo de silicio cristalino (c-Si) de canal largo trabajando a gran señal, con algunas adaptaciones para considerar las particularidades de los OFET's [24]:

- **Régimen lineal:** $I_{DS} = \frac{W}{L} C_{ox} \mu (V_{GS} - V_T - \frac{V_{DS}}{2}) \cdot V_{DS}$ para $|V_{DS}| < |V_{GS} - V_T|$ (11)

- **Régimen de saturación:** $I_{DS} = \frac{W}{2L} C_{ox} \mu (V_{GS} - V_T)^2$ para $|V_{DS}| > |V_{GS} - V_T|$ (12)

Donde W y L son el ancho y la longitud del canal, respectivamente, y μ es la movilidad, definida como la relación entre la velocidad de migración de las cargas y el campo eléctrico aplicado.

1.4.2. Caracterización eléctrica de OFETs

La norma estándar IEEE 1620-2008 [25] establece los parámetros eléctricos que se deben proporcionar para la caracterización de OFETs (tabla 1.1), así como el procedimiento para su determinación.

Tabla 1.1.- Listado mínimo requerido de los parámetros a reportar para una caracterización de eléctrica completa del dispositivo.

Característica	Símbolo estándar	Unidades
Ancho del canal	W	μm ($< 1 \text{ mm}$) mm ($\geq 1 \text{ mm}$)
Longitud del canal	L	μm
Capacidad del Dieléctrico	C_{ox}	$\text{F}\cdot\text{cm}^{-2}$
Temperatura	T	$^{\circ}\text{C}$ o K
Humedad relativa ambiental	RH	%
Movilidad de efecto campo	μ	$\text{cm}^2\cdot(\text{V}\cdot\text{s})^{-1}$
Tensión <i>Threshold</i> (Tensión umbral o de <i>pinch-off</i>)	V_T	V
Relación: on/off	I_{on}/I_{off}	adimensional

De acuerdo con esta norma, la caracterización eléctrica de un OFET requiere, como mínimo, de los siguientes conjuntos de medidas:

- ✓ **Curvas de transferencia** (I_{DS} vs. V_{GS}): permiten la determinación preliminar de la movilidad de efecto de campo (μ) y la tensión de umbral (V_T).
- ✓ **Curvas de salida** (I_{DS} vs. V_{DS}): proporcionan información sobre la saturación y el rendimiento eléctrico. Estas curvas se utilizan para determinar si el dispositivo muestra un comportamiento similar a un FET.
- ✓ **Curvas de fuga de puerta** (I_{GS} vs. V_{GS}): caracterizan la calidad dieléctrica de la puerta y cuantifican la corriente de fuga de la puerta al canal. Las mediciones de fuga se deben realizar antes de las mediciones de transferencia y de salida para garantizar la integridad dieléctrica de la puerta. La caracterización de la fuga de la puerta es necesaria para garantizar que es despreciable frente a la corriente de drenaje, de modo que se asegure la fiabilidad y utilidad de los parámetros extraídos del dispositivo.

a) Determinación de la movilidad y de la tensión de umbral

La movilidad (μ) debida al campo eléctrico no es constante en dispositivos OFET, y varía en función del régimen de funcionamiento. Se obtiene normalmente a partir de las curvas I_{DS} vs V_{GS} , figura 1.31-a, por métodos de aproximación, ya sea en régimen de saturación o lineal. La figura 1.31-b muestra la $I_{DS}^{1/2}$ vs. V_{GS} característica a V_{DS} constante tomada en la región de saturación. Esta forma de representar la I_{DS} permite determinar gráficamente la tensión umbral (V_T).

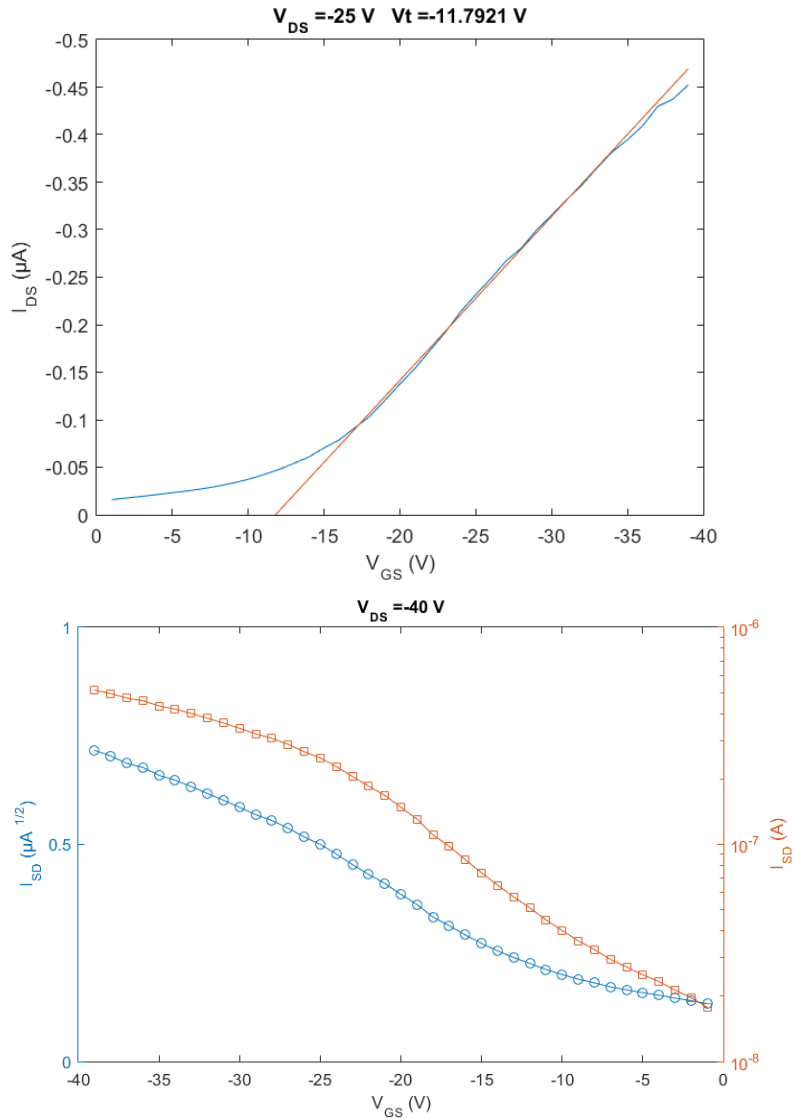

Fig. 1.31. Características: I_{DS} vs. V_{GS} ; y $I_{DS}^{1/2}$ vs. V_{GS} , de un OFET realizado con TIPS-Pentacene.

• **Régimen de saturación ($|V_{DS}| > |V_{GS} - V_T|$)**

En este régimen, la movilidad y la tensión de umbral pueden determinarse a partir de la curva experimental I_{DS} - V_{DS} . Reescribiendo la ecuación (10) de la siguiente manera:

$$\sqrt{I_{DS}} = \sqrt{\frac{W}{2L} C_{ox} \mu} \cdot (V_{GS} - V_T) = \sqrt{\frac{W}{2L} C_{ox} \mu} \cdot V_{GS} - \sqrt{\frac{W}{2L} C_{ox} \mu} \cdot V_T = a \cdot V_{GS} + b \quad (13)$$

La movilidad (μ) en régimen de saturación y la tensión de umbral (V_T) se pueden deducir gráficamente mediante el ajuste lineal de la curva experimental a esta ecuación:

$$\begin{aligned} a &= \sqrt{\frac{W}{2L} C_{ox} \mu} \quad (\text{pendiente}) \rightarrow \mu = a^2 \cdot \frac{2L}{W \cdot C_{ox}} \\ b &= -\sqrt{\frac{W}{2L} C_{ox} \mu} \cdot V_T \quad (\text{ordenada en el origen}) \rightarrow V_T = -\frac{b}{a} \end{aligned} \quad (14)$$

Los valores típicos de μ para los OFETs están en el rango de 10^{-2} a $10^{-1} \text{ cm}^2 \cdot (\text{V} \cdot \text{s})^{-1}$, aunque algunos dispositivos pueden llegar a alcanzar valores del orden de 1 a $10 \text{ cm}^2 \cdot (\text{V} \cdot \text{s})^{-1}$ [20].

- **Régimen lineal** ($|V_{DS}| < |V_{GS} - V_T|$)

En este régimen, la corriente I_{DS} depende no sólo del campo eléctrico aplicado en la puerta V_{GS} , sino también de la tensión entre el drenador y la fuente (V_{DS}), afectando esta última a la movilidad. Este parámetro se puede obtener a partir de la ecuación 11 reescrita como:

$$I_{DS} = \frac{W}{L} C_{ox} \mu \left[(V_{GS} - V_T) \cdot V_{DS} - \frac{V_{DS}^2}{2} \right] \approx \frac{W}{L} C_{ox} \mu [(V_{GS} - V_T) \cdot V_{DS}] \quad (15)$$

Derivando I_{DS} en función de V_{GS} y considerando para V_{DS} un valor determinado, se obtiene la movilidad de efecto campo en función de V_{GS} :

$$\frac{\partial I_{DS}}{\partial V_{GS}} \approx \frac{W}{L} C_{ox} \mu \cdot V_{DS} \rightarrow \mu \approx \frac{1}{C_{ox}} \frac{1}{V_{DS}} \frac{L}{W} \frac{\partial I_{DS}}{\partial V_{GS}} \quad (16)$$

La derivada I_{DS} en función de V_{GS} se puede determinar mediante alguno de los siguientes métodos:

$$\begin{aligned} \frac{\partial I_{DS}}{\partial V_{GS}} &= \frac{I_{DS}(V+h) - I_{DS}(V)}{h}; \text{Backward Derivative (B.D)} \\ \frac{\partial I_{DS}}{\partial V_{GS}} &= \frac{I_{DS}(V+h) - I_{DS}(V-h)}{2h}; \text{Two Points derivative (T.P)} \end{aligned} \quad (17)$$

En la figura 1.32 se puede observar la dependencia de la movilidad en función de la tensión de puerta (V_{GS}).

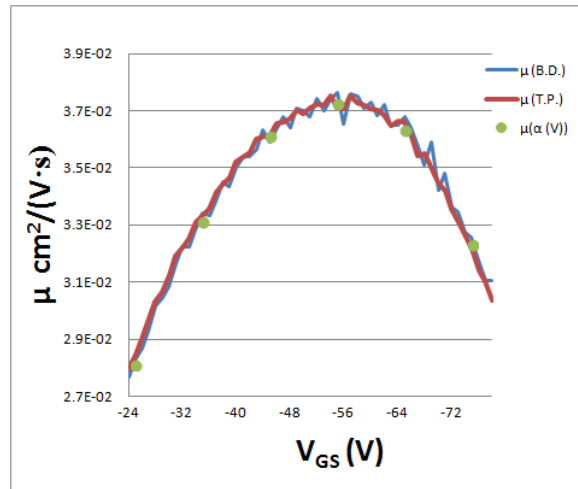

Fig. 1.32. Curva de movilidad vs. V_{GS} , obtenida por mediante el *Backward Derivative* (B.D.), *Two Points Derivative* (T.P.) y *Least square fit derivative* (α) ($\alpha(V)$). (Pier Paolo Marchisio, PhD; OSSILA [26])

Según la norma estándar IEEE 1620-2008, si el transistor muestra una dependencia sustancial (superior al 10%) de la movilidad con respecto a la tensión de puerta aplicada, esto debe indicarse mediante la inclusión de la curva que muestre la movilidad trazada en un segundo eje para la corriente de drenador.

b) Determinación de la relación I_{on}/I_{off}

Otro parámetro de interés en un OFET es la relación entre la corriente de encendido/apagado, definida como la relación entre los valores máximo y mínimo de I_{DS} en on y off de conducción en el canal. Esto es indicativo del rendimiento de conmutación del dispositivo entre los dos regímenes de conducción. Esta relación se obtiene durante una medición de curva de transferencia. Hay que tener en cuenta que esta relación puede ser diferente para los diferentes valores de V_{DS} utilizados en la medición de transferencia.

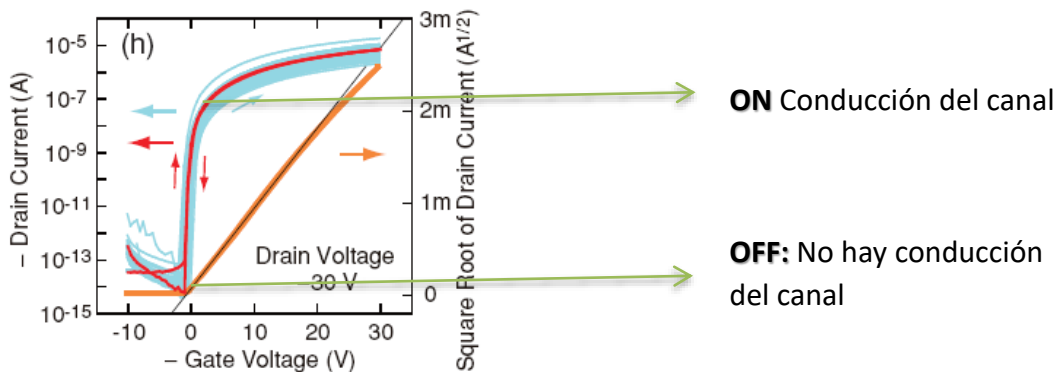

Fig. 1.33. Curva de Transferencia I_{DS} vs. V_{GS} , para un valor de V_{DS} fijo. (Berta Gómez-Lor [27])

1.5. Fabricación de Transistores Orgánicos

1.5.1. Fabricación de OECTs basados en PEDOT:PSS

Los OECTs utilizados en esta tesis se basan en el polímero semiconductor PEDOT: PSS, el cual se comercializa bajo distintos nombres por varias empresas: *Clevios* (Heraeus), *Clear Conductor* (Gwent), *PEDOT:PSS* (Sigma Aldrich) y *Baytron P* (Bayer). La mayoría de los fabricantes suministran este polímero en forma de tinta para su utilización en técnicas denominadas de *electrónica impresa*, que consisten en utilizar los métodos tradicionales de impresión (huecograbado, flexografía, inyección de tinta, serigrafía) para la fabricación de componentes electrónicos. De entre los diversos productos comerciales, se han utilizado tintas *Clevios* (Heraeus) y *Clear Conductor* (Gwent) para la fabricación de los OECTs.

Los OECTs estudiados en esta tesis, se han fabricado por serigrafía (*screen-printing*). La serigrafía consiste en transferir una tinta a través de una malla tensada en un marco. El paso de la tinta se bloquea en las áreas donde no habrá imagen mediante una emulsión o barniz, quedando libre la zona donde pasará la tinta (figura 1.34). La utilización de esta tecnología para el desarrollo de sensores es relativamente nueva, apareciendo las primeras publicaciones a partir de los años 80. La figura 1.35 muestra el proceso y resultado de aplicar la serigrafía a la producción de electrodos.

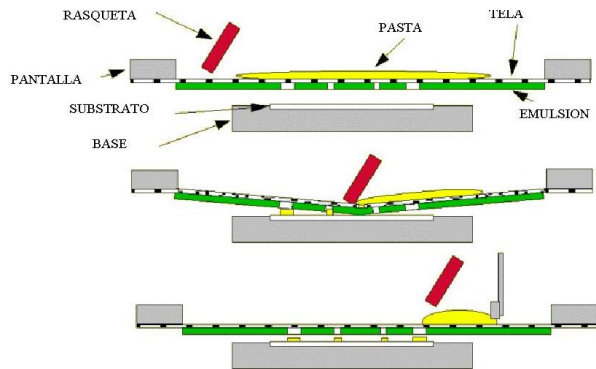

Fig. 1.34.- Proceso serigráfico.

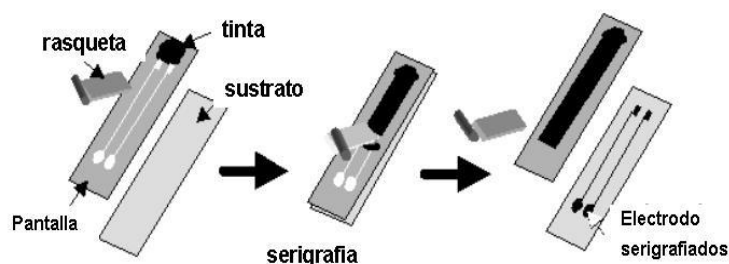

Fig. 1.35. Obtención de un electrodo mediante técnicas serigráficas.

Para la fabricación de los OECT's por serigrafía se han seguido las indicaciones proporcionadas por el fabricante de las tintas de PEDOT:PSS empleadas (Tabla 1.2).

Tabla 1.2. Recomendaciones para la fabricación de OEETs por serigrafía con tintas Clevios S (Heraeus).

Parámetro	Características recomendadas
Agitación inicial de la tinta	Velocidad: 1000 - 2000 rpm Tiempo: 30 min - 1 h
Tela de poliéster	140 mesh·cm ⁻¹ diámetro de hilo: 31 μm
Sustratos	Vidrio Alúmina Plástico (PC, PET, PEN) → requiere tratamiento superficial de corona para mejorar la adhesión
Distancia entre pantalla y sustrato	3mm
Rasqueta	Dureza: 75° shore Ángulo: 70° Presión: 1 bar Velocidad: 0.6 m·s ⁻¹
Curado	Temperatura: 200°C Tiempo: 10 min

¹Las recomendaciones para la fabricación de OEETS con tinta C2100629D1 (Gwent) son muy similares a las proporcionadas por Heraeus.

1.5.2. Fabricación de OFET's basados en TIPS-Pentacene

semiconductores orgánicos por deposición e impresión, para la fabricación de OFETs. Los **métodos de deposición** más comunes incluyen [28], [29]:

- *Spin-coating*: recubrimiento por centrifugación. Es un procedimiento utilizado para depositar películas delgadas uniformes en sustratos planos. Por lo general, se aplica una pequeña cantidad de material de recubrimiento en el centro del sustrato el cual gira a alta velocidad para extender el material por la fuerza centrífuga.
- *Drop-casting*: deposición por evaporación. Es el impacto de una gota de solución sobre un sustrato, generalmente resulta por la dispersión de la solución líquida y la formación de una película sólida delgada no uniforme después de la evaporación del solvente.
- *Dip coating*: recubrimiento por inmersión
- *Spray*: rociado
- *Blade coating*: técnicas con rasquetas
- *Roll coating*: flexografía o huecograbado.

Los OFETs utilizados en esta tesis se han fabricado a partir de chips prefabricados comerciales (OSSILA), sobre los que se ha depositado *TIPS-pentacene* mediante *Spin-Coating* y *Drop-Casting*.

El *spin-coating* se ha realizado con un equipo de *spin-coat* en cámara de flujo laminar con una velocidad y volumen determinados previamente mediante distintos ensayos.

El *drop-casting* se ha realizado en cámara de flujo laminar con secado en una placa calefactora. En este caso, se ha seguido el proceso recomendado por el fabricante de los chips (OSSILA):

- El OFET se coloca en una placa Petri con una placa fina debajo para que quede inclinado.
- La placa Petri se calienta en una placa calefactora a 50°C.
- Se deja caer una gota (50 μ l) de *TIPS-Pentacene* sobre el OFET y se tapa la placa Petri durante 5 minutos a 50°C.
- Finalmente, se apaga la placa calefactora y se sustituye la tapa de vidrio por un papel. Se deja reposar 1 minuto con cuidado de que no caigan sobre el sustrato las gotas condensadas sobre la tapa.

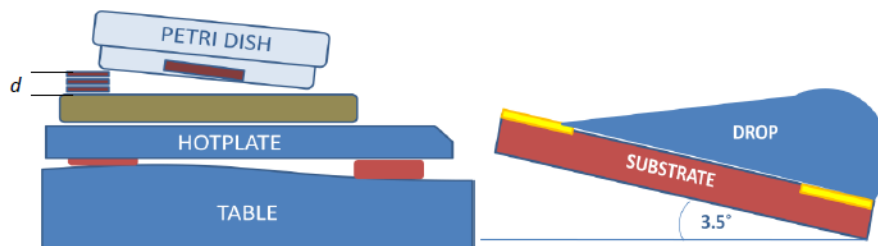

Fig. 1.37. Deposición de *TIPS-Pentacene* por *Drop-Casting* aconsejado por OSSILA.

1.6. Bibliografía complementaria

Existe mucha información ampliada en libros que han ido recopilando los trabajos desarrollados y los resultados obtenidos gracias al afán de descubrir todas las posibilidades que se abren en esta nueva área de la tecnología electrónica orgánica. Unos dedicados a desarrollar técnicas de circuitos analógicos que pueden utilizarse para aumentar el rendimiento de los circuitos orgánicos [30]. Otros a revisar los avances recientes que cubren las tres facetas importantes de la electrónica orgánica: los compuestos y materiales químicos, las técnicas de fabricación y los dispositivos resultantes, junto con sus aplicaciones actuales de [31] a [42].

2. OBJETIVOS

El **objetivo general** de esta tesis es el diseño y la caracterización de distintos tipos de OTFT's para su aplicación en el sensado químico de analitos.

Para ello, se proponen los siguientes **objetivos concretos**:

1. **Diseño y caracterización de OTFT's** tanto en su versión OFET's como OECT's. Se estudiarán los distintos tipos de estructuras posibles, así como los materiales para la capa activa, dieléctrica y conductora. En esta fase, se seleccionarán los materiales más adecuados, así como las tecnologías de fabricación más convenientes.
2. **Aplicación de los sensores basados en los OTFT's** obtenidos en el primer objetivo. En esta fase, se estudiará su aplicación como sensores químicos de analitos en disoluciones líquidas y gaseosas. Para ello, se determinará la mejor interface analito-semiconductor para su precisa detección, y se obtendrán experimentalmente los límites de detección de cada sensor. Finalmente, se desarrollarán los sistemas electrónicos ad hoc para cada sensor.
3. **Desarrollo de un equipo de medida** de bajo coste para las aplicaciones específicas de este proyecto. La validación de este equipo se realizará por comparación con los resultados obtenidos con equipos estándar.

Los resultados obtenidos en el desarrollo de esta tesis se incluyen en los artículos publicados que constituyen el Capítulo 2 de esta memoria. En la tabla 1.3 se resume para cada uno de ellos, el tipo de transistor, el material semiconductor orgánico, el método de procesado y el analito considerado para su aplicación como sensor.

Tabla 1.3.- Resumen de los artículos publicados basados en esta tesis.

<i>Artículo</i>	<i>Tipo de OTFT</i>	<i>Material semiconductor</i>	<i>Procesado</i>	<i>Analito</i>
1	OECT	PEDOT:PSS	<i>Thick-film</i>	Cationes: Rodamina.
2	OECT	PEDOT:PSS	<i>Thick-film</i>	Ácido Ascórbico
3	OFET	<i>TIPS-PENTACENE</i>	<i>Spin-Coat</i> <i>Drop-casting</i>	Gases simulantes de guerra

3. REFERENCIAS BIBLIOGRÁFICAS

- [1] Hulanicki, A., Glab, S., & Ingman, F. O. L. K. E. (1991). Chemical sensors: definitions and classification. *Pure and Applied Chemistry*, 63(9), 1247-1250.
- [2] Wolfbeis, O. S. (1990). Chemical sensors—survey and trends. *Fresenius' Journal of Analytical Chemistry*, 337(5), 522-527.
- [3] Sanchez, L. G., Rodrigo, L. C., & Garcia-Breijo, E. (2016). Ion sensors based on organic transistors. *Organic Sensors: Materials and Applications*, 257 (7).
- [4] Koezuka, H., Tsumura, A., & Ando, T. (1987). Field-effect transistor with polythiophene thin film. *Synthetic Metals*, 18(1-3), 699-704.
- [5] Mannerbro, R., & Rånlöf, M. (2007). Inkjet and Screen Printed Electrochemical Organic Electronics.
- [6] Berggren, M., Forchheimer, R., Bobacka, J., Svensson, P. O., Nilsson, D., Larsson, O., & Ivaska, A. (2008). PEDOT: PSS-based electrochemical transistors for ion-to-electron transduction and sensor signal amplification. In *Organic Semiconductors in Sensor Applications* (pp. 263-280). Springer, Berlin, Heidelberg.
- [7] Bernards, D. A., Malliaras, G. G., Toombes, G. E., & Gruner, S. M. (2006). Gating of an organic transistor through a bilayer lipid membrane with ion channels. *Applied physics letters*, 89(5), 053505.
- [8] Mousavi, Z., Ekholm, A., Bobacka, J., & Ivaska, A. (2009). Ion-Selective Organic Electrochemical Junction Transistors Based on Poly (3, 4-ethylenedioxythiophene) Doped with Poly (styrene sulfonate). *Electroanalysis: An International Journal Devoted to Fundamental and Practical Aspects of Electroanalysis*, 21(3-5), 472-479.
- [9] Lin, P., Yan, F., & Chan, H. L. (2010). Ion-sensitive properties of organic electrochemical transistors. *ACS applied materials & interfaces*, 2(6), 1637-1641.
- [10] Bernards, D. A., Macaya, D. J., Nikolou, M., DeFranco, J. A., Takamatsu, S., & Malliaras, G. G. (2008). Enzymatic sensing with organic electrochemical transistors. *Journal of Materials Chemistry*, 18(1), 116-120.
- [11] Loi, A., Manunza, I., & Bonfiglio, A. (2005). Flexible, organic, ion-sensitive field-effect transistor. *Applied Physics Letters*, 86(10), 103512.
- [12] Nilsson, D. (2005). *An organic electrochemical transistor for printed sensors and logic* (Doctoral dissertation, Institutionen för teknik och naturvetenskap).
- [13] Bernards, D. A., & Malliaras, G. G. (2007). Steady-state and transient behavior of organic electrochemical transistors. *Advanced Functional Materials*, 17(17), 3538-3544.
- [14] Yaghmazadeh, O., Cicoira, F., Bernards, D. A., Yang, S. Y., Bonnassieux, Y., & Malliaras, G. G. (2011). Optimization of organic electrochemical transistors for sensor applications. *Journal of Polymer Science Part B: Polymer Physics*, 49(1), 34-39.
- [15] Larrimore, L., Nad, S., Zhou, X., Abruna, H., & McEuen, P. L. (2006). Probing electrostatic potentials in solution with carbon nanotube transistors. *Nano letters*, 6(7), 1329-1333.

- [16] Cicoira, F., Sessolo, M., Yaghmazadeh, O., DeFranco, J. A., Yang, S. Y., & Malliaras, G. G. (2010). Influence of device geometry on sensor characteristics of planar organic electrochemical transistors. *Advanced Materials*, 22(9), 1012-1016.
- [17] Tarabella, G., Santato, C., Yang, S. Y., Iannotta, S., Malliaras, G. G., & Cicoira, F. (2010). Effect of the gate electrode on the response of organic electrochemical transistors. *Applied Physics Letters*, 97(12), 205.
- [18] Torsi, L., Magliulo, M., Manoli, K., & Palazzo, G. (2013). Organic field-effect transistor sensors: a tutorial review. *Chemical Society Reviews*, 42(22), 8612-8628.
- [19] Dodabalapur, A. (2006). Organic and polymer transistors for electronics. *Materials Today*, 9(4), 24-30.
- [20] Wang, C., Dong, H., Hu, W., Liu, Y., & Zhu, D. (2011). Semiconducting π -conjugated systems in field-effect transistors: a material odyssey of organic electronics. *Chemical Reviews*, 112(4), 2208-2267.
- [21] Laurs, H., & Heiland, G. (1987). Electrical and optical properties of phthalocyanine films. *Thin Solid Films*, 149(2), 129-142.
- [22] Assadi, A., Gustafsson, G., Willander, M., Svensson, C., & Inganäs, O. (1990). Determination of field-effect mobility of poly (3-hexylthiophene) upon exposure to NH₃ gas. *Synthetic Metals*, 37(1-3), 123-130.
- [23] Guillaud, G., Al Sadoun, M., Maitrot, M., Simon, J., & Bouvet, M. (1990). Field-effect transistors based on intrinsic molecular semiconductors. *Chemical Physics Letters*, 167(6), 503-506.
- [24] Kymissis, I. (2008). *Organic field effect transistors: theory, fabrication and characterization*. Springer Science & Business Media. (6), 75-82.
- [25] J. IEEE Standard for Test Methods for the Characterization of Organic Transistors and Materials. *IEEE Std 1620-2008*, 1-14.
- [26] <https://www.ossila.com/>
- [27] Gomez-Lor B., transparencias. CSIC.
- [28] Kymissis, I. (2008). Organic field effect transistors: theory, fabrication and characterization. Springer Science & Business Media. (4), 38-41
- [29] Parashkov, R., Becker, E., Riedl, T., Johannes, H. H., & Kowalsky, W. (2005). Large area electronics using printing methods. *Proceedings of the IEEE*, 93(7), 1321-1329.
- [30] Marien, H., Steyaert, M., & Heremans, P. (2012). *Analog Organic Electronics: Building Blocks for Organic Smart Sensor Systems on Foil*. Springer Science & Business Media.
- [31] Klauk, H. (Ed.). (2006). *Organic electronics: materials, manufacturing, and applications*. John Wiley & Sons.
- [32] Klauk, H. (Ed.). (2012). *Organic electronics II: more materials and applications* (Vol. 2). John Wiley & Sons.
- [33] Bernards, D. A., Owens, R. M., & Malliaras, G. G. (2008). Organic semiconductors in sensor applications.

- [34] Shinar, R., & Shinar, J. (2009). *Organic electronics in sensors and biotechnology*. McGraw-Hill, Inc.
- [36] Köhler, A., & Bässler, H. (2015). *Electronic processes in organic semiconductors: An introduction*. John Wiley & Sons.
- [37] Li, Q. (2011). *Self-organized organic semiconductors: from materials to device applications*. John Wiley & Sons.
- [38] Brütting, W. (Ed.). (2006). *Physics of organic semiconductors*. John Wiley & Sons.
- [39] Moiz, S. A., Karimov, K. S., & Ahmed, M. M. (2010). *Electrical Characterization of Novel Organic Semiconductor: Materials and Devices for Sensor Technology*. VDM Publishing.
- [40] Berggren, M., Nilsson, D., & Robinson, N. D. (2007). Organic materials for printed electronics. *Nature materials*, 6(1), 3.
- [41] Nisato, G., Lupo, D., & Ganz, S. (Eds.). (2016). *Organic and Printed Electronics: Fundamentals and Applications*. CRC Press.
- [42] Cantatore, E. (2013). Applications of organic and printed electronics. *A Technology-Enabled Revolution*. New York: Springer Science+ Business Media, 180.

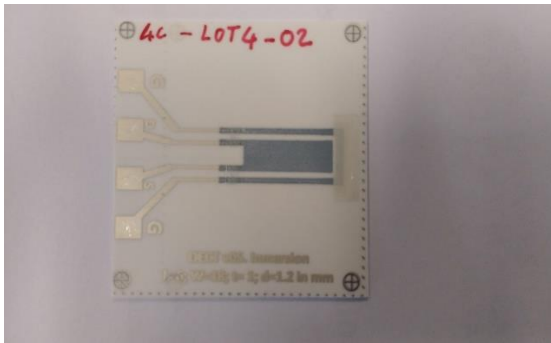

Capítulo 2: Publicaciones

Artículos en Editoriales Internacionales Indexadas

1. *Characterization of Screen-Printed Organic Electrochemical Transistors to Detect Cations of Different Sizes.*
2. *Screen-printed Organic Electrochemical Transistors for the Detection of Ascorbic Acid in Food.*
3. *Inexpensive Measuring System for the Characterization of Organic Transistors.*



sensors

Contat-Rodrigo, L.; Pérez-Fuster, C.; Lidón-Roger, J.V.; Bonfiglio, A.; García-Breijo, E. **Characterization of Screen-Printed Organic Electrochemical Transistors to Detect Cations of Different Sizes.** *Sensors* 2016, *16*, 1599.

Journal Impact Factor 2016: **2.677**
Quartile (Instruments & Instrumentation): **Q1**

Article

Characterization of Screen-Printed Organic Electrochemical Transistors to Detect Cations of Different Sizes

Laura Contat-Rodrigo ¹, Clara Pérez-Fuster ¹, José Vicente Lidón-Roger ¹, Annalisa Bonfiglio ² and Eduardo García-Breijo ^{1,*}

¹ Group of Electronic Development and Printed Sensors (GEDPS), Centro de Reconocimiento Molecular y Desarrollo Tecnológico, Unidad Mixta UPV-UV, Valencia 46022, Spain; lcontat@ter.upv.es (L.C.-R.); cperezf@eln.upv.es (C.P.-F.); jvlidon@eln.upv.es (J.V.L.-R.)

² Dipartimento di Ingegneria Elettrica ed Elettronica, Università di Cagliari, Piazza d' Armi, Cagliari 09123, Italy; annalisa@diee.unica.it

* Correspondence: egarciab@eln.upv.es; Tel.: +34-96-3877-608

Academic Editor: W. Rudolf Seitz

Received: 5 July 2016; Accepted: 14 September 2016; Published: 28 September 2016

Abstract: A novel screen-printing fabrication method was used to prepare organic electrochemical transistors (OECTs) based on poly(3,4-ethylenedioxythiophene) doped with polystyrene sulfonate (PEDOT:PSS). Initially, three types of these screen-printed OECTs with a different channel and gate areas ratio were compared in terms of output characteristics, transfer characteristics, and current modulation in a phosphate buffered saline (PBS) solution. Results confirm that transistors with a gate electrode larger than the channel exhibit higher modulation. OECTs with this geometry were therefore chosen to investigate their ion-sensitive properties in aqueous solutions of cations of different sizes (sodium and rhodamine B). The effect of the gate electrode was additionally studied by comparing these all-PEDOT:PSS transistors with OECTs with the same geometry but with a non-polarizable metal gate (Ag). The operation of the all-PEDOT:PSS OECTs yields a response that is not dependent on a Na⁺ or rhodamine concentration. The weak modulation of these transistors can be explained assuming that PEDOT:PSS behaves like a supercapacitor. In contrast, the operation of Ag-Gate OECTs yields a response that is dependent on ion concentration due to the redox reaction taking place at the gate electrode with Cl⁻ counter-ions. This indicates that, for cation detection, the response is maximized in OECTs with non-polarizable gate electrodes.

Keywords: organic electrochemical transistors; screen-printing; PEDOT:PSS; large-size cations

1. Introduction

Organic electronics has been extensively developed since the discovery of conducting polymers in the late 1970s [1,2] due to the unique features that these materials can offer, such as low-cost fabrication, low temperature processing, mechanical flexibility, ionic conductivity, and facile chemical modification [3]. As a result, many electronic devices based on organic semiconductors have been developed, including organic light emitting diodes (OLEDs) [4], organic photovoltaics (OPVs) [5], and organic thin film transistors (OTFTs) [6,7]. Among the latter, organic electrochemical transistors (OECTs) have attracted considerable interest in recent years for their application as organic semiconductor devices in many fields, especially for chemical and biological sensing due to their ability to operate in aqueous environments [8,9].

OECTs were initially reported by White in the 1980s [10]. The essential components of an OECT are an organic semiconductor film (in its doped-conducting-state), the channel, with source and drain electrodes, and an electrolyte bridging the channel and the gate electrode. As a convention, the

source electrode is grounded and a voltage is applied to the drain electrode relative to the ground. The operation of OEETs is based on the modulation of the channel current by electrochemical doping or de-doping from the electrolyte when gate voltages are applied.

One of the most widely used conducting polymers in these types of devices is poly(3,4-ethylenedioxythiophene) doped with polystyrene sulfonate (PEDOT:PSS) [11,12]. PEDOT:PSS is a degenerately doped p-type organic semiconductor that is commercially available and can be readily prepared by using conventional solution processing techniques [13–15]. In addition, it exhibits high conductivity, excellent thermal stability, and good stability in a wide pH range. Upon the application of a positive gate voltage in PEDOT:PSS-based OEETs, cations from the electrolyte medium migrate into the conducting polymer [16,17]. This in turn de-dopes PEDOT:PSS and leads to a decrease in the channel current. De-doping occurs by reduction of the highly conducting form of PEDOT⁺ to the less conducting form of PEDOT⁰ [18], according to the following electrochemical reaction:



where M^{n+} is a cation in the electrolyte medium, n is the number of charge of the cation, and e^- is an electron from the source electrode. When the gate voltage is removed, cations migrate back into the electrolyte medium, and the original conductivity of the organic semiconductor is restored.

As a result of this working principle, the characteristics of OEETs based on PEDOT:PSS are usually sensitive to the ion concentration in the electrolyte. On this basis, these devices have been successfully employed as chemical and biological sensors [17,19]. A comprehensive description of the ion-sensitive behavior of these devices is therefore critical for their optimization for sensing applications. Lin first studied the ion-sensitive properties of these types of devices in aqueous solutions with different cationic species (H^+ , K^+ , Na^+ , Ca^{2+} , and Al^{3+}), finding that the transfer curves shift to lower gate voltage horizontally with the increase in the concentration of cations [19]. This shift was also found to be dependent on the type of ion in the electrolyte, decreasing with the increase in the ionic charge.

More recently, Malliaras et al. reported on the mobility of various cations in PEDOT:PSS films, proving that this polymer is an efficient ion transporter, not only of small cations such as H^+ , K^+ , and Na^+ , but also of choline ($\text{C}_5\text{H}_{14}\text{NO}^+$), a biologically-relevant ion of larger size [20]. However, efficient transport of large ions through this material has not been yet reported, despite the interest of knowing the maximum detectable size of chemical and biological analytes for sensing applications.

In OEETs based on PEDOT:PSS, the gate electrode also plays an important role with respect to its ion-sensitive properties. Lin demonstrated that, for devices with Ag/AgCl gate electrodes, Nernstian relationships are found, whereas for devices with metal gate electrodes (Pt and Au), the ion sensitivity is higher than that given by the Nernst equation [19].

The device geometry is another critical issue to the ion-sensitive behavior of OEETs based on PEDOT:PSS. Optimization of the performance of these devices can be achieved by changing the ratio between the channel and gate areas, and the channel geometry (width and length) [21,22].

The practical implementation of these different geometries ultimately depends on the processing techniques that are used for the fabrication of these transistors. Many innovative techniques have been developed in the last decade for the fabrication of OEETs. In particular, there has been a significant increase in the interest in using printing techniques, since these provide a wide range of advantages compared to traditional fabrication techniques of silicon-based electronics. One of the most important advantages is the possibility of working with flexible substrates. Furthermore, printing techniques (inkjet, gravure, serigraphy, etc.) can be combined with high-throughput roll-to-roll manufacturing techniques (screen-printing, flexography, etc.) to produce low-cost organic electronic devices. Although printing techniques offer many advantages, only a few examples of the fabrication of OEETs using these technologies are reported in the literature [15,23,24]. In general, these types of transistors are prepared using alternative and more expensive techniques, such as lithography [16,21,22,25,26].

In this communication, we report on the characterization of various PEDOT:PSS-based OEETs prepared using a screen-printing technique over a flexible substrate. Screen-printed transistors with different geometries are compared in terms of their electrical characteristics and current modulation. In addition, the effect of the gate electrode on the ion-sensitive properties of these OEETs in aqueous solutions of cations of different sizes is also investigated.

2. Materials and Methods

Preparation of the phosphate buffered saline (PBS) solution: A 0.1-M PBS solution was prepared by dissolving K_2HPO_4 (Scharlau, Barcelona, Spain) and KH_2PO_4 (Probus, Badalona, Spain) in Milli-Q water. The PBS solution had a pH of 6.8, as measured by a pH meter.

Preparation of NaCl solutions: Aqueous solutions containing sodium cations (Na^+) were prepared by dissolving sodium chloride (Scharlau) in Milli-Q water with different molar concentrations (10^{-3} M, 10^{-4} M, and 10^{-5} M).

Preparation of rhodamine solutions: Aqueous solutions containing rhodamine B cations ($C_{28}H_{31}N_2O_3^+$) were prepared by dissolving rhodamine B ($C_{28}H_{31}ClN_2O_3$) (Sigma-Aldrich, Madrid, Spain) in Milli-Q water with different molar concentrations (10^{-3} M, 10^{-4} M, and 10^{-5} M).

Transistor fabrication: For the fabrication of the OEETs, PEDOT:PSS was screen-printed over polyester film. Screen-printing was performed with a polyester mesh screen PET 1500 165/420-34W/32 μm (SEFAR, Barcelona, Spain) and an UV film DIRASOL 132 (FUJIFILM, Barcelona, Spain). The final screen thickness was 55 μm . The OEETs pattern was transferred to screen by using an UV light. PEDOT:PSS CLEVIOS S V3 (Heraeus, Madrid, Spain) (Table 1) was mixed with ethylene glycol (4:1 by volume). The mixture was re-dispersed for 1 h at 1000 rpm before printing. Printing was carried out by using AUREL 900 with a 75° shore squeegee hardness, 1 bar force, and 0.2 m/s. The substrate used was a transparent and flexible polyester MELINEX ST506 (thickness of 175 μm , DuPont Teijin Films, Scotland, UK) cleaned with acetone, ethanol, and deionized water. Finally, the OEETs were cured in an air oven at 80 °C for 5 min.

Table 1. Main characteristics of the CLEVIOS screen-printing inks (Heraeus).

Grade	Application	Resistivity	Viscosity
CLEVIOS S HT	High transparency	1000 Ω/sq	3–5 dPas
CLEVIOS S V3	Standard	700 Ω/sq	15–60 dPas
CLEVIOS S V3 HV	Fine line	700 Ω/sq	60–180 dPas
CLEVIOS S V4	High conductivity	400 Ω/sq	15–60 dPas

Electrical measurements: All measurements were performed using a Keithley 4200 semiconductor characterization system.

Cyclic voltammetry experiments: The electrochemical characterization was carried out with an Autolab PGSTAT12 potentiostat/galvanostat electrochemical analysis system.

3. Results and Discussion

3.1. Electrical Characterization: Effect of the Device Geometry

Three types of all-PEDOT:PSS screen-printed transistors with different geometries were prepared by modifying the ratio between the channel and gate areas A_{ch}/A_g (γ) (where A_{ch} is the channel area and A_g is the gate area) (Figure 1). Type 1 OEET is a symmetric device with $\gamma = 1$. In contrast, type 2 and type 3 OEETs are asymmetric devices with $\gamma = 0.5$ and $\gamma = 2$, respectively.

These three types of all-PEDOT:PSS OEETs were initially characterized in a PBS solution. Electrical measurements were performed, filling the electrolyte reservoir with 150 μL of aqueous 0.1-M PBS. The output characteristics, the transfer characteristics, and the current modulation of each type of OEET were obtained and compared.

Figure 2 shows the output curves of the all-PEDOT:PSS transistors with different channel and gate areas. It can be observed that the geometry has a large influence on the output characteristics of these OECTs. Results clearly show that the transistor with a small area ratio ($\gamma = 0.5$) exhibits a strong modulation of the drain current (I_{DS}) (Figure 2a), while the modulation of this current is weaker for the transistor with a large area ratio ($\gamma = 2$) (Figure 2c) [22].

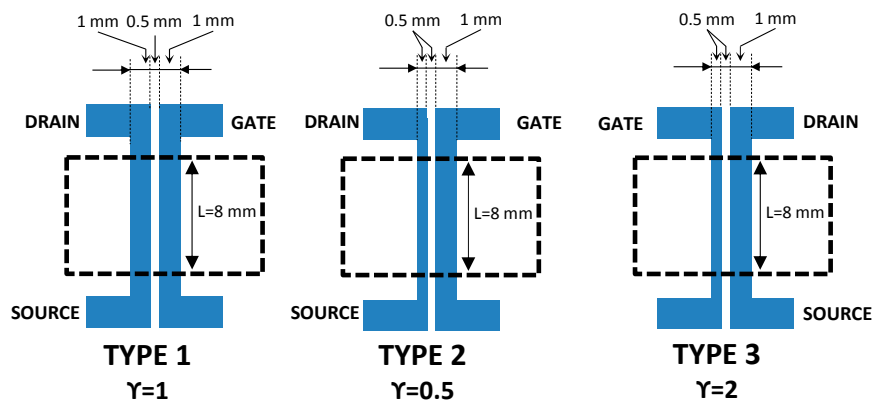

Figure 1. Schematic representation of the devices layout with three different ratios between the channel and gate areas.

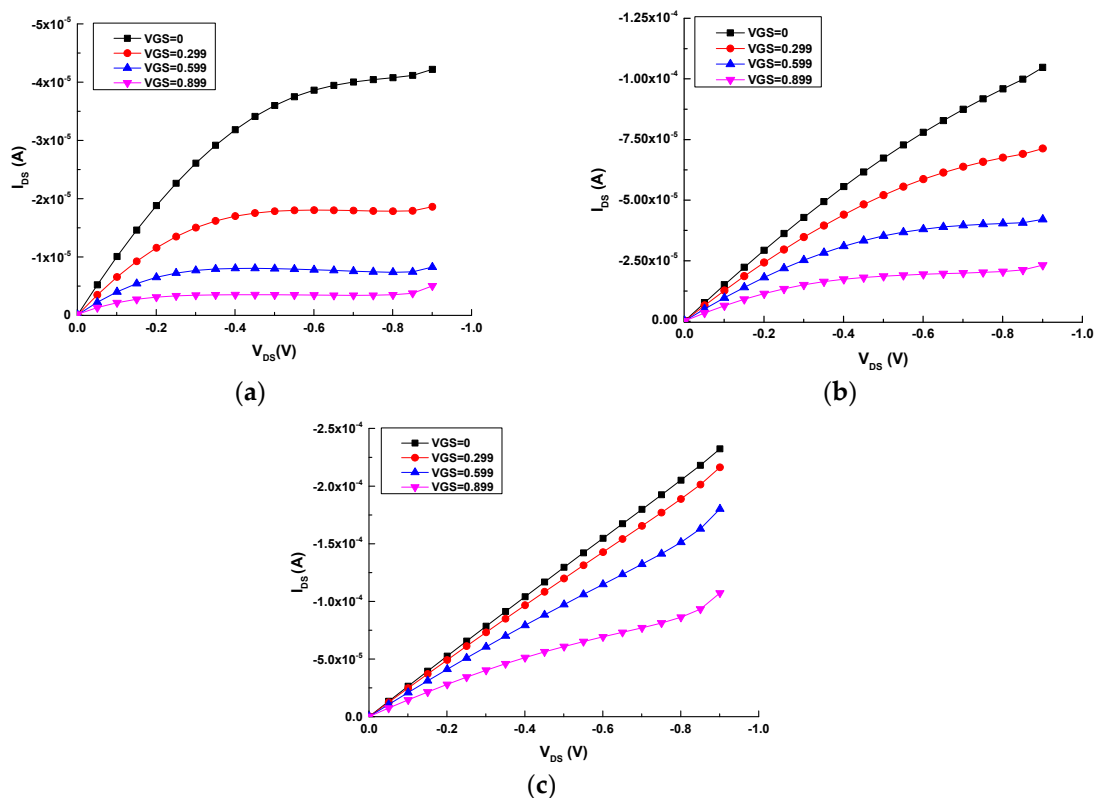

Figure 2. Output characteristics of the three types of all-PEDOT:PSS OECTs: (a) Type 2 ($\gamma = 0.5$); (b) Type 1 ($\gamma = 1$); (c) Type 3 ($\gamma = 2$).

Concerning the transfer characteristics of these screen-printed OECTs, these were obtained plotting the drain current (I_{DS}) (normalized to its maximum value) vs. the gate voltage (V_{GS}) from -0.9 V to 0.9 V under a constant drain voltage (V_{DS}) (Figure 3). It can be noticed that the maximum (on) current is reached for negative values of V_{GS} , indicating that negative gate-source voltage leads to

a further doping of PEDOT:PSS in the channel [15,23]. Moreover, it is observed that the offset voltage (V_{off}) depends on the geometry, as for metal-gated structures.

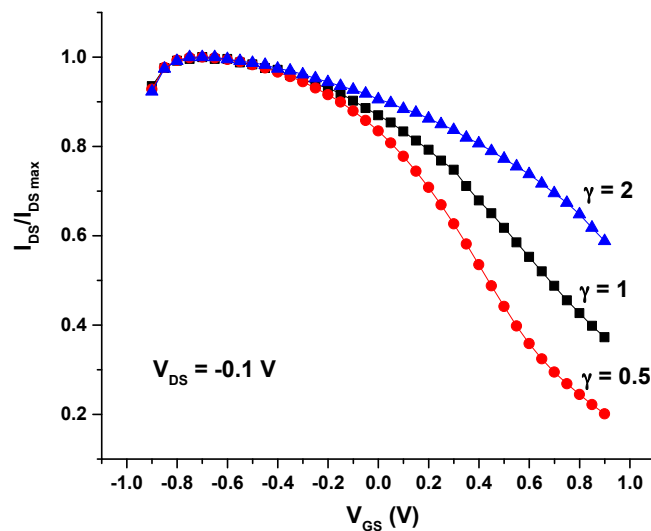

Figure 3. Normalized I_{DS} vs. V_{GS} curve for the three types of all-PEDOT:PSS OEECTs.

Finally, the current modulation of these all-PEDOT:PSS OEECTs was determined. Plots of $\Delta I/I_0$ ($\Delta I/I_0 = (|I - I_0|/I_0)$), where I is the off current ($V_{GS} \neq 0$) and I_0 is the on current ($V_{GS} = 0$), vs. the gate voltage (V_{GS}) for different values of γ are shown in Figure 4a. The different responses for the OEECTs with different geometries are highlighted. The OEECT with the smallest γ (large gate) exhibits the highest modulation throughout all the investigated V_{GS} range, while the OEECT with a large γ (large channel) exhibits little modulation (Figure 4a).

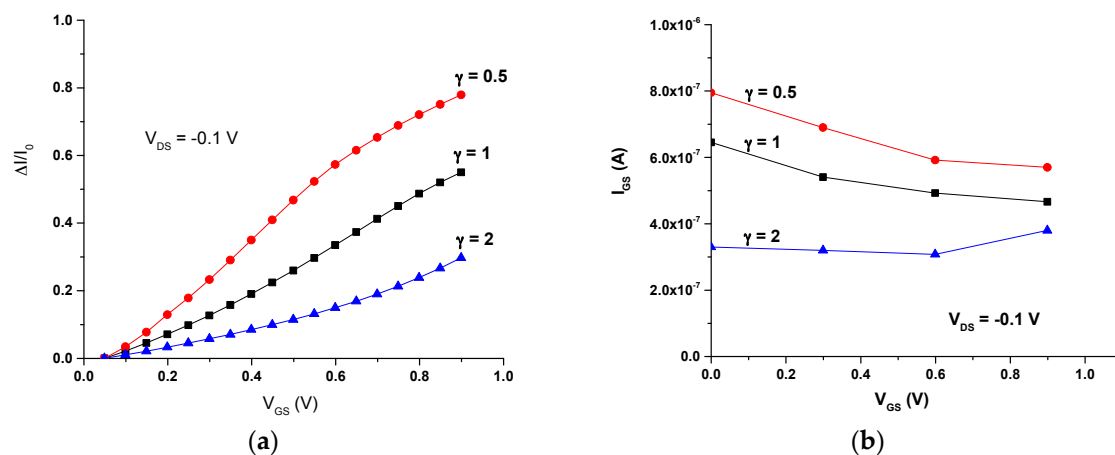

Figure 4. (a) Current modulation $\Delta I/I_0$ vs. V_{GS} ; (b) I_{GS} vs. V_{GS} .

This can be explained by the idea suggested by Malliaras [16,22] that, for these types of transistors, the electrolyte potential (V_{sol}) is related to the area geometry (γ) according to

$$V_{sol} = \frac{V_{GS}}{1 + \gamma}. \quad (2)$$

In OEECTs with a small γ , the electrolyte is nearly at the same potential as the gate, resulting in strong modulation. In contrast, in OEECTs with large γ , the modulation is weak due to the large potential drop at the gate-electrolyte interface (Figure 5).

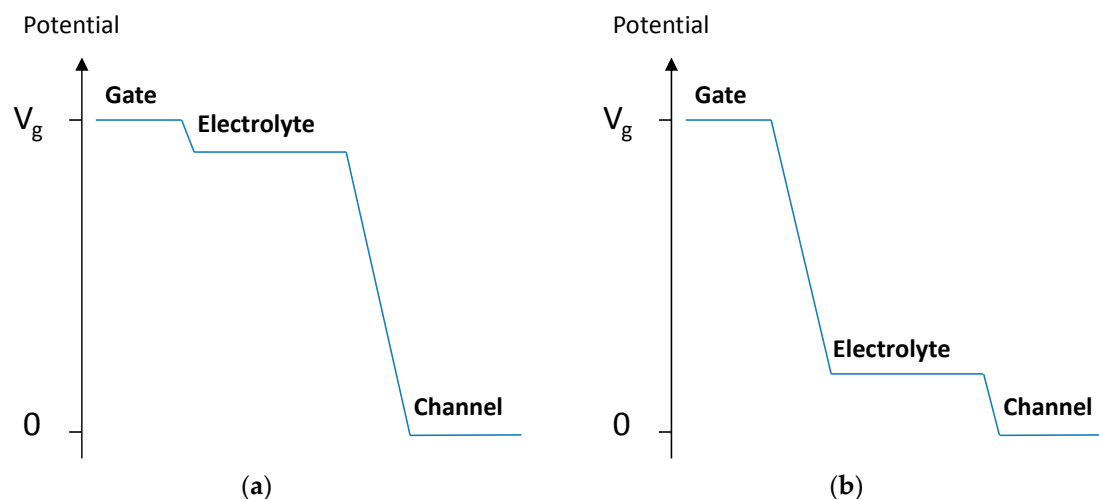

Figure 5. Potential distribution between the gate electrode and the channel for (a) $\gamma = 0.5$; (b) $\gamma = 2$.

Equation (2) represents a non-Faradaic response. Demelas and co-workers demonstrated that an all-PEDOT:PSS OECT behaves similarly to a device with a gate metal working as a polarizable electrode, at least within a certain range of the V_{GS} bias. Therefore, these devices can be controlled by varying the geometry (i.e., the area ratio, γ) [23]. In particular, it is suggested that OECTs with a gate electrode that is much larger than the channel (a small γ) are used [22], which is in good agreement with the results presented here.

On the other hand, results also show that the gate-source current (I_{GS}) is higher for the transistor with a small ratio between the channel and gate areas (Figure 4b).

3.2. Ion-Sensitivity: Effect of the Gate Electrode

According to the above results, the all-PEDOT:PSS OECT with a small γ (type 2, $\gamma = 0.5$) and better current modulation was chosen to investigate hereinafter the ion-sensitive properties of these transistors. For operation as an ion-to-electron converter, besides the use of OECTs with a small γ , it is also suggested that a non-polarizable gate (i.e., Ag) is alternatively used [22]. Therefore, the effect of the gate electrode on the performance of these transistors was additionally studied by comparing the response in aqueous solutions of cations of different sizes of the all-PEDOT:PSS transistor type 2 with an OECT with the same channel-to-gate area ratio (γ), but with a Ag gate.

First, the gate voltage (V_{GS}) range of these ion-sensitivity measurements was defined by performing a voltammetry of the PEDOT:PSS ink used for the fabrication of these OECTs (CLEVIOS S V3, Heraeus). A PEDOT:PSS electrode with the same dimensions and shape of the channel area served as the working electrode (WE) in a three-electrodes cell. A platinum wire was used as the counter electrode (CE), while all potentials were reported with the reference to the Ag/AgCl electrode (RE). Tests were performed in a 0.1-M PBS solution. Results evidence the redox behavior of this organic semiconductor (Figure 6). PEDOT:PSS undergoes reduction at approximately -0.4 V and oxidation near $+0.8$ V. According to these results, the study of the ion-sensitive properties of these OECTs was performed using a V_{GS} range from 0 V to 0.5 V.

In addition, in this V_{GS} range, the transfer curves and the associated transconductances of the all-PEDOT:PSS OECT type 2 and the Ag-Gate OECT with the same γ were obtained in the PBS solution (Figure 7). The drain current (I_{DS}) is shown in the transfer curves to decrease with the gate voltage for both OECTs, which is consistent with the operation in the depletion regime and is in good agreement with the operation mechanism of PEDOT:PSS-based OECTs [16,17]: upon the application of a positive gate voltage, cations from the electrolyte migrate into the conducting polymer. This de-dopes PEDOT:PSS and leads to a decrease in the drain current as shown in Figure 7. On the other hand,

the transconductance is shown to reach a maximum value of $g_m = 0.0115$ mS at $V_{GS} = 0.45$ V for the all-PEDOT:PSS OECT, and of $g_m = 0.0105$ mS at $V_{GS} = 0.35$ V for the Ag-Gate OECT (Figure 7).

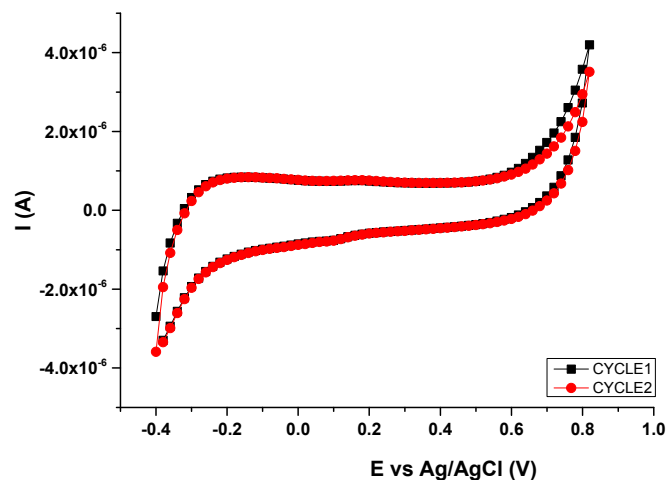

Figure 6. Electrochemical characterization of PEDOT:PSS. CV curves recorded at $0.02 \text{ V} \cdot \text{s}^{-1}$.

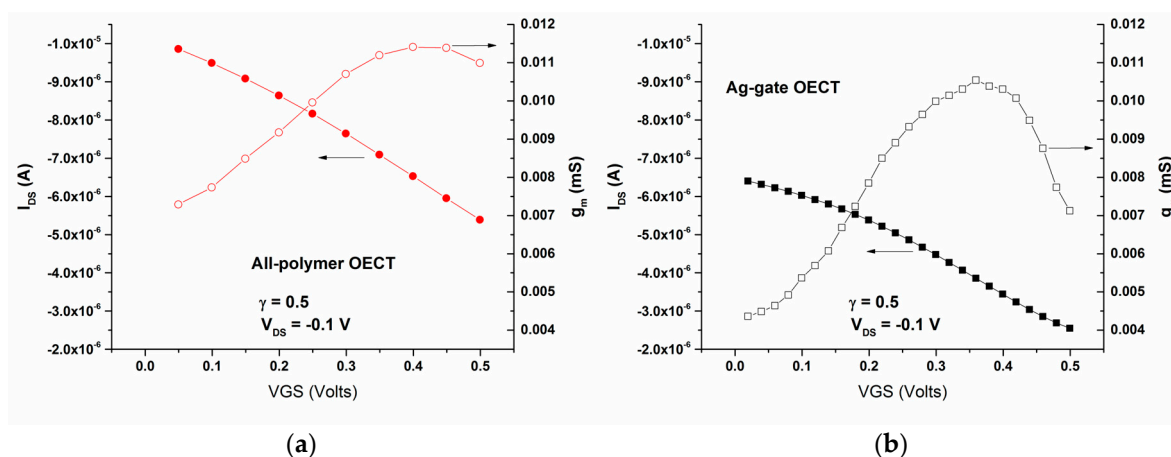

Figure 7. Transfer curves for $V_{DS} = -0.1$ V and their associated transconductances of (a) the all PEDOT:PSS OECT (type 2) and (b) the Ag-Gate OECT.

3.2.1. Ion-Sensitivity towards Sodium Cations

Initially, the ion-sensitive properties of these screen-printed OECTs were studied in aqueous solutions of NaCl to investigate the detection of Na^+ , a biologically relevant small cation. Figure 8 shows the current modulation ($\Delta I/I_0$) and gate-source current (I_{GS}) vs. the gate voltage (V_{GS}) as a function of NaCl concentration for both the all-PEDOT:PSS OECT and the Ag-Gate OECT. The operation of the all-PEDOT:PSS OECT leads to a response that is not dependent on NaCl concentration. The drain current does not depend on concentration, which suggests that the electrolyte potential has diminished. As a result, these transistors exhibit a small potential drop between the electrolyte and the channel, which in turn translates to a weak current modulation (Figure 8a). Moreover, the drain current is close to its maximum value, which can indicate that only few Na^+ cations have migrated into the channel. On the other hand, Demelas and coworkers have suggested that an all-PEDOT:PSS behaves similarly to a device with a polarizable gate (i.e., Pt), working in a non-Faradaic regime (as proven here by the very low gate current) [23] (Figure 8c). These authors also suggest that, in these types of transistors, PEDOT:PSS behaves like a supercapacitor, which could explain the weak dependence on the ionic concentration that is observed.

In contrast, the operation of the Ag-Gate OECT yields a response that is dependent on NaCl concentration. This indicates that, in this case, there is a large potential drop between the electrolyte and the channel, which in turn leads to a strong modulation of the drain current (Figure 8b). This can be explained by the redox reaction taking place at the Ag gate due to the presence of Cl^- counter-ions. As a consequence, there is almost no potential drop at the gate-electrolyte interface. The transistor operates in a Faradaic regime, as shown by the large gate current, which increases as the ionic concentration increases from 10^{-5} M to 10^{-3} M, due to the oxidation of the Ag gate (Figure 8d):

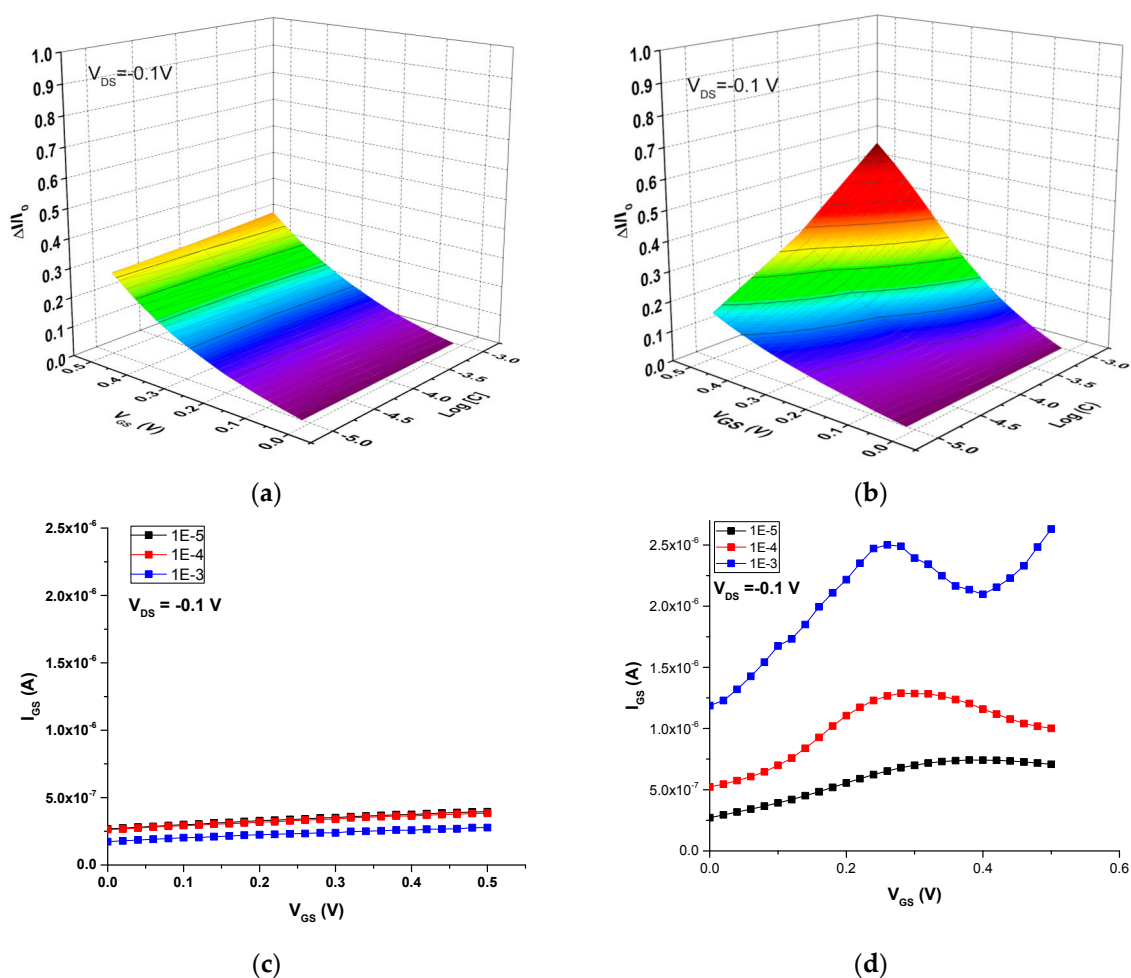

Figure 8. OECT response in NaCl aqueous solutions with different concentrations. Current modulation $\Delta I/I_0$ vs. V_{GS} for (a) all-PEDOT:PSS OECT; (b) Ag-Gate OECT. Plots of I_{GS} vs. V_{GS} for (c) all-PEDOT:PSS OECT; (d) Ag-Gate OECT.

3.2.2. Ion-Sensitivity towards Rhodamine B Cations

Next, the ion-sensitive properties of these two OECTs were investigated in aqueous solutions of rhodamine B ($\text{C}_{28}\text{H}_{31}\text{N}_2\text{O}_3^+$), a large-size cation widely used as a dye in biological applications due to its fluorescent properties. Figure 9 shows the current modulation ($\Delta I/I_0$) and I_{GS} vs. V_{GS} curves as a function of rhodamine concentration for both the all-PEDOT:PSS OECT and the Ag-Gate OECT. The operation of these two OECTs in rhodamine solutions yields to a response that is similar to that obtained in NaCl solutions. The drain current of the all-PEDOT:PSS OECT does not depend on concentration and is similar to its maximum value, which indicates that few rhodamine cations have

migrated into the channel (Figure 9a). This weak modulation of the current could again be explained assuming that PEDOT:PSS behaves like a supercapacitor [23]. Compared to the operation of this transistor in NaCl solutions, the response is even lower in this case, suggesting that the migration of large rhodamine cations into the channel is lower than that of small Na^+ cations. This is probably due to the much larger size of the rhodamine B cations, which can hinder their diffusion and mobility into the channel. In contrast, for the Ag-Gate OEET, results show that the drain current depends slightly on rhodamine concentration (Figure 9b). In particular, the drain current slightly decreases as the concentration increases, which could confirm that rhodamine cations have effectively migrated into the the PEDOT:PSS channel. Concerning the gate current, it was observed that it remained constant for the all-PEDOT:PSS OEET (Figure 9c), whereas it slightly increased for the Ag-Gate OEET as a function of both concentration and V_{GS} (Figure 9d), due to the redox reaction (Equation (3)) taking place at the gate electrode with chloride counter-ions present in rhodamine solutions.

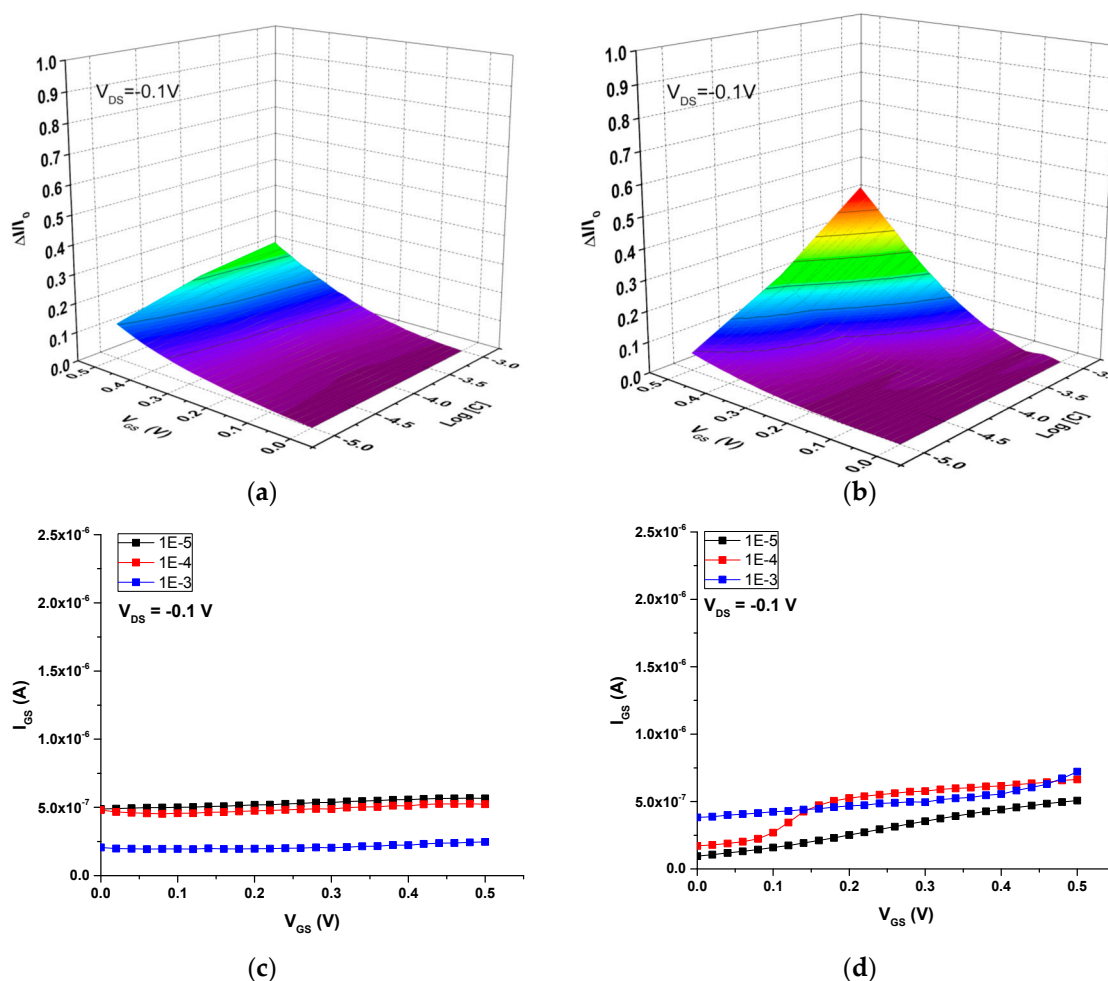

Figure 9. OEET response in rhodamine B aqueous solutions with different concentrations. Current modulation $\Delta I/I_0$ vs. V_{GS} for (a) all-PEDOT:PSS OEET; (b) Ag-Gate OEET. Plots of I_{GS} vs. V_{GS} for (c) all-PEDOT:PSS OEET; (d) Ag-Gate OEET.

In the all-PEDOT:PSS OEETs, cations seem to initially migrate into the channel leading to a slight decrease in the drain current. However, due to the supercapacitor behavior that can be attributable to PEDOT:PSS, the accumulation of charges would simultaneously occur at the surface of both the channel and the gate, which would hinder further migration of cations into the channel. As a result, the channel current remains almost constant and the gate current is kept at very low values. It can therefore be concluded that, for cation detection, the response is maximized in OEETs with non-polarizable gate

electrodes (such as Ag). Furthermore, these OECTs exhibit a good response to cations of different sizes, such as Na⁺ and rhodamine.

4. Conclusions

OECTs based on PEDOT:PSS were prepared by means of a novel screen-printing method. The electrical characteristics of three types of these screen-printed transistors with different geometries were then compared. OECTs with small ratios between the channel and the gate area showed better current modulation, which is in good agreement with previously published results.

The effect of the gate electrode on the transistor performance for ion-sensing was subsequently investigated by comparing these all-PEDOT:PSS OECTs with non-polarizable Ag-Gate OECTs with the same geometry. The response of these transistors has been studied in aqueous solutions of cations of different sizes (Na⁺ and rhodamine B) with concentrations ranging from 10⁻³ M to 10⁻⁵ M. The operation of the all-PEDOT:PSS transistors yields a response that is not dependent on ionic concentration. Results suggest that, in these OECTs, few Na⁺ cations have migrated into the channel and that ion migration is further hindered for rhodamine B large-size cations. The weak current modulation of these transistors can be explained assuming that PEDOT:PSS behaves like a supercapacitor. In contrast, Ag-Gate OECTs exhibit a good response to both small Na⁺ cations and large rhodamine B cations. The redox reaction taking place at the gate electrode due to the presence of Cl⁻ counter-ions could explain the strong modulation observed in these devices. It can therefore be concluded that, for cation detection, the use of OECTs with non-polarizable gate electrodes (such as Ag) helps to increase the response.

Results thus confirm that screen-printing can be regarded as a promising alternative technique for the fabrication of low-cost OECTs for cation detection.

Acknowledgments: Financial support from FEDER and Spanish Government funds (MAT2015-64139-C4-3-R (MINECO/FEDER)) and GVA funds (AICO/2015/103) are gratefully acknowledged.

Author Contributions: A.B. and E.G.-B. conceived and designed the transistors and their fabrication method; L.C.-R. and E.G.-B. designed the experiments for the electrical characterization of the transistors; C.P.-F. and J.V.L.-R. fabricated the transistors and performed the electrical measurements; L.C.-R., A.B., and E.G.-B. analyzed the data and wrote the paper.

Conflicts of Interest: The authors declare no conflict of interest.

References

1. Shirakawa, H.; Louis, E.J.; MacDiarmid, G.; Chiang, C.K.; Heeger, A.J. Synthesis of electrically conducting organic polymers: Halogen derivatives of polyacetylene, (CH)_x. *J. Chem. Soc. Chem. Commun.* **1977**, *16*, 578–580. [[CrossRef](#)]
2. Chiang, C.K.; Fincher, C.R.; Park, Y.W.; Heeger, A.J.; Shirakawa, H.; Louis, E.J.; Gau, S.C.; MacDiarmid, G. Electrical Conductivity in Doped Polyacetylene. *Phys. Rev. Lett.* **1977**, *39*, 1098–1101. [[CrossRef](#)]
3. Malliaras, G.; Friend, R. An organic electronics primer. *Phys. Today* **2005**, *58*, 53–58. [[CrossRef](#)]
4. D'Andrade, B.W.; Forrest, S.R. White Organic Light-Emitting Devices for Solid-State Lighting. *Adv. Mater.* **2004**, *16*, 1585–1595. [[CrossRef](#)]
5. Li, G.; Shrotriya, V.; Huang, J.; Yao, Y.; Moriarty, T.; Emery, K.; Yang, Y. High-efficiency solution processable polymer photovoltaic cells by self-organization of polymer blends. *Nat. Mater.* **2005**, *2*, 864–868. [[CrossRef](#)]
6. Dimitrakopoulos, C.D.; Malenfant, P.R.L. Organic Thin Film Transistors for Large Area Electronics. *Adv. Mater.* **2002**, *14*, 99–117. [[CrossRef](#)]
7. Guo, Y.; Yu, G.; Liu, Y. Functional Organic Field-Effect Transistors. *Adv. Mater.* **2010**, *22*, 4427–4447. [[CrossRef](#)] [[PubMed](#)]
8. Lin, P.; Yan, F. Organic Thin-Film Transistors for Chemical and Biological Sensing. *Adv. Mater.* **2012**, *24*, 34–51. [[CrossRef](#)] [[PubMed](#)]
9. Mabeck, J.T.; Malliaras, G.G. Chemical and biological sensors based on organic thin-film transistors. *Anal. Bioanal. Chem.* **2006**, *384*, 343–353. [[CrossRef](#)] [[PubMed](#)]

10. White, H.S.; Kittlesen, G.P.; Wrighton, M.S. Chemical derivatization of an array of three gold microelectrodes with polypyrrole: Fabrication of a molecule-based transistor. *J. Am. Chem. Soc.* **1984**, *106*, 5375–5377. [[CrossRef](#)]
11. Groenendaal, L.B.; Jonas, F.; Freitag, D.; Pielartzik, H.; Reynolds, J.R. Poly (3,4-ethylenedioxythiophene) and its derivatives: Past, present, and future. *Adv. Mater.* **2000**, *12*, 481–494. [[CrossRef](#)]
12. Kirchmeyer, S.; Reuter, K. Scientific importance, properties and growing applications of poly(3,4-ethylenedioxythiophene). *J. Mater. Chem.* **2005**, *15*, 2077–2088. [[CrossRef](#)]
13. Nilsson, D.; Kugler, T.; Sevansson, P.O.; Berggren, M. An all-organic sensor-transistor based on a novel electrochemical transducer concept printed electrochemical sensors on paper. *Sens. Actuators B* **2002**, *86*, 193–197. [[CrossRef](#)]
14. Andersson, P.; Nilsson, D.; Sevansson, P.O.; Chen, M.X.; Malmstrom, A.; Remonen, T.; Kugler, T.; Berggren, M. Active matrix displays based on all-organic electrochemical smart pixels printed on paper. *Adv. Mater.* **2002**, *14*, 1460–1464. [[CrossRef](#)]
15. Basiricò, L.; Cosseddu, P.; Scidà, A.; Fraboni, B.; Malliaras, G.G.; Bonfiglio, A. Electrical characteristics of ink-jet printed, all-polymer electrochemical transistors. *Org. Electron.* **2012**, *13*, 244–248. [[CrossRef](#)]
16. Bernards, D.A.; Malliaras, G.G. Steady-state and transient behavior of organic electrochemical transistors. *Adv. Funct. Mater.* **2007**, *17*, 3538–3544. [[CrossRef](#)]
17. Nikolou, M.; Malliaras, G.G. Applications of poly (3,4-ethylenedioxythiophene) doped with poly(styrene sulfonic acid) transistors in chemical and biological sensors. *Chem. Rec.* **2008**, *8*, 13–22. [[CrossRef](#)] [[PubMed](#)]
18. Nilsson, D.; Robinson, N.; Berggren, M.; Forchheimer, R. Electrochemical logic circuits. *Adv. Mater.* **2005**, *17*, 353–358. [[CrossRef](#)]
19. Lin, P.; Yang, F.; Chan, H.L.W. Ion-sensitive properties of organic electrochemical transistors. *Appl. Mater. Interfaces* **2010**, *2*, 1637–1641. [[CrossRef](#)] [[PubMed](#)]
20. Stavrinidou, E.; Leleux, P.; Rajaona, H.; Khodagholy, D.; Rivnay, J.; Lindau, M.; Sanaur, S.; Malliaras, G.G. Direct measurement of ion mobility in a conducting polymer. *Adv. Mater.* **2013**, *25*, 4488–4493. [[CrossRef](#)] [[PubMed](#)]
21. Cicoira, F.; Sessolo, M.; Yaghmazadeh, O.; DeFranco, J.A.; Yang, S.Y.; Malliaras, G.G. Influence of device geometry on sensor characteristics of planar organic electrochemical transistors. *Adv. Mater.* **2010**, *22*, 1012–1016. [[CrossRef](#)] [[PubMed](#)]
22. Yaghmazadeh, O.; Cicoira, F.; Bernards, D.A.; Yang, S.Y.; Bonnassieux, Y.; Malliaras, G. Optimization of organic electrochemical transistors for sensor applications. *J. Polym. Sci. Pol. Phys.* **2011**, *49*, 34–39. [[CrossRef](#)]
23. Demelas, M.; Scavetta, E.; Basiricò, L.; Rogani, R.; Bonfiglio, A. A deeper insight into the operation regime of all-polymeric electrochemical transistors. *Appl. Phys. Lett.* **2013**, *102*, 193301. [[CrossRef](#)]
24. Philipp, C.; Rothländer, T.; Haase, A.; Trimmel, G.; Stadlober, B. Influence of geometry variations on the response of organic electrochemical transistors. *Appl. Phys. Lett.* **2013**, *103*, 043308.
25. Tarabella, G.; Santato, C.; Yang, S.; Iannotta, S.; Malliaras, G.G.; Cicoira, F. Effect of the gate electrode on the response of organic electrochemical transistors. *Appl. Phys. Lett.* **2010**, *97*, 123304. [[CrossRef](#)]
26. Khodagholy, D.; Rivnay, J.; Sessolo, M.; Gurfinkel, M.; Leleux, P.; Jimison, L.H.; Stavrinidou, E.; Herve, T.; Sanaur, S.; Owens, R.M.; et al. High transconductance organic electrochemical transistors. *Nat. Commun.* **2013**, *4*, 1–6. [[CrossRef](#)] [[PubMed](#)]



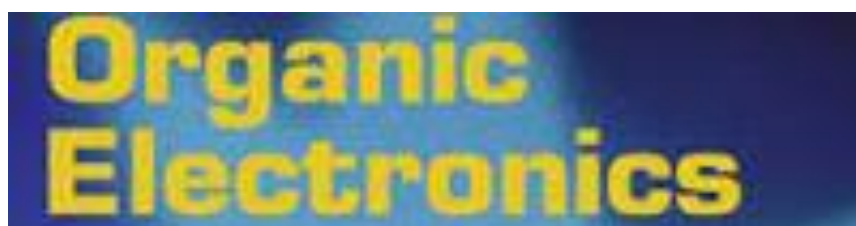

Contat-Rodrigo, L., Pérez-Fuster, C., Lidón-Roger, J. V., Bonfiglio, A., & García-Breijo, E. **Screen-printed Organic Electrochemical Transistors for the detection of ascorbic acid in food.** *Organic Electronics* 2017, 45, 89-96.

Journal Impact Factor 2017: **3.680**

Quartile (Materials Science): **Q1**

2. Screen-Printed Organic Electrochemical Transistors for the Detection of Ascorbic Acid in Food

Laura Contat-Rodrigo¹, Clara Pérez-Fuster¹, José Vicente Lidón-Roger¹, Annalisa Bonfiglio² and Eduardo García-Breijo^{1,*}

¹ Group of Electronic Development and Printed Sensors (GEDPS), Instituto Universitario de Reconocimiento Molecular y Desarrollo Tecnológico (IDM), Universitat Politècnica de València, Camino de Vera s/n, 46022 Valencia, Spain

² Dipartimento di Ingegneria Elettrica ed Elettronica. Università di Cagliari, Piazza d' Armi 09123, Cagliari, Italy.

* e-mail: egarciab@eln.upv.es. Tel: +34 96 3877608

Abstract

Methods traditionally used for ascorbic acid (AA) detection in food are often expensive and complex, making them unsuitable for day-to-day determinations. In this work, we report on the use of all-PEDOT:PSS Organic Electrochemical Transistors (OECTs) for fast, simple and low-cost determination of AA in food. The performance of these OECTs was tested first with in lab-prepared solutions of AA with different concentrations. The effect of the geometry on the transistors performance for AA sensing was also investigated by comparing the response of two OECTs with different channel and gate areas ratio (γ), in terms of current modulation, sensitivity, background signal and limit of detection (LOD). OECTs with smaller gate electrode than the channel (large γ) show the best performance for AA sensing: these devices display smaller background signal, higher sensitivity, larger modulation and better LOD value (80 μ M). Since the AA content in food rich in Vitamin C is in the mM range, these transistors can be considered sensitive enough for quantitatively monitoring AA in food. In order to demonstrate the reliability of the proposed sensors in real food samples, the response of these transistors was additionally measured in a commercial orange juice. The amount of AA obtained with the OECTs is in good agreement with that determined by HPLC and with values reported in the literature for orange juices. Furthermore, these OECTs can be considered promising candidates for the selective detection of AA in the presence of other interfering antioxidants.

Keywords

Organic Electrochemical Transistors; screen-printing; PEDOT:PSS; ascorbic acid

1. Introduction

Ascorbic acid (AA), commonly known as Vitamin C, is a naturally occurring hydrosoluble organic compound that can be found in many biological systems and food products, namely fresh vegetables and fruits. In aqueous solution, AA shows two deprotonation steps (with pKa values of 4.17 and 11.57) [1]. Therefore, at typical biological pH values, AA occurs as monodeprotonated ascorbate anion. AA is known for its reductive properties, being easily oxidized to dehydroascorbic acid (DHAA) (Figure 1). The oxidation of AA involves release of two electrons and two protons to produce DHAA [2]. Due to its strong antioxidant activity, AA is largely used as an antioxidant additive in food industry to prevent unwanted changes in color or flavor of food and drinks. Furthermore, the content of Vitamin C is used as an index of the health-related quality of fruits and vegetables [3]. Consequently, there is increasing interest in the development of analytical methods for the quantitative determination of AA in food.

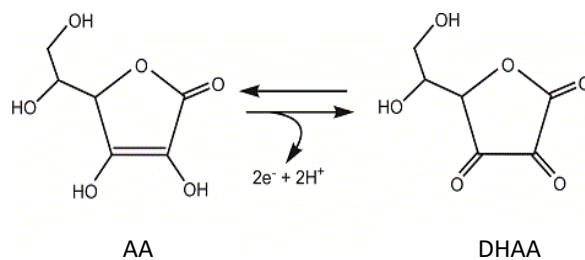

Figure 1. Ascorbic acid (AA) and its two-electron oxidation product dehydroascorbic acid (DHAA) redox couple (redox potential $E_0=+0.058V$).

Traditional methods for the determination of AA in food include enzymatic techniques [4], liquid chromatography [5-7], spectrophotometry [8], chemiluminescence [9], capillary electrophoresis [10], and titration with an oxidant solution [11]. However, such detection methods often require expensive and complex instrumentation, making them unsuitable for day-to-day determinations. Therefore, the development of sensitive, simple, fast, and low cost techniques for the detection of AA is of great interest for food industry.

Electrochemical sensors can be a promising solution since they are based on the use of quick and easy procedures [2]. Among them, sensors based on organic semiconductor devices, like Organic Electrochemical Transistors (OECTs), can be regarded as a valid option for AA sensing. OECTs have attracted considerable interest in recent years for their application as chemical and biological sensors, due to their ability to operate in aqueous environments, easy fabrication, high sensitivity, and their simpler and cheaper readout electronics compared to conventional electrochemical sensors [12,13]. The essential components of an OECT are an organic semiconductor film, the channel (with source and drain electrodes), and an electrolyte bridging the channel and the gate electrode. As a convention, the source electrode is grounded and a voltage is applied to the drain electrode relative to ground. The operation of OECTs is based on the modulation of the channel current by electrochemical doping or de-doping from the electrolyte when gate voltages are applied.

One of the most widely used conducting polymers in these devices is poly(3,4-ethylenedioxythiophene) doped with polystyrene sulfonate (PEDOT:PSS) [14,15]. PEDOT:PSS is commercially available and can be readily patterned by conventional photolithography [16,17], or by solution processing techniques like inkjet-printing [18,19] and screen-printing [20-22]. In addition, it exhibits high conductivity, excellent thermal stability and good stability in a wide pH range. Upon the application of a positive-gate voltage in PEDOT:PSS-based OECTs, cations from the electrolyte migrate into the conducting polymer [23,24]. This in turn de-dopes PEDOT:PSS and leads to a decrease of the channel current. De-doping occurs by reduction of highly conducting PEDOT⁺ to less conducting PEDOT⁰, according to the following electrochemical reaction [25]:



where M^{n+} is a cation in the electrolyte, n is the number of charge of the cation and e^- is an electron from the source electrode. When the gate voltage is removed, cations migrate back

into the electrolyte, and the original conductivity of the organic semiconductor is restored. As a result of this working principle, these devices have been successfully employed as chemical and biological sensors [24,26]. In OECTs based on PEDOT:PSS, the gate electrode [27], the device architecture (ratio between the channel and gate areas, channel geometry) [28,29], and the materials properties play an important role in the sensor performance.

PEDOT:PSS-based OECTs can operate either as ion-to-electron converters or as electrochemical sensors [29]. In OECTs that are used as *ion-to-electron converters*, a transient ionic current is converted into a change in the drain current. The application of a positive gate voltage causes an ionic current in the electrolyte. Cations from the electrolyte migrate into the conducting polymer and de-dope it, leading to the decrease of the drain current. It has been demonstrated that for operation as ion-to-electron converters, the use of a gate electrode that is much larger than the channel or a non-polarizable gate electrode improves the sensor performance [29].

In OECTs that are used as *electrochemical sensors*, charge transfer reactions between a species in the electrolyte and the gate electrode change the potential of the electrolyte, inducing a change in the drain current. For operation as electrochemical sensors, OECTs with gate electrode smaller than the channel exhibit higher sensitivity [29]. All-PEDOT:PSS OECTs can be used as electrochemical sensors for the determination of redox active species (like adrenaline, dopamine and AA) by exploiting the ability of this polymer to electrocatalytically oxidize such molecules at the gate electrode [21,30,31]. In particular, PEDOT can directly oxidize AA according to the following reaction scheme:

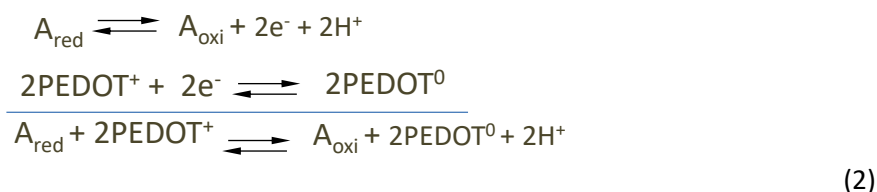

In addition, all-polymer sensors offer many advantages with respect to devices with metal gate electrode such as lower cost, easier fabrication and the possibility to be patterned in a flexible substrate.

In this communication, we report on the use of all-PEDOT:PSS OECTs as electrochemical sensors for the detection of AA in food. The performance of these OECTs was tested first with in lab-prepared solutions of AA with different concentrations. The effect of the geometry on the transistors performance for AA sensing was also investigated by comparing OECTs with different channel and gate areas ratio. Finally, the OECTs response was also measured in a commercial orange juice, in order to demonstrate the reliability of the proposed sensors in real food samples.

2. Materials and methods

Preparation of PBS solution: A 0.1M Phosphate Buffered Saline (PBS) solution was prepared by dissolving K_2HPO_4 (Scharlau, Spain) and KH_2PO_4 (Scharlau, Spain) in Milli-Q water. The PBS solution had a pH of 4.8 as measured by pH meter.

Preparation of ascorbic acid solutions: Solutions were prepared by dissolving AA (Scharlau, Spain) in PBS solution with different molar concentrations ($10^{-8}M$, $10^{-7}M$, $10^{-6}M$, $10^{-5}M$, $10^{-4}M$, $10^{-3}M$ and $10^{-2}M$).

Orange juice: Commercial ready-to-drink orange juice (Hacendado, Spain) purchased from a local supermarket was used as a model real sample. The selected product contains, according to the label, 48 mg/100ml of Vitamin C. The juice was twice diluted with the PBS solution and used without further probe preparation.

Transistor Fabrication: Commercially available PEDOT:PSS C2100629D1 (Gwent, UK) with 500-700 Ω /sq was used as the active material for the fabrication of the OECTs. The channel and the gate were obtained by screen-printing PEDOT:PSS over a polyester film. Screen-printing was performed with PET 1500 165/420-34W/32 μ m mesh screen (Sefar, USA) and Dirasol 132 UV film (Fujifilm, USA). The final screen thickness was 55 μ m. UV light was used to transfer the OECT pattern to the screen. The PEDOT:PSS ink was re-dispersed for 1 hour at 1000 rpm before printing. Printing was carried out using an Aurel 900 screen-printer with 75° shore hardness squeegee, 1 bar force and 0.2 m/s. Transparent and flexible Melinex ST506 polyester (DuPont Teijin Films, UK) of 175 μ m thickness was used as substrate, previously cleaned with acetone, ethanol and deionized water. Finally, the OECTs were cured in an air oven at 100°C for 10 minutes.

Electrical Measurements: All measurements were performed using a Keithley 4200 semiconductor characterization system.

High Performance Liquid Chromatography (HPLC): A LaChrom Elite system (Hitachi, Japan) equipped with an L-2400 UV detector, an L-2130 pump and an L-2200 auto sampler was used for HPLC analysis. To determine AA in the orange juice [32], 1 ml sample was extracted with 9 ml 0.1% oxalic acid for 3 min and immediately filtered before injection. The separation was carried out on an Ultrabase- C_{18} column (250 mm x 4.6 mm) using 0.1% oxalic acid as the mobile phase at a flow rate of 1 ml/min. Samples were injected three times in HPLC with a 20 μ l injection volume. The AA peak was detected at 243 nm and at 25°C. The analysis was carried out by EZChrom Elite software (Agilent Technologies, USA).

Determination of the antioxidant activity: The antioxidant activity of the orange juice was assessed by means of the ABTS method for total antioxidant activity [33]. This technique measures the relative ability of antioxidant substances to scavenge the 2,2'-azinobis(3-ethylbenzothiazoline-6-sulfonate) radical cation ($ABTS^{\bullet+}$). $ABTS^{\bullet+}$ was prepared by mixing an ABTS stock solution (15 mM) with potassium persulfate (4.8 mM). The mixture (1:1) was allowed to stand in the dark at room temperature for 12h before use. The working solution was prepared by dissolving $ABTS^{\bullet+}$ radicalized solution in ethanol to an absorbance

of 1.1 ± 0.002 at $\lambda = 734$ nm. The spectrophotometric assay was performed by mixing 2850 μ l of the ABTS^{•+} diluted solution with 150 μ l of the sample. Discoloration following the sample addition was determined by measuring the decrease of absorbance at 734 nm for 30 min at 20°C. Appropriate solvent blanks were run for correction of the absorbance at each time.

3. Results

The screen-printed OEECTs are composed of two parallel rectangular PEDOT:PSS stripes that act as channel and gate (Figure 2). OEECTs with two types of geometries were designed, by modifying the ratio between the channel and gate areas $\gamma = A_{ch}/A_g$ (where A_{ch} is the channel area and A_g is the gate area) (Table 1). Both OEECTs are asymmetric devices with $\gamma = 0.5$ and $\gamma = 2$, respectively. The electrolyte is confined by a polydimethylsiloxane (PDMS) well (1.7x1.1x1 cm) in a small area (dashed line in Figure 2) that partly covers the channel and the gate.

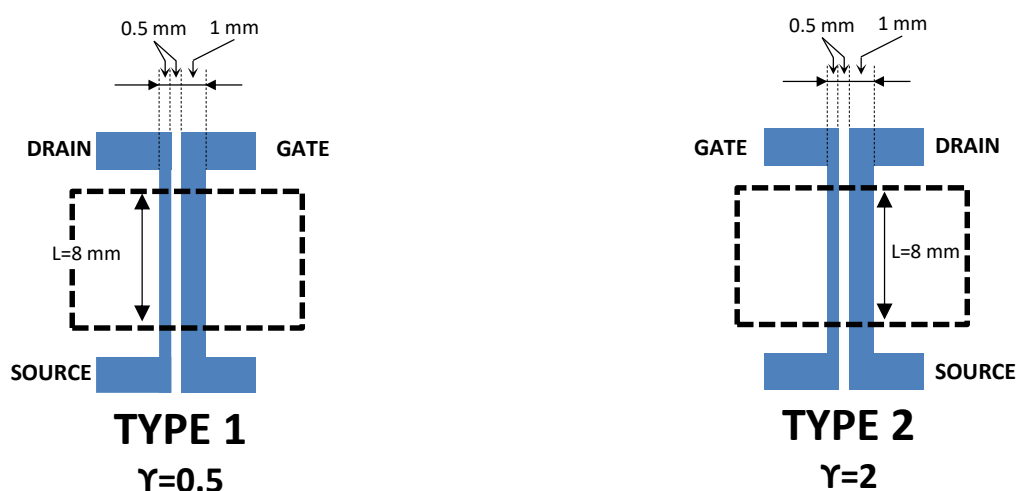

Figure 2. Schematic representation of the devices layout with different geometry.

Table 1. Geometric characteristics of the two types of OEECTs.

	Type 1	Type 2
Channel width (W_{ch}) (mm)	0.5	1
Channel length (L_{ch}) (mm)	8	8
W_{ch}/L_{ch}	0.0625	0.125
Channel area (A_{ch}) (mm ²)	4	8
Gate area (A_g) (mm ²)	8	4
$\gamma = A_{ch}/A_g$	0.5	2

3.1. Electrical characterization of the OEECTs in PBS solution

These screen-printed OEECTs were initially characterized in PBS solution. The output characteristics, the transfer characteristics and the current modulation of these two OEECTs were determined and compared. The output characteristics were obtained by measuring the drain

current (I_{DS}) as a function of the drain voltage (V_{DS}) for different gate voltages (V_{GS}). Results show that the geometry has large influence on the output characteristics of these transistors (Figure 3). OEETs with small area ratio ($\gamma=0.5$) exhibit strong modulation of the drain current, while the modulation of this current is weaker for transistors with large area ratio ($\gamma=2$) [29].

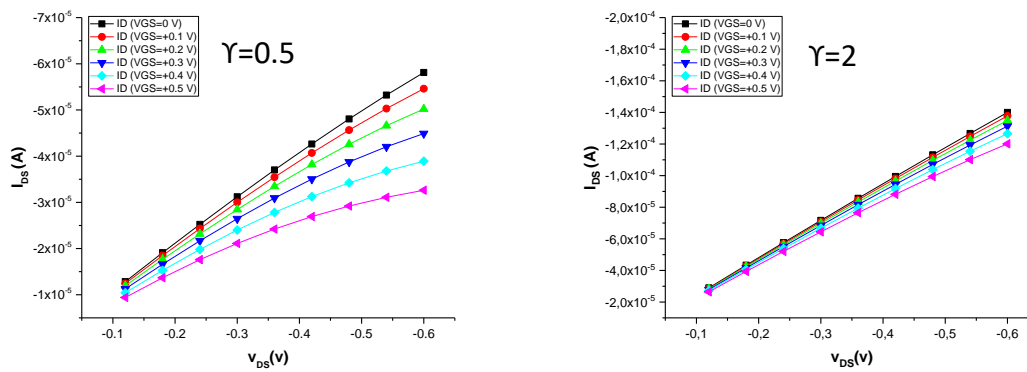

Figure 3. Output characteristics of the OEETs with different values of γ .

Concerning the transfer characteristics of these OEETs, these were obtained plotting I_{DS} (normalized to its maximum value) vs V_{GS} from 0 V to 0.5 V, under constant drain voltage (Figure 4a). Results confirm that OEETs with larger gate electrode than the channel (small γ) display higher modulation of the drain current. In contrast, OEETs with smaller gate electrode than the channel (large γ) show little modulation of the drain current and remain in the *on* state for a wider range of the applied V_{GS} [29].

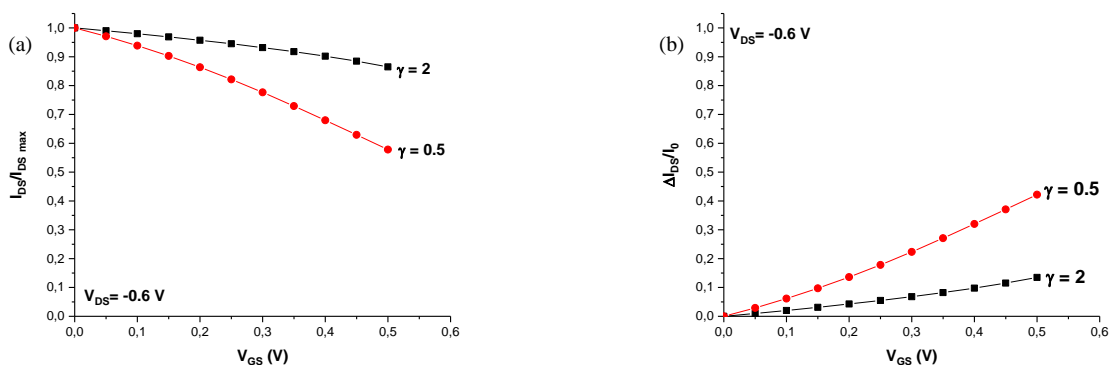

Figure 4. Curves of the OEETs with different values of γ ($V_{DS} = -0.6V$): (a) normalized I_{DS} vs V_{GS} and (b) current modulation $\Delta I_{DS}/I_0$ vs V_{GS} .

Finally, the current modulation ($\Delta I_{DS}/I_0$) of these OEETs was obtained as a function of the gate voltage for different values of γ :

$$\Delta I_{DS}/I_0 = |I_{DS} - I_0|/I_0 \quad (3)$$

where I_{DS} is the *off* current ($V_{GS} \neq 0$) and I_0 is the *on* current ($V_{GS} = 0$). Current modulation strongly decreases with increasing the area ratio (Figure 4b). OEECTs type 1 with small γ exhibit strong modulation throughout all the investigated V_{GS} range, while OEECTs type 2 with large γ exhibit little modulation.

This is in good agreement with the idea that two regimes can be identified in OEECTs operating like electrochemical sensors [34]: a non-Faradaic regime (in the absence of analyte) where the polymer doping is coupled to the charging of an ionic double layer at the gate electrode, and a Faradaic regime (in the presence of analyte) where doping/dedoping is coupled to a redox reaction at the gate electrode.

Here, in the absence of AA, with just PBS in the electrolyte reservoir, there is no charge transfer between the electrolyte and the gate electrode, and OEECTs operate in the non-Faradaic regime. The electrolyte potential (V_{sol}), in this case, is determined by the capacitances associated with double layer formation at the gate and the channel [35]:

$$V_{sol} = V_{GS} / \left(1 + (c_{ch} A_{ch} / c_g A_g) \right) \approx V_{GS} / (1 + \gamma) \quad (4)$$

where c_{ch} and c_g are the channel and gate capacitances per unit area, respectively. If it is assumed that these capacitances are similar, the electrolyte potential only depends on the ratio between the channel and gate areas (γ) [29]. In OEECTs with larger gate electrode than the channel ($\gamma < 1$), the electrolyte is nearly at the same potential as the gate electrode. This leads to a large potential drop at the electrolyte/channel interface, resulting in a strong modulation of the drain current. In contrast, in OEECTs with smaller gate electrode than the channel ($\gamma > 1$), the electrolyte is nearly at the same potential than the channel. This results in a small potential drop at the electrolyte/channel interface, which in turn leads to a weak modulation of the drain current. Therefore, for operation in the non-Faradaic regime, the current modulation of these OEECTs decreases strongly with γ .

3.2. OEECTs response in ascorbic acid solutions

Effect of the geometry

Next, the response of the OEECTs was tested in AA solutions of concentrations ranging from $10^{-8}M$ to $10^{-2}M$. The gate-source current (I_{GS}) was initially measured as a function of V_{GS} and AA concentration for the two types of OEECTs. I_{GS} can be used as a fingerprint of the operation regime of the transistors (non-Faradaic or Faradaic), since this is due to capacitive effects and/or charge transfer reactions at the gate electrode [27]. Results show the presence of a large I_{GS} in both devices for high concentrations of AA ($\geq 10^{-4}M$), consistent with the presence of Faradaic processes at the gate electrode (Figure 5). In contrast, both transistors show a small I_{GS} at low concentrations of AA ($\leq 10^{-5}M$), indicative of a non-Faradaic operation regime.

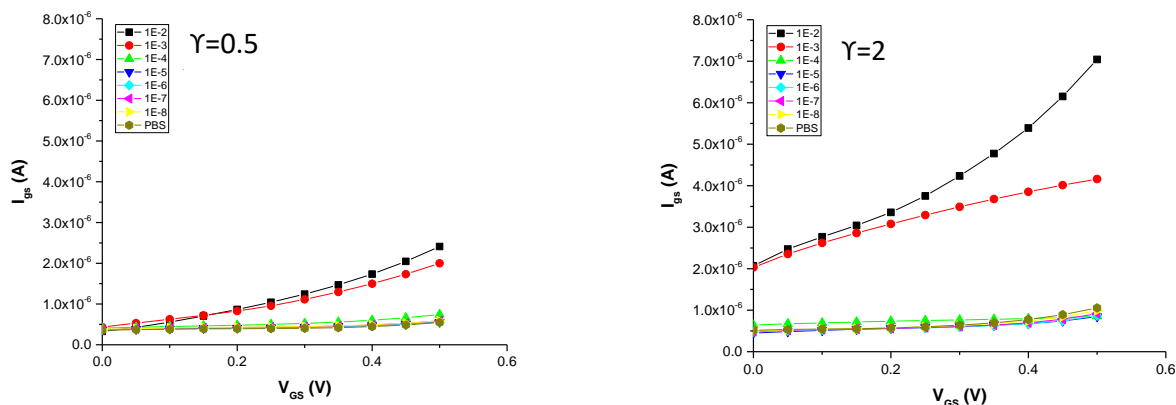

Figure 5. I_{DS} as a function of V_{GS} and AA concentration for the OECTs with different values of γ ($V_{DS} = -0.6V$).

The current modulation ($\Delta I_{DS}/I_0$) was obtained as a function of AA concentration for various values of V_{GS} , where I_{DS} is considered at zero concentration (no analyte) and at concentration of interest. This normalization facilitates comparison between the transistors with different geometry. The three-dimensional plots for the OECTs with different γ are shown in Figure 6. The operation of these two OECTs yields a response that is dependent on AA concentration and V_{GS} , confirming that these devices can be used as AA sensors. In particular, the drain current increases with concentration, being this change larger as V_{GS} increases [27,28,35]. These changes are, however, more significant for OECTs with large γ (type 2). These results indicate that for detection of AA, OECTs with smaller gate electrode than the channel display stronger current modulation [28].

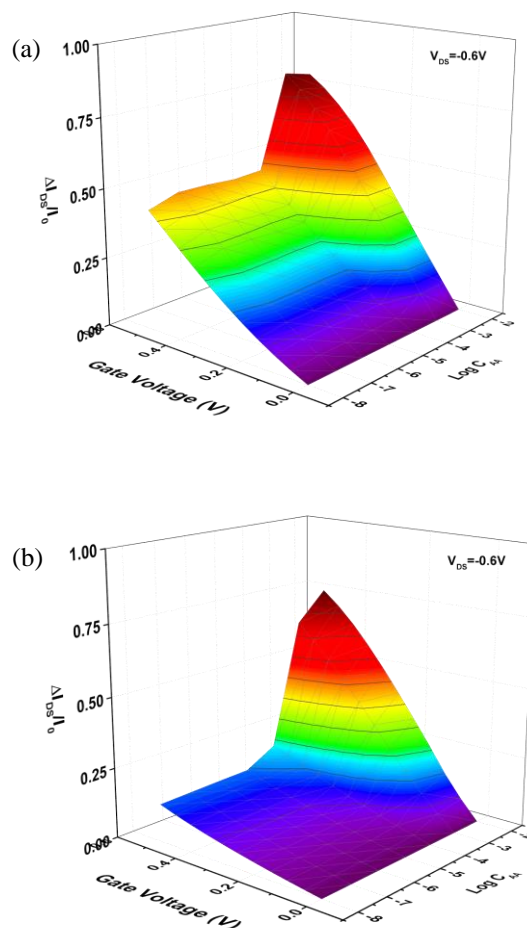

Figure 6. Normalized response of I_{DS} as a function of the applied gate voltage and AA concentration for OECTs: (a) type 1 and (b) type 2, ($V_{DS} = -0.6V$).

The influence of the ratio of the channel to gate areas in the response of these OECTs is highlighted by comparing the current modulation of the transistors with different values of γ , in AA solutions of various concentrations, at fixed V_{GS} (Figure 7). Results yield typical S-shaped curves characteristic of sensors, consisting of three distinct regimes [28]. First, for low concentrations ($[AA] \leq 10^{-5}M$), a background $\Delta I_{DS}/I_0$ is obtained. This background signal is independent on concentration and is of non-Faradaic origin, as previously shown in Figure 5. Then, $\Delta I_{DS}/I_0$ increases with concentration ($10^{-5}M \leq [AA] \leq 10^{-2}M$). The current modulation is therefore enhanced in the presence of AA due to the Faradaic contribution that exists in this concentration range, as seen in Figure 5. For high concentrations ($[AA] \geq 10^{-2}M$), $\Delta I_{DS}/I_0$ tends to saturation. Saturation occurs when the electrolyte potential becomes similar to the applied gate voltage, and further addition of analyte does not result in further de-doping of the channel [28].

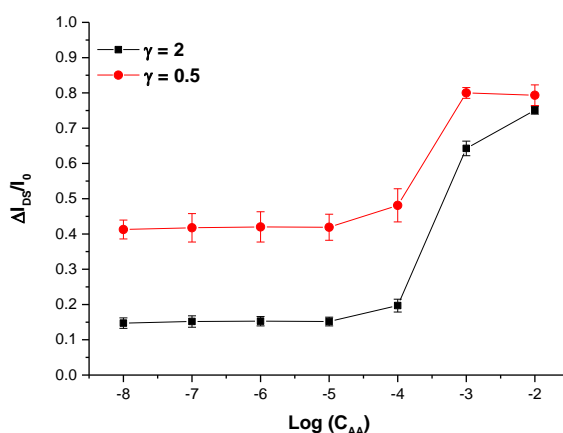

Figure 7. Response of the OECTs with different values of γ as a function of AA concentration for $V_{DS} = -0.6V$ and $V_{GS} = +0.5V$.

These results demonstrate that γ has a pronounced effect on the background signal and sensitivity (slope of the normalized response vs AA concentration) of these devices. The background value decreases with γ , whereas sensitivity increases with γ (OECTs type 1 and type 2 show a sensitivity of $15.4 \mu A.dec^{-1}$ and $61.2 \mu A.dec^{-1}$, respectively). This means that transistors with smaller gate electrode than the channel (large γ) display small background signal and high sensitivity. In contrast, the saturation and detection range seem to be rather independent of γ . Saturation of $\Delta I_{DS}/I_0$ seems to be at the same value and for the same AA concentration, regardless the value of γ . The minimum and maximum detectable concentrations are about $10^{-5}M$ and $10^{-2}M$, respectively, for both devices. These results are in good agreement with those reported by Cicoira et al. for PEDOT:PSS-based OECTs used for the detection of hydrogen peroxide via electrochemical oxidation at a Pt gate electrode [28].

In the presence of AA, the OECT operates in the Faradaic regime, since introduction of AA in the electrolyte results in charge transfer to the gate electrode according to the following reaction:



This transfer of electrons between the electrolyte and the gate electrode raises the electrolyte potential (V_{sol}) by a value described by the Nernst equation [34]:

$$V_{sol} = [V_{GS}/(1 + \gamma)] + (kT/2e) \ln[AA] + constant \quad (6)$$

where k is the Boltzmann constant, T is the temperature, e is the fundamental charge, c is the concentration of AA, and the constant contains details such as the formal potential. Therefore, the addition of AA results in the decrease in the potential drop at the gate/electrolyte interface, which leads to the subsequent increase in the potential drop at the electrolyte/channel interface, since the gate is held at constant voltage. In OEETs with smaller gate electrode than the channel (large γ), a small V_{sol} is favored in the absence of AA (as confirmed previously by the characterization of these devices in PBS solution). Consequently, in OEETs with large γ , the modulation caused by the addition of AA will be proportionally larger than in OEETs with larger gate electrode than the channel (small γ). This can explain the dependence of the sensitivity and current modulation on γ observed for these transistors: OEETs with large γ display higher sensitivity and better modulation for AA sensing. These observations are also in good agreement with the findings of Cicoira et al. for H_2O_2 sensors [28].

Effect of AA concentration on the OEETs response

Since OEETs with large γ (type 2) have shown the best performance for AA sensing in terms of sensitivity and current modulation, these transistors were chosen to further analyze the effect of AA concentration on their response. Although not shown here, similar results were obtained for OEETs type 1.

The redox reaction described above that occurs when AA is added to the electrolyte, also affects the source-drain current. This is illustrated in Figure 8a, which displays the transfer characteristics of OEETs type 2 for different AA concentrations. In all the investigated AA concentration range, I_{DS} decreases with increasing V_{GS} due to dedoping of PEDOT:PSS in the channel. However, the presence of AA clearly affects the transfer characteristics. With increasing AA concentration, the current modulation increases. In particular, modulation is enhanced for high AA concentrations ($[AA] \geq 10^{-4} M$) due to the Faradaic contribution that exists in this concentration range. These observations are consistent with Figures 5 and 7.

The gate voltage can be scaled to yield a universal curve according to [35]:

$$V_{GS}^{eff} = V_{GS} + V_{offset} \quad (7)$$

V_{GS}^{eff} is the effective gate voltage, that is defined as the equivalent voltage that needs to be applied in the absence of Faradaic effects at the gate electrode to obtain the same I_{DS} . V_{offset} is an offset voltage that depends on AA concentration. It describes the Faradaic contribution to V_{GS}^{eff} and originates from the shift in the chemical potential described by the Nernst equation (Eq. 6):

$$V_{offset} = (1 + \gamma)(kT/2e) \ln[AA] + constant \quad (8)$$

This universal curve agrees with the typical transfer characteristics of a depletion mode transistor, showing the monotonic decrease of I_{DS} with increasing the gate voltage (Figure 8b).

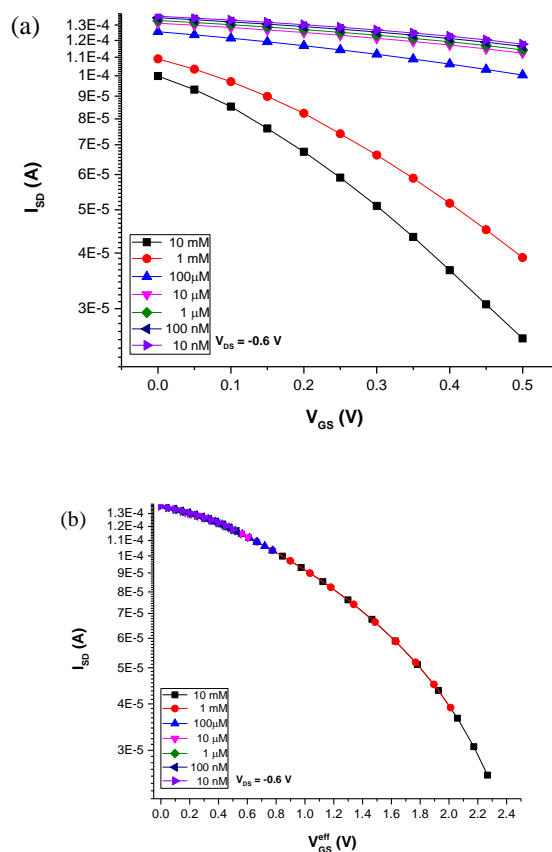

Figure 8. OECTs type 2 ($\gamma=2$): (a) I_{DS} as a function of applied V_{GS} for a fixed drain voltage ($V_{DS} = -0.6$ V) and various AA concentrations and (b) I_{DS} as a function of effective gate voltage.

The effect of AA concentration on the transistors response is highlighted in Figure 9, in which V_{offset} of OECTs type 2 is plotted as a function of AA concentration. The gating of the transistors is clearly affected by the presence of AA. A logarithmic behavior (reminiscent of the Nernst equation) is observed for AA content in the range 10^{-5} M and 10^{-2} M, consistent with the charge transfer reaction that occurs at the gate electrode for these concentrations (Figure 5).

The limit of detection (LOD) of these OECTs was obtained to evaluate their performance in AA solutions. LOD was calculated as the concentration that leads to a signal three times higher than experimental noise:

$$LOD = 3Sbl/a \quad (9)$$

where (Sbl) is evaluated as the standard deviation of the blank signal (PBS) and a is the slope obtained by linear fit. The LOD values estimated for OECTs type 1 and type 2 are $107.7 \mu\text{M}$ and $80.1 \mu\text{M}$, respectively. This confirms that OECTs with large γ show the

best performance for AA sensing, also in terms of LOD. These LOD values are, however, somewhat higher than that reported recently by Gualandi et al. for another all-PEDOT:PSS OECT for AA sensing [30]. The lower LOD obtained by these authors can be attributed to the different geometry of their proposed OECT (larger γ and lower W_{ch}/L_{ch} ratio). Taking into account that AA content in food rich in Vitamin C does not exceed the mM range [36], these transistors can be considered sensitive enough for quantitatively monitoring AA in food.

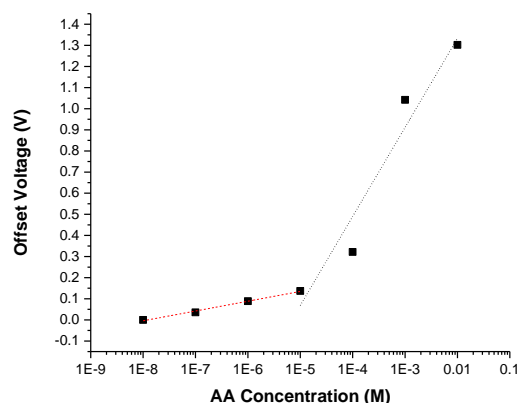

Figure 9. Dependence of the offset voltage on AA concentration for OECTs type 2.

3.3. OECTs response in orange juice

Finally, the OECTs were used to measure AA in commercial orange juice, to assess their response in real food samples. AA determination in orange juice was performed with OECTs type 2 with large γ , which have shown better sensitivity, current modulation and LOD in the previous tests with in-lab prepared AA solutions. The change in I_{DS} was used to determine the AA concentration in the orange juice, which was found to be equal to 52.80 mg/100ml. This value is in good agreement with the amount of AA in the juice obtained by HPLC, which was equal to 56.71 mg/100ml, and with that reported by Rapisarda et al. for fresh “Valencia Late” orange juice (51.37 mg/100 ml) [37].

The antioxidant activity is an overall measure of the different antioxidant compounds that are present in a sample. In orange juices, these include AA but also carotenoids and, especially, phenolics (like flavonoids and phenolic acids), among others. The antioxidant activity of the orange juice was evaluated using the ABTS method. An antioxidant activity of 7.79 mM was obtained, which is equivalent to 130.3 mg/100 ml, and is in good agreement with that reported by Rapisarda et al. (7.4 mM) [37]. Comparison of the antioxidant activity and the amount of AA in the orange juice confirms that, besides AA, this juice contains other antioxidant compounds. Furthermore, since the AA content measured with the OECT has been found to be in good agreement with that determined by HPLC and with values reported in the literature, this suggests that these transistors can be considered promising candidates for selective AA detection. This

preliminary conclusion should be however confirmed by performing additional cross experiments with interfering antioxidants present in orange juice.

4. Conclusions

The use of all-PEDOT:PSS OECTs as electrochemical sensors for the determination of AA content in food has been assessed. OECTs were prepared by screen-printing the organic semiconductor over a flexible substrate. The performance of these OECTs was first tested with in lab-prepared solutions of AA with different concentrations ranging from 10^{-8} M to 10^{-2} M. Measurements of the gate-source current indicate that for low AA concentrations (up to 10^{-5} M), these OECTs operate in the non-Faradaic regime, whereas for high AA concentrations (up to 10^{-2} M), Faradaic processes occur at the gate electrode, resulting from the ability of PEDOT:PSS to electrocatalytically oxidize AA. The Faradaic contribution in this concentration range greatly enhances modulation of the drain current and the gating of the transistors.

The effect of the geometry on the performance of these devices for AA sensing was additionally investigated by comparing two OECTs with different channel and gate areas ratio (γ), in terms of current modulation, sensitivity and background signal. It was found that the response to AA is improved in OECTs with smaller gate electrode than the channel (large γ), which display smaller background signal that results in higher sensitivity and larger modulation by the addition of AA to the electrolyte. OECTs with large γ also display better LOD value (80.1 μ M), confirming that this geometry shows the best performance for AA sensing. Since the AA content in food rich in Vitamin C is in the mM range, these transistors can be considered sensitive enough for quantitatively monitoring AA in food.

To demonstrate the reliability of the proposed sensors in real food samples, the OECTs were used to measure the AA content in a commercial orange juice. The amount of AA obtained with the OECTs is in good agreement with that determined by HPLC and with values reported in the literature for orange juices. Furthermore, these OECTs can be considered promising candidates for the selective detection of AA in the presence of other interfering antioxidants.

Acknowledgments

This work was supported by Spanish Government / FEDER funds (grant number MAT2015-64139-C4-3-R (MINECO/FEDER)) and Generalitat Valenciana funds (grant number AICO/2015/103).

References

- [1] A. Malinauskas, R. Garjonyte, R. Mazeikiene, I. Jureviciute, Electrochemical response of ascorbic acid at conducting and electrogenerated polymer modified electrodes for electroanalytical applications: a review, *Talanta* 64 (2004) 121-129.
- [2] A.M. Pisoschi, A. Pop, A.I. Serban, C. Fafaneata, Electrochemical methods for ascorbic acid determination, *Electrochim. Acta* 121 (2014) 443-460.
- [3] J. Fenoll, A. Martínez, P. Hellín, P. Flores, Simultaneous determination of ascorbic acid and dehydroascorbic acids in vegetables and fruits by liquid chromatography with tandem-mass spectrometry, *Food Chem.* 127 (2011) 340-344.
- [4] T.N. Shekhovtsova, S.V. Muginova, J.A. Luchinina, A.Z. Galimova, Enzymatic methods in food analysis: determination of ascorbic acid, *Anal. Chim. Acta* 573-574 (2006) 125-132.
- [5] M. Szultka, M. Buszewska-Forajta, R. Kaliszan, B. Buszewski, Determination of ascorbic acid and its degradation products by High-Performance Liquid Chromatography-triple quadropole Mass Spectrometry, *Electrophoresis* 35 (2014) 585-592.
- [6] K.K. Chebrolov, G.K. Jayaprakasha, K.S. Yoo, J.L. Jifon, B.S Patil, An improved sample method for quantification of ascorbic acid and dehydroascorbic acid by HPLC, *LWT Food Sci. Technol.* 47 (2012) 443-449.
- [7] L. Novakova, P. Solich, D. Solichova, HPLC methods for simultaneous determination of ascorbic and dehydroascorbic acids, *Trends Anal. Chem.* 27 (2008) 942-958.
- [8] M. Özyürek, K. Güclü, B. Bektasoglu, R. Apak, Spectrophotometric determination of ascorbic acid by the modified CUPRAC method with extractive separation of flavonoids-La(III) complexes, *Anal. Chim. Acta* 588 (2007) 88-95.
- [9] Y.P. Dong, T.T. Gao, X.F. Chu, J. Chen, C.M. Wang, Flow injection-chemiluminescence determination of ascorbic based on luminol-ferricyanide-gold nanoparticles system, *J. Lumin.* 154 (2014) 350-355.
- [10] L. Galiana-Balaguer, S. Roselló, J.M. Herrero-Martínez, A. Maquieira, F. Nuez, Determination of L-ascorbic in *Lycopersicon* fruits by Capillary Zone Electrophoresis, *Anal. Biochem.* 296 (2001) 218-224.
- [11] L. Suntornsuk, W. Gritsanapun, S. Nilkamhank, A. Paochom, Quantification of vitamin C conten in herbal juice using direct titration, *J. Pharm. Biomed. Anal.* 28 (2002) 849-855.
- [12] P. Lin, F. Yan, Organic Thin-Film Transistors for chemical and biological sensing, *Adv. Mat.* 24 (2012) 34-51.
- [13] J.T. Mabeck, G.G. Malliaras, Chemical and biological sensors based on organic thin-film transistors, *Anal. Bioanal. Chem.* 384 (2006) 343-353.
- [14] L.B. Groenendaal, F. Jonas, D. Freitag, H. Pielartzik, J.R. Reynolds, Poly (3, 4-ethylenedioxythiophene) and its derivatives: past, present, and future, *Adv. Mat.* 12 (2000) 481-494.
- [15] S. Kirchmeyer, K. Reuter, Scientific importance, properties and growing applications of poly(3,4-ethylenedioxythiophene), *J. Mat. Chem.* 15 (2005) 2077-2088.
- [16] G. Tarabella, G. Nanda, M. Villani, N. Coppedè, R. Mosca, G.G. Malliaras, C. Santato, S. Iannotta, F. Cicoira, Organic electrochemical transistors for monitoring micelle formation, *Chem. Sci.* 3 (2012) 3432-3435.
- [17] D. Khodagholy, J. Rivnay, M. Sessolo, M. Gurfinkel, P. Leleux, L.H. Jimison, E. Stavrinidou, T. Herve, S. Sanaur, R.M. Owens, G.G. Malliaras, High transconductance organic electrochemical transistors, *Nat. Commun.* 4 (2013) 2133.
- [18] D. Nilsson, T. Kugler, P.O. Sevansson, M. Berggren, An all-organic sensor-transistor based on a novel electrochemical transducer concept printed electrochemical sensors on paper, *Sens. Actuators B* 86 (2002) 193-197.

- [19] L. Basiricò, P. Cosseddu, A. Scidà, B. Fraboni, G.G. Malliaras, A. Bonfiglio, Electrical characteristics of ink-jet printed all-polymer electrochemical transistors, *Org. Electron.* 13 (2012) 244-248.
- [20] I. Gualandi, M. Marzocchi, A. Achilli, A. Bonfiglio, B. Fraboni, Textile organic electrochemical transistors as a platform for wearable biosensors, *Sci. Rep.* 6 (2016) 33637.
- [21] L. Contat-Rodrigo, C. Pérez-Fuster, J.V. Lidon-Roger, E. García-Breijo, Characterization of screen-printed organic electrochemical transistors to detect cations of different sizes, *Sensors* 16 (2016) 1599.
- [22] P.A. Ersman, d. Nilsson, J. Kawahara, G. Gustafsson, M. Berggren, Fast-switching all-printed organic electrochemical transistors, *Org. Electron.* 14 (2013) 1276-1280.
- [23] D.A. Bernards, G.G. Malliaras, Steady-state and transient behavior of organic electrochemical transistors, *Adv. Funct. Mat.* 17 (2007) 3538-3544.
- [24] M. Nikolou, G.G. Malliaras, Applications of poly (3, 4-ethylenedioxythiophene) doped with poly (styrene sulfonic acid) transistors in chemical and biological sensors, *Chem. Rec.* 8 (2008) 13-22.
- [25] D. Nilsson, N. Robinson, M. Berggren, R. Forchheimer, Electrochemical logic circuits, *Adv. Mat.* 17 (2005) 353-358.
- [26] P. Lin, F. Yang, H.L.W. Chan, Ion-sensitive properties of organic electrochemical transistors, *Appl. Mat. Interfaces* 2 (2010) 1637-1641.
- [27] G. Tarabella, C. Santato, S. Y. Yang, S. Iannotta, G.G. Malliaras, S. Cicoira, Effect of the gate electrode on the response of organic electrochemical transistors, *Appl. Phys. Lett.* 97 (2010) 123304.
- [28] F. Cicoira, M. Sessolo, O. Yaghmazadeh, J.A. DeFranco, S.Y. Yang, G.G. Malliaras, Influence of device geometry on sensor characteristics of planar organic electrochemical transistors, *Adv. Mat.* 22 (2010) 1012-1016.
- [29] O. Yaghmazadeh, F. Cicoira, D.A. Bernards, S.Y. Yang, Y. Bonnassieux, G.G. Malliaras, Optimization of organic electrochemical transistors for sensor applications, *J. Polym. Sci. B Polym. Phys.* 49 (2011) 34-39.
- [30] I. Gualandi, M. Marzocchi, E. Scavetta, M. Calienni, A. Bonfiglio, B. Fraboni, A simple all-PEDOT:PSS electrochemical transistor for ascorbic acid sensing, *J. Mater. Chem. B* 3 (2015) 6753-6762.
- [31] C. Zanardi, F. Terzi, R. Seeber, Polythiophenes and polythiophene-based composites in amperometric sensing, *Anal. Bional. Chem.* 405 (2013) 509-531.
- [32] G. Xu, D. Liu, J. Chen, X. Ye, Y. Ma, J. Shi, Juice components and antioxidant capacity of citrus varieties cultivated in China, *Food Chem.* 106 (2008) 545-551.
- [33] R. Re, N. Pellegrini, A. Proteggente, A. Pannala, M. Yang, C. Rice-Evans, Antioxidant activity applying an improved ABTS radical cation decolorization assay, *Free Radic. Biol. Med.* 26 (1999) 1231-1237.
- [34] F. Lin, M.C. Lonergan, Gate electrode processes in an electrolyte-gated transistor: non-Faradaically versus Faradaically coupled conductivity modulation of a polyacetylene ionomer, *App. Phys. Lett.* 88 (2006) 133507.
- [35] D.A. Bernards, D.J. Macaya, M. Nikolou, J.A. DeFranco, S. Takamatsu, G.G. Malliaras, Enzymatic sensing with organic electrochemical transistors, *J. Mater. Chem.* 18 (2008) 116-120.
- [36] P.J. O'Connell, C. Gormally, M. Pravda, G.G. Guilbault G.G. Development of an amperometric L-ascorbic acid (Vitamin C) sensor based on electropolymerised aniline for pharmaceutical and food analysis, *Anal. Chim. Acta* 431 (2001) 239-247.
- [37] P. Rapisarda, A. Tomaino, R. Lo Cascio, F. Bonina, A. De Pasquale, A. Saija, Antioxidant effectiveness as influenced by phenolic content of fresh orange juices, *J. Agric. Food Chem.* 47 (1999) 4718-4723.

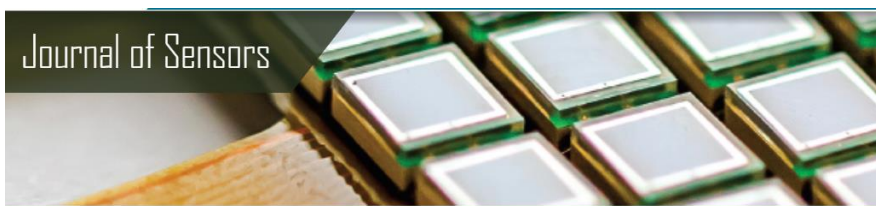

Pérez-Fuster, C., Lidón-Roger, J. V., Contat-Rodrigo, L., & García-Breijo, E. **Inexpensive Measuring System for the Characterization of Organic Transistors.** *Journal of Sensors* 2018.

Journal Impact Factor 2017: **2.057**
Quartile (Instruments & Instrumentation): **Q2**

Research Article

Inexpensive Measuring System for the Characterization of Organic Transistors

Clara Pérez-Fuster, José Vicente Lidón-Roger, Laura Contat-Rodrigo, and Eduardo García-Breijo 

*Group of Electronic Development and Printed Sensors (GEPDS),
Instituto Interuniversitario de Investigación de Reconocimiento Molecular y Desarrollo Tecnológico (IDM),
Universitat Politècnica de València, Universitat de València, Camino de Vera, s/n, 46022 Valencia, Spain*

Correspondence should be addressed to Eduardo García-Breijo; egarciab@eln.upv.es

Received 22 August 2017; Revised 24 November 2017; Accepted 10 December 2017; Published 18 February 2018

Academic Editor: Andreas Schütze

Copyright © 2018 Clara Pérez-Fuster et al. This is an open access article distributed under the Creative Commons Attribution License, which permits unrestricted use, distribution, and reproduction in any medium, provided the original work is properly cited.

A measuring module has been specifically designed for the electrical characterization of organic semiconductor devices such as organic field effect transistors (OFETs) and organic electrochemical transistors (OECTs) according to the IEEE 1620-2008 standard. This device has been tested with OFETs based on 6,13-bis(triisopropylsilylethynyl)pentacene (TIPS-pentacene). The measuring system has been constructed using a NI-PXIe-1073 chassis with integrated controller and two NI-PXI-4132 programmable high-precision source measure units (SMUs) that offer a four-quadrant ± 100 V output, with resolution down to 10 pA. LabVIEW™ has been used to develop the appropriate program. Most of the main OFET parameters included in the IEEE 1620 standard can be measured by means of this device. Although nowadays expensive devices for the characterization of Si-based transistors are available, devices for the characterization of organic transistors are not yet widespread in the market. Fabrication of a specific and flexible module that can be used to characterize this type of transistors would provide a powerful tool to researchers.

1. Introduction

Latest trends in the electronics industry are focused on looking for alternatives to inorganic semiconductors (based on silicon) by organic semiconductors in some applications, namely, transistors [1, 2], light-emitting diodes [3, 4], photovoltaic cells [5, 6], displays [7], sensors [8, 9], and even integrated circuits [1, 10]. These new devices use the same circuits and mechanical structures than inorganic devices, with the advantage of being easier to develop and setup by conventional chemical techniques. Standards describing the fabrication procedures of these organic devices already exist, and substrates and other raw materials for their fabrication are commercially available at low cost [11–13].

Development of these new electronic devices requires their electrical characterization by means of the appropriate equipment [14]. Devices used so far for this purpose are those

traditionally used for the characterization of Si-based transistors, since the operation of organic transistors can be explained on the basis of the Si semiconductors theory, with a good approach. However, it is of great interest to develop devices that allow organic transistors to be specifically studied and that could contribute therefore to improve the understanding of their operation. Characterization of these new electronic devices is hindered by the very low electrical current they provide (around 10^{-6} A), with the further difficulty that they usually require high voltages (tens of volts). Moreover, commercial systems that fulfill these characteristics are very expensive.

This work aims at describing a measuring device that has been specifically designed to study organic transistors, using exclusively low-cost commercial components and a software that has been specially developed for this application. The device described here has great flexibility, since it can be used

for different types of transistors. Finally, this module has been used to characterize an organic field effect transistor (OFET) based on TIPS-pentacene.

OFETs have attracted increasing attention in the past decades due to their potential application as sensor systems for the detection of chemical species [15]. OFETs show superior performance compared to resistor-type, amperometric, and potentiometric sensors, and the amplification inherent to transistors enhances their sensitivity [16]. Moreover, OFETs are low cost and flexible devices that offer several opportunities for selectivity, among others, to polar vapors [17] and vapors of small-molecule analytes [18].

2. Materials and Methods

2.1. OFET Fabrication. Prefabricated OFET test chips based on low-density silicon oxide (SiO_2) substrate have been used (Ossila Ltd., Sheffield, UK). Each unit consists of 5 bottom-contact/bottom-gate transistors, with $30\ \mu\text{m}$ channel length and 1 mm channel width, gold/chrome electrodes in the active area and chrome/aluminum electrodes in the contact pads. The substrate consists of a highly p-doped (Boron) silicon wafer coated with 100 nm thick layer of SiO_2 on both sides (Table 1). The doped silicon and the oxide layer provide the gate and the dielectric, respectively. A detailed schematic of the substrate is displayed in Figure 1.

TIPS-pentacene (6,13-bis (triisopropylsilyl)ethynyl) pentacene) has been used as a semiconductor in these OFETs [19]. This compound is a dark blue solid that is commercially available in the form of small crystals that can be dissolved in anisole, decane, toluene, and so on. Traditional deposition methods of TIPS-pentacene are drop-casting and spin-coating. In this work, drop-casting has proven to lead to better results. A solution of 2% (in weight) of TIPS-pentacene (Sigma-Aldrich, St. Louis, MS, USA) in a solvent mixture containing 91% anisole (Sigma-Aldrich) and 9% decane (Sigma-Aldrich) (in weight) has been used. $50\ \mu\text{l}$ of the semiconductor solution has been deposited by drop-casting, positioning the substrate inside a Petri dish at 3.5° angle with respect to the horizontal line of a flat hotplate at 50°C during 5 minutes. Immediately afterwards, the glass lid has been swapped with filter paper. The substrate has been left to cool down for 1 minute, taking caution that the solvent condensing on the lid does not fall onto the substrate (Figure 2).

HMDS (hexamethyldisilazane) (Sigma-Aldrich) treatment of the substrate surface by vaporization has been used prior to the semiconductor deposition, in order to obtain a nonpolar surface. For that, the substrate has been washed with 2-propanol (IPA) (Sigma-Aldrich), rinsed with deionized water, and air dried. The substrate was treated in a closed Petri dish (sealed with parafilm) together with an $80\ \mu\text{L}$ HMDS vial during 4 hours. Figure 3 shows TIPS-pentacene deposition by means of this technique. A dielectric thickness of 300 nm was achieved.

The electrical characterization of this transistor has been performed with the measuring device described in this work, in order to test its proper operation. A detailed description of this device and the results obtained for this TIPS-pentacene OFET are provided in the subsequent sections.

TABLE 1: Substrate specifications (Ossila).

Size/thickness	$20\ \text{mm} \times 15\ \text{mm} / 725 \pm 25\ \mu\text{m}$
Growth/orientation	CZ/(100)
Type/dopant	p-type/Boron
Resistivity	5×10^{-4} to $10^{-2}\ \Omega/\text{cm}$
Front/back surface	Polished/etched
Oxide thickness (SiO_2)	$300 \pm 5\% \text{ nm}$
Capacitance	$\approx 1.09 \times 10^{-8}\ \text{F}/\text{cm}^2$

2.2. Architecture of the Measuring Device. Current flowing through a device is traditionally measured with an ammeter and a power supply or a (power or voltage) generator. In recent years, almost all of the top/medium of the range measuring devices have communication ports that allow for control of the instruments (GP-IB, RS232, USB, Ethernet, etc.). In order to plot the I-V characteristics of a device, it is necessary to measure the drain-source current (I_{DS}) and the drain-source voltage (V_{DS}) for fixed values of the gate-source voltage (V_{GS}). That is, a V_{DS} sweep is performed in a certain interval for every selected value of V_{GS} , while measuring simultaneously I_{DS} and V_{DS} . This can be performed manually, changing the applied voltage and measuring the current point-by-point. Several programs that allow a generator and a measuring device to be controlled simultaneously using a computer have now come on the market. Nowadays, there are systems that can source a voltage (or electrical current) and read back the associated current (or voltage) simultaneously. These are called source and measurement units (SMUs). A defining SMU characteristic is that they have four-quadrant outputs. They are able to source power in quadrants I and III, as well as sink power in quadrants II and IV. The device developed in this work is based on the NI-PXIe-1073 chassis (National Instruments, Austin, TX, USA). This has been connected to the PCI-e bus of a computer, in order to be controlled (either a laptop or a desktop with Windows 7). This chassis accepts a variety of peripheral module types to be installed. In this work, two NI-PXI-4132 SMU modules (National Instruments) have been selected.

Each one of these SMUs offers up to $\pm 100\ \text{V}$ output (with voltage programming resolution down to $50\ \mu\text{V}$, accuracy of 0.025%, and offset of 3 mV), with current measurement resolution down to 10 pA, accuracy of 0.028%, and offset of 1 nA. The combination of these features makes this system ideal for the measurement of almost all the characteristics of organic semiconductors. The only inconvenient is that OFET characterization requires current sensitivity into the nanoamperes range and below, which is comparable to the module offset. This demands the use of calibration and compensation techniques to ensure correct measurement.

The SMUs are in turn connected to an EverBeing PE-4 probe station (EverBeing Int'l Corp., Hsinchu, Taiwan), consisting of three test probes, three micropositioners, and three triaxial (coaxial) wires. A test probe is used in each one of the terminals of the transistor (gate, source, and drain). The test probes can be moved in several directions with the micropositioners, which allows for measurement of any type of

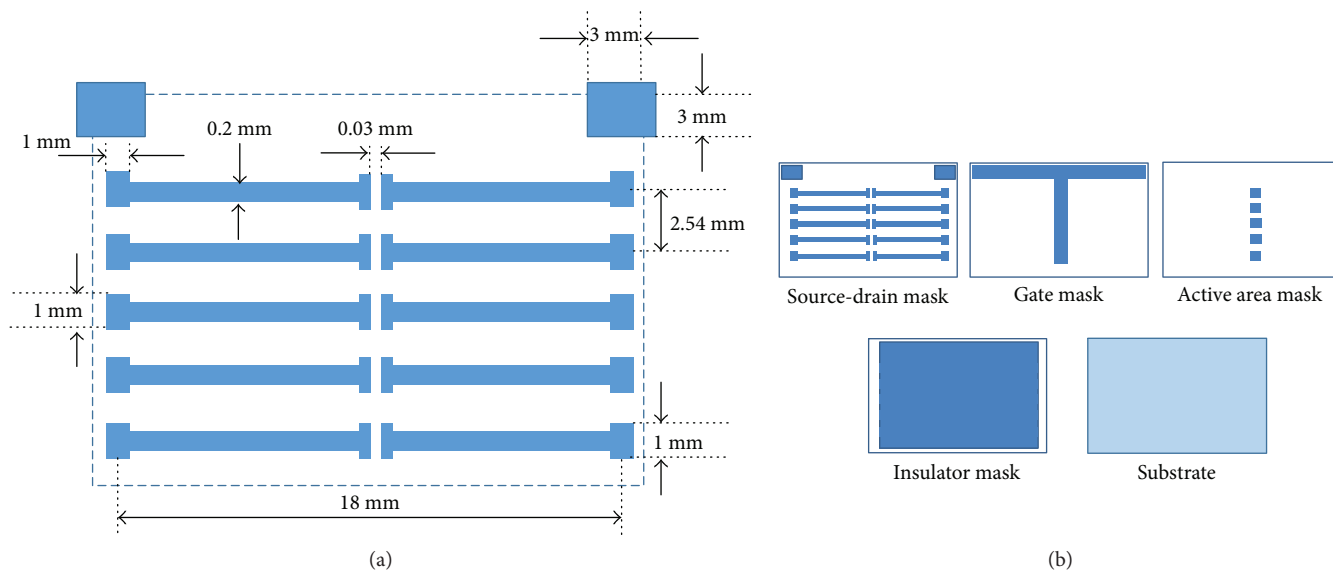

FIGURE 1: (a) Schematic and dimensions of the substrate. (b) Fabrication layers (source: Ossila).

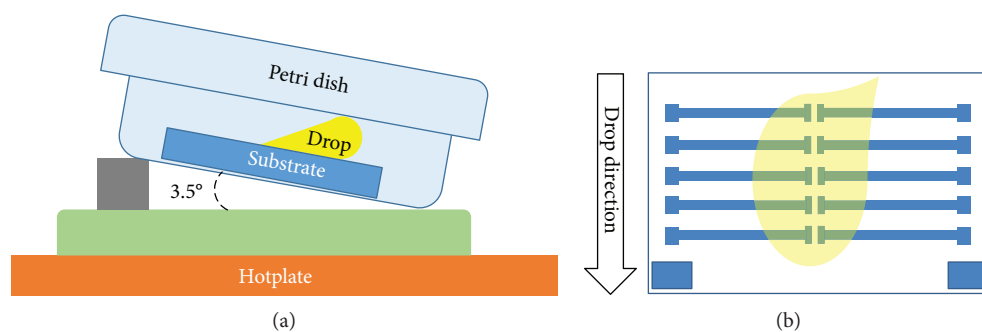

FIGURE 2: (a) Chip preparation by drop-casting deposition (source: Ossila). (b) Top view of the chip with the pentacene solution drop.

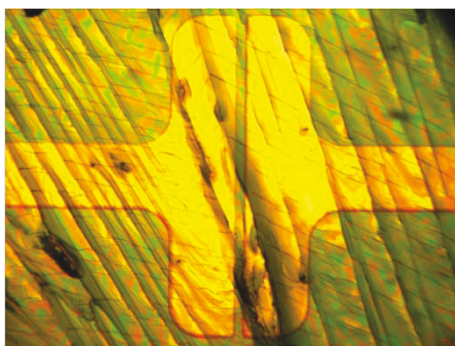

FIGURE 3: Microscope photograph of one of the OFETs of the Ossila low-density chip after deposition of a TIPS-pentacene layer.

transistor and wafer. The L wires of the SMU-1 and SMU-2 are connected to the source, the H wire of the SMU-1 is connected to the drain, and the H wire of the SMU-2 is connected to the gate. Due to the low-level current provided by the organic transistors, 2 wire measurements are performed for the characterization of these transistors. Figure 4 displays the diagram of the complete device. An expansion card has been inserted on the computer motherboard via the

PCI-e bus. The wire that has been used to connect the computer with the PXI chassis is several meters long. This allows the computer to be kept away from the device under test (D.U.T.).

The device has been programmed so that measurements and procedures meet the IEEE 1620-2008 standard for test methods for the characterization of organic transistors and materials [20], and the results can be comparable to those obtained with commercial instruments. The device that has been developed here is able to measure and plot transfer curves (I_{DS} versus V_{DS}) and to calculate threshold voltage, V_T , carrier mobility, μ , (both in the linear regime and the saturation regime), on/off ratio, and so forth. It can also be used to perform measurements in a certain time interval. This can be useful to record the change in a magnitude with time (i.e., I_{DS}) or when a change in the characterization environment of the OFET occurs (i.e., when a pollutant is added).

3. Results and Discussion

3.1. Parameter Extraction Program. As previously mentioned, procedures for obtaining the characterization parameters have been developed according to the IEEE 1620-2008

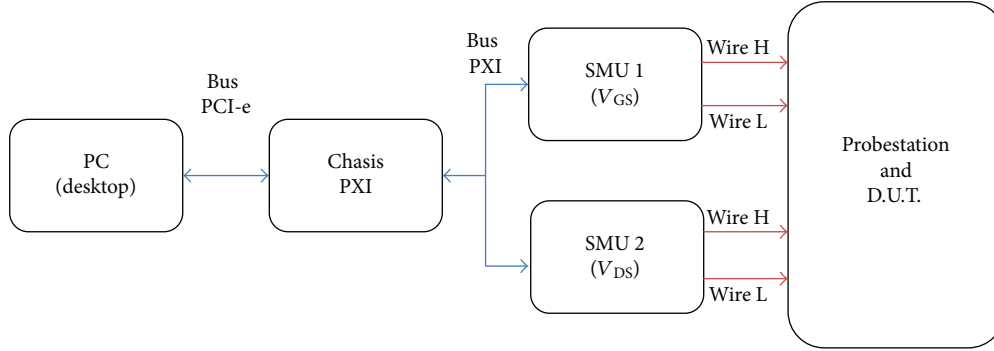

FIGURE 4: Buses and connection diagram.

standard [20]. Test methods are mainly based on the determination of the following parameters:

- (i) Transfer curves (I_{DS} versus V_{GS}), which allow for determination of carrier mobility, μ , and threshold voltage, V_T .
- (ii) Output curves (I_{DS} versus V_{DS}), which allow for determination of the channel resistance (R_{DS}) when the device operates in the ohmic (linear) regime and the characteristics of the saturation regime. These curves can also be used to determine whether the device exhibits FET-like behaviour.
- (iii) Gate leakage curves (I_{GS} versus V_{GS}), which allow for characterization of the gate dielectric quality and for determination of the leakage current from the gate to the channel ($I_{leakage}$).

The test system is controlled by a program that has been developed using LabVIEW (National Instruments). Four modules of this system are currently available: I_{DS} versus V_{DS} measurement, I_{DS} versus V_{GS} measurement, I_{DS} versus time measurement, and I_{GS} versus V_{GS} measurement. Figure 5 shows the flowchart of the different measurement procedures of the test system.

3.1.1. I_{DS} versus V_{DS} Module. This module is based on the measurement of the drain characteristics. The drain current (I_{DS}) is measured versus the drain voltage (V_{DS}) for different gate voltages (V_{GS}). Figure 6 shows a screenshot of this module and Figure 7 displays the output curves corresponding to the TIPS-pentacene OFET described previously. Configuration of the following parameters is required to run this module: V_{DS} start, V_{DS} stop, V_{DS} step, I_{DS} current limit, and V_{DS} delay (dwell time). The dwell time corresponds to the duration from the time when the measurement voltage is applied to the time when the measurement is recorded. This parameter is used to minimize measurement errors due to current transients.

Two types of tests can be performed. The first test (V_{GS} sweep) consists of a scan between two selected values of V_{GS} , that is, the V_{DS} value is swept between two limits for each V_{GS} step. As a result, a set of curves is obtained. In the second test (V_{GS} fixed), a scan is performed for a fixed V_{GS} . As a result, a single characteristic curve is obtained.

3.1.2. I_{DS} versus V_{GS} Module. This module is based on a transfer measurement (I_{DS} versus V_{GS} for a fixed V_{DS}). This curve allows for the determination of additional parameters like threshold voltage (V_T), on/off ratio (I_{on}/I_{off}), subthreshold swing (S) and carrier mobility (μ). Moreover, measurements can be performed either in the linear regime or in the saturation regime.

(1) Linear Regime. Two types of scans can be performed for the determination of I_{DS} versus V_{GS} in the linear regime: simple (single linear scan) and hysteresis (there-and-back scan). The threshold voltage (V_T) corresponds to the interception with the x -axis (V_{GS}) of the straight line with the same slope in the linear part of the I_{DS} - V_{GS} curve (Figure 8(a)). The on/off ratio (I_{on}/I_{off}) can also be determined by dividing the maximum I_{DS} value by the minimum I_{DS} value obtained from the transfer curve.

The carrier mobility (μ) of the semiconductor can also be derived through transfer curve measurement of the device, in combination with geometric and electrical parameters of the OFET that are additional inputs to be provided by the user. Carrier mobility also requires knowledge of the slope of the linear part of the transfer curve. The program developed here allows for the determination of carrier mobility by means of three different methods:

- (i) Backward derivative (B.D.):

$$\mu(\text{B.D.}) = \frac{1}{C_{ox}} \cdot \frac{1}{V_{DS}} \cdot \frac{L}{W} \cdot \frac{I_{DS}(V+h) - I_{DS}(V)}{h}, \quad (1)$$

- (ii) Two-point derivative (T.P.):

$$\mu(\text{T.P.}) = \frac{1}{C_{ox}} \cdot \frac{1}{V_{DS}} \cdot \frac{L}{W} \cdot \frac{I_{DS}(V+h) - I_{DS}(V-h)}{2h}, \quad (2)$$

- (iii) Least square fit derivative (alpha):

$$\mu(\alpha) = \frac{1}{C_{ox}} \cdot \frac{1}{V_{DS}} \cdot \frac{L}{W} \cdot \alpha(V_{GS}), \quad (3)$$

where C_{ox} is the capacitance per unit area, V_{DS} is the voltage measured between the drain electrode and the source

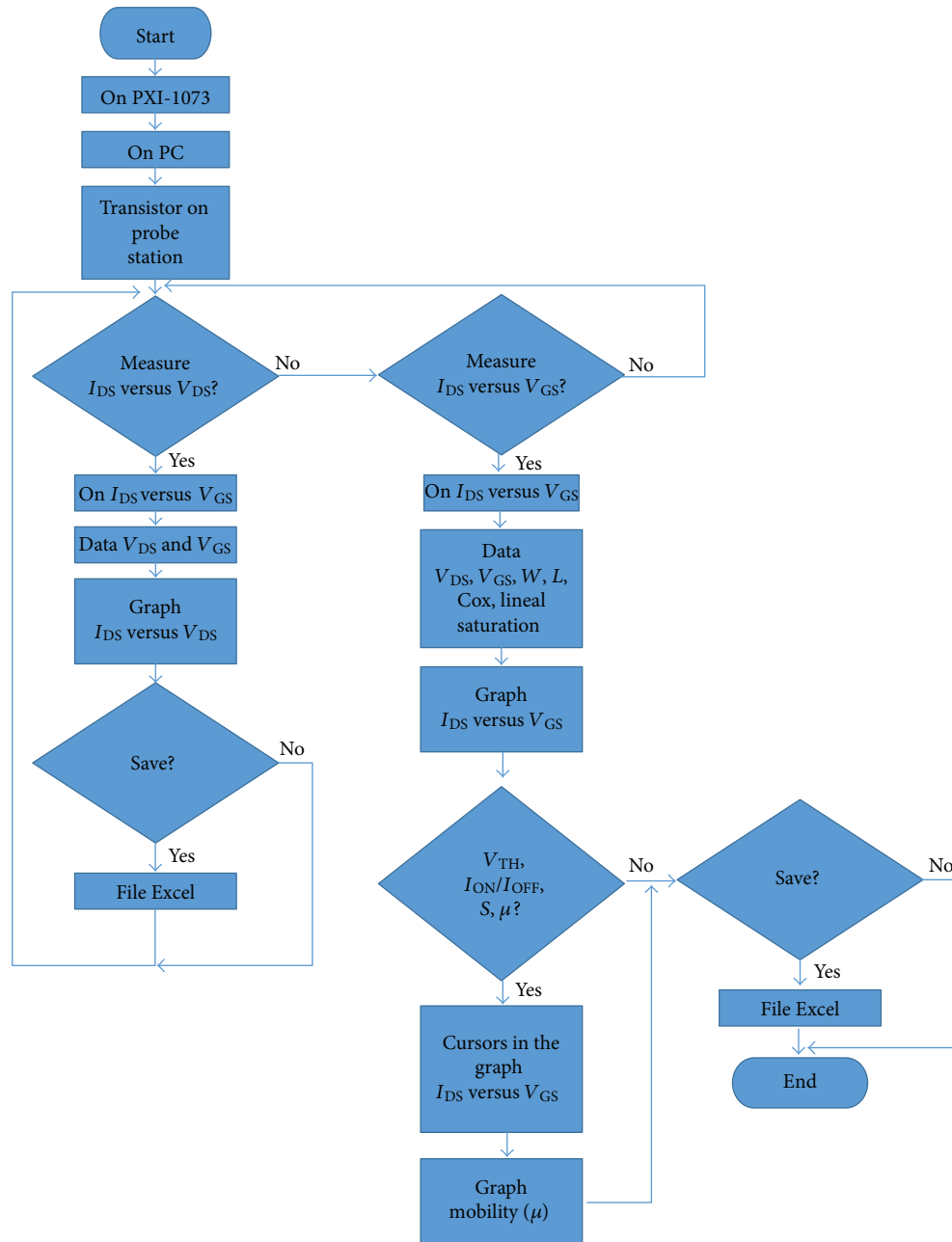

FIGURE 5: Flowchart of the test system.

electrode (fixed value), L is the channel length, W is the channel width, I_{DS} is the current flow measured through the drain electrode, and h is the step between two consecutive V_{GS} . The slope α is determined with three points of the curve by the least-squares method. Figure 9(a) shows an example of the determination of carrier mobility using the backward derivative method.

(2) *Saturation Regime*. The OFET behaviour in the saturation regime can be properly displayed in an I-V diagram, where the square root of I_{DS} and the logarithm of I_{DS} are plotted versus V_{GS} . Figure 8(b) shows an example of this diagram. The threshold voltage (V_T) can be obtained similarly to that

of the linear regime, using the curve of the square root of the drain current (I_{DS}) versus the gate-source voltage (V_{GS}). The on/off ratio (I_{on}/I_{off}) can be obtained from the maximum and minimum values of the curve of the logarithm of I_{DS} versus V_{GS} . The subthreshold swing (S) corresponds to the maximum slope of the $\log(I_{DS})$ versus V_{GS} curve in the saturation regime. Carrier mobility (μ) in the saturation regime can also be obtained similarly to that of the linear regime (Figure 9(b)).

3.1.3. *Measurements as a Function of Time*. OFETs in general have been demonstrated as effective sensors in both liquid (H^+ , glucose, hydrogen peroxide, Cu(II) ions, etc.) and gaseous environments (water vapor, chloroform, ammonia,

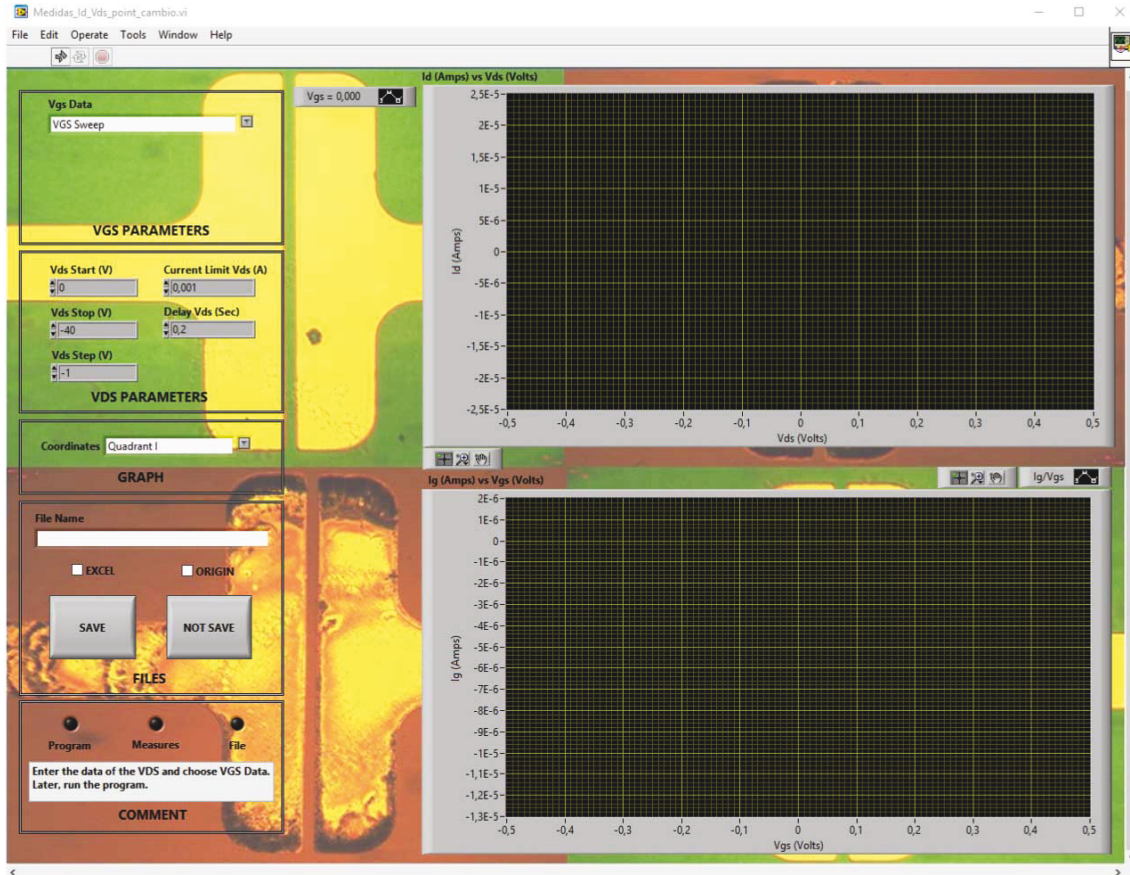

FIGURE 6: Screenshot of the program running the I_{DS} versus V_{DS} module.

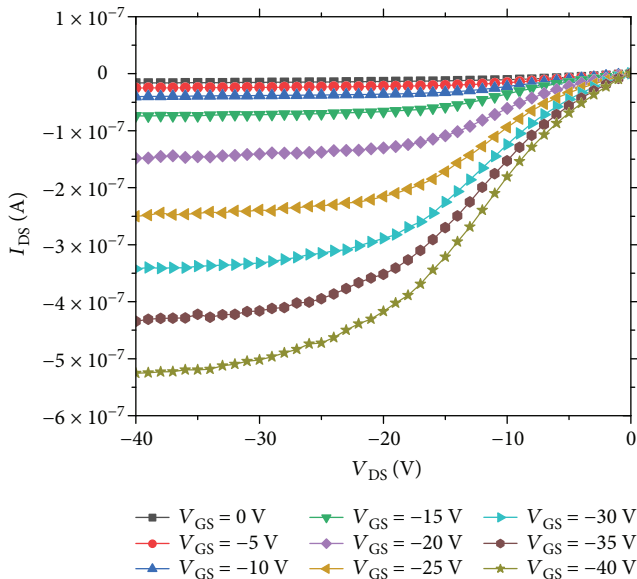

FIGURE 7: I_{DS} - V_{DS} curves of the TIPs-pentacene OFET.

etc.) [15]. Response of these sensors is usually not immediate, since the semiconductor has to react with the analyte. In order to study the OFET behaviour in transients, a module that monitors changes of I_{DS} with time has been included in the characterization program. By providing

values of V_{GS} , V_{DS} , and storage time, I_{DS} values are displayed in real time. Furthermore, since sensing experiments are usually performed while changing the analyte concentration, the program developed here can also indicate when the change in concentration occurs.

3.1.4. I_{GS} versus V_{GS} Measurements. This is the most demanding measurement of the acquisition system, since I_{GS} is very small and several orders of magnitude below I_{DS} (which is also small by itself). Thus, to perform this measurement, the sensitivity in the determination of V_{GS} by the SMU must be enhanced as much as possible. This in turn leads to a significant increase in the measurement time. Figure 10 shows an example of the gate leakage measurement performed with this device.

3.2. Characterization of the TIPs-Pentacene OFET. The main characteristic parameters of the TIPs-pentacene OFET that have been determined in this work according to the IEEE 1620-2008 standard are summarized in Table 2. The threshold voltage that has been obtained is in good agreement with that reported by Ossila for this transistor. A better carrier mobility has been found than that reported by Ossila [21].

3.3. Comparison with a Standard Semiconductor Test System. A comparative measurement has been made between the

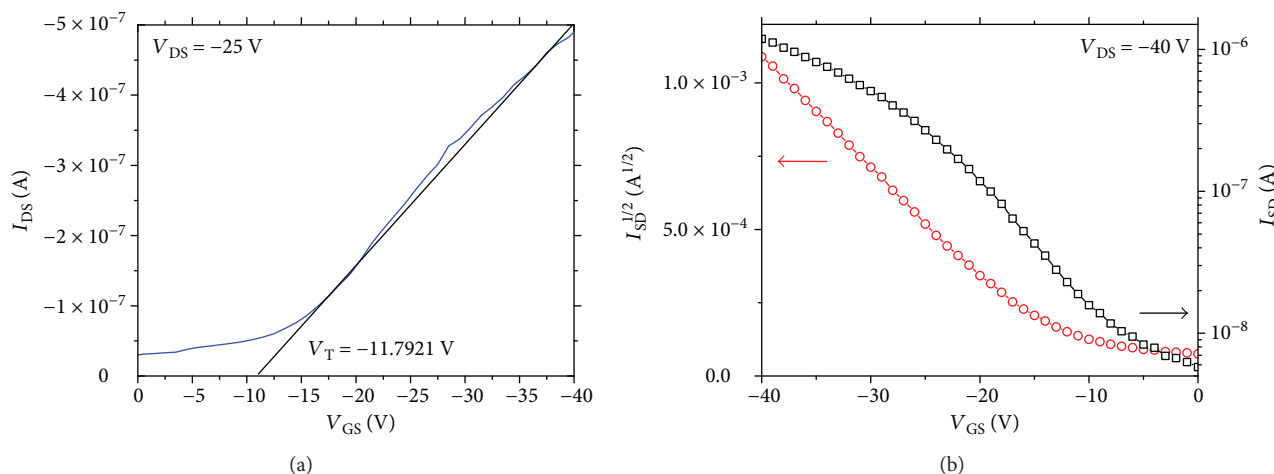

FIGURE 8: I_{DS} - V_{GS} curves of the TIPs-pentacene OFET in (a) the linear regime and (b) the saturation regime.

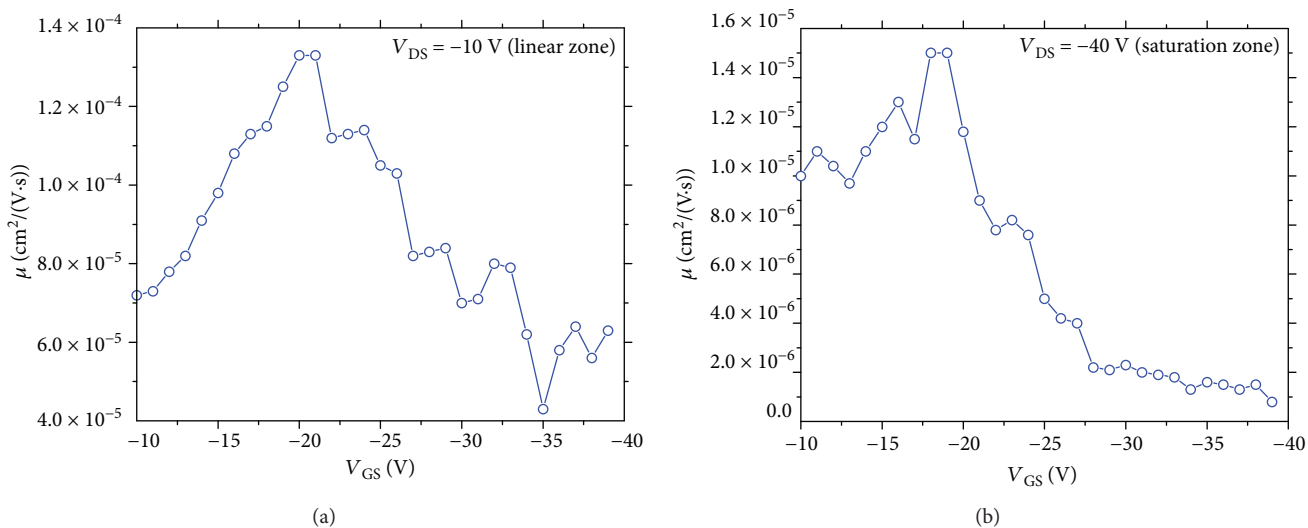

FIGURE 9: Carrier mobility values of the TIPs-pentacene OFET determined with the backward derivative method in (a) the linear regime and (b) the saturation regime.

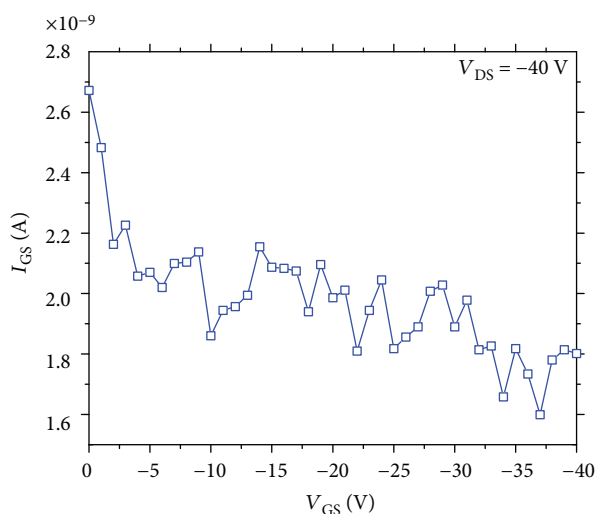

FIGURE 10: I_{GS} - V_{GS} values for a fixed V_{DS} of the TIPs-pentacene OFET.

equipment described in this work and a high-quality semiconductor characterization equipment (Keithley 4200A-SCS Parameter Analyzer) to check its reliability. Figure 11 shows the I_{GS} versus V_{GS} curves obtained with these two types of equipment. An error of 4% has been found in the results of our measuring module compared to those of the Keithley equipment.

4. Conclusions

The unique properties of organic semiconductors cause measurement issues that are not typically encountered with inorganic semiconductors. This renders difficult the electrical characterization of organic transistors, since commercial devices have been all designed for characterizing Si-based transistors. It is therefore of great interest to develop a device that can be used for specifically testing organic transistors. In this work, a low-cost device which allows for systematic characterization of OFETs has been developed. This measuring device allows for easy determination of the minimum

TABLE 2: Characterization of the TIPS-pentacene OFET according to the IEEE1620-2008 standard.

Parameter	Symbol	Value	Ossila
Stray capacitance	C_{GD}	697.38 pF at 100 KHz	—
Stray capacitance	C_{GS}	685.28 pF at 100 KHz	—
Conductance	$g_s = \partial \frac{I_{DS}}{\partial} V_{DS}$	Saturation region = 2 pA/V Linear region = 28 pA/V	—
Dwell time		500 ms	—
Environmental conditions		26°C, 60% RH, dark, air	—
Carrier mobility	μ	Saturation region = $15.10^{-6} \text{ cm}^2/\text{V}\cdot\text{s}$ Linear region = $135.10^{-6} \text{ cm}^2/\text{V}\cdot\text{s}$	0.38×10^{-6}
Gate leakage current	I_{GS}	125 pA	—
On/off ratio		32.91	—
Subthreshold swing		$0.335 \log(A)/V$ ($V_{DS} = -40 \text{ V}$, $V_{GS} = -5 \text{ V}$)	—
Threshold voltage	V_T	-11.79 V ($V_{DS} = -25 \text{ V}$)	-12.99
Transconductance	$g_m = \partial \frac{I_{DS}}{\partial} V_{GS}$	17.25 pA/V ($V_{DS} = -25 \text{ V}$)	—

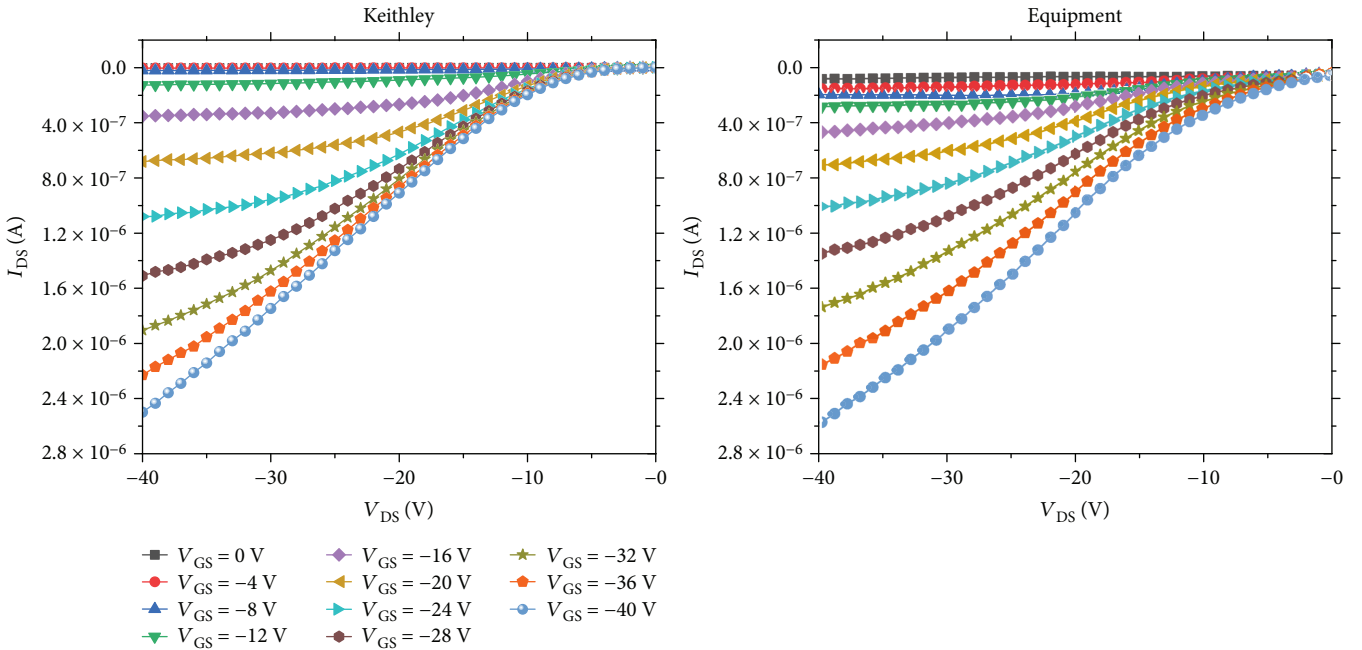
FIGURE 11: I_{DS} - V_{DS} curves obtained with the Keithley 4200 A-SCS equipment and the equipment described in this work.

reporting parameters as specified in the IEEE 1620-2008 standard. As an example, this device has been used for the characterization of TIPS-pentacene OFETs.

Conflicts of Interest

The authors declare that they have no conflicts of interest.

Authors' Contributions

Eduardo García-Breijo conceived and designed the measuring module. José Vicente Lidón-Roger constructed the measuring module. Laura Contat-Rodrigo and Eduardo

García-Breijo designed the experiments for the electrical characterization of the transistors and for DCP sensing. Clara Pérez-Fuster and José Vicente Lidón-Roger fabricated the transistors and performed the electrical measurements. Clara Pérez-Fuster performed the experimental tests for DCP sensing. All the authors analyzed the data and wrote the paper.

Acknowledgments

All financial support from the Spanish Government and FEDER funds (MAT2015-64139-C4-3-R (MINECO/FEDER)) and the Generalitat Valenciana (GVA funds) (AICO/2015/103) is gratefully acknowledged.

References

- [1] B. Kumar, B. K. Kaushik, and Y. S. Negi, "Organic thin film transistors: structures, models, materials, fabrication, and applications: a review," *Polymer Reviews*, vol. 54, no. 1, pp. 33–111, 2014.
- [2] Ö. Abanoz and C. Dimitrakopoulos, "Recent advances in organic field effect transistors," *Turkish Journal of Physics*, vol. 38, pp. 497–508, 2014.
- [3] Z. R. Li, *Organic Light-Emitting Materials and Devices*, CRC press Taylor & Francis Group, Boca Raton, 2015.
- [4] C. Murawski, K. Leo, and M. C. Gather, "Efficiency roll-off in organic light-emitting diodes," *Advanced Materials*, vol. 25, no. 47, pp. 6801–6827, 2013.
- [5] N. Kaur, M. Singh, D. Pathak, T. Wagner, and J. M. Nunzi, "Organic materials for photovoltaic applications: review and mechanism," *Synthetic Metals*, vol. 190, pp. 20–26, 2014.
- [6] J. Yu, Y. Zheng, and J. Huang, "Towards high performance organic photovoltaic cells: a review of recent development in organic photovoltaics," *Polymer*, vol. 6, no. 9, pp. 2473–2509, 2014.
- [7] S. M. Lee, J. H. Kwon, S. Kwon, and K. C. Choi, "A review of flexible OLEDs toward highly durable unusual displays," *IEEE Transactions on Electron Devices*, vol. 64, no. 5, pp. 1922–1931, 2017.
- [8] L. Torsi, M. Magliulo, K. Manoli, and G. Palazzo, "Organic field-effect transistor sensors: a tutorial review," *Chemical Society Reviews*, vol. 42, no. 22, pp. 8612–8628, 2013.
- [9] P. Lin and F. Yan, "Organic thin-film transistors for chemical and biological sensing," *Advanced Materials*, vol. 24, no. 1, pp. 34–51, 2012.
- [10] K. J. Baeg, M. Caironi, and Y. Y. Noh, "Toward printed integrated circuits based on unipolar or ambipolar polymer semiconductors," *Advanced Materials*, vol. 25, no. 31, pp. 4210–4244, 2013.
- [11] J. S. Chang, A. F. Facchetti, and R. Reuss, "Guest editorial organic/printed electronics: a circuits and systems perspective," *IEEE Journal on Emerging and Selected Topics in Circuits and Systems*, vol. 7, no. 1, pp. 1–6, 2017.
- [12] S. Khan, L. Lorenzelli, and R. S. Dahiya, "Technologies for printing sensors and electronics over large flexible substrates: a review," *IEEE Sensors Journal*, vol. 15, no. 6, pp. 3164–3185, 2015.
- [13] S. H. Kim, K. Hong, W. Xie et al., "Electrolyte-gated transistors for organic and printed electronics," *Advanced Materials*, vol. 25, no. 13, pp. 1822–1846, 2013.
- [14] I. Kymissis, *Organic Field-Effect Transistors. Theory, Fabrication and Characterization*, Springer, New York, USA, 2009.
- [15] J. T. Mabeck and G. G. Malliaras, "Chemical and biological sensors based on organic thin-film transistors," *Analytical and Bioanalytical Chemistry*, vol. 384, no. 2, pp. 343–353, 2006.
- [16] I. Manunza, *Organic Field-Effect Devices for Detecting Chemical and Physical Parameters*, Department of Electrical and Electronic Engineering, University of Cagliari, Italy, 2007.
- [17] P. Lienert, S. Fall, P. Lévêque, U. Soysal, and T. Heiser, "Improving the selectivity to polar vapors of OFET-based sensors by using the transfer characteristics hysteresis response," *Sensors and Actuators B: Chemical*, vol. 225, pp. 90–95, 2016.
- [18] A. N. Sokolov, M. E. Roberts, O. B. Johnson, Y. Cao, and Z. Bao, "Induced sensitivity and selectivity in thin-film transistor sensors via calixarene layers," *Advanced Materials*, vol. 22, no. 21, pp. 2349–2353, 2010.
- [19] S. Ochiai, K. Palanisamy, S. Kannappan, and P. K. Shin, "Pentacene active channel layers prepared by spin-coating and vacuum evaporation using soluble precursors for OFET applications," *ISRN Condensed Matter Physics*, vol. 2012, Article ID 313285, 7 pages, 2012.
- [20] Working group for electronic and molecular electronics, "IEEE Std 1620-2008-IEEE Standard for test methods for the characterization of organic transistors and materials.
- [21] Ossila. https://cdn.shopify.com/s/files/1/0823/0287/files/pre_fab_specv2.pdf.

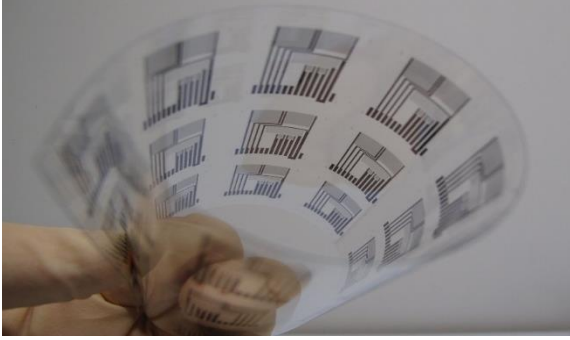

Capítulo 3: Conclusiones

1. Conclusiones de los Resultados Obtenidos

- Se han preparado mediante serigrafía, OECTs basados en PEDOT:PSS con diversas geometrías para estudiar su respuesta en soluciones acuosas de cationes de diferentes tamaños (Na^+ y Rodamina B). Inicialmente, se ha encontrado que la optimización de la respuesta se puede lograr usando transistores con un área de puerta mayor que la del canal. El efecto del electrodo de puerta se ha investigado posteriormente comparando OECTs con la misma geometría, pero con puerta de PEDOT:PSS o no-polarizable (Ag). El funcionamiento de los transistores con puerta de PEDOT:PSS produce una respuesta que no depende de la concentración iónica. Los resultados sugieren que en estos OECTs sólo unos pocos cationes Na^+ migran al canal, mientras que la migración de cationes de gran tamaño como la Rodamina B se ve dificultada. La débil modulación de corriente de estos transistores se puede explicar asumiendo que el PEDOT:PSS se comporta como un supercondensador. Por el contrario, los OECTs con electrodo de puerta no-polarizable muestran una buena respuesta a ambos cationes. La reacción redox que tiene lugar en el electrodo de puerta debido a la presencia de contra-iones Cl^- podría explicar la fuerte modulación observada en estos dispositivos. Por lo tanto, se puede concluir, que para la detección de cationes el uso de OECTs con electrodos de puerta no-polarizable (como Ag) contribuye a mejorar la respuesta. Por otro lado, los resultados confirman que la serigrafía puede considerarse una técnica prometedora para la fabricación de OECTs de bajo coste para la detección de cationes.
- Se ha evaluado el uso de OECTs de PEDOT:PSS como sensores electroquímicos para la determinación del contenido de ácido ascórbico (AA) en alimentos. El rendimiento de estos OECTs se ha comprobado inicialmente con soluciones de AA de diferentes concentraciones (10^{-8} - 10^{-2} M) preparadas en laboratorio. Las medidas de la corriente de drenador indican que para concentraciones bajas de AA (hasta 10^{-5} M), estos OECTs operan en régimen no farádico, mientras que para concentraciones altas de AA (hasta 10^{-2} M) tienen lugar procesos farádicos en el electrodo de puerta, como resultado de la capacidad que tiene el PEDOT:PSS de oxidar electrocatalíticamente el AA. La contribución farádica en este rango de concentraciones mejora en gran medida la modulación de la corriente de drenador y la activación de los transistores. El efecto de la geometría en el rendimiento de estos dispositivos para la detección de AA se ha investigado comparando dos OECT's con diferentes relación de áreas de canal y puerta (γ), en términos de la modulación de corriente, sensibilidad y señal base. La respuesta al AA se mejora en los OECT's con electrodos de puerta más pequeños que el canal (γ grande). Estos transistores muestran una señal base más pequeña que resulta en una mayor sensibilidad y mayor modulación de la corriente en presencia de AA. Los OECT's con γ grande también muestran un mejor límite de detección ($80.1 \mu\text{M}$), lo que confirma que esta geometría proporciona un mejor rendimiento para la detección de AA. Dado que el contenido de AA en alimentos ricos en vitamina C se encuentra en el rango mM, estos transistores pueden considerarse

suficientemente sensibles para monitorizar cuantitativamente el AA en alimentos. Para comprobar la fiabilidad de los sensores propuestos en muestras de alimentos reales, se ha medido con estos OECT's el contenido de AA en zumo de naranja comercial. La cantidad de AA determinada con los OECT's concuerda con la medida por HPLC y con los valores de la bibliografía para zumos de naranja. Además, estos OECT's pueden considerarse candidatos prometedores para la detección selectiva de AA en presencia de otros antioxidantes interferentes.

- Se ha diseñado un equipo específico de bajo coste y manejo sencillo, para la caracterización eléctrica de transistores orgánicos de acuerdo con la norma estándar IEEE 1620-2008. El equipo se ha fabricado utilizando un chasis de National Instruments y dos módulos SMU programables de alta precisión que permiten generar tensiones de hasta ± 100 V, con una resolución de 10 pA. El sistema de medida está controlado por un programa específicamente desarrollado con LabView™, que permite medir la mayoría de los parámetros de caracterización eléctrica de transistores orgánicos incluidos en la norma IEEE 1620. Este equipo se ha testado con OFET's basados en *TIPS-pentacene*. Dado que en la actualidad los dispositivos para la caracterización de transistores orgánicos aún no están muy extendidos en el mercado, la fabricación de un equipo específico y versátil que permita caracterizar este tipo de transistores resulta de gran interés.

2. Producción Científica

La realización de esta tesis doctoral se ha llevado a cabo en el marco de los proyectos de investigación detallados a continuación. Los resultados obtenidos durante su realización se han publicado en los siguientes artículos en revistas indexadas y congresos internacionales

A) Artículos

- Pérez-Fuster, C.; Lidón-Roger, J.V.; Contat-Rodrigo, L.; García-Breijo, E. Inexpensive Measuring System for the Characterization of Organic Transistors. *Journal of Sensors* (2018) 1-9, 2018. Doi: 10.1155/2018/4286894
- Contat-Rodrigo, L.; Pérez-Fuster, C.; Lidón-Roger, J.V.; Bonfiglio, A.; García-Breijo, E. Screen-printed Organic Electrochemical Transistors for the Detection of Ascorbic Acid in Food. *Organic Electronics* (45) 89-96, 2017. Doi: 10.1016/j.orgel.2017.02.037
- Contat-Rodrigo, L.; Pérez-Fuster, C.; Lidón-Roger, J.V.; Bonfiglio, A.; García-Breijo, E. Characterization of Screen-Printed Organic Electrochemical Transistors to Detect Cations of Different Sizes. *Sensors*, 1 (16), 1599, 2016. Doi: 10.3390/s16101599

B) Congresos

- Lidón-Roger, J.V.; Pérez-Fuster, C.; García-Breijo, E.; López-Carrero, J.; Contat-Rodrigo, L. (2015). Sistema de instrumentación para la utilización de los Organic Field-Effect Transistors (OFET) como sensores químicos. IX International Workshop on Sensors and Molecular Recognition (340-345). Valencia, España.
- Pérez-Fuster, C.; Lidón-Roger, J.V.; López-Carrero, J.; García-Breijo, E.; Contat-Rodrigo, L. (2015). Organic Field-Effect Transistors (OFETs) desarrollados con Pentaceno como sensores de gases. IX International Workshop on Sensors and Molecular Recognition (336 - 337). Valencia, España.

C) Proyectos

- Masot, R. (I.P.); Pérez, C.; Laguarda, N.; Lidón, J.V. Desarrollo de Sensores para la Detección de Ácido Ascórbico en Alimentos Basados en Transistores Orgánicos Electroquímicos (01/01/18-01/01/20). GENERALITAT VALENCIANA (GV/2018/090).
- Contat, L. (I.P.); Pérez, C.; Lidón, J.V.; Montes, R. Desarrollo de Sensores Basados en Puertas Moleculares Mediante Dispositivos de Tipo Transistores Orgánicos Electroquímicos y Transistores Orgánicos de Capa Delgada de Baja Tensión. (01/01/15-01/01/17). GENERALITAT VALENCIANA (AICO/2015/103).

3. Líneas Futuras

En el momento de presentar esta tesis se está participando en un nuevo proyecto de la GVA con el título *Desarrollo de Sensores para la Detección de Ácido Ascórbico en Alimentos Basados en Transistores Orgánicos Electroquímicos*, que se prolongará hasta finales de 2019. El objetivo es continuar con la línea de trabajo iniciada en esta tesis sobre la aplicación de OECTs como sensores de AA. En concreto, se pretende analizar el rendimiento de estos transistores para la determinación de AA en presencia de interferentes y, posteriormente, en muestras reales de alimentos ricos en AA.

Por otra parte, se ha iniciado una nueva línea de trabajo para el desarrollo de dispositivos OECT combinados con puertas moleculares, que permitan la liberación controlada de determinados compuestos en presencia de un analito. Si el compuesto liberado es capaz de modificar la conductividad del semiconductor orgánico, se podrá dotar de respuesta eléctrica a sensores que tradicionalmente sólo cuentan con respuesta óptica. Por el momento, ya se han hecho algunas pruebas para detectar *Cocaína* y *Candida albicans* con estos nuevos dispositivos, con resultados prometedores.

