

2011

FINAL PROJECT HISTORICAL, CONSTRUCTIVE AND PATHOLOGICAL ANALYSIS OF MODERNIST BUILDINGS IN SZCZECIN



AUTHORS OF PROJECT:
JORGE SENDRA SENDRA
CLARA SAIS GIRONÉS

**INDEX**

1. INTRODUCTION.....	2	6.1 Study and architectural analysis	66
1.1 Project objective.	2	6.2 Constructive analysis of building	70
1.2 Agents involved.	2	6.3 Problems of the building	75
2. HISTORICAL REVIEW.	3	6.4 Decoration proposal.....	78
2.1 History of Poland.....	3	6.5 Restoration of the garden	81
2.2 Polonia economy.....	7		
2.5 Geography of Szczecin.....	10		
3. URBAN SZCZECIN'S ANALYSIS	15		
3.1 General analysis of the city.....	15		
3.2 Analysis for districts	15		
3.3 Principal accesses of the city.....	19		
3.4 Green spaces and universities	20		
3.5 Urban planning	21		
3.5 Analysis of Turzyn	24		
3.6 Historical evolution of Turzyn	24		
4. PROJECT OF RESTORATION BUILDING N°24	25		
4.1 Study and architectural analysis.....	25		
4.2 Constructive analysis of the building.....	30		
4.3 Problems of the buildings.....	34		
4.4 Restoration proposals.....	45		
5. PROJECT OF RESTORATION BUILDING N°7	51		
5.1 Study and architectural analysis.....	51		
5.2 Constructive analysis of building	54		
5.3 Problems of the building	58		
5.4 Decoration proposal	61		
5.5 Restoration of the garden.....	64		
6. PROJECT OF RESTORATION BUILDING N°44	66		



1. INTRODUCTION.

1.1 Project objective.

Our project will begin with an urban study of Szczecin's city, stops later focusing on the principal objective of the project.

The principal objective of our project is to accomplish a study and rehabilitation of a series of facades of buildings at Szczecin's city (Poland) that belong all of them a century XIX.

We will accomplish the planimetric uprising out of every facade, where we will indicate each of his pathologies. We will study the materials utilized for the construction of the facade, to be able to examine the possible causes of the found pathologies. We will propose possible interventions to realize for the reparation of these pathologies previously commented before this.

1.2 Agents involved.

Authors of the project:

Jorge Sendra Sendra

Clara Sais Gironés

Tutors of the project:

Spanish tutor: Esther Valiente Ochoa

Polish tutor: Zbigniew Paszkowski

2. HISTORICAL REVIEW.

2.1 History of Poland.

Middle ages

Unified state. The last Piast.

During the reign of the last ones Piast: Kings Wladyslaw Lokietek (Ladislao the Parvo) and Kazimierz Wielki (Cashmere the Grande) the heft of the Polish territories was reunified.

Poland became a country loudly, effortlessly administrated, that you took actively part in the political, cost-reducing and cultural life of Europe. Precisely in this period, in 1364, Cracovia's university is founded, you second her in Oriental Europe, after of give it Prague. The capital of Poland plays the part of a diplomatic European center then. Here, in the year 1364, kings' encounter is celebrated. The principal problem of the country 1226, with the Gentlemanly Teutónicos, that had managed to create in Prussia a fortress been you threatened the Polish frontiers constantly were the permanent conflicts with the bohemiens because of Silesia, and, from the year.

Cashmere the Grande did not have legitimate heirs and, in 1370, Piast extinguished the main line of the dynasty himself. The Polish throne exceeded Anjou to the dynasty: To Luis of Hungary (1370-1384) and to his daughter Eduvigis, allied dynasty beforehand and united with the Piast for loops of kinship. You threaten her to the Gentlemanly Teutónicos you tilted Poland then to shape an alliance with Lithuania. The results of negotiations matched : Eduvigis's marriage, even minor but crowned I eat Rey of Poland, with Jagiello, the Grand Duke of Lithuania, and Unión's Minutes of both countries, signed in Krewa in 1385.

Modern time

The jaguelones

The Polish Lithuanian State during the two hundred years following, getting to XV to constitute one-half one of the bigger European empires during the second best the century governed the Jaguelones's dynasty: The Jaguelones governed in Poland, Lithuania, Bohemia and Hungary.

Wladyslaw Jagiello's reign (Ladislao Jaguelón) is correlated generally with its great military success: The victory on the ranks of the Gentlemanly Teutónicos in Grunwald's battle in 1410. Unfortunately, that victory failed to match properly. The Mixed-Breed Teutónicos managed to maintain Malbork's fortress and, in spite of the multiple defeats suffered at the battlefields, to can of the Order inquebrantado kept on . You vary tens of years later another confrontation took place : The so-called war of the thirteen Years (1454-1466), and only then Poland managed to recover the Pomerania Oriental (around Gdansk), and to annul the threat that was constituting the Gentlemanly Teutónicos's Order.



The creation of the Parliament and the enlargement of the privileges of the nobility.

According to the old custom, the Polish gentlemen were summoned by the dukes for the assemblies named diets. At the end of the XVth century, in the year 1493, during the reign of king Jan Olbracht the rules were consolidated for the constitution of the national Diet, which it was including: to the King and to the Senate, which at that time was consisting only of the Real Advice and, like third part, to the Chamber of the Deputies. In the last one there were finding the representatives of the nobility, chosen in the regional assemblies called dietinas, and the delegates of the most powerful cities. It was one of the most ancient European parliaments.

Cultural development.

The epoch of the Jaguelones is also a period of the cultural flowering of Poland, which turns into one of the centers of the European Renaissance. He emphasizes in a special way the role of Kazimierz Jagiellonczyk kings (Casimiro Jaguelón) and Zygmunt Stary (Segismundo Old man). In this epoch Andrzej Frycz Modrzewski was written the "Chronicles" of Jan Dlugosz, the most significant literary works of Mikolaj Rej, Jan Kochanowski, and sculptor Wit Stwosz and the historian Kallimach developed his activities. The level reached by the Polish science in the epoch Jaguelona demonstrates his it at that time revolutionist, work of Nicolás Copérnico: Of revolutionibus orbium celestium. The category of these personalities did that during some generations the classes illustrated in this part of Europe were speaking the Polish language.

The reform in Poland.

The Poland of the XVth and XVIth centuries is also a country opened for new religious currents. Unlike other parts of Europe, here religious wars did not go so far as to explode, the dissidents were finding in Poland not only shelter but even protection on the part of the monarches and of the magnates. The result of this attitude was the enrichment of the cultural and scientific life with new ideas and literary works, in addition to creating the image of Poland as a tolerant country. Not without reason, the contemporaries, and also the later generations, named the "Century of Gold" to the epoch of the Jaguelones, and in particular a XVIth century.

The republic of two nations.

As the Piast, the Jaguelones left the History when they did not have a legitimate heir. King Segismundo Augusto, before his death, happened in the year 1572, still managed to unify in 1569 Poland and Lithuania, up to this moment joined only by the personal tie of the monarch, in only one country called the Republic of two Nations, but this state was already going to be governed by the monarches chosen in the free election realized by the nobility of the country.

The first elect monarches.

The first free election took place in the spring of the year 1573. As candidates for the Polish throne presented before themselves: the duke of Moscovia, Juan IV the Terrible one, prince Ernesto de Habsburgo and the brother of the king of France, Enrique de Valois. The last one turned out to be elected, but it was not a good election. The monarch, who was not understanding to the country to which it was having him to govern, made use of the death of his brother Carlos IX and, after only four months of reign, it absconded from Krakow to France to turn there into king Enrique III.

The Swedish dynasty in the Polish throne.

After the Batory death a grandson of Segismundo I is chosen like king the Old man, Swedish prince Segismundo, the first Polish king of the Swedish dynasty Vasa. Three kings of this dynasty: Segismundo III, Ladislao IV and Juan Casimiro, governed Poland for 70 years, until the year 1688, and although, certainly, they managed to support the prestige of Poland as a big country with proper weight in Europe, unfortunately they involved it in a series of military conflicts. Neither they could prepare the bloody civil war in Ukraine and allowed a considerable increase of the power of the magnates of the aristocracy. Las guerras y la devastación del país.

From the beginning of the XVIIth century, Poland meets uninterruptedly in state of war some of the nearby countries. The military victories: in 1605 in Kircholm, on the Swedishes; in 1610 in Kluszyn on the Russians; in 1621 in Chocim on the Turks; they interlace with the defeats: in 1612 the defeat of the Polish intervention in Russia; in 1620 the defeat in Cecora against the Turks; in 1648 a series of disasters during the uprising of the Cossacks, led by Chmielnicki, in Ukraine. These circumstances necessarily had to do notch in the interior situation of Poland: the country was devastated, the Treasure was emptying, the Diets were turning out to be completely inoperative (from the year 1652), the opposition of the nobility was growing to the power of the monarch. The culmination of the misfortunes turned out to be the period of the "Swedish deluge" in the years 1655-1660, when the country had to face at the same time the invasion of the Swedish, Russian, Cossack, Prussian troops and transilvanas. Although this war ended with the victory, Poland went out of her devastated and much debilitated internally. Due to the pressures of the Counter-Reformation and the wars with the countries governed by non-Catholics (orthodox Russia, Protestant Sweden) it began to diminish the religious tolerance, they were happening stirred of noble and big magnates of the aristocracy against the king (rokosz), what finally ended in a civil war, in 1655, which concluded with the abdication of king Juan Casimiro in 1688.

In alliance with Saxony.

The period in which the kings of the dynasty Wettin of Saxony (Augusto II and Augusto III) sit down in the Polish throne, coincides with the progressive decrease of the political and military importance of Poland. The participation in the War of the North (1702-1721) brought I obtain more devastation. Although dweeb and dependent on the neighbors, Poland was continuing his rapid economic development in the European frame.



The last king.

The reign of the last sovereign one of the Republic of two Nations, Stanislaw August Poniatowski, it was full of discrepancies. On the one hand he was a submissive monarch to Russia, thanks to whose support was elected a king and he was depending on the clan of the Czartoryski, to which it usually call the "Family"; on the other hand, during his reign a period of cultural flowering lived through Poland. In this epoch there are published the historical works of Adam Naruszewicz, the satires and novels of the bishop Ignacy Krasicki, his journey begins the national theater, which creator was Wojciech Boguslawski. Warsaw, the capital of Poland from the times of Segismundo III, turns into one of the centers of the classical architecture of what there can be an example the palace and the park named Lazienki Krolewskie.

The disintegration of the state.

At the same time the State, increasingly dweeb, was unable to defend itself opposite to the aspirations of the nearby potency. Russia, Prussia and Austria carried out the First Division of Poland in 1772; the Republic of two Nations lost then a third of his territory. They had contributed to this situation to a great extent the increasing internal disorder and the pronouncements of the nobility. The radical reforms carried out in Poland in the nineties of the XVIIIth century (the Constitution of May 3, 1791) propitiated a new intervention of Russia and Prussia, worried by the possibility of a strong Poland. In spite of the resistance, Poland was subjugated by a top force: in 1793 the Second Division of Poland was realized. This time the traitors helped actively to the potency particionistas the homeland, authors of the pronouncement of Targowica. The defeat of the anti-Russian insurrection of 1794 (the insurrection of Kosciuszko) was the last and decisive blow to the independent Poland. In 1795 Russia, Austria and Prussia stop distributing the territories of the Polish Republic and have to abdicate Estanislao Augusto. From this moment Poland "had to be erased of the map of Europe forever.

XIXth century.

Napoleón the hope of the Poles.

With the change of century, of the XVIIIth the XIXth, there arose again the hopes to recover the independence thanks to the military successes of Napoleón. The troops of the Polish Legions, created in Italy, fought in numerous battles of the Napoleonic campaigns. Napoleón realized, partly, the hopes of the Poles. After having conquered Austria and Prussia, in 1807 it created the Big Duchy of Warsaw on a part of the territories of the ancient Polish Republic. It helped also the Poles in the creation of a proper army, headed by the nephew of the last Polish king, prince Jozef Poniatowski. The Polish troops took part in all the campaigns and big battles. But the defeat in the war against Russia (1811-12), and the later fall of the emperor they changed the destination of Europe and of Poland.

For the independence with the weapon in the hand.

The Poles did not leave the idea of full independence. Already in the year 1830, in consonance with the protests wave in the whole Europe against the decisions of the Congress of Vienna, there exploded in the Kingdom of Poland a military insurrection (the Insurrection of November - 29.11.1830), which proclaimed the removal from office of the czar of the throne of Poland and summoned a National Government. In spite of the initial successes, the insurrection failed. The Kingdom of Poland turned into an integral part of the Russian Empire and the Parliament it was dissolved.

The Poles in the exile.

After each of the uprisings, an exiles' wave was turning out to be forced to leave the Polish grounds. The defeat of the insurrection of November did that more than ten thousand persons had to emigrate. The high number and also the intellectual potential of the members, since they were between them the out-standing politician Adam Czartoryski; the poets: Adam Mickiewicz y Juliusz Slowacki; the composer Frederico Chopin; the historian Joachim Lelewel, and almost the whole "major state" of the insurrection, determined that this exiles' mass was named the Big Emigration. Most of them integrated into the political life of Europe, without leaving the performances in favor of the independence of Poland.

XXth century

The way of the independence.

The First World war brought the solution to the Polish problem. The political vision of Jozef Pilsudski, the Commander of the Polish Legions, with orientation proaustriaca, turned out to be the most effective. He supposed that Germany and the Austro-Hungarian Empire would conquer Russia and that those, in turn, would be defeated by France and England. On the ruins of the potency particionistas it might then erect the independent Poland. And this way it is as it happened: Russia, after the revolution of the year 1917, moved back from the war, while Germany and the Austro-Hungarian Empire gave up before the western Allied Forces.

The Treaty of Versailles, which was closing the World War I, just was confirming the Polish independence. Already in October, 1918 the Polish troops began to disarm the German and Austrian soldiers

The proper state - difficult beginning.

Three months, after having recovered the independence of the country, the Constituent Diet began his works. The approval, in February, 1919, of the Small Constitution, the agrarian reform, the creation of the organs of the state administration, the reconstruction of the educational system and of the industry devastated during the war, took place at the same time that the insurrections happened in Silesia and the war was developing with the Bolshevik Russia. In March, 1921 the Polish Republic had already a modern constitution. The first years of peace and independence brought, nevertheless, numerous tensions to the internal matters of the country. Numerous political conflicts and the increasing economic crisis ended in the loss of authority of the leaders.



Sanitation.

The "Government of Sanitation" (Sanacja) contributed to Poland the economic stabilization, but at the same time he supposed the change of the democracy to the authoritarianism. The Marshall Pilsudski was ruling with a firm hand, was not tolerating the disagreement and he did not hesitate to use drastic methods to control the politicians of the opposition.

The catastrophe - the end of the brief independence.

The existence of the Second Polish Republic was cut by the explosion of the Second World War. On September 1, 1939 Germany invaded Poland; on September 17 the Soviet Union attacked for the East. After a month of combats, Germany and the Soviet Union perpetrated another division more, of so many people that Poland had suffered. In a part of the occupied territories by the Nazi the called General Government was created, other one was annexed to the Reich; the oriental territories were annexed by the Soviet Union. Both invaders initiated, although to different scales, the politics of extermination of the Polish population; there filled the German concentration camps and the Soviet gulags, the Polish intellectuals were shot by the Germans of massive form in Palmiry and Wawer, in proximities of Warsaw, and in many other executions places. By order of Stalin there were shot twenty-one thousand officials, officials of the state and intellectuals, principally in Katyn and Charkow.

To hands of the Nazi there died more than two million Poles and nearly three million Jewish Polish citizens. The Soviet authorities arranged the necessary exile of hundreds of thousands of Poles and of Jews who were taken to the east of the Soviet Union, where many people died. In the years 1939-45 the whole territory of Poland was submitted to radicals and bloody actions of ethnic purge. The Government of Poland was continuing the struggle. The linked clandestine organizations had created in the Poland occupied by the Nazi the real Clandestine State, with their own administrative system and a wide system of secondary and top education, since all the schools, except the elementary education, had been suppressed.

In the fronts and offices.

During the war the Polish troops were fighting in all the fronts: in Narvik (Norway), in French campaign, in Battle of England of 1940, in Tobruk (north of Africa) in 1941-42; and in Normandy, in Montecassino in 1944. The biggest group of the Polish army in Occident was the Second Body of General Anders in Italy; created in 1941 in the Soviet Union and in whose lines there were principally the Polish prisoners liberated to the effect, by virtue of the agreement between Sikorski and Stalin. The Poles had collaborated with the Allied Forces also in the secret services, since they had deciphered the code of the German Enigma, but for the future of Poland the most important thing were the political decisions. The only authorization on the part of Stalin was the agreement to grant to Poland the areas placed in the basin of the river Oder and ancient Oriental Prussia.

Communist Poland

The communists - a new system.

Poland was going to be governed by the PPR (Polish Working Party) that, from 1948, would be called PZPR (Polish Unified Working Party - POUP). In the years 1948-1956, in the called Stalinist period, the communist party governed Poland of an uncontroversial way, with wide help of the political police and of "Soviet advisers". The political adversaries were not the only ones affected by the countermeasures; there were coming to the jails not only the soldiers of the Interior Army, or the catholic priests (the internment of the Primate of Poland, Wyszynski in 1953), but even the same uncomfortable militants of the POUP.

Poland was then one of the been faithful satellites of the USSR. Of the economic structure of the country there had disappeared almost all the small businessmen and experts who did not belong to the Party and the agricultural property was collectivized. The industrialization that was realized to forced marches provoked a considerable descent in the standard of living and a big dissatisfaction in the population.

The Polish way to the democracy. "The round table"

The achievement of a commitment in the "Round table" and the pacific change of the communist system to the democratic system was possible thanks to the substantial change of the politics of the USSR that, in the years 1986-1988, began to apply the beginning of the pierestroika and glasnost, as well as the political and economic opening towards the rest of the world.

III República.

Por primera vez en más de 40 años, Polonia había un gobierno dirigido por no comunistas. En diciembre de 1989, el Sejm aprobados por el gobierno de la reforma del programa encaminado a transformar la economía polaca rápidamente de planificación centralizada a una de libre mercado, modificó la Constitución para eliminar las referencias al "liderazgo" del Partido Comunista, y cambió el nombre del país de la República "de Polonia. "

El polaco de Trabajadores (comunista) se disolvió en enero de 1990, creando en su lugar un nuevo partido, Democracia Social de la República de Polonia.

En la década de 1990, Polonia hecho grandes progresos hacia el logro de un gobierno plenamente democrático y una economía de mercado. En noviembre de 1990, Lech Walesa fue elegido presidente para un mandato de cinco años. En diciembre de Walesa se convirtió en el primer presidente elegido por el pueblo de Polonia.



En noviembre de 1995, Polonia celebró su segunda post-guerra elecciones libres presidenciales.

In 1997 the parliamentary elections of both parts with roots in the movement Solidarity - Electoral Action Solidarity (AWS) and the Union of the Freedom (UW) - gained 261 of 460 benches in the Sejm and formed a coalition government. In April, 1997, the new Constitution of Poland ended, and in July of putting into practice, to replace the used ones previously modified communist statute.

Poland joined the NATO in 1999.

Poland joined the European Union in May, 2004. So much the president Kwasniewski and the government vocal in his support to this cause.

After the fall of the communism, the government policy to guarantee the full employment had ended and not profitable many the big state companies were closed or restructured. East and other economic problems of the transitional period caused the unemployment to be sometimes so high as a 20 %. With the European Union the access, the gradual opening of the European labor markets West together with the national economic growth, led the Polish workpeople to a notable improvement in the situation of the employment (at present over 10 %) in Poland.

The Poles the stability hope without precedents in the history inside the European Union. The introduction of the currency of the euro and the moment difficult decisions are, considering the economic crisis in the area of the euro.

In the current big economic crisis in the whole world, it has shot and is exemplified, in particular, by the collapse of 2008 USA and the rescue of the bank system, the Polish economy has got over the crisis, compared to many other European, relatively safe countries. The social price paid for the Poles for the application of economic liberal politics of free market has been the most unequal distribution of wealth and drastically the impoverishment of big sectors of the society. President of Poland Lech Kaczynski and all on board died in a plane crash on April 10, 2010 in the west of Russia, it surrounds deSmolensk.

The president Kaczynski and other out-standing Poles were in the way to the massacre of Katyn a commemoration of the anniversary.

In the end the second return of the presidential elections of Poland July 4, 2010, Bronislaw Komorowski, temporary President, the marshall of the Sejm and a Civic Platform politician, defeated Jaroslaw Kaczynski in 53 % to 47 %.

The tragedy of Smolensk put in the deep divisions opened inside the Polish society and it turned into a destabilizing factor in the politics of Poland.

2.2 Polonia economy.

The principal problem of the independent Poland was of economic nature: in 1990 the hyperinflation, out of control, came to 500 %; the big foreign debt was not allowing any type of investments. The factors as the secret unemployment, the antiquated and slightly profitable industry, and his agriculture last night were making moreover the situation difficult. Poland chose then to start the called "Plan of Balcerowicz", which author was the minister of finance of the moment. This plan was based on the liberalization of the prices on the domestic market, on the growth of the imports, on a more strict control of wages and of the financial policy of the companies, on the application of bank interests superior to the inflation; in the stabilization of the exchange rate of the American dollar and in the introduction of the convertibility of the zloty. As result, the Polish economy became stable and one opened to the markets of the world. There reformed the bank system and the financial and credit policy. There was created in Poland the market of capitals and the labor market. In July, 1990 the Diet approved the Law of Privatizations. In July, 1991 the IRPF interfered and in 1992, the VAT.

The transformation of the property, the independización of the companies and the stimulation of the competition on the domestic market redeemed a role emphasized between other reforms of the system. The politics of privatization of the state patrimony, the introduction of the beginning of the free market and a radical reduction of the budget deficit began to contribute results. The Stock Exchange of Values of Warsaw initiated his functioning in 1991. The GDP kept on growing, from 4 % in 1993 up to 7 % in 1995. The zloty, entirely convertible, was devaluated in 1995 applying the change of 1 zloty new (PLN) for every 10.000 zlotys "old men"; the success of the financial reforms stabilized the exchange rate with regard to the dollar. In the years '90, in the central part of Warsaw construlleron many buildings.

At present Poland is a country with a stable political system and which economy is in full development. Poland takes part actively in the international organizations.

The economic development, although lately less rapid, it is stable and is endorsed by deep social reforms: between them the reform of the system of pensions and of the health care.

For ten years there is carried out the process of the adaptation of the regulation and of the Polish economic entities to the current laws in the European Union. His starting point is the application of the norms of functioning of the free market, which, in turn, is based on the activity of the private sector, which is already the predominant one and development is in continuo. As it happened in the countries of the European Union, the privatization turned out to be more complicated in case of the heavy industry, for his big social impact. There is still carried out the process of privatization of a group of big companies of the iron and steel, chemical industry and of machinery. The same happens in the sector of the energy.



2.3 Polonia geography.

Poland is a country of Central Europe. In general terms, Poland is an uninterrupted flatness that goes from the Baltic Sea in the north of the mountain range of the Carpathians in the south. Inside that, the changes of the flat area in general, they are executed in the bands of this one on west. The coast of the Baltic natives lacks ports except that of Gdansk, Gdynia and the region of Szczecin, in the extreme northwest. The region North-East, called the District of the Lajos, is wooded and slightly inhabited and that lacks the agricultural and industrial resources. On the south and to the west of the region of the lakes, a vast flatness region extends to the Sudetes in the Czech and Slovak Republic borders to the Southwest and to the Carpathians in the opposite Czech Republic, Slovakia and Ukraine towards the southeast. Poland occupies the central territories of the European continent. Not far from Warsaw is the geometric center of Europe. There cross the lines that join the most distant points of Europe: the ends – Nordkyn (Norway) with Matapan (Greece) and the end Rock (Portugal) with the way of the Urals. For the country the continental border happens between the East Europe and that of the West.



(Map of Poland www.kasprzyk.demon.co)

The highest elevation is the Mount Rysy, which raises 2.499 meters in the Tatra status of the Carpathians, 95 kilometers to the south of Krakow. About 60 kilometers squared along the Gulf of Gdansk are below the sea level. Poland divides traditionally in topographic five north areas on south.

The territory of the Polish state occupies a surface of 322,5 thousand of km² what it places to him in a ninth position in Europe and 63 in the world. The surface of Poland is a 1,4 % of the area of the whole Europe and 0,23 % of that thing about the world. Poland is 120 times bigger than Liechtenstein and 520 – that Singapore.

The average of elevation of Poland is 173 meters, and only 3 % of the Polish territory, along the south border, it is major than 500 meters.

The biggest, the central depression, or "Polish flatness" (Pole: Polski Niz or Polska Nizina), it is narrow in the west, it expands towards the north and south spreads to the east. Along the oriental border, this area spreads from the North-East even inside 200 kilometers of the south border. The area in the central low grounds is quite flat, and previous lakes of origin glacier that have been covered by sediments. The region is cut by several important rivers, including the river Oder (Odra), which defines the low Silesia grounds in the south-west, and the Vistula (Wisla), which defines the low areas of the this center of Poland.

To the south of the low grounds there are the high grounds of the minor of Poland, a belt of variable width from 90 up to 200 kilometers, formed by the soft slope of hills of the Sudetes and mountain ranges of the Carpathians and the high grounds that connect the status in the south center of Poland.

The third topographic area is on both sides of the south border of Poland and is formed by the Carpathians and status of the Sudetes. In Poland, none of this status is prohibited sufficiently to avoid important establishments, the Carpathians are especially densely inhabited. The highest elevation of the Sudetes is 1.602 meters, in the Karkonosze mountains. There are the north rim of a scale much bigger that spreads up to the Czech Republic, Slovakia, Ukraine, Hungary and Romania. In Poland, the scale includes two principal basins, the Oświęcim and Sandomierz, which are rich in several minerals and natural gas.

To the north of the central depression, the region of the lake includes the only forest vírgen that stay in Europe and big part of Poland virgin natural habitat of the reduction. The glacial action in this region formed the lakes and hills low in the apartment of the adjacent area otherwise to Lithuania and the Baltic Sea. Small lakes splash the north of his half of Poland, and the formations glaciers that they characterize to the region of the lakes extend up to 200 kilometers ground inside in the west of Poland. The vales of the rivers dividen the region of the lakes in three parts. In the northwest, Pomerania finds to the south of the coastal region of the Baltic and the north of the Warta and Noteć rivers. Masuria occupies rest of north of Poland and he is provided with a series of big lakes.



(Map of Poland www.kasprzyk.demon.co)



Most of 9.300 lakes of Poland, which are more than 10.000 square meters of surface is in the north part of the region of the lakes, where they occupy 10 % of the surface. The coastal flatness of the Baltic there is a region of low altitude formed by sediments deposited by the sea. The coast forms for the action of the sea in increase after the Scandinavians ice layer it moved back. Two principal earnings on the coast without problems are those of the Bay of Pomerania, on the German border, in the extreme northwest and the Gulf of Gdansk, in the East. The river Oder ends in the first one, and one forms the Vistula big delta in the head of the last one. Sand Banks with dunes form big lagoons and coastal lakes along big part of the coast.

The current territory of Poland remained fixed by the winning potency after the second world war. Consequently of the signed agreements Poland has lost more than 20 % of his area of before the war.

Borders

The Polish map he emphasizes the form typical of the peninsula of Hel (34 km long and 500m of width for way). The western border of Poland is with Germany (467 km), that of the South with the Czech Republic (790 km) and Slovakia (541 km) and of the East – with Ukraine (529 km), Belorussia (416 km), Lithuania (103 km) and Russia (210 km). The whole Polish frontier line measures 3496 km (in the ground and in the Baltic coast).

Important cities

In the year 1999 there has got the new system of the administrative region of Poland in municipalities, districts and voivodías. The ties of the territorial autonomous power are: municipalities (2489), districts (308) and 16 voivodías of self-governments. The biggest cities are: Warsaw, Lodz, Krakow, Wroclaw, Poznan, Gdansk, Szczecin, Bydgoszcz, Katowice and Lublin. The most important geographical regions are: Pomerania, Masuria, Wielkopolska (The Big Poland), Mazovia, Podlasie, Silesia, Malopolska and Podkarpacie.

2.4 History of Szczecin

Szczecin has a multinational and multicultural past. The history of the city began at the beginning of century, when the hill of the castle, nowadays, already existed a Slavonic establishment and fortitude. At the end of the Xth century Szczecin turned into a fief Polish prince Mieszko I, but in 1005 years Pomerania recovered his full independence. For the second time in Polish Szczecin orbit the mouth Boleslaw was at the moment of the crooked one.

In the year 1184-1227, together with Szczecin Pomerania was under Danish domain. About the XIIth century, the perspiration began to appear in German Szczecin. first that established close to current Lounge of the Old City. From this point it goes back to the vigorous inflow of the city of the German population and an increase of his importance. The people grows quickly German in 1237 has already absorbed the ancient Slavonic city.



Szczecin has been the permanent head office of the prince. Since then, the city began to redeem a domineering political role in Pomerania.

(Pictures: The current State of the castle of the Dukes of Pomeranian)

(Source information: <http://history.howstuffworks.com>)

There was created an autonomous organism of the state of Pomerania, and the representatives of this dynasty more than 500 years (1121-1637), celebrated the government in Pomerania.

Duchy of Pomerania was a been stopper between the Poles, of Brandenburgo and the Teutonic Order and also it was a fief of the German Reich.

Politics towards the countries of the leaders of way of Pomerania during a considerable period of the history was limiting itself to supporting to a great extent more wide of the longest duration and autonomía.



En the first half of the XVIIth century saw the slope of the epoch of prosperity, and soon there was an economic recession marked in the whole principality, irritated by the effects of religious War of Thirty Years (1618-1648).

In 1637 there died without children Prince Boguslaw XIV, the last one of the dynasty of Griffin in the Szczecin throne. Szczecin and big part of the Pomerania was in hands of Sweden.

During the reign of 90 years of the Swede in Pomerania and Szczecin marked by a clear deterioration of the city, the port and the commerce.

The Big War of the North ended with the agreement of Stockholm. Szczecin in 1720 incorporated Prussia and obtained the statute of the capital of the province of Pomerania.

The Prussian authorities have done an important military center of Szczecin, which turned into a powerful expression of the defenses, much over the surface of the city. During the Napoleonic wars, the city several years (1806-1813) was an important one the French say. Frenchman Manténgase a significant decrease of the population and it took the city to the economic collapse.



The railroad line between Szczecin and Berlin was constructed in 1843, doing even more attractive Szczecin from the commercial point of view. Many investors attracted the new possibilities, what he contributed to the development of the naval industry.

(Picture of tramcar Szczecin). (Source information: www.poland/poland.com)

In the second half of the XIXth century Szczecin the industry developed quickly, especially thanks to his good relations with the marine port. In 1913 there was opened the channel that Szczecin connects with Berlin, what guaranteed more port activity. In April, 1945 the red army of Russia conquered the city and one returned it to the Polish administration in July of the same year.

The city, now placed on the border west of Poland, survived the war without serious damages. Although the original image of the city has changed a lot of, his only character has survived together with the exceptional nature of his architecture art nouveau and the beauty of the splendid verdure of his surroundings.

After returning to the city of Prussia, they began to re-live through the shipbuilding industry, and the city little by little turned into an important center of the industry in the Prussian State.

Prussian the military authorities have developed a fortitude of Szczecin, which for the long time is reflected negatively in the town-planning development of the city.

Permanent flow of the rural population to the cities and the industrial and commercial development means that the opportunities for the spatial development of the bristles concerning the fortifications became exhausted quickly.

Many years of efforts to interrupt the authorities of the city have been successful defenses in 1873, when they began to beat in the fortifications and walls of the city. From this point it goes back to a dynamic expansion of the city.

The spatial development bristles in this moment was a geometric classic urban design boss, for that he accepted like base for squares covered with stars with plots triangular building, which state buildings were constructed in neoclassic style and New art and buildings of functional apartments. Another important stage in the development of the spatial city began at the end of the XIXth and XXth century, when it continued to the integration in already urbanized Szczecin areas, but independently from the suburban quarters and peoples. This evolution collaborated with a significant expansion of the infrastructure.

On April 26, 1945, Szczecin was captured by the Soviet army in 1965, and the Polish administration took charge of the city on July 5, 1945. In the Conference of Potsdam Three Big ones he decided to grant the Poland Szczecin. During the Second World War, the buildings of the city it was destroyed in 60-70 %, together with the adjacent properties to 70-80 %, and the industrial facilities were destroyed almost 90 %. The most affected areas of the river Odra and buildings in the center of the city, included ex-of Old City. The magnitude of the damages caused to the war of Szczecin was one of more than 20 cities devastated in the contemporary Germany.

(Pictures: Destroyed Szczecin) (Source information.: www.pictures.polandforall.com)





2.5 Geography of Szczecin

Szczecin is to the northwest of Poland, and is one of the cities of more importance of the country. The city is located close to big water extensions. The Baltic Sea is one hour in car, the Lagoon of Szczecin, part of the Baltic Sea and practically separated from the sea opened by a series of islets, is located moreover close to the city. Also, the part East of Szczecin is washed by the lake Dabie. Szczecin is in the delta of the river Odra whose tributaries happen for the city. The German border is very close to Szczecin; Berlin is only to 120 km.

The frontier steps more surround us they are those of Kolbaskowo, Rosówek and Lubieszyn. Many people say that Szczecin is “a green city”, but this name should not limit itself only to the city, but also to his very attractive surroundings, especially to three forests of the neighborhood: The Forest of The Hague (Puszcza Bukowa) with his Lake of Emerald, the Forest of Wkrzanska and the Forest Goleniowska. The lake Dabie, one of the biggest lakes of Poland constituting a center of very interesting recreation.

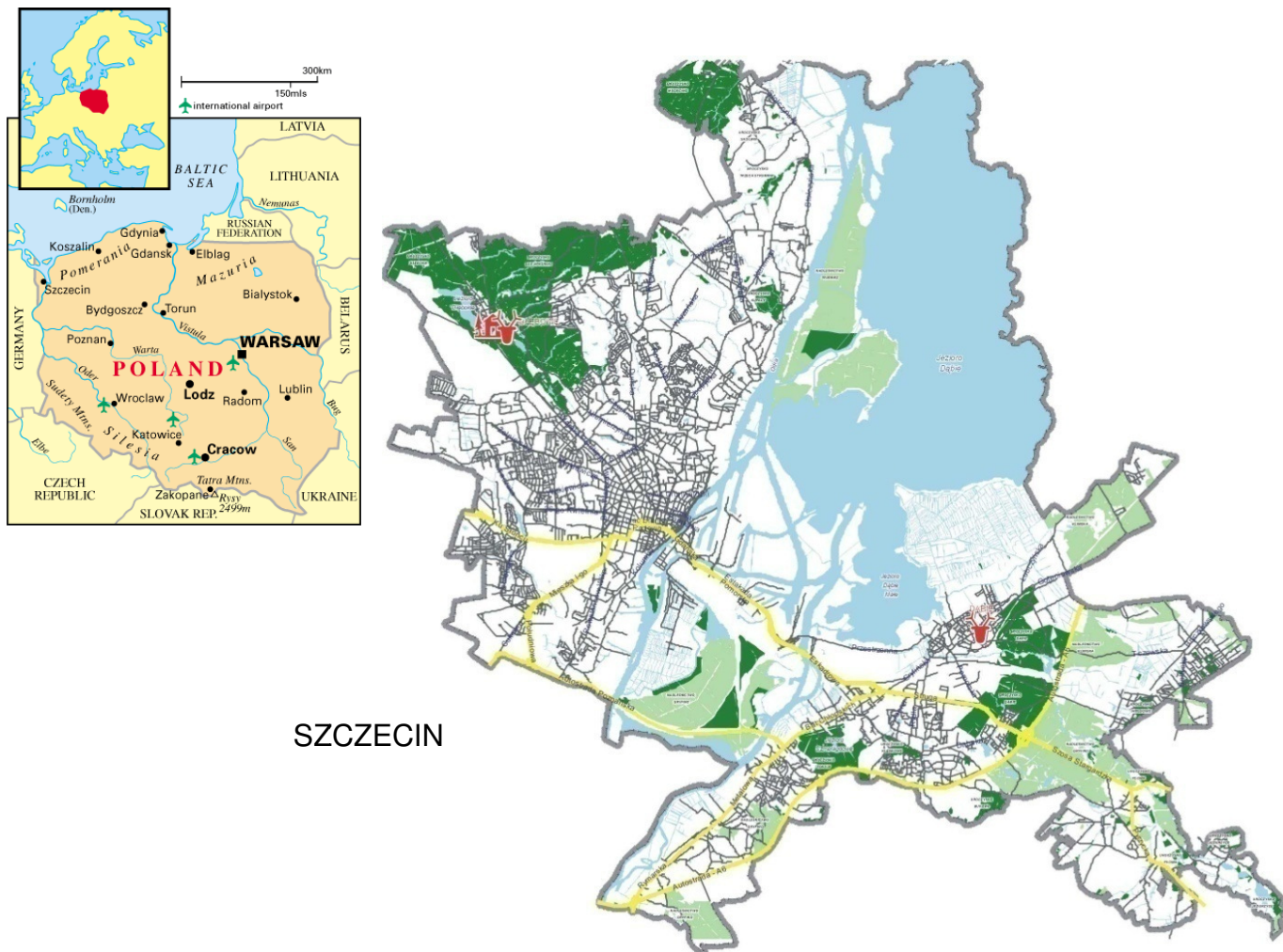

SZCZECIN

(Pictures: Destroyed Szczecin) (Source information: www.cityhall/szczecin.com)

2.6 Economy Szczecin.

The Szczecin economy in Poland prospers largely in the commercial and commercial activities, and the products of the manufacture are exported to the foreign nations with the port region. This alternatively, it brings in enough foreign coins in the ground, doing financially increasingly the sound, stable and prosperous to him. A good number of companies is glad of the factory of the drug of Cefarm, Polish company of steam ship, the brewery of Drobimex and of Bosman has his headquarters and units of the manufacture in Szczecin.

The Szczecin port is a Polish marine port and of deep waters of the port of Szczecin, Poland, placed in Rio Oder and ReGallic I laugh in the Low Vale of the Rio Oder, close to the Lagoon of Szczecin. The port is provided with port of Free zones and the shipyards. In 2006, the load traffic in the port was equalled 9.965.000 tons, and compound for 16,5 % of all the traffic of load in the ports of Poland. The port of Szczecin and the Port of Świnoujście they are administered by an authority. Both ports it creates one of the biggest port complexes in the Baltic Sea.

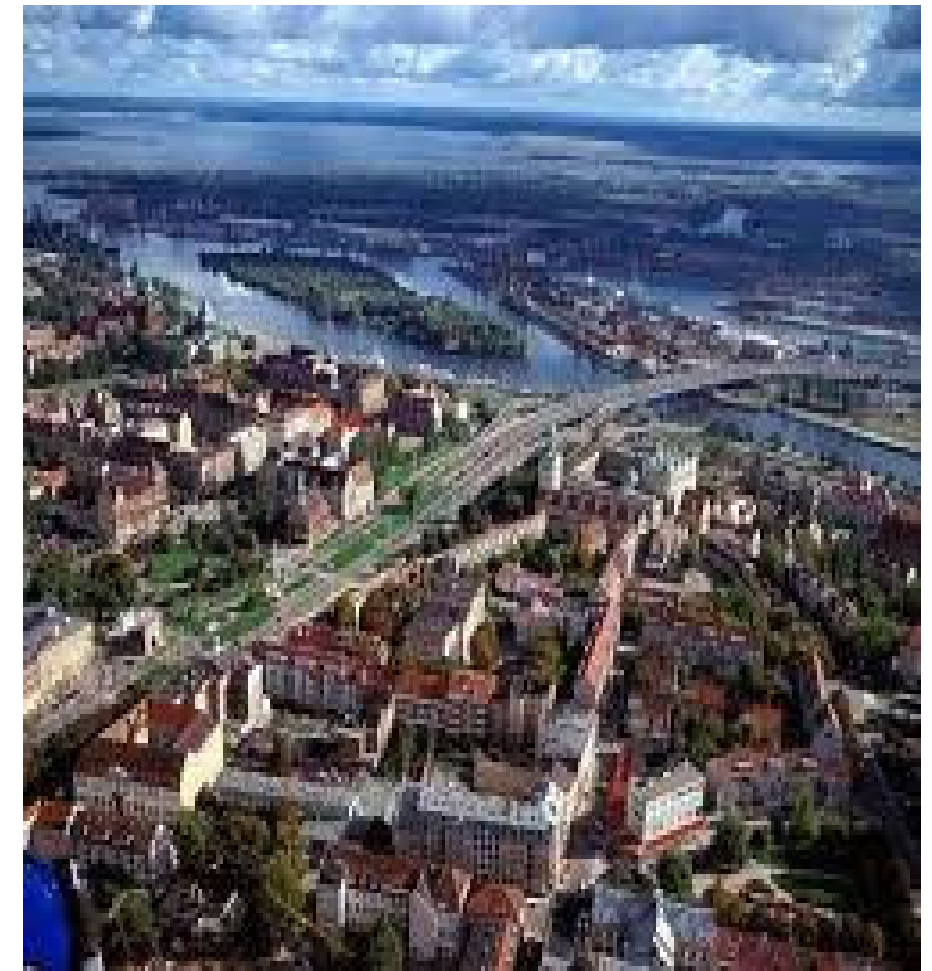

(Pictures: Destroyed Szczecin) (Source information: www.wszczecinie.pl)



2.7 Historical context of the buildings to be treated. Modernism.

The Polish architecture of the first decades of the XXth century, previous to 1939, is supported inside the general keynote of the European architecture of the epoch. The divorce took place in order to the Second World War and the fall of the Soviet country in the field of influences. The renewal of the Polish architecture could only be carried out thanks to the democratic transformations after 1989.

Real and prefabricated socialism

The predominant feature of the architecture of the countries of the Soviet block of the forties and fifties was the "socialistic realism", obligatory in all the domains of the art. The socialistic realism was trying to impose "national forms" and "socialistic contents", although it would be very difficult to tell of what there might consist these "socialistic contents" applied to the architecture. This tendency lasted in Poland only some years and left, in spite of everything, some interesting works, which were continuing in certain way the formal searches of the Polish architecture of the thirties. The most monumental works were doing clear reference to the classic tradition, from here the colonnades and the axial dispositions. In the decoration one was resorting to the baroque *diociesco* and to the modernism of beginning of this century.



The work most known about this period and simultaneously very little typical of the socialistic realism in Poland, is the Palace of the Culture and the Science, enormous building erected in full center of Warsaw. In spite of certain decorative elements of Renaissance origin with clear reference to the Polish tradition, the building is practically a copy of other similar buildings constructed in the same years in Moscow by order of Stalin. The author of the project was the Soviet architect Lev Rudniév. In this epoch the Polish architects were occupied mostly in the reconstruction of the historical centers of Warsaw, Gdansk and Wroclaw, limited to debris during the war. (Pictures: *Palace of the culture and the science, Warszawa*). (Source information: www.flirks.com)

The socialistic realism disappeared in Poland together with the Stalinism, in 1956. The architectural projects of the fifties and sixties admire for his innovative spirit. Regrettably, the low quality of the construction and the nature itself of the socialistic economy were an insuperable obstacle for the development of a truly interesting architecture. Of that epoch, seventies, there come projects of residential urban developments of enormous proportions, constructed with prefabricated elements, badly executed and worse finished. With the eighties there came the big economic crisis that marked the last years of the communism and that paralyzed also the construction.

The big change.

The year 1989 brought radical political and economic transformations that were reflected also in the architecture. In the Polish architecture of last decade three stages can differ.

In the first period slightly interesting projects of previous years kept on being realized, applying quite primitive technologies. At the same time the first works began to appear "of import", designed by slightly well-known western architects, the this way called "parachutists". State buildings arose then very few, while in the commercial architecture the most important target was the low cost and the rapid benefit, minor attention being paid to the quality and to the artistic value. Later there were appearing more and more companies that were tackling the construction of ambitious buildings. The projects were entrusting more well-known architects, often for contest. On the market of the construction new architects studies appeared well prepared to be employed at a market economy.

At the end of the nineties they did his appearance the first big companies property development companies, for which the commercial success was already implying a good location, an attractive architecture and a good quality of the works. Some projects were entrusted to famous architects. As example the project can serve IT OPERATES in the Square of the Saxon ones, Norman Foster acts Sir's. The design of the PORT OF PRAGUE, also in Warsaw, was entrusted to Ricardo Bofil

During last decade there have been accentuated the differences of style between the different architectural means of Poland. Warsaw is a center eminently cosmopolitan and his construction is becoming more and more chaotic. The most interesting regional centers are, undoubtedly, Krakow, the Tall Silesia and Wroclaw. In the historical Krakow the avant-garde architects return the roots of the modernism (DDJM, Romuald Loeger, Wojciech Obtulowicz). In the Tall Silesia the architects are still faithful to the industrial image of the region, with bold forms of steel and surfaces of brick lightly nostalgic (Andrzej Duda, Henryk Zubel, Malgorzata Pilinkiewicz, Tomasz Studniarek).



Public buildings.



One of the most interesting architectural achievements in Poland of last decade is the UNIVERSITY BIBLIOTECA OF WARSAW. The contest, organized in 1993, was gained by a group of architects directed by Marek Budzynski i Zbigniew Badowski. It is a low, but extremely spacious construction, where there interlace the concrete and the botanical garden of the roof, destined to lodge two millions in volume and

several reading rooms. Along with the Library there are two office buildings designed by Andrzej Kicinski. An old industrial building that existed in the place also was transformed into offices, while the courtyard has been excavated below the area level to lodge a garden that can be admired from a bridge of steel and wood stretched on the same one.

(Picture: Library, Warsaw. Source information: www.polandimagens.pl).



From the architectural, most interesting point of view of the state buildings in Poland raised at the beginning of the nineties it is, unquestionably, the CENTER OF ART AND SKILL OF THE JAPAN "MANGGHA" in Krakow (the design is of Arata Isozaki and Associates Tokyo and Ingarden-Ewa and Jet Atelier Krakow), work due to an initiative of the well-known film director, Andrzej Wajda. The building is placed

opposite to the Castle of Wawel and his architecture offers marked associations with the Japan, offering an interesting accent of the scenery when it looks from the hill of the castle. The spacious interiors join traditional materials with the most modern technologies

(Picture about the center of art and skill of the Japan, Krakow. Source information: www.polandimagens.pl)



Another peculiarity of last decade is the quantity of new town halls and municipal buildings, symbol of a new democracy of base and of the increasing importance of the local authorities. Between the new town halls one of the most interesting is perhaps that of VARSOVIA-BIALOLEKA (I design: Grzegorz Stiasny, Jakub Waclawek and collaborators). The project shows marked similarities with the Town hall of Hilversum, erected in 1931 by the renowned Dutch architect Willem Dudok and with the Town hall of Janow, close to Katowice, projected in 1931 by Tadeusz Michejda. These similarities might say something on the functionalism of the municipal architecture of the twenties.

(Picture: town hall Warsaw. Source information: www.polandimagens.pl)

Comercial arquitechure.

From 1990 the Polish real estate market was opened to the foreign investors. At first the most profitable investments were the office blocks and the hotels de luxe, then the shift came to them to the big commercial surfaces. Most of the investments were arising at first in Warsaw. The most active investors were therefore the international construction firms established in Poland, especially Skanska, of Sweden and ILBAU of Austria.

There were the first companies property development companies that made use of his experience in the sector and took charge of the totality of every project (acquisition of the area, project, financing and commercialization). This way there arose in Poland the first commercial buildings that they were answering to international standards of equipment and functionality.

(Picture: Hotel Radisson, Szczecin. Source information: www.polandimagens.pl).



It is a question of the best example of architectural postmodernism that it is possible to contemplate in Warsaw.



Bancs.

While the big office blocks were arising principally in Warsaw, practically in all the cities of Poland banks head offices were appearing throughout the decade. In general, much better finished than the offices and also with a more complex functional disposition. There is excellent the architecture of the BANK HANDLOWY S.A. OF KATOWICE, work of the architects Kapucik and Lekawa. The building, which is surrounded with monstrous blocks of flats of the seventies, gives the impression of an enormous abstract structure in an a little surprising place. The first commercial category building A in Cracowia, of excellent architecture and finished, is also a property of the BANK HANDLOWY S.A. and he answers to a quite traditional architectural conception. The project belongs to the Architects' Society DDJM, integrated by the architects Marek Dunikowski, Artur Jasinski, Jaroslaw Kutnowski, Wojciech Miecznikowski and Piotr Uherek. The front of the project develops a scheme of traditional composition of socket, average plane and cornice expressed in a modern architectural language.

Comercial areas.

At the beginning of the nineties numerous shopping centers were constructed also. The achievement most emphasized from that period was the ADAPTATION OF THE BIG MILL OF GDANSK for shopping center, with big shops quantity concerning a central atrium. This enormous Gothic bricks construction, of about the year 1350 was counted between the biggest buildings of the Medieval Europe. The basic target of the restoration was to reveal the historical values of the building. The architect Elzbieta Ratajczyk-Piatkowska and the engineer Jerzy Sieminski chose for a radical solution. The walls of the monument were left intact, while inside there was constructed a structure of steel that does not rest on any point of the historical building. Between the new shopping centers the one that he emphasizes architectonically is the SOLPOL, OF WROCLAW, work of Wojciech Jarzabek (collaborators: Pawel Jaszczuk, Jan Matkowski, Jacek Sroczynski). The building causes controversies, especially for his form and colors, of clear postmodernist references.

Hotels.

The most important architectural event in the years 1994-1995 was the HOTEL SHERATON OF WARSAW, a project of Tadeusz Sychala and Piotr Szaroszyk. Although in this construction they played a very important role the economic aspects, and the front was not finished by lasting materials, the architects managed, in spite of it, to design a work well adapted to the environment which value is heightened moreover at night thanks to an ingenious lighting.



The architectural value of the HOTEL PANORAMA OF SZCZECIN, it owes to his picturesque location and to his original technology of wood, all this very carefully designed and with an excellent spatial distribution (I plan: Studio Ar, architect Stanialaw Kondarewicz. (Pictures: Hotel Panorama, Szczecin. Source information: www.polandimagens.pl)

Decorations.

At the end of the nineties there began to spread the habit of decorating both the state buildings and the commercial architecture with works of art entrusted to recognized artists. The front of the ACADEMIC LIBRARY OF WARSAW exhibits five symbolic books of bronze that represent the wealth of texts and the universal dimension of the funds of the library. In the fronts of the STOCK EXCHANGE OF WARSAW we see panels of aluminum that symbolize graphs of the quotations. Very rich in symbolism is the FRONT OF THE SUPREME COURT OF WARSAW in whose columns exhibit the most important appointments of the civil law. The artistic compositions are more and more frequent even in decisively utilitarian buildings.

Quarters bedroom.

While in the middle of the decade of the ninety the blocks of flats kept on being constructed mostly by cooperatives, at the end of the decade they emphasized for his presence on the market the big construction firms and property development companies. In the architecture of the housing modernism notices a draft towards the neo. There are more and more numerous the houses inspired by the style of avant-garde of the twenties and by the style of the luxurious buildings of the thirties. The buildings neo modernist with arcades, long lines of windows and roofs instead of straight roofs mark a comeback to old traditions. There are works decidamente original, where the history is an only one pretext to create something new, but the most frequent thing is to find compilations of old motives which result is a banal architecture that little has to do with the original model. In Warsaw there differs the study of Szymborski i Zielonka and the group JEMS.



One of the most interesting works of Wojciech Szymborski and Jacek Zielonka is the BUILDING OF APARTMENTS OF PAX in Warsaw. A decisively modern project, but with many references to the architectural avant-garde of the twenties and thirties. The architects have received instructively the proportions of the front, the building seems to sail along the urban space like a transatlantic one, to which really it looks alike thanks to his patios in the shape of bridges, to his footbridges and eyes of ox. In spite of a certain presence of decoration, the authors have supported a sober expression of the set.

Also in other cities of Poland and in other projects it is easy to see a certain fascination for the modernism. There differ especially the achievements and projects of the architects of Krakow Romuald Roegler and Wojciech Obtulowicz to whom an interesting project of residential urban development owes in the quarter of WOLA JUSTOWSKA. The houses of modernist fronts are surrounded with an enormous scaffolding of pergolas over which the vegetation has to climb. This vegetable wall constitutes an encirclement during the summer and an additional front of the constructions.

A new phenomenon in the residential architecture of Poland there are the urban developments and buildings constructed by the big companies property development companies. It is a question of a commercial architecture of good quality, entrusted the most well-known architectural studies.

The quality of the finished not desmerce in nothing to the most expensive projects of any country of the world.

The reconstruction.



During the last decade there was continued the reconstruction of the urban sets destroyed during the Second World War. In the eighties there began the reconstruction of the historical quarters of Elblag i Kolobrzeg (Pomerania). In the nineties it began also the reconstruction of the medieval quarters of Szczecin i Glogów. At present there is prepared the reconstitution of the Old City of Kwidzyn.

(Pictures quarter Szczecin. Source information: www.polandimagens.pl)

The reconstruction of every historical urban set is different in each of the cases. The most valuable buildings have to be reconstructed in possible exact reproductions of the original building, taking advantage for it the original planes in few cases in which they exist, or resorting to the ancient photos and paintings. Most of the buildings have been projected by Szczepan Baum and Ryszard Semko. In the reconstruction of the historical quarter of Szczecin the architects have major freedom, since for different motives the faithful reconstruction is impossible. All the works are executed by proper means of the cooperative that is a co-owner of the area. Each of the buildings is put on sale on having finished the construction. Every building is projected by a different architect.

In other cities there are reconstructed parts of historical sets or separated buildings. The architectural evolution not always supports the step of the new technologies. It is not possible to speak about the Polish architecture without bearing in mind the enormous political and economic changes of the country during last two decades.

“ In the eighties the market of the construction remained practically paralyzed by the crisis. The architects had scarce possibilities of seeing his realized projects. The situation changed in the year 1989, giving to the architects a big opportunity”

The Polish architecture of the nineties keeps on being, largely, a provincial architecture, but necessary it is to admit that in the last years truly interesting and original projects have begun to arise. Probably a very positive phenomenon is the appearance in Poland of recognized international architects. Thanks to them it is of hoping that in the next decade the Polish architecture should acquire the art category.



3. URBAN SZCZECIN'S ANALYSIS

3.1 General analysis of the city

Szczecin consists of a population of approximately 420,000 inhabitants. The metropolitan population of the area belongs to 650,000 inhabitants. Enjoy a strategic position to meet between Poland and Germany, and of a situation that it enables him having multiple commercial links with the European Union. His connections for road, railway workers and maritime they have made of Szczecin the bigger seaport of Poland, being shipyards join of your more important industries.

The city was destroyed after second worldwide war, being not much of a the vestiges that fitted of previous epoches. It was reconstructed according to Georges Eugène Haussmann's design in 1880, who had redesigned Paris under Napoleón III's empire. Szczecin's urban planning is unusual. The city has an abundance of green spaces, with parks, roundabouts and broad avenues with trees planted downtown, separating the opposed traffic, space that is made good use of for the circulation of the trams. After the war, they reconstructed the buildings with Gothic and renaissance character, attempting to reflect like thrashing floor the city before the conflicts. Buildings are by majority of 3 plants with attic. The height of cornice is for what's general one belonging to 15 m, while the total height hovers around the 18'5 m.

The recent transformations have developed along of over 15 years, as the city has faced the typical urbane problems of some obsolete infrastructures and the loss of the industries. The strategic issues key for Szczecin music: His Baltic relations, his frontier situation and his vibrating relations with Berlin, the big transporting infrastructures including the port and the regional airport, the urban renewal and the regeneration of the urbane surroundings at deteriorated neighborhoods, including the maritime fronts and the downtown, water's environmental resources and the forests, as well as the fast housing development of the nearby towns.

3.2 Analysis for districts

Szczecin's city is divided administratively at four districts: Śródmieście, Północ, Zachód y Prawobrzeże; That in turn they subdivide themselves at neighborhoods. Each district enjoys an administrative organ with autonomy of Government on its zone, always headed by the local organ. In turn, the neighborhoods consist of some administrative organs that have an auxiliary show on each district's address.

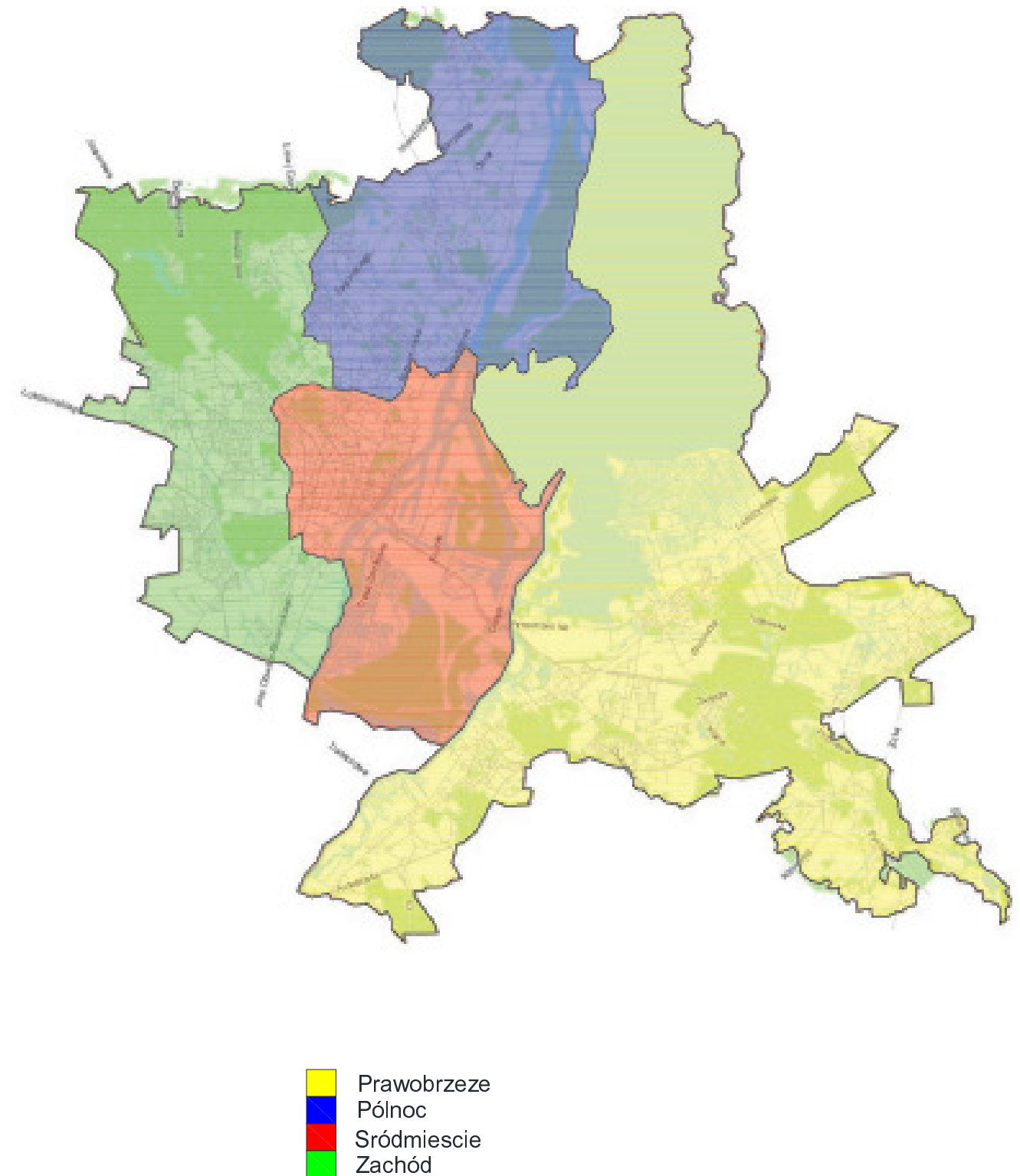

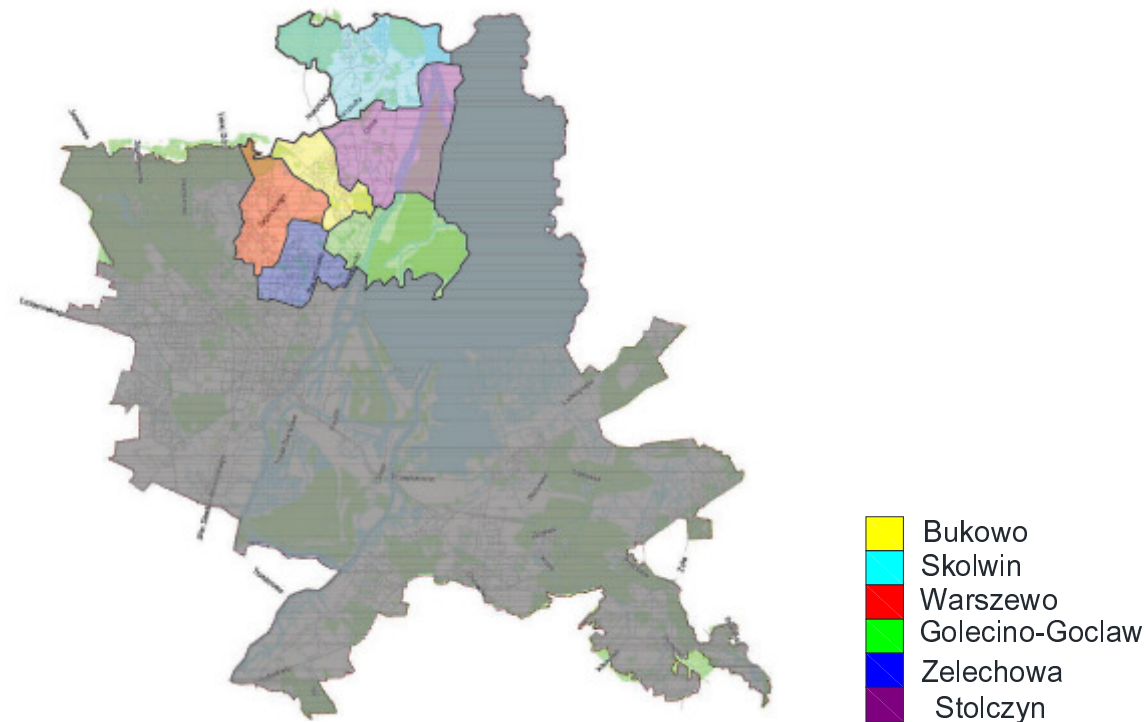

PÓŁNOC

This district extends throughout the city's north zone, and it is subdivided at the following neighborhoods: Bukowo, Golęcino-Gocław, Niebuszewo, Skolwin, Stolzyn, Warszewo, Zelechowa.

The **predominant use** at the outermost neighborhoods of the river bed is the **residential**, since it has to do with a fringe area of the city. At the close neighborhoods to the river, the zones of industrial use collect a great importance, since to his sides exist important factories and companies, and one of the more important seaports of Poland, motor of the economy of this zone.

The most seen **constructive typology** at the residential areas, is **isolated houses** and **houses placed near**, although also they observe cases of blocks isolated of houses at the closer zones to the downtown. The **average of age** of the buildings of this zone, it oscillates between the 10 and the 20 years, and the majority presents a good condition of conservation. This district shows a large number of greenbelts. The factories and the works of port infrastructure predominate at the **industrial zones**.

Like **accesses** at this neighborhood, there are connections of railroad with northern and with the downtown, and there are maritime connections with the Baltic, to long of the riverbed Odra. As to the **transporting infrastructures**, there are several lines of bus that connect the district with the rest of the city, but the tram line circulates only for the seashore.

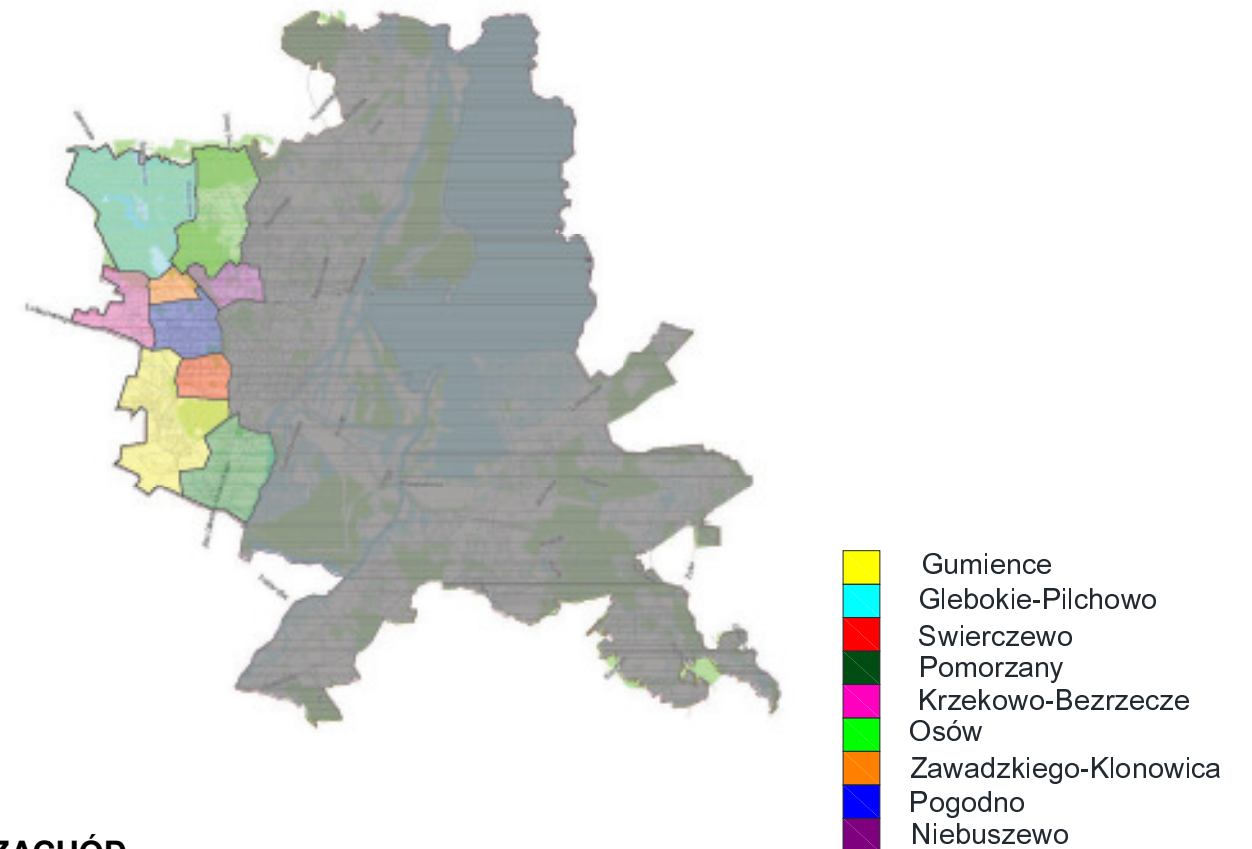

ZACHÓD

This district extends throughout the zone west and northwest of the city. The several neighborhoods that we found are the following: Głębokie-Pilchowo, Gumieńce, Krzekowo-Bezrzecze, Arkońskie-Niemierzyn, Osów, Pogodno, Pomorzany, Świerczewo, Zawadzkiego-Klonowica.

Is a fringe area of marked **residential** character and with great quantity of **green zones**, formed for a large number of housing developments that spread over all of the zone.

The **houses isolated and placed near** are the constructive prevailing typologies at this district, although at Pogodno's and wierczewo's neighborhoods there are a large number of blocks isolated of houses. The **age** of the edifications at this zone seems to oscillate between the 10 and the 20 years, and they seem to have a good condition of conservation, because apparently we do not observe pathologies.

Exists an ample net of buses that go over all of the zone, and also a line of railroad that surrounds the downtown and serves as frontier between Śródmieście's and Zachód's neighborhoods.

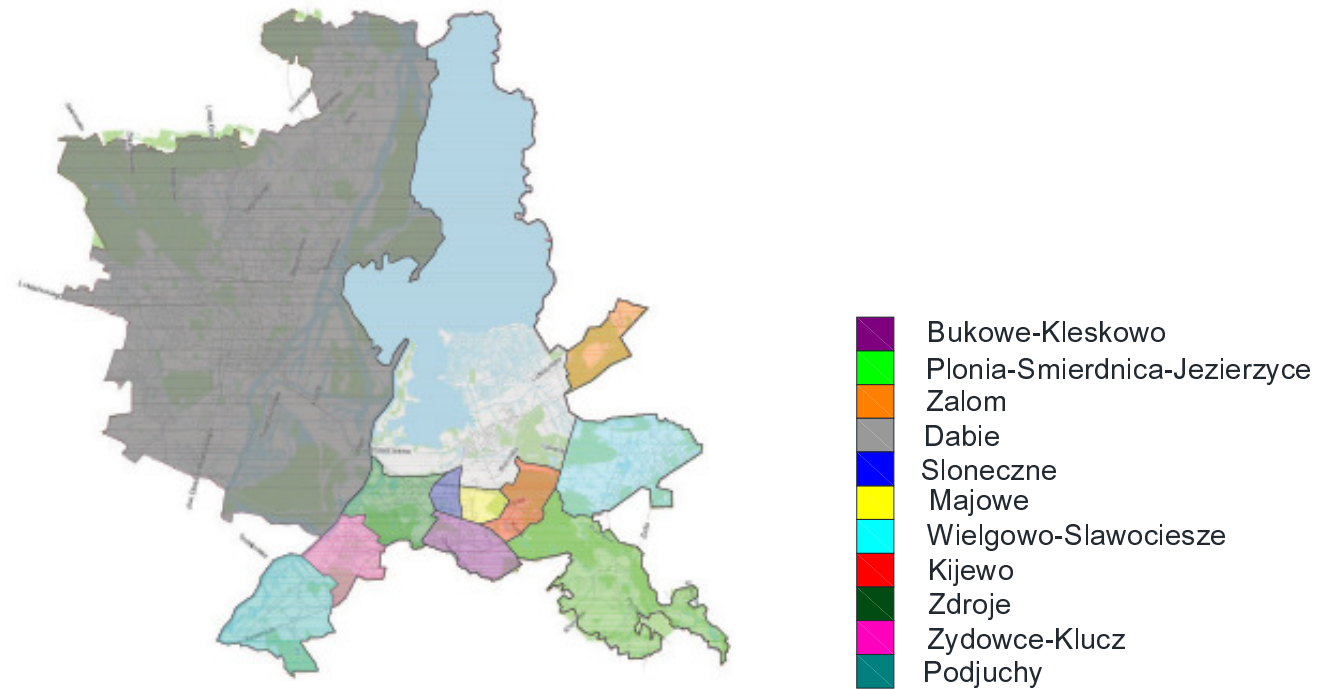

PRAWOBRZEŻE

This district extends throughout the city's territory that is in the right part of the Odra's river. It is composed of the following neighborhoods: Bukowe-Kłęskowo, Dąbie, Majowe-Kijewo, Płonia-Śmierdnica-Jezierzyce, Podjuchy, os. Słoneczne, Wielgowo-Sławocieszce, Załom, Zdroje, Żydowce-Klucz.

This is the biggest district of the city, principally because comprises the Dąbie's lake. This gives a **maritime character** to the zone. There are several marinas and numerous zones of camping and recreative zones by the side of the lake. The close zones to the lake are of residential use. The existent constructions are **houses isolated** of second use, in the main. There are certain places of residential nuclei formed by **big blocks isolated of houses**, separated by parks and greenbelts a little more to the inside. Close to these zones there are a shopping center and several supermarkets. There are little urban nuclei of rural character with the limited services in the city's border areas.

At this district exists a net of buses that communicate the several neighborhoods, although it is not so wide as the rest of the city. Also there are lines of railroad that go by this district and that communicate it with the downtown, the most central zones of Poland, and the Baltic seashores. There aren't tram's lines at this zone.

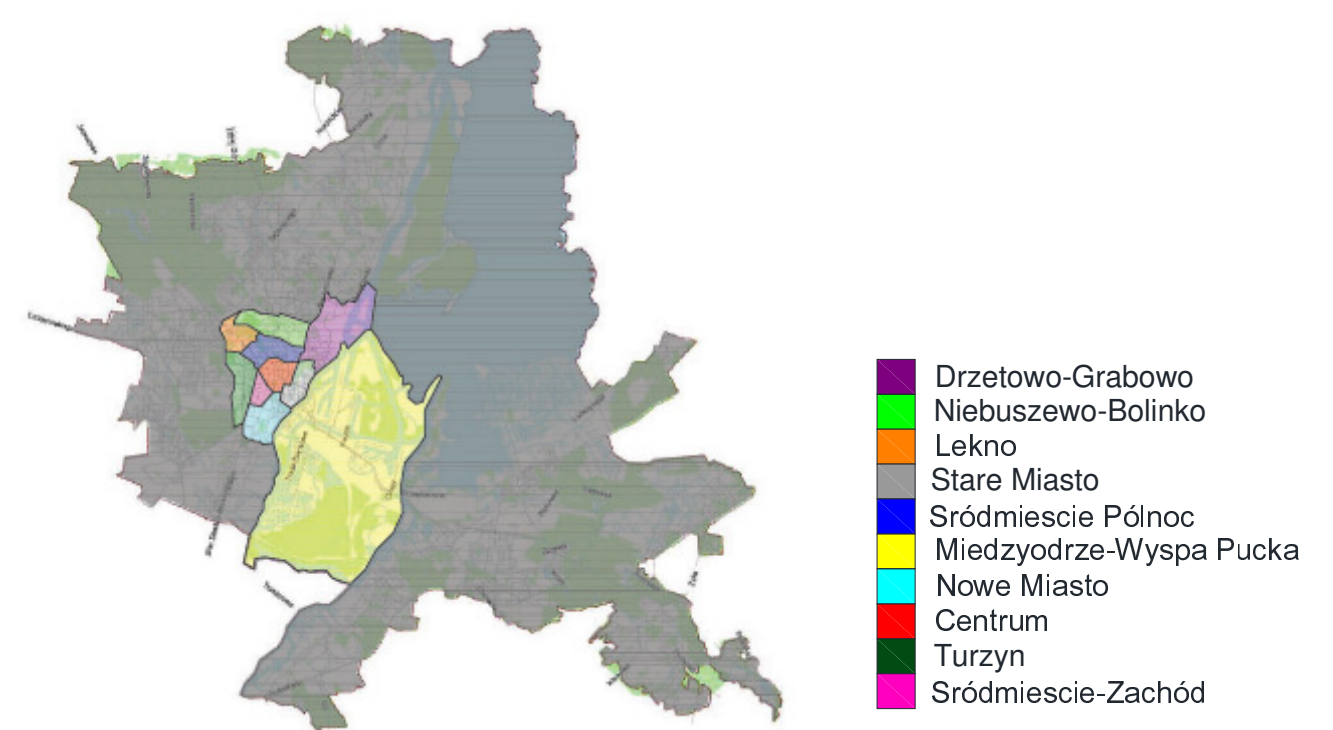

ŚRÓDMIEŚCIE

This district comprise the downtown zone and consists of the following neighborhoods: Centrum, Drzetowo-Grabowo, Łekno, Międzyodrze-Wyspa Pucka, Niebuszewo-Bolinko, Nowe Miasto, Stare Miasto, Śródmieście Północ, Śródmieście-Zachód, Turzyn.

It is the **most developed** district of Szczecin, where there are most of public, cultural and commercial buildings. The **urban planning** of this area is squared, with wide avenues that present areas of woodland that divide two senses of the roadway. This space is made use for circulation of the trams and like walk areas for persons. The width of the sidewalks is considerable, and certain avenues present areas landscaped in front of the facades. In this district there exists a big number of parks and green spaces interspersed by the whole territory.

The buildings are usually of 3 plants with garret and semicellar, and present an average height of 15 m cornice. most of them were constructed or reformed after the war. To today, half of the buildings that are observed in the streets presents the **bad conservation** state, especially of his facades.

This district presents a wide network of buses and trams that communicate all the neighborhoods. Along with the river there is the railroad base station of Szczecin, who communicates with the areas of the Baltic one, Berlin and the rest of Poland.



3.3 Principal accesses of the city



Railroads lines

In this plain there are indicated the railroad lines that cross the area of the city of Szczecin. The lines of the **north** communicate with the cities of the north like Police, and with the industrial areas of the area. The lines of the **west** connect with the German cities, especially with his capital, Berlin While the lines of the **east** communicate with the rest of Polish cities.



Highways and main streets

In this plain are indicated the principal accesses by highway. To the **north** with Police and the coast, on the **west** with Berlin and to the **southeast** with the rest of Poland. It is necessary to emphasize the step of the **freeway A-6**.

Also the principal arteries of the city are indicated.



Public transport network

In this plane there is indicated the network of public transport of the city.

Buses network: **blue**

Trams network: **red**



3.4 Green spaces and universities

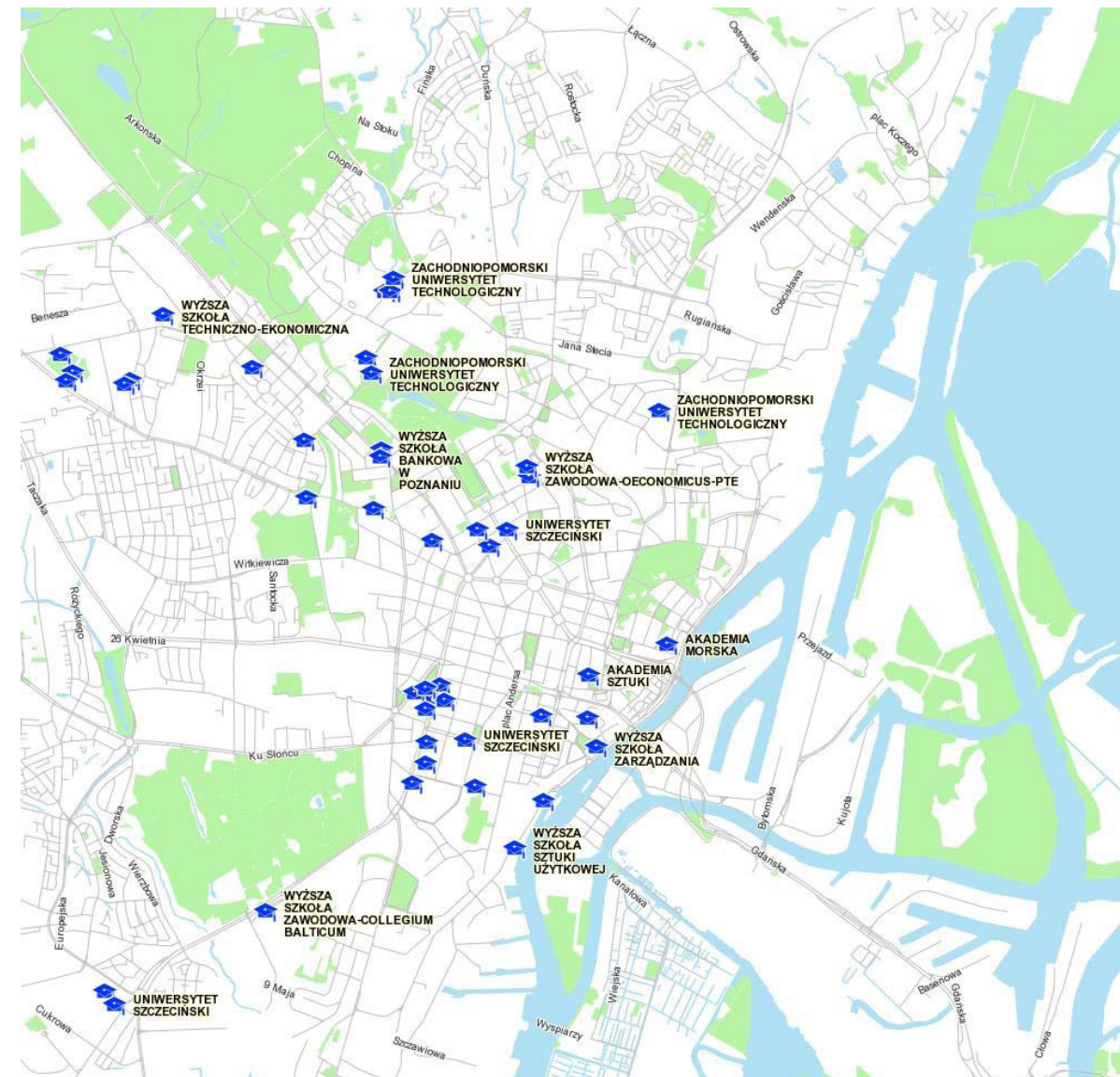
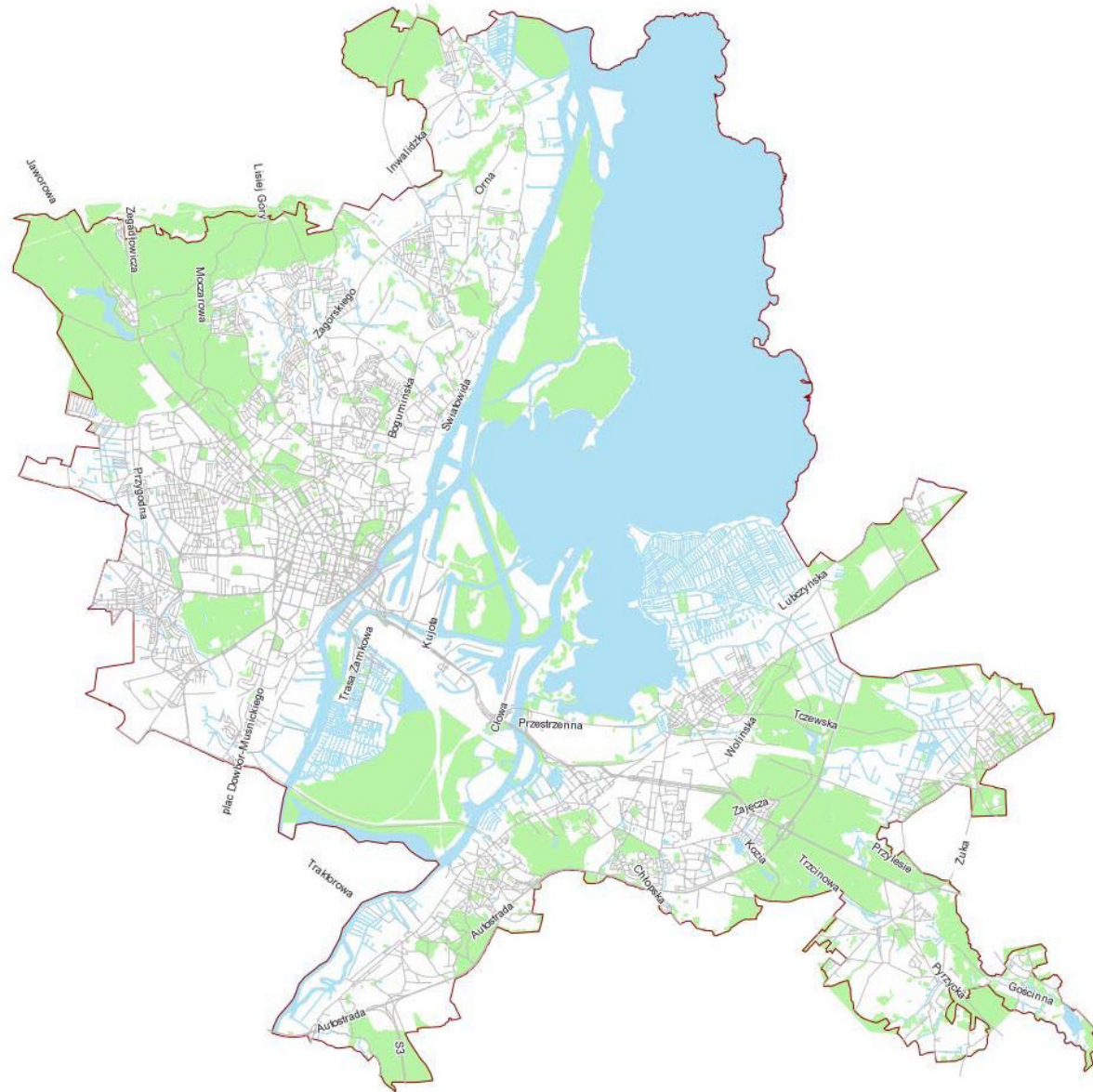

(Map of Szczecin. Source information: www.gis.um.szczecin.pl)



3.5 Urban planning

DEVELOPMENT URBAN PLANS IN SZCZECIN

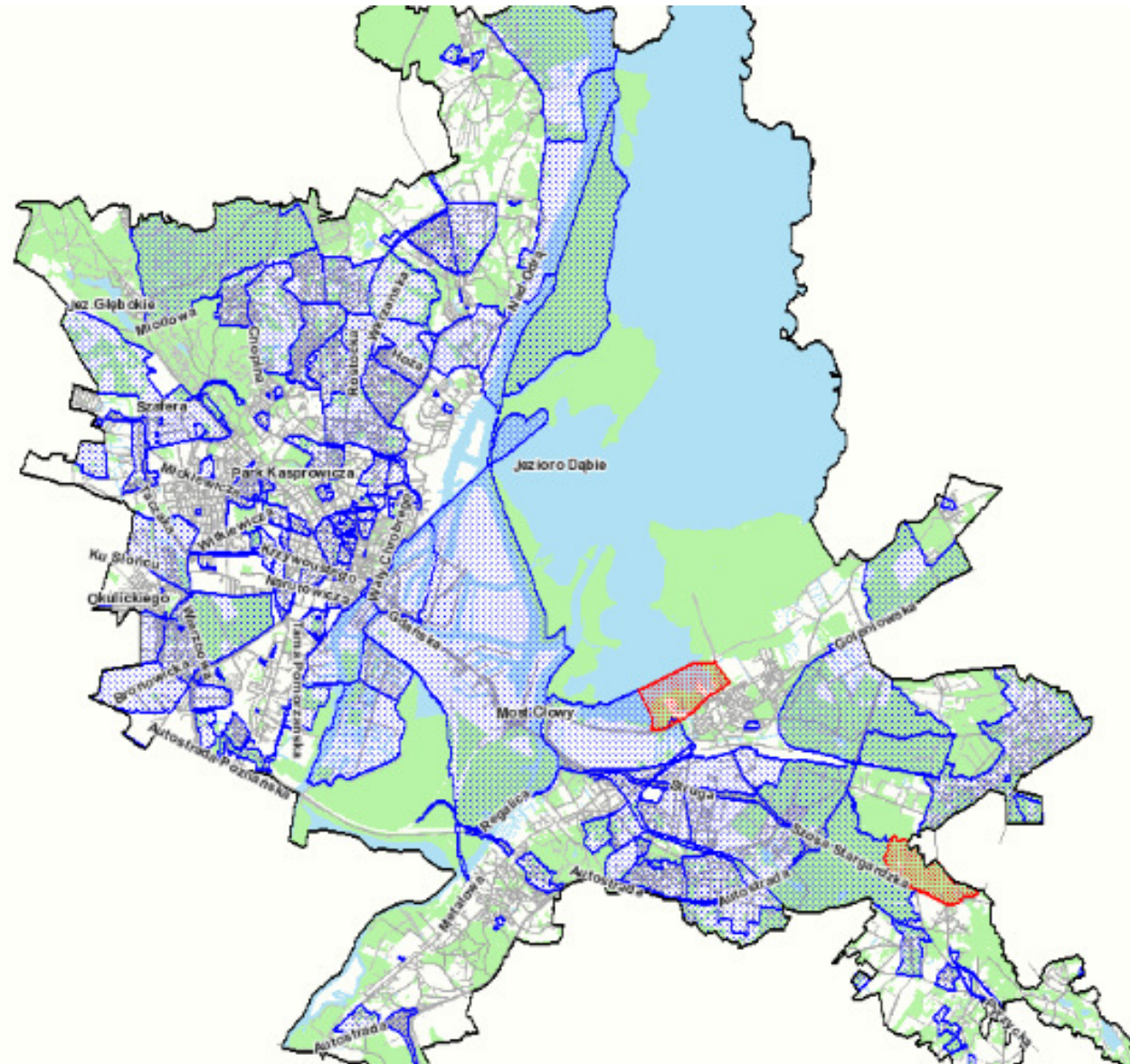

(Map of Szczecin. Source information: www.gis.um.szczecin.pl)

Every area delimited in this plane has its own urban development plan. In whole 72 plans exist. In the areas that do not remain delimited by any plan it is operated of the following way. The builder communicates to the town planning department the intention of constructing in the area in question. On not having belonged to any development plan, the department will do a study of the area and his outline, and will prepare a report with the conditions that must fulfill the requested construction.

HISTORIC NUCLEUS ZONE

During the second world war, the city of Szczecin was considered as a port city of big importance, considering the proximity of this one with Berlin. It was for it that during the war also it was a city much destroyed by the bombings. Test of it is that more than 90 % of the buildings of Szczecin remained completely destroyed after the war. On having concluded this one, the city was re-designed completely. It is for all this, therefore no historical nucleus exists in Szczecin.

ENLARGEMENT ZONE



In this area we find a urban variable of residential type of closed apple. This typology is the most predominant in the central area of the city, as we can observe in the plan of urban arrangement enclosure. The buildings are in general of 4 plants high more garret and they present a homogeneous total height that ranges between height of 18 and 20 meters.

OPEN BUILDING ZONE

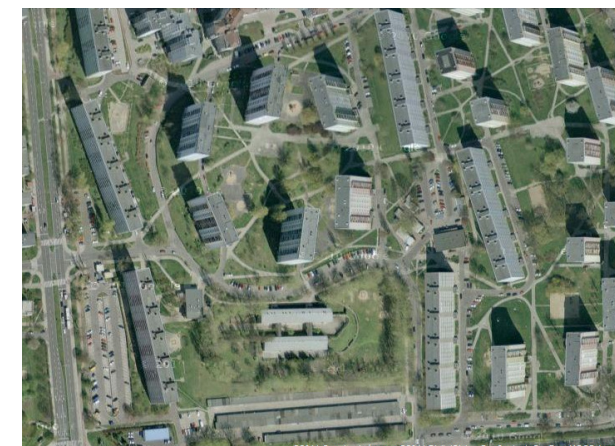

We find this type of building in more peripheral areas of the city. It presents a urban variable of the multiple residential type of exempt blocks.



ISOLATED HOUSES ZONE



It belongs to the urban variable of residential unitarily of exempt blocks. As we observe in the general plan, this type of area is located in the periphery of the city, and the small downtowns that surrounds Szczecin. In general there are buildings of 2 plants high more garret, with an total height that ranges between the 10 and 12 meters.

ATACHED HOUSES ZONE



This area presents the urban variable of residential unitarily of attached blocks. As the area of isolated housings, we find this type of area in the periphery of the city, where the residential use is predominant. The houses usually have two heights more garret and the total height ranges between the 10 and 12 meters.

INDUSTRIAL AREAS

We find this type of areas on on the banks of the river Odra, where there is most of the industry of Szczecin.

COMPACT APPLE



EXEMPT BLOCK



(Pictures of Szczecin: Google earth and www.gis.um.szczecin.pl)



GENERAL PLAN OF SZCZECIN (Map of Szczecin: www.gis.um.szczecin.pl)

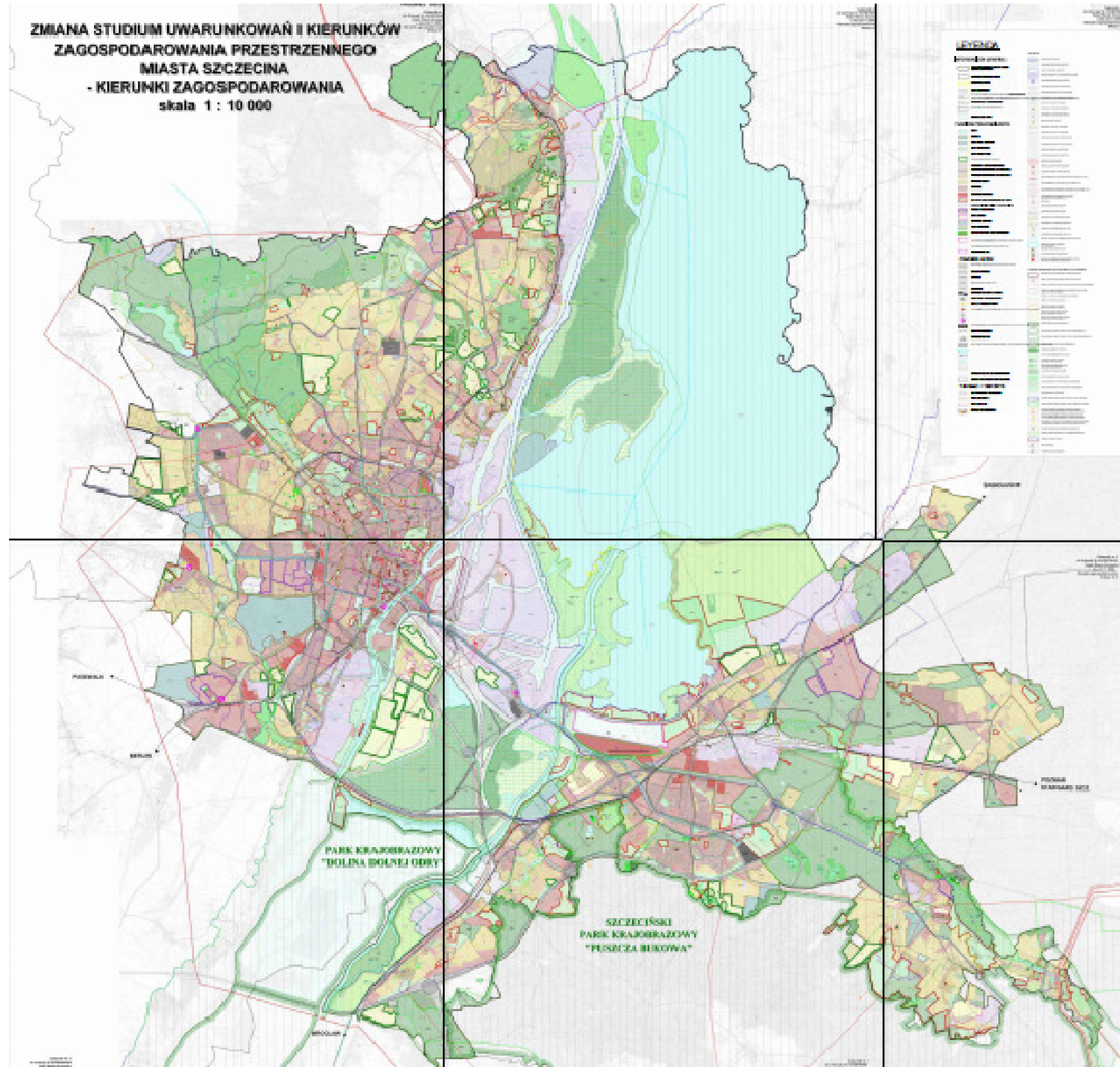



3.5 Analysis of Turzyn

General description:

The **predominant use** in this area is the residential one, while the **constructive typology** that more appears is a closed apple, with blocks of multifamiliar's flats.

Most of the housings of the area present the following **structure**: a semicellar, 4 plants of housings and a garret. The total height of the housings is about them 18'5 m, while the height under cornice is about 15 m.

The **age** of the constructions of this neighborhood ranges between 80 years, and in general they presents the bad **conservation state**. Although it is necessary to emphasize the rehabilitation of several buildings in the street Boleslawa Smialego.

The equipments in this area are the following ones:

- There is a school to 50 m, in the street Boleslawa Smialego.
- There are a group of universities to 500m, in the avenue Piastów.
- There is a shopping center of big dimensions to 600m, in the street Bohaterów.
- there is a medical center to 350 m, in the beginning of the street Boleslawa Smialego.
- There is a theater to 200m, in the street 5 Lipca.



Legend

Residential

Public buildings

Comercial buildings

Office buildings

Health centers

3.6 Historical evolution of Turzyn

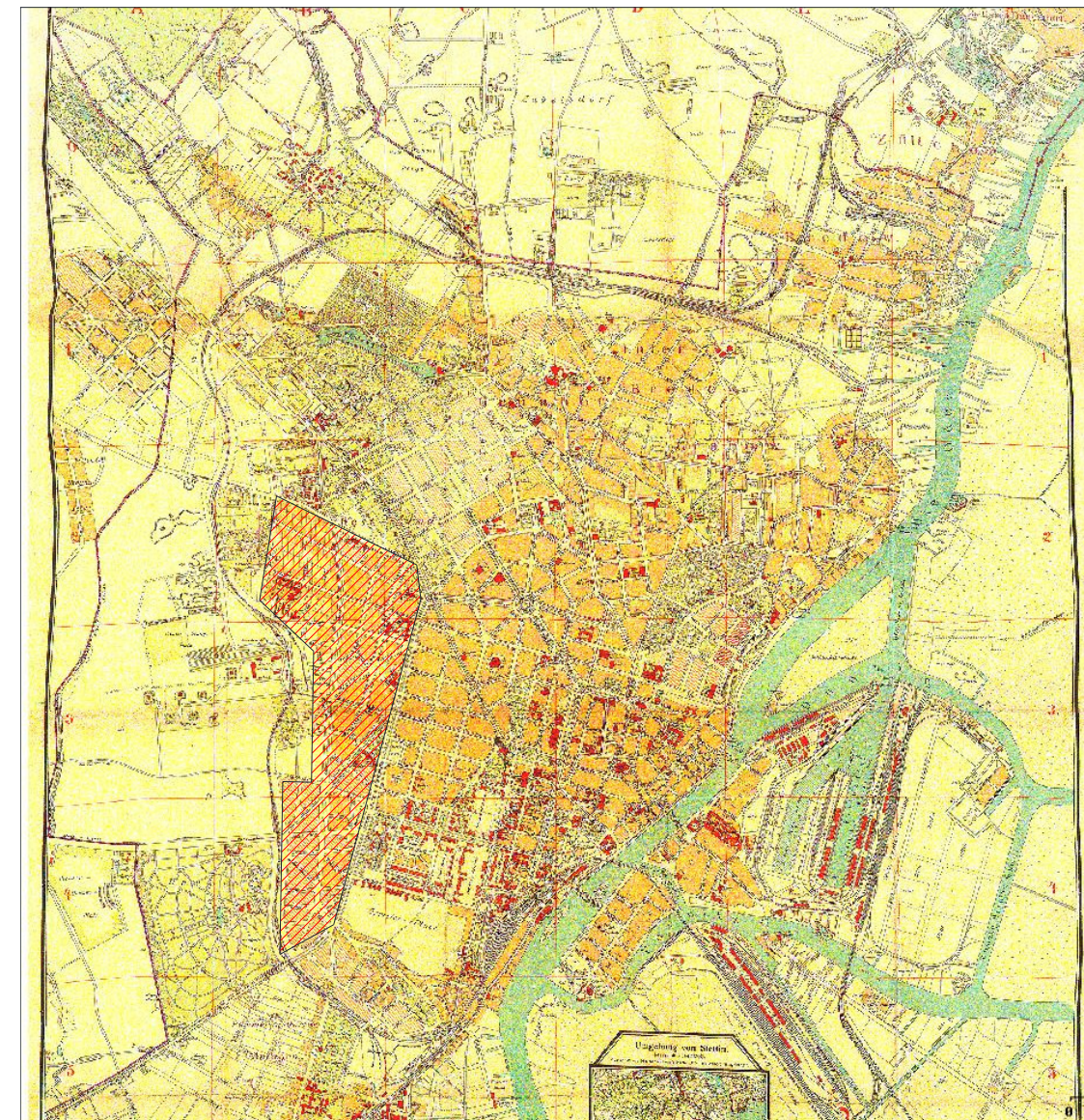

The Turzyn's neighborhood is relatively young, compared to the rest of the city. The plane that we can observe is of the year 1907, and although the area of the neighborhood studied is already planned, in this epoch no type of building existed in Turzyn. It was from this epoch when there was begun the expansion of the city, which was braked completely a few years later with the beginning of the second world war. It is for it that a big number of buildings, like that we will analyze next, they began his construction at the beginning of century, and could not finish even concluded the war.



4. PROJECT OF RESTORATION BUILDING 24.

4.1 Study and architectural analysis.

USE OF THE BUILDINGS

The building to be treated in this project is used for residential.

DESCRIPTION OF THE BUILDING BOLESŁAWA SMIAŁEGO N°24

LOCATION: The building is placed in the western rim of the center of the city. More specifically it is located in the quarter Turzyn. This quarter is in the central district of the city called Centrum.

MAP OF SZCZECIN

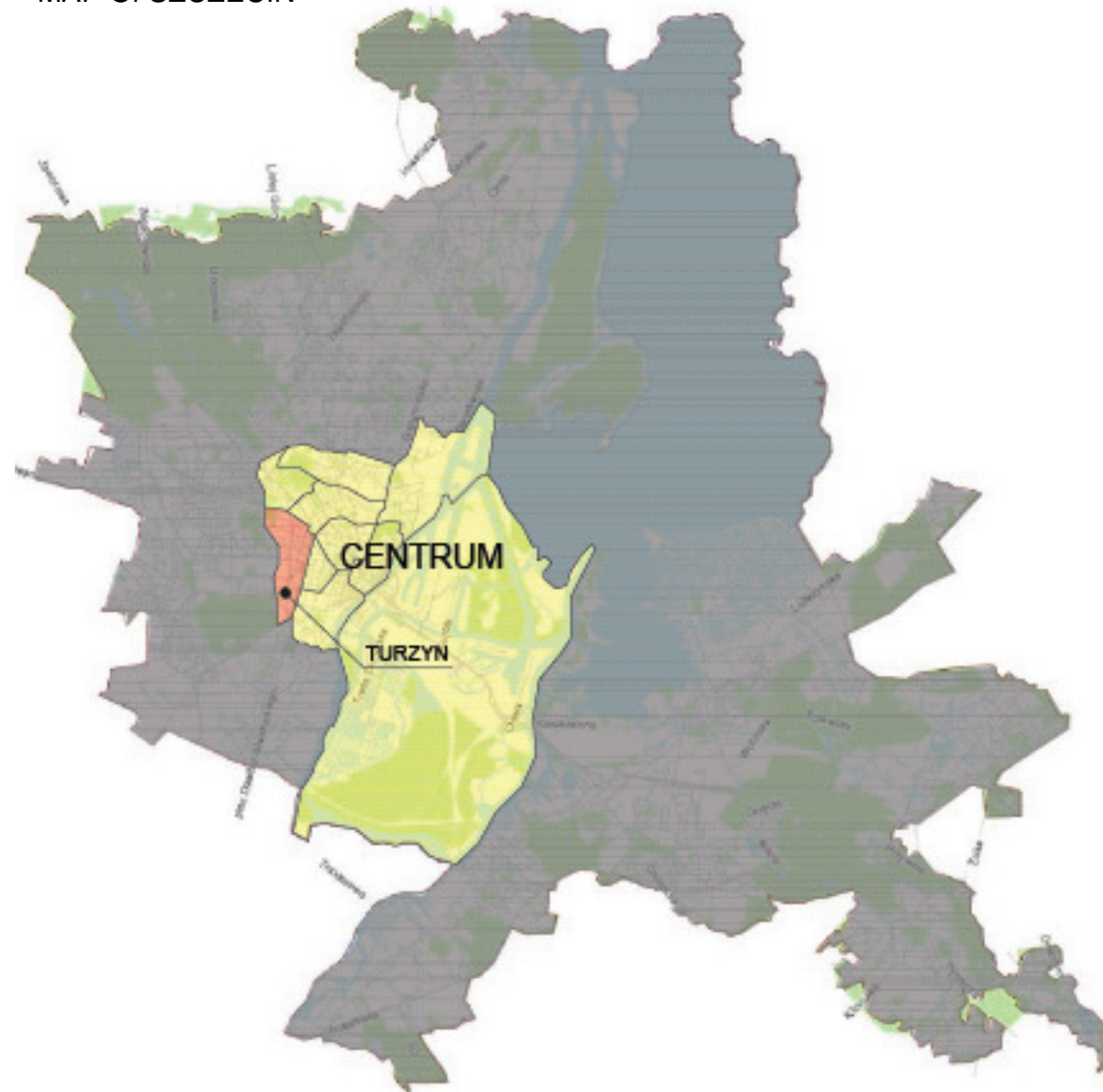

TURZYN



Building n°24



Occupying the corner between c / Bolesława Smialego and c / Jagiellońska of the quarter commented previously. In these streets the buildings are still a boss of height of approximately 19 meters, most of them are residential ones and they destining the ground floors to commercial areas. The c/ Bolesława Smialego takes sidewalks as both sides and double rail for vehicles transit, while the street Jagiellońska presents in addition to previous double rail for the tramcar.



PHOTOS AND SECTIONS OF THE STREETS

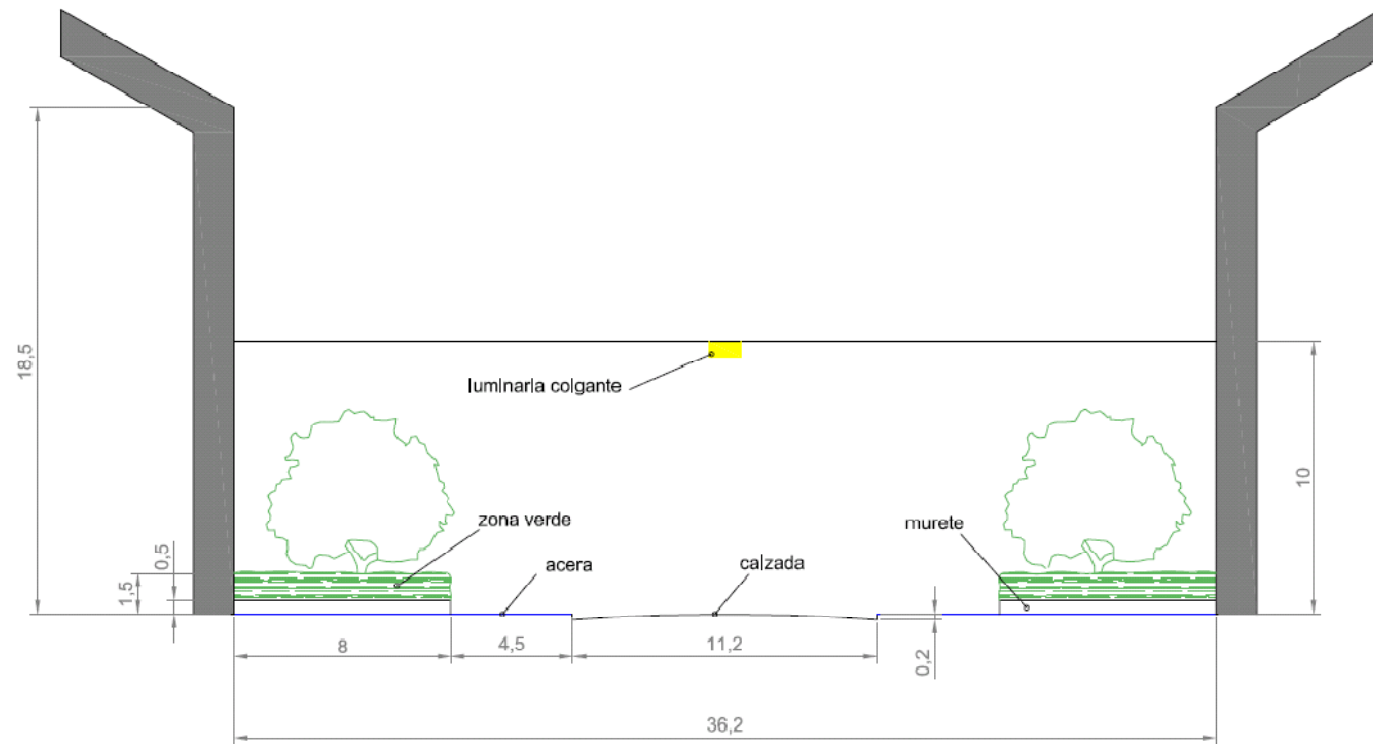

C/ BOLESŁAWA SMIAŁEGO

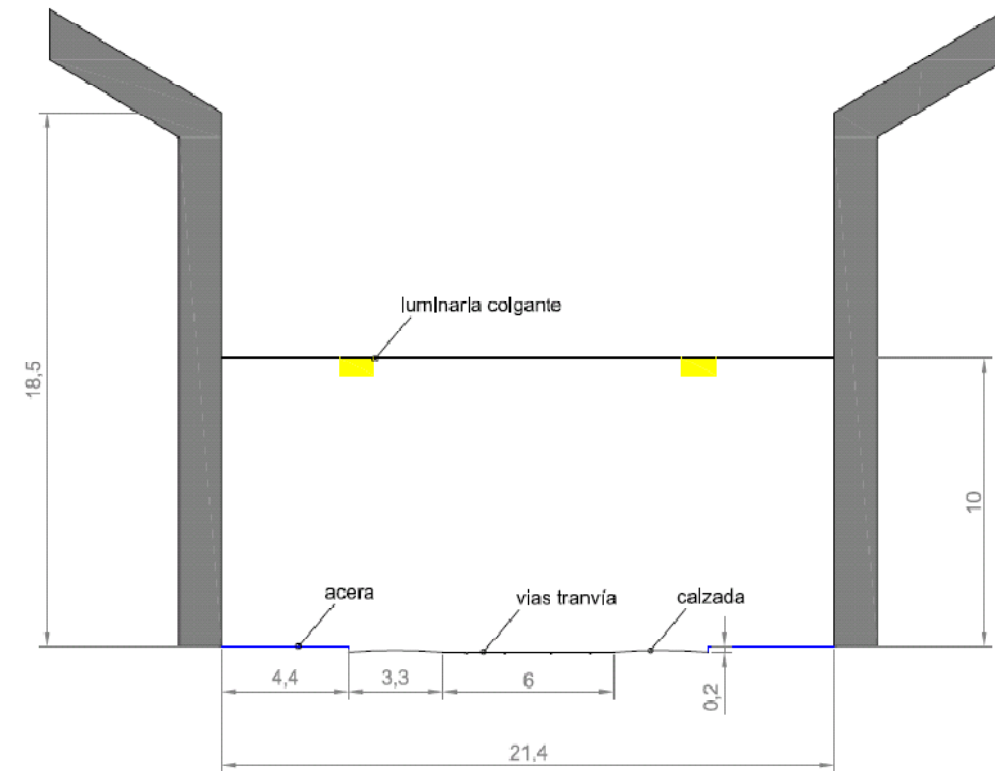

C/ JAGIELLONSKA



PRINCIPAL CHARACTERISTICS

- It is a modernism building destined for residential use. It has four plants with garret and semibasement.
- The building is part of an open apple/block.
- It has two accesses:

The principal access to the housings is in the street Boleslawa Smialego, whose front is in the est façade. The secondary access destined for the rolled is located in the street Jagiellonska, whose front is faced on the South. Both accesses are asymmetric with all constitution of the facade. There are four commercial places in ground floor and one in the semicellar, all of them in use.

- The openings are rectangular and in general, divided into two parts of two rows. In the East facade there are three bay windows, while the South one presents only one.
- Dimensions:

Elevation of c / Boleslawa Smialego $18,4 \times 33,6 = 618,24\text{m}^2$

Elevation of c / Jagiellonska $18,4 \times 26,8 = 493,12\text{m}^2$

HISTORICAL SUMMARY OF THE BUILDING

The building was projected in the year 1902 to begin being constructed in 1904. The works were interrupted by the First World War, being finished in the year 1938. This has provoked that the current result of the building does not coincide exactly with the project of the beginning. It was suffered some changes in the facade. Most of the buildings that we find in this street have more or less the same height, they belong to the modernist movement in wich use big quantity of cornices and forms in the fronts.

PICTURES OF ADJACENT BUILDINGS





PICTURES OF BUILDING



Facade C/ Bolesława Smialego



Profile c/Bolesława Smialego



Facade C/ Jagiellonska



Openings.



Bay Window



Secondary access



Bay window



Opening



Lintel



4.2 Constructive Analysis Of The Buildings

TYOLOGY AND DESCRIPTIVE STUDY OF THE FACADE

PRINCIPAL FACADE:



SOUTH FACADE:



Openings distribution in facade of Boleslawa Smialego street:

Principal access: Format door 1,5x2,65 with semicircular arch.

Commercial shallows in first floor: A hairdressing salon, a consultancy and a shop. The access hollow has a few dimensions of 3'7 x 2' 05 m, while that of the hairdressing salon is 2' 5 x 1 m.

Bay windows: Of the front there stand out three bay windows of 3,8m of width, which are born in first floor and extend up to the attic. These bay windows divide the front in four cloths of asymmetric form.

Openings in bay windows:

Frontal faces: 3x2' 6 x 2' 2m.

Side faces: 6x0' 85 x 2m.

The rest of openings:

Openings for plant type: 15x1x2

Openings at the attic: 4x0,5x0,7m; 2x0,45x1,25m; 2x1,35x0,7m.

Openings of the semicellar: 8x0,8x0,3m

Openings distribution in facade of Jagienllonska street:

Secondary access: There is a secondary access destined for the rolled access of dimensions 2,5x3,95m that gains access to the interior of the courtyard of open apple which the building in question is part the building.

Bay windows: Of this front there stands out only a bay window of 3,15m of width, dividing it in two cloths. in this cloths are distributed the holows of 1x2m mainly in an asymmetric way, there being someone of 0,8x2m. The above mentioned bay window, in contrast to the principal front, starts in the first plant up to the covering.

Openings in the bay window:

Side faces: 6x0,5x2m

Face frontal:3x1,5x2m

Openings in the rest of the front:

Openings for plant tipo:11x 1x2m

Openings in semicellar: 5x 0,8x0,3m. Some windows of the semicellar are over the level of the sidewalk and they were realized by posteriority to the construction of the building for providing light to a place destined for commercial use.



STRUCTURE OF THE FACADE:

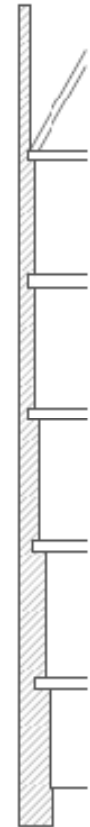

The facade is realized by massive ceramic brick of 24x12x7cm, and cement mortar. The thickness of the wall is variable. In the semicellar the wall reaches 77cm of thickness and in the ground floor 64cm. In the first plant the thickness of the wall diminishes to 51cm, and in two remaining ones to 38cm.

REVTMENT OF THE FACADE:

The facade of the studied building has two types of revetments:

Lime plaster: Most of the surface of the ornament is covered by a layer of lime plaster with 2 cm of thickness. In ground floor and the first one, this layer presents padded form, which produces an increase of thickness of the layer of revetment.

Cement plaster: Some of the holes on the upper floors crown molding is formed by a layer of cement mortar 1-2 cm thick, depending on the area.

Lime plaster's details:

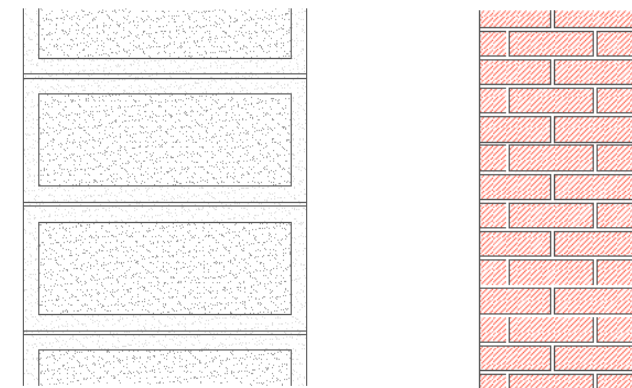

SOLUTION OF THE OPENINGS:

Lintels: they were solved by metallic profiles which support the efforts that the wall transmitted in this area

Sill: used a limestone cladding has been covered with a metal plate for protection against the elements. The arches of the main entrances, are made of ceramic bricks.

Cement plaster's details:

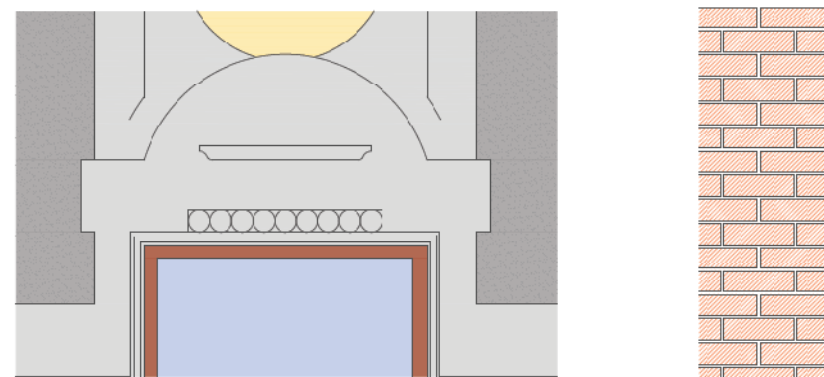

Lintels Detail:

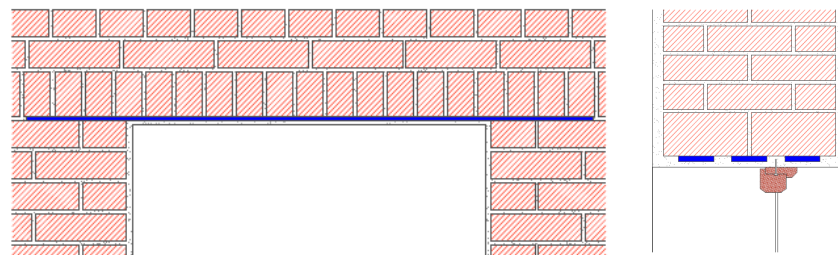



DECORATIVE ELEMENTS OF THE FACADE:

In the facade we can find a big number of decorative elements that give to the building a modernist character.

In the bay windows of the building there are rectangular tiling plaster on the sides, on the front and between floors. (1)

Topping the openings of the second floor there are rectangular veneering with a scroll on each side (2). On the facade there are some scrolls decorating the cantilever. (3)

The building presents two perimeters **cornices**:

- One of them separates the ground floor of the first one. (4)
- other one crowns the front wall.

Also exist small cornices that finish off the openings in the second plant (5). The cornices are realized of plaster, and there are metallic sheets on that protect them from the weather. All the decorative elements have been anchored to the wall face by metal claws.

(2)



(2) and (5)



(4)



PICTURES: (1)



(3)

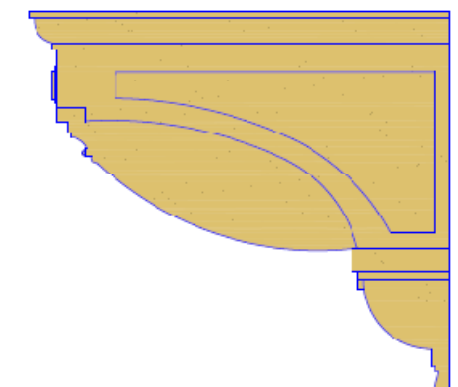
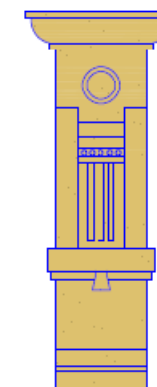



STRUCTURES.

Basing on the constructive methodology of the epoch, the consulted projects and the visual analysis, we deduce that the horizontal structure is formed by frameworks that works in one direction. The vertical structure is formed by walls of load and some isolated support.

The vertical structure is realized by massive ceramic brick of 24x12x7cm. The load walls reduce his thickness as they climb of plant, in the semicellar floor has 77 cm of thickness and 38 cm in the last one.

The horizontal structure is realized by wooden beam in big size. They support the wooden small beams and rest on the load walls. The beam fill space is refilled by a paste formed with a mixture of clay and sawdust, much used in the epoch. When the paste is dry, wooden strips of wood were placed and then nailed the wooden that forms the parquet. The framework of cellar it was realized of different form. In this case the girders and the small beams are metallic. The beam fill space is realized by a brick and filled with a paste of mortar and debris.

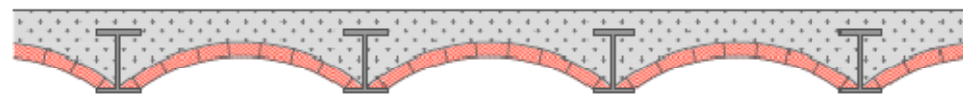
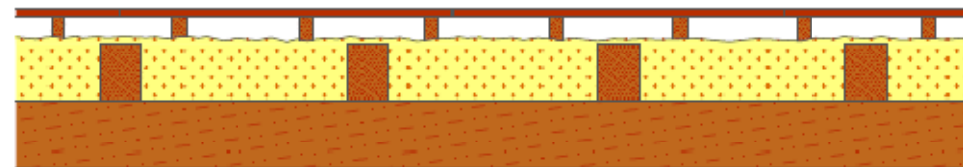

ANALYSIS OF CANTILEVER.

The single cantilever that exists in this building is in the backyard facade. It has a length of 3'15 m and there stands out 1 m of the line of front. The cantilever continues the same direction as the framework the beams beyond the facade line and serve to support the joists.

MATERIALS USED

MATERIALS NAMES	DESCRIPTION	ZONE
Bricks	Massive ceramic brick of 24x12x7	Facade closing
Plaster	Cement mortar	Coating of facade closing
Plaster	Lime mortar	Coating of facade closing
Wood	Beams of massive wood.	Horizontal structure (framework tipo 1)
Paste	mixture of clay and sawdust	Beam fill in horizontal structure (framework tipo 1)
Wooden slats	Wooden slats that forms the parquet	Horizontal structure (framework tipo 1)
Metallic joist	Steel section IPE	Horizontal structure (framework tipo 1)
Poor mortar	Paste make of mortar and debris.	Beam fill in Horizontal structure (framework tipo 2)
Thin hollow brick	Thin hollow brick of ceramic	Horizontal structure (framework tipo 2)
Veneering of gypsum	Plates of gypsum done with mold of different tickness	Decorative elements
Steel section	Steel section of 0,5 mm tickness	Lintels
Metallic sheet	Metallic sheets of 3mm tickness	Sills
Limestone veneering	Veneering of limestone 2cm tickness	Sills



4.3 Problems in the building

File 24.1: Cracks in lintels



Type A

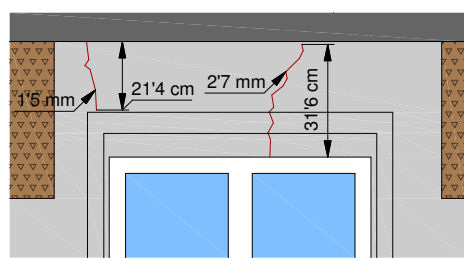

Type B

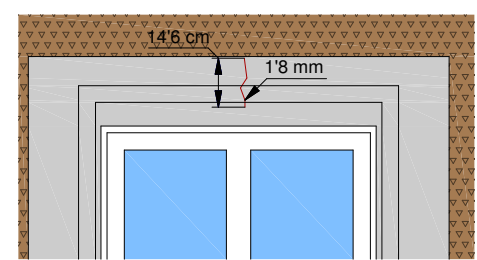

Type C

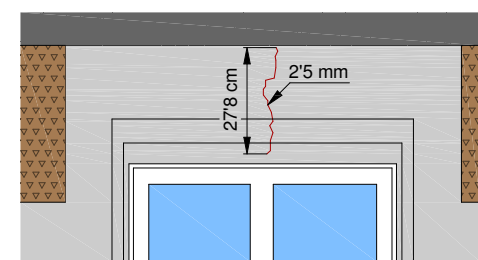

Scheme of Forces

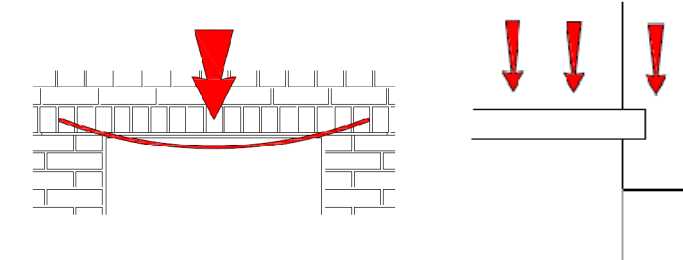

This type is in the third floor. It is the least frequent. Two cracks are appreciated in the lintel. There is one in the center who is born in the low face and climbs for the frontal face, perpendicular to the direction of the lintel. The second fissure is born at the corner of the hollow and extends obliquely towards the low area.

This type is in first and second floors. It is the most frequent. A crack of small size is appreciated in the central area of the lintel, which is born in the low face and climbs for the frontal face, perpendicular to the direction of the lintel.

This type is in the third floor. A crack of considerable size is appreciated in the central area of the lintel, which is born in the low face and climbs for the frontal face, perpendicular to the direction of the lintel.

POSSIBLE CAUSES

If the executed lintel presents cracks, it can be because there has been realized an incorrect calculation of the forces that act on him. Because he supports an excessive proper weight of the wall, or because the charges transmitted by the framework are major than the awaited ones. This provokes an arrow excess in the lintel, as it appears in the scheme, which provokes the cracks. Another possible cause is the bad execution of the lintel on the part of the workpeople, as for example, an inadequate anchoring of the metallic sheets, a bad laying of the bricks, or the employment(job) of an inadequate mortar.



4.3 Problems in the building

File 24.2: Cracks in the lintels



Type A

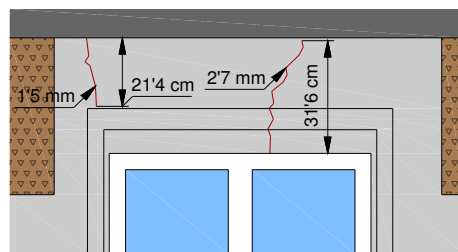

This type is in the third floor. It is the least frequent. Two cracks are appreciated in the lintel. There is one in the center who is born in the low face and climbs for the frontal face, perpendicular to the direction of the lintel. The second fissure is born at the corner of the hollow and extends obliquely towards the low area.

Type B

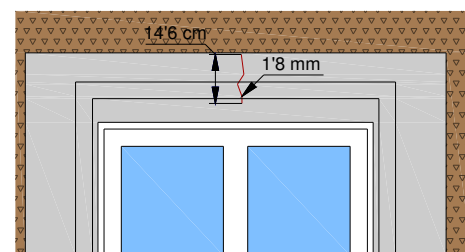

This type is in first and second floors. It is the most frequent. A crack of small size is appreciated in the central area of the lintel, which is born in the low face and climbs for the frontal face, perpendicular to the direction of the lintel

Type C

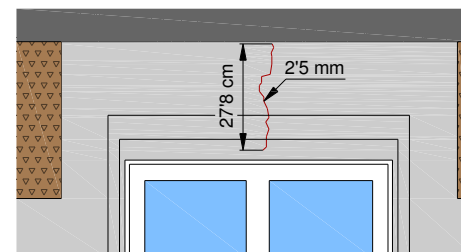

This type is in the third floor. A crack of considerable size is appreciated in the central area of the lintel, which is born in the low face and climbs for the frontal face, perpendicular to the direction of the lintel.

Scheme of Forces

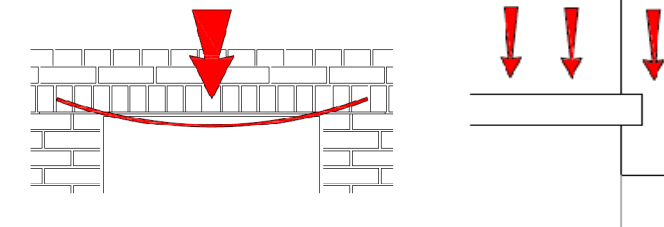

POSSIBLE CAUSES

If the executed lintel presents cracks, it can be because there has been realized an incorrect calculation of the forces that act on him. Because he supports an excessive proper weight of the wall, or because the charges transmitted by the framework are major than the awaited ones. This provokes an arrow excess in the lintel, as it appears in the scheme, which provokes the cracks. Another possible cause is the bad execution of the lintel on the part of the workpeople, as for example, an inadequate anchoring of the metallic sheets, a bad laying of the bricks, or the employment(job) of an inadequate mortar.



4.3 Problems of the buildings

File 24.3: Cracks in the cornices

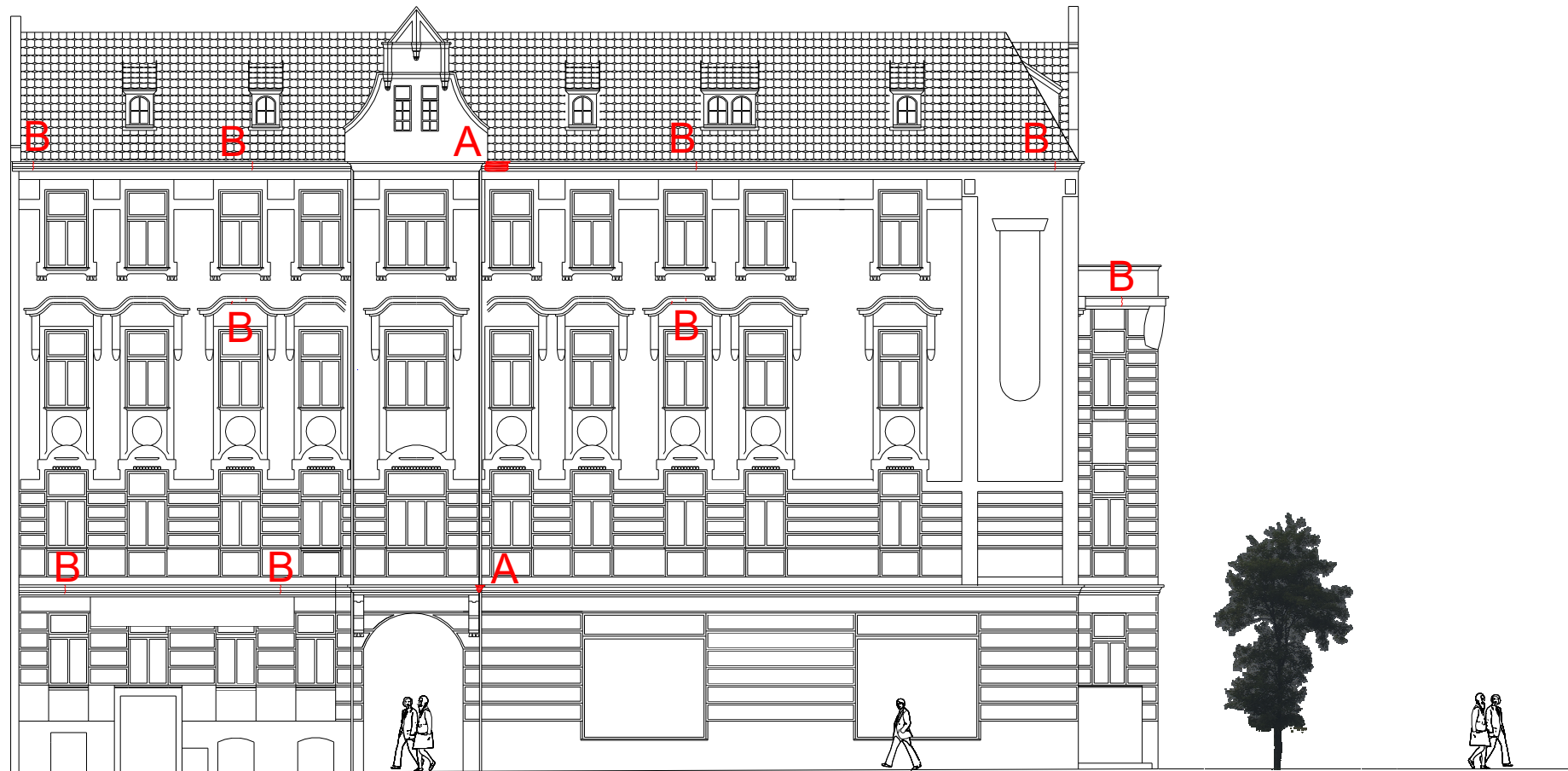

Type A

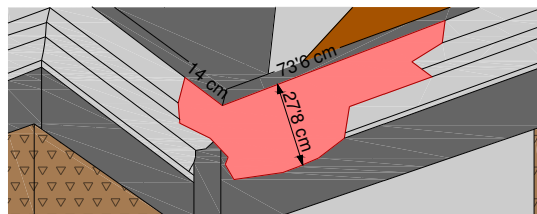

Type B

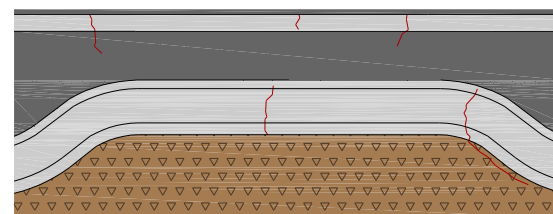

Detail

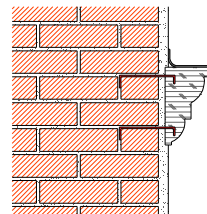

Possible Causes

The cornices that are continuous along the building are coincide with the framework's cants. The efforts that this one could transmit to the load wall, can transmit an excessive effort to the bricks, to which the cornices are adhere. These movements can provoke the cracks in the cornices that are not prepared for this type of efforts. These cracks also can owe to the corrosion of the metallic claws that serve as support to the cornice. When thats claws having corroded experience an increase of volume that provokes a few tensions that the cornice cannot support. The area of the cornice near to the downspout, we suppose that this excessive degradation it stemmed from the break of the gutter the collection of rain waters. But since it is possible to observe in the picture, the gutter has been replaced, for this reason we will center in the repair the cornice.

In this type there qualify the detachments that we find along the front. In the area where the cornices cross the downspout, there is an important detachment. To repair this, there was refilled the area with froth of polyurethane or some of similar product.

Along the length of the top cornice in the building there are cracks, perpendicular to the direction of the same one. The thickness of the craks are between 2 and 5 mm, and the length are between 15 and 20 cm. In some areas, especially in the corners, these problems have provoked a partial detachment of the cornice. The metallic sheets that cover the cornices, present an advanced stated of deterioration. There are areas where the oxidation is very advanced. The sheets have undulated.



4.3 Problems of the building

File 24.4: Cracks in the cornices



Type A

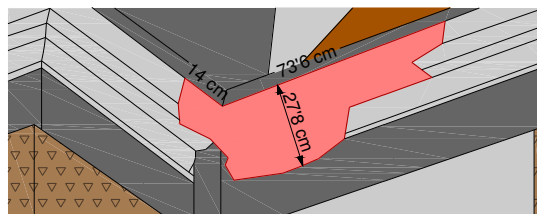

In this type there qualify the detachments that we find along the front. In the area where the cornices cross the downspout, there is an important detachment. To repair this, there was refilled the area with froth of polyurethane or some of similar product.

Type B

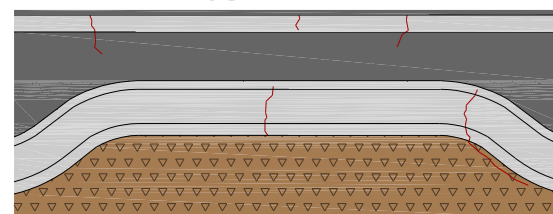

Along the length of the top cornice in the building there are cracks, perpendicular to the direction of the same one. The thickness of the cracks are between 2 and 5 mm, and the length are between 15 and 20 cm. In some areas, especially in the corners, these problems have provoked a partial detachment of the cornice. The metallic sheets that cover the cornices, present an advanced stated of deterioration. There are areas where the oxidation is very advanced. The sheets have undulated.

Detail

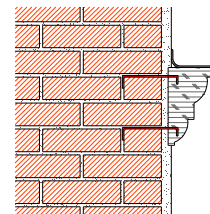

Possible Causes

The cornices that are continuous along the building are coincide with the framework's cants. The efforts that this one could transmit to the load wall, can transmit an excessive effort to the bricks, to which the cornices are adhere. These movements can provoke the cracks in the cornices that are not prepared for this type of efforts. These cracks also can owe to the corrosion of the metallic claws that serve as support to the cornice. When that claws having corroded experience an increase of volume that provokes a few tensions that the cornice cannot support. The area of the cornice near to the downspout, we suppose that this excessive degradation it stemmed from the break of the gutter the collection of rain waters. But since it is possible to observe in the picture, the gutter has been replaced, for this reason we will center in the repair the cornice.





4.3 Problems of the building

File 24.5: Degradation of lime plaster



Description of problems

There is appreciated an important degradation of lime's plaster that covers the facade, which has provoked the appearance of a big number of pores and cavities in the surface of the ornament. The dimensions of these pores are very diverse. Another important symptom, consequence of the previous symptom is the darkening of the revetment for dirt deposition in the cavities.

Constructive detail

Section

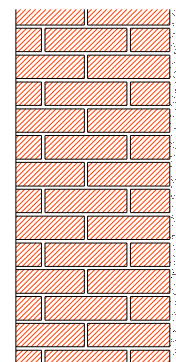

Elevation

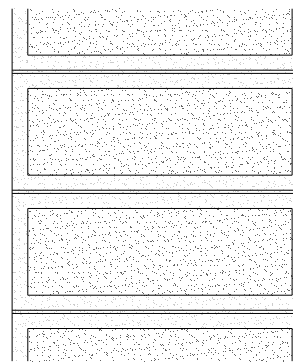

Possible causes

The bad quality of the lime's mortar, added the hardness of the atmospheric agents in certain seasons plus the scarce maintenance of the revetment during his useful life, has provoked the wear of the mortar and the posterior appearance of pores and cavities. The water accumulation in these pores, as well as the changes of volume that experiences that one, provoke the increase of size of the pores. The rough surface created, it allows a major facility for the deposition of the dust and the pollution of the ambience in the cavities, which provokes the darkening of the revetment.





4.3 Problems of the building

Ficha 24.6: Degradation of lime plaster



Description of problems

There is appreciated a notable degradation of lime's plaster that covers the front, which has provoked the appearance of a big number of pores and cavities in the surface of the ornament. The dimensions of these pores are very diverse, some going so far as to reach several centimeters. Another important symptom, consequence of the previous symptom and that appears in the whole front ornament, is the darkening of the revetment for dirt deposition in the cavities.

Constructive Details

Section

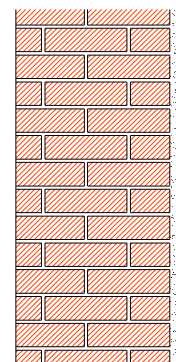

Elevation

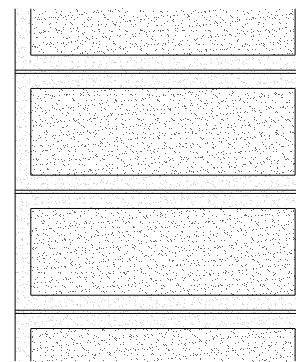

Possible Causes

The bad quality of the lime's mortar, added the hardness of the atmospheric agents in certain seasons plus the scarce maintenance of the revetment during his useful life, has provoked the wear of the mortar and the posterior appearance of pores and cavities. The water accumulation in these pores, as well as the changes of volume that experiences that one, provoke the increase of size of the pores. The rough surface created, it allows a major facility for the deposition of the dust and the pollution of the ambience in the cavities, which provokes the darkening of the revetment.





4.3 Problems of the buildings

File 24.7: Degradation of decorative elements



Description of Problems

In the plaster's veneering that decorate the openings, as well as in the decorations who accompany them, we find small detachment that have left to the overdraft the plaster. In most of the veneering, there are cracks that surround the perimeter of the plates and crackings also in the central areas.

The big decorations placed in the principal facade present the awful conservation state. In one of them there has taken place a detachment of a considerable size, leaving to the overdraft the metallic beam of the cantilever. Also a crack is appreciated in the side face, which is born in the left top corner and descends towards the central area, of approximately 30 cm of length a 5 mm thickness.

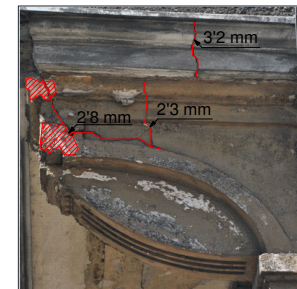
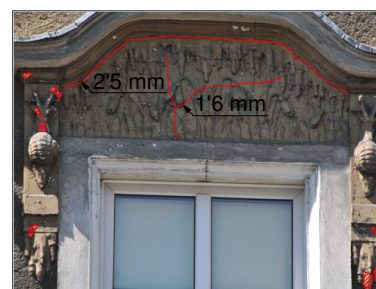
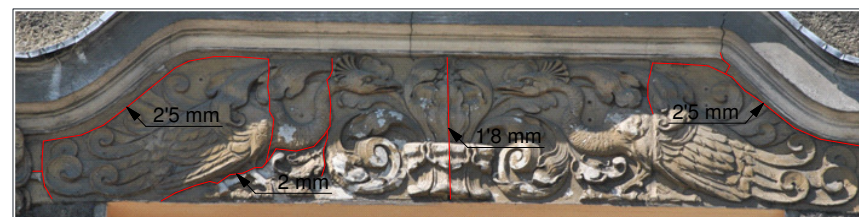

Possible Causes

The crackings in the plates of plaster in the spaces between windows can owe to the movements that experiment the frameworks on these areas, or from the extension of the problems in the lintels, quoted in previous cards.

Also, an important cause is the void maintenance that the veneering have received, what has provoked the appearance of a big number of detachment and bleaching of the elements.

The decoration of big size present problems owe to the movements that experiences the beam of the framework which they are anchored. Also the crack of the top cornice has provoked the oxidation of the metallic claws, which, on having expanded, provoke tensions that the material cannot support.





4.3 Problems of the building

File 24.8: Degradation of decorative elements



Description of Problems

In the plaster's veneering that decorate the openings, as well as in the decorations who accompany them, we find small detachment that have left to the overdraft the plaster. In most of the veneering, there are cracks that surround the perimeter of the plates and crackings also in the central areas.

The big decorations placed in the principal facade present the awful conservation state. In one of them there has taken place a detachment of a considerable size, leaving to the overdraft the metallic beam of the cantilever. Also a crack is appreciated in the side face, which is born in the left top corner and descends towards the central area, of approximately 30 cm of length a 5 mm thickness.

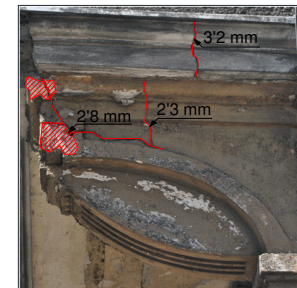
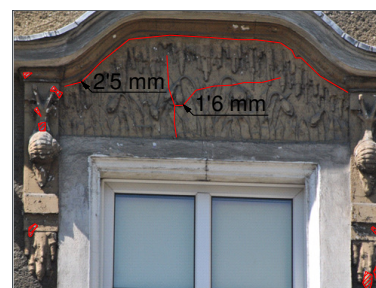
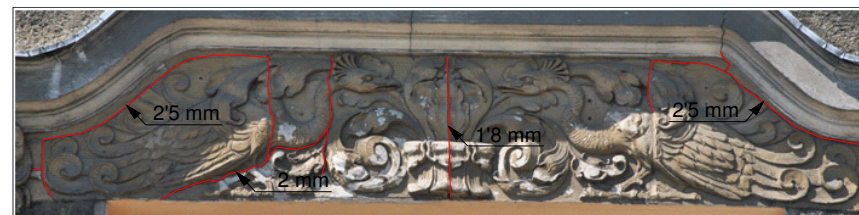

Possible Causes

The crackings in the plates of plaster in the spaces between windows can owe to the movements that experiment the frameworks on these areas, or from the extension of the problems in the lintels, quoted in previous cards.

Also, an important cause is the void maintenance that the veneering have received, what has provoked the appearance of a big number of detachment and bleaching of the elements.

The decoration of big size present problems owe to the movements that experiences the beam of the framework which they are anchored. Also the crack of the top cornice has provoked the oxidation of the metallic claws, which, on having expanded, provoke tensions that the material cannot support.





4.3 Problems of the building

File 24.9: Degradation of the cement mortar



Description of Problems

The cement mortar that forms the frames, we observed cracks in the spaces between windows. Many of them are a continuation of the cracks that have appeared in the lintels. Also there are cracks in the sills of a big number of windows. The mortar presents a considerable bleaching in all his surface.

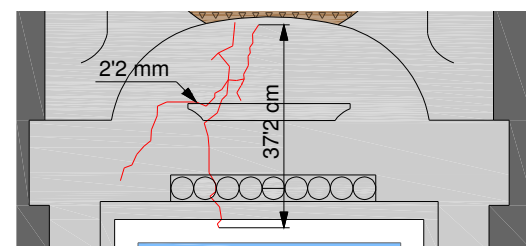

Detail of Lintel

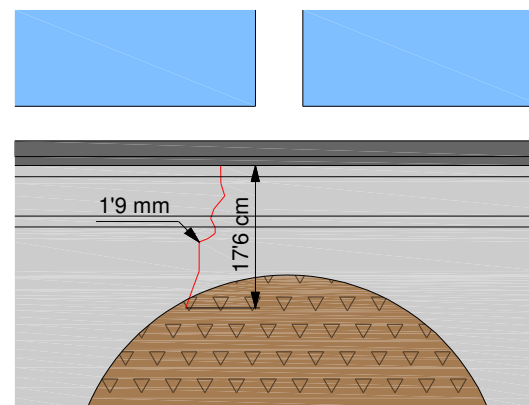

Detalle of Sill

Possible Causes

The crackings of the cement mortar placed in the spaces between windows can owe to the movements that experiment the frameworks on these areas, or can stem from the extension of the problems in the lintels, quoted in previous cards. Another important cause is the void maintenance that has received the revetment. That has provoked the appearance of a big number of flaked, and the bleaching of the elements by the sun.





4.3 Problems of the building

File 24.10: Degradation of cement mortar



Description of problems

The cement mortar that forms the frames, we observed cracks in the spaces between windows. Many of them are a continuation of the cracks that have appeared in the lintels.

Also there are cracks in the sills of a big number of windows. The mortar presents a considerable bleaching in all his surface.

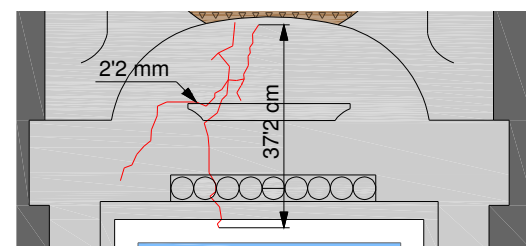

Detail of Lintel

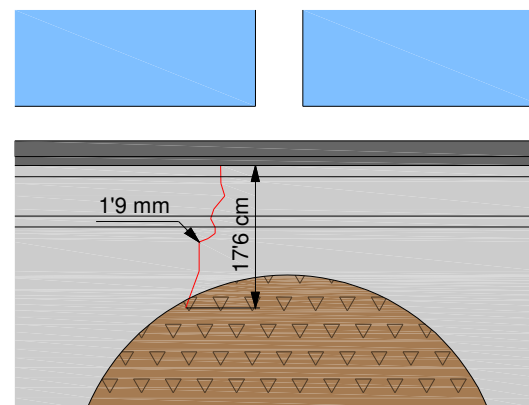

Detail of Sill

Possible Causes

The crackings of the cement mortar placed in the spaces between windows can owe to the movements that experiment the frameworks on these areas, or can stem from the extension of the problems in the lintels, quoted in previous cards.

Another important cause is the void maintenance that has received the revetment. That has provoked the appearance of a big number of flaked, and the bleaching of the elements by the sun.

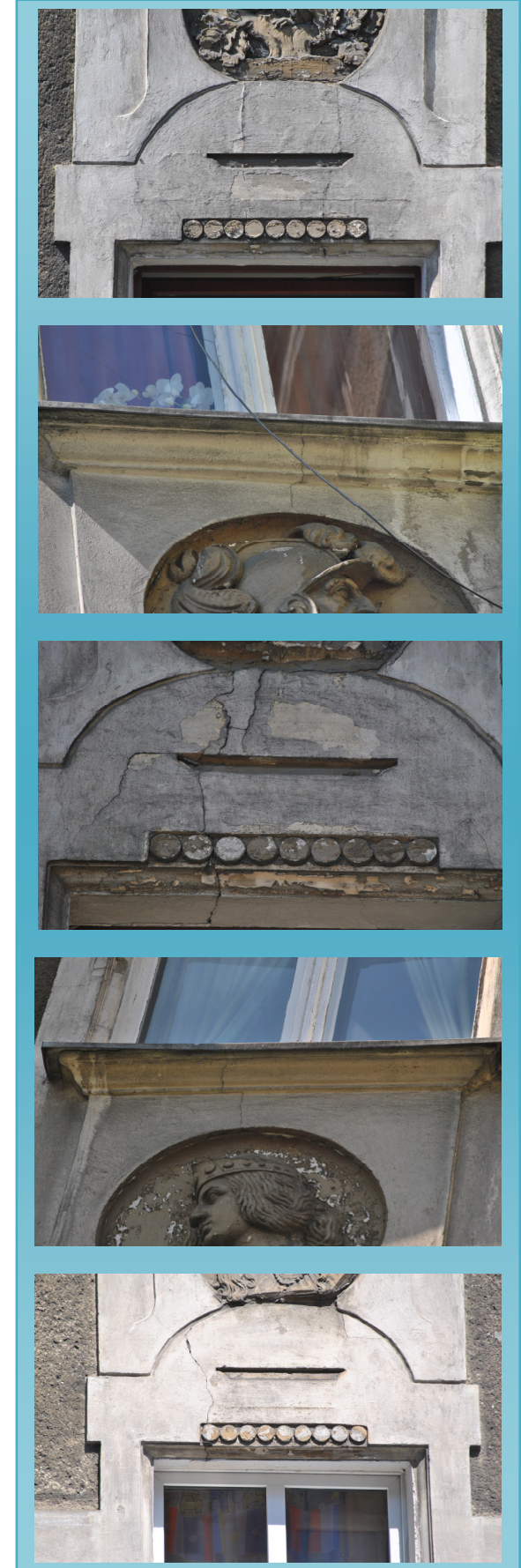



4.3 Problems of building

File 24.11: Metal corrosion joist.

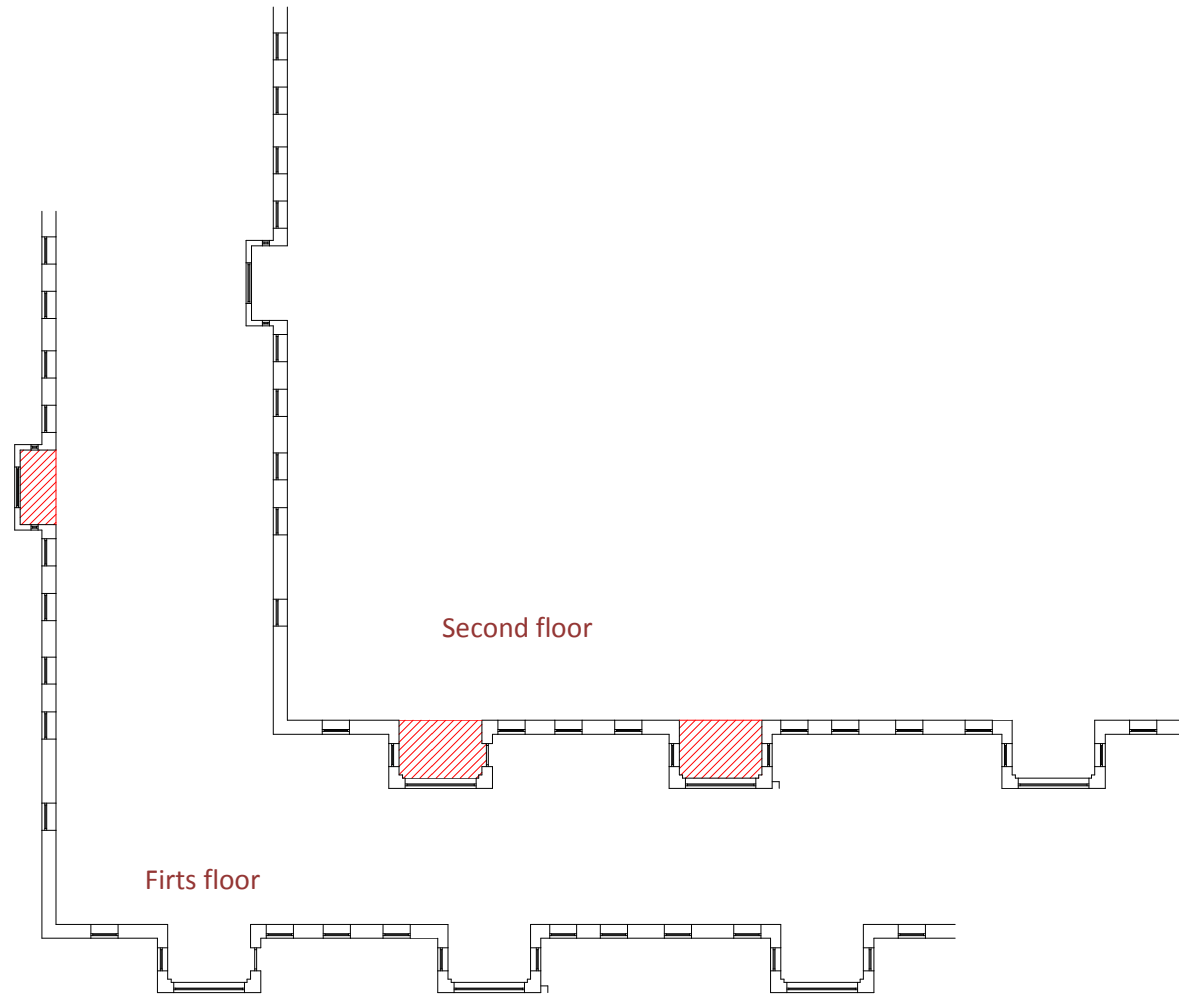

Possible Causes

The defects are light and they do not suppose any problem for the structural stability of the building. The revetment mortar is very damaged because it is of bad quality, and has not received any maintenance along his life. The corrosion of the metallic small beams has taken place because the revetment mortar has become detached. This has left the small beams to the overdraft, accelerating the corrosion.

Bay window of second floor

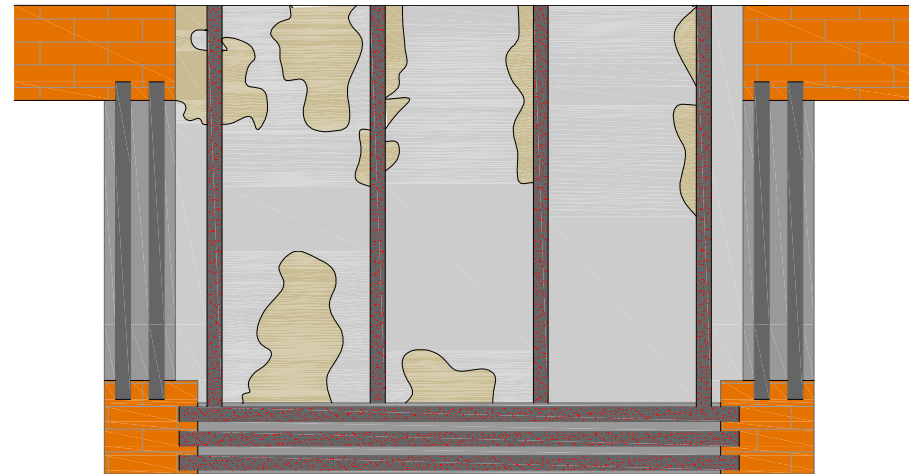

There is corrosion in the joists that form the cantilever, and in the joist of the frontal lintel. As we see in the detail, there are areas where the mortar of revetment the joist has detached. The mortar that still survives is very damaged. The joist of the side openings do not present any problem.

Cantilever of first floor

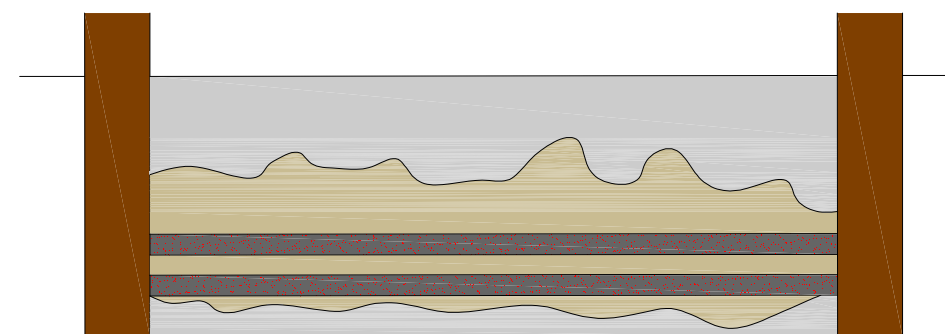

The revetment mortar is very damaged. Largely surface of cantilever it has got rid, and the joist have stayed to the overdraft. There is corrosion in two metallic joist that form the cantilever.





4.4 Restoration proposals

File 24.1: Cracks in lintels

Description:

As intervention to this problem, we propose to reinforce the lintels damaged by laying of a resistant element that works to haulage (a steel section in the shape of E). This steel section will be placed in the low part in order to resist the efforts.

Programation for repair

- 1°_ Extraction the carpentry to avoid damages and to clear the work plane.
- 2°_ To shore up the interior or with pins that cross the front.
- 3°_ Eliminate revetment of mortar to uncovering the metallic sheets.
- 4°_ Make chase in the wall of dimensions sufficient for the laying of the reinforcement.
- 5°_ Eliminate old steel sections.
- 6°_ Collocation the steel sections of reinforcement in the shape of E.
- 7°_ Priming of a layer of antirust painting.
- 8°_ Filling of the chase.
- 9°_ Recovering by a cement mortar layer.

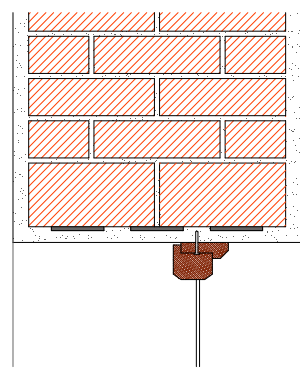

Origen state

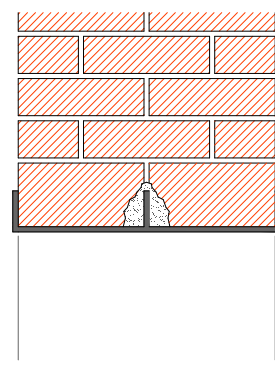

During the process

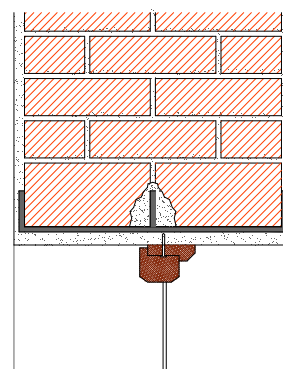

Lintel restored

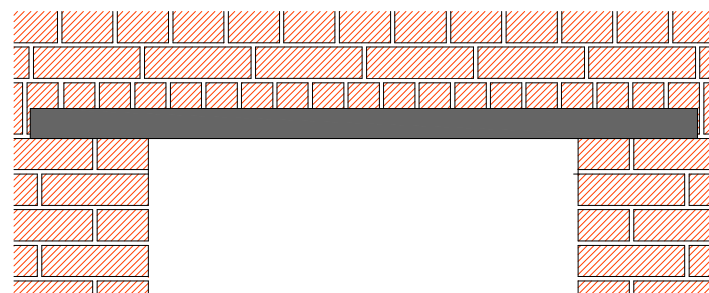

Elevation of lintel

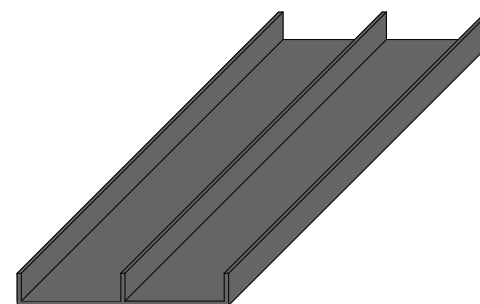

Detail of Reinforcement

File 24.2: Cracks in cornices

Description:

As intervention to this problem, we propose replacement the parts of the cornice where detachments have taken, as well as the metallic claws that support it. The cornices will be realized in workshop by cast molds to image original ones.

In the areas where cornices have cracks will place a mesh and they will refill the cracks with resin.

The metallic sheets placed on the cornices will be replaced completely because it has a lot of oxide.

Programation for repair:

- 1°_ Elimination of the metallic sheets that cover the cornices.
- 2°_ Delimitation and extraction of the area of cornice to be eliminated.
- 3°_ Elimination of the bricks that serve as anchoring to the metallic claws, for the extraction of claws too.
- 4°_ Collocation the new metallic claws and new bricks.
- 5°_ Collocation new pieces of the cornice.
- 6°_ Cleanliness and filling of the cracks by resin repairers.
- 7°_ Laying of the repaire mesh in the raw areas.
- 8°_ Priming of a layer of plastic painting that protects the cornices of the inclement weather.
- 9°_ Collocation metallic sheets of protection.

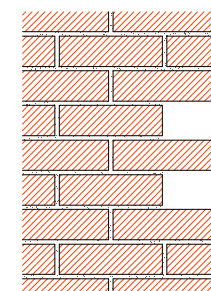

Removing the damage cornices

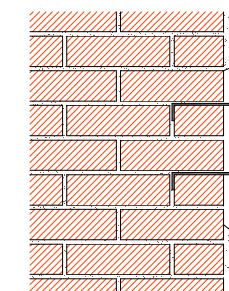

Collocation new metallic claws

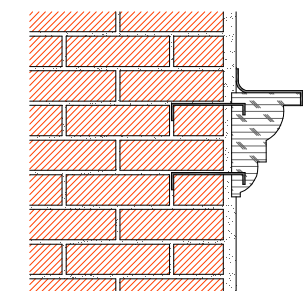

Collocation new cornices and new sheep

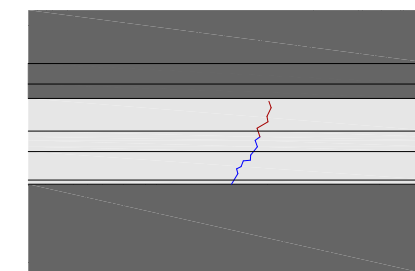

Fills the cracks with resins

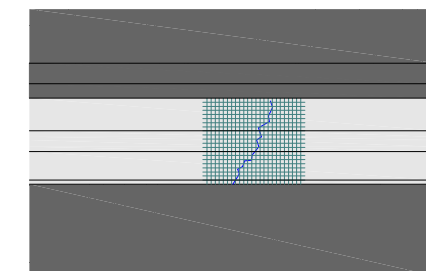

Placement of mesh repair



4.4 Restoration proposals

File 24.3: Restoration of decorative elements.

Description:

The intervention on the plaster veneering will be realized in situ.

As intervention we propose cleanliness the veneering and to refill the cracks with resin repairer, placing, if it is necessary, a mesh that reinforces the union between the weakest areas.

As soon as the cracks were repaired there will be applied a layer of painting that protects the appeared ones of the inclement weather.

As for the decorations in the cantilever, for their bad state of conservation and the number of detachments, we propose completely replace.

Programation for Repair

1°_ Cleanliness of the plaster veneering by projection spray of atomized water with low pressure.

2°_ Filling of the cracks by resins repairers who assure the unification of the efforts.

3°_ Laying, when it is necessary, a repairer mesh as reinforcement for the unification of the efforts.

4°_ Priming of a layer of plastic painting for location that protects the appeared ones of the meteorological inclemencies.

5°_ Extraction of the damaged decoration and formation of mold for making the new ones in workshop.

6°_ As soon as the decoration were realized in the workshop, laying of the volutas by means of metallic anchoring.

Detail of decoration

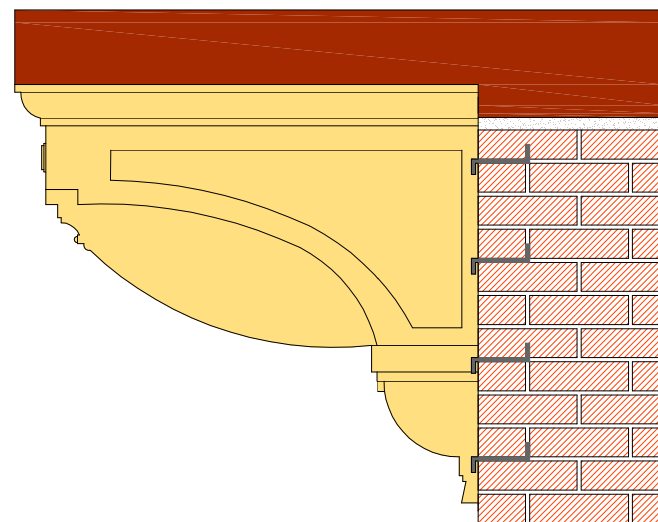

Detail of veneering

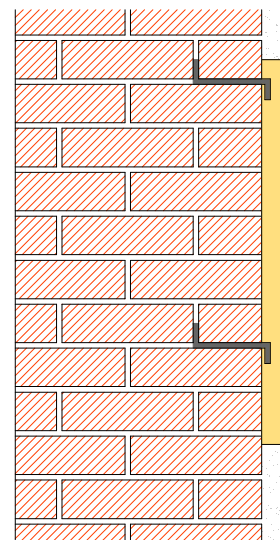

Ficha 24.4: Restoration of lime plaster and cement mortar

Description:

As intervention to this problem, is proposed the replacement of the lime plaster by one of cement, of major quality. The same will happen with the cement mortar damaged that gives form to some of the frames at the facade. First we will give a regularization layer on the bricks of 1 cm of thickness, and on this one, the layer of finished whose thickness changes between 2 and 3 cm, if there are or not frames.

Programation for Repair

1°_ Stung the damage mortar with manual means.

2°_ Cleanliness the facade.

3°_ 1° mortar layer of 1 cm of thinnckness.

4°_ 2° mortar layer of higher qualityde mayor of 1 - 2 cm of thinnckness.

5°_ Primer a layer of acrylic paint to protect against the elements.

Detail of lime mortar restoration

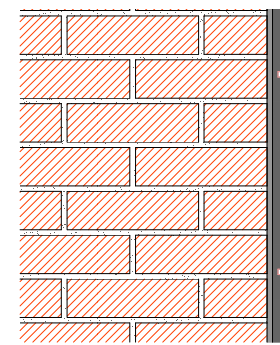

Detail of cement mortar restoration

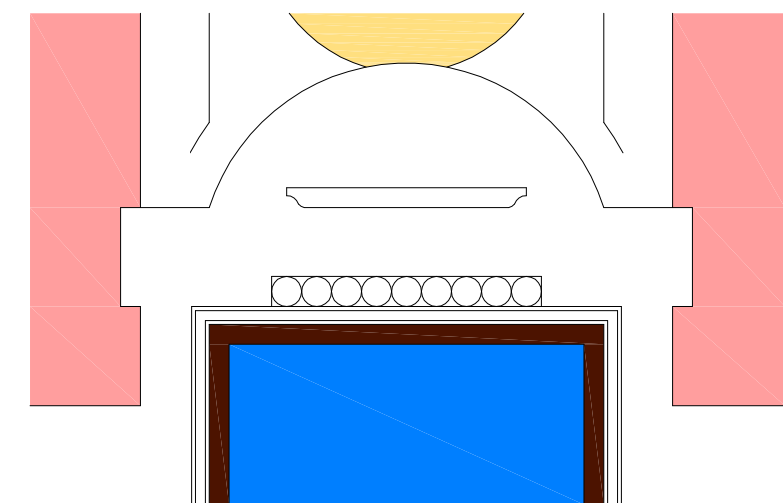
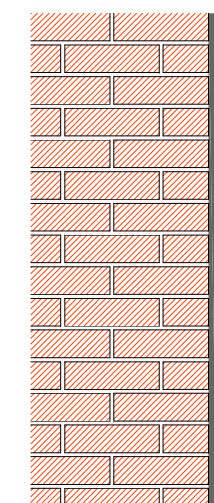



4.4 Restoration proposal

File 24.5 : Restoration of metallic joist.

Description:

The restoration proposal is based on the elimination of the damaged mortar and the repair of the metallic joist. First we will eliminate the mortar that is still supported. Later we will clean the corrosion of the metallic small joist with a metallic brush, and will clean the rest of the surface to eliminate the dust. Next we will paint the small joist with a special painting that protects them. To finish, we will place a layer of cement mortar that surface covers, and will paint the area with plastic painting.

Programation for Repair

- 1°_ Elimination damaged mortar that still survives to clear the area.
- 2°_ Cleanliness corrosion of the metallic joist with metallic brush.
- 3°_ Cleanliness whole surface with brush to eliminate the dust of the surface.
- 4°_ Painting Layer repairer anti-oxidation in the metallic small beams.
- 5°_ Layer of cement mortar.
- 6°_ Layer of plastic painting.

Detail of the process

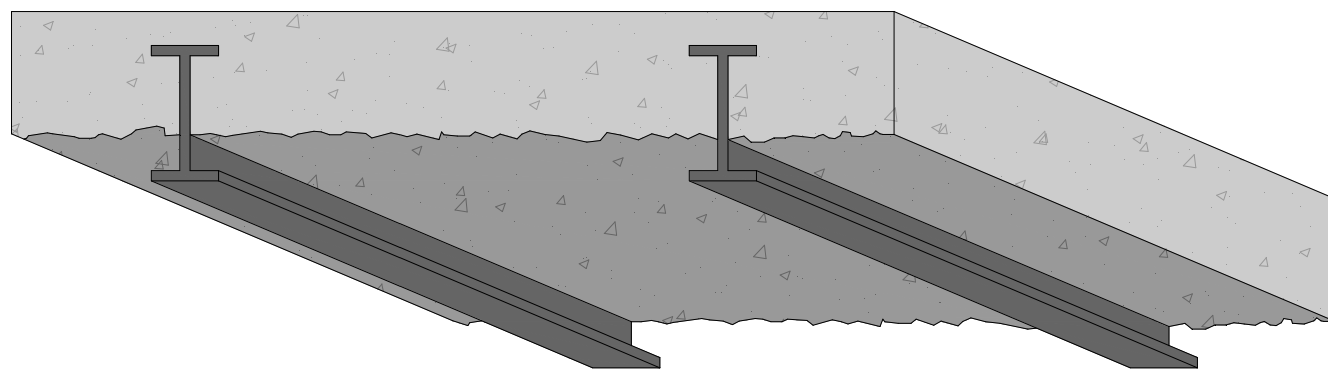

File 24.5 : Restoration of the carpentry.

Description:

In this restoration we propose replace the original carpentry for a new ones, which contributes a major thermal isolation. The original carpentry that still survives is quite damaged. It has many cracks and most of the painting are loose. The new carpentry will be of wood and it will have glazing of double layer.

Programation for Repair

- 1°_ Extraction of original carpentry.
- 2°_ Collocation frames of the windows.
- 3°_ Laying of the windows.
- 4°_ Layer of plastic painting for location.

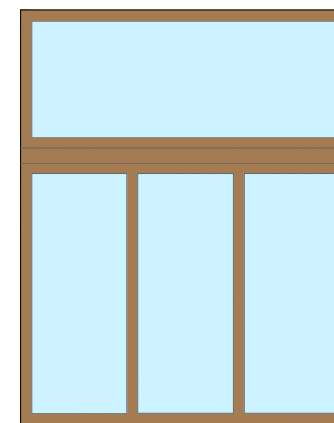

Cantilever windows

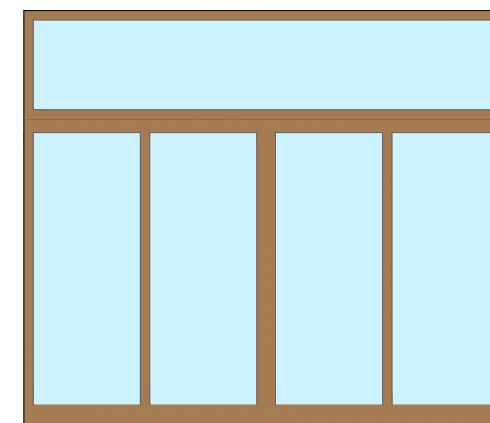

Bay window's windows

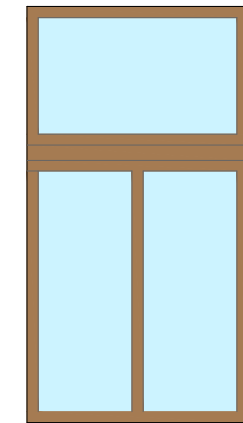

Type windows

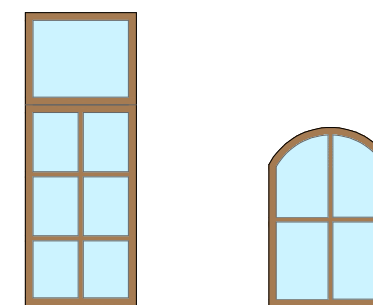

Attic windows



4.4 Restoration proposal

Restored facade Jagiellonska street





4.4 Restoration proposal

Restored facade Boleslawo Smialego street





4.5 Restoration of gardens

Original model

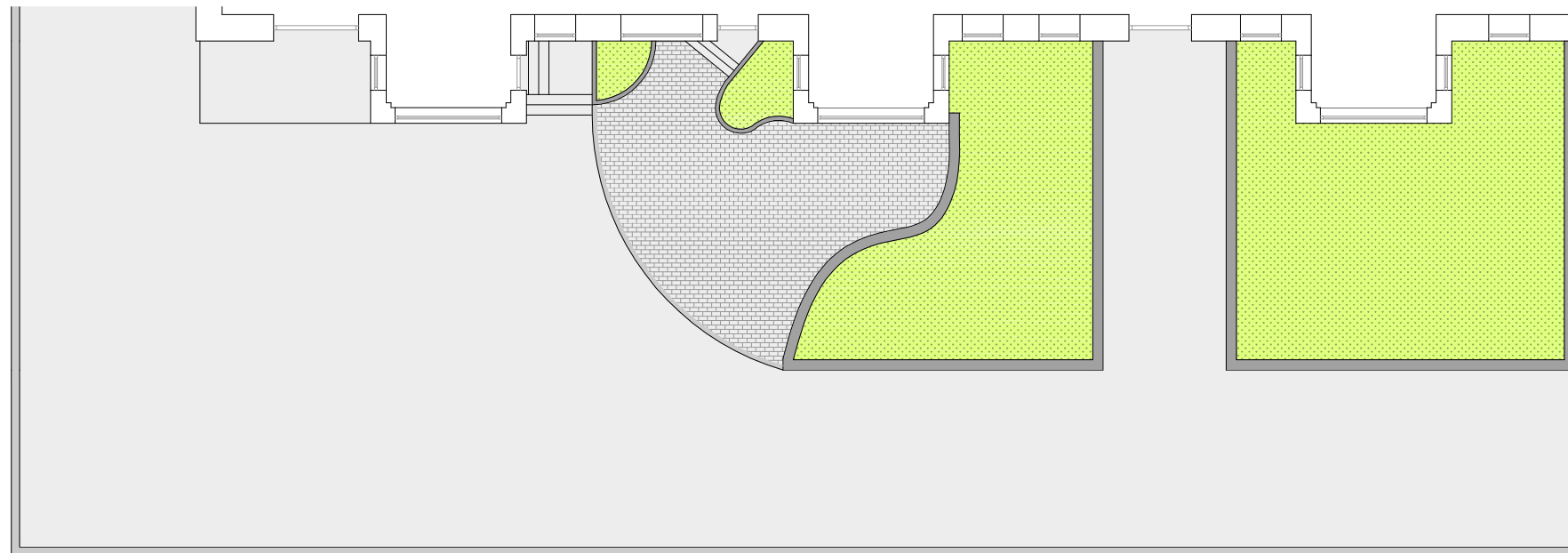

Analysis of problems



Description of symptoms

The perimeter wall that surrounds the landscaped area of the building is realized by massive ceramic bricks and a recovering of mortar of lime. The above mentioned wall has a big number of cracks in all his length that in some cases reach more than one centimeter of thickness. Also, in some areas these cracks have provoked detachments of a considerable size. The garden is formed by a line of firs that surrounds the area, and several trees distributed randomly.



4.5 Restoration of gardens

Restored model

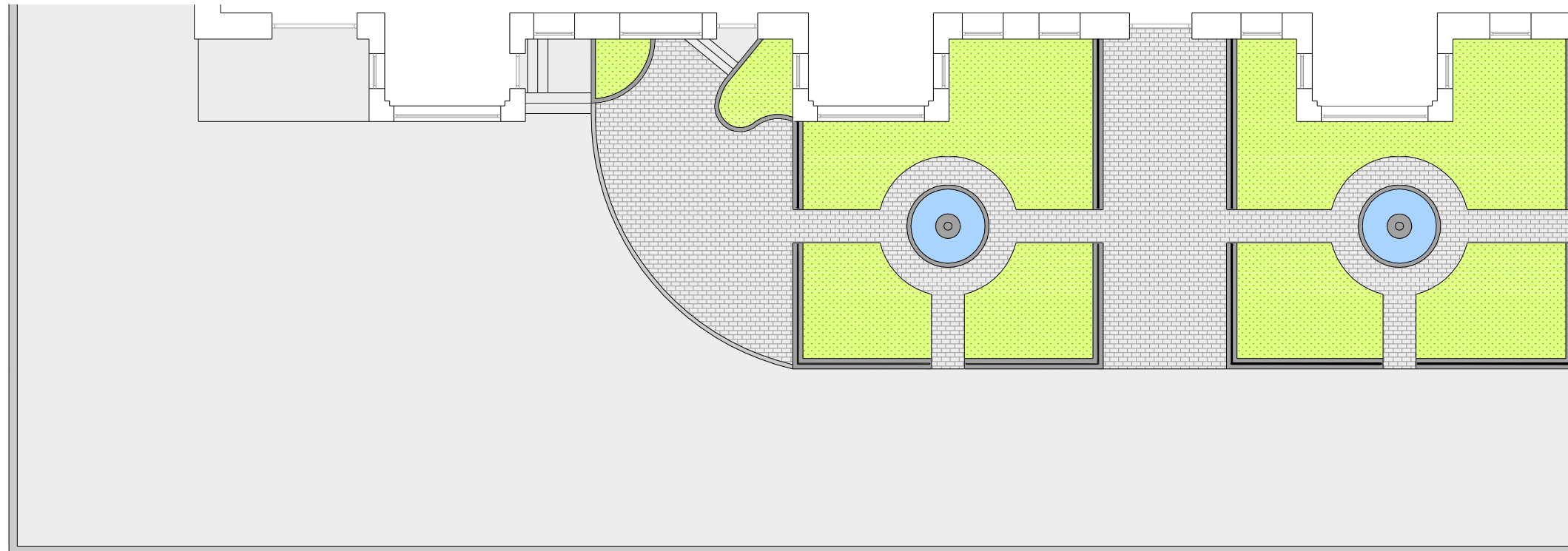

Description of the intervention:

The intervention is based on the replacement completely of the perimeter wall, due to his bad conservation state, and of the firs that surround some parts of the landscaped area. The new wall will be realized by massive brick (24x11 '5x7 cm), and will have 24 cm of thickness. This wall will support a metallic fence 40 cm high of wrought steel, with a recovering of plastic painting that protects it against the meteorological inclemencies. In both landscaped areas a source will be placed in the center, to which three different ways will come. Finally, a paving will be placed in the areas of transit of the housings.

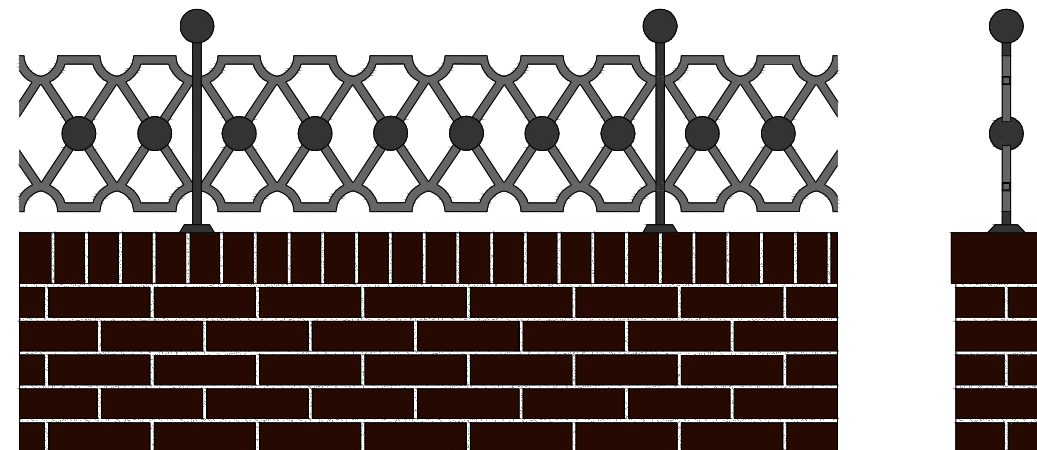



5. PROJECT OF RESTORATION BUILDING 44

5.1 Study and architectural analysis

USE OF THE BUILDING.

Residential.

DESCRIPTION OF THE BUILDING BOLESŁAWA SMIAŁEGO N°7

LOCATION: The building is in the western part of the city, as the previous one. More specifically it is located in the quarter Turzyn. This quarter is in the central district of the city called Centrum.

MAP OF SZCZECIN

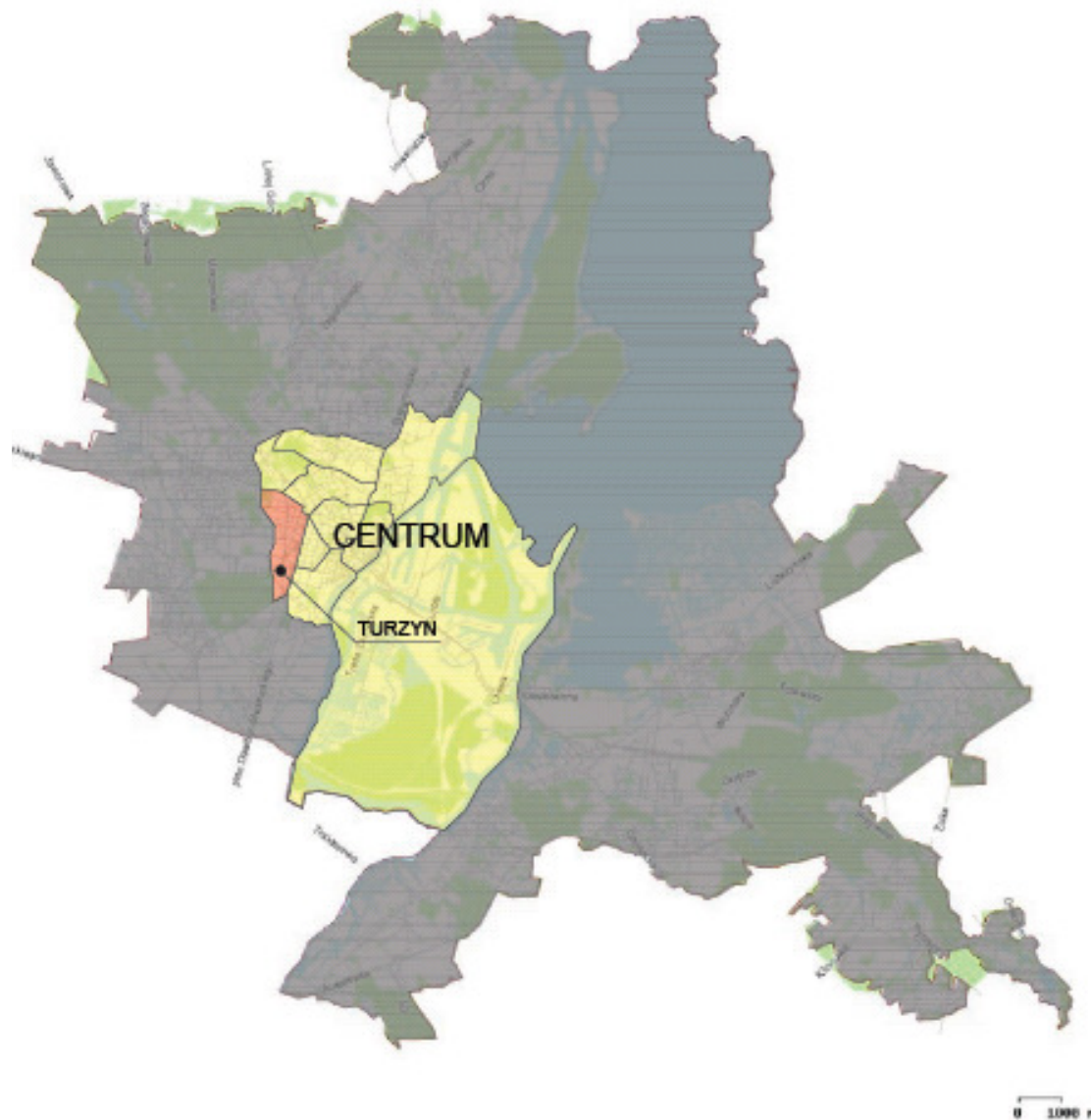

TURZYN

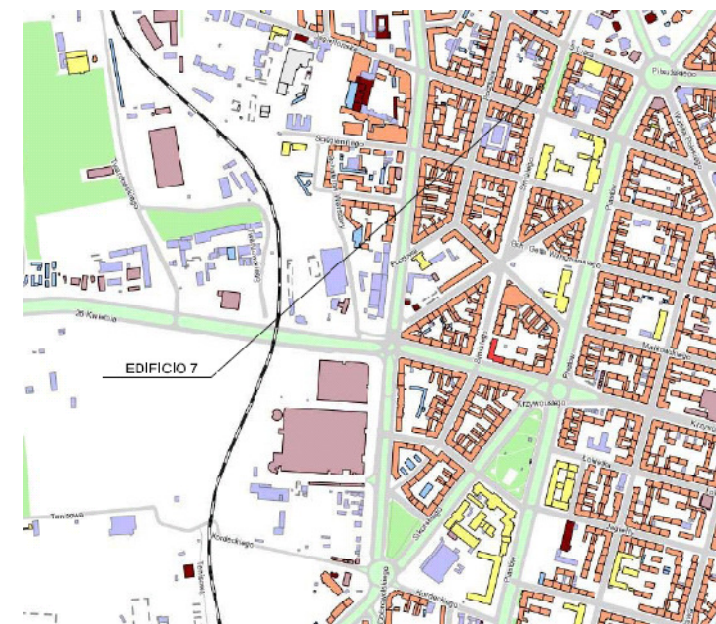

Building n°7

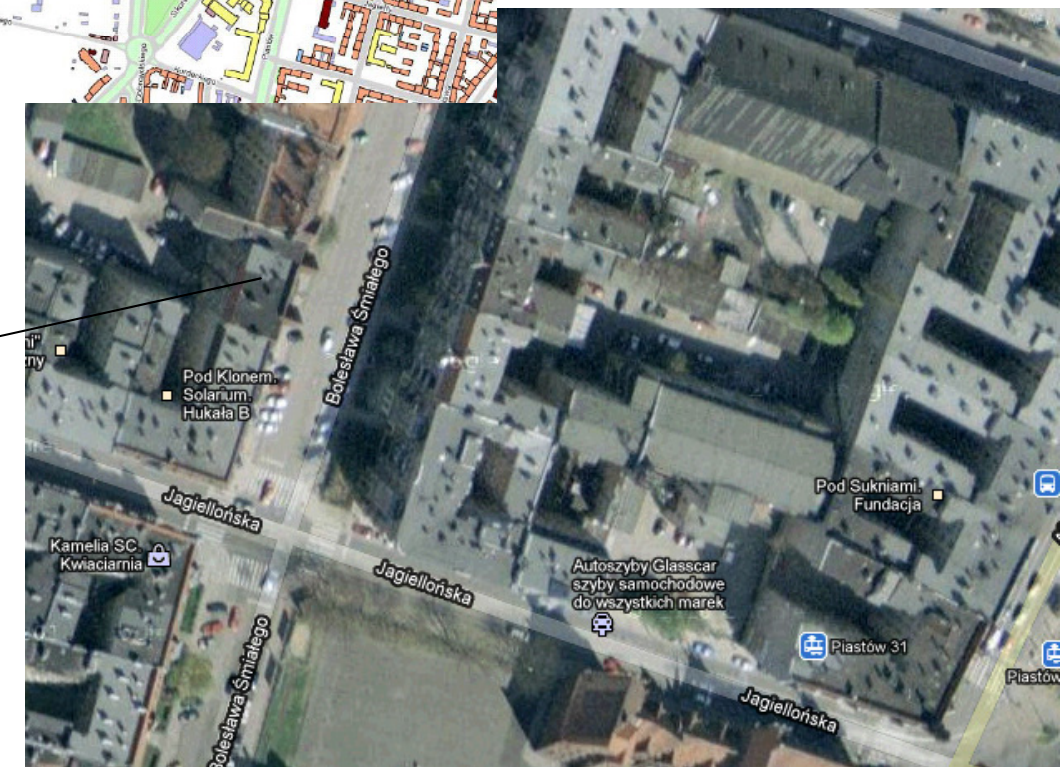

The building is in the street Borisława Smiałego, occupying the number 7. The building is between party walls, bordering on the buildings n°24 and n°6.



PICTURES AND SECTION ABOUT THE STREET



PRINCIPAL CHARACTERISTICS.

- It is a question of a modernist building destined for **residential** housing.
- It consists of a semicellar, four plants and garret. The building is part of a **closed apple** and in his front we can find one opening for access rolled to the right part, as the pedestrian access to the hall in the central area of the building.
- It does not present commercial places in first floor, since this one is also of residential use.
- Two tiers of **bay windows** that begin in the ground floor until the roof.
- The **openings** are in general rectangular with two tiers and two party gaps.

Dimensions:

Elevation Boleslawa smialego n°7: $22 \times 20 = 440 \text{ m}^2$.

HISTORICAL SUMMARY OF THE BUILDING

The building, likewise the previous one, was projected in 1902 and begun constructing in 1904, being this process interrupted by the First World war, therefore it was finished in 1939. It is because of, the current state of the building does not coincide exactly with the planes of the old project that we have found in the Szczecin's city hall. The buildings in this street are part of the same movement, the modernism.

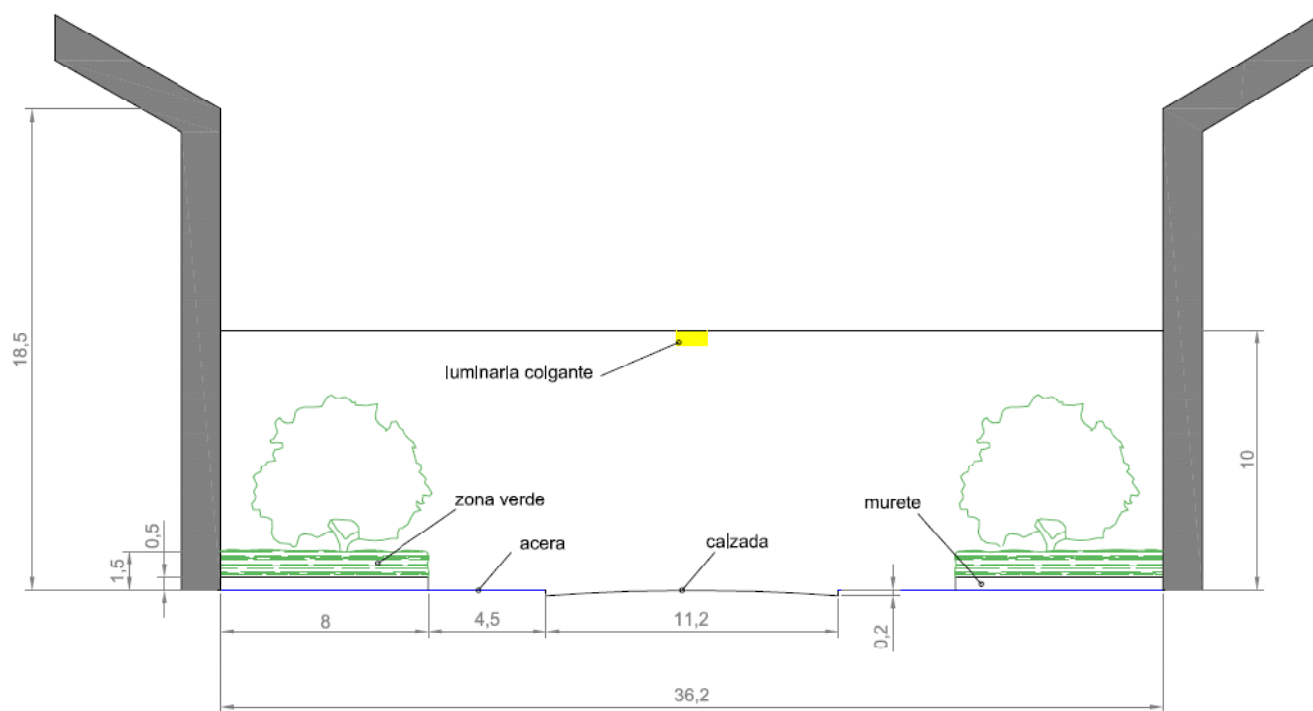

C/ BOLESLAWA SMIALEGO



ADJACENT BUILDING PICTURES



PICTURES OF BUILDINGS



Facade





Left profile



Secondary access

Right profile



Principal access

OLD DRAWING OF ELEVATION

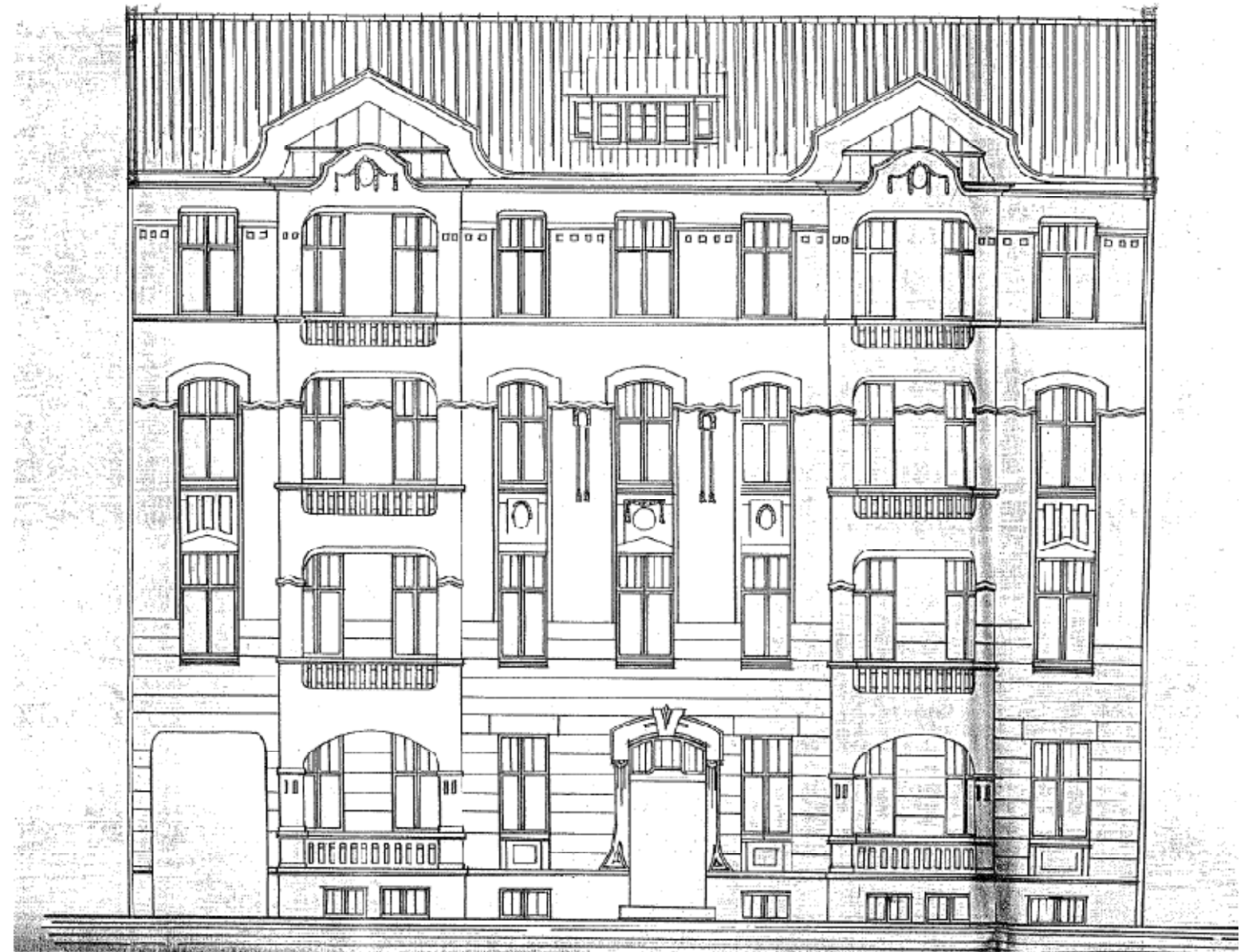

Bay window



Bay window



5.2 Constructive analysis of the building

TYPOLOGY AND DESCRIPTIVE STUDY OF THE FACADE

PRINCIPAL FACADE



Distribution of the openings in the facade:

Symmetrical facade, removing a gap for the rolled access in ground floor.

Principal access: It is the narrowest one and is in central position of the facade. It is pedestrian opening of 1.7x2.6 m with a rectilinear form and there is a frame with shape of arch, which gains access to the hall, where it will go over to the housings by stairs.

Secondary access: In the right part at ground floor we find the secondary one for rolled access, an opening of 2.5x3.75 m, where it is possible to gain access to the closed apple which it is part.

Bay windows: Of the front two lookouts stand out dividing this way the front in three cloths.

Opening in bay windows:

Frontal face: 8x2.75x2.20 m

Side Face: 16x1x2.20 m

Rest of opening:

Opening for plant: 9x1x2m

Opening in garret: There are two in the shape of semicircle in both sides of the bay window and one rectangular form of tripartite window in the central part.

Semicellar hollows: Two blocks to protect from ingress of water are not well resolved.

FACADE STRUCTURE:

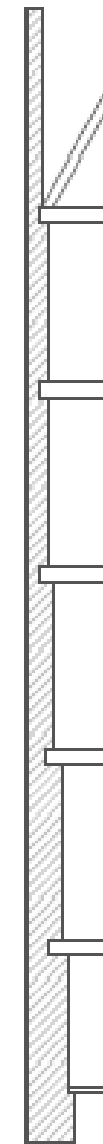

This facade closing is realized by massive ceramic brick and cement mortar. The dimension of the brick are 24x12x7 cm. The thickness diminishes in every plant. In the plant semicellar the wall is 77 cm of thickness, in ground floor it reaches 66 cm, in the first plant 60cm, going so far as to become closer up to 47 cm of the second plant that extend in two following heights.



SOLUTION OF OPENINGS:

We could have analyzed the solution for the absence of mortar in the front.

Lintels: they were solved placing the bricks in different direction for work like an arch.

Sill: there are a few frames of cement mortar where a metallic sheet rests to protect to the bricks of the sill of the weather, avoiding the wear.

Detail of lintel

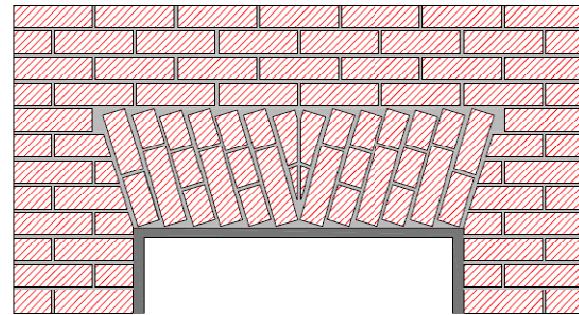

Detail of sill



Detail of lime mortar :

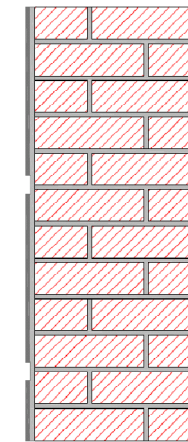

USED SOLUTION

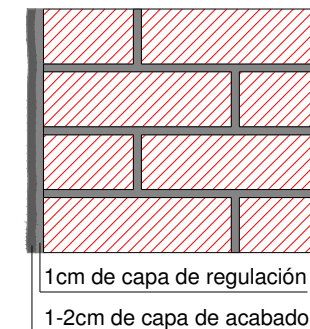

CURRENT SOLUTION

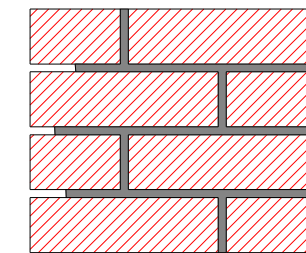

REVTMENT OF THE FACADE:

The facade of this building has two types of revetment:

Lime plaster: The above mentioned closing is covered by lime mortar in practically the whole front. In ground floor the mortar has given false veneering of stone, while in the following plants it appears in thick plaster, giving a coarse aspect.

Revetment with tile: The central area in the third plant, that it is covered with the same tiles used in the roof.

DECORATIVES ELEMENTS IN THE FACADE:

In the bay windows there are some decorative elements about the openings and someone in the central area. These were realized by lime mortar with finished smoother than the rest of the facade.

Framing the door there is a frame. This one also realized against the same material, and shape of semicircular arch.

In all the facade we can only find a cornice in the central area, separating the finished of tiles about the mortar one. In the top of the rolled access we find a semicircular arch that is solved by the same brick as the rest of the facade and then covered by mortar.



PICTURES:





STRUCTURES

According to the constructive methodology of the epoch, the visual analysis and the study of the opposing old projects we can deduce that the horizontal structure it is formed for framework in one direction that they support on walls of load and some isolated support that form the vertical structure.

The foundation of the building is solved of strip foundation covered under wall and isolated footing under the supports.

The walls of load and the isolated supports are the vertical structure. They are formed by massive ceramic brick of 24x12x7cm. The walls are taking thickness when they wins height, taking from 77cm in ground floor up to 38 cm in the last plant.

The horizontal structure rests on the walls of load and the isolated supports. There are two types of frameworks in the building.

Ground floor's framework is solved by metallic beams, the beam fill space is of ceramic brick refilled with a pasta of mortar and debris.

In the rest of frameworks, the beams are formed by wood of big size that they rest on the load walls. On these, rest the wooden small beams. The space of beams fill is refilled by a paste formed with a mixture of clay and sawdust. Once it dries, wooden strips of wood were placed and above a wooden boarding that was forming the parquet.

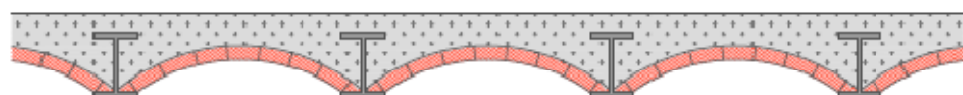
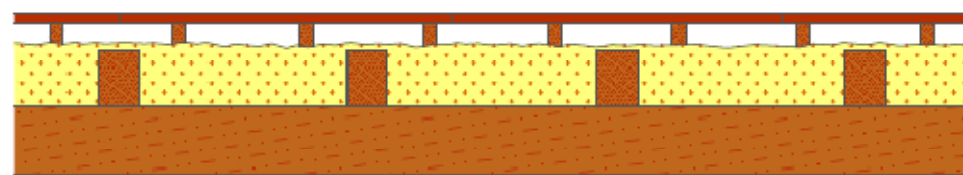

ANALYSIS OF CANTILEVER.

The facade consists of two courses of bay windows from level zero and come up to the roof, taking also the garret. These bay windows are formed by the extension of the one direction frameworks of every plant. The small joist continue the direction of the frameworks, perpendicular to the plane of the facade and rest on a beam or lintel that unloads his weight on the supports that form the bay window. The closing was made with massive ceramic brick of 24x12x7 cm and covered with lime mortar.

There isn't any cantilever in the facade.

MATERIALS USED

MATERIALS NAMES	DESCRIPTION	ZONE
Bricks	Massive ceramic brick of 24x12x7	Facade closing
Plaster	Cement mortar	Coating of facade closing
Wood	Beams of massive wood.	Horizontal structure (framework tipo 1)
Paste	mixture of clay and sawdust	Beam fill in horizontal structure (framework tipo 1)
Wooden slats	Wooden slats that forms the parquet	Horizontal structure (framework tipo 1)
Metallic joist	Steel section IPE	Horizontal structure (framework tipo 1)
Poor mortar	Paste make of mortar and debris.	Beam fill in Horizontal structure (framework tipo 2)
Thin hollow brick	Thin hollow brick of ceramic	Horizontal structure (framework tipo 2)
Metallic sheet	Metallic sheets of 3mm tickness	Sills
Limestone veneering	Veneering of limestone 2cm tickness	Sills



5.3 Problems of the building

File 7.1: Degradation of the lime mortar

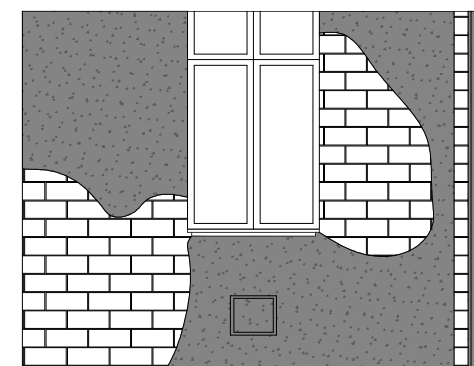
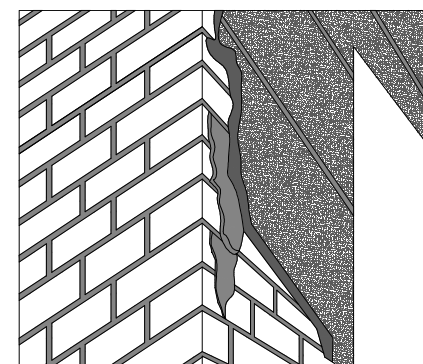
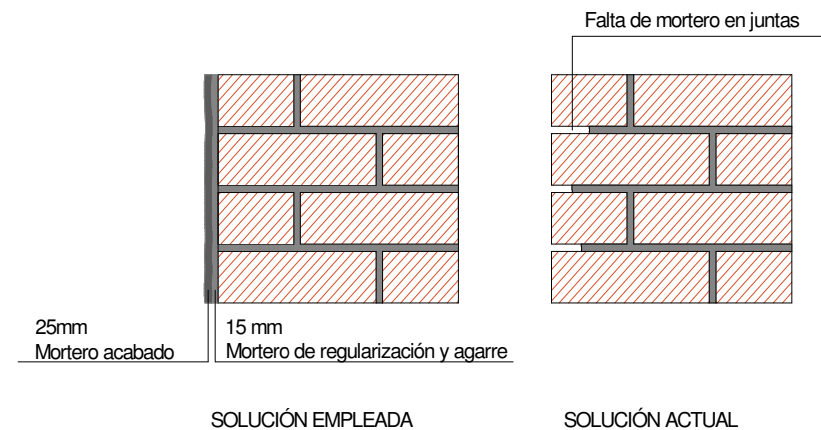

Description of Symptoms

In this facade there is a big degradation of the lime mortar used like vertical revetment. It is in more than 50 % of the entire facade surface, as it is possible to see in the drawing and the pictures, the recovering is completely absent, leaving exposed brick. In some areas, part of the decorative elements are incomplete, because also they have disintegrated. The mortar that is still in his place is much degraded. The revetment presents a porous and darkened aspect.

Possible Causes

The loss of mortar can have been caused by the simple degradation of the mortar that is of low quality and has decomposed with the step of the years. The low quality of the mortar added with the meteorological inclemencies and the absence of conservation in all his useful life has provoked an increase of the porosity in the mortar. In these pores there settles the water that with his changes of temperature provokes an increase of size in the cavities what facilitates the deposition of particles of dust and contamination. This contamination has provoked the darkening of the facade. In the areas where it is missing the revetment there is also lacking in mortar of joints. The water wears out the mortar of grip used in bindings the bricks.



5.3 Problems of the buildings.

File 7.2: Degradation of the cornices

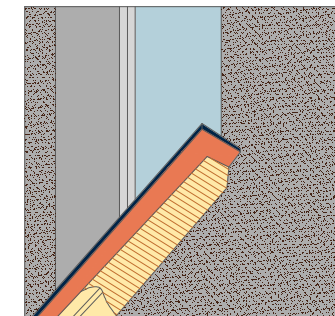
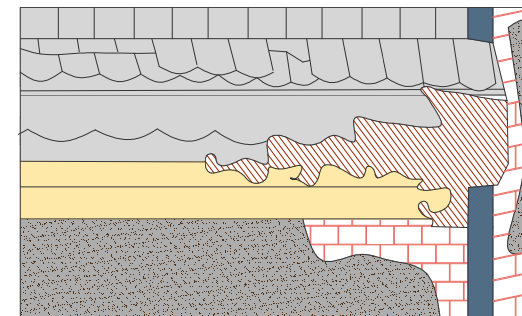
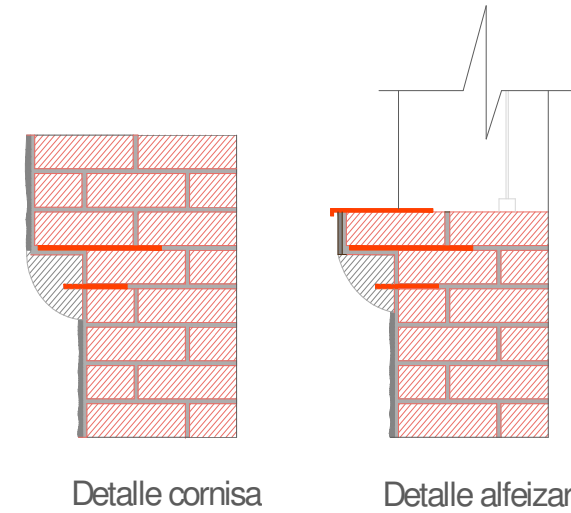

Description of Symptoms

In this front there is a big detachment of most of the existing cornices. In almost all of them, the bricks that were forming the cornices are exposed. The same way the sheet used to support them. There does not stay anything of the frame that was giving the final score of the cornice, not either of the mortar used as finished end.

As for the sills in the windows, they are very damaged. The sheet that they were serving of ledge is completely convex and rusty.

Possible causes

The low quality of the mortar used in the plaster of the revetment joined few conservation of the front during the useful life of the building, has provoked the entire loss of this one in almost the whole front.

The moisture attacks the metallic elements used in the support of the cornices provoking his size increase for oxidation. The trims have become detached, as some bricks that were forming the cornices.

Constructive analysis

The cornices and the sills in the hollows were solved by the same method.

At a height of the cornices, there are placed between the mortar joints a few metallic sheets that it serves of support to the bricks that going out of the facade line give form to the cornices. Under these bricks and by means of metallic elements there get hooked up the frames that give the final form to the cornice.



5.3 Problems of the building

File 7.1: Degradation of the carpentry.



Description of symptoms

In the front the used windows are of wood with a layer of white painting. The general model of the windows is for parts of two tiers. Some of them have been restored. Some bay windows have placed carpentries making the front slightly homogeneous

Possible causes

The wood of the carpentry has a big wear caused by the absence of care by the users during the useful life of the building added with inclement weather. The wood to the contact with the water expands and has made to jump the painting.

Detail of carpentry

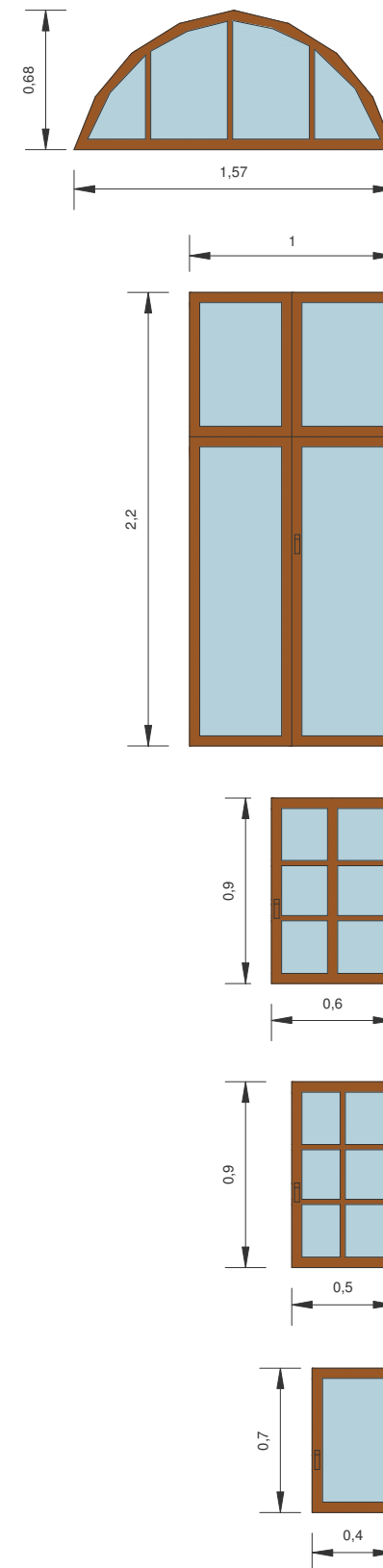



5.4 Restoration proposals.

File 7.1: Degradation of lime mortar

As solution to this pathology we propose the entire replacement of the lime mortar used in the facade for a cement mortar of better quality. Also one will proceed to the cleanliness of the bricks and joints that form the wall. After that we restore the grip mortar and to plaster again the facade. With this, we will prevent the dirt from provoking damages to the new revetment.

Programation for Repair

- 1º_ Stung of lime plaster, applied on vertical exterior facade, with manual means, eliminating it completely without spoiling the surface support that it will stay to the overdraft.
- 2º_ Mechanical cleanliness of the facade by projection of water atomized spray to low pressure. Withdrawing the impurities that exist and preparing the facade for the new revetment.
- 3º_ First layer of mortar lower quality than 1 cm thick.
- 4º_ Second layer of mortar on highest quality 1 to 2 cm thick, molded carrying characteristic of each zone
- 5º_ Priming a layer of plastic painting that it protects against the inclement weather

Details of mortar

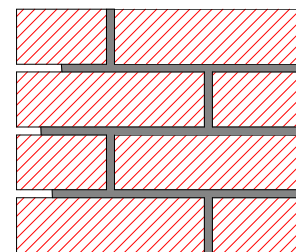
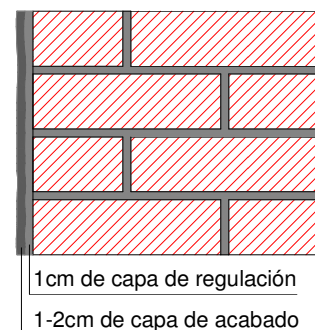

File 7.2: Degradation of cornices

The cornices that present detachments will be realized in workshop by cast molds to image the original ones to place it in his place. In the cornices where the brick that gives form are very worn-out, will be stung to replace it. Also there will be realized the replacement of the metallic elements that serve as sustenance.

The cornices that present cracks repairer will place a mesh and they will be refilled by resin repairer.

Programation for Repair

- 1º_ Delimitation and retreat of the cornices in bad state.
- 2º_ Elimination of the bricks that give form to the cornice and that are in bad state, and also of the metallic claws that serve as sustenance.
- 3º_ Collocation the new metallic claws and new the bricks.
- 4º_ Collocation the new piece of cornice.
- 5º_ Cleanliness and filling the cracks by repaire resins.
- 6º_ Collocation of the repairer mesh in union areas between new cornices and old cornices.
- 7º_ Layer of plastic painting for protection.

Details of cornices

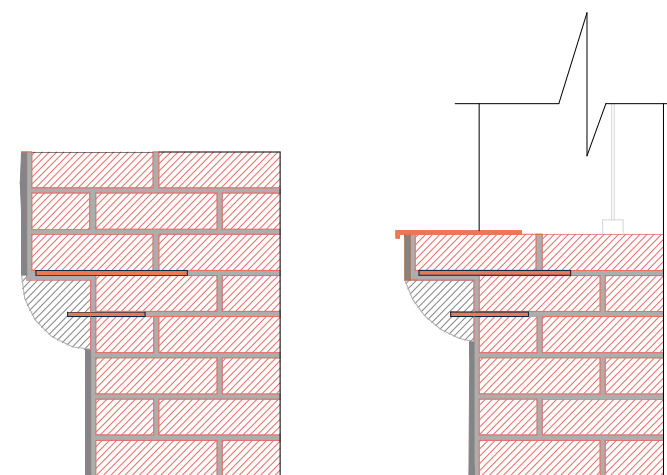

Details os Craks repair

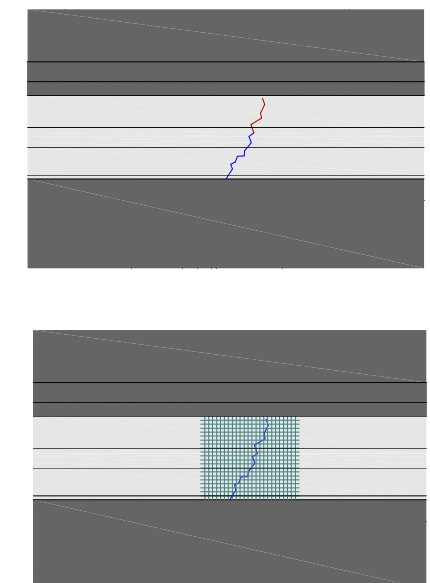



5.4 Restoration proposals.

File 7.3: Degradation of the carpentry.

There will be realized the entire replacement of the current carpentry of the building, so much the restored ones at present like which not. With this we try to follow the same line in the aspect of all the facade. The used carpentry will be of wood with glazing of double layer for a major isolation, also the wood will be covered with a painting or varnish that protects from the external agents.

Detail of new carpentry

Type 1

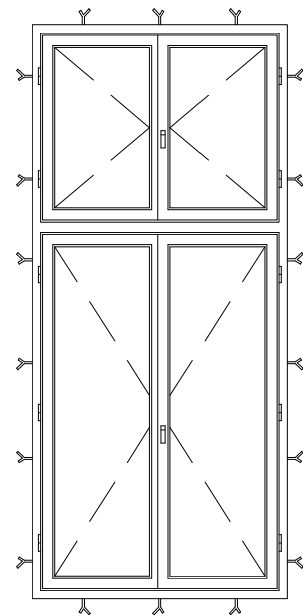

Alzado

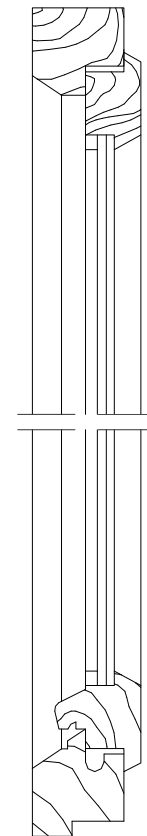

Seccion vertical

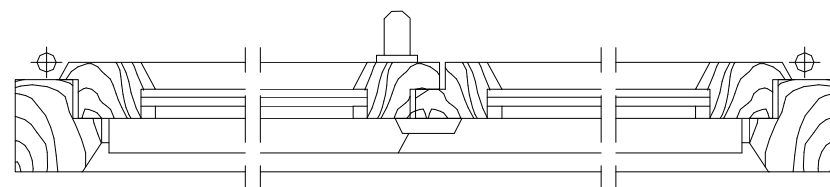

Seccion horizontal



5.4 Restoration proposals

Restorated facade





5.4 Restoration proposals.

File 7.3: Degradation of the carpentry.

There will be realized the entire replacement of the current carpentry of the building, so much the restored ones at present like which not. With this we try to follow the same line in the aspect of all the facade. The used carpentry will be of wood with glazing of double layer for a major isolation, also the wood will be covered with a painting or varnish that protects from the external agents.

Detail of new carpentry

Type 1

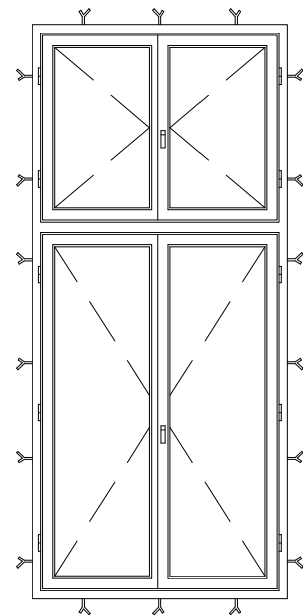

Alzado

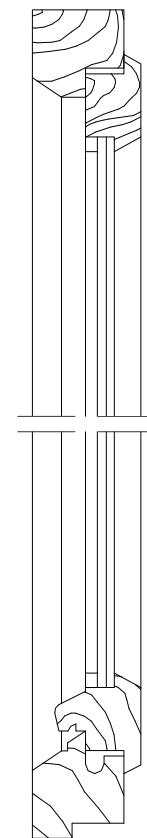

Seccion vertical

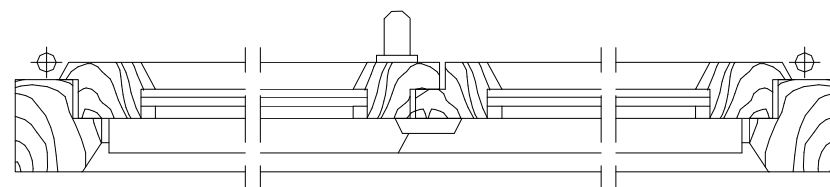

Seccion horizontal



5.4 Restoration proposals

Restorated facade



5.5 Restoration of gardens

Original model

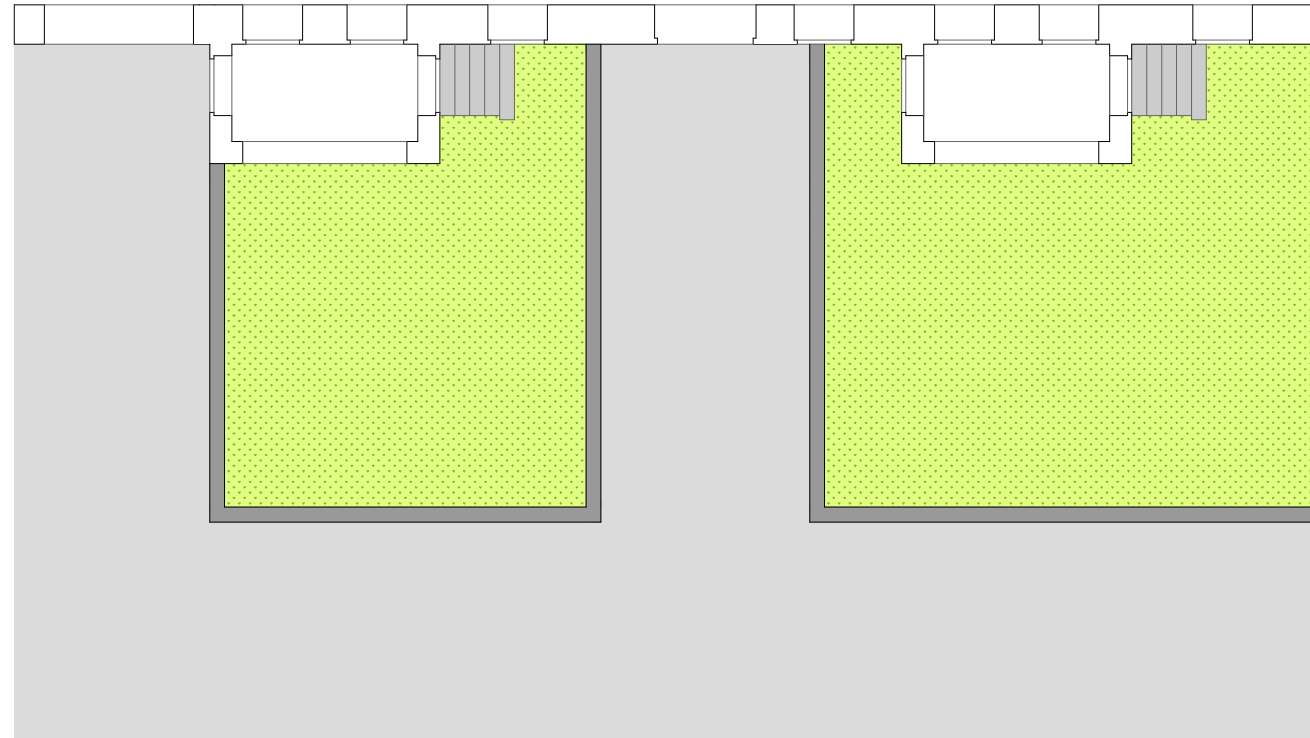

Analysis of problems



Description of the symptoms

The perimeter wall that surrounds the landscaped area of the building is realized by massive ceramic brick and a recovering of mortar of lime. The above mentioned wall has a big number of cracks in all his length that in some cases reach more than one centimeter of thickness. Also, in some areas these cracks have provoked detachments of a considerable size. The garden is formed of a line of firs that surrounds the area, and three trees distributed randomly.



5.5 Restoration of gardens

Restored model

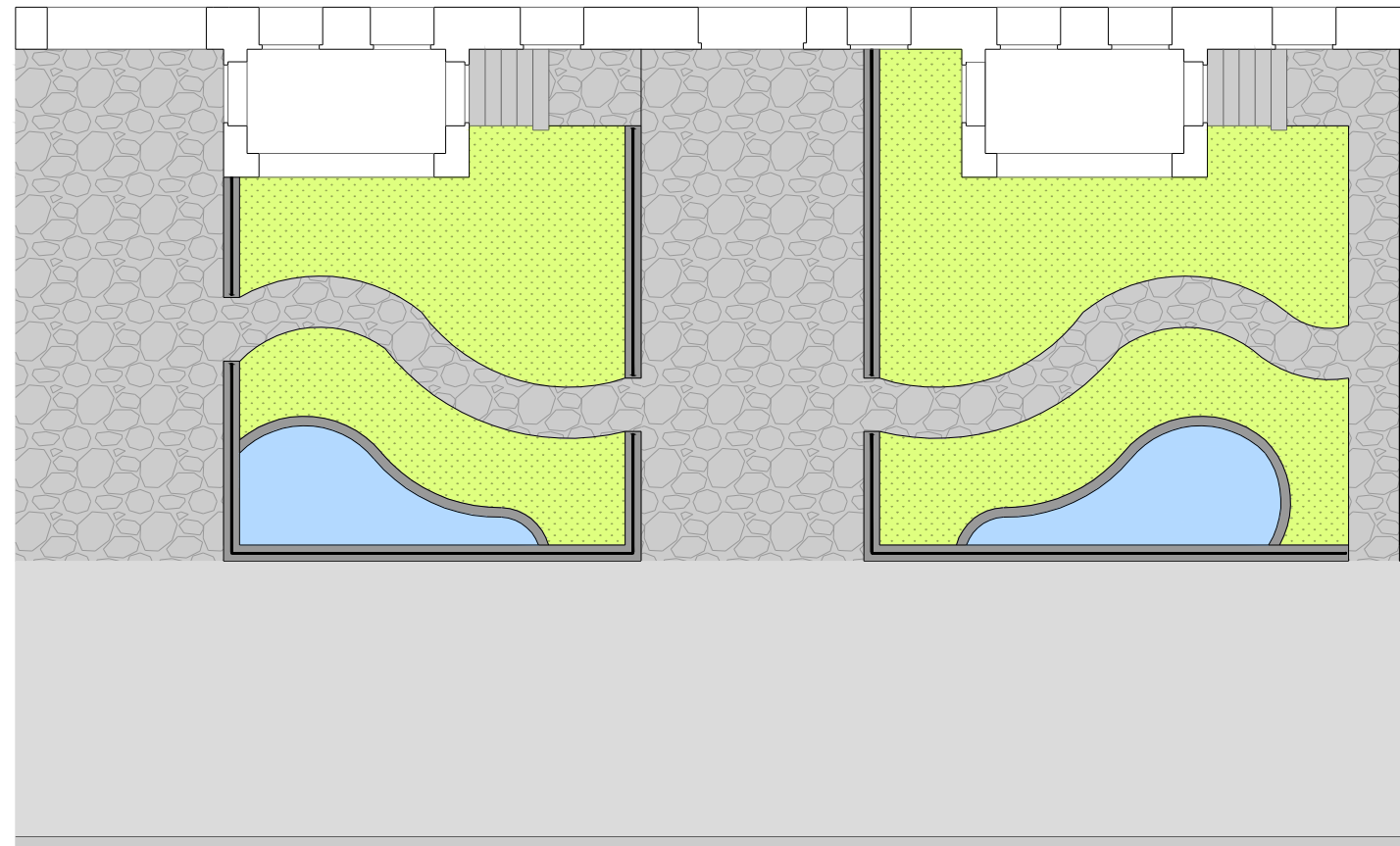

Description of the intervention:

The intervention is based on the replacement completely of the perimeter wall, due to its bad conservation state, and of the firs that surround some parts of the landscaped area. The new wall will be realized with massive ceramic bricks (24x11'5x7 cm), of 24 cm of thickness. This wall will support a metallic fence 50 cm high of wrought steel, with a recovering of plastic painting that protects it against the meteorological inclemencies. In both areas of the garden there will be placed a water pond, which will be surrounded with lawn. Two accesses of the building and the ways of the garden will be realized by a stone pavement

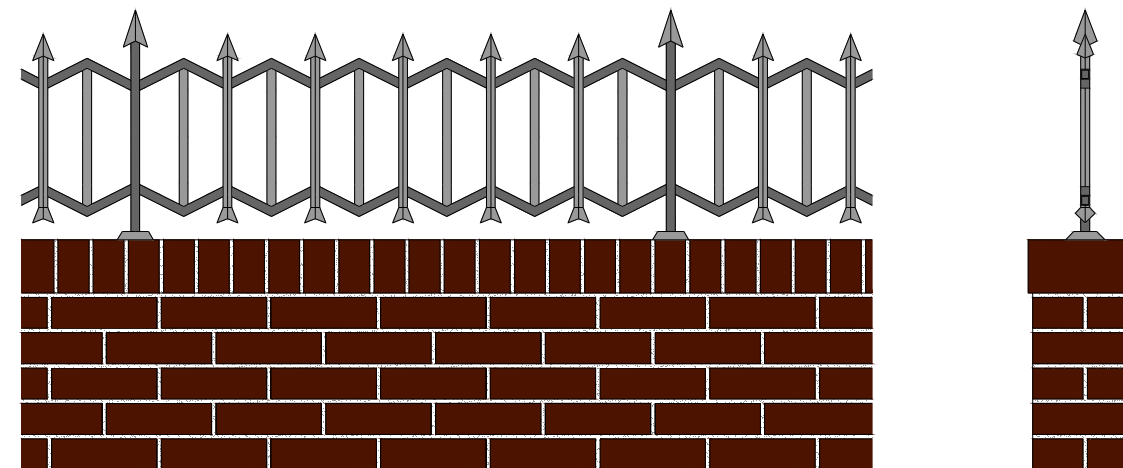



6. PROJECT OF RESTORATION BUILDING 44

6.1 Study and architectural analysis

USO OF THE BUILDING.

Residential

DESCRIPTION OF THE BUILDING C / BOLESŁAWA SMIAŁEGO 44

LOCATION: The building is placed in the western rim of the center of the city. More specifically it is located in the quarter Turzyn. This quarter is in the central district of the city called Centrum.

MAP OF SZCZECIN

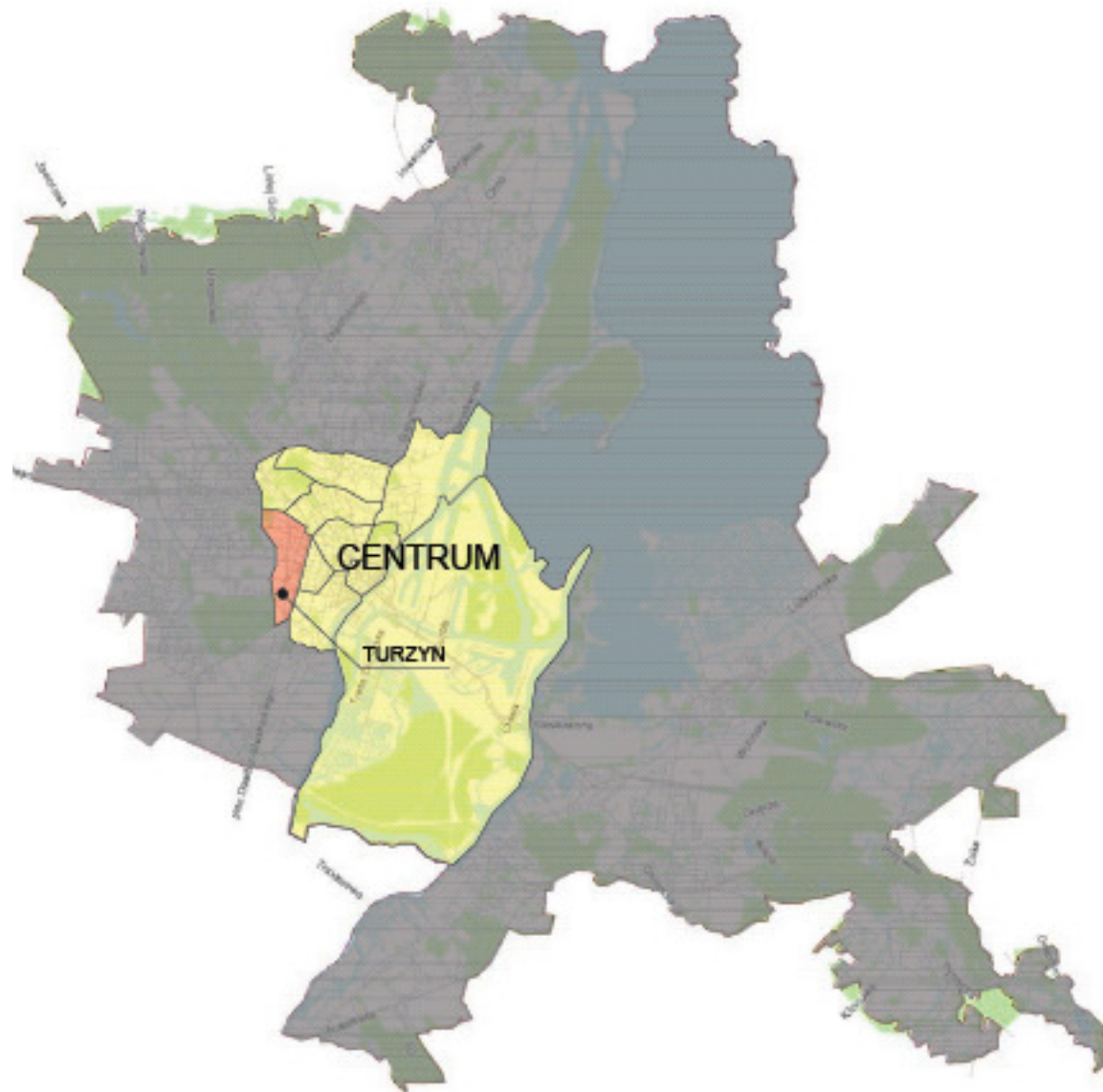

TURZYN



Building between two part walls of c / Bolesława Smiałego of the quarter commented previously. In this street the buildings have the same height of approximately 19 meters, they all are residential ones destining the first floors some of them to commercial areas.

The C / Bolesława Smiałego takes sidewalks as both sides and double rail for vehicles transit.



PICTURES AND SECTION ABOUT THE STREET



PRINCIPAL CHARACTERISTICS

- Residential building of first floor, three plants type more garret.
- Principal access in the center of the facade, the opening have the dimensions: 2.5x3.9m
- The openings are rectilinear of windows of two tiers and four parts.
- Dimensions of elevation: 21.4x19.97m

HISTORICAL SUMMARY OF THE BUILDING

The building was projected in the year 1902 to begin being constructed in 1904. The works were interrupted by the First World war, being finished in the year 1938. This has provoked that the current result of the building does not coincide exactly with projected in the beginning, having suffered some changes in the front. As most of the buildings that we find in this street have more or less the same height, the modernist movement, using a big quantity of cornices and forms in the facade.

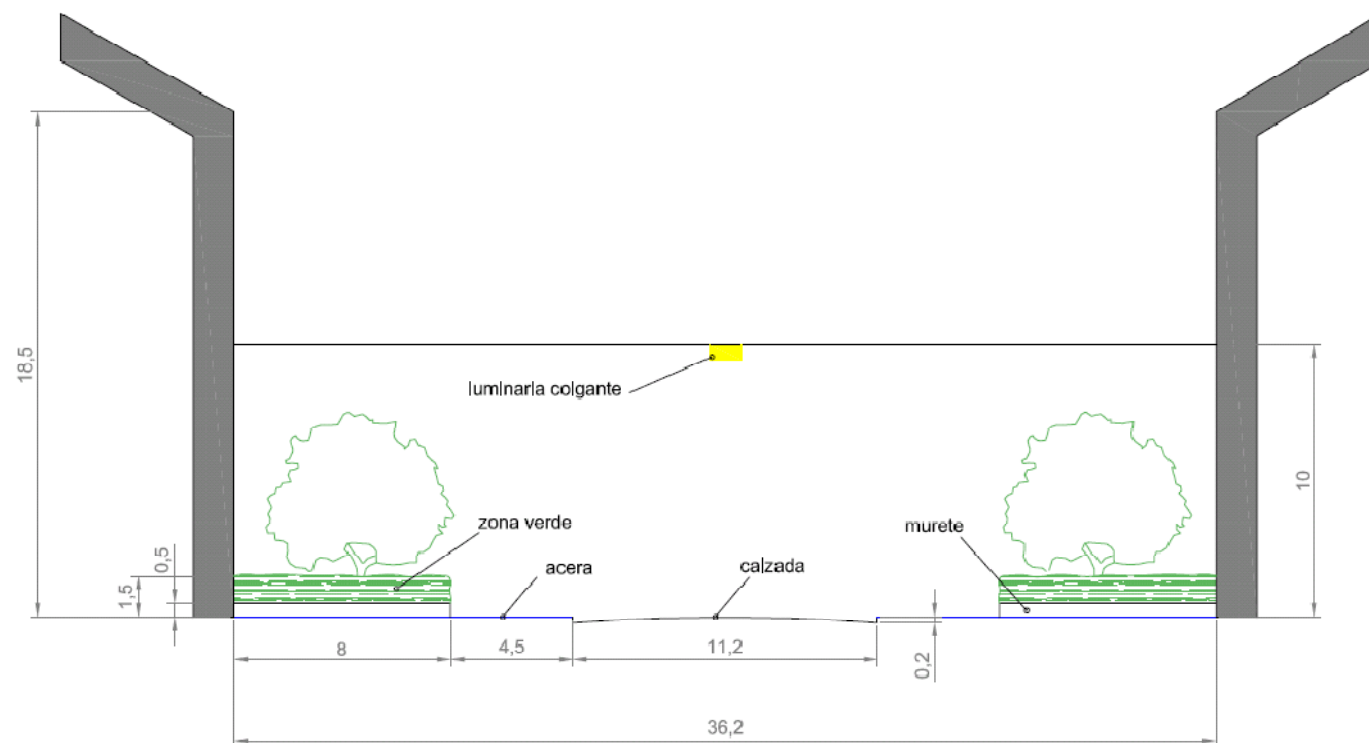

C/ BOLESŁAWA SMIAŁEGO



ADJACENTS BUILDINGS PICTURES



BUILDING PICTURES



Principal facade



Bay Window's top



Floor 3º



Details



Bay window's details



Floor 2º



reformed area



Decoratives elements



6.2. Analysis constructico of the building.

TYOLOGY AND DESCRIPTIVE STUDY OF THE FACADE

PRINCIPAL FACADE



Openings in bay windows:

Frontal face: 3x1.2x2 m and 1x0.8x1.9m finished in the top with oval form

Side face: 6x0.6x2 m

Rest of opening:

Type plant: 3x9x1x2m

Mezzanine: 8x1x2m

Openings in garret: 2x0.5x0.5

COMPOSITION OF THE FACADE:

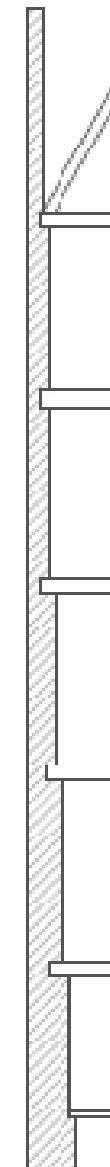

The facade closing is realized by massive ceramic brick of 24x12x7cm, and cement mortar. The thickness of the wall is variable. In the semicellar plant the wall reaches 77cm of thickness and in the ground floor 64cm. In the first plant the thickness of the wall diminishes to 51cm, and in the rest 38cm.

Distribution of openings in facade:

Principal access: It's in the center of the facade. The opening's dimensions are 2.5x3.8m.

Commercial lows in ground floor: We find a consultancy occupying the semicellar and the mezzanine in the right part of facade.

Bay window: There is one bay windows that divided the faced in three parts. The bay window occupies the central part of the facade beginning from level zero up to the covering.



SOLUTION OF OPENINGS:

Lintels: were solved laying the bricks to other way, making it work of similar form to an arch.

Sills: there was used a veneering of limestone that was covered with a metallic sheet for the protection from the atmospheric agents. According to the methodology used in the epoch, we deduce also that the semicircular arches of the principal earnings, are solved by ceramic brick.

Lintel's detail:

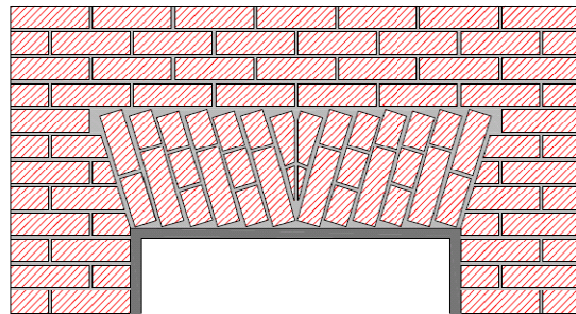

Sill's picture:

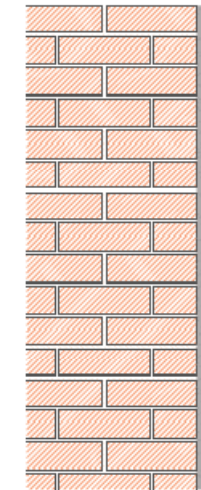

REVTMENT OF THE FACADE:

The facade just presents a type of revetment:

Lime plaster: In ground floor, the mortar has a form of false vereering of stone in smooth, while in the following plants it appears without form.



DECORATIVE ELEMENTS OF THE FACADE:

In the bay windows there are two vertical tiers simulating columns, one to every side of the hollows.

On the openings of the second floor we find floral details framed in a rectangular frame. Also **floral figures** on the openings of third floor, under these there are a few cornices with pyramidal form.

Cornices: we find four longitudinal cornices that are coincident with the singing of frameworks. We find small cornices in the sills of the openings. On of that is placed a metallic sheet of protection to the frame.

In ground floor, the windows are surrounded by a cornice in the top part and the wings. There are a frame simulating the voussoir of an arch. Under the cornice of the last framework there are decorative elements forming small pointed arches in the roof.



PICTURES:





STRUCTURES.

Basing on the constructive methodology of the epoch, the consulted projects and the visual analysis, we deduce that the horizontal structure is formed by frameworks that works in one direction. The vertical structure is formed by walls of load and some isolated support.

The vertical structure is realized by massive ceramic brick of 24x12x7cm. The load walls reduce his thickness as they climb of plant, in the semicellar floor has 77 cm of thickness and 38 cm in the last one.

The horizontal structure is realized by beam of big size that are formed by wood. They support the wooden small beams and rest on the load walls. The beam fill space is refilled by a paste formed with a mixture of clay and sawdust, much used in the epoch. When the paste is dry, wooden strips of wood were placed and then nailed the wooden that forms the parquet. The framework of cellar it was realized of different form. In this case the girders and the small beams are metallic. The beam fill space is realized by a brick and filled with a paste of mortar and debris.

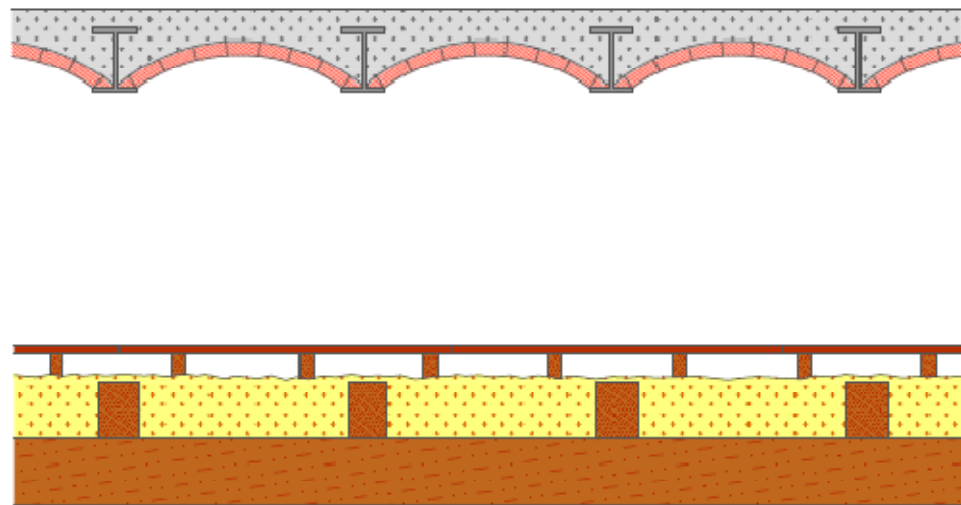

ANALYSIS OF CANTILEVERS

In the facade we find two tiers of three cantilever, one to every part of the bay window. Every cantilever are agree with framework of the three type floors. There is a metallic rail for protection from the falls that reaches a 0.9 m height.

The cantilever are formed for:

- Metallic small joist, IPE 160, which continue the direction of the framework, perpendicular to the plane of facade.
- Metallic beam, IPE 180, as bundle hoop.
- Vault of small format in the beam fill.

In the balcony of the ground floor exists a small wall that provides a trapezium form.

Cantilever's pictures:



*MATERIALS USED*

MATERIALS NAMES	DESCRIPTION	ZONE
Bricks	Massive ceramic brick of 24x12x7	Facade closing
Plaster	Lime mortar	Coating of facade closing
Wood	Beams of massive wood.	Horizontal structure (framework tipo 1)
Paste	mixture of clay and sawdust	Beam fill in horizontal structure (framework tipo 1)
Wooden slats	Wooden slats that forms the parquet	Horizontal structure (framework tipo 1)
Metallic joist	Steel section IPE	Horizontal structure (framework tipo 1)
Poor mortar	Paste make of mortar and debris.	Beam fill in Horizontal structure (framework tipo 2)
Thin hollow brick	Thin hollow brick of ceramic	Horizontal structure (framework tipo 2)
IPE 160	Steel section	Cantilever
IPE 180	Steel section	Cantilever
Steel section	Steel section of 0,5 mm tickness	Lintels
Metallic sheet	Metallic sheets of 3mm tickness	Sills
Limestone veneering	Veneering of limestone 2cm tickness	Sills



6.3 Problems of the building

File 44.1: Degradation of lime mortar



SOLUCIÓN EMPLEADA

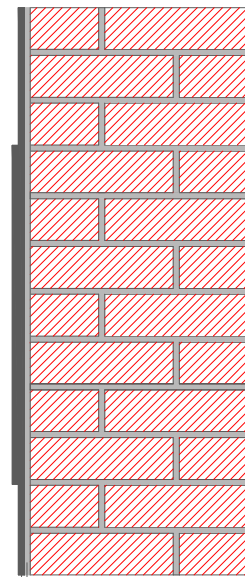

1cm capa mortero de agarre

1 - 2cm capa mortero de acabado

SOLUCIÓN ACTUAL

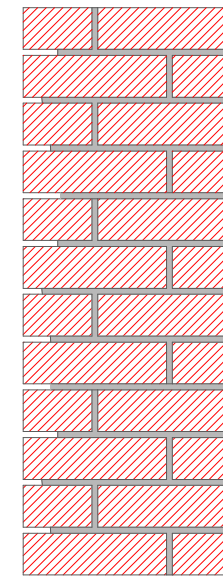

Description of Symptoms

In the previous scheme it is possible to appreciate that the mortar of lime used as plaster in the revetment of the front presents the bad state. There is big quantity of areas where the mortar has become detached completely leaving the bricks exposed to the inclement weather. The mortar that is still in the surface, has a dirty color. The left low area of the facade is already restored.

Possible causes

This problem can have been caused by the bad quality of the mortar joined little care of the users during the useful life and the meteorological inclemencies of the area. The mortar has gone disintegrating leaving to the air the bricks. The black color stems from the moisture and the contamination of the streets that have provoked that the particles place the pores of the mortar giving him a dirty color.





6.3 Problems of buildings

File 44.2: Degradation of the cornices

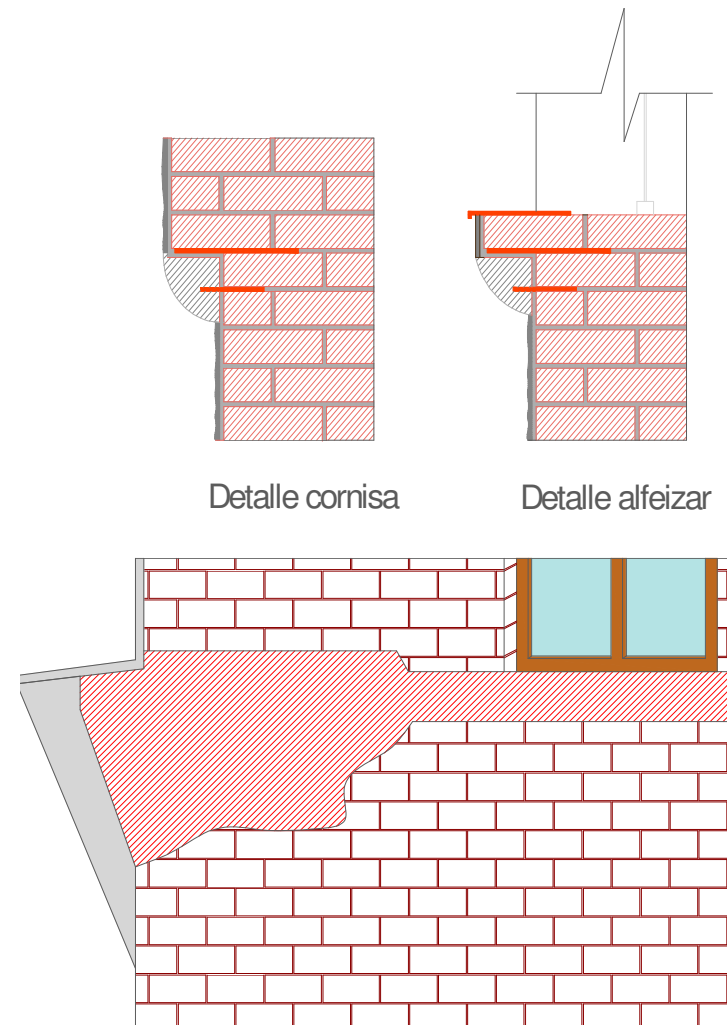

Description of symptoms

In this front there is an important deterioration. In almost all of them, the bricks that were forming the cornices has left exposed to the inclement weather. There is seen the sheet used for the grip of the frames of finished because these have disintegrated. For the sills in the windows, they are very damaged.

Constructive Analysis

The cornices and the sills in the hollows were solved by the same method.

At a height of the cornices, there are placed between the mortar joints a few metallic sheets that it serves of support to the bricks that going out of the facade line give form to the cornices. Under these bricks and by means of metallic elements there get hooked up the frames that give the final form to the cornice.

Possible Causes

The low quality of the mortar used in the plaster of the revetment joined few conservation of the front during the useful life of the building, has provoked the entire loss of this one in almost the whole front.

The moisture attacks the metallic elements used in the support of the cornices provoking his size increase for oxidation. The trims have become detached, as some bricks that were forming the cornices.



6.3 Problems of the building

File 44.1: Corrosion cantilever joist

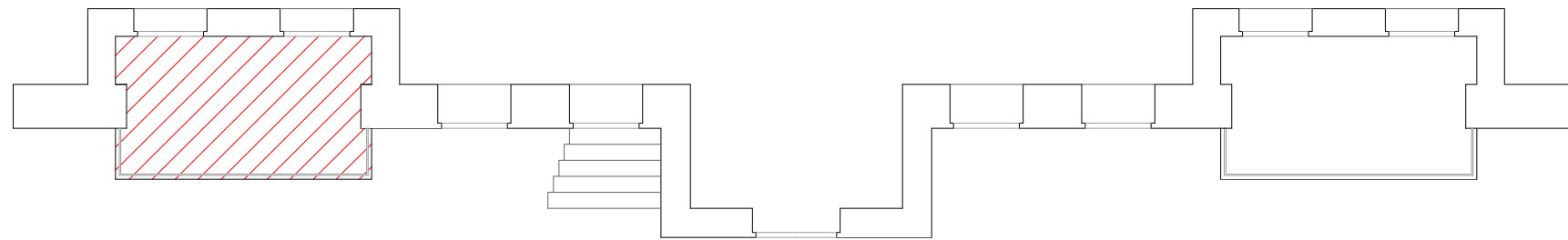

FIRST FLOOR SECTION

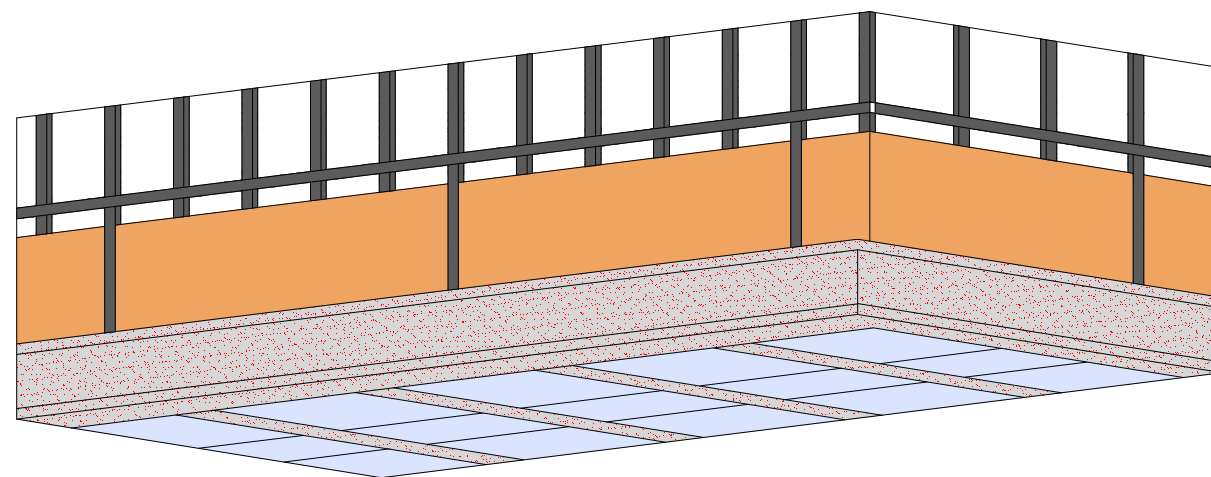

DETAIL OF CANTILEVER

Description of symptoms

In this front, there is one cantilever in bad state, because the rest are already restored.

It is the cantilever of the first floor in the left part and it has a detachment of the final revetment and corrosion in the joist that form this cantilever. The oxide provokes an increase of size of the material, this increase provokes the detachment of the plaster.

The rails are misshapen and it has oxide in all the cantilevers of the facade. The worst zone is the connection of the rail with the framework strap.





6.4 Restoration proposal

File 44.1: Degradation of lime mortar.

As solution to this pathology we propose the entire replacement of the lime mortar used in the facade for a cement mortar of better quality. Also one will proceed to the cleanliness of the bricks and joints that form the wall. After that we restore the grip mortar and to plaster again the facade. With this, we will prevent the dirt from provoking damages to the new revetment.

Programation fo Repair

1º_ Stung of lime plaster, applied on vertical exterior facade, with manual means, eliminating it completely without spoiling the surface support that it will stay to the overdraft.

2º_ Mechanical cleanliness of the facade by projection of water atomized spray to low pressure. Withdrawing the impurities that exist and preparing the facade for the new revetment.

3º_ First layer of mortar lower quality than 1 cm thick.

4º_ Second layer of mortar on highest quality 1 to 2 cm thick, molded carrying characteristic of each zone

5º_ Priming a layer of plastic painting that it protects against the inclement weather

SOLUCIÓN EMPLEADA

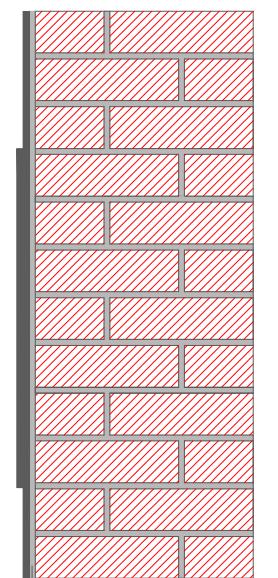

1cm capa mortero de agarre
1- 2cm capa mortero de acabado

SOLUCIÓN ACTUAL

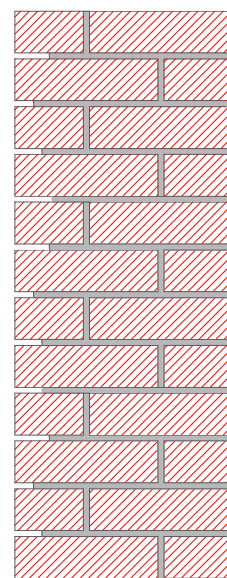

Ficha 44.2: Degradation of the cornices.

The cornices that present detachments will be realized in workshop by cast molds to image the original ones to place it in his place. In the cornices where the brick that gives form are very worn-out, will be stung to replace it. Also there will be realized the replacement of the metallic elements that serve as sustenance.

The cornices that present cracks repairer will place a mesh and they will be refilled by resin repairer.

Programation fo Repair

1º_ Delimitation and retreat of the cornices in bad state.

2º_ Elimination of the bricks that give form to the cornice and that are in bad state, and also of the metallic claws that serve as sustenance.

3º_ Collocation the new metallic claws and new the bricks.

4º_ Collocation the new piece of cornice.

5º_ Cleanliness and filling the cracks by repaire resins.

6º_ Collocation of the repairer mesh in union areas between new cornices and old cornices.

7º_ Layer of plastic painting for protection.

Details of cornices

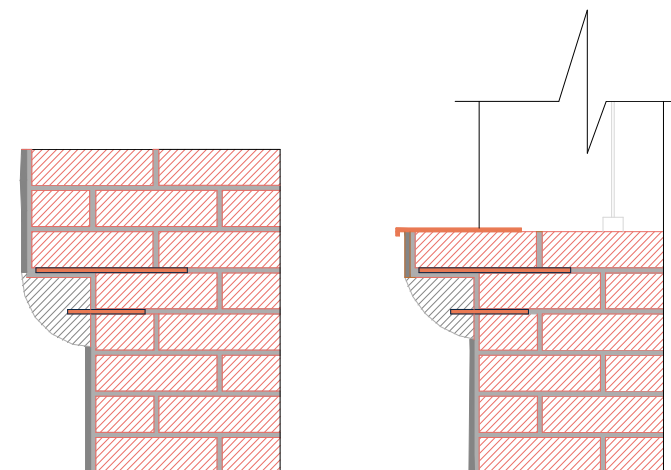

Details os Craks repair

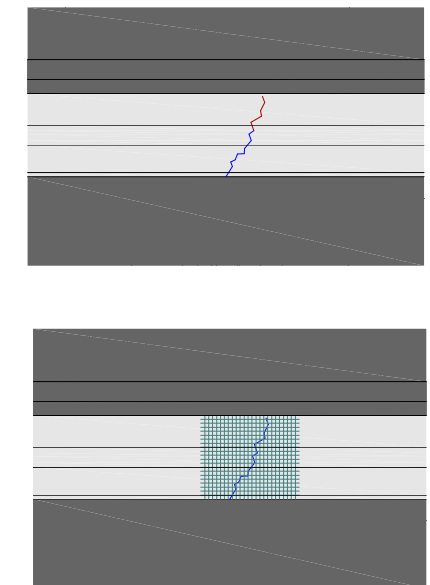



6.4 Restoration proposals

File 44.3: Corrosion cantilever joist.

We propose the elimination of the plaster used as revetment that is in the bad state. After this, the superficial cleanliness of the steel section that form the structure of the cantilever, eliminating remains of painting, the layer of lamination, the visual oxide and the strange particles of the support.

Programation for repair

- 1º_ Stung remains of lime plaster applied on the structure of cantilever with manual means, eliminating it completely without spoiling the surface support that it will stay to the overdraft.
- 2º_ Superficial cleanliness of steel sections by projection overland of an abrasive material formed by particles of aluminum silicate.
- 3º_ Application layer of antirust protection on the metallic elements.
- 4º_ Collacation of the new revetment plaster.

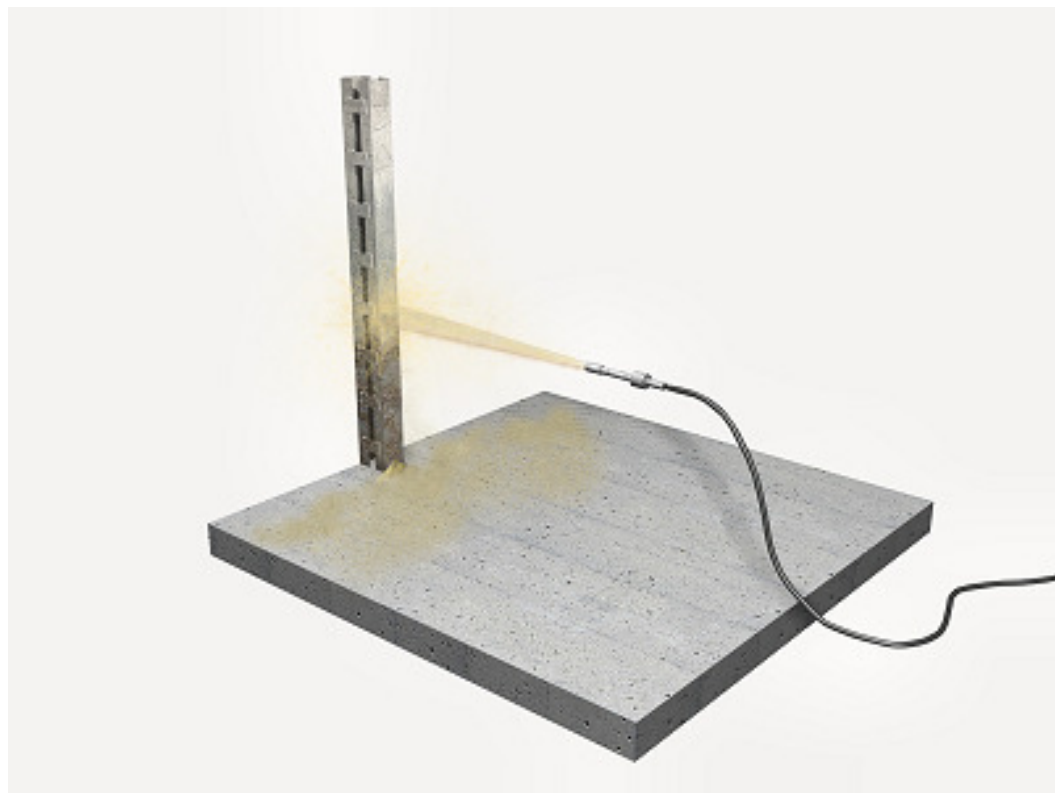

(Imagen de: www.limperfmet.com)

File 44.4: Replacement rails.

Replacement all the rails used for the protection from falls in the cantilever because most of them are bent and have oxide.

Programation for repair

- 1º_ Rails extraction, cutting the connection points of the rails with the strap of the cantilever structure.
- 2º_ Placement of the new steel handrail, fixing it properly in both the singing of the cast as the facade.
- 3º_ Application a layer of antirust painting.

RAIL IN GROUND FLOOR

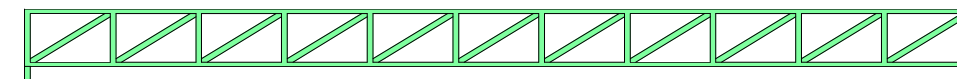

CURRENT DESIGN

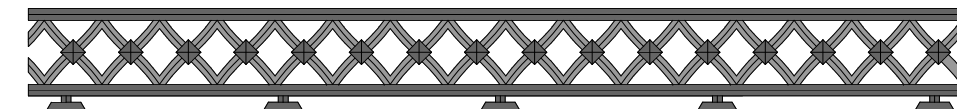

NEW DESIGN

RAILS IN TYPE PLANT

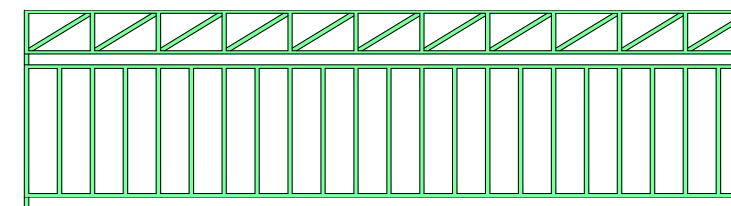

CURRENT DESIGN

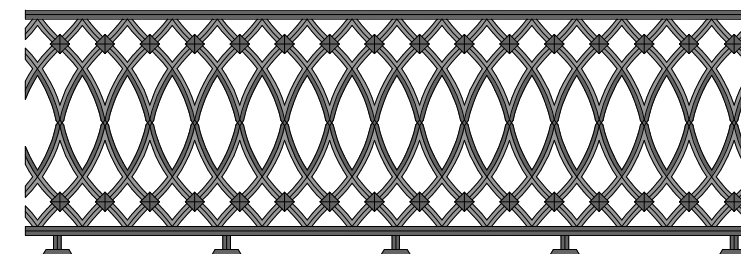

NEW DESIGN



6.4 Restoration proposal

Restored facade





6.5 Restoration of gardens

Original model

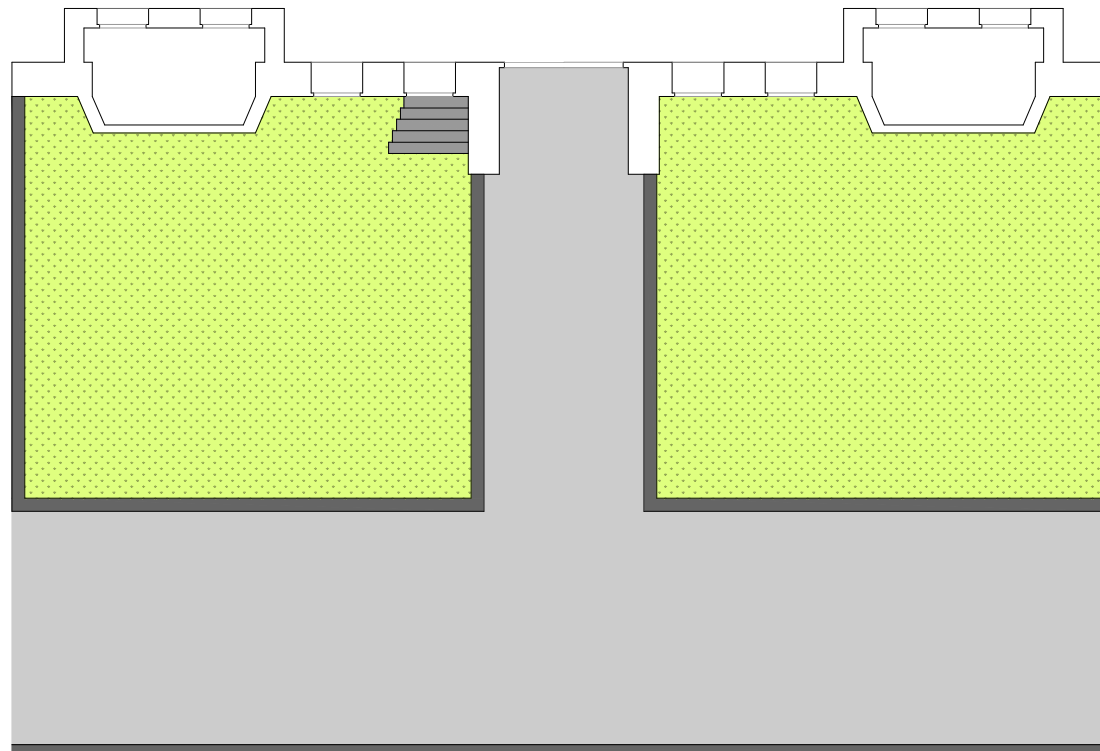

Description of the symptoms

The perimeter wall that surrounds the landscaped area of the building is realized by massive ceramic blocks and a recovering of mortar of lime. The above mentioned wall has a big number of cracks in all his length that in some cases reach more than one centimeter of thickness. Also, in some areas these cracks have provoked detachments of a considerable size. The garden it is formed by a firs line in the frontal face, and a 5 m tree in both sides of the landscaped area.



6.5 Restoration of gardens

Restored model

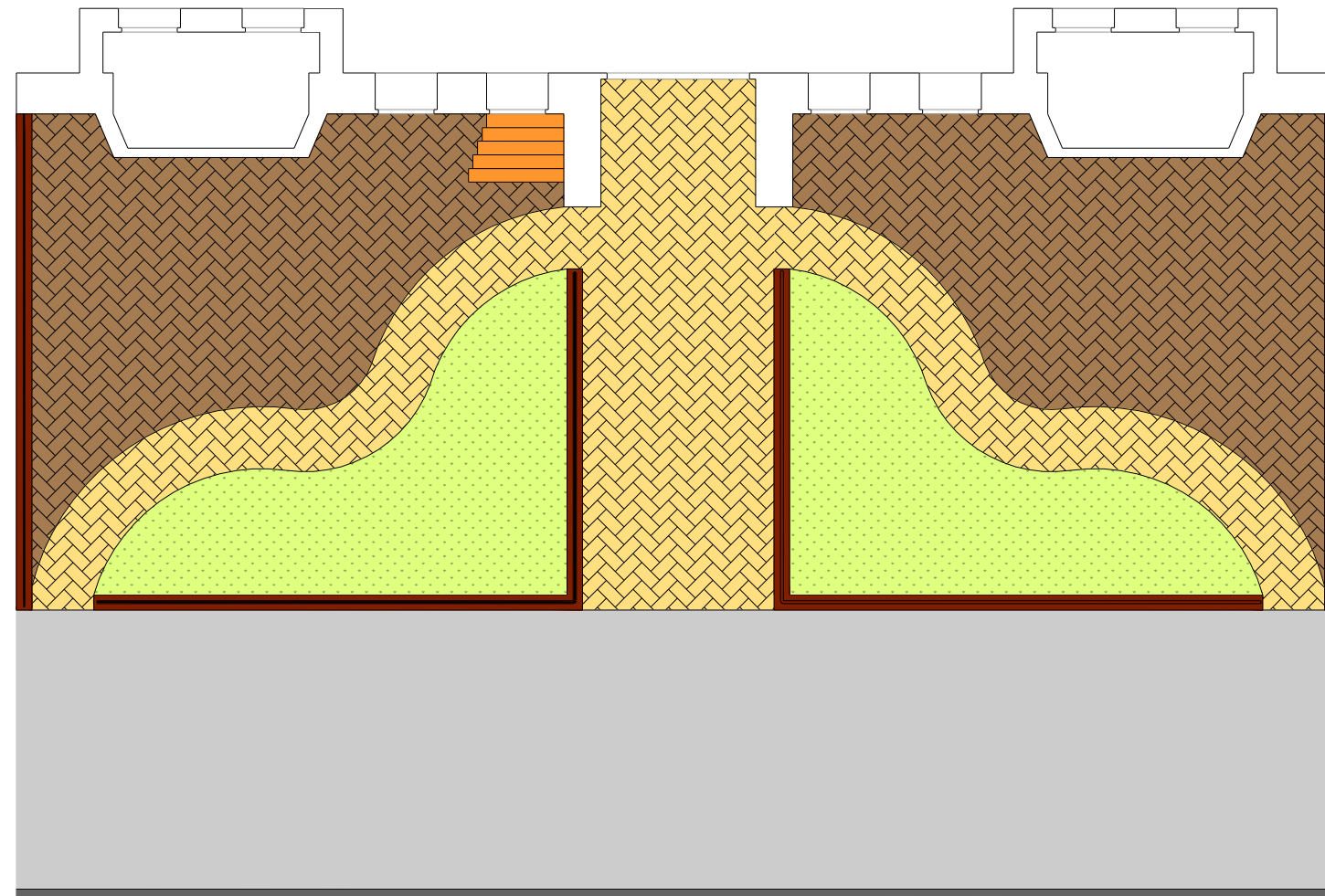

Description of the intervention:

The intervention is based on the replacement completely of the perimeter wall, due to its bad conservation state, and of the fences that surround some parts of the landscaped area. The new wall will be realized with massive ceramic bricks (24x11'5x7 cm), of 24 cm of thickness. This wall will support a metallic fence 50 cm high of wrought steel, with a recovering of plastic painting that protects it against the meteorological inclemencies. The garden is divided in two zones, a paving zone and a lawn zone.

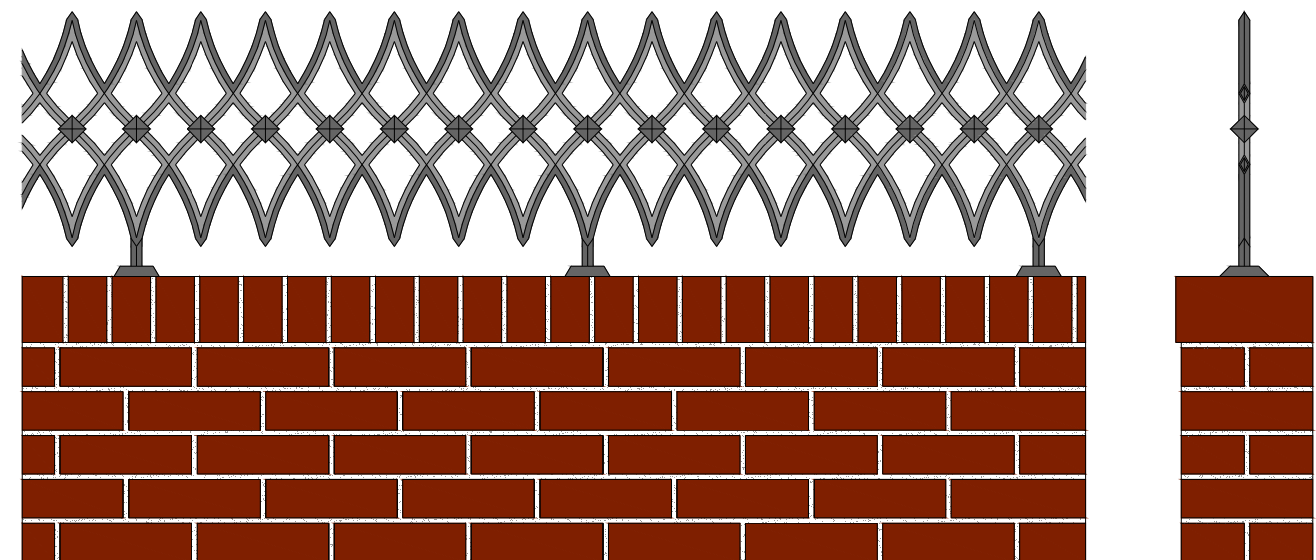



8. Bibliography

- Documents of historical archive
- Safeguarding historic waterfront sites bryggen in Bergen as a case (Politechnia Szczecinska)
- Manual de la construcción (Editorial UPV)
- www.portaldelaconstrucción.es
- www.gis.um.szczecin.pl
- www.wikipedia.com

SECTION C-C'

FACADE JAGIELLONSKA

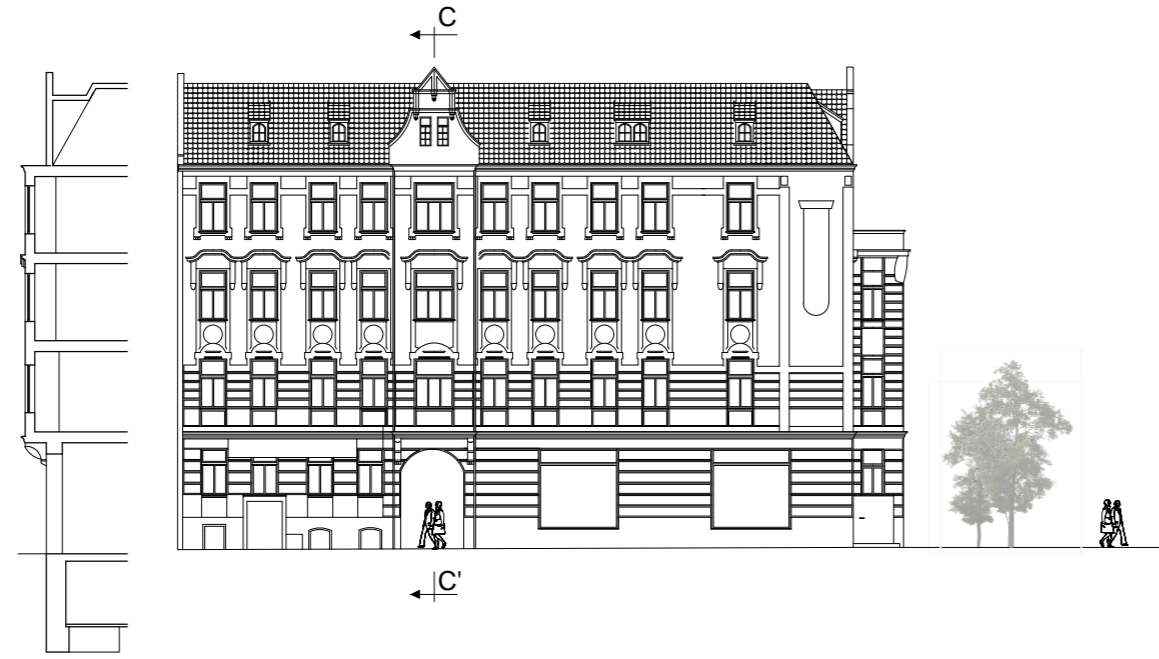

FACADE BOLESLAWA SMIALEGO

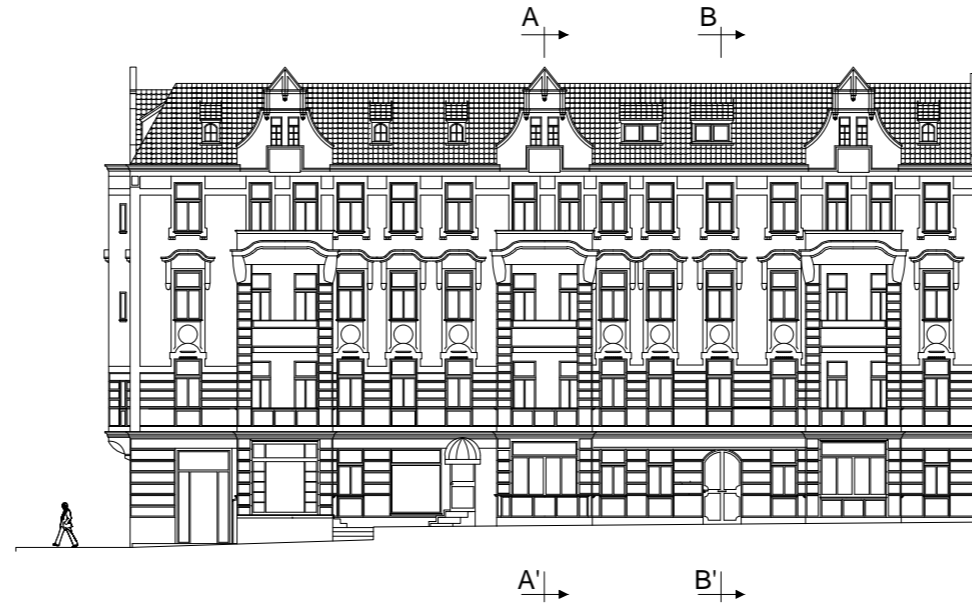

SECTION A-A'

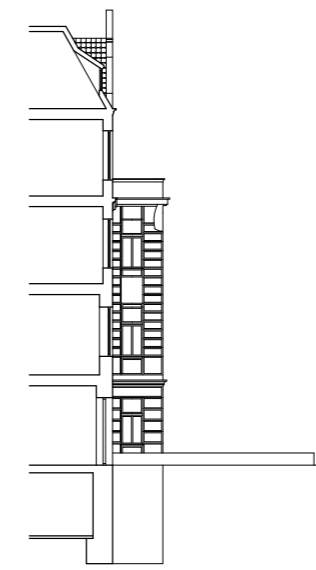

SECTION B-B'

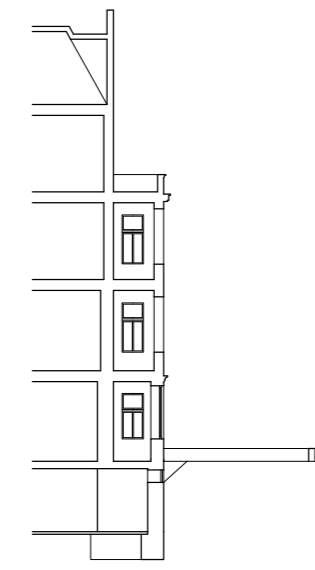

GROUND FLOOR

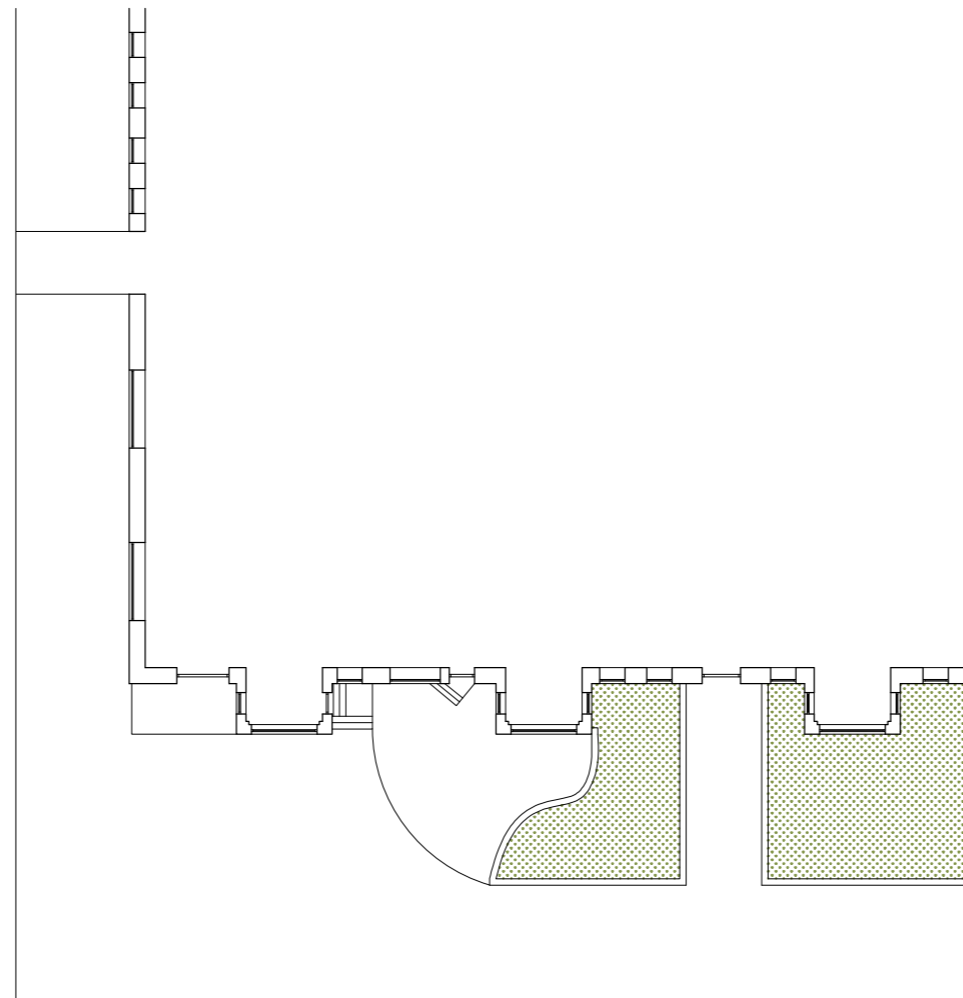

0 5 10 E 1:300



FACADE BOLESLAWA SMIALEGO



0 5 E 1:100

FACADE JAGIELLONSKA



PROYECTO FINAL DE GRADO. Análisis histórico, constructivo y patológico de edificios modernistas en Szczecin

Plano 24.3

SECTION A-A'

SECTION B-B'

SECTION C-C'

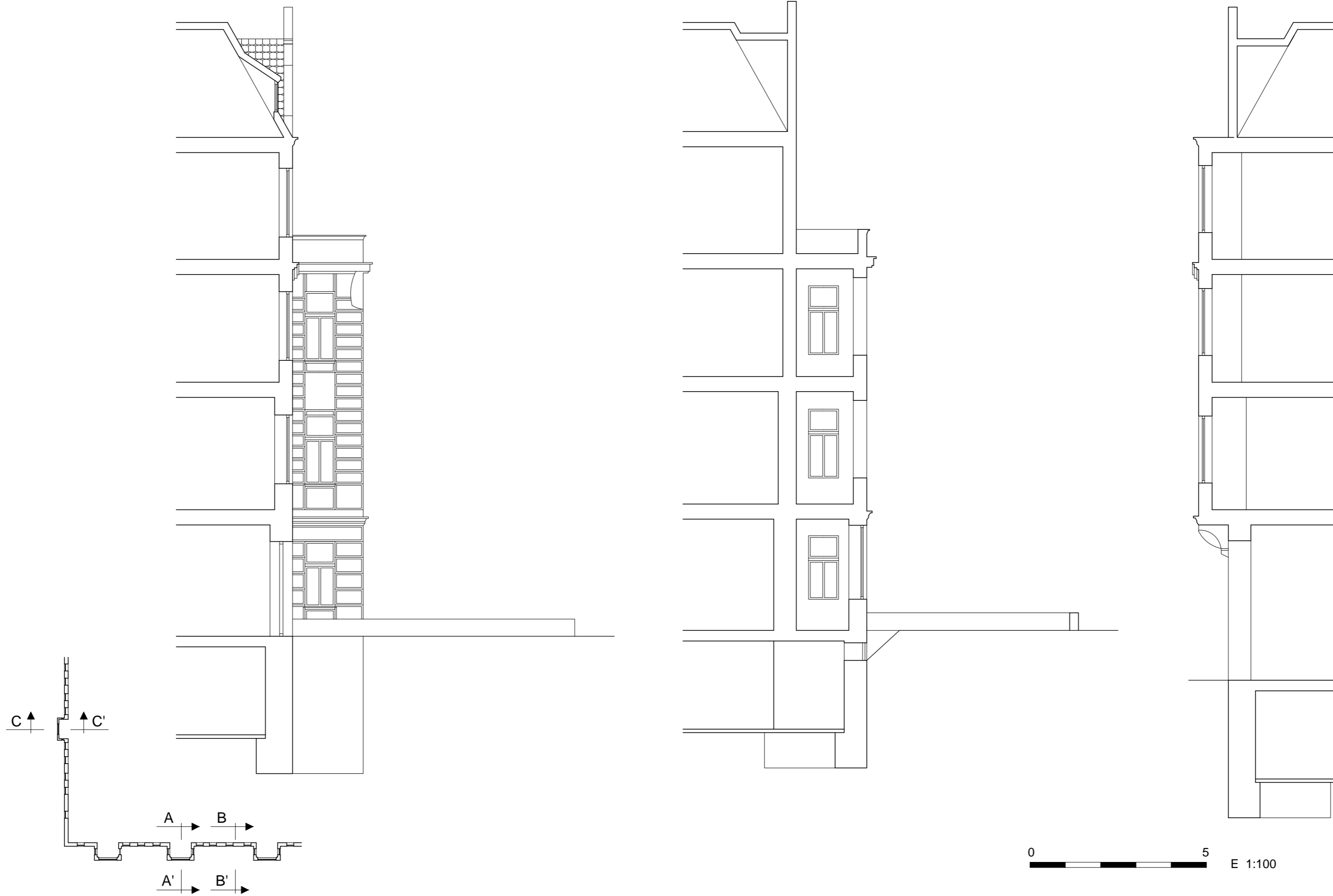

PROYECTO FINAL DE GRADO. Análisis histórico, constructivo y patológico de edificios modernistas en Szczecin

Plano 24.4

GROUND FLOOR

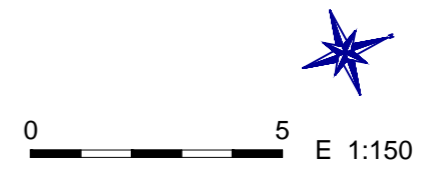
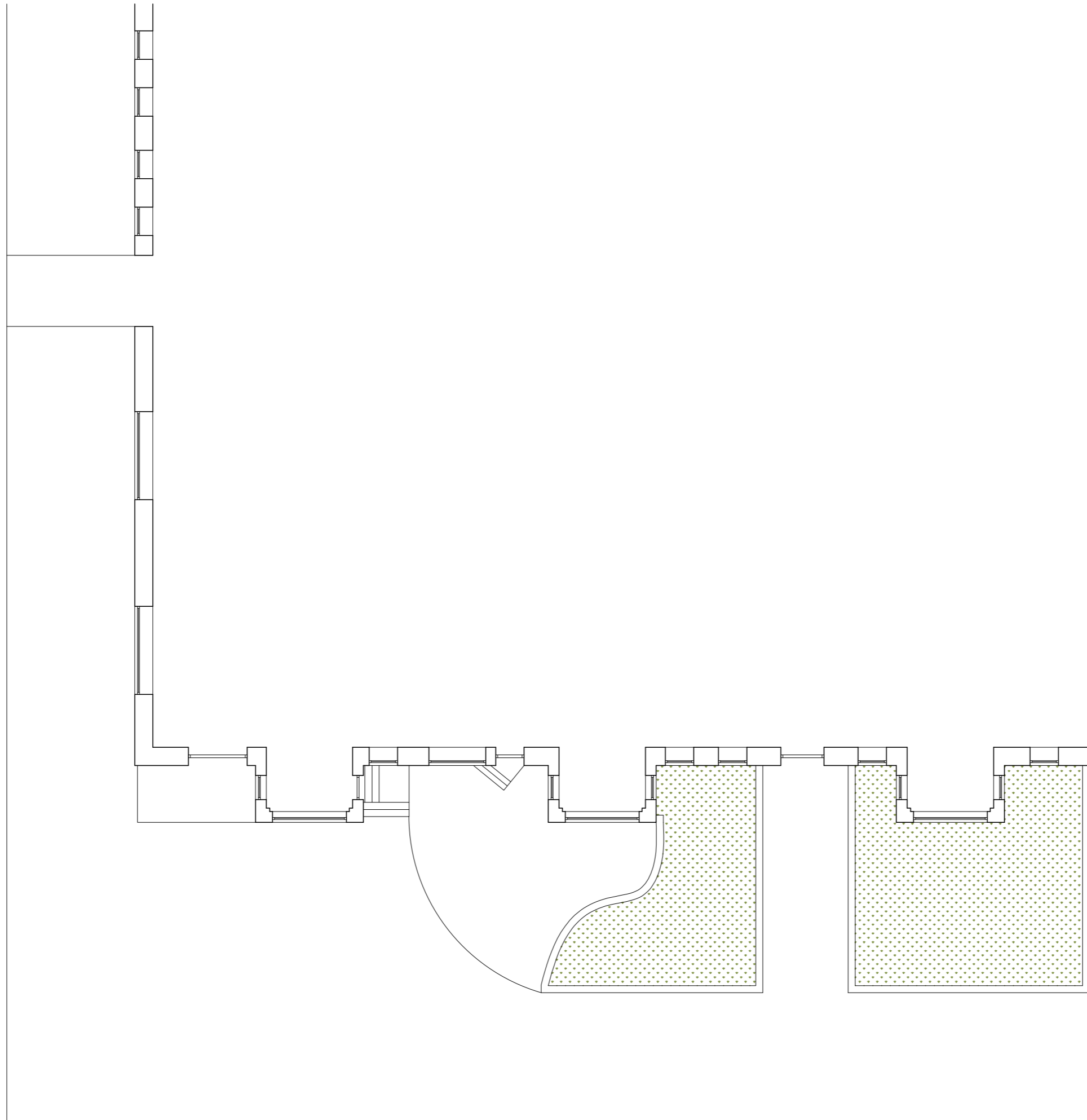

FIRST FLOOR

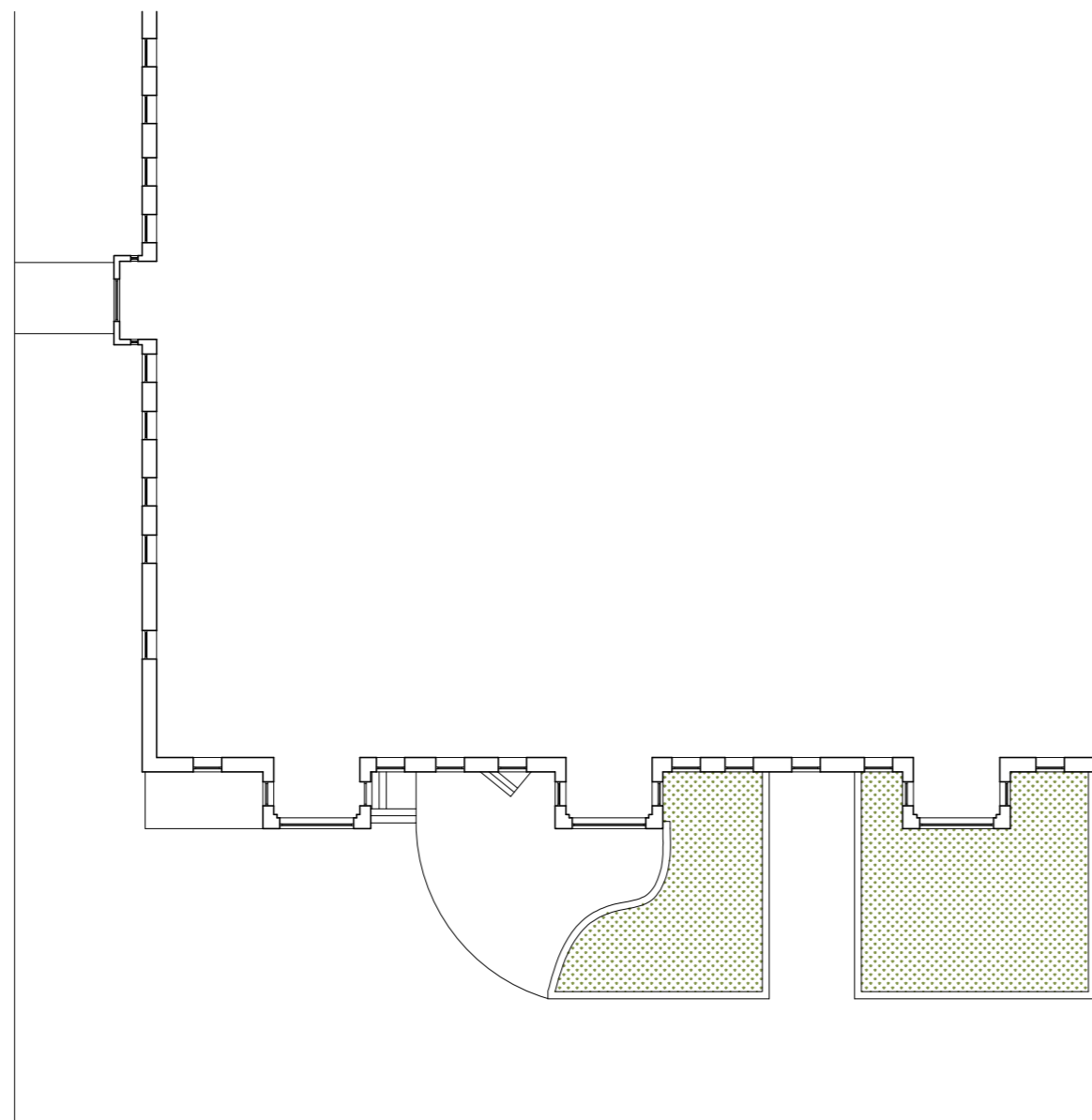

SECOND FLOOR

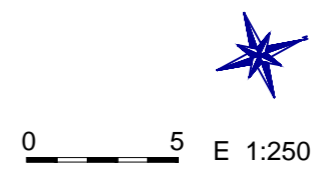
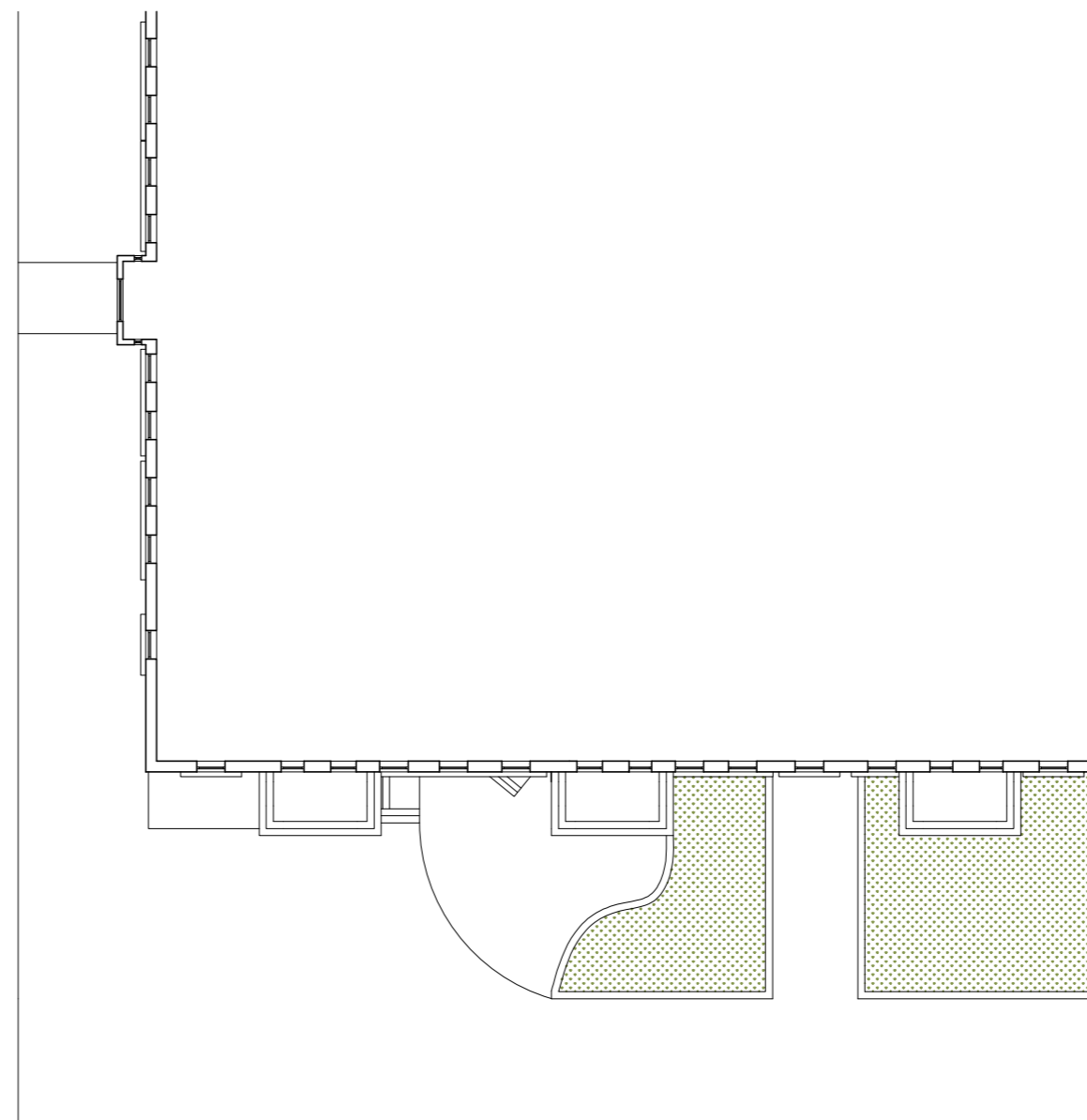

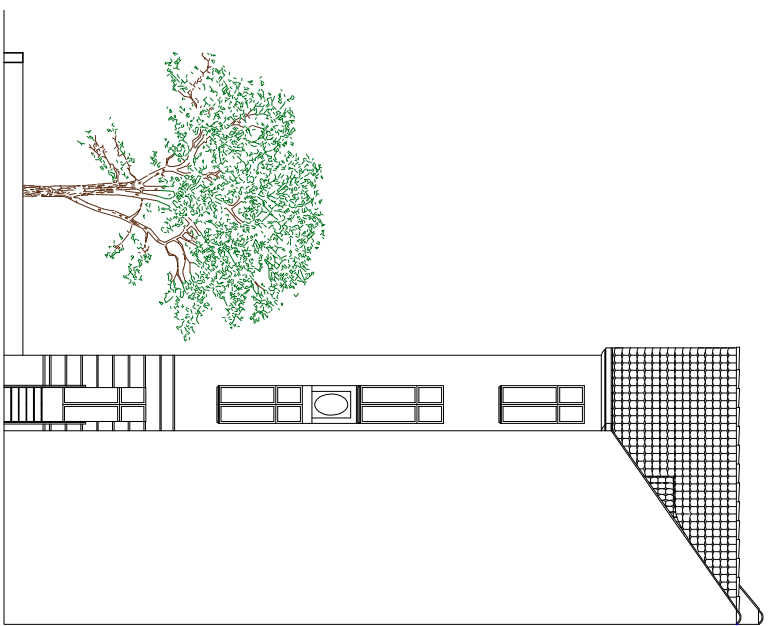

PERFIL

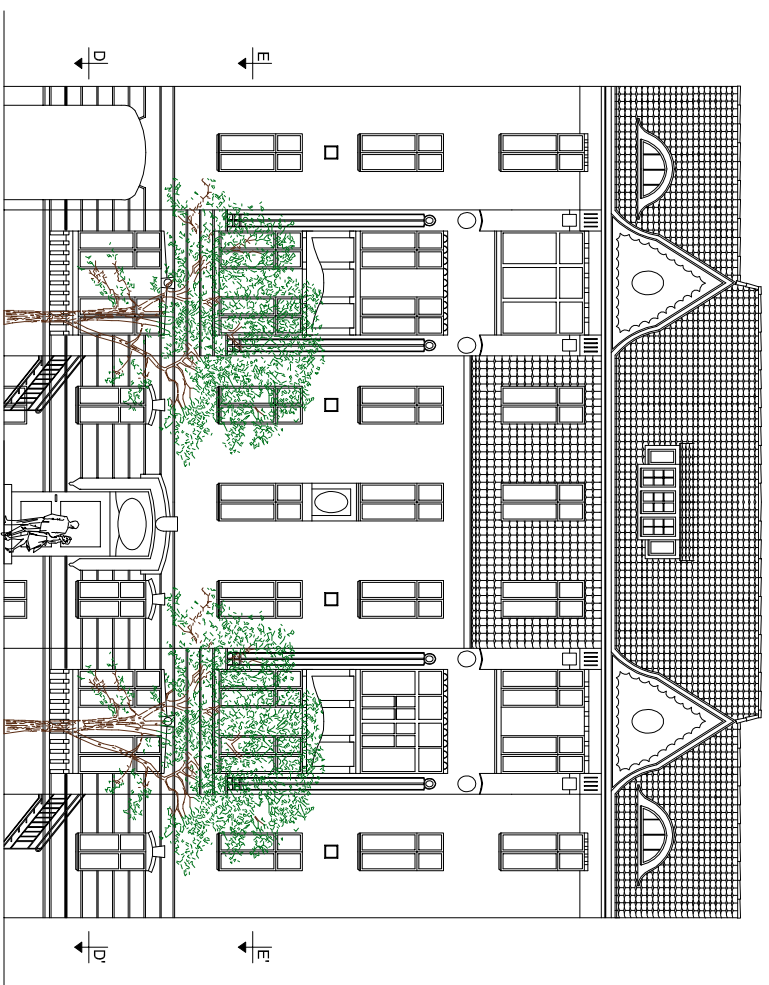

ALZADO



SECCIÓN A-A



SECCION C-C

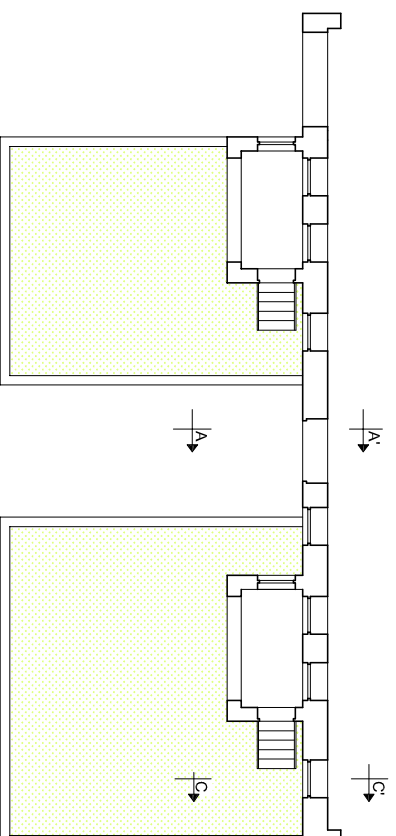

SECCIÓN D-D

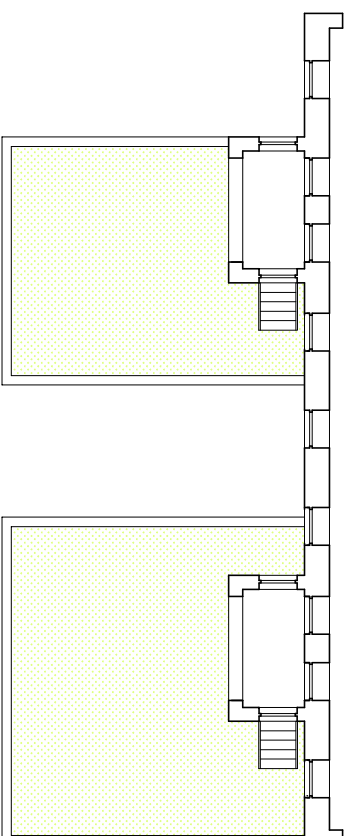

SECCIÓN E-E





ALZADO



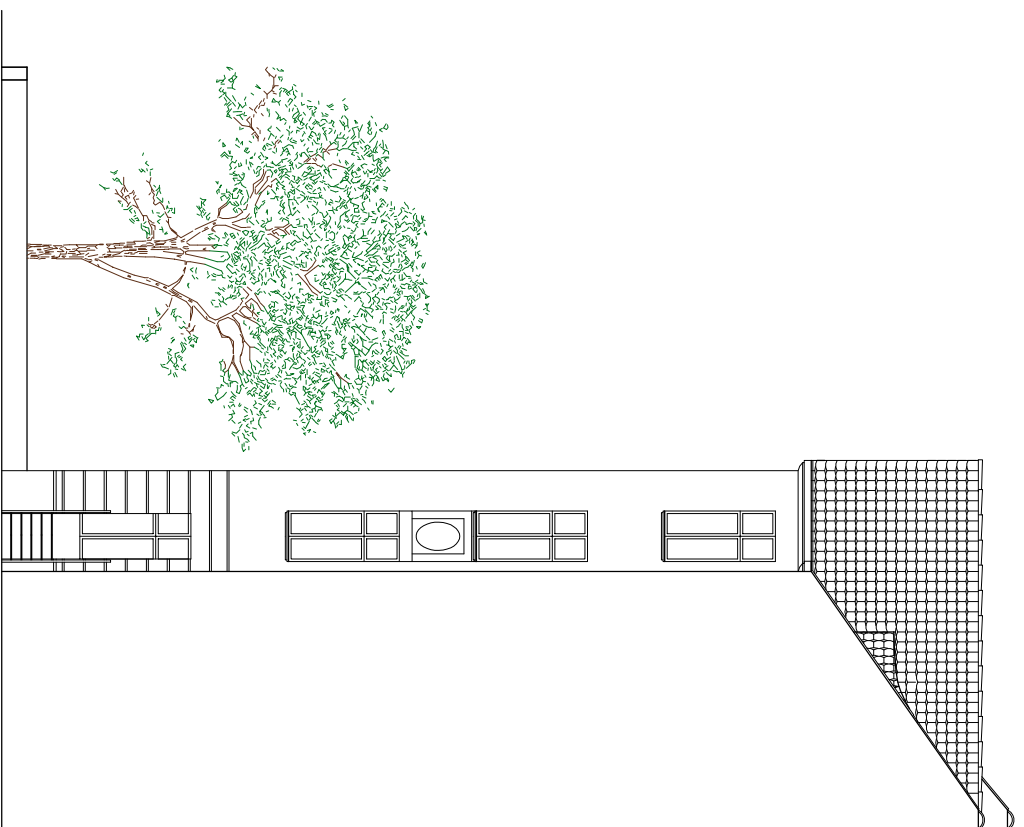

PERFIL

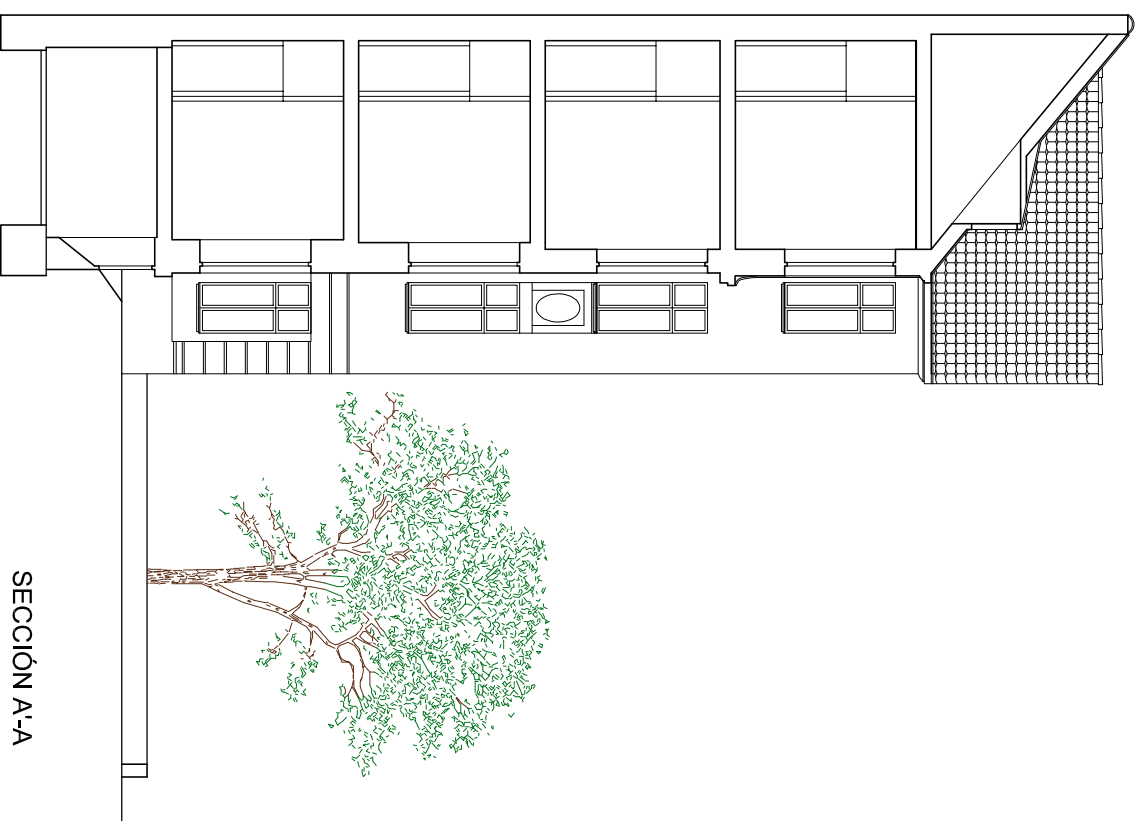

SECCIÓN A-A

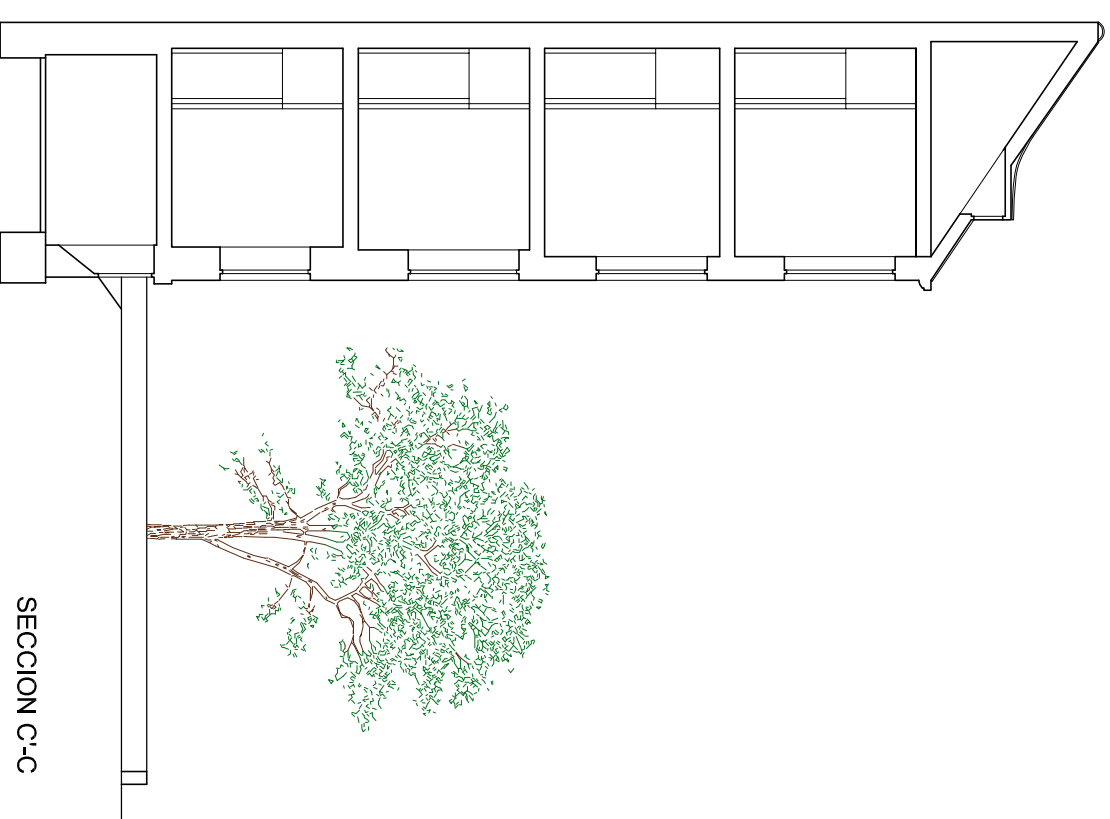

SECCION C-C

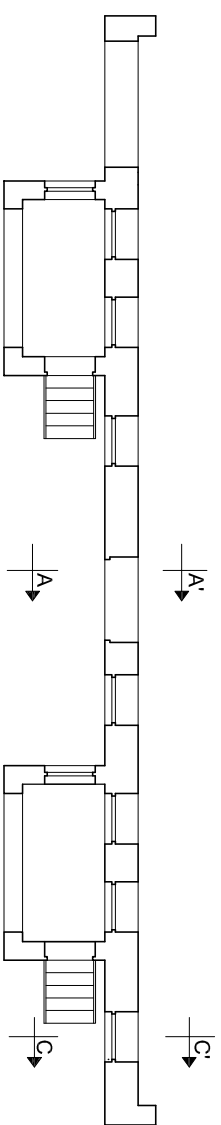

SECCION A-A



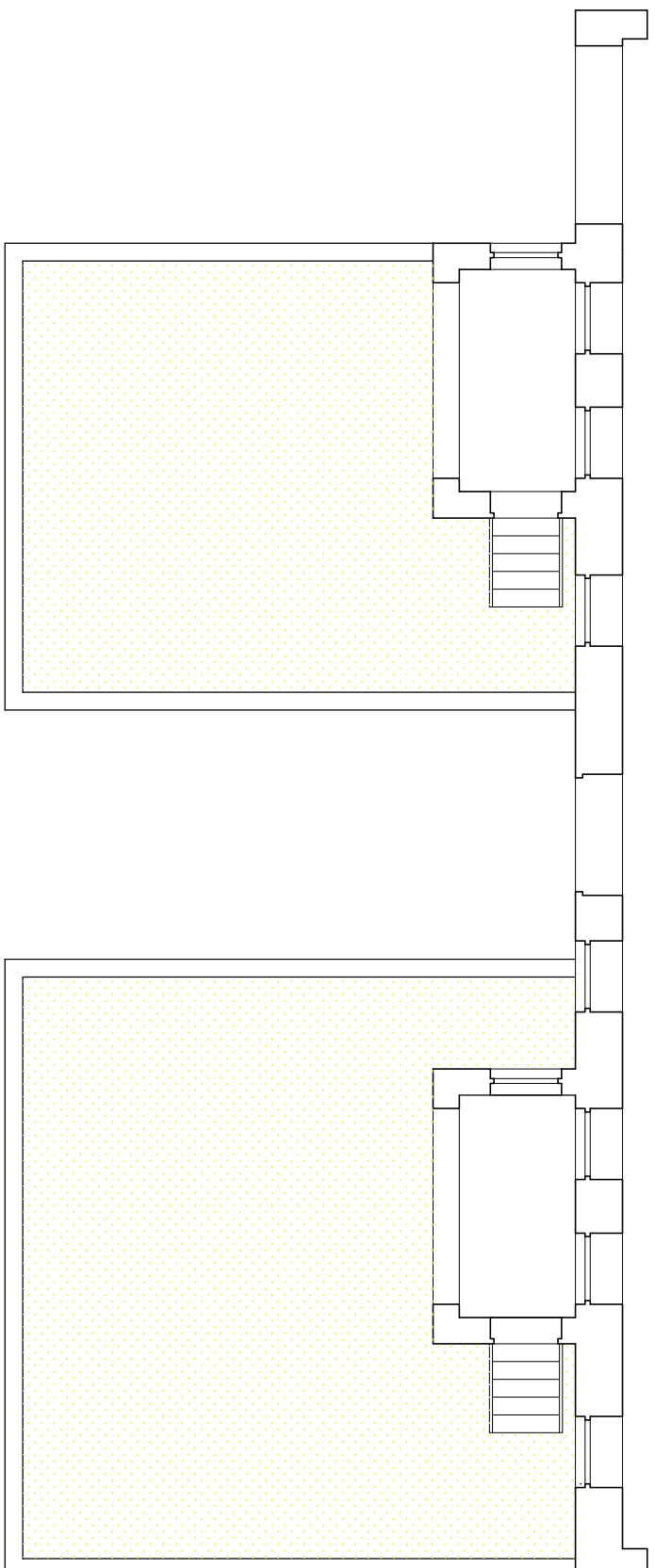

SECCION D-D

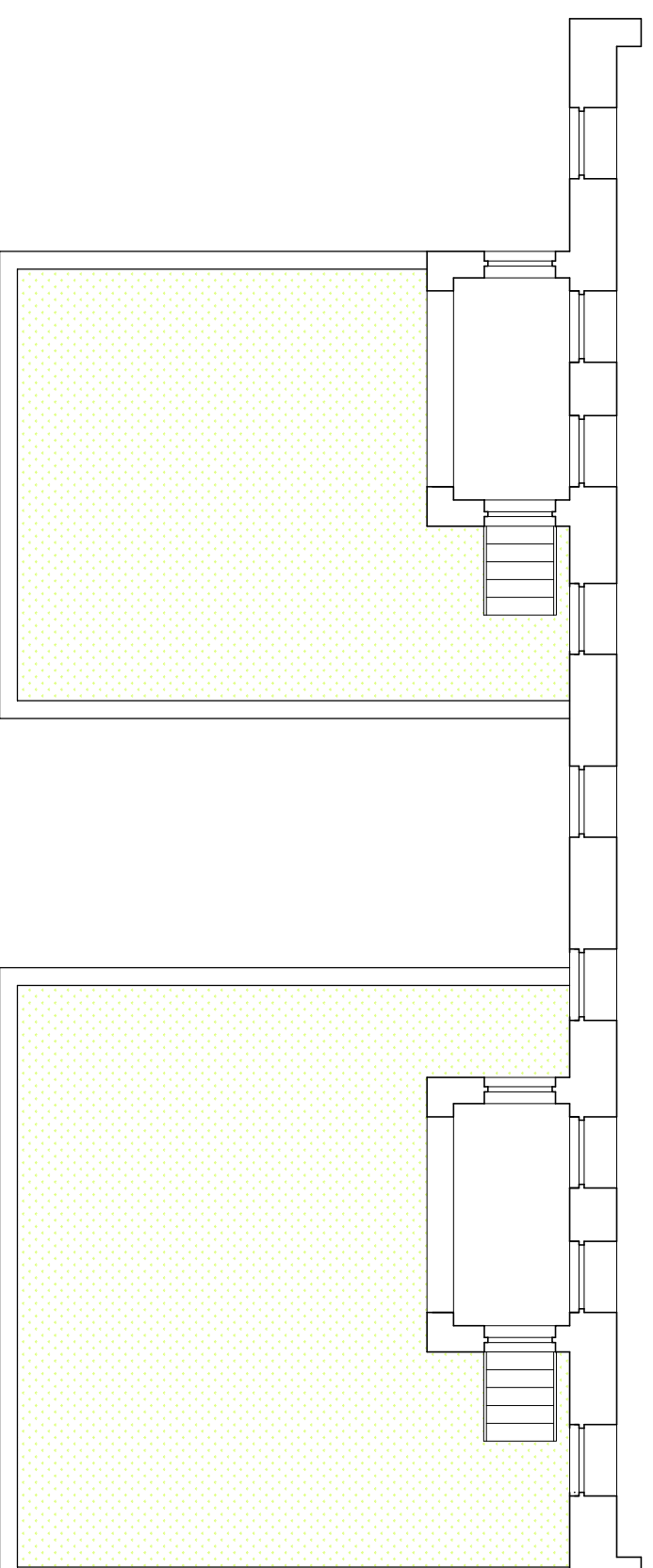

SECCION E-E

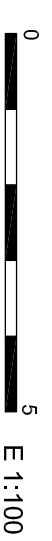



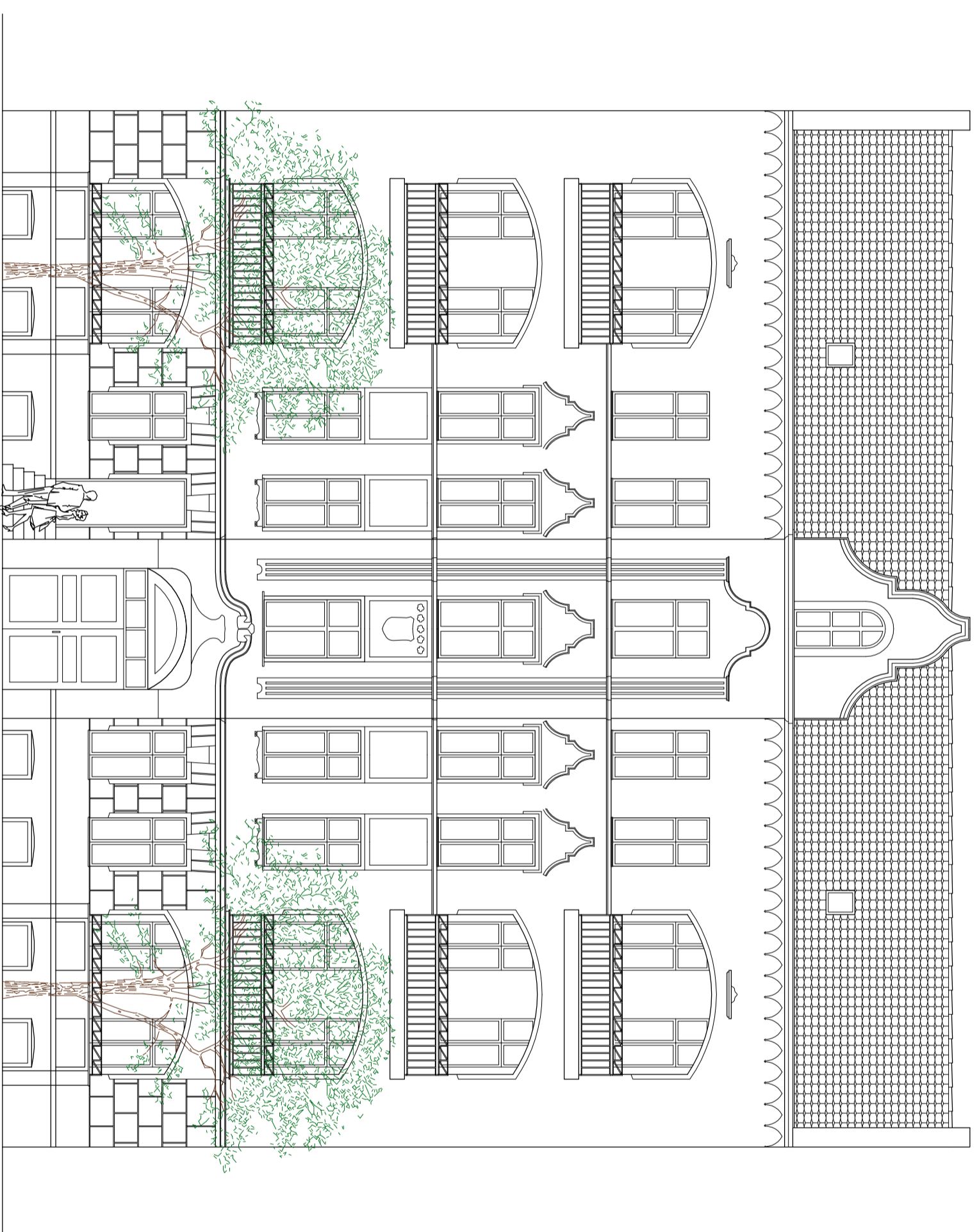

0 5 E 1:100

ALZADO

PROYECTO FINAL DE GRADO. Análisis histórico, constructivo y patológico de edificios modernistas en Szczecin

Plano 44.2

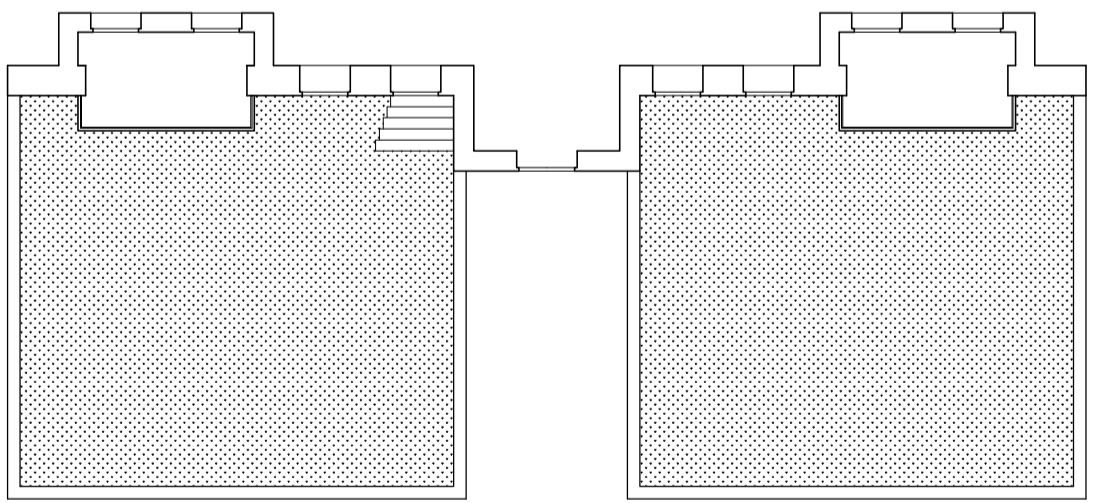
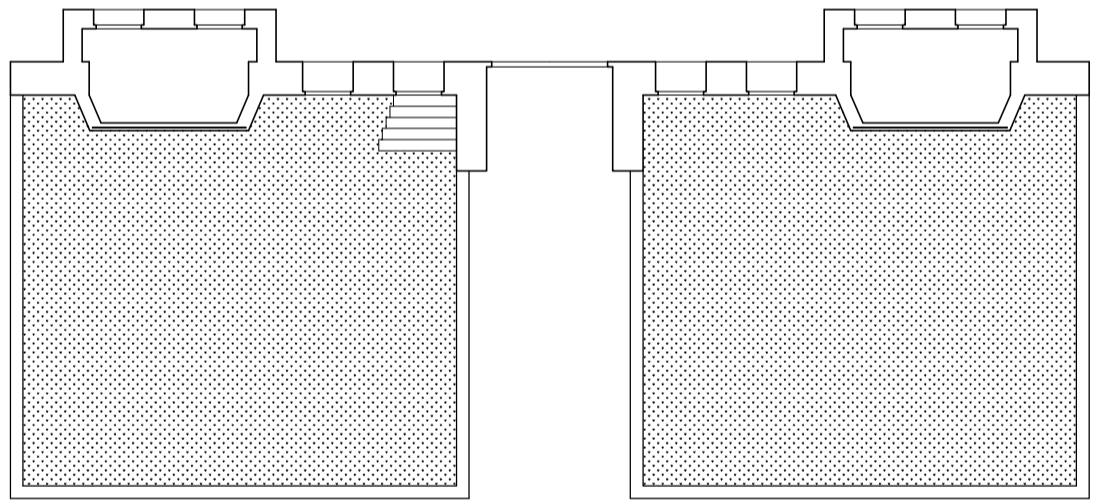

E 1: 150

PROYECTO FINAL DE GRADO. Análisis histórico, constructivo y patológico de edificios modernistas en Szczecin

Plano 44.3



PROYECTO FINAL DE GRADO. Análisis histórico, constructivo y patológico de edificios modernistas en Szczecin

[Plano 44.4](#)