

Empirical characterisation of the indoor multi-user MIMO channel in the 3.5 GHz band

ISSN 1751-8725

Received on 20th December 2018

Revised 10th May 2019

Accepted on 3rd June 2019

E-First on 30th July 2019

doi: 10.1049/iet-map.2018.6215

www.ietdl.org

Rafael P. Torres¹, Jesús R. Pérez¹ ✉, José Basterrechea¹, Marta Domingo¹, Luis Valle¹, Jorge González¹, Lorenzo Rubio², Vicent M. Rodrigo², Juan Reig²

¹Department of Communications Engineering, University of Cantabria, Santander, Spain

²Departamento de Comunicaciones, iTEAM Research Institute, Universitat Politècnica de València, Valencia, Spain

✉ E-mail: jesusramon.perez@unican.es

Abstract: This study presents an analysis of the capabilities of using multi-user multiple input multiple output (MU-MIMO) in indoor environments at the 3–4 GHz band through an empirical characterisation of the MU-MIMO channel, obtaining a statistical description of the degree to which this specific multi-user channel verifies the condition of ‘favourable propagation’. Different metrics have been considered to measure the degree of orthogonality between the channels, such as the orthogonality coefficient or the condition number. In addition, in order to obtain a direct measure of the goodness of the channel in terms of the achievable spectral efficiency, the capacity of the channel has been calculated for different numbers of users and base station antennas and compared with theoretical i.i.d. Rayleigh channels.

1 Introduction

The development of the new 5G communication systems, including the use, among others, of multi-user multiple input multiple output (MU-MIMO) access techniques, requires higher dedicated bandwidths. Currently, industry, governments and regulatory bodies are involved in the search and harmonization of new frequency bands for such systems. Although it is expected that a significant part of these frequencies will be allocated in the millimetre band, there is also an international consensus to start the deployment of the first 5G systems in the 3.3–4.4 GHz band. In Europe, the band ranging from 3.4 to 3.8 GHz has already been reserved for the deployment of these systems [1]. It is important to carry out studies of the MU-MIMO channel in that band in order to analyse the feasibility of the MU-MIMO scheme in a relatively low frequency band, especially in indoor environments.

In recent years, a great deal of work has been performed to empirically characterise MU-MIMO channels in different environments and frequency bands [2–6]. One of the most relevant aspects to be analysed deals with the relationship between the channels established between any user terminal (UT) and the base station (BS). In particular, it is of great interest to evaluate the degree to which a specific multi-user channel verifies the condition of ‘favourable propagation’. This condition assumes that the channels between the different UTs and the BS are increasingly orthogonal to each other when the number of antennas of the BS increases. The degree to which the predicted theoretical capacities can be achieved and which processing techniques will be more appropriate depend on the degree of fulfilment of this condition [7, 8].

In this paper, we present a study of the behaviour of the MU-MIMO channel in the 3–4 GHz band based on experimental data, taking as reference the results of a measurement campaign carried out in two indoor environments. In one of these scenarios, the UTs are all in a line-of-sight (LOS) situation with respect to the BS but, in contrast, the second one corresponds with a non-line-of-sight (NLOS) situation for all the UTs. For both cases, the sum capacity of the channel in the uplink (UL) has been evaluated for a maximum number of 6 users. Moreover, the BS is a virtual flat array consisting of 7×7 antenna elements, $\lambda/4$ uniformly spaced at the centre frequency (3.5 GHz), and 14×14 cm² in size. Both the relatively low number of antennas as well as the small size of the

array make it a realistic and attractive option for the deployment of an indoor cell.

There are different metrics to measure the degree of orthogonality between the channels. The simplest one lies in calculating the scalar product between the channel vectors taken two by two. However, this method provides only a partial knowledge of the complete MU-MIMO channel as it is necessary to be aware of the degree of orthogonality when all the UTs are active, that is, the degree of global orthogonality of the columns of the channel matrix. This information can be obtained by analysing the distribution of the eigenvalues of the channel matrix, either directly or through the statistical behaviour of the ‘condition number’ [3–5]. These characteristics of the channel matrix are valid metrics of the degree to which the condition of ‘favourable propagation’ is fulfilled. However, they are not a direct measure of the goodness of the channel in terms of the spectral efficiency achievable in bits/s/Hz.

The characterisation of the channel against the achievable spectral efficiency is usually obtained by calculating the capacity of the channel. This theoretical maximum limit can be achieved in different degrees depending on the signal processing techniques used [8].

The paper is organised as follows. Section 2 includes the main characteristics of the indoor radio channel measurements, including a description of both the scenarios as well as the measurement setup. Then, Section 3 describes the system model focused on the UL and Section 4 includes representative results along with their associated discussion. Finally, the main conclusions are summarised in Section 5.

2 Channel measurements

In order to analyse the behaviour of the MU-MIMO channel, a measurement campaign has been carried out at two specific sites of the Telecommunications Engineering building at the University of Cantabria, as shown in Fig. 1. Both scenarios have a concrete floor and a ceiling board, concrete columns, as well as indoor walls made of plasterboard. Regarding site 1 depicted in Fig. 1a, it corresponds to a meeting room with office furniture, including desks, chairs and shelves. In this case, both BS and all the UTs or transmitter positions are in a LOS situation. However, at site 2 the BS is placed inside a computer laboratory and the UTs are located

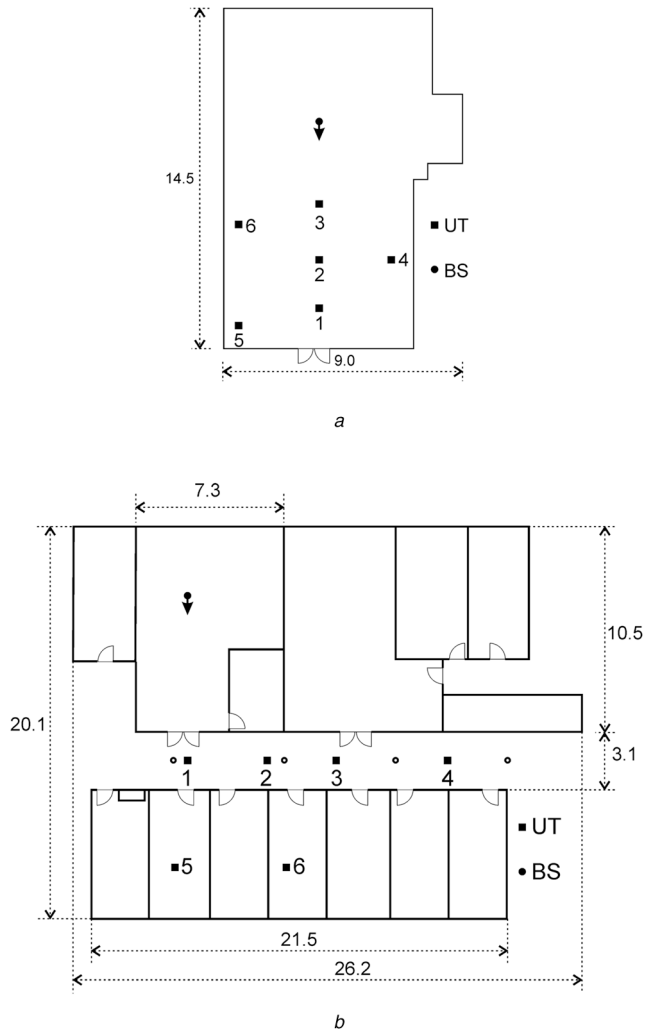

Fig. 1 Measurement scenarios including detail of both BS (the arrow indicates the broadside direction) and UTs positions, dimensions in meters (a) Site 1, LOS, (b) Site 2, NLOS

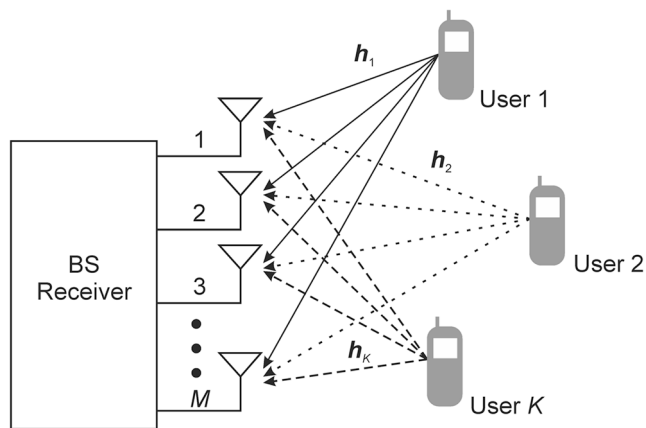

Fig. 2 MU-MIMO system for the uplink

either in a long corridor (UT₁₋₄) or inside offices (UT₅₋₆), but all of them in an NLOS situation with respect to the BS position. Computers, desks, metallic as well as wooden bookshelves and chairs complete the common furniture present at site 2.

Concerning the measurement setup, a planar scanner consisting of two linear units and step motors along with an E8362A PNA series vector network analyser (VNA) are used to build up the virtual array at the BS side and to measure the channel response for any of the UTs positions, respectively. Both, the planar scanner on which the BS antenna is mounted along with the VNA are synchronised and remote controlled from an *ad-hoc* computer software through the RS-232 and GPIB interfaces, respectively.

Once the VNA has been calibrated at both transmitter (UT) and receiver (BS) cable ends, considering the 3–4 GHz band and 801 frequency tones (1.25 MHz uniformly spaced and with a delay time of 800 ns without aliasing), the measurement can be performed. Thus, for any of the UT positions, the virtual BS antenna moves on a 14 × 14 cm² vertical plane, considering 7 × 7 positions λ/4 uniformly spaced at 3.5 GHz. At each position, the S₂₁ trace is remotely acquired, so the experimental data contain 49 traces with information of the channel frequency response for every UT. At both transmitter and receiver sides, a biconical broadband antenna has been used.

At site 1, where all the UTs are in LOS and at a similar distance from the BS, the average signal-to-noise ratio (SNR) over all the BS antenna elements was above 40 dB. At site 2, due to the different NLOS conditions of each UT, the average SNR ranges from 30 dB (UT₆) to 37 dB (UT₁). For the capacity analysis, a SNR of 10 dB has been selected since it is considered a middle-level SNR [3].

3 Uplink system model

Focusing the analysis on the UL, the MU-MIMO system considered is a simple cell system where the BS is equipped with M antennas. The maximum number of active users is K and each UT is equipped with a single antenna, as depicted in Fig. 2. It is assumed that the users transmit a total power P , which is distributed equally among all UTs. In addition, it is assumed that the BS knows the channel and that the UTs are not collaborating among each other. Considering the spatial distribution of the UTs along the measured scenarios, it can be considered that there are no significant differences between the propagation losses suffered by any of them. In any case, the normalisation made on the channel matrix does not eliminate such differences, as detailed later. Furthermore, we consider an OFDM system with N_f sub-carriers, which corresponds to the 801 measured tones.

Considering this model, the signal received at the BS for the i th sub-carrier when the K users are active will be given by

$$\mathbf{y}(i) = \mathbf{H}(i) \cdot \mathbf{s}(i) + \mathbf{n}(i); i = 1, 2, \dots, N_f \quad (1)$$

where $\mathbf{y}(i)$ is a column vector with M elements corresponding to the i th sub-carrier and $\mathbf{H}(i)$ is the channel matrix, of order $M \times K$, in which each one of its columns represents the narrowband channel ($\mathbf{h}_k(i)$) of order $M \times 1$ corresponding to the i th sub-carrier. The signals transmitted from each UT are grouped into the signal vector \mathbf{s} ($K \times 1$) that is normalised, so that $E\{\|\mathbf{s}\|^2\} = 1$; and, finally, \mathbf{n} ($M \times 1$) is a complex Gaussian noise vector with i.i.d. unit variance elements.

The matrix \mathbf{H} in (1) is normalised in such a way that verifies

$$E\{\|\mathbf{H}\|_F^2\} = M \cdot K \quad (2)$$

Moreover, the matrix \mathbf{H} is obtained from the matrix of the raw channel measurements (\mathbf{H}^{raw}) by means of the expression

$$\mathbf{H}(i) = \mathbf{H}^{\text{raw}}(i)/J^{\text{norm}} \quad (3)$$

in which J^{norm} is a normalisation factor given by

$$J^{\text{norm}} = \sqrt{\frac{1}{N_f} \sum_{i=1}^{N_f} \|\mathbf{H}^{\text{raw}}(i)\|_F^2} \quad (4)$$

It should be noted that the normalisation considered preserves the small and large-scale variations of the links. This normalisation is a realistic approach, especially in the UL, where the power level received from different UTs is not the same, and this fact must be taken into account in the channel matrix structure as it influences its singular values. However, there exists another normalisation method so that the unbalance between the different UTs is cancelled; so this normalisation makes sense when isolating the

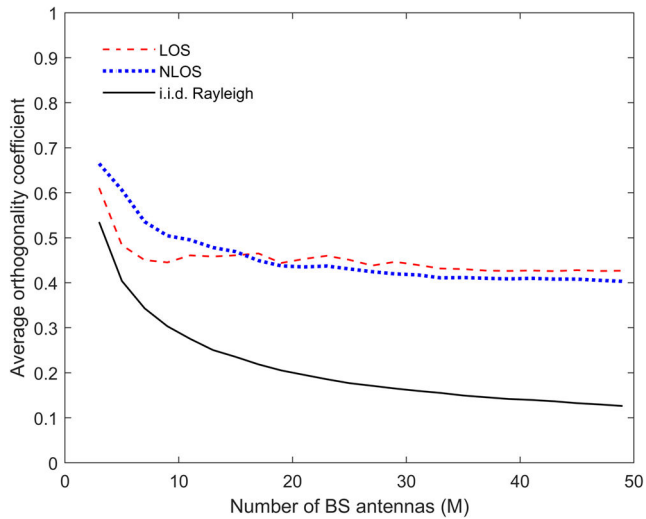

Fig. 3 Orthogonality coefficient for both scenarios, site 1 (LOS) and site 2 (NLOS)

effect on the behaviour of the system of the small-scale fading against the large-scale fading pursued [3].

Under the hypothesis of a perfect knowledge of the channel at the BS, we can obtain the sum-capacity of the MU-MIMO-OFDM system by means of the breakdown into singular values of the channel matrix as

$$C(i) = \sum_{k=1}^K \log_2 \left(1 + \frac{\text{SNR}}{K} \cdot \lambda_k \right); i = 1, 2, \dots, N_f \quad (5)$$

in which λ_k represents the k th eigenvalue of the $\mathbf{H}^H \mathbf{H}$ matrix, i.e. the square of the k th singular value of the \mathbf{H} matrix.

Under favourable propagation conditions, as the number of receiving antennas (M) increases to infinity, and for a fixed number of transmitters (K), the capacity of the UL channel will tend asymptotically to the upper bound [8], given by

$$C_b = K \cdot \log_2 \left(1 + \frac{M \cdot \text{SNR}}{K} \right) \quad (6)$$

The upper bound in (6) indicates that a scenario is beneficial when the number of antenna elements at the BS is high in comparison with the number of UTs and, in addition, the conditions of favourable propagation are accomplished [8].

4 Results

4.1 Favourable propagation

In order to evaluate the degree to which the condition of ‘favourable propagation’ is accomplished, the orthogonality coefficients of the channels taken in pairs (p, q) have been calculated as follows:

$$\delta(p, q) = \frac{\mathbf{h}_p \cdot \mathbf{h}_q}{\|\mathbf{h}_p\| \cdot \|\mathbf{h}_q\|} \quad (7)$$

In order to globally characterise the environments under study, these coefficients have been averaged over the 15 possible pair combinations at each one of the environments (6 UTs taken two by two). In Fig. 3, the result obtained is presented, showing the mean orthogonality coefficient against the number of elements within the receiver array (the elements of the receiver array are also taken randomly to reduce the influence of its exact position within the array). The expected value for i.i.d. Rayleigh channels is also included, where $E\{\left(\delta^{i.i.d.}\right)^2\} = M^{-1}$. From the results, it can be observed how the orthogonality coefficients of the channels decrease as the number of antennas at the BS increases. However, the decrease stagnates when M is >20 antennas, obtaining a floor

value of ~ 0.4 . This behaviour contrasts with the value obtained for the i.i.d. Rayleigh channels, in which that decrease is continuous and for 49 antennas the orthogonality coefficient reaches a value of ~ 0.1 . Furthermore, concerning the comparison of the orthogonality coefficient values achieved in both scenarios, it can be concluded that for a number of antennas smaller than 16 there are only slight differences between the two environments. However, as the number of antenna elements increases above 16, the results achieved for both environments become quite similar. For this analysis, only the channels taken in pairs have been considered, but in the next sub-section we will analyse the behaviour of both environments using the complete channel matrix, when all the UTs are active.

4.2 Inverse condition number

The decomposition into singular values of the \mathbf{H} matrix is an important mathematical tool, useful for calculating the theoretical capacities achievable by the MIMO channels and to compare different propagation environments among themselves [3, 9]. We can concisely state that a greater dispersion between the singular values of the channel matrix implies a lower capacity associated with this channel. The reason is that the dispersion of the singular values is due to a poor orthogonality between the columns of the \mathbf{H} matrix, that is, between the different channels that are established between the UTs and the BS. The dispersion of the singular values is usually measured by the condition number, stated as follows:

$$\kappa = \frac{\max\{\text{eigenvalue}(\mathbf{H}^H \mathbf{H})\}}{\min\{\text{eigenvalue}(\mathbf{H}^H \mathbf{H})\}} \quad (8)$$

According to (8), a value of κ equal to one corresponds to a channel matrix in which all its columns are orthogonal. On the contrary, high values of κ indicate that at least two columns of the matrix will be practically collinear. From a practical point of view, it is more suitable to represent and interpret the results using as a metric the inverse of the condition number (ICN), which varies between 0 (zero orthogonality, at least between two columns of \mathbf{H}) and 1 (maximum orthogonality).

Fig. 4 shows the cumulative distribution function (CDF) of the ICN for the LOS, NLOS as well as i.i.d. Rayleigh channels when the number of antennas at the BS is set to 49 and the number of active UTs ranges from 2 to 6. For $K=2$ and $K=4$, the CDF corresponds with the ICN values of the 15 possible combinations of six UTs taken from two by two or from four by four, respectively. For both LOS and NLOS environments, as well as for any value of K , it can be observed that the values of the ICN achieved are lower than those obtained for the i.i.d. Rayleigh case. This allows us to state for all the measured channels that there is a loss of orthogonality with respect to the uncorrelated theoretical channels. Unlike the orthogonality coefficient, the statistical distributions of the ICN do make it possible to differentiate between the two propagation environments. From the results, it can also be inferred that for any number of UTs, either 2, 4 or 6, the NLOS environment presents a greater orthogonality loss than the LOS one. When comparing the two environments, it is observed that the LOS one presents a more favourable propagation than the NLOS. This result differs from that obtained by other authors for outdoor channels [3], where NLOS situations present better orthogonality than LOS channels. However, indoor scenarios often lead to complex propagation conditions, in which LOS situations may present a greater scattering richness than NLOS ones.

Finally, Fig. 4 also shows how increasing the number of active channels (K) leads to an orthogonality loss in the channel matrix, that is, smaller ICN values appear, which indicates the presence of at least two columns of the channel matrix with high correlation; i.e. there are at least two UTs with channels that have low orthogonality.

4.3 Sum capacity

Fig. 5 presents the CDF of the sum capacities for both propagation environments obtained according to the model proposed in Section

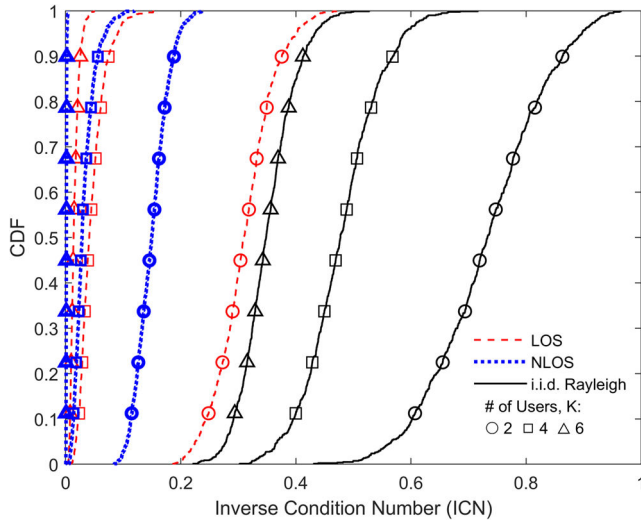

Fig. 4 CDF of the ICN with 49 antenna elements at the BS for a different number of active UTs

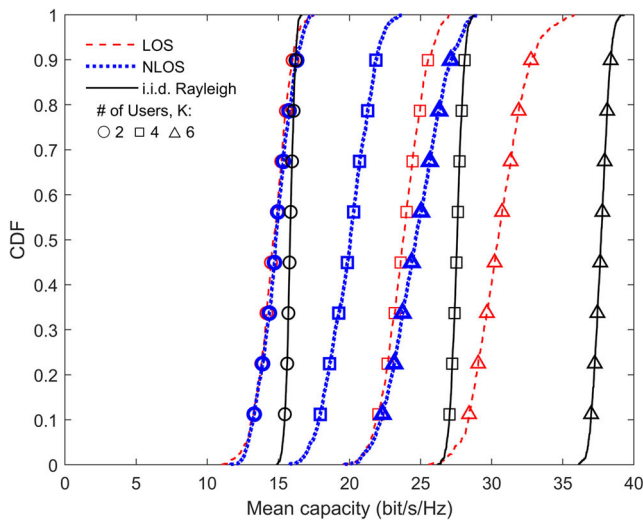

Fig. 5 CDF of the capacity with 49 antenna elements at the BS for a different number of active UTs

3, and considering a SNR of 10 dB along with a number of active UTs ranging from 2 to 6. The theoretical CDF associated with i.i.d. Rayleigh channels is also included in the comparison. The results achieved show how the measured capacities are always lower than those corresponding to the i.i.d. channels. For $K=2$, the capacities for both environments are quite similar and show a loss of the mean value of the capacity of 1 bit/s/Hz against the i.i.d. Rayleigh channel. For $K=4$, both site 1 (LOS) and site 2 (NLOS) results differ significantly, obtaining greater capacities in the LOS scenario, according to the ICN values obtained; and in both cases the difference with the theoretical capacities of the Rayleigh channels increases. Finally, for $K=6$ the above trend continues, as site 1 and site 2 differences become higher and, at the same time, both have a greater loss of capacity with respect to the theoretical i.i.d. channels, showing losses in the median capacity of 7 and 15 bit/s/Hz in LOS and NLOS environments, respectively.

From the comparison of the statistical behaviour of both the ICN parameter and the capacity, it can be concluded that the impact of the variations of the ICN on the capacity is not linear. Furthermore, from the decrease of the ICN from one environment to the other one, only general conclusions regarding the capabilities of both sites can be drawn.

Fig. 6 shows the mean capacity as a function of the SNR for both scenarios, and again for different numbers of active UTs ($K=2, 4$ and 6). Moreover, the experimental results are compared with the mean capacities of the i.i.d. Rayleigh channels. From the results, for both measurement environments and for a fixed SNR

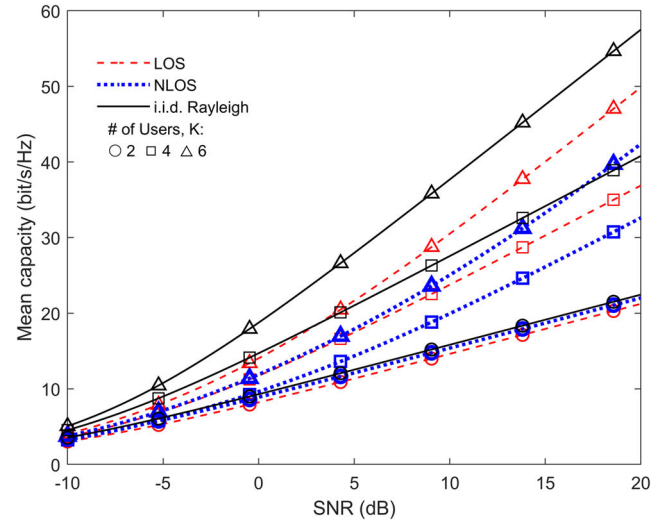

Fig. 6 Mean capacity of the system against the SNR as a function of the number of active UTs. An antenna array with 49 elements at the BS has been considered

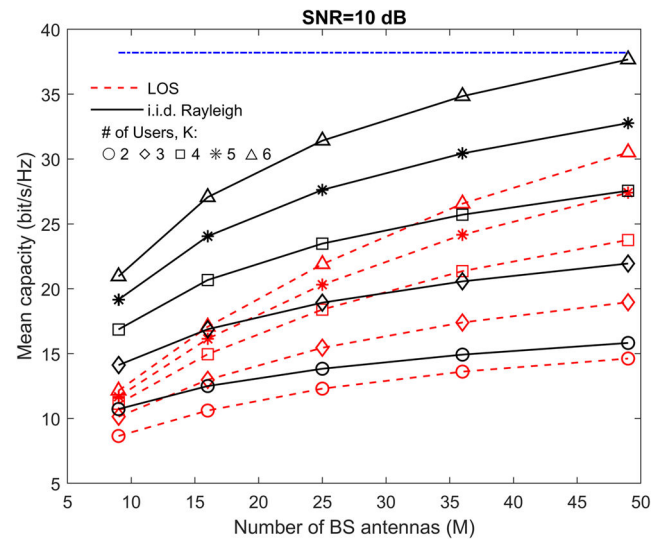

Fig. 7 Mean capacity of the system against the number of antennas at the BS for site 1 (LOS) and Rayleigh channels

value, it is observed that the loss of capacity when compared with the i.i.d. channels increases with K , and its value remains practically constant for SNR values above 5 dB. For example, the loss of capacity in the worst case ($K=6$ in the NLOS situation) reaches 10 bit/s/Hz.

To complete the analysis, Fig. 7 shows for site 1 (LOS) the mean value of the capacity of the MU-MIMO system for different numbers of active UTs ($K=2, 3, 4, 5$ and 6), as the number of antennas at the BS side increases ($M=9, 16, 25, 36$ and 49). The results are compared with those achieved for i.i.d. Rayleigh channels, as well as with the asymptotic value of 38.2 bit/s/Hz obtained according to (6) for $M=49$ and $K=6$. In all cases, there is an increase in capacity as the number of antennas at the BS array becomes higher, but the measured capacities do not reach the values of the theoretical channels, with capacity losses of the order of 7 bit/s/Hz. It can also be observed that the increase in the number of active UTs leads to an increase in capacity. This gain is practically linear for the case of i.i.d. channels, although in real channels the capacity gain decreases as K increases.

Finally, Fig. 8 shows the mean value of the capacity of the system for both environments and different numbers of antennas at the BS. It can be seen that for the NLOS scenario the propagation conditions are less favourable and thus, the increase in capacity with the number of antennas of the BS is slower than in the LOS situation. In fact, the loss of capacity with respect to the i.i.d. channel for $K=6$ and $M=49$, reaches 13 bit/s/Hz.

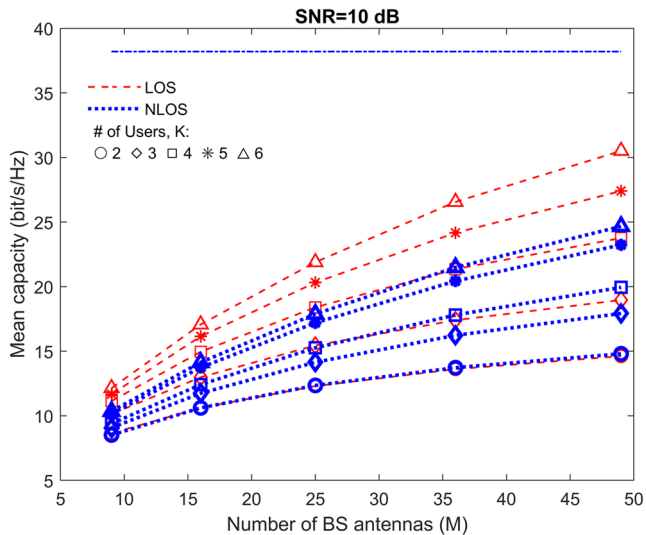

Fig. 8 Mean capacity of the system against the number of antennas at the BS for both scenarios

5 Conclusion

The possibilities of using MU-MIMO in indoor environments in the 3–4 GHz band through an empirical characterisation of the MU-MIMO-OFDM channel have been investigated in this paper. The proposed model concentrates on the UL of a single cell and it considers a BS consisting of a 7×7 planar array and a maximum of 6 active UTs. The following paragraphs summarise the main conclusions that can be drawn from the empirical data.

The orthogonality coefficient of the sub-channels taken two by two gives an incomplete estimate of the degree to which a specific multi-user channel verifies the condition of ‘favourable propagation’. The structure of the channel matrix when the number of active UTs increases is critical to establish the joint orthogonality of the channels, and thus the achievable sum-rate.

The degree of global orthogonality of the columns of the channel matrix can be achieved by analysing the distribution of the eigenvalues of the channel matrix, either directly or through the statistical behaviour of the condition number or its inverse. Unlike the orthogonality coefficient, the statistical distributions of the ICN do make it possible to differentiate the two propagation environments. In both environments, the CDF of the ICN obtained presents medium values lower than the corresponding i.i.d. for the same number of active UTs, which verifies that in both environments there is a clear loss of orthogonality with respect to the i.i.d channels.

When comparing the two environments, it is observed that the LOS one presents a more favourable propagation than the NLOS. This result differs from that obtained by other authors in outdoor channels, where NLOS situations present better orthogonality than the LOS ones. However, indoor scenarios often lead to complex propagation conditions, in which LOS situations may offer a greater scattering richness than the NLOS ones. Therefore, the conclusion is that in indoor environments, both the specific environment and the spatial distribution of the UTs determine the goodness of the channel. In this sense, it may be appropriate to

carry out measurements and simulations where realistic situations are considered and where links with different levels of obstruction between the BS and the UT can be mixed.

A characterisation of the channel against the achievable spectral efficiency is obtained through the calculation of the CDF of the measured channels capacity against frequency. The results achieved show how the measured capacities are always lower than those corresponding to the i.i.d. channels according to the ICN values obtained. This difference increases with the number of active UTs. For $K=6$, differences between sites 1 and 2 become higher, both having a high loss of capacity with respect to the theoretical i.i.d channels, showing losses on the median capacity of 7 and 15 bit/s/Hz in site 1 (LOS) and site 2 (NLOS) environments.

An important conclusion refers to how the mean capacities vary as the number of BS antennas increases for different number of UTs. In all cases, there is an increase in capacity as the number of antennas at the BS array becomes higher, but the measured capacities do not reach the values of the theoretical channels, with capacity losses of the order of 19 and 35% for LOS and NLOS scenarios, respectively.

Finally, it can be stated that despite the fact that there is a significant loss of capacity with respect to the ideal channels, important rates can still be achieved on real channels. Furthermore, the trend of the capacity curves with respect to the number of BS antennas also allows us to state that the spectral efficiency of the system could be considerably improved with a moderate increase in the number of antennas at the BS.

6 Acknowledgments

This work has been supported by the Spanish Ministerio de Economía, Industria y Competitividad under the projects TEC2017-86779-C2-1-R and TEC2017-86779-C2-2-R.

7 References

- [1] ‘The future of IMT in the 3300–4200 MHz frequency range’. <https://new.gsacom.com/paper/future-imt-3300-4200-mhz-frequency-range/>, accessed 12 December 2018
- [2] Li, J., Zhao, Y.: ‘Channel characterization and modelling for large-scale antenna systems’. Proc. Int. Symp. Comm. Information Techn. (ISCIT), Incheon, Korea, September 2014, pp. 559–563
- [3] Gao, X., Edfors, O., Rusek, F., *et al.*: ‘Massive MIMO performance evaluation based on measured propagation data’, *IEEE Trans. Wirel. Commun.*, 2015, **14**, (7), pp. 3899–3911
- [4] Zhang, B., Zhong, Z., Ai, B., *et al.*: ‘Empirical evaluation of indoor multi-user MIMO channels with linear and planar large antenna arrays’. IEEE Int. Symp. Personal Indoor Mobile Radio Commun. (PIMRC), Montreal, Canada, October 2017, pp. 1–6
- [5] Hoydis, J., Hoek, C., Wild, T., *et al.*: ‘Channel measurements for large antenna arrays’. Int. Symp. Wireless Commun. Syst. (ISWCS), Paris, France, August 2012, pp. 811–815
- [6] Payami, S., Tufvesson, F.: ‘Channel measurements and analysis for very large array systems at 2.6 GHz’. European Conf. Ant. Propagat. (EUCAP), Prague, Czech Republic, March 2012, pp. 811–815
- [7] Marzetta, T.L.: ‘Noncooperative cellular wireless with unlimited numbers of base station antennas’, *IEEE Trans. Wirel. Commun.*, 2010, **9**, (11), pp. 3590–3600
- [8] Rusek, F., Persson, D., Lau, B.K., *et al.*: ‘Scaling up MIMO: opportunities and challenges with very large arrays’, *IEEE Signal Process. Mag.*, 2013, **30**, (1), pp. 40–60
- [9] Jaramillo, R., Fernández, Ó., Torres, R.P.: ‘Empirical analysis of a 2×2 MIMO channel in outdoor-indoor scenarios for BFWA applications’, *IEEE Antennas Propag. Mag.*, 2006, **48**, (6), pp. 57–67