



**Università
degli Studi
di Palermo**



**UNIVERSITAT
POLITÈCNICA
DE VALÈNCIA**

The Human Biodiversity in the Middle of the Mediterranean

Study of native and settlers populations on the Sicilian context

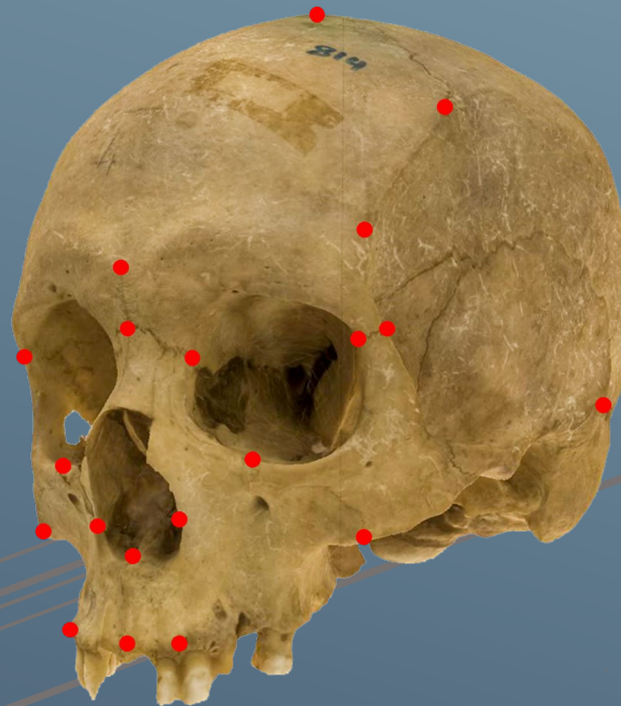

Gabriele Lauria

Università degli Studi di Palermo (UNIPA) – Universitat Politècnica de València (UPV)

PhD Thesis

Supervisors Prof. Luca Sineo (UNIPA) – Prof. Vicente D. Estruch-Fuster (UPV)

NOVEMBER 2020



**Università
degli Studi
di Palermo**



**UNIVERSITAT
POLITÈCNICA
DE VALÈNCIA**

Biodiversità Mediterranea – Internazionale-Europeus
Dipartimento di Scienze Agrarie, Alimentari e Forestali
Dipartimento di Scienze e Tecnologie Biologiche Chimiche e Farmaceutiche
BIO/08

Ciencia y Tecnología de la Producción Animal
Departamento de Ciencia Animal

**The Human Biodiversity in the Middle of the
Mediterranean**
Study of native and settlers populations on the Sicilian context

PhD CANDIDATE

GABRIELE LAURIA

PhD COORDINATOR

PROF. MARIA ANTONIETTA GERMANA'

SUPERVISOR

PROF. LUCA SINEO

CO-SUPERVISOR

PROF. VICENTE ESTRUCH-FUSTER

TUTOR

PROF. MIGUEL JOVER-CERDA'

CICLO XXXII
NOVEMBER 2020

This page was intentionally left blank

The Human Biodiversity in the Middle of the Mediterranean

Study of native and settlers populations on the Sicilian context

PhD Thesis

Gabriele Lauria

 [0000-0002-0122-7093](https://orcid.org/0000-0002-0122-7093)



Department of “Scienze Alimentari Agrarie e Forestali” (SAAF)
Department of “Scienze Biologiche Chimiche e Farmaceutiche” (STEBICEF)

University of Palermo (UNIPA)

Department of “Ciencia Animal”

Polytechnic University of Valencia (UPV)

Thesis submitted by **Gabriele Lauria** to get the
Europeaus PhD in ‘‘Mediterranean Biodiversity-International’’ ([UNIPA](#))

and the in PhD in ‘‘Science and Technology of Animal Production’’
in Co-Tutorship with the ([UPV](#))

Supervisors

Prof. **Luca Sineo** (UNIPA)

Prof. **Vicente Domingo Estruch-Fuster** (UPV)

Tutor

Prof. **Miguel Jover-Cerdá** (UPV)

PhD Coordinators

Prof. **Maria Antonietta Germana**’ (UNIPA)

Prof. **Maria del Pilar Hernández-Pérez** (UPV)

Special Thanks to

Dr. **Emiliano Bruner** (CENIEH)

Prof. **Armando González-Martín** (UAM)

Prof. **Oscar Cambra-Moo** (UAM)

«'O brothers, who amid a hundred thousand
Perils,' I said, 'have come unto the West,
to this so inconsiderable vigil

Which is remaining of your senses still
be ye unwilling to deny the knowledge,
Following the sun, of the unpeopled world.

**Consider ye the seed from which ye sprang;
Ye were not made to live like unto brutes,
But for pursuit of virtue and of knowledge.»**

Divine Comedy

Hell- canto 26° (vv 112-120)

“Dante Alighieri”

Traslated by Henry Francis Cary - 1814

«"O frati," dissi, "che per cento milia
perigli siete giunti a l'occidente,
a questa tanto picciola vigilia

d'i nostri sensi ch'è del rimanente
non vogliate negar l'esperienza,
di retro al sol, del mondo senza gente.

**Considerate la vostra semenza:
fatti non foste a viver come bruti,
ma per seguir virtute e canoscenza".»**

Divina Commedia

Inferno- canto 26° (w. 112-120)

“Dante Alighieri”



Virgilio (Virgil) shows Dante Alighieri the flames of the fraudulent advisers.

Illustration by Paul Gustave Doré - 1861

To my Family
that always gives me the strength to never give up
and for the indefatigable support.

To my Friends
who tolerate me every day.

To all who suffer in these sad moments.

This page was intentionally left blank

Summary

During the last 200,000 years, human species has spread throughout Earth, adapting their morphology and physiology to a wide range of habitats. The human skeleton has therefore, recorded the main environmental effects and consequently, skeletal findings assume great importance on the investigation of the evolutionary processes.

Nowadays modern quantitative investigations of the main morphological features permit us to relate them with the genetic variability.

The Sicilian geographic position, isolation and its long and dynamic history of colonization (several and different cultural and biological contribution) made a peculiar context that allows a unique anthropological study, useful to sign-out important information about the “Migratory Flow” and the consequent “Populations Influx” on Human Skeletal Remains.

This project is based on the Anthropological Analysis of the human bones coming from different populations (indigenous and colonizers) distributed from Paleolithic to the Contemporary Age.

The most modern techniques of Morphometric Geometric analysis (3D reconstruction) and Multivariate Statistic Analysis were applied over three different catchers (Teeth, Skulls and Stature).

The project aim is to perform a wide analysis of the Sicilian Human Biodiversity in order to:

- ✓ Analyze 2D odontometrics data with multivariate techniques to explore the relationships between the peoples over the centuries.*
- ✓ Use 3D models and skull-facial morphometry to study the complex morphological variability concerning the Populations.*
- ✓ Evaluate the “Stature’s Secular Trend”.*
- ✓ Use these three characters to provide a general overview of the human biodiversity in Sicily.*

Our work denotes the reliable of the methods employed underlying as in a study of biodiversity several characters are indispensable to understand the

evolutionary process. Data also provided to demonstrate the correlation between the morphological characters and the influence carried (not only by the environmental factors) by the human flow on the phenotype.

Results clearly shows as all the characters evaluated are at the same time involved in the same process of diversification.

Morphological variations show a general decrease of Maxilla Prognathism and a soft Mesocephalization with the skull that becomes tighter and slightly and less elongated and the face that become wider and shorter.

Always considering simple size/composition both Canonical and Multivariate Statistics Analysis display, as the Upper-Paleolithic Würm-Settlers of San Teodoro could reasonably be the first evidence of human colonization in Sicily (this theory is supported by the Mesolithic Hunter- Gatherers specimens clustered separated from the first one).

Meaningful is the periods of Bronze/Iron transition in we assist to the prime plainness of morphological changes (teeth, skulls and statures) due to the constant and numerically significative "Migratory Flows". This variation exactly coincides with the first "Population Influx" consequent of the human migrations from the continent.

Instead, Prehistorical samples of some populations, keep some archaic characters after Iron Age (Historical Era) the "Population Continuity" (consequent of the cohabitation and alternations of the several Mediterranean populations) from Antiquity to Middle Ages produced a progressive increase of variability without big variation among Eigenvalue and Principal Component.

The absence of internal relationship caused by the intricate colonization period is on the contrary present on Prehistorical sample on which we can find a clear variation between the PC.

Correlations between "Population Influx" and Variability are also observable on the influence of Islamic settlers on the Indigenous during the Middle Ages. However, the wide variability and the homogenous morphospace showed by these groups and the Contemporary resulted in no well-defined populations.

Riassunto

Negli ultimi 200.000 anni, la specie umana si è diffusa in tutta la Terra, adattando la sua morfologia e fisiologia a un'ampia gamma di habitat. Lo scheletro umano ha quindi registrato i principali effetti ambientali e di conseguenza i reperti scheletrici assumono grande importanza nell'indagine dei processi evolutivi.

Oggi le moderne tecniche di indagini quantitative delle principali caratteristiche morfologiche consentono di metterle in relazione con la variabilità genetica.

La posizione geografica della Sicilia, l'isolamento e la sua lunga e dinamica storia di colonizzazione (diversi e numerosi contributi culturali e biologici) hanno creato un contesto peculiare che consente uno studio antropologico unico, utile per sottrarre informazioni importanti sul "Flusso Migratorio" e il conseguente "Influenza delle Popolazioni" sui resti scheletrici umani.

Questo progetto si basa sull'analisi antropologica delle ossa umane provenienti da diverse popolazioni (indigene e colonizzatori) distribuite dal Paleolitico all'Età Contemporanea. Le più moderne tecniche di Analisi Geometria Morfometrica (ricostruzione 3D) e di Analisi Statistica Multivariata sono state applicate su tre diversi caratteri scheletrici (Denti, Crani e Statura).

L'obiettivo del progetto è quello di eseguire un'ampia analisi della Biodiversità Umana Siciliana al fine di:

- ✓ Analizzare i dati odontometrici 2D con tecniche multivariate per esplorare le relazioni tra i popoli nel corso dei secoli.*
- ✓ Usare modelli 3D e la morfometria cranio-facciale per studiare la complesso variabilità morfologica relativa alle influenze dei flussi migratori.*
- ✓ Valutare il Secular Trend della Statura.*
- ✓ Usare questi tre caratteri per fornire una panoramica generale della Biodiversità Umana in Sicilia.*

Il nostro lavoro denota l'affidabilità dei metodi impiegati e come in uno studio sulla biodiversità diversi caratteri sono indispensabili per comprendere il processo evolutivo. I dati forniti dimostrano anche la correlazione tra i caratteri morfologici

e l'influenza esercitata (non solo dai fattori ambientali) dal flusso umano sul fenotipo.

I risultati mostrano chiaramente come tutti i caratteri valutati siano coinvolti allo stesso tempo nello stesso processo di diversificazione.

Le variazioni morfologiche mostrano una generale diminuzione del prognatismo mascellare e una leggera mesocefalizzazione con il cranio che diventa più stretto e leggermente e meno allungato e il viso che diventa più largo e più corto.

Considerando sempre l'influenza del rapporto dimensione/composizione sia l'analisi statistica canonica che quella multivariata, supportano la teoria che i coloni del Paleolitico superiore di San Teodoro potrebbero ragionevolmente essere la prima prova di colonizzazione umana in Sicilia (questa teoria è anche supportata dai campioni Mesolitici che clusterizzano separati dai primi).

Significativi sono i periodi del Bronzo della transizione Bronzo/Ferro nei quali assistiamo ad importanti cambiamenti morfologici (Denti, Crani e Stature) dovuti a "Flussi Migratori" costanti e numericamente significativi. Questa variazione coincide esattamente con i primi "Afflussi di Popolazione" stabili conseguenti alle migrazioni umane dal continente.

Tuttavia i campioni preistorici di alcune popolazioni, conservano alcuni caratteri arcaici anche dopo l'Età del Ferro (Era Storica) mentre la "Continuità di Popolazione" (conseguente alla convivenza e agli alternamenti delle diverse colonizzazioni) dall'Antichità al Medioevo ha prodotto un progressivo aumento della variabilità senza grandi variazioni tra Eigenvalue e Componenti Principali. L'assenza di relazione interna causata dall'intricato periodo di colonizzazione è invece presente sul campione preistorico sul quale si riscontra una netta variazione tra i PC.

Le correlazioni tra "Afflusso di popolazione" e Variabilità sono osservabili anche nell'influenza dei coloni islamici sugli indigeni durante il Medioevo. Tuttavia, l'ampia variabilità e il morfospazio omogeneo mostrano che dopo questi gruppi (fino ai Contemporanei) sono riconoscibili popolazioni ben definite.

Resumen

Durante los últimos 200.000 años, la especie humana se ha extendido por toda la Tierra, adaptando su morfología y fisiología a una amplia variedad de hábitats. Por tanto, el esqueleto humano ha registrado los principales efectos ambientales y, en consecuencia, los restos esqueléticos asumen una gran importancia en la investigación de los procesos evolutivos.

Hoy las modernas técnicas de investigaciones cuantitativas de las principales características morfológicas nos permiten relacionarlas con la variabilidad genética.

La posición geográfica de la Sicilia, su aislamiento y su larga y dinámica historia de colonización (diversas y numerosas contribuciones culturales y biológicas) han creado un contexto peculiar que permite un estudio antropológico único, útil para extraer información importante sobre el "Flujo Migratorio" y "Influencia Población" en los restos óseos humanos.

Este proyecto se basa en la análisis antropológica de huesos humanos de diferentes poblaciones (indígenas y colonizadoras) desde el Paleolítico hasta la Edad Contemporánea. Las técnicas más modernas de Análisis de Geometría Morfométrica (reconstrucción 3D) y Análisis Estadístico Multivariante se han aplicado en tres caracteres esqueléticos diferentes (Dientes, Cráneos y Estatura). El objetivo del proyecto es realizar un análisis amplia de la Biodiversidad Humana Siciliana con el fin de:

- ✓ Analizar datos odontométricos 2D con técnicas multivariadas para explorar las relaciones entre pueblos entre los siglos.*
- ✓ Utilizar modelos 3D y la morfometría craneofacial para estudiar la compleja variabilidad morfológica relacionada con los flujos migratorios.*
- ✓ Evaluar la tendencia secular de la estatura.*
- ✓ Utilizar estos tres caracteres para proporcionar una descripción general de la Biodiversidad Humana en Sicilia.*

Esto trabajo denota la confiabilidad de los métodos utilizados y, como en un estudio de la biodiversidad, varios caracteres son indispensables para comprender el proceso evolutivo. Los datos también demuestran la correlación entre los caracteres morfológicos y la influencia (no solo por factores ambientales) de los flujos humanos sobre el fenotipo.

Los resultados muestran claramente que todos los caracteres evaluados están involucrados al mismo tiempo en el mismo proceso de diversificación.

Las variaciones morfológicas muestran una disminución general del prognatismo maxilar y una ligera mesocefalilización con el cráneo que se convierte en más estrecho y ligeramente y menos alargado y la cara más ancha y corta.

Siempre considerando la influencia de la relación tamaño/composición, de la muestra, tanto el análisis estadístico canónico como multivariado apoyan la teoría que la población del Paleolítico Superior de San Teodoro podría ser razonablemente la primera evidencia de colonización humana en Sicilia (esta teoría también es apoyada de la muestra Mesolítica que se agrupa separada).

Son significativos los periodos de el Bronce y de la transición Bronce/Hierro en los que asistimos a importantes cambios morfológicos (Dientes, Cráneos y Estatura) debido a los constantes y numéricamente significativos "Flujos Migratorios". Esta variación coincide exactamente con los primeros "Flujos de Población" estables como consecuencia de las migraciones humanas desde el continente.

Sin embargo, las muestras Prehistóricas de algunas poblaciones conservan algunas características arcaicas incluso después de la Edad del Hierro (Era Histórica) mientras la "Continuidad de la Población" (resultante de la coexistencia y alternancia de la colonización) desde la Antigüedad hasta la Edad Media produjo una mayor progresiva variabilidad sin pero mayor variación entre Eigenvalue y Componentes Principales.

La ausencia de relación interna causada por el intrincado período de colonización está presente, en contrero, en la muestra prehistórica en la que hay una clara variación entre las Componentes Principales.

Las correlaciones entre la "Afluencia de Población" y la Variabilidad también se pueden observar en la influencia de los colonos Islámicos sobre los indígenas durante la Edad Media. Sin embargo, la amplia variabilidad y el morfoespacio homogéneo muestran que poblaciones bien definidas no son reconocibles después de estos grupos (hasta los contemporáneos).

Resum

Durant els últims 200.000 anys, l'espècie humana s'ha estès per tota la Terra, adaptant la seua morfologia i fisiologia a una àmplia varietat d'hàbitats. Per tant, l'esquelet humà ha registrat els principals efectes ambientals i, en conseqüència, les restes esquelètiques assumeixen una gran importància en la investigació dels processos evolutius. Hui les modernes tècniques d'investigacions quantitatives de les principals característiques morfològiques ens permeten relacionar-les amb la variabilitat genètica.

La posició geogràfica de la Sicília, el seu aïllament i la seua llarga i dinàmica història de colonització (diverses i nombroses contribucions culturals i biològiques) han creat un context peculiar que permet un estudi antropològic únic, útil per a extraure informació important sobre el "Flux Migratori" i "Influència Població" en les restes òssies humanes.

Aquest projecte es basa en l'anàlisi antropològica d'ossos humans de diferents poblacions (indígenes i colonitzadores) des del Paleolític fins a l'Edat Contemporània. Les tècniques més modernes d'Anàlisi de Geometria Morfomètrica (reconstrucció 3D) i Anàlisi Estadística Multivariante s'han aplicat en tres caràcters esquelètics diferents (Dents, Cranis i Alçada).

L'objectiu del projecte és realitzar una anàlisi àmplia de la Biodiversitat Humana Siciliana amb la finalitat de:

- ✓ Analitzar dades odontomètrics 2D amb tècniques multivariades per a explorar les relacions entre pobles entre els segles.*
- ✓ Utilitzar models 3D i la morfometria craniofacial per a estudiar la complexa variabilitat morfològica relacionada amb els fluxos migratoris.*
- ✓ Avaluar la tendència secular de l'alçada.*
- ✓ Utilitzar aquests tres caràcters per a proporcionar una descripció general de la Biodiversitat Humana a Sicília.*

Això treball denota la confiabilitat dels mètodes utilitzats i, com en un estudi de la biodiversitat, diversos caràcters són indispensables per a comprendre el procés evolutiu. Les dades també demostren la correlació entre els caràcters

morfològics i la influència (no sols per factors ambientals) dels fluxos humans sobre el fenotip.

Els resultats mostren clarament que tots els caràcters avaluats estan involucrats al mateix temps en el mateix procés de diversificació.

Les variacions morfològiques mostren una disminució general del prognatisme maxil·lar i una lleugera mesocefalització amb el crani que es converteix en més estret i lleugerament i menys allargat i la cara més ampla i tala.

Sempre considerant la influència de la relació grandària/composició, de la mostra, tant l'anàlisi estadística canònica com multivariat donen suport a la teoria que la població del Paleolític Superior de Sant Teodoro podria ser raonablement la primera evidència de colonització humana a Sicília (aquesta teoria també és secundada de la mostra Mesolítica que s'agrupa separada).

Són significatius els períodes del Bronze i de la transició Bronze/Ferro en els quals assistim a importants canvis morfològics (Dents, Cranis i Alçada) a causa dels constants i numèricament significatius "Fluxos Migratoris". Aquesta variació coincideix exactament amb els primers "Fluxos de Població" estables com a conseqüència de les migracions humanes des del continent. No obstant això, les mostres Prehistòriques d'algunes poblacions conserven algunes característiques arcaiques fins i tot després de l'Edat del Ferro (Era Històrica) mentre la "Continuïtat de la Població" (resultant de la coexistència i alternança de la colonització) des de l'Antiguitat fins a l'Edat mitjana va produir una major progressiva variabilitat sense però major variació entre Eignevalue i Components Principals.

L'absència de relació interna causada per l'intricat període de colonització està present, en contrero, en la mostra prehistòrica en la qual hi ha una clara variació entre les Components Principals.

Les correlacions entre l' "Afluència de Població" i la Variabilitat també es poden observar en la influència dels colons Islàmics sobre els indígenes durant l'Edat mitjana. No obstant això, l'àmplia variabilitat i el morfoespacio homogeni mostren que poblacions ben definides no són recognoscibles després d'aquests grups (fins als contemporanis).

Index

Summary	8
Riassunto	10
Resumen	12
Index	17
1. Introduction	19
1.1 Human Biodiversity and the Sicilian Context	19
1.2 Aim of the Study	22
1.3 Teeth – Genesis, Evolution and Structure	24
1.4 Odontology in Anthropological Studies	27
1.5 Cranium – Structure and Development	28
1.6 Craniofacial Sutures	33
1.7 Measurement of the Cranium – Craniometry	37
1.8 Photogrammetry – History and Basic concepts	41
1.9 Geometric Morphometrics – Key concepts	47
1.10 Multivariate Statistical Analysis in Physical Anthropology	58
1.11 Stature and Secular Trend	66
1.12 Biological Distance from Skeletal Remains	70
2. Materials and Methods	72
2.1 Materials	72
2.1.1 Teeth 2D Measurements	80
2.1.2 Craniofacial 3D Geometric Morphometrics	82
2.1.3 Secular Trend of Stature	85
2.2 Methods	87
2.2.1 Dental Metrics	88
2.2.2 Geometric Morphometrics	91
2.2.3 Secular Trend	103
3. Results and Discussion	106
3.1 Dental Metrics	106
3.1.1 Preliminary Studies	106
3.1.2 Recent Data	109
3.1.3 PCA	110
3.1.4 MANOVA/CVA and MDS	119

3.1.5 Neighbour Joining	122
3.2 Geometric Morphometrics	123
3.2.1 Craniofacial Geometric Morphometrics in Sicily	124
3.2.2 PCA.....	130
3.2.3 MANOVA/CVA.....	139
3.2.4 Neighbour Joining	141
3.2.5 Groups' Geometric Morphometrics.....	142
3.2.6 Groups' PCA	148
3.2.7 Group's Neighbour Joining.....	158
3.2.8 Comparison Sample	160
3.2.9 Precis	165
3.3 Secular Trend	170
3.3.1 Canonical Statistics	171
3.3.2 Multivariate Statistics.....	177
4. Conclusion	180
Bibliography	183
Appendix1	253
Appendix2	258
Acknowledgements	261

1. Introduction

1.1 Human Biodiversity and the Sicilian Context

Humans are subjected to adaptations and evolutionary process ruled by the environment. During the last 200,000 years, human species has spread throughout Earth, adapting his morphology and physiology to a wide range of habitats ([Kuzawa & Thayer 2011](#)).

The human skeleton is, therefore, a real "Biological Archive" on which are recorded several environmental effects ([Mays 2010](#)), consequently, skeletal findings assume huge importance on the investigation of the evolutionary processes.

Nowadays, the study on human bones made possible to detect important data related to the "Human Biodiversity" evidently not limited to demographic and pathological studies ([Ortner 2003](#) – [Brickley & Ives 2010](#)). Quantitative investigations of the main morphological features allow relating them with the genetic variability.

Hereditary genetic changes are the basis of phenotypic variations and are the essential prerequisite for the natural selection. Without phenotypic variation, there would be no adaptations and evolution by natural selection.

Instead, this principle is generally true natural selection not always match exactly with genetic variations and the morphological features.

To determine phenotype often occurs other important phenomena like gene flow and genetic drift, done by random factors, that could change the genetic pool of a

population. These “atypical forces” of natural selection can make an allele more common or rarer changing randomly the phenotype.

Bottle Neck and Founder Effect ([Mayr 1963](#)) ([Manica et al. 2007](#)) are two of these phenomena, which (as we will see) have quickly and significantly influenced the Sicilian phenotype.

Several populations, each of which has left his cultural and biological contribution, have colonized Sicily since prehistory. Geographic isolation and the position in the middle of the Mediterranean area made a peculiar context that allows the chance for a unique anthropological study, useful to sign-out important informations about the "Human Biodiversity" in the Mediterranean and Insular context.

Sicily is the biggest island on the Mediterranean Sea and is located on its centre. For size and peculiar position, Sicily undoubtedly allowed the isolation and microevolution processes quite impossible on the continent ([Massa et. al 2011](#)). Indeed, since its emersion from the sea (4 million years ago) Sicily was "reservoir" for populations coming from and going to the southern Apennine Italy and the north of the Maghreb area ([Ruggieri 1973](#)). Moreover, the several Sicilian's biogeographical conditions (caused by mountain ranges, valleys and weather) produced a huge diversification of habitats (high rate of endemism) and different relationship with the European and African continents ([La Greca 1957](#)).

A lot of species (plant and vegetable, insects, reptiles and amphibious and mammals) were so characterized by an intense phase of radiations due to the isolations (founder effect) for many generations not only from the continents but also in the same island ([La Greca 1961](#)). It's realistic to imagine Sicily divisible

into separate blocks on which it is easy to see the effective segregation of genes responsible for small morphological changes. Human species on Sicily is not an exception, in fact, as highlighted by recent studies, Sicilian's populations are characterized (since the Paleolithic) by a phenomenon of human-vegetation coevolution ([Pingatti 2011](#)) that has produced profound changes in the landscape and in all the species involved. The evolution (at the level of the individual species) could be related to these coevolution and ecology alterations that produced several cases of apomixes on vegetation and allows micro-evolution of the sympatric and parapatric human's systems.

Sicilian context can be used to test methodology that will provide important data useful in another context.

However, despite this singular situation (which include Settlers, Prehistoric, Greek, Carthaginian, Roman, Islamic, and Norman population dynamics) adequate and complete studies of physical anthropology have been neglected in the past ([Becker 1995](#)).

Moreover, the recent analytical techniques as like GM, 3D imaging, photogrammetry and CT scanning have increased the power of skeletal biology in providing data on population's biological variability and dynamics ([Stock et. al 2007](#) - [Gunz et. al 2009a](#)).

1.2 Aim of the Study

The project aim is to achieve a wide analysis of the Sicilian Human Biodiversity in order to:

- ✓ Analyze 2D odontometrics data with multivariate techniques to explore the relationships between the peoples over the centuries.
- ✓ Use 3D models and skull-facial morphometry to study the complex morphological variability concerning the "migration influx".
- ✓ Evaluate the "Stature's Secular Trend".
- ✓ Realize a probabilistic scenario of the peopling by tracing human flows and their dynamics on the Sicilian territory.
- ✓ Use these three characters to provide a general overview of the human biodiversity in Sicily.

This study will help to collect important data about Human Biodiversity in the Mediterranean and Sicily and will clarify the articulated dynamics that has generated the current cultural, genetic and morphological heterogeneity.

Moreover, combining data from different Mediterranean populations will expand our knowledge about the relationship between the morphological changes, genetic variability and environment.

For this purpose, Geometric Morphometrics will be used to perform a reconstruction of the population in Sicily, tracing the migratory flows of *Homo sapiens* and their dynamics on Sicilian territory, also highlighting the influences from and to the Continental Europe and the African continent.

The study also wants to show the efficiency of skeletal comparative analysis in reconstructing biological distances.

This diachronic approach on the Sicilian populations will allow to test and compare both 2D and 3D data, highlighting limits and strength points (in small and large scale) and providing to realize a not expensive and quick alternative to the most popular molecular techniques.

1.3 Teeth – Genesis, Evolution and Structure

Teeth are, without any doubt, the most preserved fossil and sub-fossil records. Due to their peculiar structure and compositions (in particular the hardness of enamel) are, compared with the other organic tissue, (subject to environmental and biological degradation) the much more durable body elements.

Teeth, with appropriate study methods, are therefore able to tell us their evolutionary history ([Mallegni 2001](#)).

Anatomical and comparative studies based on teeth are used to reconstruct phylogenetic and evolutionary mechanisms in all the mammals ([Gingerich 1974](#)) because of their forms, sizes and shapes, changes during centuries according to the evolution of each species. Indeed, species had developed their peculiar dentition (number, form and size) a result of evolution to the adaptations at the environment. In this process mammals have the highest level of teeth's specialization, in fact, have different teeth between and inside a species, about their functions ([Walker et. al 1978](#)). In particular human species is characterized by deciduous and permanent teeth (20 deciduous and 32 permanents) ([Aiello & Dean 1990](#)) divided into different categories adapted for a specific function.

They are real '*index fossilis*' used as markers in palaeontology, paleozoology and palaeoanthropology, and since the last 30 years were subjected to specific researches that today constitute a well-defined discipline called Odontology ([Alt et. al 1998](#)).

Summarizing and considering the evolution and the development of teeth (from Synapsid Reptiles to Mammals) it is possible to identify six adaptive radiations ([Olson 1959](#)).

Teeth ([Brothwell 2014](#)), especially in the mammals, play an important role in the first phase of nutritional processes cutting and chopping food (Hillson 1986) (made it more digestible by gastric juices). Indeed they come from mesenchymal tissue as bones are considered part of the digestive system, moreover, this is justified by the fact that enamel ([Boyde 1964 - 1968 – 1976 - 1989](#)) come from ectoderm as the other epithelial tissue (they also perform an aesthetic function, maybe the evolution of the attack and defence function from other animals).

They are macroscopic ([Lautrou et. al 1982](#)) formed by a crown (in the oral cavity) and a root (implanted in the buccal cavity) while microscopically ([Fejerskov & Thylstrup 1986](#)) are composed by:

- Enamel: covers the part exposed to the environment and for these reasons, is the hardest. Of ectodermal origin is composed of large crystals orderly arranged (96% inorganic, 4% organic).
- Dentin: mineralized connective tissue (mesenchymal origin), without vessels, covers the pulp and are the main morphological structure of the tooth (72% inorganic, 28% organic).
- Cement: specialized connective tissue of collagens slightly mineralize and hard that covers the root (65% inorganic, 23% organic, 12% water) as dentin do not have vessels. It is never subjected by remodelling.

- Dental Pulp: loose connective tissue of gelatinous consistency composed by a network of fibres containing blood vessels and filaments of the trigeminal nerves. Is a huge part of the tooth form and is covered by dentin (25% organic, 75% water).

Human's teeth are divided incisors, canines and molars in the deciduous dentition and incisors, canines, premolars and molars, in the permanent dentition ([Ubelaker 1989](#)). They are all different form each other, from the same group, the different arches and plays a different role in the nutrition:

- Incisors: With canines are the anterior teeth and in addition to a facial aesthetics importance are deputies to grab food.
(In each arch 4 in permanent dentition and 4 in deciduous dentition).
- Canines: Are specialized to immobilize (prey and food) and in helping in the initial food processing.
(In each arch 2 in permanent dentition and 2 in deciduous dentition).
- Premolars: Play a role of transition between canines and molars cutting and chopping food.
(In each arch 4 in permanent dentition and 0 in deciduous dentition).
- Molars: their role is to chop the food and prepare it for digestion.
(In each arch 6 in permanent dentition and 4 in deciduous dentition).

Summarizing humans, during childhood, have 20 teeth on deciduous dentition the will increase in the number of 32 in adulthood during permanent dentition ([Hillson 1986](#)).

1.4 Odontology in Anthropological Studies

Odontological studies allow identifying and quantifying the phenotypic variations among different human populations, (both in micro and macro evolutionary studies) because teeth form and size changes reflect the interaction between genotype and environment. So is possible to study both qualitative (discontinuous characters – no metric – presence or absence) and quantitative (continuous characters – metric – dimension scale) variation.

Teeth's dimensional variation is commonly used in palaeoanthropology as a powerful diagnostic tool; especially in "Comparative Population Studies" to focus the interaction between genetic and environment during the centuries and the migratory flows among different populations ([Alvesalo 1971](#)) ([Goose & Roberts 1982](#)). Teeth size and dimensions are under a polygenic control influenced by environmental factors as prolonged gestation time, large body size and high weight at birth, maternal diabetes hypothyroidism ([Garn et. al 1980](#)).

Morphological investigation of teeth has proven to be a useful tool in the characterization of the human group able to underline the biological distance between past and contemporaneous populations; morphological character is demonstrated to be real genetic markers easy to achieve and comparable with other markers like DNA ([Nichol 1989](#)) ([Scott & Turner 1997](#)).

Dimensional teeth's analysis is applicable as in large continental-scale as in more limited areas, providing, in any case, a useful diachronic investigation.

1.5 Cranium – Structure and Development

Cranium is an anatomical district of the body that forms the head in vertebrates.

It is linked with the mandible and together forms the skull ([Liem et. al 2002](#)).

Cranium is composed of two main parts, the Splanchnocranium (facial cranium) and the Neurocranium. It protects the brain and several sensory structures such as eyes (stereoscopic vision), ears, nose, and mouth driving them in the correct position. Cranium also contains air-filled cavities and numerous foramina that housed the respiratory epithelium ([Standring 2017](#)) (the area delegated to warming and moistening the air drawn into the nasal cavity), decrease the weight of the entire structure and increase the resonance to the voice. They also allow the passage of the spinal cord as well as nerves and blood vessels.

He is made up of several fused flat and pneumatic bones.

The development of the skulls (cranium and mandible) is the result of the growth three main areas ([Flugel et. al 1993](#)) of different embryological origin ([Clarson 1999](#)):

1. Neurocranium: (or braincase) is a case that surrounds and protect the brain and brainstem from injury.
2. Sutures: typical of Neurocranium, are rigid joints between bones.
3. Facial skeleton: (or membranous viscerocranium) is made by the bones supporting the face (includes the mandible) that house visual, olfactory, respiratory and masticatory apparatus (jaws, muscles and teeth).

Each area has its development and growth linked to the function ([Arnold et. al 1998](#) – [Caussenot et. al 1998](#)).

Immovable sutures join all the bones of the cranium (except for the mandible) together. It generally consists of twenty-two bones ([Alcamo 2012](#)) ([White 2005](#)) (14 facial skeleton bones and 8 cranial bones). The occipital, two temporal, two parietal, the sphenoid, ethmoid and frontal bones in the Neurocranium and the vomer, two inferior nasal conchae, two nasal bones, two maxilla, the mandible, two palatine, two zygomatic and two lacrimal in the facial skeleton.

The bones of the Cranium are formed or by intramembranous or by endochondral ossification: roof, roof side and facial bones are formed by intramembranous ossification ([Gartner & Hyatt 2007](#)); contrariwise temporal bones and all the bones supporting the brain (occipital, sphenoid, and ethmoid) are formed by endochondral ossification.

The Intramembranous Ossification starts from the mesenchymal connective tissue where cells (differentiate into osteoblasts) begin to produce a bone matrix, spicules and trabeculae. Intramembranous ossification begins in peculiar areas called "*Primary Ossification Centers*" (different in number for each bone but in general not least of two), densely aggregated of cells that begin the production of osteoid. The osteoid is immediately mineralized from the bone trabecula and osteoblasts affix on this bone trabecula a new layer of osteoid. During this process, numerous osteoblasts are imprisoned in a matrix that will turn into osteocytes necessary for the metabolic demands of the cells. The bones formed in this way tend to have a macroscopically spongy appearance. The remaining mesenchymal tissue will transform into hematopoietic bone.

Endochondral Ossification allows the creation of resistant structures to the compression and therefore useful for the skeletal support function as movement, muscles, and ligaments attack sites. First, we assist at the mesenchymal tissue's thickening and subsequently at the production of several chondrogenic centres on which the mesenchymal cells differentiate into chondroblasts (precursors of the chondrocytes). Exactly in the same way as the intramembranous process, around these centres will be formed the perichondrium. The perichondrium made the hyaline cartilage that will form a cartilaginous model of the future bone. The chondroblasts, differentiated into chondrocytes reabsorb the cartilage maintaining the thin trabeculae. Finally, the chondrocytes degeneration leaves empty spaces that will subsequently be invaded by blood vessels and by hematopoietic stem cells. The cells contained in the perichondrium, therefore, acquires osteoblastic activity, transforming it into periosteum and thus forming the "primary ossification centres". The endochondral ossification so continues in the "*Secondary Ossification Centres*" as an ordered process (made a trabecular structure similar to intramembranous ossification).

This two way of ossification is an advantage because it gives resistance to the bone without making an excessive weight.

At birth, the cranium is moveable to ease childbirth and the later growth. It is made up of 44 bones ([Cunningham et. al 2016](#)) completely separated and linked each other by connective tissue (in the roof bones, these regions of connective tissue are called "fontanelles" - six in total: one frontal, one occipital, two sphenoids and two mastoids). Subsequently, different elements of these 44 bones and the connective tissue will ossify during development into solid bone.

The development of Skull ([Sperber 2001](#)), as the other part of the human body, is under the control of genes ([Carlson 1999](#)), growth factors and intercellular communications ([Francis-West et. al 1998](#)), so under the environmental pressure ([Hall 1990](#)).

The first step in the morphogenesis, of all the bones, is condensation that determines when and where the bones will form and also the final size and shape ([Opperman et. al 1996](#)). Condensation is the result of a migration of peculiar cell in a specific location and their differentiation in chondroblasts or osteoblasts ([Ducy et. al 1997](#) - [Rice et. al 1997](#)) done by specific molecular signal ([Hall & Miyake 1995 - 2000](#) – [Most 1998](#) [Chimal-Monroy & Diaz de Leon 1999](#)). The process ends with cell adhesion that influences the future form and function ([Stains & Civitelli 2005](#) – [Modarresi et. al 2005](#) – [Hartmann 2006](#)) or possible alteration ([Rice 2005](#)).

The shape and the size of the bones are so genetically determined and influenced by nutrition, hormones and muscles. So all the bones are the results of “Mechanochemical force”. A single error in growth patterns of a component however results in distorted bones relationship ([Siegel et. al 1991](#)).

Considering only the face is possible to divide it into 3 parts (upper, middle and lower face). The upper the face is the part of the neurocranium, the middle and the lower are part of the masticatory apparatus (including maxilla, mandible and dentition) ([Gill et. al. 1994](#)). The upper part contains the frontal lobes of the brain characterized by a rapid and longer growth (if we do not consider the ending of molars eruption at 18-25 years of age) ([Mandarim de Lacerda et. al. 1993](#)).

The facial growth is determined by the site of attachment of the facial skeleton, the calvaria base and the oromasticatory musculature ([Kjaer 1989](#) - [Lee et. al 1992](#) –

[Radlanski et. al 2000](#)). In addition, the growth of eyes for the stereoscopic view provide expanding forces that influence the human facial skeleton, that separate neural and facial skeleton.

1.6 Craniofacial Sutures

At first sight, "Sutures" are joints between bones of the vertebrate's skulls. Biologically speaking are fibrous joints coming fibrous tissue, at the end of two bones, which differentiate from embryonic mesenchyme. They are primary sites of osteogenesis usually (but not exclusively) of intramembranous origins ([Rice 2008](#)). The growth of the craniofacial bones and the position of each suture influence the others, so the final structure is the result of the bony margins, who themselves are determined by specific molecular factors (Hox Genes) ([Tyler et. al 1977](#) – [Opperman et. al 1993](#) – [Creuzet et. al 2004](#)).

Nevertheless, this regulation could have some exceptions and additional ossification centre where added between the sutures or in the fontanelles. Instead, the alteration of the regulation process could result in pathological conditions in some case were only added extra bones (within the suture especially lying on the lambdoid suture called Wormian's bones – [Barberini et. al 2008](#)) that do not influence the external morphology or the functions of skull and brain.

In many cases, when in their tight regulation occurs an error ([Bjork 1966](#) – [Bjork et. al 1977](#)), sutures are also able to adapt to pathological conditions. Nonetheless, several chemical alterations of genes expression and physical alteration during growth (intracranial pressures or injuries) could change suture's positioning and skull morphology and function ([Persson & Roy 1979](#)).

All the sutures (interfrontal, sagittal and lambdoidal) are formed during the embryonic development when they approximate to each other. First, we assist at the closing of the skull base ([Rice et. al 2003](#)) bone by the osteogenic activity of

frontal and parietal bones. After the development of the bones, close the interfrontal and sagittal sutures.

Sagittal sutures during his growth and development start as a sulcus between skull's hemispheres and end as a simple joint with multiple interlocking projections, instead, the coronal suture that links frontal with parietal bones were formed very early in skull development to allow the growth of frontal lobes ([Johansen & Hall 1982](#)).

Sutures have different functions ([Persson 1995](#)):

- Site of bone growth.
- Allows movement during birth and growth.
- During growth, permit adjustment in size, shape and spatial orientations.
- Protect the osteogenic tissue.
- Absorb mechanical stress and energy under the impact.
- Allows the developing of brain, eyes, ears, nose and dentition.
- Once closed they stop any modification in that part.

The skull growth both during the embryonic and the postnatal periods but calvaria and facial skeleton have different speed with the first one that grows most rapidly before and the second later ([Jane & Persing 2001](#)).

In conclusion, sutures need to be flexible, soft during birth and growth, and more rigid after (for these the fusion is after childhood) ([Todd & Lyon 1925](#) - [Miroué & Rosenberg 1975](#) – [Persson & Thilander 1977](#) – [Bradley et. al 1996](#)). Any changes in this process could produce small or large alteration in form and function ([Pritchard et. al. 1956](#) – [Moss 1958](#) – [Opperman et. al 1997](#) - [Roth et. al 1997](#)).

Cell matrix of cartilages could be considered as an elastic solid that subjected to strain and stress produced new bones in size and shape ([Iordansky 1990](#) - [Gussekkloo et. al 2001](#)). The resulting mature sutures (especially in mammals) are so able to bear the huge load, resist to deformation and compression ([Herring & Rafferty 2000](#) – [Harring & Teng 2000](#)) and at the same time are areas energy absorption ([Woo & Akeson 1987](#)). Sutures are able to dissipate impact from falls or foreign object, play a role in the pulsations of blood vessels ([Oudhof & van Doorenmaalen 1983](#)) and during the growth help and go hand in hand ([Henderson et. al 2005](#)) with other tissue as the “*dura madre*” ([Henderson et. al 2004](#)).

To sum up, sutures are so an important element of the craniofacial skeleton and their growth and development have an important role in the evolutionary and morphometric studies. Sutures also respond to chemical and mechanical stimuli ([Redlich et. al 2004](#) - [Wang et. al 2005](#)) determined by inheritance, environmental pressure and evolutionary process.

Sutures so could be used in the cladistics analysis of vertebrate to investigate the evolutionary pattern, using homology and homoplasy ([Hall 1994](#) - [2003](#)) to recognise how and when they change ([de Beer 1985](#) – [Depew et. al 2002](#)) and to understand how they diverged over time.

Phenotypic alterations due to changes (relative position, morphology, and histocytochemistry and gene expression) are used to study the evolution and biological distances on the vertebrates. In fact the dentition, jaws, skull, and facial musculature, of all the gnathostomes, is the result of the adaptations of several of ecological niches ([Tomes 1923](#) - [Jollie 1926](#) - [Gregory 1933](#) - [Goodrich 1958](#) –

[Halstead 1968](#)- [Peyer 1968](#) – [Romer 1968](#) — [Monroe 1981](#) — [Shellis 1982](#) –
[Carroll 1988](#) –[Hildebrand 1988](#) - [Bemis 1986](#) – [Bemis & Lauder 1986](#)).

The correlation between form and function is still today object of important studies and debates ([Gregory 1933](#) - [Albright & Nelson 1958](#) – [Peyer 1968](#) – [Hildembrand 1988](#) - [Anton et. al 1992](#) - [Rieppel 1993](#) – [Janvier 1996](#)).

1.7 Measurement of the Cranium – Craniometry

Craniometry is a subset of human Anthropometry, ([Martin & Saller 1957](#)) an early tool of Physical Anthropology used for understanding human physical variation through the bones measurements ([Buikstra & Ubelaker 1994](#)).

Craniometry, that is real science, is completely different of Anthroposociology and Phrenology, pseudo-sciences that, between the 19th and the 20th century, wrongly linked personality and behaviour to head shape also promoting the aberrant idea of race.

The widespread, at that time, of this mistake, was due to one of the prominent figure in this field Georges Vacher de Lapouge (1854–1936). Vacher de Lapouge was a French theoretician of eugenics and racialism also the founder of ‘Anthroposociology’, a pseudo-science that linking anthropological and sociological study was able to hierarchize different race in order to establish the superiority of certain peoples ([Vacher de Lapouge 1899](#)).

On the other hand, Craniometry was also used to disprove the existence of a "Superior race" as shows important scientific studies done by:

- Franz Boas (1858–1942), the pioneer of modern anthropology, used the cephalic index to show the influence of environmental factors ([Boas 1928 – 1940 - 1945](#)).
- Charles Darwin (1809-1882), the father of Evolution’s Theory, used Craniometry and the study of skeletons to demonstrate his theory of evolution first expressed in *On the Origin of Species* ([Darwin 1859](#)).

The origin of Craniometry however, it is antecedent to all these theories, in fact it dates back in 1784 when Louis-Jean-Marie Daubenton (1716-1800) published the “*Mémoire sur les différences de la situation du grand trou occipital dans l’homme et dans les animaux for the Académie Française*” ([Daubenton 1784](#)).

Six years later, Pieter Camper (1722–1789), a French anatomist, published his craniometrical methods the "Facial Angle", ([Camper 1782](#)) a measure meant to determine intelligence among various species. Étienne Geoffroy Saint-Hilaire (1772–1844) ([Saint-Hilaire 1830](#)) and Paul Broca (1824–1880) continued his research in the following years.

In the 19th century of craniometrics literature increased in number so quickly, that is impossible to remember each contribution and authors. We will only remember notable researchers who used craniometric methods to compare humans to other animals included as Paul Broca ([Broca 1861](#)) and T. H. Huxley (1825–1895) who by comparing man and apes ([Huxley 1880](#)) provide great support to Charles Darwin's theory of evolution highlighting that man and ape were descended from a common ancestor.

Instead, this Georges Vacher de Lapouge's racial classification was re-used by William Z. Ripley (1867–1941) in “*The Races of Europe*” ([Ripley 1899](#)) and by Rudolf Virchow’s Theory of the "Aryan race", presented the "Nordic mysticism" in the 1885 Anthropology Congress in Karlsruhe ([Virchow 1885](#)).

Craniometry only on the 20th century take on the features of true science with the remarkable works of Stephen Jay Gould (1941–2002), an American palaeontologist, evolutionary biologist and historian of science, that through these

craniometric work summarized in ‘*The Mismeasure of Man*’ ([Gould 1996](#)) disproved lot’s racism original data.

Gould in particular confuted Morton’s data (1799–1851) ([Morton 1839 - 1842](#)) and his followers Josiah C. Nott (1804 –1873) and George Gliddon (1809 –1857) (at that time all considered the greatest authorities in the field). This author has instead tried to classify skulls according to logical criterion and influenced by the common theories of his time, collected hundreds of skulls sustaining that was possible judge the intellectual capacity of a race by the cranial capacity ([Nott & Glidon 1860](#)).

Already C. Darwin, without success, opposed Nott and Glidon publishing the manuscript ‘*The Descent of Man*’ ([Darwin 1871](#)) was argued the monogenic of the species but the opera was quite neglected by the scientific community.

Instead of the remarkable efforts of a scientist like Boas and Darwin, this did not prevent the diffusion of pseudo-scientific theories as the "Cranioscopy". Cranioscopy was developed by Franz Joseph Gall (1758–1822), and subsequently renamed ‘Phrenology’ by his student Johann Spurzheim ([Spurzheim & Gall 1815](#)), a method to determine the personality and mental skills based on the external shape of the skull. The theory also supported by famous Criminal Anthropologist Cesare Lombroso (1835–1909) that tried d to recognize criminals by measurements of their bodies ([Lombroso 1896](#)).

Today modern sciences completely confuted pseudo-sciences as ‘Anthroposociology’ and ‘Phrenology’, that is demonstrated to be only quackery, and are nowadays considered by only a few anarchical and nationalism movements.

At present time, modern Craniometry, found applications in Neuroscience and craniometrics data are used to compare modern-day animal species and to analyse the evolution of the species in palaeontology for the study of ancestors and the history of humankind.

Fossils are investigated only to define evolutionary pathways and in physical anthropology to highlight population relationship, growth and development.

We also recognize that measurements used are only a limited set of those necessary and that any kind of racial discrimination is not science.

Craniometry nowadays is only a tool to record skeletal remain and we create a special database only for comparative statistical analysis in bioarchaeological research.

Measurements of the skull based on specific anatomical reference points are also used in both forensic facial reconstruction and portrait sculpture.

1.8 Photogrammetry – History and Basic concepts

Photogrammetry is a modern technique that allows for the building of 3D models starting from a set of digital photographs. Currently, it is widely used in several fields (life and earth sciences, medicine, architecture, topography, archaeology, - [Chodoronek 2015](#) - Crime Scene Investigation, cinematography and engineering) ([Linder 2009](#)).

Instead, in the past his use was limited by the high cost of the equipment necessary for building the models (powerful computers and high definition digital cameras), nowadays its diffusion is mainly due to the great reliability of the models obtained, its practicability and its low cost ([Jurda & Urbanova 2016](#)).

In the last few years, it has also been affirmed in Physical Anthropology ([Weber et. al 2001](#)) as one of the best techniques to build 3D models. It allows, indeed, easy storage of a large number of finds ([Kats & Friess 2014](#) – [Elvin et. al 2016](#) - [Santella & Milner 2016](#) - [Morgan et al. 2019](#)) thus making them available for subsequent qualitative and quantitative studies.

Among the quantitative applications, well know is the support provided to the Geometric Morphometrics Analysis, a discipline that studies the differences between biological forms.

The technique of photogrammetry, therefore, links descriptive geometry (a science that allows, through geometric constructions, to represent 2D and 3D objects on one or more planes), optics and photography and their history are closely linked to their history. The first steps of photogrammetry could both be considered ‘*Perspectiva liber*’ (1759) the works of Johann Heinrich Lambert, on which were defined the

mathematical laws on which photogrammetry is based. The second was the ‘‘Daguerreotype’’ created in 1837 by Louis Daguerre that can be considered the first photographic image, but we have to wait until 1883 to have the first study on the relationships between projective geometry and photogrammetry.

The birth of future photogrammetry, therefore, was the discovery of photography and the discovery of perspective and its laws (how to link the spatial position of a point to its position in an image).

In 1849, Aimé Laussedat (who is considered the founder of photogrammetry) used a process called "Iconometry", for the realization of topographic maps starting from the analysis of photographic images on which is considered the first example of photogrammetry. Nine years later, in 1858, the same Laussedat experimented the ‘‘Aerial Photogrammetry’’, a technique which consists in photographing the area from above (in 1862 this technique was officially accepted by the Royal Academy of Exact Sciences, Physics and Natural Sciences of Madrid).

In Italy Porro started the study of photogrammetry in 1855 and later the engineer Paganini of I.G.M. used a system of photography taken from the ground for the Monte Rosa and the Apuan Alps for a geomorphological study.

In the following years ‘‘Aerial Photogrammetry’’ was perfected especially for military purposes using balloons (an example was during the Battles of Solferino and San Martino, in which Napoleon III ordered to do reconnaissance with this technique).

In 1893 Albrecht Meydenbauer (founder and director until 1909 of the Royal Prussian Institute of Photogrammetry) used for the first time the term "Photogrammetry". In 1924 Otto von Gruber perfected the mathematical laws

applied to photogrammetry, creating the ‘‘Analytical Photogrammetry’’ that, as the word say, use an analytical method that makes the process faster. Other important steps forward were in the occasion the congresses in Zurich in 1930, Paris in 1934, Rome in 1938, and the invention of Nistri devices for photography (this technique, however, remained very expensive due to the complexity of the equipment used). With any doubt last and of the most import steps were the ‘‘Digital Cameras’’ that reduced significantly operations and cost.

Aerial photogrammetry was also used in the Apollo Program to map the lunar surface. This technique is also used for the mapping of planets by space probes.

According to field’s distances and collecting area, Photogrammetry is dived in:

- Micro photogrammetry: done within 6 cm; have many laboratory applications, especially in medicine, surgery, natural sciences (Ex. Palaeontology).
- Photogrammetry of ‘‘Close Objects’’: used between 1m and 30m, it has many fields of application, in the buildings of 3D models, for anthropological and zootechnical studies, crime scene investigations, artistic restoration, etc.
- Architectural Photogrammetry: allows identifying the shape, dimensions and position of architectural elements.
- Aerial photogrammetry: an irreplaceable method (for details and precision), when it is necessary to identify more or less extensive rocky walls and lands.

Photogrammetry, in any case, needs a set of digital photograph. It is not necessary to follow a well-defined order but is fundamental to cover the entire subject (it is recommended that each photo have at least 25% coverage with another to be properly placed in space).

As regards the "Exhibition Triangle" (opening time, diaphragm, and ISO) it is possible to change (not recommended) the parameters during the acquisition and it is possible (recommended) change the parameters after the acquisition in order to unify all the value.

It is extremely important Never change the "Focal Distance" because each lens has its own distortion that changes from lens to lens and among the same lens changing the focal distances. Change the lens or focal distance involves an uneven distortion. Although this is quite irrelevant in Aerial photogrammetry, Micro photogrammetry and Close objects photogrammetry, this implies a significant alteration of the scale of the object. So for "Quantitative Studies" of small objects (such as morphometric ones) we, always, use the same lens and the same focal distance (if the lens were changed it is necessary to redo the photos of the sample).

Natural and artificial light are both good but absolutely avoid direct light source coming from the background and the side.

It is not possible to avoid direct light it is possible to try to adjust contrast, brightness and opacity after taking the photos but this does not guarantee a satisfactory result. For the background always avoid white, glass, plastic and enamel that do not allow depth estimation so choose a colour that creates contrast with the object.

Photogrammetry is achieved through different steps, that changes according to the software, but certainly the first is take the photos always making various 360 °

rounds from different heights (the number of rounds depends on the size of the object).

As mentioned before the following steps depend from the software performed to build 3D models.

Models used in this works were created using [Agisoft-Metashape](#) a stand-alone software that performs photogrammetric processing of digital images and generates 3D spatial models.

Although the process will be explained in detail in the following chapter ‘Materials and Methods’ (paragraph ‘Methods’) below will be described briefly how the software works:

- 1- Align Photos and Sparse Cloud: the software search partial coincidences among the photos to place them into the space estimate the depth and create a sparse cloud taking only a few points.
- 2- Dense Cloud: the software analyses, compare all the megapixels of all the photos for estimate the depth, and realize a ‘mosaic of dense points’ that faithfully reproduce shape, size and colours of the object.
Already with this cloud is possible to have a realistic 3D vison, scale the model, export it in different a format that processed with specific software allows precise numerical calculations.
- 3- Mesh: over the dense cloud Metashape build a model composed of several micro-polygons. Higher will be the number of polygons (chosen by the operator) smaller will be their surface that will increase the resolution of the 3D models.

- 4- Texture: the software analyses the colours of the photos reproducing these on the polygonal model for a more realistic view.

All these steps have defaults and custom settings chosen step by step from the operator (in all the steps is possible to clean the model from artefacts and scale it).

For that reason, a special category of the soundscape has been set aside for human, alone. Called anthrophony, it includes all of the sounds that humans produce, whether structured (i. e. music, theatre, film, etc.), or entropic, as in the electromechanical chaotic and uncontrolled signals we generate by whatever means.

1.9 Geometric Morphometrics – Key concepts

Several modern biological studies are today, focusing on ‘‘Shape Analysis’’ ([Bruner 2007](#)). It clearly demonstrated that shape variation plays an important role in many biological processes. Disease or injury, mutation, ontogenetic development, adaptation to local geographic factors, or long-term evolutionary diversification always produces differences in shape (in a district or in the whole body) ([Bruner & Manzi 2005](#) – [Bruner et. al 2006 - 2020](#)).

Morphological variation and transformation are, therefore, useful to understand the process of growth and morphogenesis of the biological structures under the selective pressures and their functional role in the evolution ([Roseman 2004](#) - [Slice 2005](#)).

In the past differences in shape were only studied with a descriptive analysis by comparing the observed shapes with other similar in nature or schematized in geometry, using terms as mitten like, circular, Reniform, C shaped etc. etc., almost certainly easy to visualize and remember but not valuable in quantitative studies ([Bruner & Ripani 2008](#) - [Zelditch et. al 2012](#)). Moreover, often too much inaccurate, vague and subjective for complex shape where is request a high level of precision and accuracy that could be provided only by measurements.

Morphometrics is a quantitative approach to study and compare shape applicable in biology ([Bruner 2004](#) - [Bruner & Manzi 2004](#) - [Bruner et. al 2004](#)). Instead, pictures seem to be typical of qualitative studies this approach is completely different and shape comparison ([D’Amore et. al 2010](#) – [Ozdemir et. al 2010](#) – [Baab et. al 2010](#) – [Manon Galand et. al 2016](#)) can give a study analyzable in a mathematical context.

Morphometric usually produced tables with a list of numbers. Those numbers, before a mathematical and statistical analysis, are not displayable as the descriptor of shape. For this reasons morphometric is closer to algebra than morphology. This is true if we consider that in the end morphometric is a branch of statistic of shape (we extract mathematical morphometric data that rather involves in biological intuition or classical morphology. At support, of this view are the pioneering work in modern Geometric Morphometrics by Kendall and Kendall on the alignment of megalithic stones like Stonehenge ([Kendall and Kendall 1980](#)) that had nothing at all to do with biological morphology.

In biology, classical morphometric, have the advantage to provide a precise description coming from a rigorous statistical analysis allowing us to visualize differences from complex shape (not evaluable with a simple description) in an easy way like the visualization of differences between circles, letters of the alphabet etc. etc. We do not have to forget that mathematics applied to the biological component provide to build not only algebraic models but also exploratory methods such as principal components analysis.

Instead, shape analysis has a biological importance, before each study is important to focus some questions:

- What are we measuring?
- Is it a functional character?
- Is it a systematically important character?
- Is it a developmentally important character?
- Is it character mathematically related to what we are measuring?
- What we define for character, size and shape?

It is always difficult to answer this questions, especially on the beginning, because each study had an own approach to measurements (according to the biological form) and there was no a general theory of shape and for the treatments for shape data.

Nowadays, the development of measurement theory resulted in a precise definition of shape and his mathematical application.

On the beginning morphometric data contained only a little information about shape (length, depth and width) ([Lagler et al., 1962](#)) and many of the measurements (that can not be independent) overlapped or ran in similar directions. Moreover, for morphological analysis, is necessary a measurement scheme (often data are only a list of values) that show spatial relationship between measurements.

Considering this is clear that data often could be overestimated and the scheme does not have to alter its mathematical basis ([Strauss & Bookstein 1982](#) - [Bookstein et al. 1985](#)).

This approach used, as endpoints of the measurements, biological homologous anatomical loci "Landmarks" that improve the classical measurements schemes. Unfortunately, results are always a list of number with the same problems of the dissertation. Additionally, we need a large sample to test the hypothesis about the shape and specialized statistical methods (analyzable mainly with regression coefficients, principal component analysis) to analyze they ([Richtsmeier & Lele 1993](#)).

All considered is very difficult separate information about shape and size, is fundamental chose an appropriate statistical analysis ([Atchley et al. 1976](#) - [Corruccini 1977](#) – [Albrecht 1978](#) - [Atchley and Anderson 1978](#) - [Dodson 1978](#) -

[Hills 1978](#)). Usually, researchers construct shape variables from linear combinations of length measurements, such as Principal Component Analysis (PCA) that includes information about both shape and size, (raw measurement also includes their linear combinations).

As highlighted separate size and shape is problematic and another problem is due to multiplicity of definitions of size and shape ([Bookstein 1989](#)). For someone is impossible to separate shape and size (size separated from shape is not size) ([Klingenberg 1998](#)) because they are both linked by biological process and we have to study their relationship. Understand the information about the relationship between size and shape is difficult ([Lahr & Wright 1996](#)), especially, when the organisms span a broad size range. In fact, often, size is the dominant source of variance in traditional morphometric.

Finally, another problem, of morphometric, is that measurements give not information about geometric structure (landmarks are close to each other's and others are far; some are ventral other dorsal; some anterior others posterior).

Is so necessary considering that the information about the position is important in morphometric and Landmarks, containing coordinates (not distances) provide all the necessary information (x, y and z) (distances can be reconstructed by the coordinates if the unit of measurements is known).

Using coordinates is possible to treat data with simple algebraic manipulations, this allows us to divide the information into size and shape and delete all the irrelevant information.

Another advantage of analyzing Landmarks coordinates is that it is relatively easy

draw informative pictures to illustrate the results (examples: the shape changes that show the relative landmark variations as vectors and the deformed grid that shows the changes between those vectors) nevertheless the use of landmarks does not solve all of the problems of traditional methods.

To overcome these problems is it possible to achieve other information about points on the curve between landmarks positioning other point called “Semi landmarks” taking it not on anatomical loci but along curves (the advantages of using semi landmarks is that provides information on the curvatures and their function).

In conclusion, Geometric Morphometrics do not have the restriction of two-dimensional data and its limitation is partially related to the cost of the technology used (Computer Tomography – TC, Photogrammetry, Laser scanner).

Working in Geometric Morphometrics requires to have clear the concept:

- Shape
- Scale
- Size
- Centroid size
- Landmarks
- Semi Landmarks
- Procrustes Superimposition
- Thin-plate Spin

In Geometric Morphometrics, “Shape” is defined as “all the geometric information that remains when location, scale and rotational effects are filtered out from an object” ([Kendall, 1977](#)).

Using coordinates of points removing any non-shape variation resulting from our arbitrary choice and leaving only differences in shape perform the work that uses this definition.

This definition implies that "Scale" is one of the effects that could be separate by Shape. Indeed, we have to consider that Size could make Shape Analysis less effective, if not treated and analyzed separately. Separating size and shape will allow to study variation in both, as well as size/shape covariation. In the present case, size comparison and allometry maybe relevant for population differences, and I would have liked to see this addressed at some point.

The two are geometrically independent so scale is the definition of "Size" and size is complementary to shape.

To estimate scale, we calculate the distances of all landmarks to the centre of the form (called centroid); it is so possible to compute geometric scale calculating the square of each distance from landmarks to the centroid, summing those squares and taking the squares root of their sum. This called "Centroid Size" is the measure of size mathematically independent from the shape.

In biology could be correlated with shape but this does not mean a loose of information because we can analyze that relationship by conventional statistical methods.

"Landmarks " are discrete anatomical loci that can be recognized, as the same point in all specimens in the study, are so homologous point (points on one specimen correspond to that point on all individuals found in the entire sample - Examples. Mental foramen of the lower jaw). Instead, homology seems to be the crucial word discrete points is the most important word. If in area of interest

Landmarks are scarce is possible to place on the curves additional points that improve our information; this points (not anatomical points) are called “Semi Landmarks”.

Position and order of landmarks and semi landmarks are arbitrary ([Bookstein 1996](#)) (and only the entire configuration dataset is analyzable by multivariate analysis ([Klingenberg, 2008](#)) (not the singular point).

To choose the landmarks is very important:

- Do not forget Homology.
- Adequate coverage of the form ([Roth 1993](#)).
- Repeatability.
- Scale preservations.
- Chose points not randomly ([Webster & Hughes 1999](#)).

In the case of Photogrammetry and Laser Scanning distance between the specimen and the camera can be the first source of measurement error ([Mullin & Taylor 2002](#)); in general, all the digital equipment generates distortion and error ([Corner et al. 1992](#)).

In addition, the positions of the Landmarks could be a source of errors, for this Bookstein ([Bookstein 1991](#)) introduced a classification of landmarks into three categories named Type 1, Type 2 and Type 3:

- Type 1: Optimal Landmarks - Discrete juxtapositions of tissues, discrete juxtapositions of bones (Example the intersection between three bony sutures) or Foramen.

- Type 2: Problematic Landmarks - Intermediate between Type1 and Type2 are tip or bulge of geometric structure or points located on maxima or minima of curvature.
- Type 3: Might not even be considered Landmarks – Landmarks often far the Landmarks of Type 1 often constructed geometrically (intersection of lines).

There are not correct numbers of landmarks or a correct scheme valid for all studies and all the organisms; the researcher have to design is own scheme considering the sample and the aim of the study. Considering that, the use of Landmarks Type 2 and 3 and Semi landmarks is not always an error; different studies with different goals in a different part of the skeleton require different numbers, schemes and types of Landmarks (or semi landmarks) ([von Cramon-Taubadel et. al 2007](#)).

As reported below nowadays are available several studies based on different biological species:

- Trilobites ([Kim et al. 2002](#)) ([Webster 2007 - 2009](#)) ([Webber & Hunda 2007](#)), Insects wings ([Debat et al. 2009](#)) ([Johansson et al. 2009](#)) ([Klingenberg & Zaklan 2000](#)) ([Klingenberg et al. 2001](#)).
- Shrimps ([Claverie et al. 2011](#)).
- Crabs carapaces ([Hopkins & Thurman 2010](#)).
- Tadpoles ([Arendt 2010](#)) ([Van Buskirk 2009](#)).
- Orchids ([Benitez-Vieyra 2009](#))
- Tooth ([Caumul & Polly 2005](#)) ([Wood et al. 2007](#)) ([Laffont et al. 2009](#)) ([Piras et al. 2010](#)) ([Skinner et al. 2008](#)) ([Singleton et al.2011](#)) ([Gomez et al. 2006 - 2009](#)).

- Skulls ([Baab et. al 2010](#)) ([Betti et al. 2009](#)) ([Bruner 2002](#)) ([Bruner 2004](#)) ([Bruner 2007](#)) ([Bruner 2009](#)) ([Bruner 2013](#)) ([Bruner & Manzi 2003](#)) ([Bruner & Manzi 2004](#)) ([Bruner & Manzi 2005](#)) ([Bruner & Jeffery 2007](#)) ([Bruner & Ripani 2008](#)) ([Bruner et. al 2004](#)) ([Bruner et. al 2006](#)) ([Bruner et. al 2020](#)) ([D'Amore et. al 2009](#)) ([D'Amore et. al 2010](#)) ([Harvati & Weaver 2006](#)) ([Harvati et. al 2006](#)) ([Harvati et. al 2010](#)) ([Lahr & Wright 1996](#)) ([Lycett & von Cramon-Taubadel 2008](#)) ([Galland & Friess 2016](#)) ([Galand et. al 2016](#)) ([Galland et. al 2019](#)) ([Matsumura et al. 2018](#)) ([Mounier & Lahr 2016](#)) ([Gunz et. al 2009a](#)) ([Gunz et. al 2009b](#)) ([Ozdemir et. al 2010](#)) ([Rangel de Lanzaro et. al 2016](#)) ([Reyes- Centeno et al. 2017](#)) ([Roseman 2004](#)) ([Slice 2005](#)) ([Slon et. al 2014](#)) ([Stock et. al 2007](#)) ([von Cramon-Taubadel et. al 2007](#)) ([von Cramon Taubadel & Weaver 2009](#)) ([von Cramon Taubadel 2011](#)) ([von Cramon-Taubadel 2014](#)) – ([von Cramon-Taubadel et. al 2016](#)) ([Zelditch et. al 2012](#)).

All these species have their own landmarks and the scheme used to have to be built on the samples considered and the target to achieve.

The last, but very important concept to understand is “Procrustes Superimposition” ([Chapman 1990](#)).

This methods instead is less intuitive, is the most widely used to obtain shape variables which can be used both for graphical displays and formal statistical tests ([Claude 2008](#)).

Procrustes was a bandit, in Greek mythology, used to fit his victims to a bed by stretching or truncating them, trying to minimize the difference between victims

size and the bed. The method, in fact, minimizes the differences between landmark configurations to obtain shape ([Dryen & Mardia 1998](#)) coordinates. Unlike the mythological Procrustes, the mathematical Procrustes superimposition method does not alter shape because uses three operations: translation, scaling and rotation.

As proposed by Rohlf and Slice the mathematical operations done are ([Rohlf & Slice 1990](#))¹:

¹« “1- Centre each configuration of landmarks at the origin by subtracting the coordinates of its centroid from the corresponding (X or Y) coordinates of each landmark. This translates each centroid to the origin (and the coordinates of the landmarks now reflect their deviation from the centroid)”.

“2- Scale the landmark configurations to unit centroid size by dividing each coordinate of each landmark by the centroid size of that configuration”.

“3- Choose one configuration to be the reference, and then rotate the second configuration to minimize the summed squared distances between homologous landmarks (overall landmarks) between the forms” ».

With three or more forms, first, all are rotated to optimal alignment; second, the average shape is then calculated and all are rotated to obtain an optimal alignment based on the average shape (which is the new reference). Finally, the average shape is recalculated ([Walker 2000](#)).

To summarize after Procrustes superimposition, the centroid size is fixed through a repetitive (iterative) process called GPA (Generalized Procrustes Analysis). This, especially in 3D, need a huge matrix and for this reason, we left the analysis to computers and software.

For the superimposition of Semi landmarks (that are not free to move - can only slide on the line tangent) ²« we slide it to the position that minimizes the summed squared deviations between each individual and the reference form » ([Sampson et al. 1996](#))².

Superimposition is certainly a complex mathematical operation that allows different useful displays of the data as PCA, Wireframe Graph and Lollipop Graph (vectors landmarks displacement) ([Rao 1973](#)) ([Morrison 1990](#)).

Thin-plate Spin: is used for visualizing the change in shape through a deformation grid it shows 2D data while the called ‘ soft – wireframe’ represent changes on 3D.

Is a deformation smooth function that shows what happens between the landmarks and their changes. Changes are shown by a series of graphics ([Thompson 1992](#)) that sometimes are supported by colours to highlight the rate of changes.

1.10 Multivariate Statistical Analysis in Physical Anthropology

Multivariate Statistical Analysis provides an easy method for describing the diversity of shapes ([Hammer & Harper 2008](#)). Is a descriptive statistics analysis that summarizes all the value in a few particularly indicative numbers ([Friess 2005](#)).

It considers simultaneously, all the variables linked together usually considering which is more important, nevertheless in Geometric Morphometric variables are considered all of the same importance.

Is used when are not clear the causes "*a priori*" of the observed phenomenon and it is necessary to analyze all the variables and their possible relationships (as the morphology of living organism).

All multivariate statistical analysis divides the samples into similar groups and represents it in graphs (2D or 3D) where the distances represent the similarities or differences (are largely based on the replacement of the original data matrices with similarity matrices).

In this type of analysis, the Principal Component Analysis (PCA) plays a key role ([Jolliffe 2002](#)). PCA ([Chatfield & Collins 1980](#)) ([Campbell & Atchley 1981](#)) produce a simplified description of shape, among individuals, easy to understand and describe.

PCA made a new linear set of variables from the original one and a score for individuals on those variables that can be also visualized in a simple and intuitive way ([Hotelling 1933](#) - [Jolliffe 1986](#) - [Jackson 1991](#) - [Reyment & Jöreskog 1993](#)).

As well explained below it, compute the original data producing a set of linear combinations by rotating the axes (from the original data matrix the dimension of a

data set were progressively reduced). In detail display the samples in the new axis projecting a line that minimizes the sum of the squares of the distances called “best-fit line of the data” and on a second axis perpendicular at the first.

With more than two variables, it is difficult to represent, graphically, the rotation between the axes and the components are extracted in different ways not treated here.

In our case, we use the Covariance-based PCA where the distance between samples depends on the unit of measurement (applied to dimensionally homogeneous variables). The analysis of Covariance or Correlation (R-Mode analyses) allows to quantify the degree of correlation between variables (evaluate if two or more matrices are correlated) but we have pre-treated the data standardizing them.

We applied the variance on the Covariance matrix ([Davis 1986](#)) if the observed variables are expressed in the same unit of measurement and the same scale. Otherwise, PCA must be done with Correlation Matrix ([Press et al.1992](#)) (that could be the same of the covariance matrix) as the raw data.

To understand how PCA represent the reality we have to consider the “Eigenvalues” the quantity or original variance explained by the new variables.

To sum up PCA:

- 1- PCA produces new axes which are linear combinations of original values.
- 2- The first axis describes the maximum variation.
- 3- The second, orthogonal to the first, describes the largest variation of the data.
- 4- Axes PC1 and PC2 represent the variance and describe the variation of the original data. To notice is that, in more than one case, this may not be

enough to detect all the major patterns of variation. For this reason sometimes, lower components should be considered to show crucial variations.

- 5- PCA maintains Euclidean distances between the samples.
- 6- Covariance-based PCA is applicable if the variables are "dimensionally" homogenous and should be avoided if the number of variables is greater than the number of samples and there are too many zero.

Geometric shape variables are always dependent and PCA simplifies those patterns making them easy and clear to explain.

In Morphometry PCA allows other types of graph useful to visualize shape change:

- 1- Wireframe Graph: is made by a set of lines (wires) connecting the landmarks. The lines do not connect each point to some other (graph would not be easy to understand) but only the major point chosen by the researcher. Often the wireframe is drawn overlapping the sample mean over the result of deformations, to show the variation of each landmark in the sample. The vertices of wireframe are so the landmarks and the wires can be replaced by curves (Soft Wireframe) that reflect the Shape Deformation in the space between landmarks and the deformation in the sample.
- 2- PC Shape Change (or Lollipop Graph): shows the landmarks with vectors as point and lines. The length of the vectors indicates the variation of each point. Greater will be the length of the vector, greater will be the variation in that point, among the samples. It is a powerful way to display the

landmarks variations (which landmarks vary more and which less) showing the direction and magnitude of change through time at each landmark.

The analysis of “Size” in Morphometry ([Centroid Size](#)) is carried out by a Linear Regression analysis that consists to assume two variables (one dependent and one independent) and fit this bivariate dataset to a straight-line model.

The fitting on a straight-line is possible for all the bivariate dataset built with independent data and errors normally distributed.

Linear regression follows the equation “ $y = ax + b$ ” where the slope “a” and the intercept “b” are constant but we cannot exclude the measurements error. For this reason, we assume that there are no errors in the independent variables (x). This model so result in a linear, “deterministic” component $ax + b$ plus a “random” or “stochastic” error component (e) $y_i = ax_i + b + e_i$. Linear Regression consists on find (a) and (b), minimizing (e_i) from a set of values ([Kermack & Haldane 1950](#)) ([Miller & Kahn 1962](#)) ([Sokal & Rohlf 1995](#)).

Is possible doing Regression Model differently but in morphometric is used the “Mayor Axis” that is easy and intuitive in calculating the magnitude of the residual as the sum of Euclidean distances from each data point to the line. The first axes have so the same slope of the first principal component.

In this work will be applied the methods proposed below but is important do not forget that are available other Multivariate Analysis, very important for other targets in Biology and Geometric Morphometrics.

Multivariate Techniques could be also employed to estimate biological distances coming from a different dataset (as landmarks or measures).

In this work, they will be also employed multivariate techniques as MANOVA/CVA, MDS and NEIGHBOUR JOINING:

- ANOVA-MANOVA: Is applied with more than two groups and different levels of factors (for instance considering sex in nine different species, we have nine levels of factors). It is suggest to perform the Single Analysis of variance ANOVA ([Klingenberg & McIntyre 1998](#) - [Anderson 2001a](#) - [b](#) - [2006](#) - [Anderson & Robinson 2001](#) - [McArdle & Anderson 2001](#) - [Rencher & Schaalje 2008](#) - [Rohlf 2009](#)) or the MANOVA Multivariate Analysis of Variance ([Snedecor & Cochran 1980](#) – [Lorenzen & Andeson 1993](#) – [Quinn & Keogh 2002](#) - [Adams & Collyer 2009](#)). Both are general linear model used when we have a mixture of categorical factors and continuous variables (covariates), plus some other models.
- Canonical Variates Analysis (CVA): is used for description among groups and to form mathematical discriminant function which may be used to assign specimens to group ([Nolte & Sheets 2005](#) – [Costa et al. 2008](#) - [Van Bocxlaer & Schultheiß 2010](#) - [Williams et al. 2012](#) - [Menesatti et al. 2008](#) - [Yee et al. 2009](#)). CVA build new coordinate system quite in the same way of PCA but rescale the samples.
- MDS: The Multidimensional Scaling is often used to graphically show the differences or similarities between elements of a dataset. MDS' algorithms assign each element a position in an N-dimensional space, with N established *a priory*. This technique starts with a multidimensional system (as there are elements of the system) in witch dimensions will be reduced to a certain number N. Is so inevitable a loss of information and therefore there

are different algorithms adapted to different situations (metric and non-metric) ([Rightmire 1976](#) – [Bronstein et. al 2006](#)).

- Neighbour Joining (NJ): is an agglomerative Clustering Method (see next page) used to create phylogenetic trees from biological data. NJ starts from a distance matrix (Q-matrix) itemizing the distance between each pair of groups ([Saitou & Nei 1987](#)).

Multivariate techniques are so a group of statistical methods used for the called Exploratory Data Analysis (EDA). These methods are useful to identify systematic relationships between multiple variables.

The EDA most commonly used and recommended by physical anthropologists for this purpose include the analysis of the (PCA), the Analysis of Groups (Cluster analysis) and the Multidimensional Scaling (MDS) ([Pietrusewsky 2000](#)).

In the present work different of these techniques has been used for (as deduced from the rich scientific literature) contribution to the result ([Andrews & Williams, 1973](#)).

Although they will not be treated in this thesis, they are quickly remembered:

- Thin-plate Spin: as said, is used for visualizing the change in shape and its metric is also used to superimpose semi landmarks ([Green 1996](#)). Semi landmarks could be slide along curves in order to minimize the perpendicular distances between the specimens. Is also possible to use a thin-plate spline to slides and obtain an optimal smooth distance between semi landmarks on the sample.

- CA: Cluster Analysis or Group Analysis is a technique used to select and group homogeneous elements in a dataset. CA is based on the similarity between the elements. This similarity (or dissimilarity) are expressed in terms of distance in a multidimensional space. The quality of this analysis depends on the choice of the metric and on how the distance is calculated ([Oxnard 1985](#) – [Curnoe et. al 2006](#) - [Pang et. al 2010](#)).
- Partial Least Square (PLS): is used to study patterns of covariation between two or more block of variables ([Houle et al. 2002](#) - [Angielczyk & Sheets 2007](#)). For instances between morphology and diseases status ([Lowe et al. 1997](#) - [Bookstein et al. 2002](#)), shape and environmental variables ([Noback et al. 2011](#) - [Monteiro et al. 2003](#)) or 2D and 3D data ([Rohlf & Corti 2000](#)). Because it analyses the covariation of a block of data is used for morphological and modularity studies ([Bookstein et al. 2003](#) - [Klingenberg et al. 2003](#) - [Bastir & Rosas 2004](#) - [Bastir et al. 2005](#) - [Mitteroecker & Bookstein 2007](#)). PLS reduce the dimension of all the blocks (the variables in the blocks need not be independent of each other) yielding and giving scores on the axes that explain covariance. On the contrary of PCA studies covariance between blocks rather than the variance within a block. Is often applied in Chemistry ([Kemsley 1996](#) - [Barker & Rayens 2003](#)), Clinical Studies ([Sampson et al. 1989](#) - [Streissguth et al. 1993](#) - [Lowe et al. 1997](#)), Sociology ([Wold 1966](#) - [Bookstein 1982](#) - [Joreskog & Wold 1982](#)), Economy ([Fornell & Bookstein 1982](#)) and Biology ([Noback et al. 2011](#) - [Sheets et al. 2006](#)) ([Mitteroecker & Bookstein 2011](#)). It is so possible

compare PLS with PCA and CVA. In Biology remarkable are the works with the aim to:

- “Explore Tool to Characterize Populations” ([Rothwell 1995](#) - [Pretty & Sweet 2001](#)- [Bowers 2006](#) – [Pretty 2006](#) - [Bowers 2006](#)) applied to forensic sciences.
- “Examine Morphological Integration and Modularity” ([Bookstein et al. 2003](#) - [Bastir & Rosas – 2004](#) – [2005](#) – [2006](#) - [Bastir et al. 2005](#) – [2007](#) – [2008](#) - [Mitteroecker & Bookstein 2007](#) - [2008](#) - [Laffont et al. 2009](#) - [Gkantidis & Halazonetis 2011](#) - [Cheverud et al. 1991](#)- [Mezey et al. 2000](#) - [Klingenberg et al. 2003](#)) as the comparison of the tooth-bearing region with the muscle-bearing region of the rodent.
- “Ecological Factors” ([Fadda & Corti 1998](#) - [Monteiro et al. 2003](#) - [Arif et al. 2007](#)- [Pulcini et al. 2008](#) - [Fornell et al. 2010](#) – [McGuire 2010](#) - [Noback et al. 2011](#)) to analyze the relationship between shape and environmental factors (abiotic and biotic) or Cichlid Body Shape and the Biotic Environment ([Ruber & Adams 2001](#)).

1.11 Stature and Secular Trend

Human Stature (or Height) is the distance from the top of the head and bottom of the feet, standing erect. Height is, therefore, a measure of the biological development as an individual as an entire population and is a sensitive character of a series of factors (gender, age, social layer, environment etc.) as the Secular Trend.

Despite, could be both calculated in centimetres and feet and inches, several methods, commonly used in physical anthropology, are based on a metric system instead of imperial system.

Even though (to estimate stature from skeletal human remains) large numbers of methods were proposed ([Rösing, 1988](#) - [Formicola 1993](#)) we remark the most commonly applied:

- Fully: ([Fully 1956](#)) based on European samples is the most commonly used for height's reconstruction of a complete skeleton. The methods consist in the measure in centimetres of the basion-bregma height and the maximum height of the body of the vertebrae from C2 (including the tooth) to L5 (measured individually). At these measures should be added the maximum height of the first sacral segment, the bicondylar (oblique) length of the femur, the maximum length of the tibia (including malleolus and excluding the thorns), the height of talus and calcaneus articulated (should be used overage of left and right for the femur, tibia, talus and calcaneus – [Lundy 1988](#)). The results should be calculated considering the soft part's

corrections factor proposed by Fully and revised by Raxter, Aurerbach and Ruff in 2006 ([Raxter et. al 2006](#)).

The pros, of this method, are that could be applied for different populations but has the cons that need an almost complete skeleton available.

- Manouvier: ([Manouvier 1893](#)) is a method for estimating statures from isolated bones. It could be considered the evolution of the method of Rollet ([Rollet 1888](#)) the first method for estimating height from isolated bones.

In both the methods long bones measurements were tabulated (one table for male and one for female) with on the side the correspond statures.

- Pearson, Trotter and Gleser, Tibbets: ([Pearson 1899](#) – [Trotter & Gleser 1952](#) – [1958](#) – [Totter 1970](#) - [Jantz et. al 1995](#) - [Tibbets 1981](#)) as the previously mentioned, allows determining stature coming from isolated long bones throw the use of regression formulas. The length of each bone complete the missing value of a specific formula that estimate height with a small error (in general smaller for leg bones).

- Muller, Steele: ([Muller 1935](#) – [Steele 1970](#)) starts from fragmented bones. Both do an approximate estimation of the proportions of the present parts and the missing parts to reconstruct the length of the entire bone.

Consequently, to reconstruct statures, the first use Manouvier while the second Totter & Gleser and Genovès ([Genovès 1967](#)), for the Mongolian, and Stele & McKern ([Steele & McKern 1969](#)), for Black and White.

It is obvious that these methods have a very low degree of accuracy should be considered possible, and not predictable, relevant errors.

A Secular Trend is a variation that involves a character of a species during a long period (centuries). It is, therefore a, quite constant, small changes that produce a huge variation on a historical series (is also called “Secular Drift” when is linear).

Secular Trends are important phenomena in several areas as economy, astronomy, physical anthropology and different species ([Bruner 2013](#)) etc.

In physical anthropology, the secular trend is the tendency of new generations to be taller. It, primarily, involves the lower limbs and the growth’s rate was not constant during the centuries.

Is possible to observe Secular Trend already on the archaic economy characterized by good climatic conditions and food surplus while is absent (in the same period) in unstable and unfavourable areas and after each period of urbanization.

Certainly, the European industrial revolutions, (and the consequent improvement of life conditions of the lowest social layer) that has characterized our continent, provided a wide boost to this phenomenon.

During the last 100 years, we have seen a remarkable increase in average height (more than 10 cm) in all age classes. Instead, the missing data of the pre-scholar period is clear that this phenomenon start forms the birth (between 2 and 5 years old). The overage’s increase (from 1880 to 1950) is 1 cm and 0,5 Kg for children (between 5 and 7 years old) and 2,5 cm and 7 Kg for adolescent every 10 years while only 1 cm in the adulthood ([Harrison at. al 2004](#)).

This trend is still present in a lot of European Country and more accentuated in Japan both probably due to early maturation. However today wealthy classes seem have been expressed all the genetic potential and the phenomenon has been stopped.

Secular Trend, through the century, has involved all the social classes and instead, still, today are differences guys nowadays are taller than in the past ([Harrison at. al 2004](#)).

Today early maturation and the consequent early achievement of adult stature determined an increase of stature's overage of 2,5 cm for a generation.

Despite is impossible exactly determine Secular Trend's reasons is demonstrated environmental conditions and genetic factors are both involved in this process.

Stature is so a good index of human evolution and variability, in fact, modern historical are using this data to understand human condition during the industrial age ([Harrison at. al 2004](#)).

1.12 Biological Distance from Skeletal Remains

Data derived from Skeletal Remains reflect populations' similarities and differences so could be employed to estimate the Biological Distances (or BioDistances) ([Pilloud & Hefner 2016](#)). Instead, only recently, phenotypic characters assumed to be informative, several studies on cranial and dental variation in shape and size (such as another morphological character) have been demonstrated that phenotype and epigenetic factors ([Hunter et. al 2010](#)) carry phylogenetic inheritance information ([Galland & Friess 2016](#)). As mentioned below dental morphology and measurement (tooth dimension) reflect the human variation and could be used in biological distances estimations both in modern ([Scott 1980](#) - [Edgar 2002](#) - [Lease 2003](#) - [Hanihara 2008](#)) and archaeological populations ([Irish & Guatelli-Steinberg 2003](#) - [Guatelli-Steinberg & Irish 2005](#) - [Martinón-Torres et al. 2007](#) - [2012](#) - [Gómez-Robles et al. 2013](#)). Moreover, since the first studies were done by traditional craniometric and Geometric Morphometrics has been demonstrated that craniometric data recording and morphometric dataset (especially if analysed together) serves to explore human variations and biological relationship ([Howells 1973](#) - [1984](#) - [1989](#) - [1996](#) - [O'Higgins 2000](#) - [Relethford & Harpending, 1994](#)).

This does not mean that each morphological similarities share always a common ancestry but that there is a relationship between genotype and phenotype analysable by morphological character (mainly carried by cranial morphology that post-cranial districts - [Wescott 2005](#) - [Harvati et. al 2006](#) - [Bruner & Jeffery 2007](#) - [Lycett &](#)

[von Cramon-Taubadel 2008](#) - [Mounier & Lahr 2016](#) – [von Cramon-Taubadel 2014](#)
– [von Cramon-Taubadel et. al 2016](#))

2. Materials and Methods

2.1 Materials

A set of Sicilian (Italy) (**Tab. 2.1**) human skeletal finds coming different ages (from Prehistory to Contemporary – 39 Populations) was selected to carry out 2D teeth dimensional data analysis, 3D craniofacial Geometric Morphometrics and statures' secular trend. Craniofacial Geometric Morphometrics analysis was complete comparing the reference sample with e set of Spanish and Argentinian (**Tab. 2.2**).

The finds belonging to the Sicilian Context comes from the collections stored in the:

- Archaeological Museum of Isole Eolie ([Bernabò-Brea](#))
Lipari
- Archaeological Museum of Marsala ([Baglio Anselmi](#))
Birgi – Lilibeo – Marsala - San Giovanni Marsala
- Archaeological Park of Monte Iato ([Monte Iato](#)) - [University of Innsbruck](#)
Monte Iato
- Archaeological Museum of Mozia ([Whitaker](#))
Birgi – Lilibeo – Mozia
- Archaeological Museum of Palermo ([A. Salinas](#))
Caserma Tukory – Castello San Pietro- Grotta della Molara - Marcita –
Maranfusa - Manuzza – Partanna - Stretto Partanna – Selinunte – Segesta –
Roccazzello – Grotta dell'Uzzo

- Archaeological Park of Agrigento ([Agrigento](#))
Tardo Antico Tempio della Concordia
- Geological University Museum of Palermo ([Gemmellaro](#))
Grotta di San Teodoro
- Township Museums of Caltavuturo ([Don G. Guarnieri](#)).
Caltavuturo
- Township of Mussomeli ([Antiquarium Archeologico](#))
Polizzello (Demiro Excavations)
- Laboratorio di Antropologia ed Applicazioni Forensi –Università degli Studi di Palermo-UNIPA ([LabHomo](#))
Baucina – Grotta della Molara - Licata - Phoenician of Palermo – Rotoli.
- Municipality of Alia ([Alia](#))
Alia
- Literature
Contrada Petrarò (Entella) - Desueri — Entella- Grotta Chiusilla – Grotta D’Oriente - Grotta del Fico – Grotta di San Ciro - Piano Vento –Sant’Agata

The Comparison Sample come from the:

- Laboratorio de Poblaciones del Pasado – Universidad Autonoma de Madrid
UAM ([LAPP](#))
Almansa - Encantada – Lugo de Llanera – Marialba – Veranes
- Laboratorio de Ecología Evolutiva Humana - Universidad Nacional del
Centro de la Provincia de Buenos Aires – UNCPBA – CONICET ([LEEH](#))
Argentinian and Spanish

Site	Dating	Historical Periods**	Populations	T. *	M.*	S.*
Grotta di San Teodoro	14.500 B.P. - ¹⁴ C	Upper-Paleolithic	Würm-Settlers	X	X	
Grotta dell'Uzzo	9.000 B.P.	Mesolithic	Hunter-Gatheres	X	X	X
Molara	9.000 B.P.	Mesolithic	Hunter-Gatheres		X	
Grotta D'Oriente	8.500 B.P.	Mesolithic	Hunter-Gatheres	X		
Piano Vento	3.500 b.C	Neolithic	Indigenous			X
Fossato Stretto Partanna	3.500 b.C	Neolithic	Indigenous			X
Grotta di San Ciro	3.500 b.C	Neolithic	Indigenous	X		
Roccazzello	3.500-2.300 b.C	Eneolithic	Indigenous			X
Grotta del Vecchiuzzo	3.500-2.300 b.C	Eneolithic	Indigenous	X		X
Grotta del Fico	2.500-700 b.C	Copper	Indigenous			X
Marcita	2.300-700 b.C	Bronze	Indigenous	X	X	X
Stretto Partanna	2.300-700 b.C	Bronze	Indigenous	X		X
Grotta Chiusilla	2.300-700 b.C	Bronze/Iron	Indigenous			X
Polizzello	1.200-1.100 b.C	Bronze/Iron	Indigenous	X	X	X
Baucina	500-600 b.C	Bronze/Iron	Indigenous	X	X	X
Desueri	1.100-900 b.C.	Iron	Indigenous			X
Motya	800-400 b.C.	Antiquity	Phoenician	X	X	
Birgi	700-100 b.C.	Antiquity	Phoenician	X	X	
Caserma Tukory	600-300 b.C.	Antiquity	Phoenician	X	X	X
Phoenician of Palermo	600-300 b.C.	Antiquity	Phoenician		X	
Contrada Petrarò (Entella)	600-200 b.C.	Antiquity	Phoenician			X
Lilibeo	400.100 b.C.	Antiquity	Phoenician	X	X	X
Manuzza-Selinunte	400-300 b.C.	Antiquity	Phoenician/Greek	X		
Marsala	300-100 b.C.	Antiquity	Greek/Roman	X	X	
Lipari	200 C.E.	Antiquity	Greek		X	
San Giovanni Marsala	300-400 C.E.	Late Antiquity	Indigenous			X
Licata	400-300 C.E.	Late Antiquity	Indigenous			X
Agrigento	400-500 C.E.	Late Antiquity	Indigenous		X	X
Sant'Agata	400-500 C.E.	Late Antiquity	Indigenous			X
Entella	1.000-1.300 C.E.	Middle Ages	Islamic			X
Castel San Pietro	1.000-1.300 C.E.	Middle Ages	Islamic	X	X	X
Segesta	1.200-1.300 C.E.	Middle Ages	Islamic			X
Monte Iato-Position(A)	1.000-1.300 C.E.	Middle Ages	Islamic	X		X
Monte Iato-Position(B)	1.000-1.300 C.E.	Middle Ages	Norman/Swabian	X	X	X
Maranfusa	1.200-1.300 C.E.	Middle Ages	Norman/Swabian	X		X
Caltavuturo	1.000-1.500 C.E.	Middle Ages	Mixed		X	
Alia	1.800 C.E.	Contemporary	Contemporary Sicilian	X	X	X
Rotoli	2.000 C.E.	Contemporary	Contemporary Sicilian		X	X
Contemporary Italian	2.013 C.E.	Contemporary	Contemporary Italian			X

Tab. 2.1 Sicilian Sample – Chronology, Ethnology and Type of Study

**B.P. Before Present – b.C. Before Christ – C.E Christian Era

*T. Teeth – M. Morphometrics – S. Stature

Place	Dating	Historical Periods***	Polulations	Morphometrics
La Encatada	2.000 b.C.	Bronce	Spanish	x
Almansa	1.200-1.500 C.E.	Middle Ages	Spanish-Christian	x
Veranes	1.200-1.300 C.E.	Middle Ages	Spanish-Christian	x
Lugo de Llanera	1.000-1.200 C.E.	Middle Ages	Spanish-Christian	x
Marialba	1.100-1.300 C.E.	Middle Ages	Spanish-Christian	x
Spain	2.000 C.E.	Contemporary	Contemporary Spanish	x
Argentinian	2.000 C.E.	Contemporary	Contemporary Argentinian	x

Tab. 2.2 Comparison Sample - Chronology and Ethnology and Type of Study
****B.P.** Before Present – **b.C.** Before Christ – **C.E** Christian Era

****Main Sicilian Historical Periods:**

B.P. Before Present – **b.C.** Before Christ – **C.E** Christian Era

Prehistory

- Upper Paleolithic: 40.000-10.000 B.P.
- Mesolithic: 10.000-8.000 B.P.
- Neolithic: 8.000-4.000 B.P.
- Eneolithic/Copper Age: 4.000-2.500 B.P.
- Bronze Age: 2.500-1.100 B.P.
 - Early Bronze Age: 2.500-2.000 B.P.
 - Middle Bronze Age: 2.000-1.500 B.P.
 - Late Bronze Age: 1.500-1.100 B.P.
- Iron Age: 1.100-700 B.P.

History

- Antiquity: 700 b.C. – 100 C.E.
 - Colonial Period: 700-600 b.C.
 - Classical Period: 600-400 b.C.
 - Hellenistic (Greek Period): 400-200 b.C.
 - Roman Republic Period: 200 b.C. – 100 C.E.
- Late Antiquity (Roman Empire Period): 100-476 C.E.
- Middle Ages: 476-1.492 C.E.
 - Byzantine Period: 500-1.000 C.E.
 - Islamic Period: 1.000-1.300 C.E.
 - Norman/Swabian Period. 1.300-1.500 C.E.
- Modern Ages: 1.492-1.789 C.E.
- Contemporary: 1.789 C.E. to Nowaday.

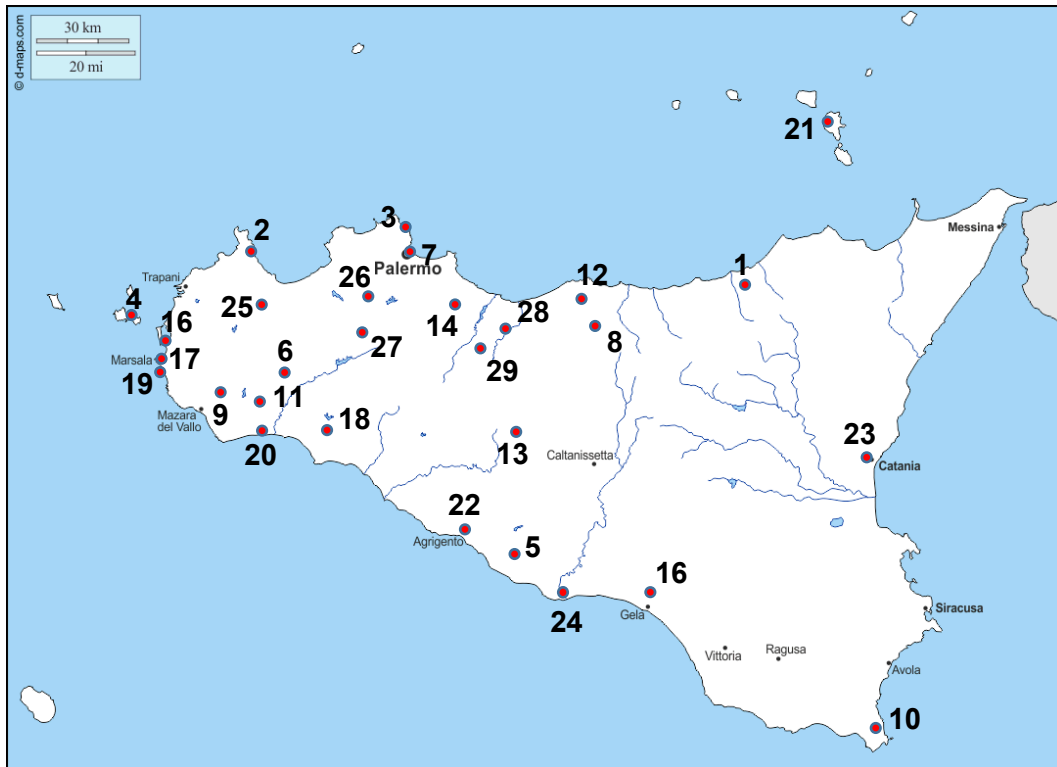

Fig. 2.1 Sicilian Sample - Map

- 1- Grotta di San Teodoro (Upper-Paleolithic)
- 2- Grotta dell'Uzzo (Mesolithic)
- 3- Grotta Molara (Mesolithic)
- 4- Grotta D'Oriente (Mesolithic)
- 5- Piano Vento (Neolithic)
- 6- Fossato Stretto Partanna (Neolithic) - Stretto Partanna (Bronze)
- 7- Palermo – Cave of San Ciro (Neolithic) - Caserma Tukory (Antiquity) – Phoenician of Palermo (Antiquity) - Castello San Pietro (Middle Ages) – Rotoli (Conemporary)
- 8- Grotta del Vecchiuzzo (Eneolithic)
- 9- Roccazzello (Eneolithic)
- 10- Grotta del Fico (Copper)
- 11- Marcita (Bronze)
- 12- Grotta del Chiusilla (Bronze/Iron)
- 13- Polizzello (Bronze/Iron)
- 14- Baucina (Bronze/Iron)
- 15- Desueri (Iron)
- 16- Mozia (Antiquity)
- 17- Lilibeo (Antiquity)
- 18- Contrada Petraro-Entella (Antiquity) - Entella (Middle Age)
- 19- Marsala (Antiquity) – Birgi (Antiquity) –San Giovanni Marsala (Late Antiquity)
- 20- Manuzza-Selinunte (Late Antiquity)
- 21- Lipari (Antiquity)
- 22- Agrigento (Late Antiquity)
- 23- Sant'Agata (Late Antiquity)
- 24- Licata (Late Antiquity)
- 25- Segesta (Middle Ages)
- 26- Monte Iato (Middle Ages)
- 27- Monte Maranfusa (Middle Ages)
- 28- Caltavuturo (Middle Ages)
- 29- Alia (Contemporary)

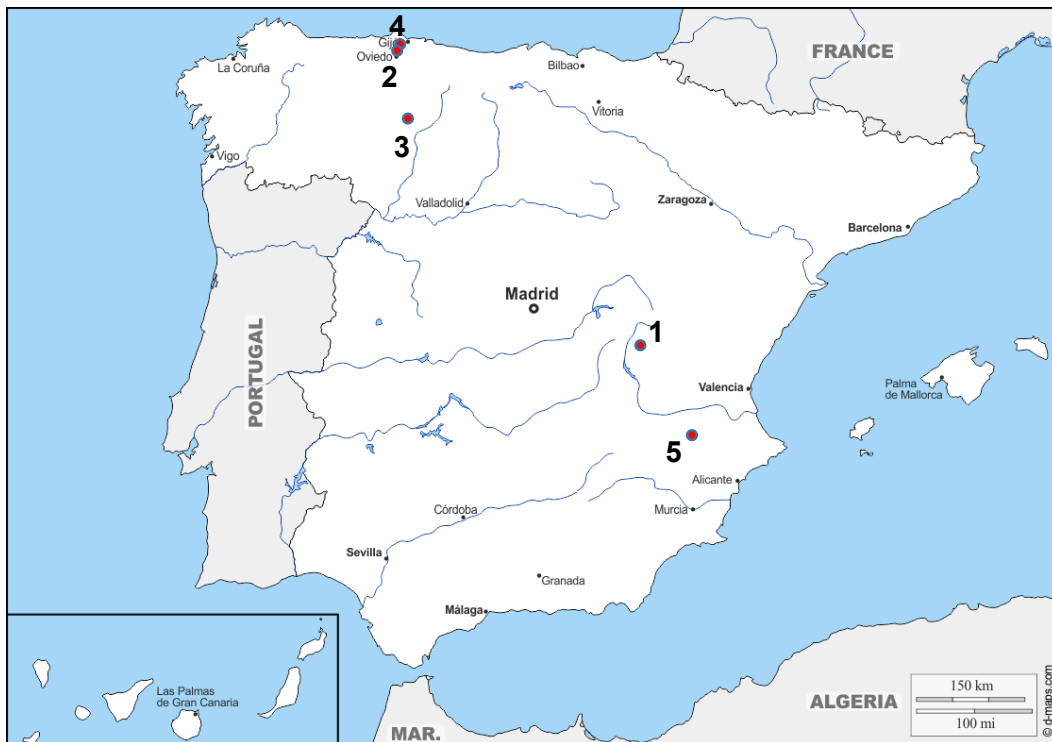

Fig. 2.2a Reference Spanish Sample – Map

- 1- La Encantada (Bronze)
- 2- Llanera (Middle Ages)
- 3- Marialba (Middle Ages)
- 4- Veranes (Middle Ages)
- 5- Almansa (Middle Ages)



Fig. 2.2b Phd Sample – Map

- 1- Sicily – Italy (Prehistory – Contemporary)
- 2- Italy (Contemporary)
- 3- Spain (Bronze-Middle Ages)
- 4- Buenos Aires – Argentina (Contemporary Argentinian and Contemporary Spanish)

2.1.1 Teeth 2D Measurements

The sample analyzed for the Odontological Section of this project consists of Mandibles' teeth measurements of (dental metrics of premolars and molars) individuals coming from 13 Sicilian sites (**Tab.2.3a-b**):

Site	Specimens	Dating	Historical Periods	Populations
Grotta del Uzzo	6	9.000 B.P.	Mesolithic	Mesolithic Hunter-Gatherers
Marcita	4	2.300-700 B.P.	Bronze	Indigenous
Stretto Partanna	1	2.300-700 B.P.	Bronze	Indigenous
Polizzello	1	1.200-1.100 B.P.	Bronze/Iron	Indigenous
Baucina	3	500-600 B.P.	Bronze/Iron	Indigenous
Motya	8	800-400 b.C.	Antiquity	Phoenician
Birgi	1	700-100 b.C.	Antiquity	Phoenician
Caserna Tukory	3	600-300 b.C.	Antiquity	Phoenician
Manuzza-Selinunte	2	400-300 b.C.	Antiquity	Phoenician/Greek
Marsala	3	300-100 b.C.	Antiquity	Greek/Roman
Castel San Pietro	1	1.000-1.300 C.E.	Middle Ages	Islamic
Monte Maranfusa	1	1.200-1.300 C.E.	Middle Ages	Norman/Swabian
Alia	6	1.800 C.E.	Contemporary	Contemporary Sicilian

Tab. 2.3a Sampled Site for the Odontological Section

Each population were chosen after a careful bibliographic study, considering the aim of the study and the possible contribution to this thesis's project.

The following tables show the papers considered before sampling.

Previous Study and Bibliography:

Place	Previous Study and Bibliography			
Grotta di SanTeodoro	Fabbri 1995	Bonfiglio et. al 2001	Sineo et. al 2002	D'Amore et. al 2009
Grotto del Uzzo	Borgognini & Repetto 1986	Costantini 1989	Borgognini et. al 1993	Mannino et. al 2007
Grotta D'Oriente	Di Salvo et. al 2007	Di Salvo et. al 2012		
Grotta di San Ciro	Bonfiglio et. al 2001	Burgio et. al 2002	Cangelosi et. al 2005	Brea 2016
Grotta del Vecchiuzzo	Di Salvo 1998	Lauria & Messina 2013		
Marcita	Di Salvo 1991 - 1998	Becker 2000	Larocca 2011	
Stretto Partanna	Di Stefano 1998	Conte et. al 2007	Nicoletti & Tusa 2012	
Polizzello	De Miro 1988	Messina et. al. 2008	Hods 2010	
Baucina	Castellana & Mallegni 1986	Belvedere et. al. 2017	Bellomo 2016	Cunzolo 2018
Motyà	Becker 1985 - 1998	Lauria et. al 2017	Minà 2018	
Birgi	Griffo 1997 - 2008	Fama' & Toti 2019		
Caserna Tukory	Germana' & Di Salvo 1994	Di Stefano 1995		
Lilibeo	Becker 1995	Bechtold et. al 1999		
Manuzza-Selinunte	Castellana 1992	Becker 2000		
Marsala	La Duca 2000	Becker 2000		
Castel San Pietro	Di Salvo 2004			
Monte Iato	Di Salvo 2004	Kistler 2012 – 2013 - 2014 - 2019	Reusser et. al. 2010 - 2015	Mölk 2019
Monte Maranfusa	Di Salvo 2004	Spatafora 2010		
Alia	Mannino 2016	Cangelosi 2017	LabHomo	

Tab. 2.3b Previous Study and Bibliography for the Odonthological Section

2.1.2 Craniofacial 3D Geometric Morphometrics

For the Morphometric section were build 3D models of Skull comings, as was possible, from the same sites mentioned above. However, considering the different status of preservation of each population the two samples are not exactly the same but belongs from the same historical period. Sicilian were compared to Spanish and Argentinian. The complete sample consists in 19 Sicilian populations, 6 Spanish, 1 modern Argentinian (Tab.2.4a-b-c).

Site	Specimens	Dating	Historical Periods	Populations
Grotta di San Teodoro	2	14.500 B.P. - ¹⁴ C	Upper Paleolithic	Würm-Settlers
Grotta del Uzzo	2	9.000 B.P.	Mesolithic	Mesolithic Hunter-Gatherers
Grotta della Molara	2	9.000 B.P.	Mesolithic	Mesolithic Hunter-Gatherers
Marcita	6	2.300-700 B.P.	Bronze	Indigenous
Polizzello	2	1.200-1.100 B.P.	Bronze/Iron	Indigenous
Baucina	2	500-600 B.P.	Bronze/Iron	Indigenous
Motya	3	800-400 b.C.	Antiquity	Phoenician
Birgi	5	700-100 b.C.	Antiquity	Phoenician
Caserma Tukory	3	600-300 b.C.	Antiquity	Phoenician
Phoenician of Palermo	4	600-300 b.C.	Antiquity	Phoenician
Lilibeo	4	400.100 b.C.	Antiquity	Phoenician
Marsala	1	300-100 b.C.	Antiquity	Greek/Roman
Lipari	6	200 C.E.	Antiquity	Greek
Agrigento	1	400-500 C.E.	Late Antiquity	Indigenous
Castel San Pietro	2	1.000-1.300 C.E.	Middle Ages	Islamic
Monte Iato-Position(B)	4	1.000-1.300 C.E.	Middle Ages	Norman/Swabian
Caltavuturo	5	1.000-1.500 C.E.	Middle Ages	Mixed
Alia	46	1.800 C.E.	Contemporary	Contemporary Sicilian
Rotoli	4	2.000 C.E.	Contemporary	Contemporary Sicilian

Tab. 2.4a Sampled Site for the Geometric Morphometrics Section

Place	Specimens	Dating	Historical Periods	Populations
La Encatada	2	2.000 b.C.	Bronze	Spanish
Almansa	17	1.200-1.500 C.E.	Middle Ages	Spanish-Christian
Veranes	18	1.200-1.300 C.E.	Middle Ages	Spanish-Christian
Lugo de Llanera	4	1.000-1.200 C.E.	Middle Ages	Spanish-Christian
Marialba	8	1.100-1.300 C.E.	Middle Ages	Spanish-Christian
Spain	2	2.000 C.E.	Contemporary	Contemporary Spanish
Argentinian	9	2.000 C.E.	Contemporary	Contemporary Argentinian

Tab. 2.4b Sampled Site for the Comparison of Geometric Morphometrics Section

Previous Study and Bibliography:

Place	Previous Study and Bibliography			
Grotta di SanTeodoro	Bonfiglio et. al 2001	Sineo et. al 2002	D'Amore et. al 2009	
Grotta del Uzzo	Borgognini & Repetto 1986	Costantini 1989	Borgognini et. al 1993	Mannino et. al 2007
Grotta della Molara	Silvana et. al 1985	Becker 2000		
Marcita	Di Salvo 1991 - 1998	Becker 2000	Larocca 2011	
Polizzello	De Miro 1988	Messina et. al. 2008	Hods 2010	
Baucina	Castellana & Mallegni 1986	Belvedere et. al. 2017	Bellomo 2016	Cunzolo 2018
Motya	Becker 1985 - 1998	Lauria et. al 2017	Minà 2018	
Birgi	Griffo 1997 - 2008	Fama' & Toti 2019		
Caserna Tukory	Germana' & Di Salvo 1994	Di Stefano 1995		
Phoenician of Palermo	Lab Homo in progress			
Lilibeo	Becker 1995	Bechtold et. al 1999		
Marsala	La Duca 2000	Becker 2000		
Lipari	Brea & Cavalier 1965	Cavalier 1995		
Agrigento	Cesare 2018			
C. San Pietro	Di Salvo 2004			
M. Iato	Di Salvo 2004	Kistler 2012 – 2013 - 2014 -2019	Reusser et. al. 2010 - 2015	Mölk 2019
Caltavuturo	Passafiume 1645	Pancucci 1989	Romana 2009	Vassallo 2009
Alia	Mannino 2016	Cangelosi 2017		
Rotoli	LabHomo			
La Encatada	Huerta & Hervás 2004			
Almansa	Gil et. al 2016			
Veranes	Jurado-Gómez 2007	Rascón et. al 2011		
Lugo de Llanera	Ochoa & Diaz 1999			
Marialba	González et. al. 2016			
Modern Spanish	LEEH			
Modern Argentinian	LEEH			

Tab. 2.4c Previous Study and Bibliography for the Morphometric Section

2.1.3 Secular Trend of Stature

For the Stature's Secular Trend were mainly done a review-job analyzing 27 Sicilians populations (**Tab.2.5a**). 24 were already present in literature (measured by Dr. Di Salvo), 3 new populations were measured for the first time while 9 of the previous 24 were re-measured (all the data confirms literature) (**Tab.2.5b**).

Site	Specimens	Dating	Historical Periods	Populations
Grotta di San Teodoro	2	14.500 B.P. - ¹⁴ C	Upper-Paleolithic	Würm-Settlers
Grotta del Uzzo	13	9.000 B.P.	Mesolithic	Mesolithic Hunter-Gatherers
Piano Vento	15	3.500 B.P.	Neolithic	Indigenous
Fossato Stretto Partanna	7	3.500 B.P.	Neolithic	Indigenous
Roccazzello	18	3.500-2.300 B.P.	Eneolithic	Indigenous
Grotta del Vecchiuzzo	2	3.500-2.300 B.P.	Eneolithic	Indigenous
Grotta del Fico	2	2.500-700 B.P.	Copper	Indigenous
Marcita	30	2.300-700 B.P.	Bronze	Indigenous
Stretto Partanna	20	2.300-700 B.P.	Bronze	Indigenous
Grotta Chiusilla	/	2.300-700 B.P.	Bronze/Iron	Indigenous
Polizzello	102	1.200-1.100 B.P.	Bronze/Iron	Indigenous
Baucina	52	500-600 B.P.	Bronze/Iron	Indigenous
Desucri	260	1.100-900 B.P.	Iron	Indigenous
Caserna Tukory	/	600-300 b.C.	Antiquity	Phoenician
Contrada Petraro (Entella)	32	600-200 b.C.	Antiquity	Phoenician
Lilibeo	/	400.100 b.C.	Antiquity	Phoenician
San Giovanni Marsala	16	300-400 C.E.	Late Antiquity	Indigenous
Licata	22	400-300 C.E.	Late Antiquity	Indigenous
Agrigento	/	400-500 C.E.	Late Antiquity	Indigenous
Sant'Agata	284	400-500 C.E.	Late Antiquity	Indigenous
Entella	47	1.000-1.300 C.E.	Middle Ages	Islamic
Castel San Pietro	/	1.000-1.300 C.E.	Middle Ages	Islamic
Segesta	70	1.200-1.300 C.E.	Middle Ages	Islamic
Monte Iato-Position(A)	10	1.000-1.300 C.E.	Middle Ages	Islamic
Monte Iato-Position(B)	7	1.000-1.300 C.E.	Middle Ages	Norman/Swabian
Monte Maranfusa	7	1.200-1.300 C.E.	Middle Ages	Norman/Swabian
Alia	/	1.800 C.E.	Contemporary	Contemporary Sicilian
Rotoli	20	2.000 C.E.	Contemporary	Contemporary Sicilian
Modern Italian	57,7 "mln"	2.013 C.E.	Contemporary	Contemporary Italian

Tab. 2.5a Sampled Site for the Secular Trend Section / = no records available

Previous Study and Bibliography:

Place	Previous Study and Bibliography	
Grotta di San Teodoro	Fabbri 1993	Whitehouse 2016
Grotta del Uzzo	Borgognini et. al 1993	LabHomo
Piano Vento	Di Salvo 1998	
Fossato di Stretto Partanna	Schimmenti & Di Salvo 1997	LabHomo
Roccazzello	Schimmenti & Di Salvo 1997	Di Salvo 1998
Grotta del Vecchiuzzo	Lauria & Messina 2013	
Grotta del Fico	Di Salvo 1998	
Marcita	Di Salvo 1991 - 1998	LabHomo
Stretto Partanna	Schimmenti & Di Salvo 1997	LabHomo
Grotta Chiusilla	Di Salvo 1998	
Polizzello	Schimmenti & Di Salvo 1997	
Baucina	Castellana & Mallegni 1986	Belvedere et. al. 2017
Desueri	Di Salvo & Schimmenti 2006	
Caserma Tukory	Germana' & Di Salvo 1994	LabHomo
Contrada Petraro (Entella)	Pautasso 2017	
Lilibeo	Becker 1995	
San Giovanni Marsala	Di Salvo et. al 2008	LabHomo
Licata	La Torre & Raffa 2016	Cangelosi 2017
Agrigento	Di Salvo et. al 2008	LabHomo
Sant'Agata	Di Salvo et. al 2008	
Entella	Di Salvo 2004	
Castel San Pietro	Di Salvo 2004	LabHomo
Marsala	Di Salvo 1984	
Segesta	Di Salvo 2004	
Monte Iato-Position(A)-Muslim	Di Salvo 2004	LabHomo
Monte Iato-Position(B)-Supine	Di Salvo 2004	LabHomo
Monte Maranfusa	Di Stefano & Cadei 1997	LabHomo
Alia	Cangelosi 2017	LabHomo
Rotoli	LabHomo	
Contmporay Italian	Istitutio Italiano di Statistica	

Tab. 2.5b Previous Study and Bibilography for the Secular Trend Section

2.2 Methods

This project has been developed in three sections to investigate (in a wide range) the human biodiversity in the Mediterranean and Island context.

For these reasons were employed several different techniques suitable for each topic.

Described in the next paragraphs all the tools and the methods employed to reach the proposed goals.

As done in the previous chapter methods will be carefully described in three different paragraphs:

- Dental Metrics
- Geometric Morphometrics
- Secular Trend

2.2.1 Dental Metrics

The quantification of tooth dimensions is mainly done by dental metrics of crown width and length ([Pilloud & Hefner 2016](#)). Dental metric data were collected measuring dental crown Mesiodistal and Buccolingual diameter ([Kieser et. al 1990](#)) of premolars and molars by a digital calliper.

Considering that dental dimensions within the same tooth class are highly correlated ([Moorrees & Reed 1964](#)) were measured all the teeth of the two dental arcades of the mandible. Premolars and molars were chosen because the most distal teeth tend to reflect more the variation about the environment, classifying better the groups ([Kenyhercz 2014](#)).

The Mesiodistal diameter of posterior teeth is the maximum diameter of the tooth crown in the mesiodistal plane (**Fig. 2.3a**) (parallel the occlusal and buccal surface) ([Moorrees 1957](#) – [Moorrees & Reed 1964](#) - [Mayhall 1992](#) – [Hemphill 2015](#)). This measure was preferred because is easier to define (also in case of malocclusion) and not dependent on accurate observations of contact facets ([Buikstra & Ubelaker 1994](#)).

The Buccolingual measurement is the maximum diameter in the buccolingual, or labiolingual, a plane perpendicular to the mesiodistal plane (**Fig.2.3b**) ([Moorrees & Reed 1964](#) – [Mayhall 1992](#) - [2000](#)).

During collections were avoided teeth affected by any wear or attrition, diseases and all the biological stress.

The precision of measurements was granted by using standard dental metrics and careful calibration of the measuring equipment to reduce reading and recording data entry errors.

Data were analyzed using [Statistical Multivariate](#) procedures commonly used in skeletal biology to investigate the patterns between the groups.

First of all, log/shape ratios (logarithmic scale transformation) ([Clauset et. al 2009](#) - [Claude 2013](#)) were applied to dental metrics raw data to obtain the same yield of Procrustes analysis (without the possibility to visualize shape differences).

After that, Loadings and the related PCA were carried using the classical algorithm that produces a symmetric matrix of variance-covariance of the variables ([Davis 1986](#)) between the groups.

In the end MANOVA/CVA, MDS (see [Pag.53](#)) and NEIGHBOUR JOINING (Root-Outgroup) (see [Pag.54](#)) were realized with the Euclidean distances.

The Euclidean distances are simply the linear distances between two points x and y in a multidimensional space (it is the measure of the segment having the two points as extremes). It combines the offsets between variables that can be expressed in different units of measurement. Using this formula as a distance, Euclidean space becomes a metric space ([Gower & Legendre 1986](#)).

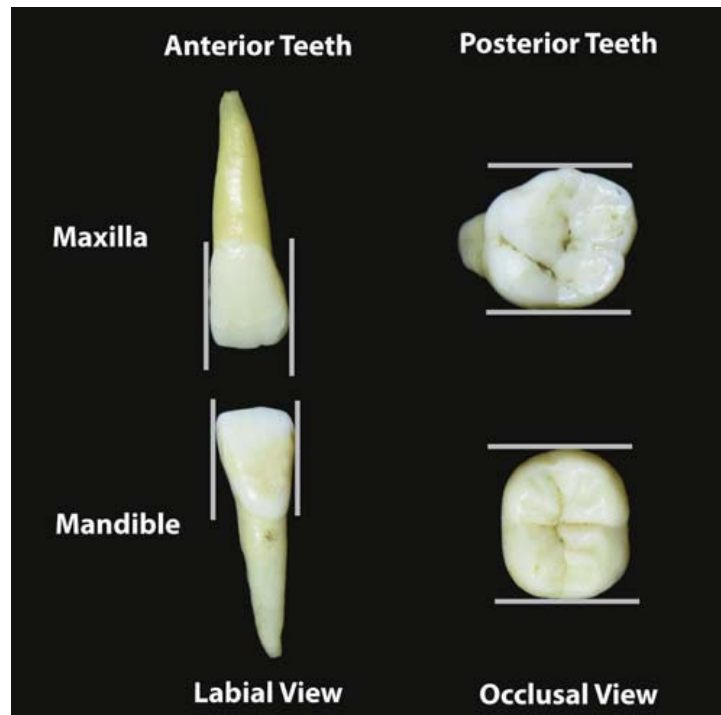

Fig. 2.3a Maximum Mesiodistal dimensions of anterior and posterior teeth
 (Photo from [Pilloud & Hefner 2016](#))

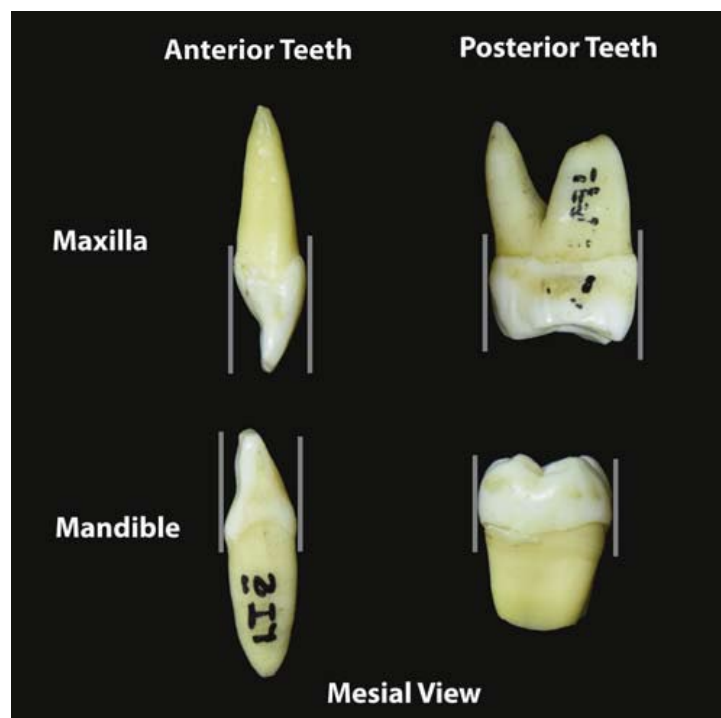

Fig. 2.3b Maximum Buccolingual dimensions of anterior and posterior teeth
 (Photo from [Pilloud & Hefner 2016](#))

2.2.2 Geometric Morphometrics

The main section of this project is, without any doubts, the Geometric Morphometrics analysis of Skulls.

To perform this analysis was made a database of Skulls 3D ([Bruner 2002 – 2009](#) – [Gunz et. al 2009b](#) – [Harvati et. al 2010](#)) models acquired by Computer Tomography (CT) and Photogrammetry.

Computer Tomography: (formerly computerized axial tomography scan or CAT scan [CATscan MedicineNet](#)) is a technique based on X-Ray (**Fig.2.4a-b**) that through a computer process allows building 3D models (stored in the medical files extension .dicom).

X-Ray measurement, taken from different angles, produces cross-sectional images (composed by several virtual slices) of the object forming a 3D (**Fig.2.5a-b**) model ([Herman 2009](#)). CT allows the operator to see the inside the object without cutting them but do not reproduce the texture (also irradiate several radiations dose units).

The models obtained are the result of a digital geometry process that also generates a set of two-dimensional radiographic images (**Fig.2.6a-b**) for each axe of rotations.

CT models can be manipulated to underline a specific structure and drawing on the models ([Bruner 2004 - Bruner & Manzi 2003 - 2006](#) – [Slon et. al 2014](#) – [Menéndez et. al 2019](#)) that could be exported in different files extensions useful for other analysis ([Brandfiled et. al 2016](#)) (medical and quantitative studies - [Rangel de Lanzaro et. al 2016](#) - and also 3D printing).

PHILIPS-90082 SH		
SliceThickness	0.625	DS
KVP	120	DS
DataCollectionDiameter	500	DS
SoftwareVersions	2.6.0	LO
ReconstructionDiameter	500	DS
ExposureTime	6500	IS
XRayTubeCurrent	30	IS
ScanArc	90	DS
TableHeight	61	DS

Fig. 2.4a Model and Main-Settings of CT scan based on X-Ray used for the Sicilian Sample



Fig. 2.4b CT scan based on X-Ray San Teodoro1
The Oldest Specimens found in Sicily



Fig. 2.5a CT of San Teodoro1
The Oldest Specimen found in Sicily



Fig. 2.5b CT of San Teodoro1
The Oldest Specimen found in Sicily

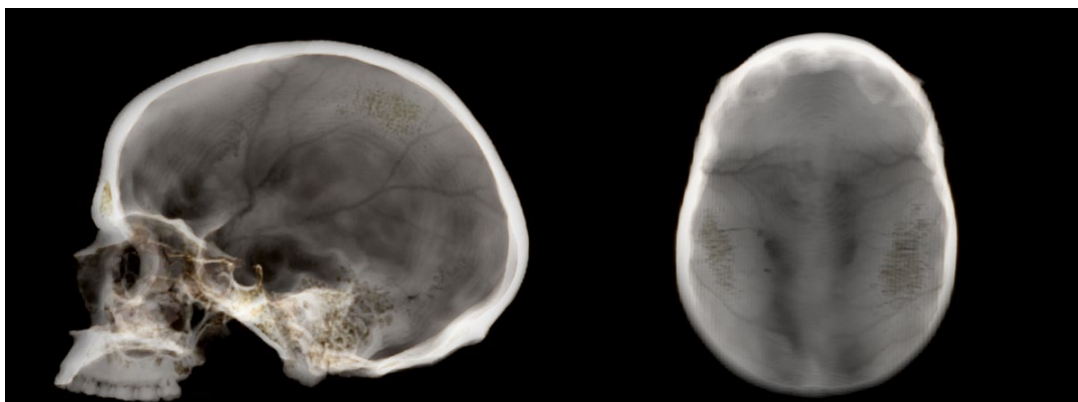

Fig. 2.6a CT Radiography of San Teodoro1
The Oldest Specimen found in Sicily

Fig. 2.6b CT Radiography of San Teodoro1
The Oldest Specimen found in Sicily

Photography: The skulls were photographed using a Nikon D700 digital camera, (with a total of with 20 Megapixel) mounted on a tripod. Four-paper metric scales were added around each bone to scale models (**Fig.2.7**). To ensure that photography completely covered each sample were taken two sets of 54 images for the same specimen:

- Superior Side or Chunk1 (**Fig.2.8a**).
- Inferior Side or Chunk2 (**Fig.2.8b**).

The specimens were rotated through 360° and photographed at 20° rotations intervals at three different heights for each side (**Fig.2.9a-b-c** and **Fig.2.10a-b-c**). This resulted in 108 individual camera positions encircling the specimen in six circuits. All images were recorded in manual mode (with a fixed focal distance of 22mm) in RAW format and then converted in high-resolution JGP format using Camera Raw 10.3.



Fig. 2.7 Digital Camera on a Tripod

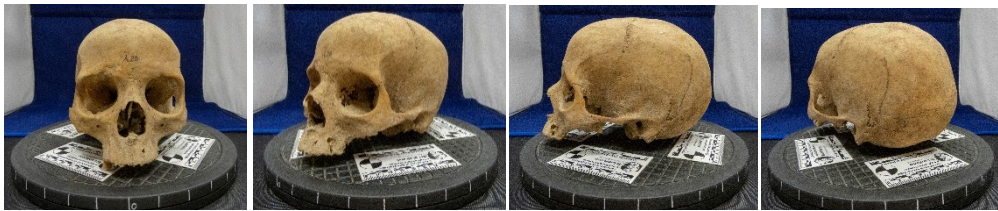

Fig. 2.8a Photo Set of Inferior Side – 4 of 54 photos that will form Chunk1

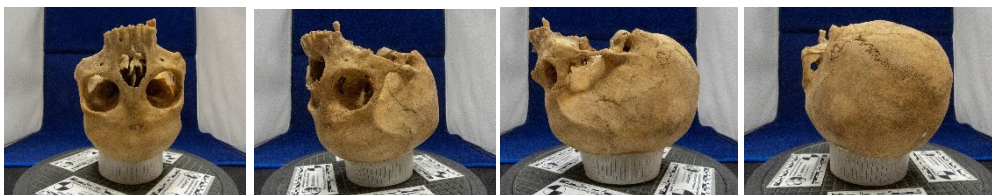

Fig. 2.8b Photo Set of Superior Side – 4 of 54 photos that will form Chunk2

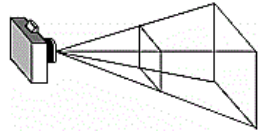

Fig. 2.9a Chunk1-Height1



Fig. 2.10a Chunk2-Height1

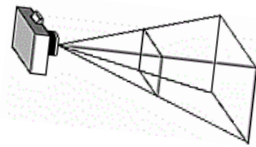

Fig. 2.9b Chunk1-Height2



Fig. 2.10b Chunk2-Height2

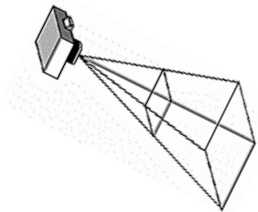

Fig. 2.9c Chunk1-Height3



Fig. 2.10c Chunk2-Height3

Photogrammetry: For each studied sample, a 3D digital model was generated using [Agisoft-Metashape](#) software. The software was set to "**High**" option for both [Alignment](#) and [Dense Cloud](#) generation.

As said a set of images was acquired for each side of the specimen and two set for each skull were processed separately (**Fig.2.11a** and **Fig.2.12a**) until the dense cloud (**Fig.2.11c** and **Fig.2.12c**).

The two dense clouds were so Scaled (matching and using as references five scale bars of 1 cm for a final error of precision always between 0,2 cm and 0,3 cm in the whole sample) and Cleaned (**Fig.2.11d** and **Fig.2.12d**).

This produced two “Chunks” were Aligned (Workflow - Align Chunk) with the method “Marker-based” and subsequently Merged (Workflow - Merge Chunk) using four landmarks (one for each side of the skull) (**Fig.2.11d** and **Fig.2.12d**).

Finally, the newly generated “Merged chunk” (**Fig.2.13**) was used to build mesh and texture. [Mesh](#) (polygonizations) (**Fig.2.14**) was done using custom settings “Face count of “**2.500.000**”. Once finished, [Texture](#) (**Fig.2.15**) was generated using “**Generic mapping mode**” option.

<p>Sparse Cloud Key Point Limit: 40000 Tie Point Limit: 4000 Accuracy: High Pair Preselection: Disabled</p>

<p>Dense Cloud Quality: High Deep Filtering: Aggressive</p>

<p>Mesh Surface: Arbitrate Source: Dense Cloud Face Count: 2.500.000 Interpolation: Default</p>

<p>Texture Mapping Mode: Generic Blending Mode: Mosaic Texture Size/Count: 4096x1 Enable Colour Correction: not marked Interpolation: Default</p>

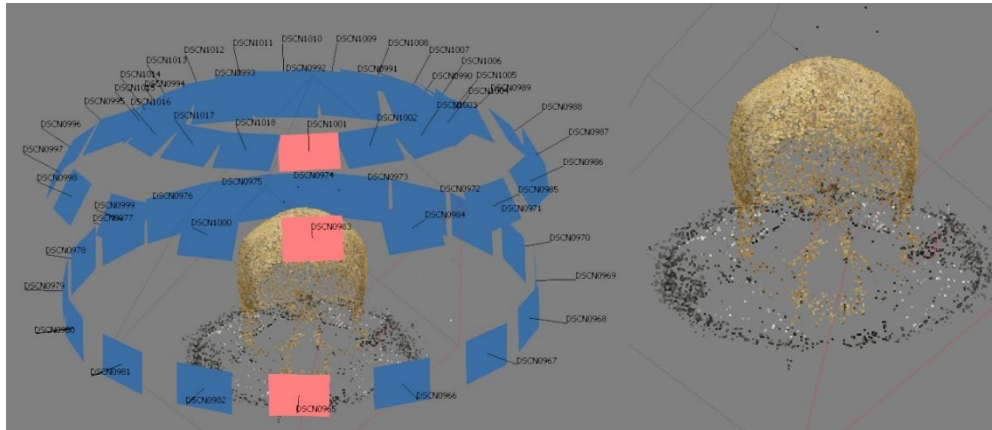

Fig. 2.11a Sparse Cloud Chunk1-Cameras Show **Fig. 2.11b** Sparse Cloud Chunk1

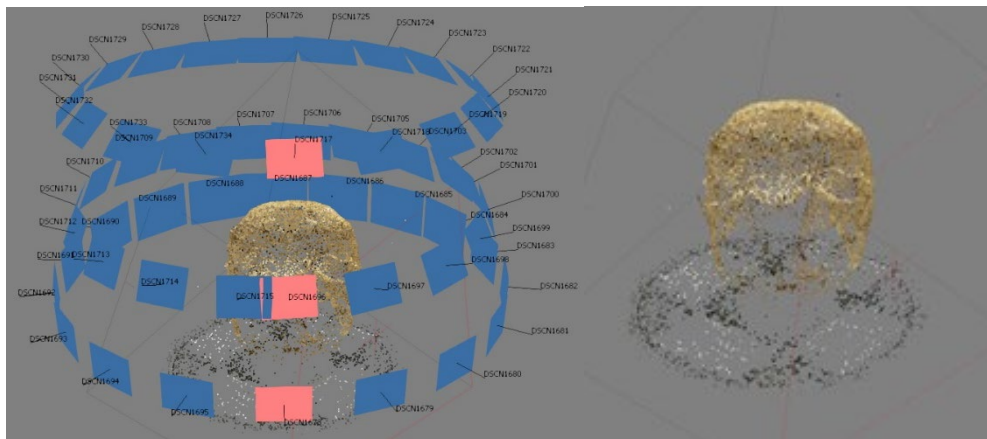

Fig. 2.12a Sparse Cloud Chunk2-Cameras Show **Fig. 2.12b** Sparse Cloud Chunk2

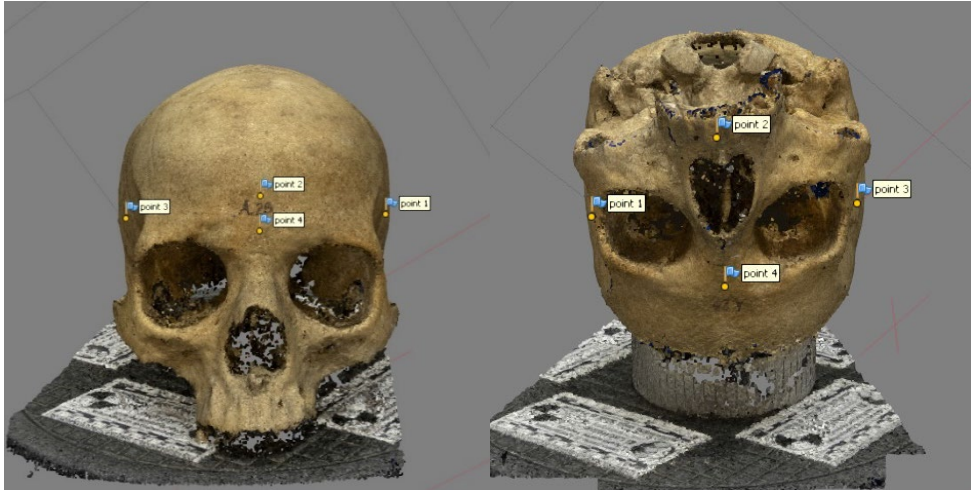

Fig. 2.11c Dense Cloud Chunk1
+ Markers to Merge

Fig. 2.11c Dense Cloud Chunk2
+ Markers to Merge



Fig. 2.12d Dense Cloud Chunk1
Scaled and Cleaned

Fig. 2.12d Dense Cloud Chunk2
Scaled and Cleaned



Fig. 2.13 Dense Cloud - Merged Chunk



Fig. 2.14 Mesh – Shaded View



Fig. 2.15 Texture

Geometric Morphometrics: The morphometric analysis was carried out using a configuration of 26 landmarks marked and taken twice by the software “Landmark3.6” – University of California Davis”. All 26 landmarks (**Fig.2.16a-b**) were positioned exactly above Sutures Junction (Landmarks Type1) and Anthropometric points (Landmarks Type2) (**Tab. 2.7**).

Klingenberg-MophoJ and PAST.2 (“Hammer Ø.”: Paleontological Museum, University of Oslo, Norway- “Harper D. A. T.”: Geological Museum, University of Copenhagen, Denmark and “Ryan P. D.”: Department of Geology, National University of Ireland, Galway, Ireland) software were finally used to perform the morphometric and statistical analysis. Through this software, landmarks were Procrustized and subsequently visualized in Wireframe, Lollipop and Shape Deformations Graphs (Soft Wireframe), and treated for a Principal Component Analysis (PCA) applied as previously described on Paragraph 2.2.1 (Pag.79).

Landmarks	MorphoJ	Landmarks	Type
0	1	Prostion	1
1	2	Nasospinal	1
2	3	Nasion	1
3	4	Glabella	2
4	5	Bregma	1
5	6	Lambda	1
6-7	7-8	Point between the dental alveoli I2/C	1
8-9	9-10	Alare	2
10-11	11-12	Zygomatic-Maxillary suture - lower margin	1
12-13	13-14	Zygomatic-Maxillary suture – upper margin	1
14-15	15-16	Maxillary-Frontal suture	1
16-17	17-18	Ectoconchion	1
18-19	19-20	Fronto-Temporal-Malar	1
20-21	21-22	Frontotemporal	1
22-23	23-24	Occipital - Temporal - Parietal intersection	1
24-25	25-26	Stephanion	1

Tab. 2.7 Anatomical Landmarks considered in this study

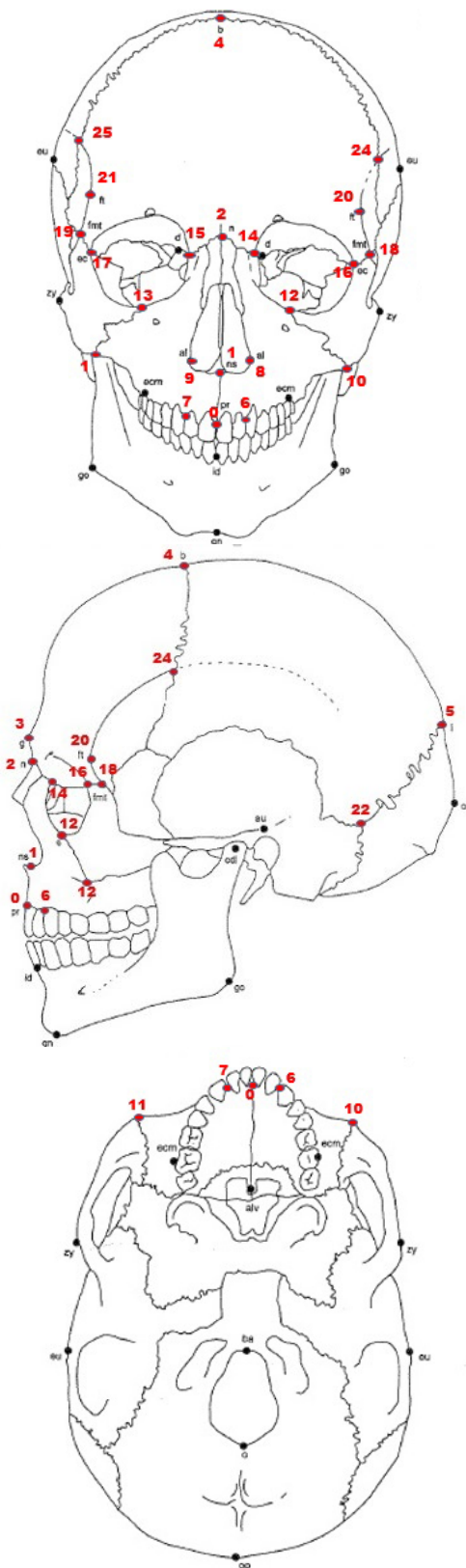

Fig. 2.16a Anatomical Landmark's Postions
 (Draw from [Buikstra & Ubelaker 1994](#))
 Numeration according the software "[Landmark](#)"

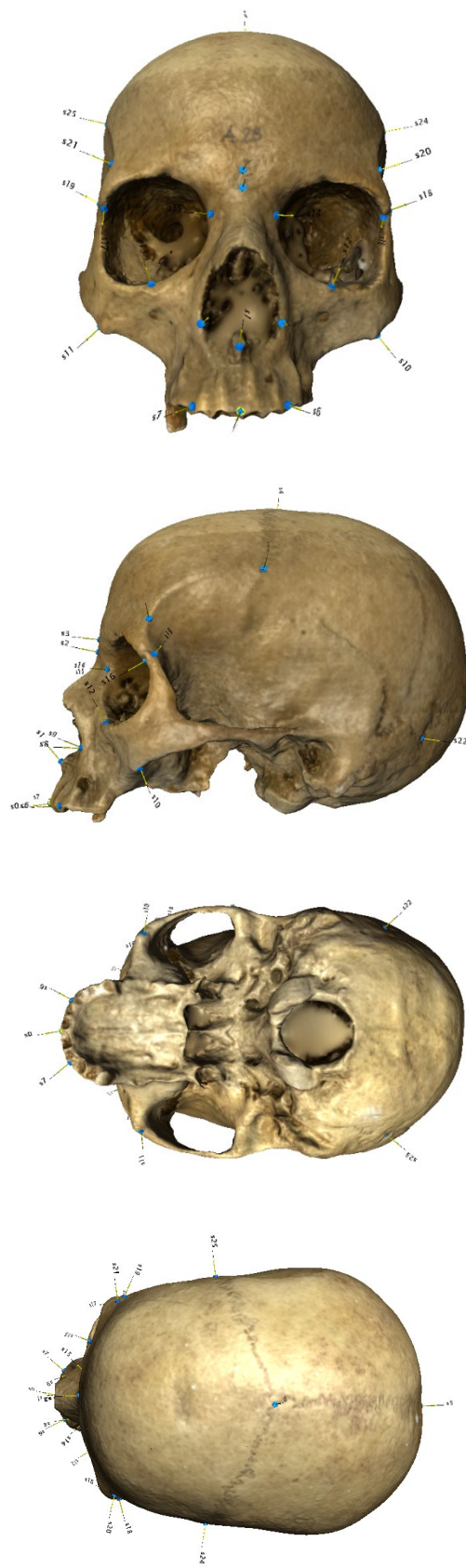

Fig. 2.16b Captured Screen-Shot from “[Landmark](#)”

2.2.3 Secular Trend

To estimate the height of the different populations were measured the maximum length of arms and legs long bones using an osteometric board.

In details were measured long bones maximum length as propose by Martin and Saller ([Martin & Saller 1957](#)) and by Buikstra and Ubelaker ([Buikstra & Ubelaker 1994](#)):

- *Humerus* Maximum Length: distance from the most superior point of the head to the most inferior point of the trochlea (**Fig.2.17a**).
- *Radius* Maximum Length: distance from the most proximally positioned point of the head to the tip of the styloid process (**Fig.2.17b**).
- *Ulna* Maximum Length: distance from the most superior point of the olecranon to the most inferior point of the styloid process (**Fig.2.17c**).
- *Femur* Maximum Length: distance from the most superior point of the head to the most inferior point of distal condyles (**Fig.2.18a**).
- *Tibia* Maximum Length: distance from the articular superior surface of the lateral condyles to the most inferior point of the tip of the medial malleolus (**Fig.2.18b**).
- *Fibula* Maximum Length: distance from the most superior point of the fibula to the most inferior point of the lateral malleolus (**Fig.2.18c**).

To standardize the results were always applied the formulas of Trotter and Gleser ([Trotter & Gleser 1952 – 1958](#)) as well for the measured bones as in literature where they were selected only data estimated by this method.

The formulas of [Trotter and Gleser](#) allow estimating the stature from isolated bones. As said above authors proposed several regression equations for ethnicity, sex and singular bone. Starting from long bones, maximum length height was calculated in cm according to Martin's method of measurement.

The formulas are valid only for individuals with sex determined and between 18 and 30 years old (for older are necessary subtract 0.06 cm for each year - $0.06 \times$ years) ([Canci & Minozzi 2005](#)).

As the previous two sections, the same Statistics Techniques were performed to fulfill the Multivariate Analysis (see Paragraph 2.2.1 - [Pag.79](#)).

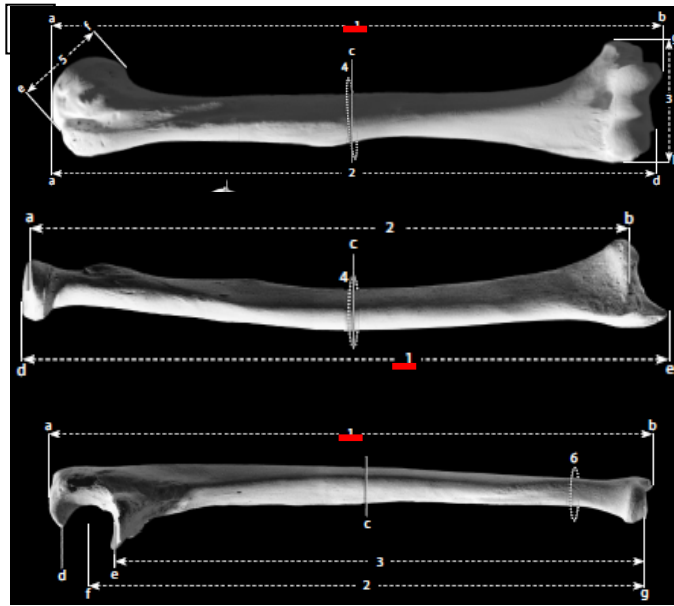

Fig. 2.12 Long Bones of Arm: Humerus – Radio – Ulna

- 1- [Maximun Length](#)
- 2- Biomechanical Length
- 3- Physiological Length

(Photo from [White et. al 2011](#))

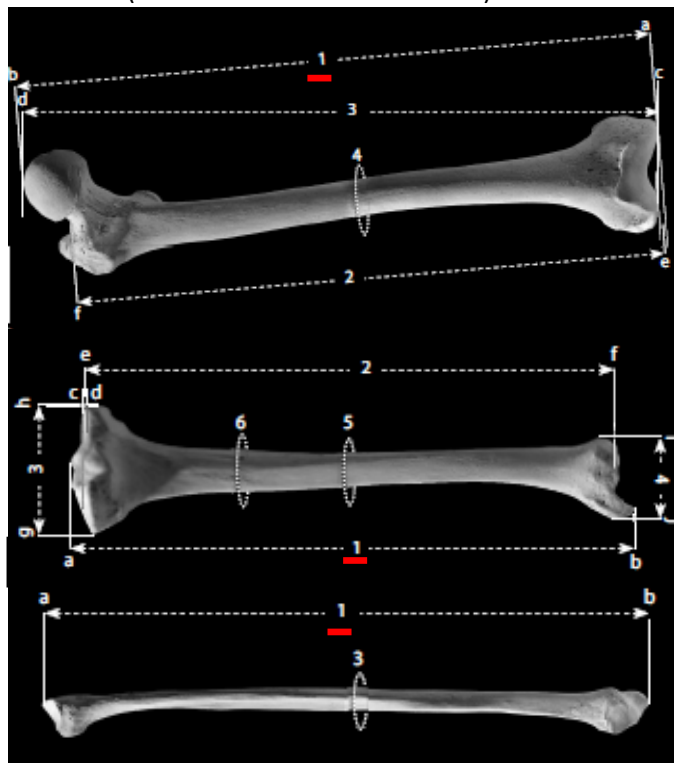

Fig. 2.13 Long Bones of Leg: Femur– Tibia– Fibula

- 1- [Maximun Length](#)
- 2- Biomechanical Length
- 3- Physiological Length

(Photo from [White et. al 2011](#))

3. Results and Discussion

3.1 Dental Metrics

3.1.1 Preliminary Studies

Preliminary Odontological studies (Lauria & Messina 2013), done on Prehistorical and Historical samples of Central-Western Sicily, had already shown the reliability of this approach. These Odontometrics Data had also provided a preliminary analysis of the relationship between the Sicilian populations applying statistics multivariate techniques.

Below are quickly summarized because they adduce the basis on which the hypotheses pursued in this project were formulated.

In detail, the following data (Tab. 3.1) were collected acquiring tooth's measures of 12 Sicilian Site:

Site		Period	Keys	Population
Grotta di San Teodoro	ST	Upper-Palaeolithic	Red Box-3	Würm-Settlers
Grotta dell'Uzzo	GU	Mesolithic	Sky Blue Box-1	Mesolithic Hunter-Gatheres
Grotta D'oriente	GO	Mesolithic	Sky Blue Box-1	Mesolithic Hunter-Gatheres
Grotta di San Ciro	SC	Neolithic	Sky Blue Box-1	Indigenous
Grotto del Vecchiuzzo	GV	Neolithic	Sky Blue Box-1	Indigenous
Cave of San Ciro	SC	Neolithic	Green Box-4	Indigenous
Marcita	MA	Bronze	Orange Box-2	Indigenous
Polizzello	PO	Bronze/Iron	Orange Box-2	Indigenous
Stretto Partanna	STR	Bronze	Orange Box-2	Indigenous
Caserma Tukory	TU	Antiquity	Green Box-4	Phoenician
San Giovanni Marsala	SG	Late Antiquity	Green Box-4	Indigenous
Monte IatoA	MIA	Middle Ages	Yellow Box-5	Islamic
Monte IatoB	MIB	Middle Ages	Yellow Box-5	Indigenous.

Tab. 3.1 Sampled Sicilian Site for Preliminary Study – Dental Metrics

The PCA (**Fig. 3.1**) and the MDS (**Fig. 3.2**) shows a clear separation between the Paleolithic, Mesolithic and Neolithic samples (**Sky-Blue Box-1**) that lies along the negative side (except for SC) of the first component and the Protohistoric and Historic samples (**Orange Box-2**) found on the positive side. To notice is that:

- The oldest specimens of Sicily coming from ST grouped with the other Prehistoric but separated from everyone else (**Red Box-3**).
- Inside the Orange Box is possible to find two sub-groups composed by I) The Protohistoric Samples of MA and PO, related to the Phoenician of TU, that lies exactly between the negative and positive side (Prehistoric and Historic) (**Green Box-4**). II) The Historic samples of MIA- Islamic and MIB- Indigenous (same site and period) close to each other but lying one along the positive side and one along the negative side (**Yellow Box-5**).

Distances 'Matrix (**Tab. 3.2**) also underline the shorter distances (or similarity) that characterized the four main groups:

- Paleolithic, Mesolithic and Neolithic samples (**Sky-Blue Box**).
- Protohistoric and Historic samples (**Orange Box**).
- Protohistoric Sample and Phoenician (**Green Box**).
- Indigenous and Settlers coming the same site and period (**Yellow Box**).

Highlighted is the strong similarity between the specimens belonging Green and Yellow Boxes and the specimens belonging of Sky-Blue and Orange Boxes.

Sky-Blue samples are characterized by a certain variety with the oldest samples of Sicily (ST-**Red Box**) related but separated from the other Prehistoric Samples.

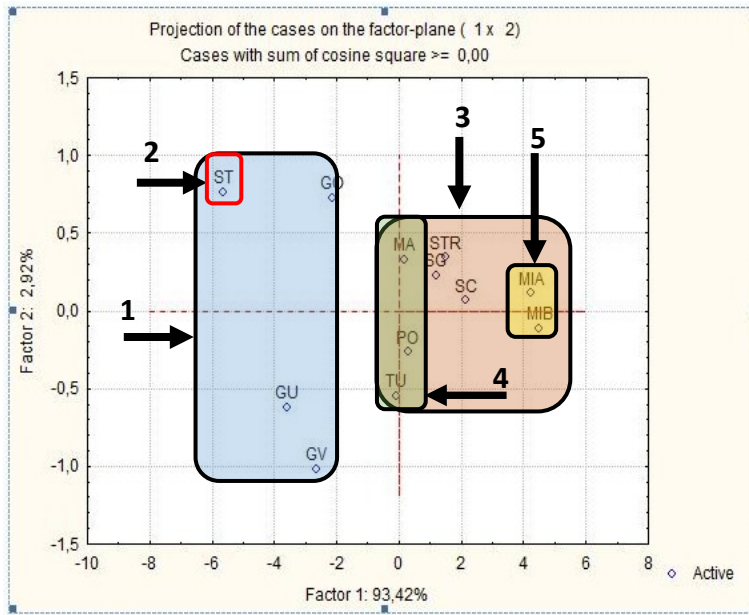

Fig.3.1 Scatterplot of the Main Components. The Eigenvalue of the the first three components respectively are 9,34, 0,29 and 0,13

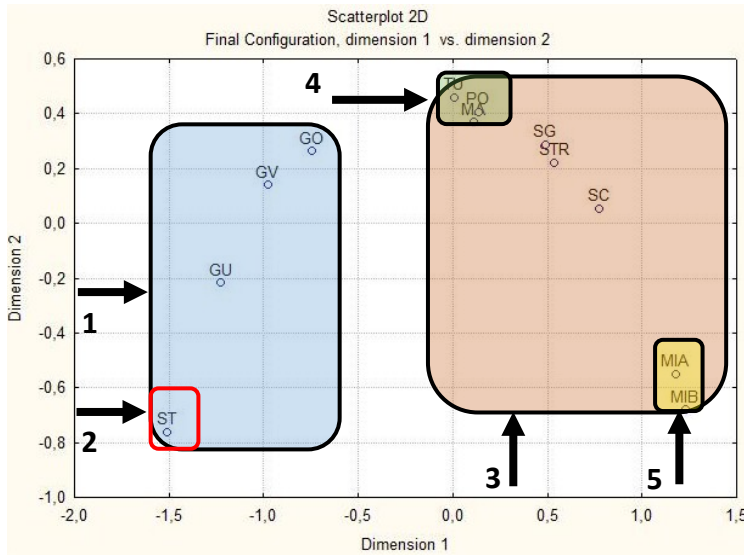

Fig.3.2 Scatterplot of the MDS

	ST	GU	GO	SC	GV	STR	MA	PO	TU	SG	MIA	MIB
ST	0,0000	3,2059 5	4,9367	10,7565 1	4,71268	9,7628 1	7,8597 1	8,1334 1	7,7990 7	9,3997 9	13,4710 3	13,8859 9
GU	3,2059 9	0,0000	3,3249	8,51459	2,16344	7,6102 6	5,7926 5	5,8512 4	5,4228 9	7,2625 1	11,2198 1	11,6079 8
GO	4,9367 7	3,3249	0,0000	6,02434	2,62644	5,1383 4	3,2628 2	3,8227 4	3,4748 5	4,7775 9	8,73200	9,20972
SC	10,7565 6	8,5145	6,0243	0,00000	7,00812	1,8246 8	8,0073 8	2,9495 4	3,2986 4	1,7943 7	2,86555	3,27042
GV	4,71268 6	2,1634	2,6264	7,00812	0,00000	6,2258 6	4,4690 7	4,5273 8	3,9094 5	5,8857 1	9,71939	10,0980 9
STR	9,7628 8	7,6102 4	5,1383 4	1,82463	6,22586	0,0000 0	2,3021 7	2,4987 6	2,9305 7	1,7569 7	8,91146	4,54852
MA	7,8597 7	5,7926 2	3,2628 2	3,00732	4,46907	2,3021 7	0,0000 0	1,2872 1	1,5327 1	1,7106 1	5,63346	6,07953
PO	8,1334 4	5,8512 4	3,8227 4	2,94954	4,52738	2,4987 6	1,2872 1	0,0000 0	1,0094 1	1,9776 5	5,57282	5,89414
TU	7,7990 0	5,4228 5	3,4748 5	3,29864	3,90945	2,9305 7	1,5327 1	1,0094 1	0,0000 0	2,3828 5	6,01771	6,34579
SG	9,3997 7	7,2625 9	4,7775 9	1,79437	5,88571	1,7569 7	1,7106 1	1,9776 2	2,3828 5	0,0000 0	4,22164	4,59047
MIA	13,4710 1	11,2198 0	8,7320 0	2,86555	9,71939	3,9114 6	5,6334 6	5,5728 2	6,0177 1	4,2216 4	0,00000	1,18860
MIB	13,8859 5	11,6079 9	9,2097 2	3,27042	10,0980 9	4,5485 2	6,0795 3	5,8941 4	6,3457 9	4,5904 7	1,18860	0,00000

Tab.3.2 Distances' Matrix (stress value 0.01)

3.1.2 Recent Data

Recent data acquired during the project coming from a wide range period (from Mesolithic up to Modern Age) (Tab. 3.3) were treated together to highlight the most important evolutionary trend.

Instead, sample size/and compositions always influence this type of statistical analysis data will be adequate to reach meaningful conclusions.

Site	Key	Historical Periods	Populations
Grotta del Uzzo	△	Mesolithic	Mesolithic Hunter-Gatherers
Marcita	△	Bronze	Indigenous
Stretto Partanna	△	Bronze	Indigenous
Polizzello	□	Bronze/Iron	Indigenous
Baucina	□	Bronze/Iron	Indigenous
Motya	○	Antiquity	Phoenician
Birgi	○	Antiquity	Phoenician
Caserma Tukory	○	Antiquity	Phoenician
Manuzza-Selinunte	○	Antiquity	Phoenician/Greek
Marsala	○	Antiquity	Greek/Roman
Castel San Pietro	◇	Middle Ages	Islamic
Monte Maranfusa	◇	Middle Ages	Norman/Swabian
Alia	+	Contemporary	Contemporary Sicilian

Tab. 3.3 Sample and Key - Dental Metrics

3.1.3 PCA

A preliminary analysis was done on the samples of Mesolithic (Δ), Bronze (Δ), Bronze/Iron (\square), Antiquity (\circ), Middle Ages (\diamond) and Contemporary ($+$).

The results of the Principal Components in (Tab. 3.5a) shows that the first explain the 77, 5% of the variance.

Eigenvalue, with an exception for PC1, decreases gradually that denote that variation is distributed mainly along PC1 and gradually on the other vectors (Fig. 3.3).

PC	Eigenvalue	% variance
1	0,00582845	77,504
2	0,00122759	16,324
3	0,000275585	3,6646
4	0,000107525	1,4298
5	8,10013E-05	1,0771

Tab. 3.4 Percentage of Variance covered by Principal Components of Sicilian Sample – Dental Metrics

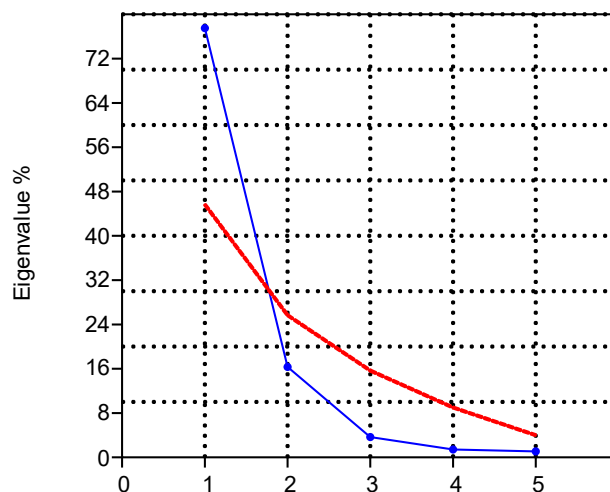

Fig. 3.3 PCA Scree Plot with Broken Stick (in red) – Dental Metrics

As described above only PC1 reduces sharply so is reasonable to guess that PC1 is a good indicator of dental metrics variability.

Before the PCA Scatter-Plot, we present the “Loadings” of PC1 that shows how much each variable contributes to the components (**Fig. 3.4**).

The histogram clearly shows that Mesiodistal diameter (MD) has a major influence compared to the Buccolingual (BL). In particular, P2 and M3 Mesiodistal diameters have the biggest impact.

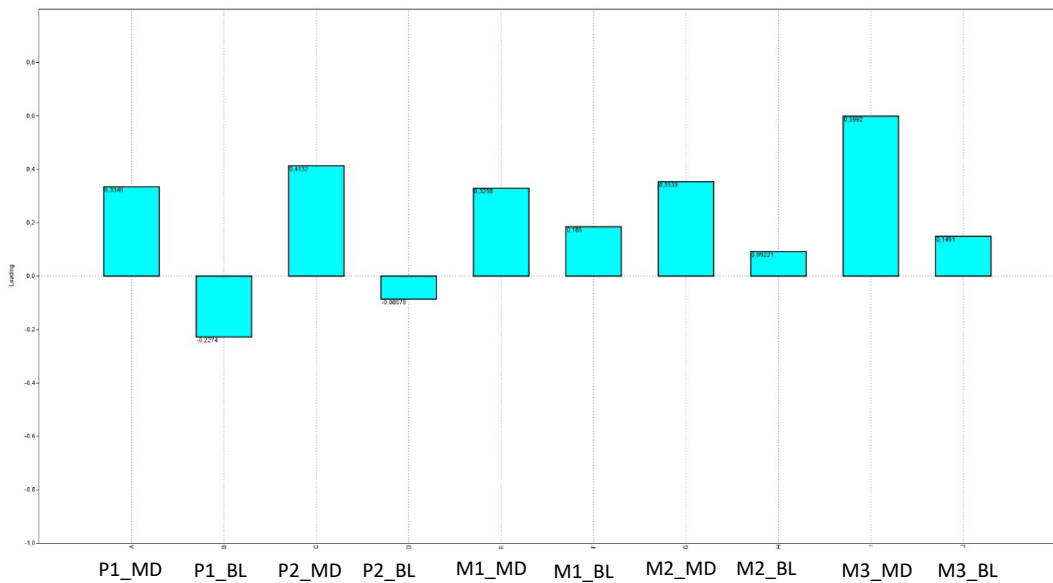

Fig.3.4 Loadings of PC1 – Dental Metrics

As reported by the PC1vsPC2 we again assist to a clear separation between the Contemporary Sample (separated by the PC1 axe) with the other one (**Fig. 3.5a**).

On the opposite side of the graph, we found well-clusterized Mesolithic Hunter-Gatherers specimens showing a low variability.

Meaningful is the period of Bronze and its transition with Iron in which (samples still well clusterized and characterized by low variability) we assist to a clear separation between the others groups done by a probable variation in tooth size and dimension. This variation exactly coincides with the first stable human migrations from the continent and the consequent "Populations Influx".

Not negligible are indeed, the environmental factors of the diet variation that occurred between the Hunter-Gatherers of Mesolithic and the following populations of farmers.

The variability produced is so the combinations of the genetic influence of the first settlers and the diet variation.

The following period of Antiquity (in temporal conjunction with Iron) partially overlap the antecedent but show a huge variability done, without any doubt, by the intense period of colonization carried by Phoenician, Greek and Roman.

Unfortunately, the few specimens belonging at Middle Ages do not allow a significant analysis.

Instead, the PCA does not present a significant dominant pattern along the axes the morpho-space not always showing a concentric organization (homogeneous) suggest a slow degree of morphological differentiations interrupted by a significative event of genetic variability's increase result of the "Human Flow" (**Fig. 3.5a**).

PC1vsPC3 confirm the effect of human migratory flows during Bronze/Iron transition and Antiquity (also highlighting the separation between Contemporary specimens and the other one) on improving the genetic variability (**Fig. 3.6a**).

Furthermore, the slightly increase of the morpho-space concentric organization denotes however a constant slow variation done by the environmental factors (**Fig. 3.6b**).

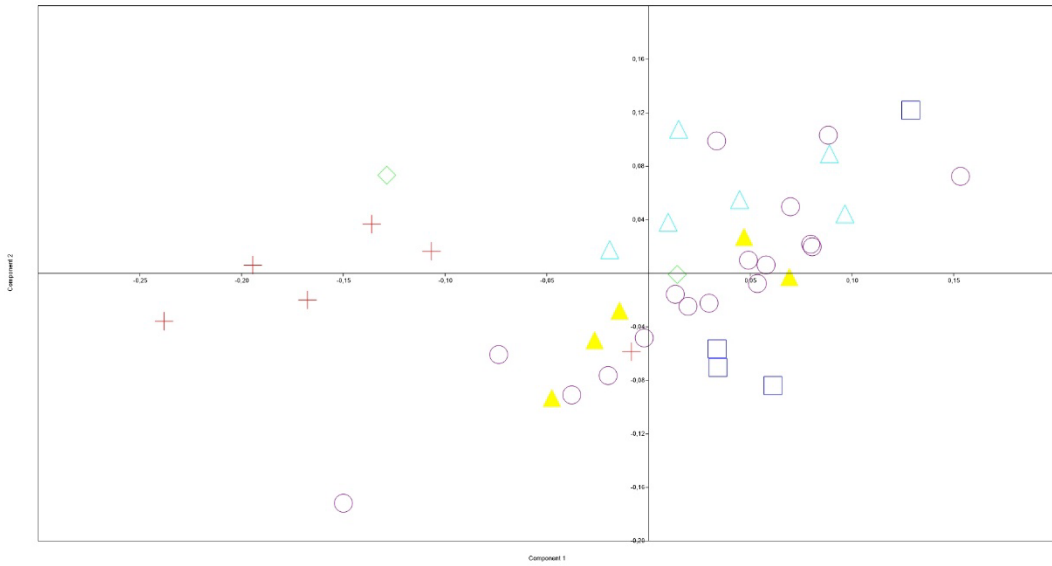

Fig. 3.5a PC1vs PC2 (Log)- Dental Metrics

- ▲ Mesolithic
- ▲ Bronze
- □ Bronze/Iron
- ○ Antiquity
- ◆ Middle Ages
- + Contemporary Age

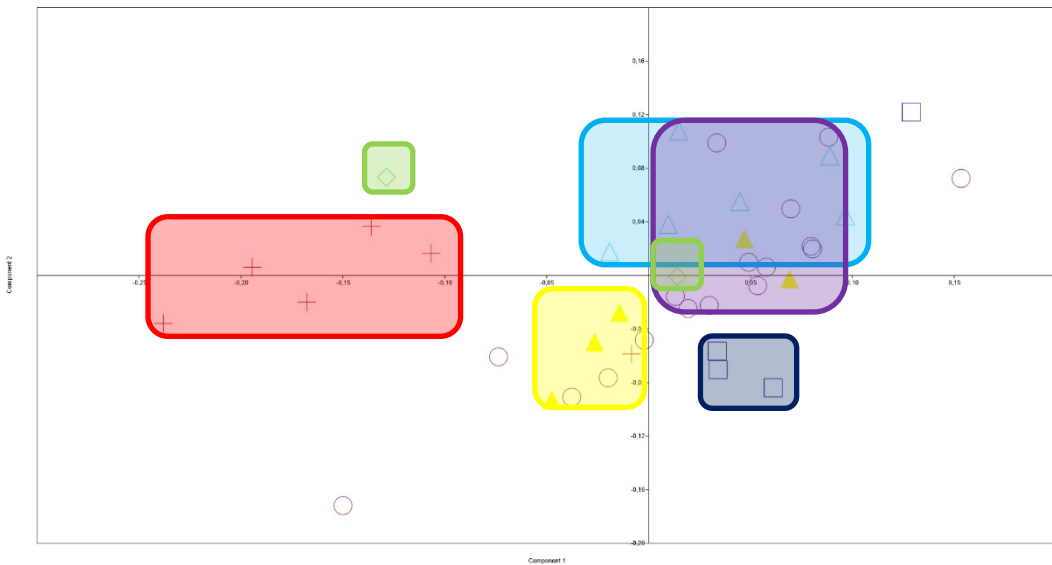

Fig. 3.5b PC1vs PC2 (Log) BoxColor - Dental Metrics

- ▲ Mesolithic
- ▲ Bronze
- □ Bronze/Iron
- ○ Antiquity
- ◆ Middle Ages
- + Contemporary Age

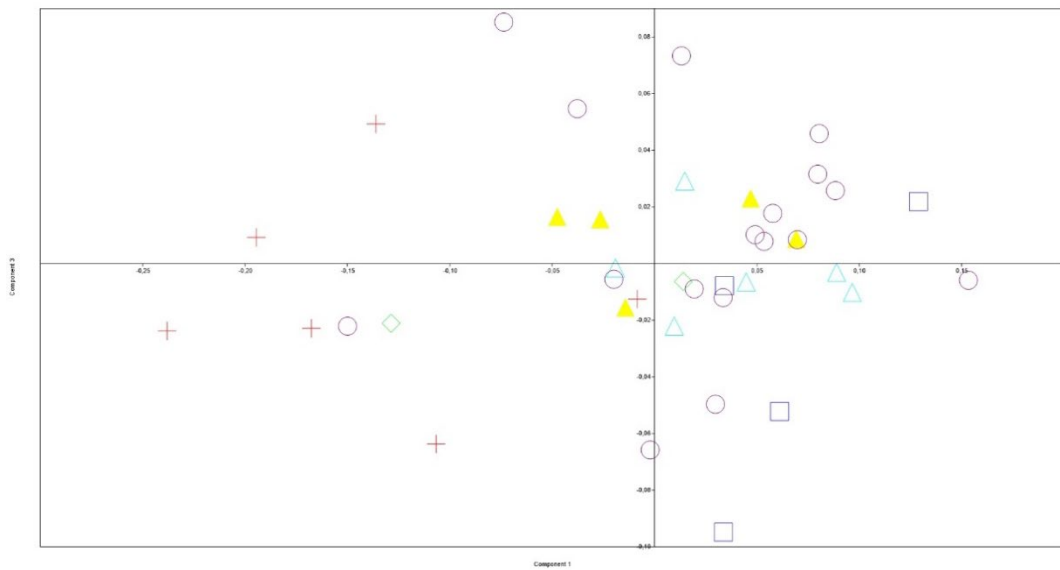

Fig. 3.6a PC1vs PC3 (Log) -Dental Metrics

- ▲ Mesolithic - ▲ Bronze - □ Bronze/Iron - ○ Antiquity
- ◇ Middle Ages - + Contemporary Age

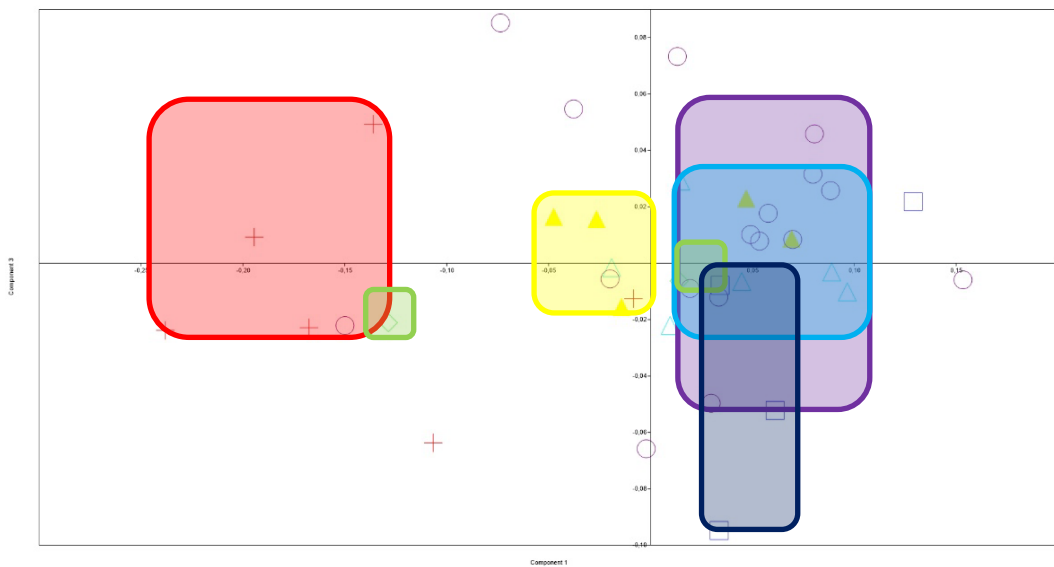

Fig. 3.6 PC1vs PC3 (Log) Box Color - Dental Metrics

- ▲ Mesolithic - ▲ Bronze - □ Bronze/Iron - ○ Antiquity
- ◇ Middle Ages - + Contemporary Age

A second PCA was done processing the average of the specimens for each site, ruling out Marcita, Stretto, Birgi, Castel San Pietro e Maranfusa as a single individual composes them.

As is possible to see quite the 82% of the variability lies along the PC1 that with the PC2 (12%) has the 94% of the total (**Tab. 3.5**), and for this reason will be considered only these two (**Fig. 3.7**).

PC	Eigenvalue	% variance
1	0,007478	81,952
2	0,001092	11,969
3	0,000315	3,4548
4	0,00024	2,625

Tab. 3.5 Percentage of Variance covered by Principal Components of Sicilian Sample – Dental Metrics

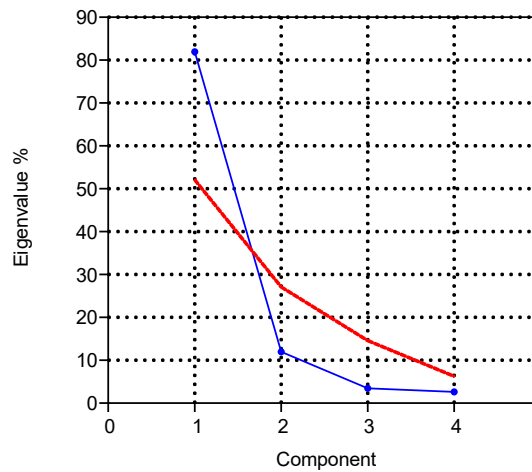

Fig. 3.7 PCA Scree Plot with Broken Stick (in red) – Dental Metrics

The following discussion, talk of the PCA done by each site but before we have to consider that especially in this case simple size/compositions could influence the analysis.

In spite of this is important to notice that the Mesolithic specimens of Uzzo (1) are found separated from the others, especially distant from the Bronze and Bronze/Iron (4) (Baucina) one that instead lies quite close to each other but separated by the PC1 axe.

Very interesting is also the situations of Antiquity's site (almost all on the negative side of PC1). Among these, we found the oldest settlement of the Phoenician of Mozia (7) close to the indigenous of Marcita (2) (Bronze Age) and distant from the Phoenician of Caserma Tukory (6). On the contrary the last two Antiquities settlements of Manuzza-Selinunte (5) (Phoenician/Greek) and Marsala (4) (Greek/Roman) near to each other, highlighting the strong influence carried by the Greek colonization (**Fig. 3.8**).

As expected the Contemporary (8) (Alia) specimens take place separated from the other latter groups.

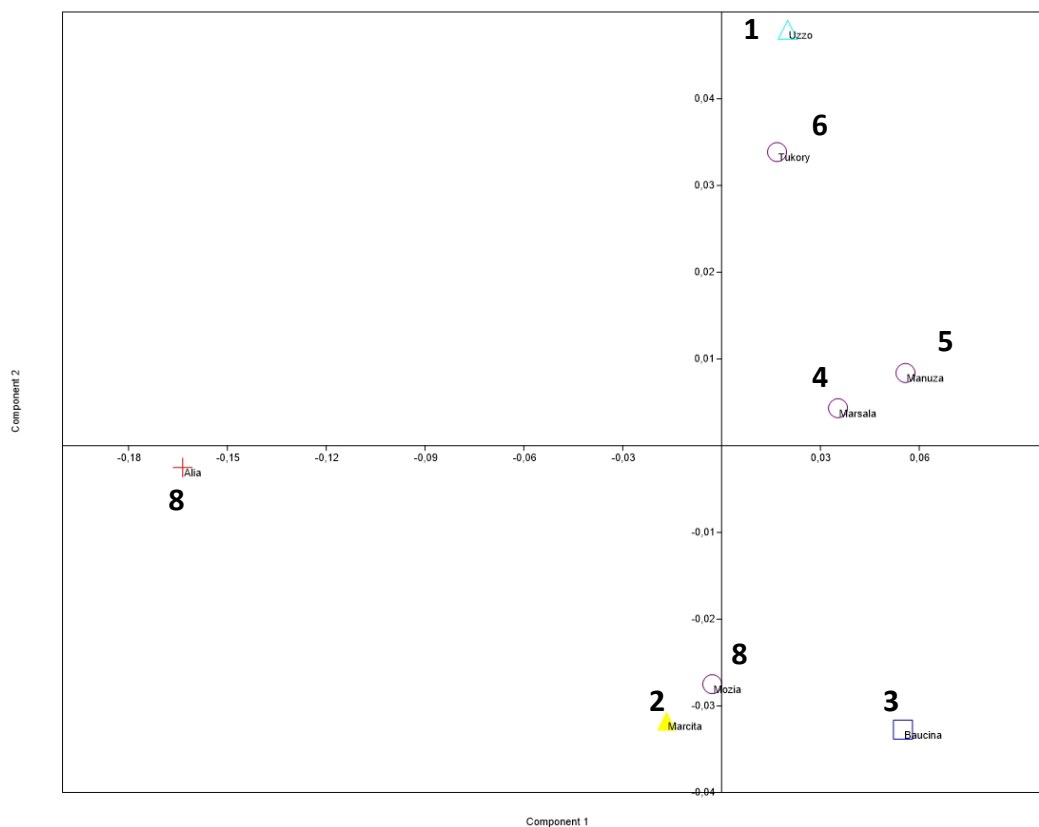

Fig. 3.8 PC1vs PC2 (Log)- Dental Metrics

- ▲ Mesolithic - ▲ Bronze - □ Bronze/Iron - ○ Antiquity + Contemporary Age
- **1** Uzzo (CU)
- **2** Marcita (MA)
- **3** Baucina (BA)
- **4** Marsala (MAR)
- **5** Manuzza-Selinunte (MAS)
- **6** Caserma Tukory (TU)
- **7** Mozia (MO)
- **8** Alia (AL)

3.1.4 MANOVA/CVA and MDS

Despite the restricted number of specimens (for each group), a MANOVA/CVA and an MDS analysis were computed to compare the result with the pattern obtained with the PCA.

Remembering that MANOVA/CVA is used for description among groups and that MDS graphically show the differences or similarities between elements of a dataset and the strong similarity between this two type of analysis and the PCA confirm the assumption done before:

- Mesolithic Hunter-Gathered shows the lowest variability among the group and clusterized close altogether (**Fig.3.9a**) (always condering sample size/compition).
- Bronze and Bronze/Iron transition characterized by first human migration and instead keep a low variability among the group produced the first significantive increase in genetic variability (**Fig.3.9b**).
- Antiquity undergoes an intense colonial period by Phoenician, Greek and Roman that result in a huge increase of variability (**Fig.3.10a**).
- Contemporary constitute a separate group (**Fig.3.10b**).
- The organization of the morpho-space suggest two different patterns of evolution, one fast and punctual borne by human flow and another slow borne by environmental factors.

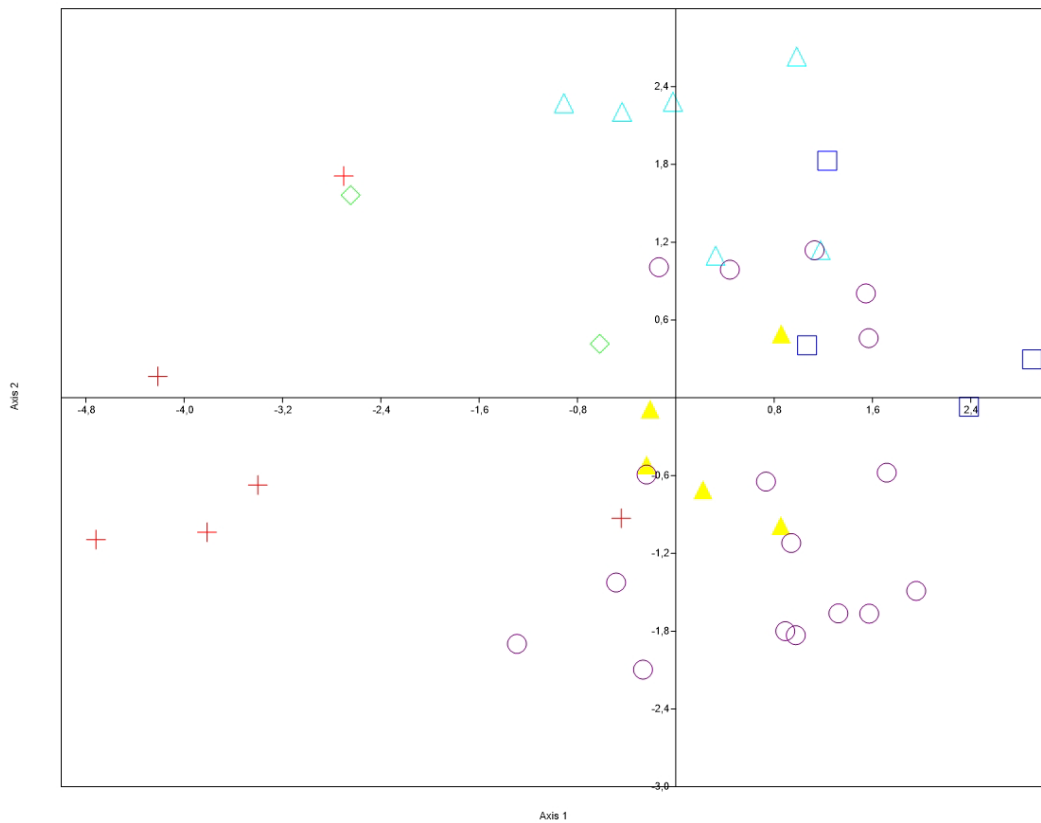

Fig. 3.9a MANOVA/CVA - Dental Metrics

- ▲ Mesolithic
- ▲ Bronze
- □ Bronze/Iron
- ○ Antiquity
- ◆ Middle Ages
- + Contemporary Age

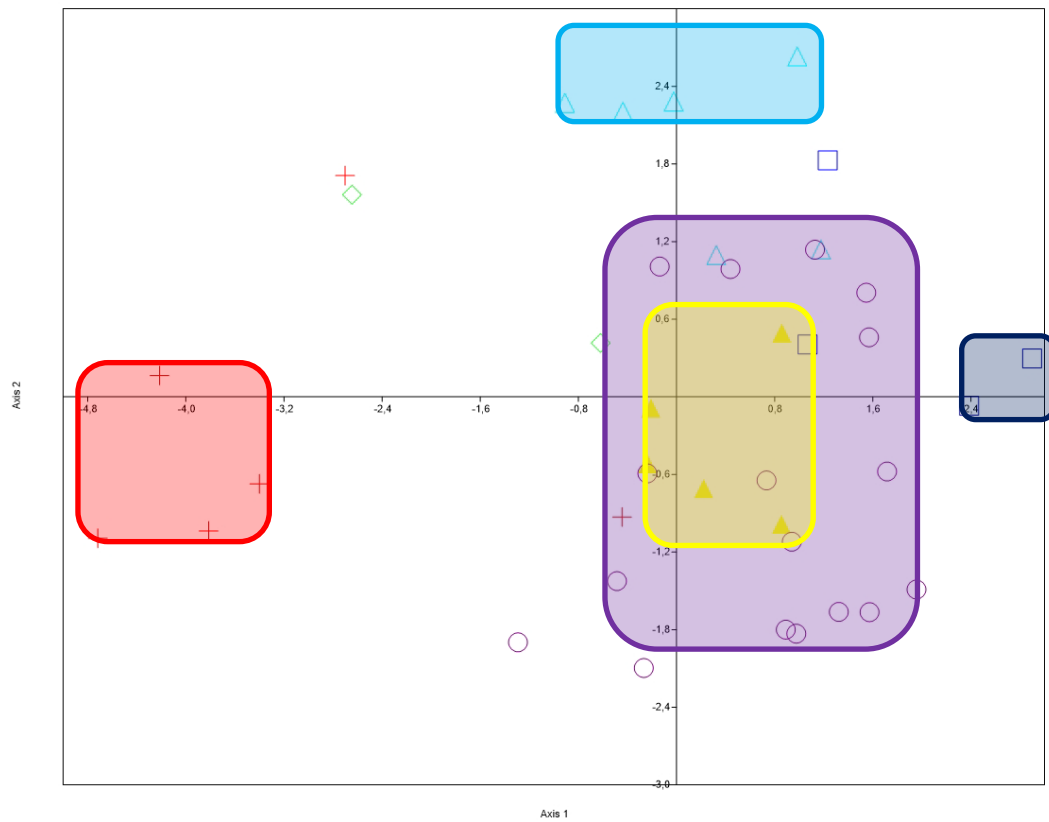

Fig. 3.9b MANOVA/CVA Box Color - Dental Metrics

- ▲ Mesolithic
- ▲ Bronze
- □ Bronze/Iron
- ○ Antiquity
- ◆ Middle Ages
- + Contemporary Age

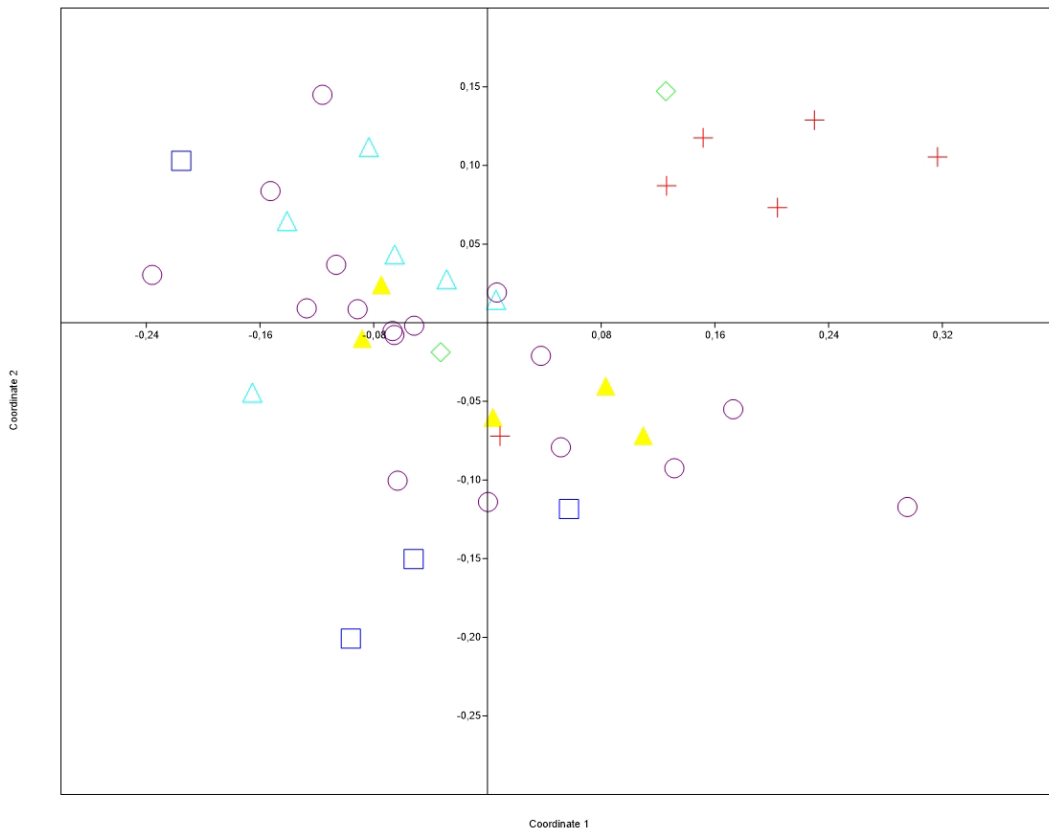

Fig. 3.10a MDS - Dental Metrcs

- ▲ Mesolithic
- ▲ Bronze
- □ Bronze/Iron
- ○ Antiquity
- ◆ Middle Ages
- + Contemporary Age

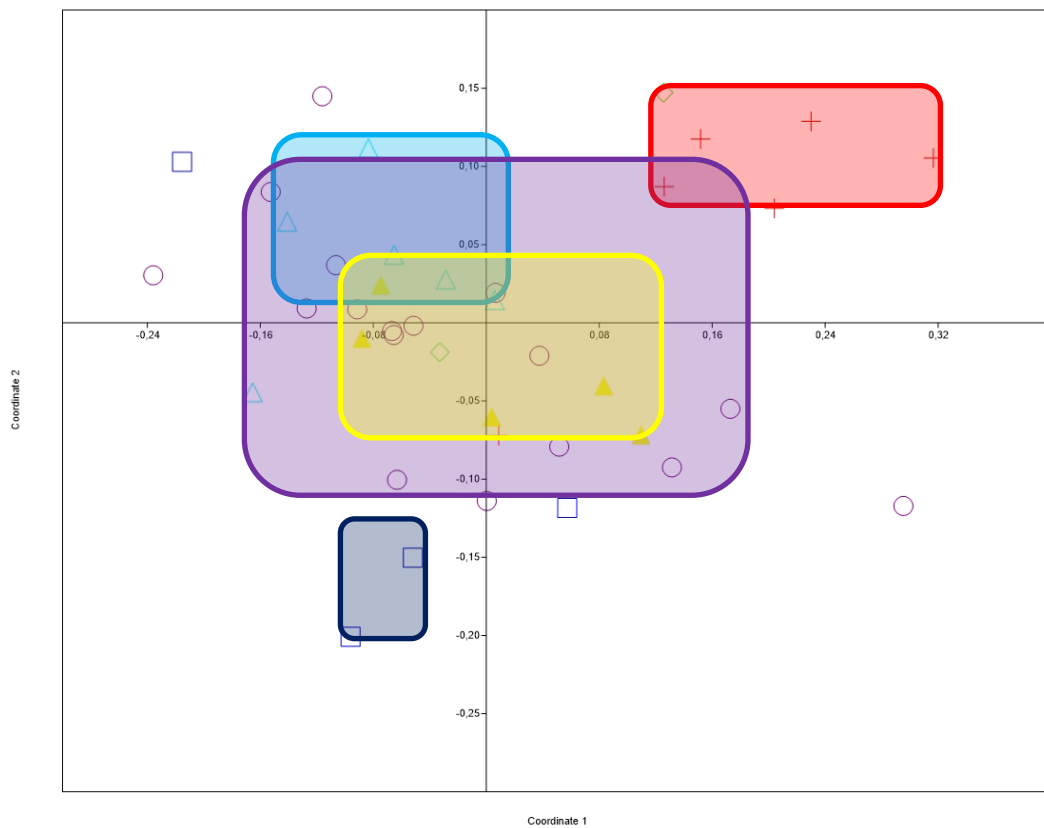

Fig. 3.10b MDS Box Color -Dental Metrcs

- ▲ Mesolithic
- ▲ Bronze
- □ Bronze/Iron
- ○ Antiquity
- ◆ Middle Ages
- + Contemporary Age

3.1.5 Neighbour Joining

The Neighbor-Joining tree (Fig.3.11) clearly shows the Mesolithic specimens are Outgroup of the all-later groups. As expected Bronze/Iron transition, presents affinities with Antiquity and both are relatively close with the previous specimens of Iron. In spite of they came directly from the root of Mesolithic they result closer to Middle Ages and Contemporary.

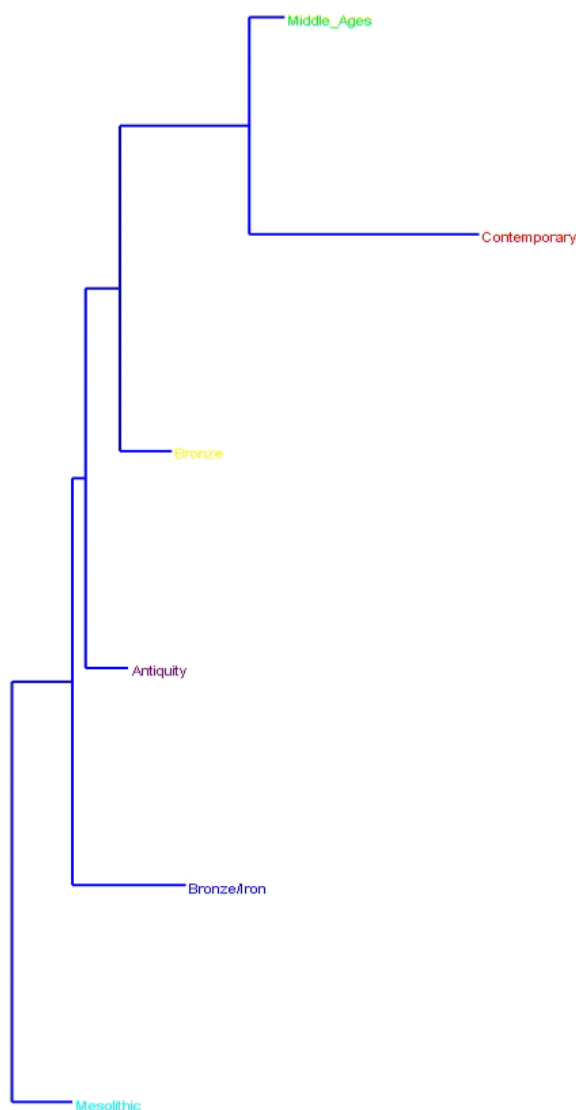

Fig. 3.11 Dental Metrics Neighbour-Joining hierarchical tree representing the historical divergence among populations through the century

In conclusion instead (as said before) the sample size/composition influence the Plot is clear that the first not negligible “Populations Influx” began during Iron Age.

Is also clear that a second important moment marks the transition Bronze/Iron up to an extremely dynamic and varied context such as the Antiquity.

3.2 Geometric Morphometrics

The second analysis among the Sicilian populations was done applying modern techniques of Geometric Morphometrics to landmarks 3D spatial coordinates.

Always Prehistorical samples were compared with Protohistoric and Historical samples.

Data collected on (Tab. 3.6) comes from landmark's database:

Site	Key	Historical Periods	Populations
Grotta di San Teodoro	●	Upper Paleolithic	Würm-Settlers
Grotta del Uzzo	△	Mesolithic	Mesolithic Hunter-Gatherers
Grotta della Molara	△	Mesolithic	Mesolithic Hunter-Gatherers
Marcita	△	Bronze	Indigenous
Polizzello	□	Bronze/Iron	Indigenous
Baucina	□	Bronze/Iron	Indigenous
Motya	○	Antiquity	Phoenician
Birgi	○	Antiquity	Phoenician
Caserna Tukory	○	Antiquity	Phoenician
Phoenician of Palermo	○	Antiquity	Phoenician
Lilibeo	○	Antiquity	Phoenician
Marsala	○	Antiquity	Greek/Roman
Lipari	○	Antiquity	Greek
Agrigento	■	Late Antiquity	Indigenous
Castel San Pietro	◇	Middle Ages	Islamic
Monte Iato-Position(B)	◇	Middle Ages	Norman/Swabian
Caltavuturo	◇	Middle Ages	Mixed
Alia	+	Contemporary	Contemporary Sicilian
Rotoli	+	Contemporary	Contemporary Sicilian

Tab 3.6 Sampled Sicilian Site and Key for the Geometric Morphometrics Section

3.2.1 Craniofacial Geometric Morphometrics in Sicily

Considering the different type of wireframe generated (ShapeChange, StandardWireframe and Soft-Wireframe) by the PCA, differences in facial shapes show:

- A decrease of Maxilla Prognathism.
- A Mesocephalization of the cranial vault.

Dolichocephaly that characterized prehistoric populations of northern Europe (like British and Scandinavians), southern Europe (like the southern Iberian Peninsula and southern Italy) and the Mediterranean island as Sardinia, Corsica and Sicily changed in direction to a progressive Mesocephalization during Mesolithic.

Lollipop Graph (**Fig.3.12**) show the variance of landmarks above the skull.

In this case, quite all of the variability is located on:

- Prosthion (Landmarks 1).
- Front points of Canine's Alveolus (Landmarks 7 and 8) with all landmarks placed on the superior jaw that moves back inwards.
- Stephanion (Landmarks 25 and 26) that instead move forward.
- Asterion (Landmarks 23 and 24) and Lambda (Landmark 6) also move forward.

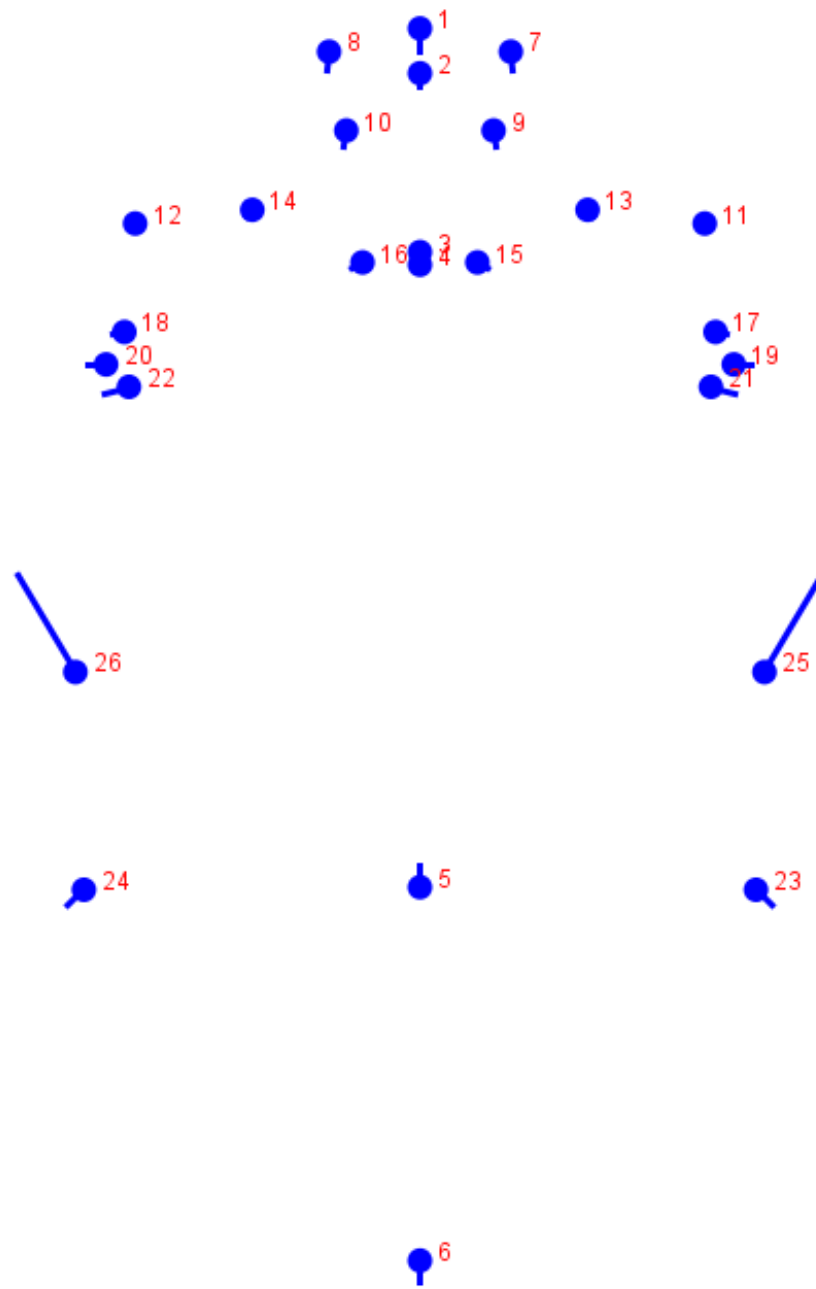

Fig. 3.12 PC1 ShapeChange (or Lollipop Graph) showing the Mesocephalization of Sicilian skulls

Wireframe and Soft-Wireframe Graphs (**Fig.3.13a-b**) provide a complete image of the skull on which is possible to see a decrease of the Maxilla Prognathism and a soft Mesocephalization with the skull that becomes tighter and slightly and less elongated.

Faces become wider and shorter (**Fig.13c-d**).

Nasal bones and maxilla vertically shorted decreasing the prognathism.

Maxillary prognathism (never extremely severe) correspond to Mesolithic specimens that had a lengthy and more robust skull compared with wider and smaller of modern.

Frontal and Occipital become slightly wider, keeping quite the same size but increasing the shape while the Parietals are instead, affected by the major changes rising wider size and shape (**Fig.13e-f**).

The whole structure gets shorter in the anterior parts (nasal aperture and maxilla) and taller on the superior.

In summary, the face lengthens decrease and skull become taller and wider.

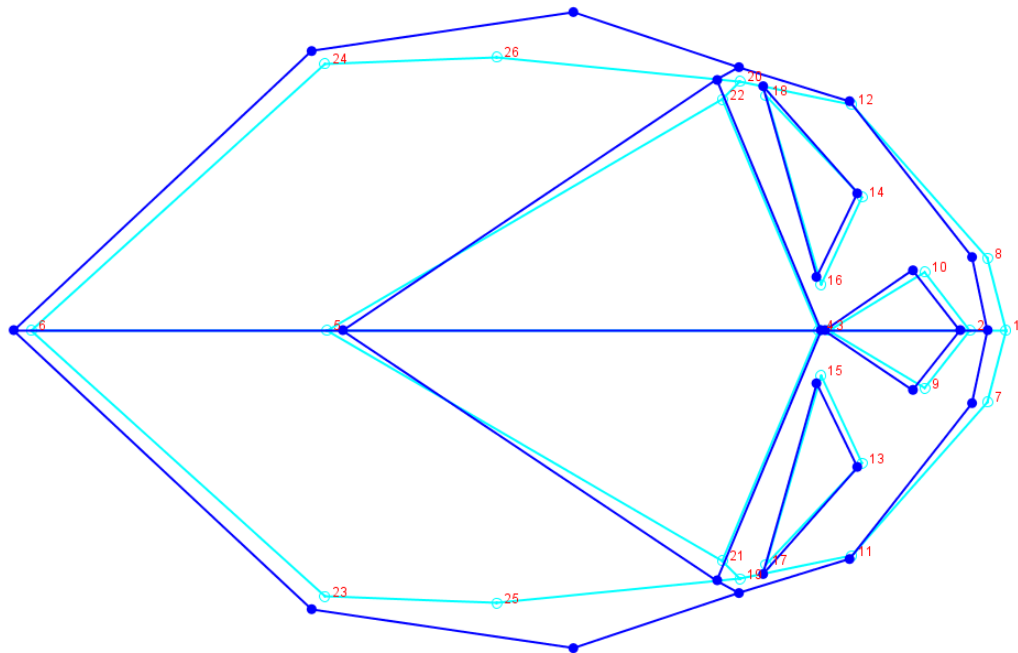

Fig. 3.13a PC1 Wireframe of Superior View showing the Mesophalization of Sicilian skulls

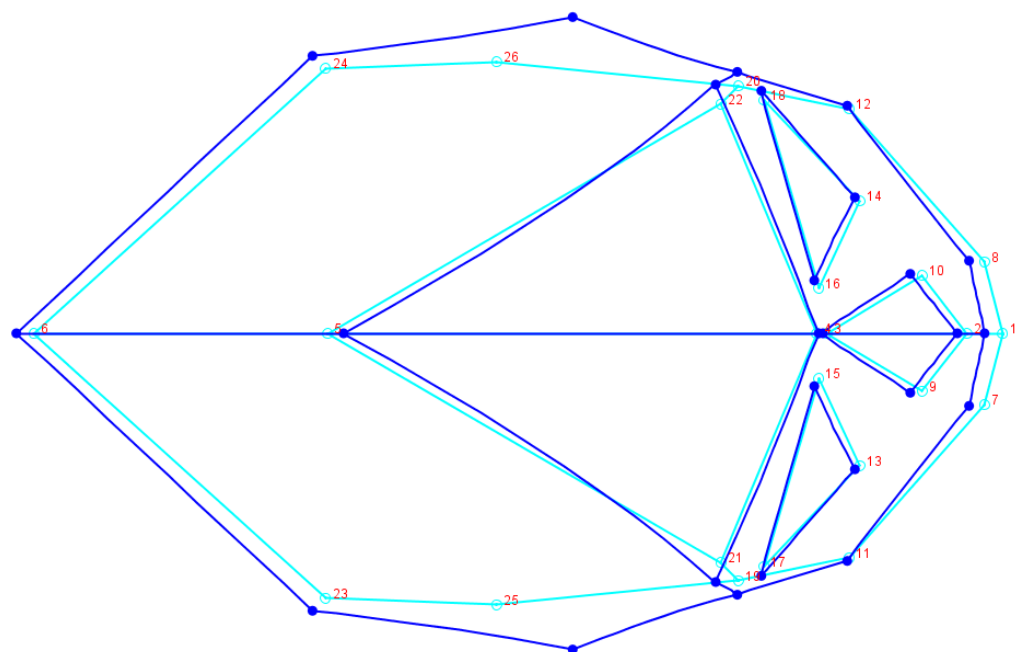

Fig. 3.13b PC1 Soft-Wireframe of Superior View showing the Mesophalization of Sicilian skulls

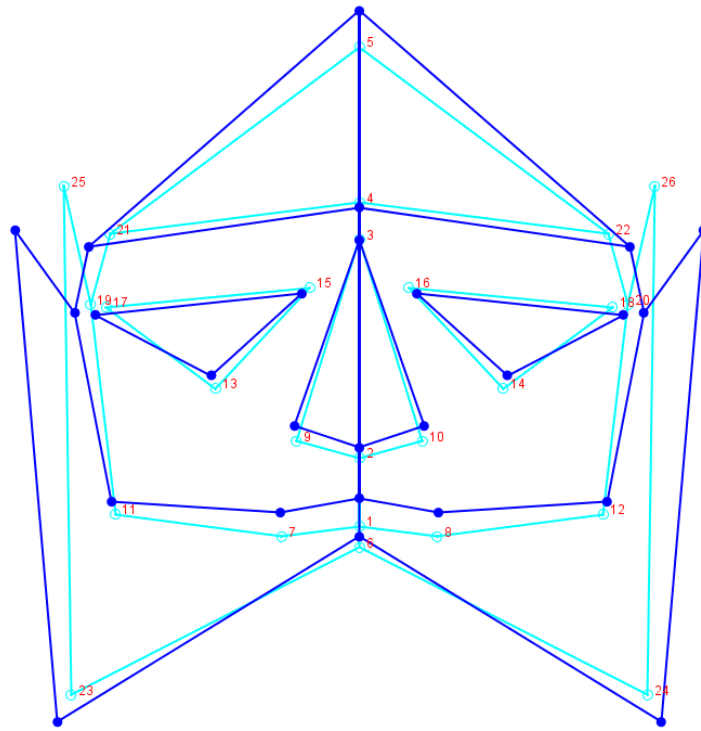

Fig. 3.13c PC1 Wireframe of Anterior View showing the Mesopthalization of Sicilian skulls

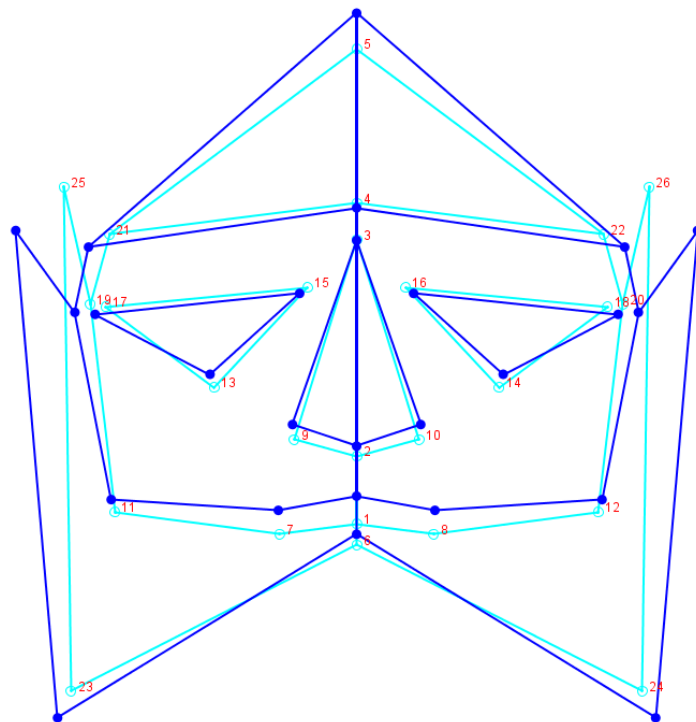

Fig. 3.13d PC1 Soft-Wireframe of Anterior View showing the Mesopthalization of Sicilian skulls

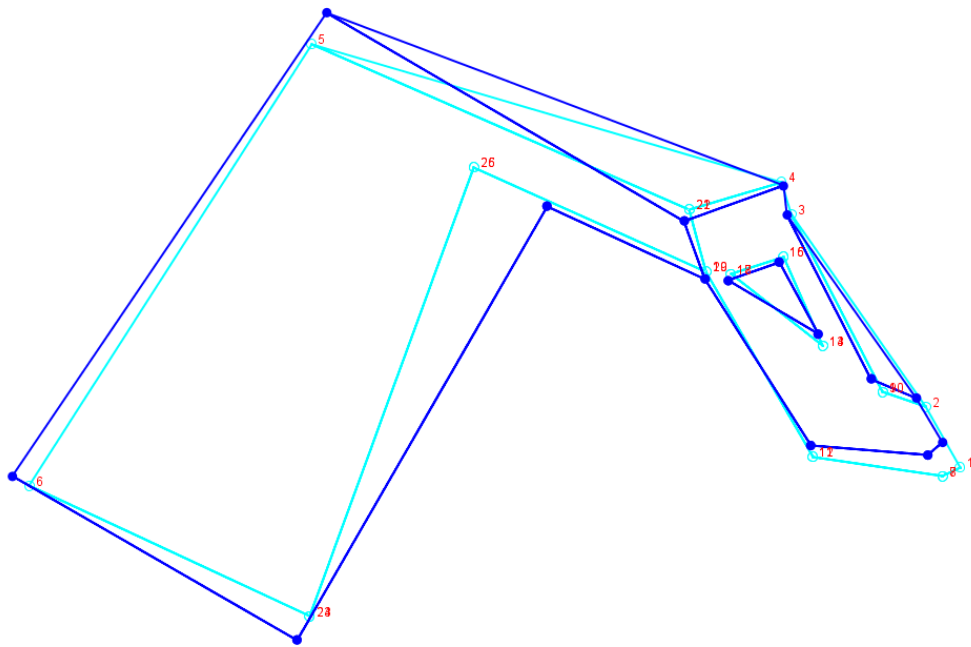

Fig. 3.13e PC1 Wireframe of Lateral View showing the Dolichocephaly of Sicilian skulls

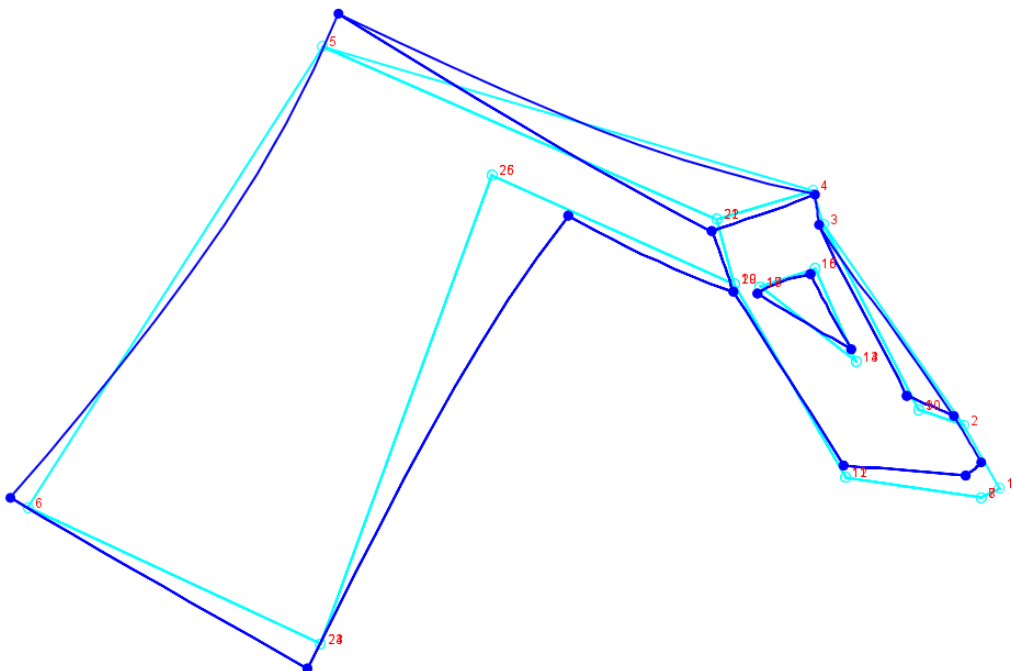

Fig. 3.13f PC1 Soft-Wireframe of Lateral View showing the Mesophalization of Sicilian skulls

3.2.2 PCA

A Geometric Morphometrics Analysis was continued by performing a PCA Analysis (PC1vsPC2 and PC1vsPC3). The following graphs show the PCA carried on the Procrustes Coordinates of the landmarks of Sicilian Populations.

In spite of sample size/composition influx this data will produce tenable results also, in this case, they moreover reinforce the previous conclusions.

PC and Eigenvalue distributed among all the components decreases gradually over the PC axes only after PC4 (**Tab. 3.7**) (after PC4 they halved on each component).

This trend denotes only significative variations enclosed among the components of the Prehistorical specimens. The scree plot shows how only the first three PC could be considered significant (**Fig. 3.14**). For that, reason will be only evaluated PC1, PC2 and PC3.

PC	Eigenvalue	% variance
1	5,83296	38,684
2	3,48157	23,09
3	2,74128	18,18
4	1,61966	10,742
5	0,794896	5,2717
6	0,411794	2,731
7	0,196328	1,302

Tab. 3.7 Percentage of Variance covered by Principal Components of Sicilian Sample

Geometric Morphometrics

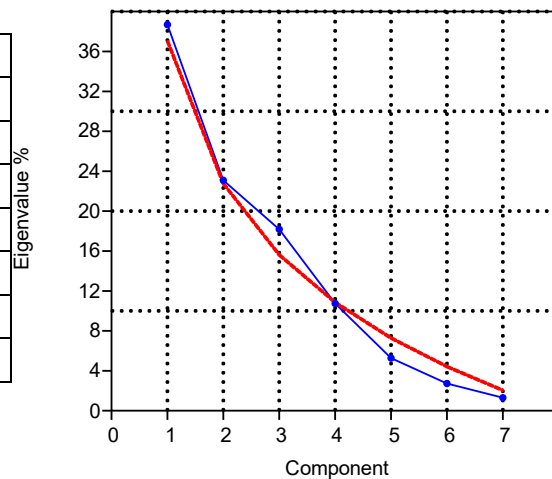

Fig. 3.14 PCA Scree Plot with Broken Stick (in red) - Sicilian Sample

Geometric Morphometrics

Suddenly appear clear the separation between the Würm-Settlers of San Teodoro (●) and Hunter-Gathered of Mesolithic (△). In turn, not negligible differences in average differentiate Mesolithic from all the other groups.

Despite this, Würm-Settlers of San Teodoro preserve a surprising similarity with Contemporary (+), probably due to sizes/sample composition and that, some modern skulls of extreme form still kept archaic characters. ([Relethford & Smith 2018](#)).

As predicted, in the odontological section, significative differences in shape are detected during Bronze Age (△) and Bronze/Iron transition (□) evidence of the important contribute produced by human flows to genetic variability.

The “Population Continuity” is clearly visible during Antiquity (○) and Middle Ages (◇) that both shows a large variation along all the four axes (with a progressive increase of variability). Apart from the increase of specimens available for the historical groups, the mentioned period get the contribution of Phoenician, Greek, Roman, Byzantine, Islamic and Norman/Swabian dominations. Important is that settlers, separately, had already produced a huge heterogeneity without modern dispersal patterns (**Fig.15a-b**).

Not negligible is already the geography and history of the island which, being located in the centre of the Mediterranean, was (for millennia) a meeting place for commercial exchanges between many cultures and huge empires.

Especially the role of the Maritime Hub covered during this colonization played an important role in the morphological characterization.

For that reason, we have to remember, that many of these groups (coming from different geographical areas) that we formally call populations, in turn, were composed by many cultures (with their own genetic pool).

The two specimens of Late Antiquity (■) do not allow to draw a definite conclusion but it is surely not casual their positions among Antiquity and Middle Ages specimens.

Contemporary as expected presented a wide heterogeneity, mainly placed on the right side of PC1 axis, mainly due to the genetic inheritance left by settlers and enriched by the modern dynamic of populations (**Fig.15a-b**).

Instead, the undoubted contribution of environmental factors to genetic variability (interrupted but in general very slow) the not always homogeneous layout of the morphospace suggest a discontinuous contribution of the “Populations Influx” during Prehistory. While after Iron Age, a constant contribution was carried by the intense phase of colonization.

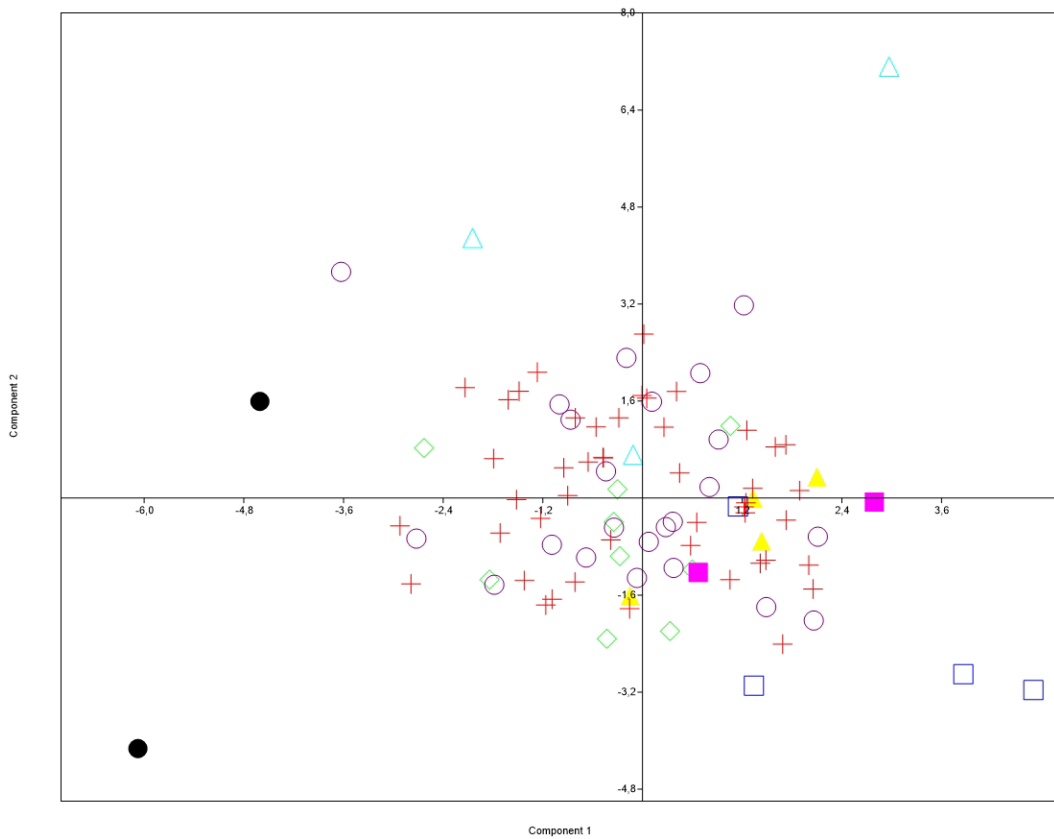

Fig. 3.15a PC1vs PC2 - Geometric Morphometrics of Sicilian

- ● Paleolithic
- ▲ Mesolithic
- ▲ Bronze
- □ Bronze/Iron
- ○ Antiquity
- ■ Late Antiquity
- ◇ Middle Ages
- + Contemporary Age

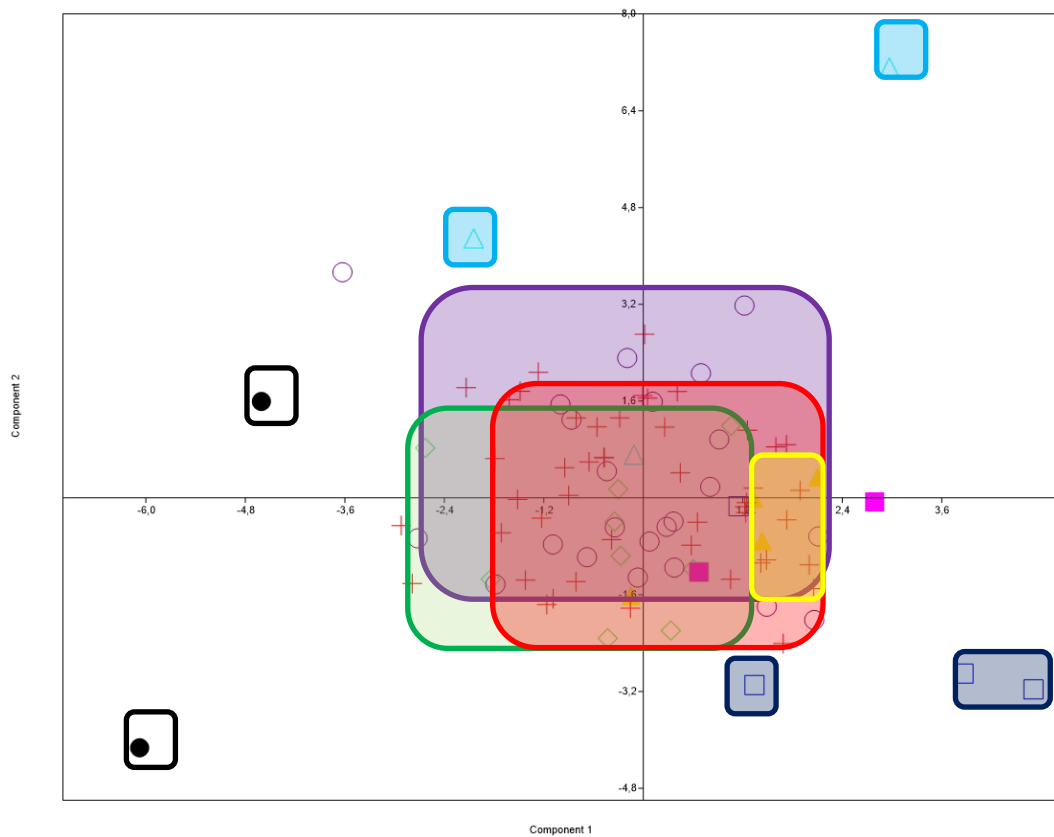

Fig. 3.15b PC1vs PC2 Box Color – Geometric Morphometrics of Sicilian.

- ● Paleolithic
- ▲ Mesolithic
- ▲ Bronze
- □ Bronze/Iron
- ○ Antiquity
- ■ Late Antiquity
- ◇ Middle Ages
- + Contemporary Age

The following analysis PC1vsPC3 support the predictions mentioned in the previous paragraphs (**Fig.16a-b**).

To avoid being redundant result will be summarized to clarify the huge variability found:

- 1- Würm-Settlers of SanTeodoro clusterized separate from the other Prehistoric specimens.
- 2- In the same way, Hunter-Gathered of Mesolithic clusterized as a separate group.
- 3- Bronze and Bronze/Iron transition “Population Influx” produced the first meaningful step on genetic variability in Sicily.
- 4- The colonization, cohabitation and transition during Antiquity, Late Antiquity and Middle Ages increase the variability and strongly influenced skull morphology.
- 5- The increase of variability was linked with a general decrease in size and robusticity.
- 6- The huge variability found on Contemporary is the result of human flows, environmental factors and modern dispersal patterns.

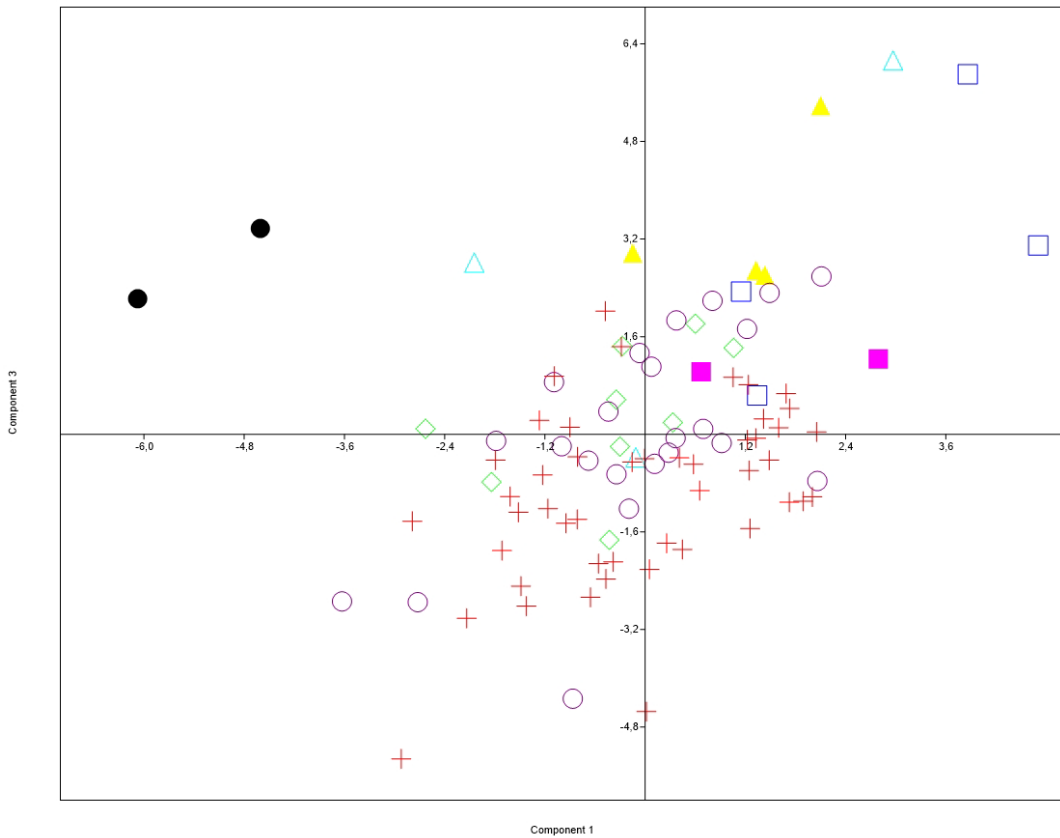

Fig. 3.16a PC1vs PC3 - Geometric Morphometrics of Sicilian

- ● Paleolithic - ▲ Mesolithic - ▲ Bronze - □ Bronze/Iron.
- ○ Antiquity - ■ Late Antiquity - ◇ Middle Ages - + Contemporary Age

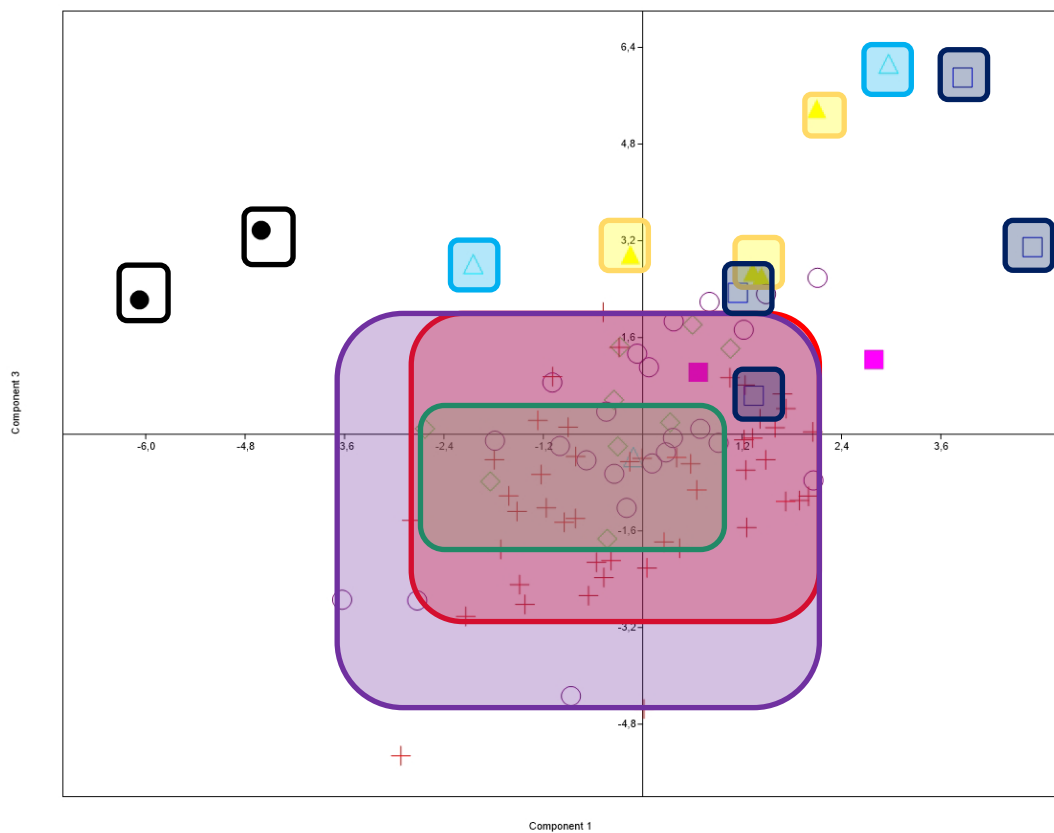

Fig. 3.16b PC1vs PC3 Box Color – Geometric Morphometrics of Sicilian

- ● Paleolithic - ▲ Mesolithic - ▲ Bronze - □ Bronze/Iron
- ○ Antiquity. - ■ Late Antiquity - ◇ Middle Ages - + Contemporary Age

Like the previous section the PCA analysis was completed by carrying out the averages of each site (**Tab.3.8**), (the cave of Molarà represented by a unique specimen was excluded).

As the previous PCA Eigenvalue and PC' values decrease gradually over the PC axes only after PC4 (**Tab. 3.9**)

This trend denotes an important variation enclosed among the first three Components with the scree Plot that shows how only the first two PC could be considered significant with the third borderline (Fig. 3.17).

For that, reason will be only evaluated PC1 and PC2.

PC	Eigenvalue	% variance
1	9,1277	43,31
2	6,36494	30,201
3	3,37366	16,008
4	1,05868	5,0233
5	0,904365	4,2911
6	0,24614	1,1679

Tab. 3.9 Percentage of Variance covered by Principal Components of Sicilian Sample

Geometric Morphometrics

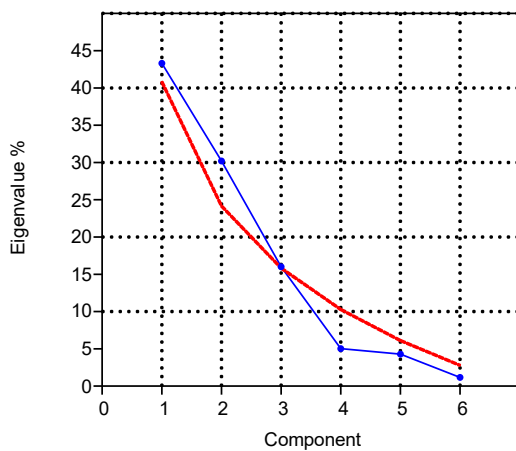

Fig. 3.17 PCA Scree Plot with Broken Stick (in red) - Sicilian Sample

Geometric Morphometrics

The ScatterPlot below mark the separations between the Hunter-Gathered of San Teodoro (1) and Uzzo (2) (in turn separated between themselves) and the other groups Marcita (3) (Iron Age), Polizzello (4) and Baucina (5) (Bronze/Iron transition) lie separated from the other Historical groups of Antiquity (7-11), Middle Ages (12-14) and Contemporary (15-16).

Among the Phoenicians to notice is that the specimens coming from Palermo, (Phoenician of Palermo (8) and Caserma Tukory (10)) lies close to each other with the group of Lilibeo (9) in turn separated from Birgi (7) (Phoenician/Greek) and Mozia (6) coming from the same area.

The positions of Birgi and Lipari (Greek/Roman) again underline the strong influence of Greek colonizations and the high degree of variability already reached during these periods.

In the end, the Middle Ages of Caltavuturo (13), Castel San Pietro (12) and Monte Iato B (14) display a huge variability done by more or less influence carried by Indigenous, Byzantine and Islamic.

Contrariwise, the Contemporary of Alia (15) (18th Century) and Rotoli (16) (21st Century) took place close to each other evidence that already modern dispersal pattern had already produced the current skull morphology (Fig. 3.18).

Instead, the sample size/compositions still influence this type of statistic the complex, miscellaneous and dynamical “Populations Influx” on the Sicilian scenario will be clarified and discussed in detail on the following paragraphs (3.2.5 – 2.2.7).

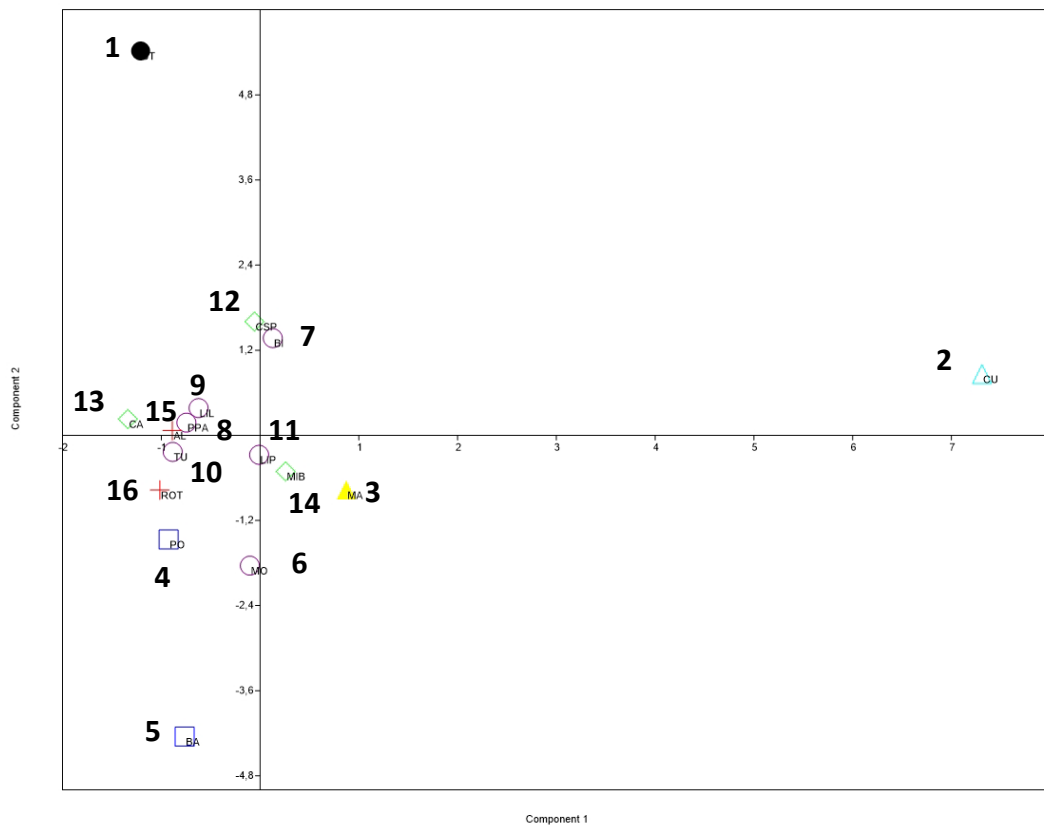

Fig. 3.15a PC1vs PC2 - Geometric Morphometrics of Sicilian

- ● Paleolithic - ▲ Mesolithic. - ▲ Bronze - □ Bronze/Iron
- ○ Antiquity - ■ Late Antiquity - ◆ Middle Ages - + Contemporary Age
- 1 San Teodoro (ST)
- 2 Grotta dell'Uzzo (CU)
- 3 Marcita (MA)
- 4 Polizzello (PO)
- 5 Baucina (BA)
- 6 Mozia (MO)
- 7 Birgi (BI)
- 8 Phoenician of Palermo (PPA)
- 9 Lilibeo (LIL)
- 10 Caserma Tukory (TU)
- 11 Lipari (LIL)
- 12 Sastel San Pietro (CSP)
- 13 Caltavuturo (CA)
- 14 Monte Iato B (MIB)
- 15 Alia (AL)
- 16 Rotoli (ROT)

3.2.3 MANOVA/CVA

Considering the restricted number of specimens (for each group) and the landmarks set MANOVA/CVA could not be significative, (we must consider that a limited number of specimens was matched with a large number of variables). Despite this MANOVA/CVA was carried to compare the result with the pattern obtained with the PCA.

Suddenly appear the peculiar the position of the two Paleolithic Würm-Settlers specimens separated and all the others (**Fig.14a**).

This confirms the previous studies and the theories about the first human peopling during Upper-Paleolithic who has seen in the Würm-Settlers of San Teodoro first humans entered Sicily and etabilishing a permanent settlement.

In fact, San Teodoro craniofacial morphometry presents more a closest similarity with other Western European and Southern-Central Italy Upper-Palaeolithic groups that the other Sicilian one ([0](#)).

These results might suggest that previous colonization of Sicily was carried by hunter-gatherer populations (with low density) sustained by continuous flow from the continent ([D'Amore et. al 2009](#)).

Appear also clear the separation between the main historical periods with the Mesolithic still characterized by robusticity and less variability and the following steps brought by the human flow and colonization during Bronze, Bronze/Iron, Antiquity and Middle Ages with the last one close to Contemporary on the right side of PC1 axe separated by the PC2 axe (**Fig.14b**).

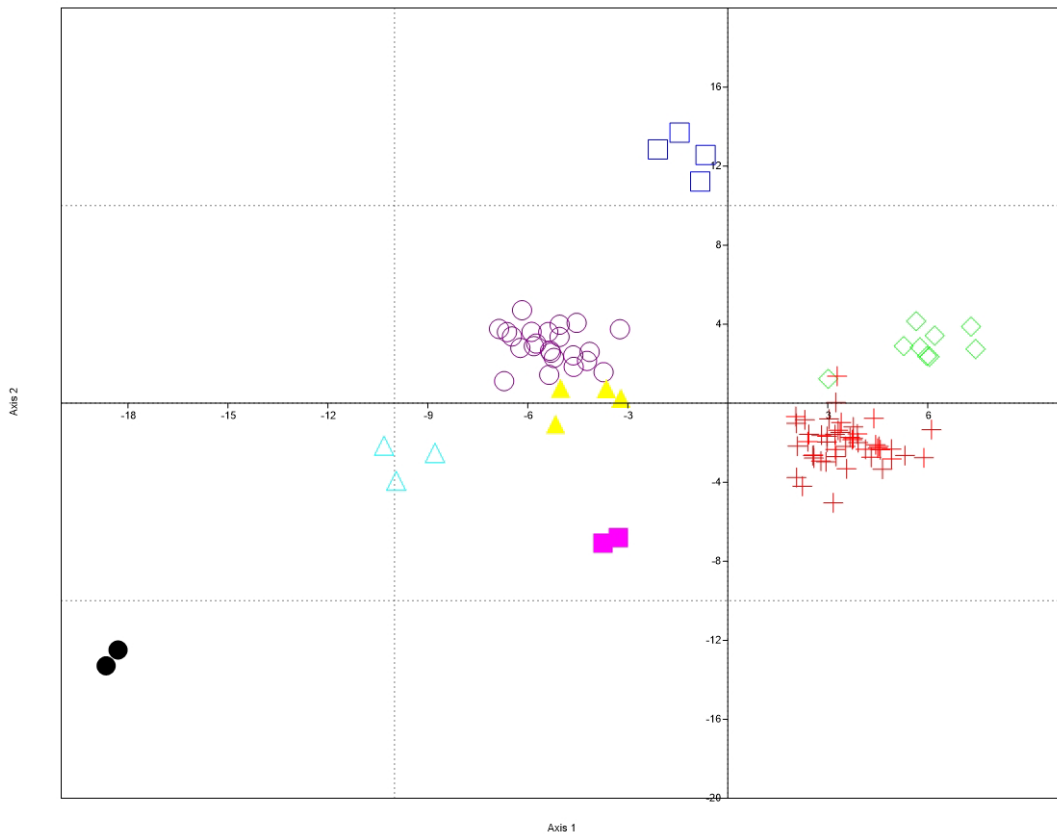

Fig. 3.14a MANOVA/CVA – Geometric Morphometrics of Sicilian.

- ● Paleolithic - ▲ Mesolithic - ▲ Bronze - □ Bronze/Iron
- ○ Antiquity - ■ Late Antiquity - ◇ Middle Ages - + Contemporary Age

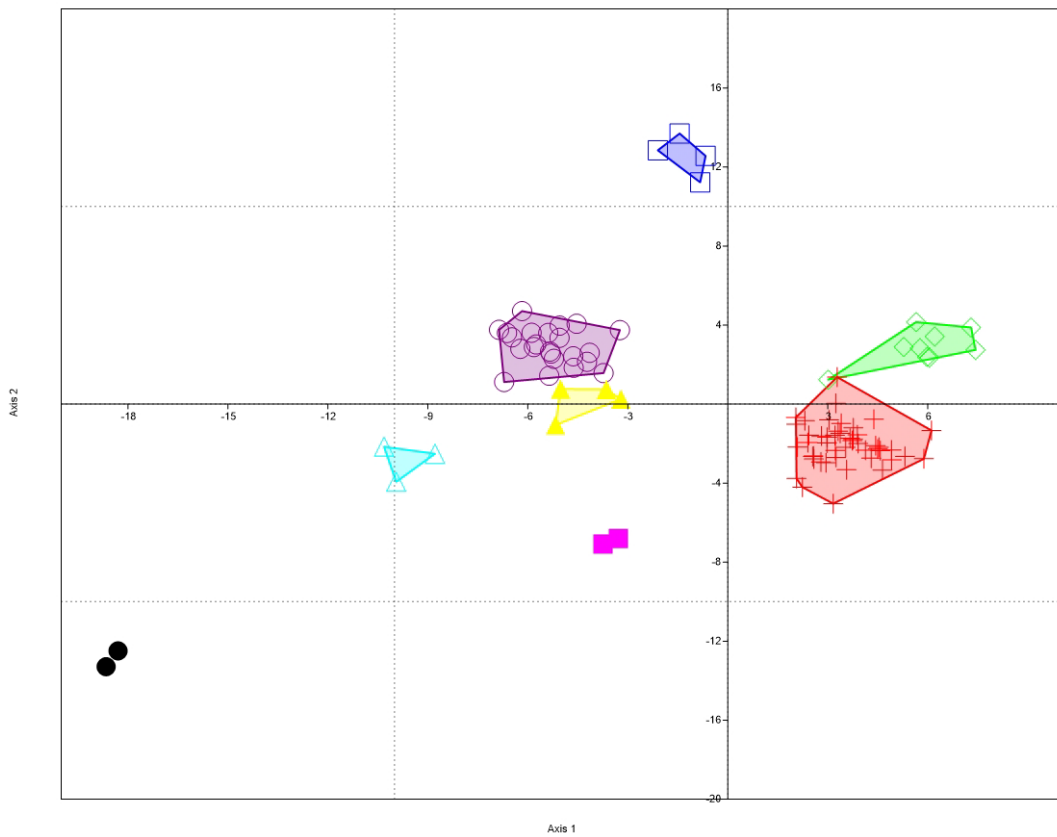

Fig. 3.14b MANOVA/CVA Convex hulls – Geometric Morphometrics of Sicilian.

- ● Paleolithic - ▲ Mesolithic - ▲ Bronze - □ Bronze/Iron
- ○ Antiquity - ■ Late Antiquity - ◇ Middle Ages - + Contemporary Age
-

3.2.4 Neighbour Joining

The Neighbour-Joining tree obtained with the Procrustes Coordinates of the entire Sicilian sample (Fig.3.15) reiterates the same observations of PCA with the Paleolithic specimens of San Teodoro (the Outgroup), from to which come down the all-later groups and the Mesolithic one segregating in two different clusters.

Bronze and Bronze/Iron groups and Middle Ages and Contemporary are relatively closer to each other showing a certain similarity.

Peculiar is the positions of Antiquity and Late Antiquity groups certainly influenced by sizes/sample composition and the unique regional “Populations Influx”.

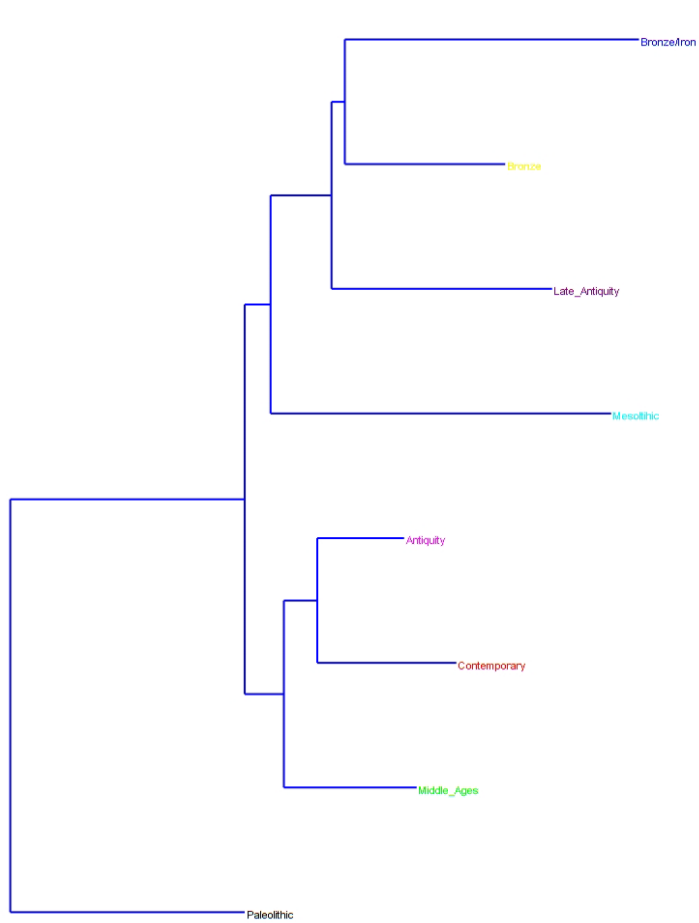

However, data will be discussed in detail in the next paragraphs on which will be clarified how they mainly reflect population history rather other cause.

Fig. 3.15 Procrustes Coordinates Neighbour-Joining hierarchical tree representing the historical divergence among the Sicilian populations from Paleolithic to Contemporary

3.2.5 Groups' Geometric Morphometrics

To highlights the Sicilian heterogeneity and test the hypothesis done the same sample was divide into two groups to focus the “Population Influx” during Prehistory and History (always using a group of Contemporary as reference sample).

Group1:

Upper-Paleolithic (●)

Mesolithic (△)

Bronze (△)

Bronze/Iron (□)

Group2:

Antiquity (○)

Late Antiquity (■)

Middle Ages (◇)

Contemporary (+)

Lollipop Graphs of Group1 and Group2 comparison clearly evidence the trend of Mesophalization of Sicilian Skulls.

Prehistorical specimens were still characterized by a certain Facial Prognathism showed by the landmarks placed on the superior jaw (Prosthion-Landmark 1 and Front points of Canine's Alveol-Landmarks 7 and 8) that slightly move forward (**Fig.3.16a**). At the same time facial and frontal bones, do not undergo any change (**Fig.3.16c-d-e**).

In that period, in fact, the main changes occur on the cranial vault with parietals (Stephanion- Landmarks 25-26 and Bregma Landmark 5) that all move forward (**Fig.3.16a**) and the occipital that slightly move inwards keeping an elongated and narrow shape of the posterior part (**Fig.3.16f-g**).

Meaningful are the changes occurred during historical periods with the landmarks placed on the superior jaw (**Fig.3.17a**). that don't undergo any change while the Fronto-Temporal Bones (Maxillary-Frontal Suture- Landmarks 15-16, Ectoconchion- Landmarks 17-18 and Fronto-Temporal-Malar- Landmarks 19-20) become wider and shorter (**Fig.3.17d-e**).

The Mesophalization is moreover increased by Parietals (Stephanion- Landmarks 25-26 and Bregma Landmark 5) and Occipital (Asterion Landmarks 23-24) bones that become wider and taller (**Fig.3.17c-d-f-g**).

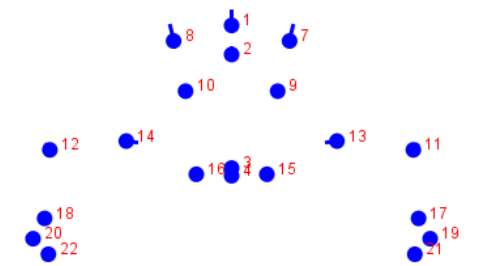

Fig. 3.16a PC ShapeChange
Group1: Sicilian Prehistorical

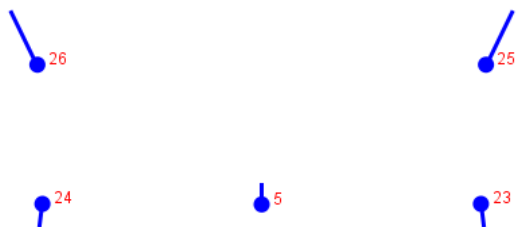
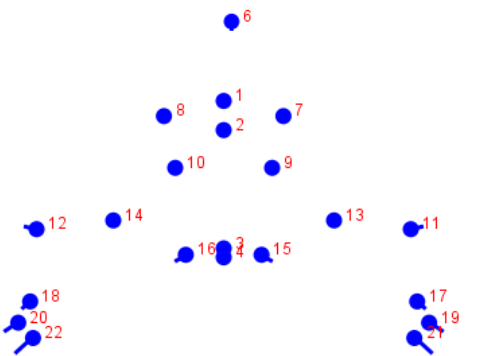

Fig. 3.17a PC ShapeChange
Group2: Sicilian Historical



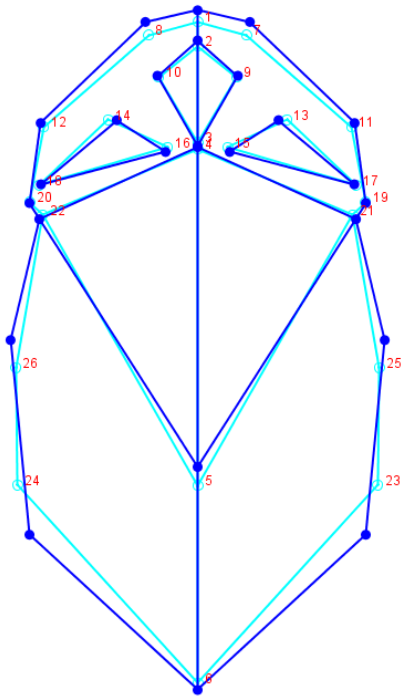

Fig. 3.16b Wireframe-Superior View
Group1: Sicilian Prehistorical

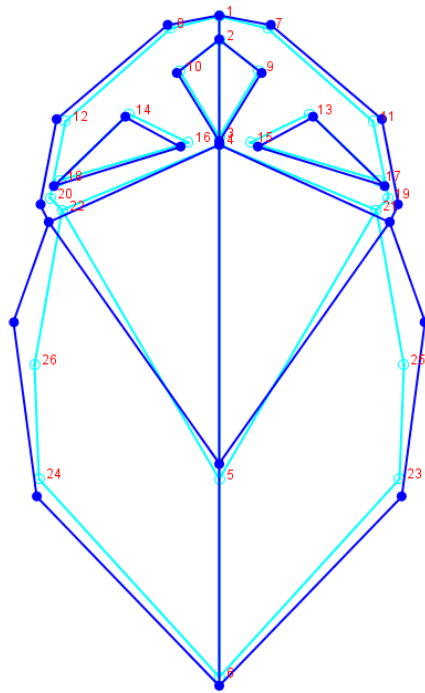

Fig. 3.17b Wireframe-Superior View
Group2: Sicilian Historical

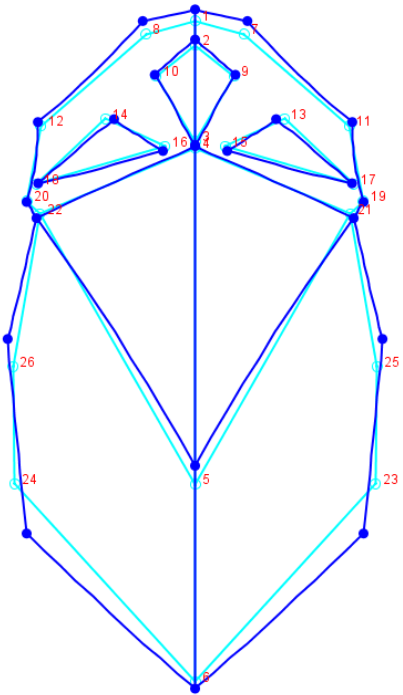

Fig. 3.16c Soft-Wireframe-Superior View
Group1: Sicilian Prehistorical

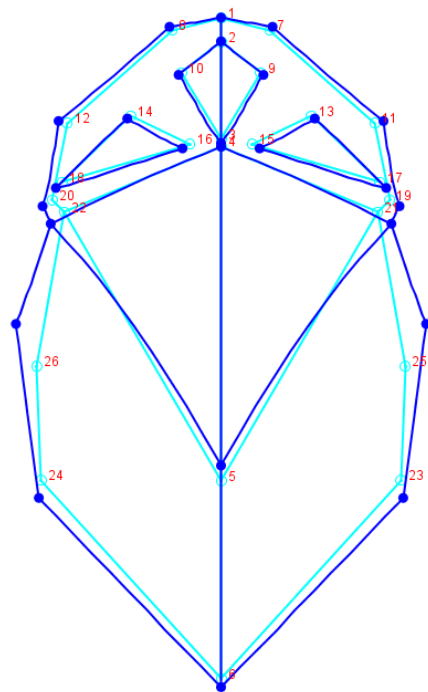

Fig. 3.17c Soft-Wireframe-Superior View
Group2: Sicilian Historical

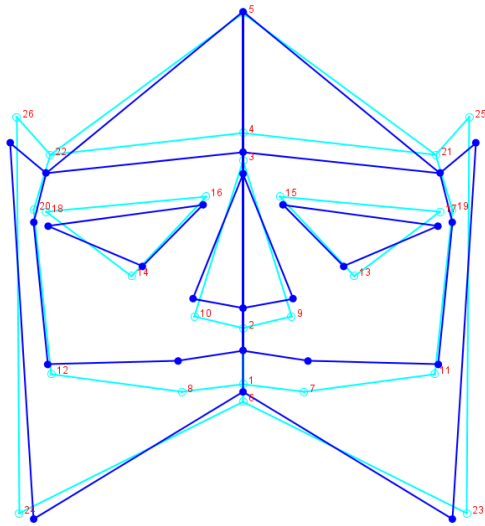

Fig. 3.16d Wireframe-Anterior View
Group1: Sicilian Prehistorical

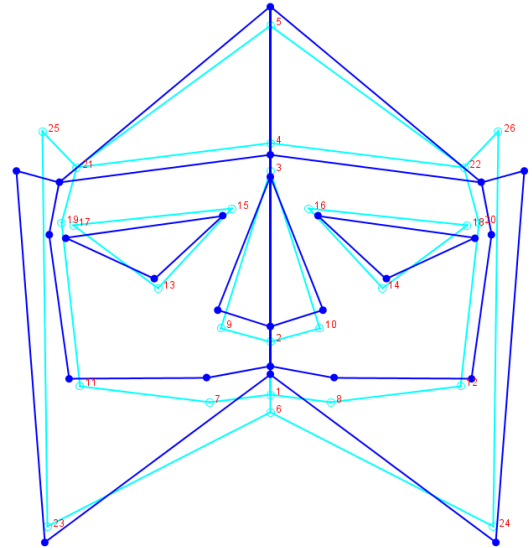

Fig. 3.17d Wireframe-Anterior View
Group2: Sicilian Historical

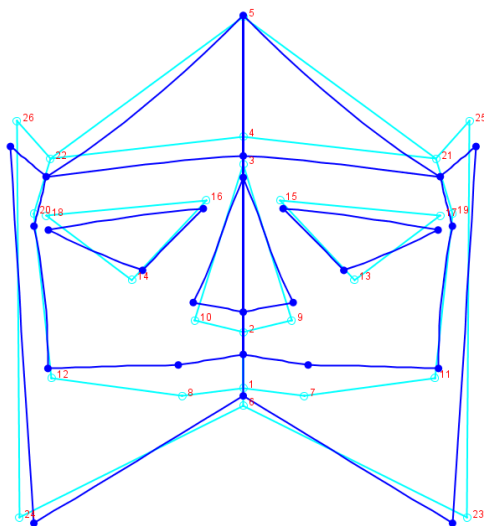

Fig. 3.16e Soft-Wireframe-Anterior View
Group1: Sicilian Prehistorical

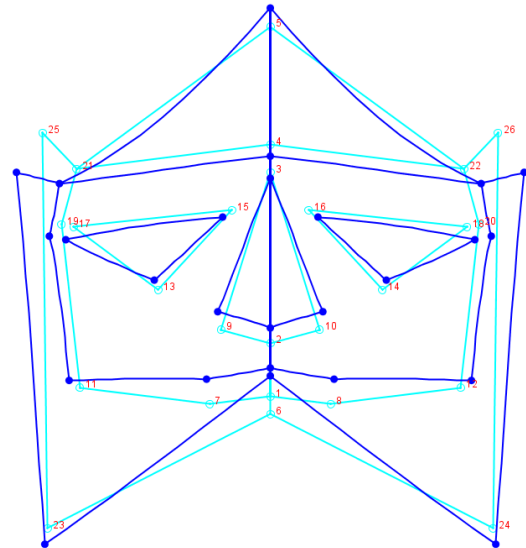

Fig. 3.17e Soft-Wireframe-Anterior View
Group2: Sicilian Historical

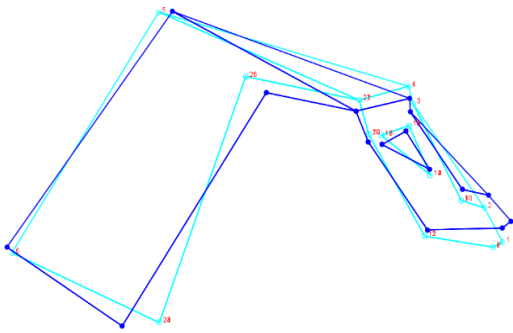

Fig. 3.16f Wireframe-Lateral View
Group1: Sicilian Prehistorical

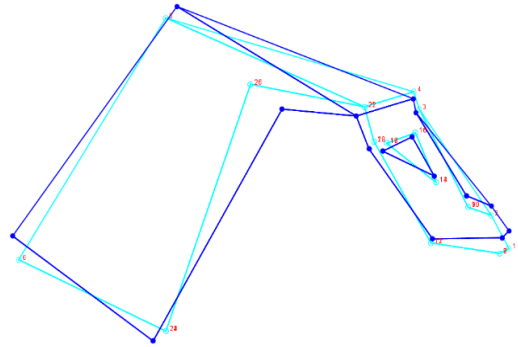

Fig. 3.17f Wireframe-Lateral View
Group2: Sicilian Historical

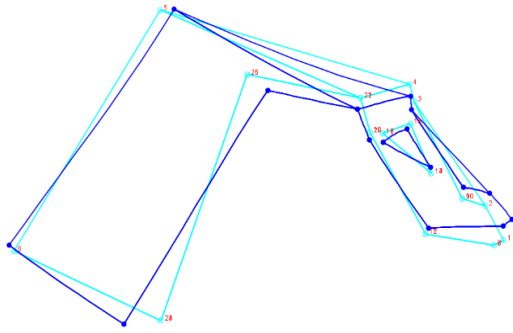

Fig. 3.16g Soft-Wireframe-Lateral View
Group1: Sicilian Prehistorical

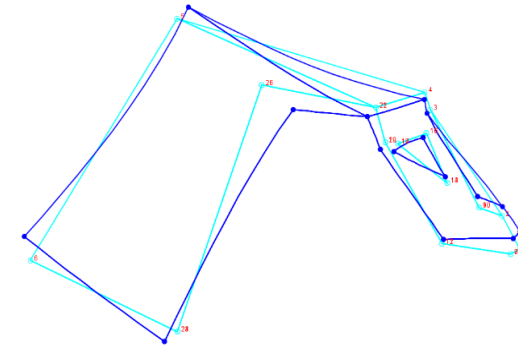

Fig. 3.17g Soft-Wireframe-Lateral View
Group2: Sicilian Historical

3.2.6 Groups' PCA

Regarding the groups, Prehistoric PC and Eigenvalue distributed among all the components decreases constantly (the % of variance decrease of 18%, 12% and 9% among the components that means submultiples of 3) and in general without significant variations among all the components (**Tab.3.8** and **Fig.3.18**). On the contrary historic decrease with significant steps across each Component (**Tab.3.9** and **Fig.3.19**). In general, this denotes a lack of directions of the PC due to the absence of internal relationship caused by the intricate colonizations patterns during Prehistory and History.

PC	Eigenvalue	% variance
1	12,739	55,56
2	7,90156	34,462
3	2,28783	9,9782

Tab.3.8 Percentage of Variance covered by Principal Components of Group1

Geometric Morphometrics

PC	Eigenvalue	% variance
1	4,06919	65,877
2	1,42171	23,016
3	0,68609	11,107

Tab. 3.9 Percentage of Variance covered by Principal Components of Group2

Geometric Morphometrics

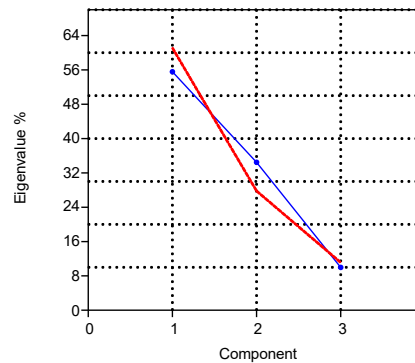

Fig. 3.18 PCA Scree Plot with Broken Stick (in red) – Group1

Geometric Morphometrics

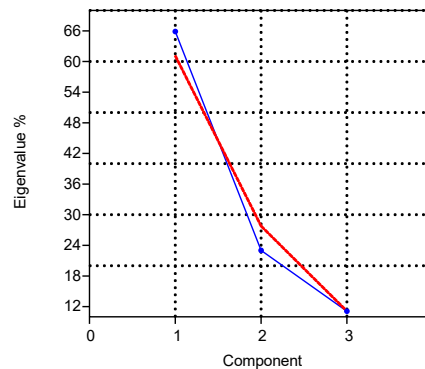

Fig. 3.19 PCA Scree Plot with Broken Stick (in red) – Group2

Geometric Morphometrics

PCA Analysis evidence the effects of migratory flow on the island genetic variability.

As regards Group1 (Prehistory) both PC1vsPC2 (**Fig.3.20a-b**) and PC1 vsPC3 (**Fig.3.21a-b**) shows still a clear separation between Paleolithic Würm-Settlers (●) and the indigenous of Mesolithic (△) Bronze (▲) and Bronze/Iron transition (□) clustered close to each other but separated from the Mesolithic one. These specimens, in fact, are found separated from the Mesolithic.

The inhomogeneous morphospace supports the theory of a discontinuous genetic flux carried by settlers during Prehistory.

Group2 (History) present another significative situation in witch the morphospace assume a more concentrical organization with a homogeneous distribution of the specimens along the four axes (**Fig.3.22a-b**).

In fact, this phase characterized by intense colonization and cohabitation of different populations granted for centuries an interrupted genetic increase of variability.

Although this was expected for the Contemporary, the same distribution showed by Antiquity (○), Late Antiquity (■) and Medievals (◇) attest not only an uninterrupted increase of variability but also a heterogeneity comparable with the Contemporary Age (+) (**Fig.3.23a-b**).

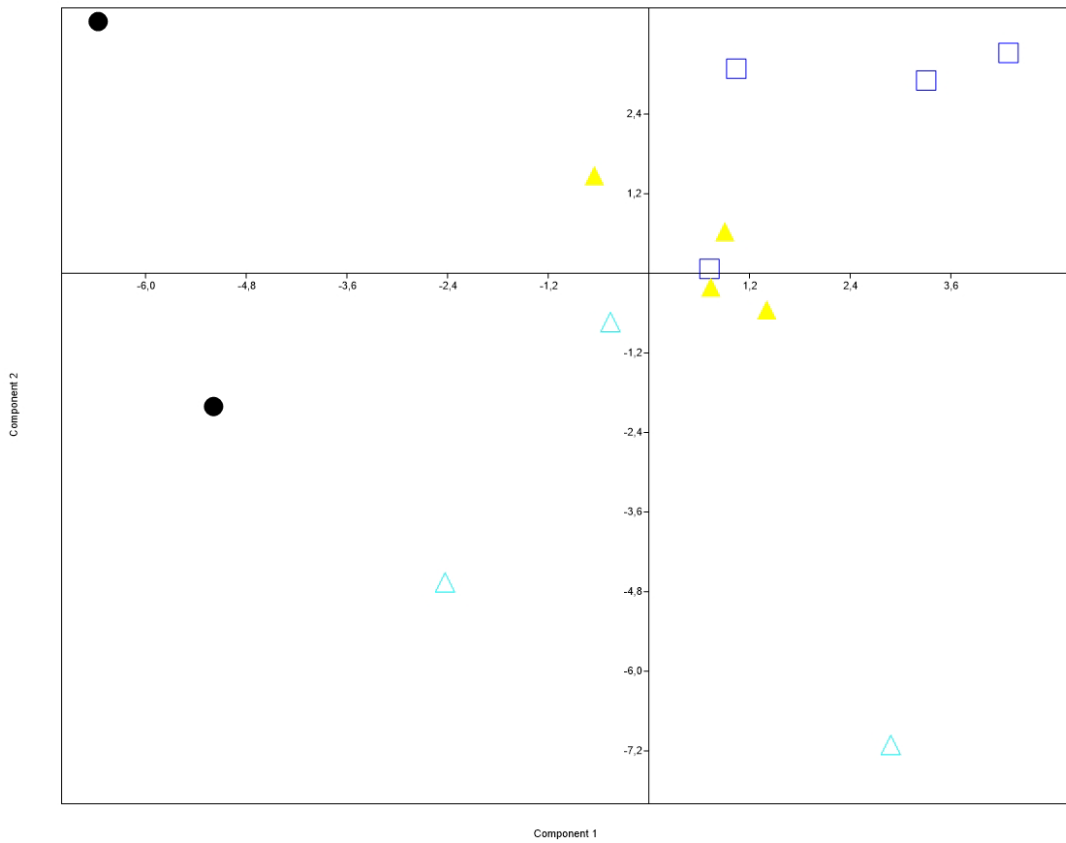

Fig. 3.20a PC1vsPC2 – Geometric Morphometrics of Group1: Prehistory
 - ● Paleolithic - ▲ Mesolithic - ▲ Bronze - □ Bronze/Iron

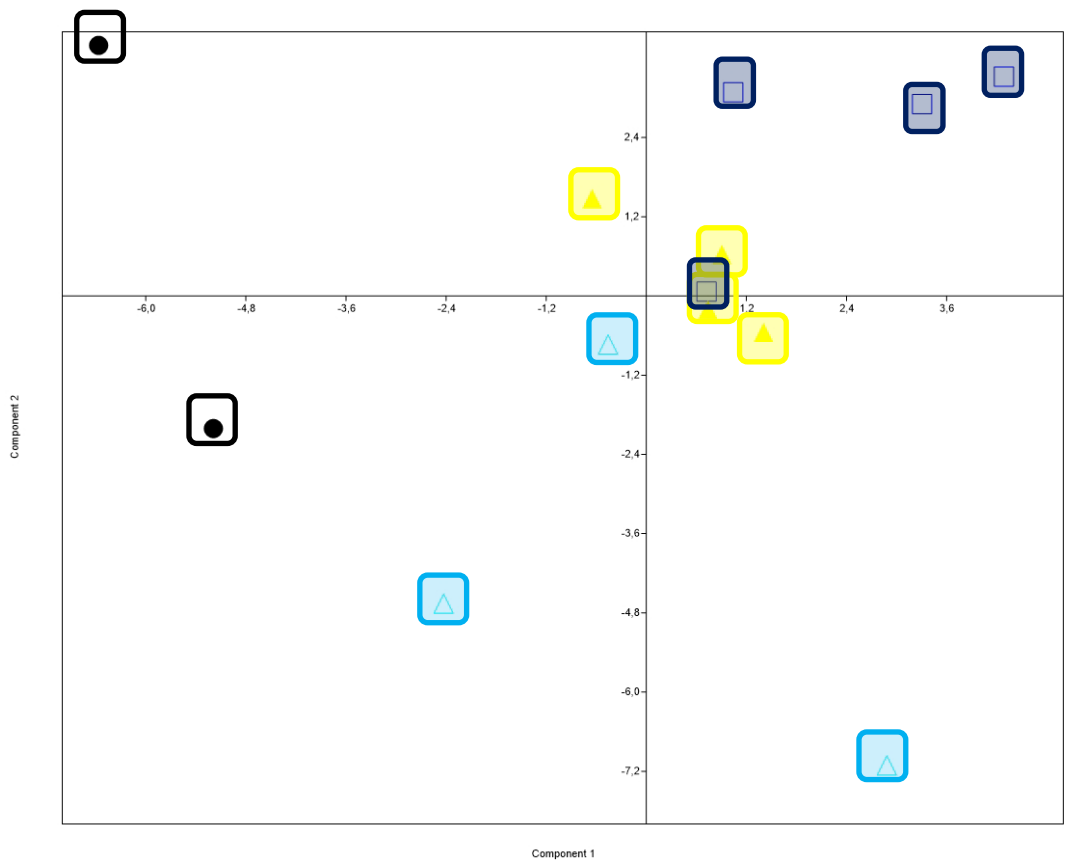

Fig. 3.20b PC1vsPC2 BoxColor – Geometric Morphometrics of Group1: Prehistory.
 - ● Paleolithic - ▲ Mesolithic - ▲ Bronze - □ Bronze/Iron

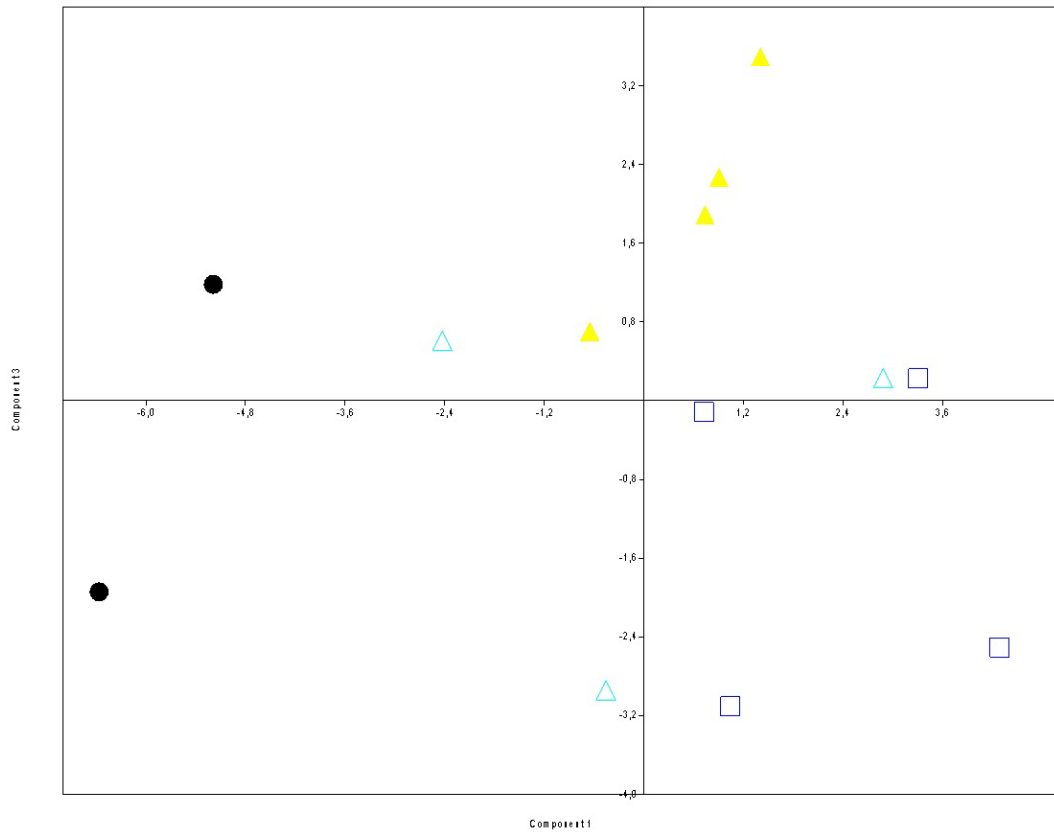

Fig. 3.21a PC1vsPC3 – Geometric Morphometrics of Group1: Prehistory.

- ● Paleolithic - ▲ Mesolithic - ▲ Bronze - □ Bronze/Iron

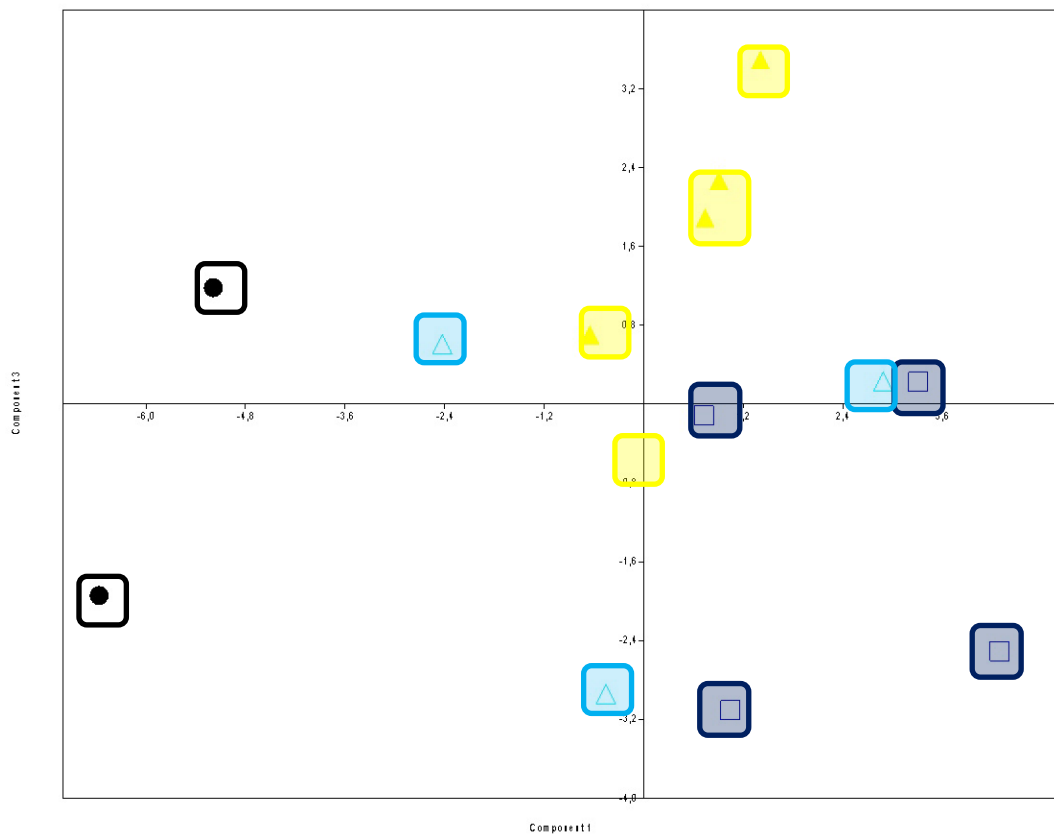

Fig. 3.21b PC1vsPC3 Box Color– Geometric Morphometrics of Group1: Prehistory

- ● Paleolithic - ▲ Mesolithic - ▲ Bronze - □ Bronze/Iron

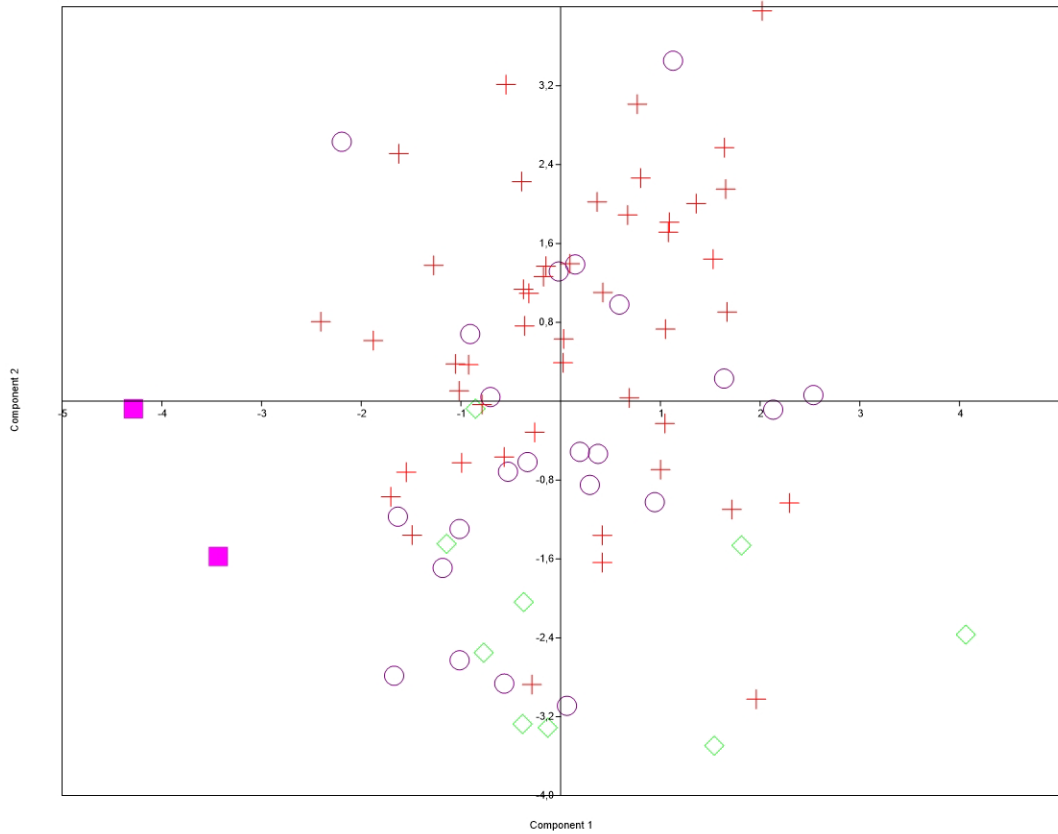

Fig. 3.22a PC1vsPC2 – Geometric Morphometrics of Group2: History
 - ○ Antiquity - ■ Late Antiquity. - ◇ Middle Ages - + Contemporay Age

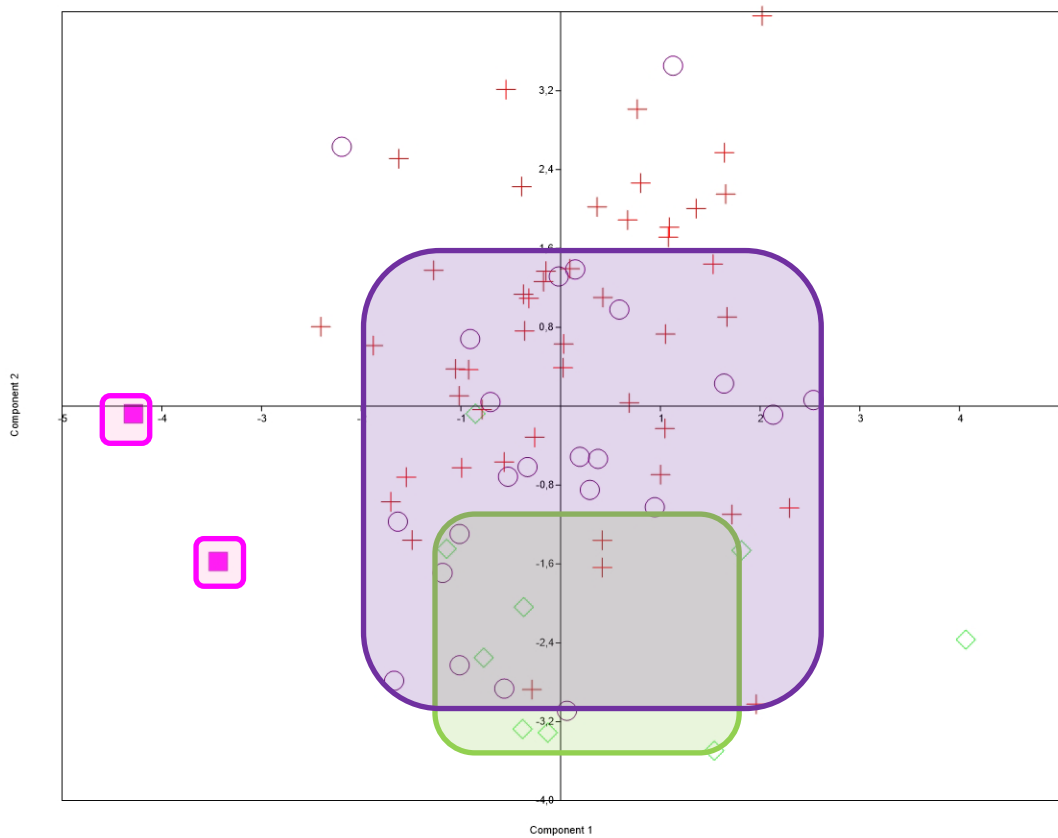

Fig. 3.22b PC1vsPC2 Box Color – Geometric Morphometrics of Group2: History
 - ○ Antiquity - ■ Late Antiquity. - ◇ Middle Ages - + Contemporay Age

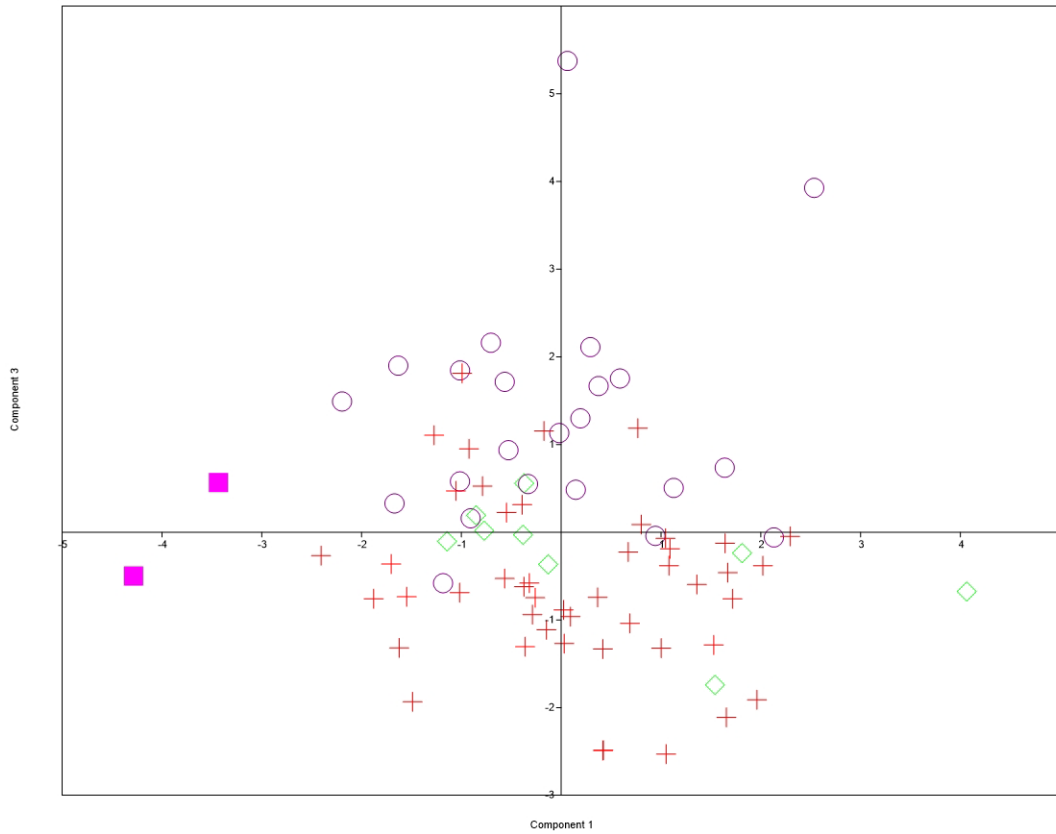

Fig. 3.23a PC1vsPC3– Geometric Morphometrics of Group2: History

- ○ Antiquity. - ■ Late Antiquity. - ◇ Middle Ages.
- + Contemporary Age.

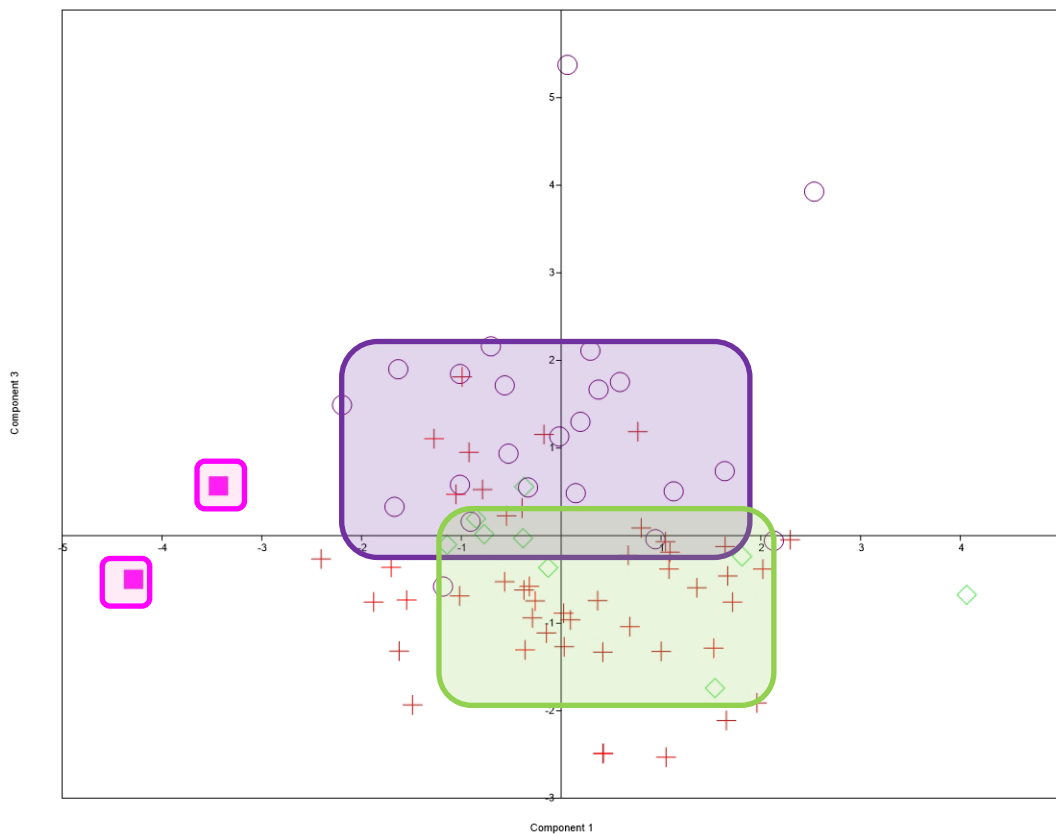

Fig. 3.23b PC1vsPC3 BoxColor – Geometric Morphometrics of Group2: History

- ○ Antiquity. - ■ Late Antiquity. - ◇ Middle Ages.
- + Contemporary Age

Group's PCA realized with the averages of the Procrustes Coordinates for each settlement (always excluding the single specimen of Molara).

To not to be redundant for Eigenvalue and % of variance we call back to what was discussed in paragraph 3.1.3 ([Pag.106](#)).

We only quickly remember that PC1 and PC2, among the Prehistoric groups represent more 93% of the total of variance and for that reason only these two will be considered (Historic group is compose only by PC1 and PC2).

PC	Eigenvalue	% variance
1	16,6405	53,318
2	12,5014	40,056
3	2,06782	6,6256

Tab.3.10 Percentage of Variance covered by Principal Components of Group1

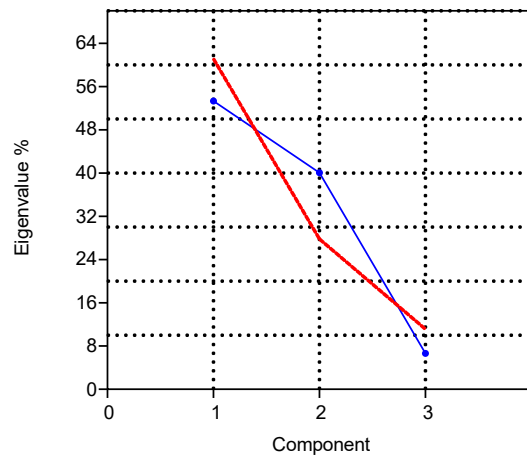

Fig. 3.24 PCA Scree Plot with Broken Stick (in red) – Group1

PC	Eigenvalue	% variance
1	3,7231	80,381
2	0,908717	19,619

Tab.3.11 Percentage of Variance covered by Principal Components of Group1

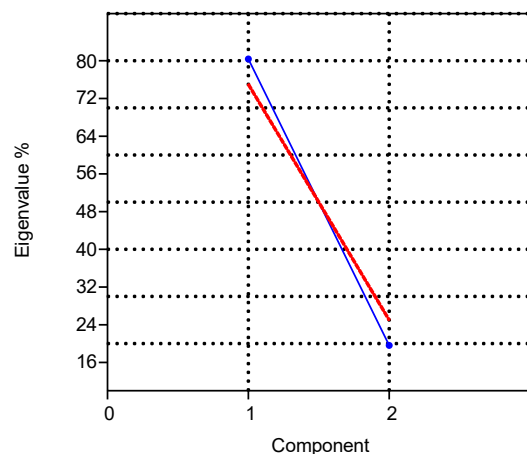

Fig. 3.25 PCA Scree Plot with Broken Stick (in red) – Group2

On the same way of the previous analysis the Group's PCA, computed with the average (Procrustes Coordinates) of each site help to clarify "Populations Influx" through the main Historical Periods.

Fig. 3.26 (Group1-Prehistory) is yet another demonstration of the sporadic and discontinuous "Human Flow" occurred during the Paleolithic and the Mesolithic with the lack of permanent settlements necessary to shape a well-defined Sicilian population. Appear clear that during these periods Paleolithics and Mesolithics (separated by the two PC axes) were still two different populations.

The same phenomenon is detectable on the Bronze and Bronze/Iron one that nevertheless appears as separated groups are found close to each other and both to the positives axes o the PCs.

This Graph as well the following despite they hold few Groups and PCs are a simple and quick way to represent the Sicilian scenario.

Fig. 2.27 (Group2-History) display the Groups of Antiquity all on the negative side of PC2 completely separated by Middle Ages and Contemporary that in turn are separated by the PC1 axe.

To notice are the positions of the Contemporary of Alia (18th century) and Rotoli (21th century) that lies on the same sides of PC axes but separated.

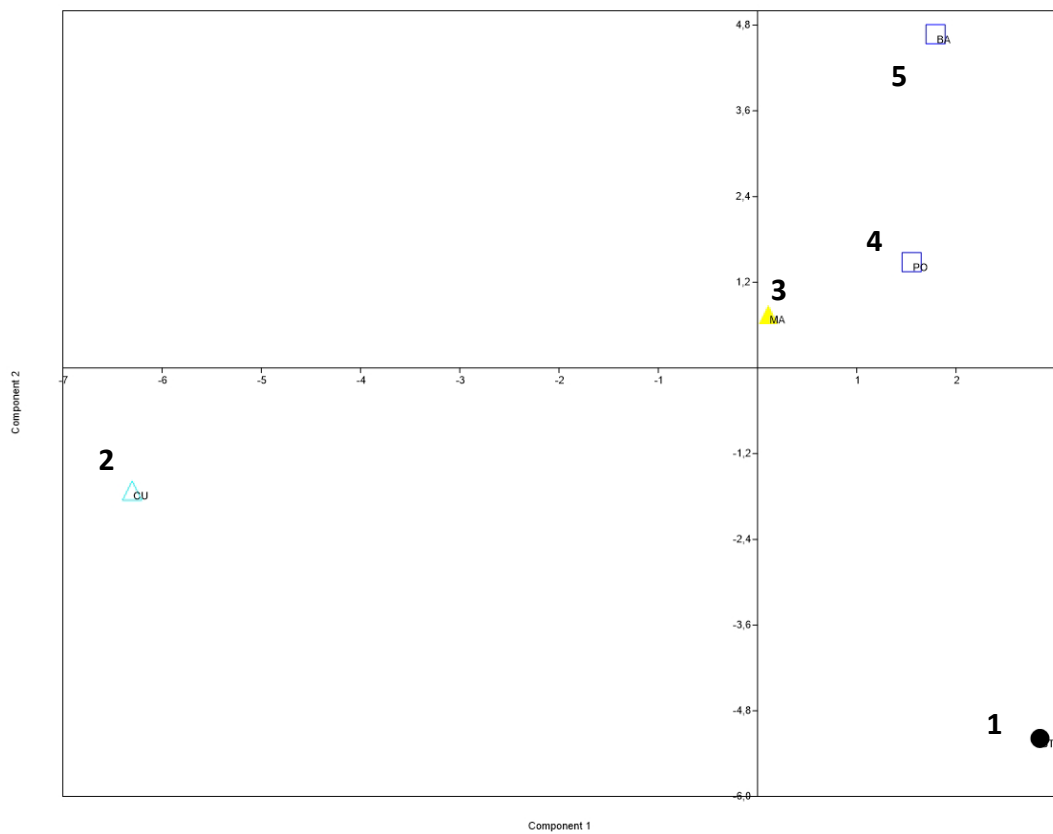

Fig. 3.26 PC1vsPC1 – Geometric Morphometrics of Group1: Prehistory

- ● Paleolithic - ▲ Mesolithic - ▲ Bronze - □ Bronze/Iron

- 1 San Teodoro (ST)
- 2 Grotta dell'Uzzo (CU)
- 3 Marcita (MA)
- 4 Polizzello (PO)
- 5 Baucina (BA)

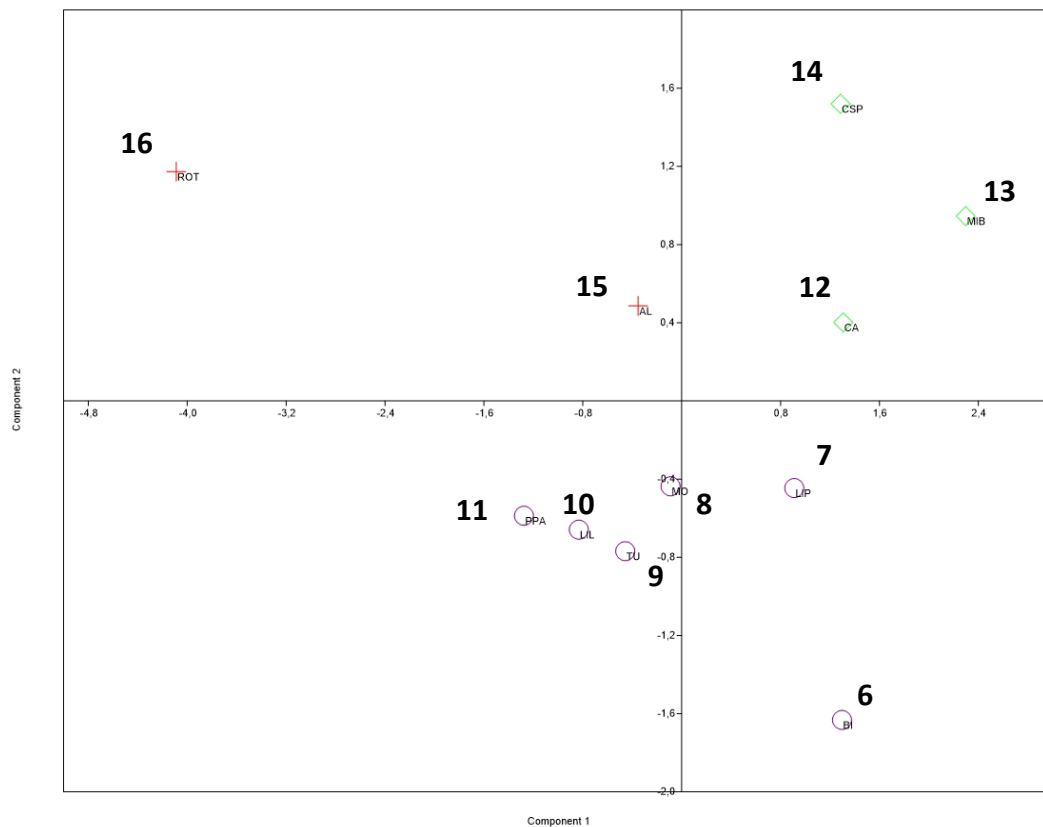

Fig. 3.27 PC1vsPC2 – Geometric Morphometrics of Group2: History

- ○ Antiquity - ■ Late Antiquity - ◇ Middle Ages - + Contemporary Age

- 6 Brigi (BI)
- 7 Lipari (LIP)
- 8 Mozia (MO)
- 9 Caserma Tukory (TU)
- 10 Lilibeo (LIL)
- 11 Phoenician of Palermo (PA)
- 12 Caltavuturo (CA)
- 13 Monte Iato B (MIB)
- 14 Castel San Pietro (CLP)
- 15 Alia
- 16 Rotoli

3.2.7 Group's Neighbour Joining

The Neighbour-Joining trees of Group1, Group2 supports the observations, and the hypothesis made on PCS with the Outgroup of the Paleolithic, featuring the first human flow followed by latter flow during the Mesolithic with a first significatives and stables migrations during the last centuries of the Iron Age (**Fig.3.28**).

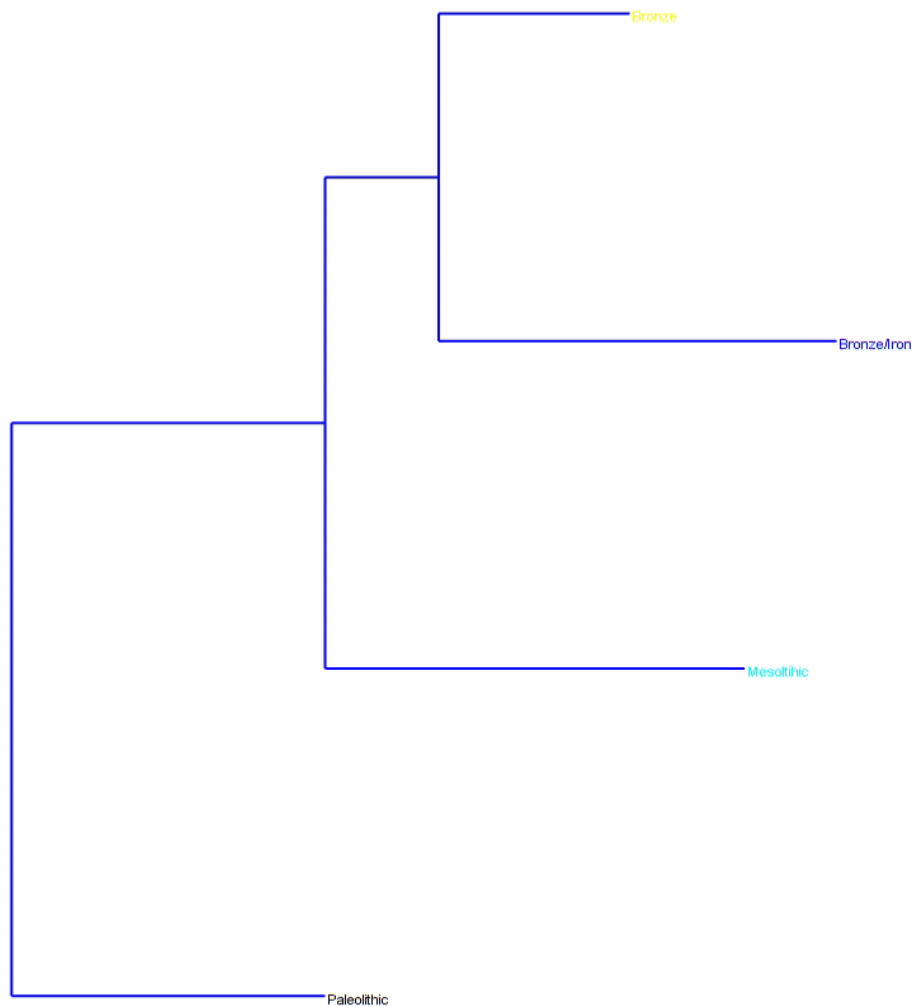

Fig. 3.28 Procustes Coordinates Neighbour Joining hierarchical tree representing the historical divergence among the Sicilian populations during the Prehistory

In the same way, the Neighbour-Joining tree of Historical, samples show the divergence from the oldest, group of Antiquity to Contemporary Age.

To notice are the similarities among Middle Ages and Contemporary Age specimens that, as predicted were the result of complex and varied migrations patterns and the positions of Late Antiquity group, undoubtedly the result of the but sizes/sample composition but also by the dynamic “Populations Influx” carried by the Roman Empire in those centuries (**Fig.3.29**).

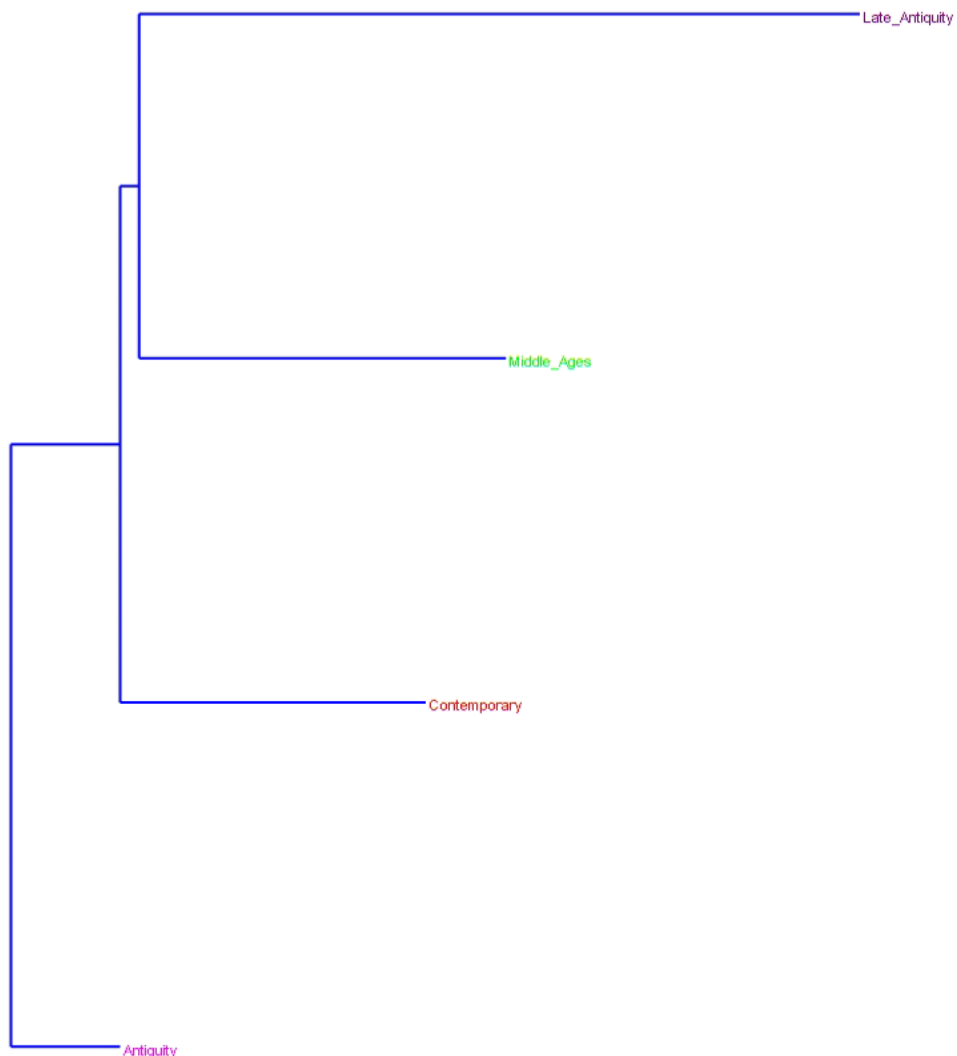

Fig. 3.29 Procustes Coordinates Neighbour Joining hierarchical tree representing the historical divergence among the Sicilian populations during the History

3.2.8 Comparison Sample

In order to test this main hypothesis Sicilian sample was compared with a reference sample of Spanish (Bronze, Middle Age and Modern) and Argentinian (Modern) (Tab.3.12). Results are shown, in detail, on the following graph:

Site	Key	Historical Periods	Populations
Grotta di San Teodoro	●	Upper Paleolithic	Würm-Settlers
Grotta del Uzzo	▲	Mesolithic	Mesoltitch Hunter-Gatheres
Grotta della Molara	▲	Mesolithic	Mesoltitch Hunter-Gatheres
Marcita	▲	Bronze	Indigenous
Polizzello	□	Bronze/Iron	Indigenous
Baucina	□	Bronze/Iron	Indigenous
Motya	○	Antiquity	Phoenician
Birgi	○	Antiquity	Phoenician
Caserma Tukory	○	Antiquity	Phoenician
Phoenician of Palermo	○	Antiquity	Phoenician
Lilibeo	○	Antiquity	Phoenician
Marsala	○	Antiquity	Greek/Roman
Lipari	○	Antiquity	Greek
Agrigento	■	Late Antiquity	Indigenous
Castel San Pietro	◇	Middle Ages	Islamic
Monte Iato-Position(B)	◇	Middle Ages	Norman/Swabian
Caltavuturo	◇	Middle Ages	Mixed
Alia	+	Contemporary Age	Contemporary Sicilian
Rotoli	+	Contemporary Age	Contemporary Sicilian
La Encantada	◇	Bronze	Spanish Bronze
Almansa	□	Middle Ages	Spanish Indigenous
Veranes	□	Middle Ages	Spanish Indigenous
Lugo de Llanera	□	Middle Ages	Spanish Indigenous
Marialba	□	Middle Ages	Spanish Indigenous
Spain	■	Contemporary Age	Contemporary Spanish
Argentinian	*	Contemporary Age	Contemporary Argentinian

Tab 3.12 Sampled Sicilian Site and Comparison Sample

A first PCA analysis (PC1vsPC2 and PC1vsPC3) was conducted comparing Paleolithic (●), Bronze (△), Antiquity (○), Late Antiquity (■), and Middle Ages Sicilian (◇) to Bronze Spanish (◊) and Middle Ages Spanish (□).

Although the separation between Paleolithic and Bronze were predicted interesting are the positions of Bronze Sicilian and Bronze Spanish specimen close but already separated, evidence of the first “Populations Influx” and genetic changes on Sicily (Fig.3.30a).

With the previous analysis, Sicilian Historical samples (composed of several populations and an intense migratory human flow) shows a high degree of variability not less than the continental one.

The situations observed is moreover the result of the same influence of Islamic domination during the Middle Ages.

For this reason, the overlap between the two groups is not surprising (Fig.3.30b).

Middle Ages situation can be so summarized with a slow decrease in robusticity and slow increase a variability (underlined by the concentrical morphospace). Sicilian Medievals appear slightly more robust than Spanish of the same period. Therefore, in this period we assist to an increase of variability linked to a decrease robusticity and dolichocephaly as shown by the position of Paleolithic specimens.

The last analysis involved only Contemporary Groups (Sicilian +, Spanish ■, and Argentinian*) using as outgroup the Paleolithic (●).

The wide variability of these groups and the homogeneous morphospace are the result of modern dispersal patterns that today involve the entire contemporary groups no more considerable well-defined populations (**Fig.3.31a-b**).

However, Contemporary Argentinian pear slightly separated from Contemporary Sicilian but does not fall within the scope of this work and will be investigated later.

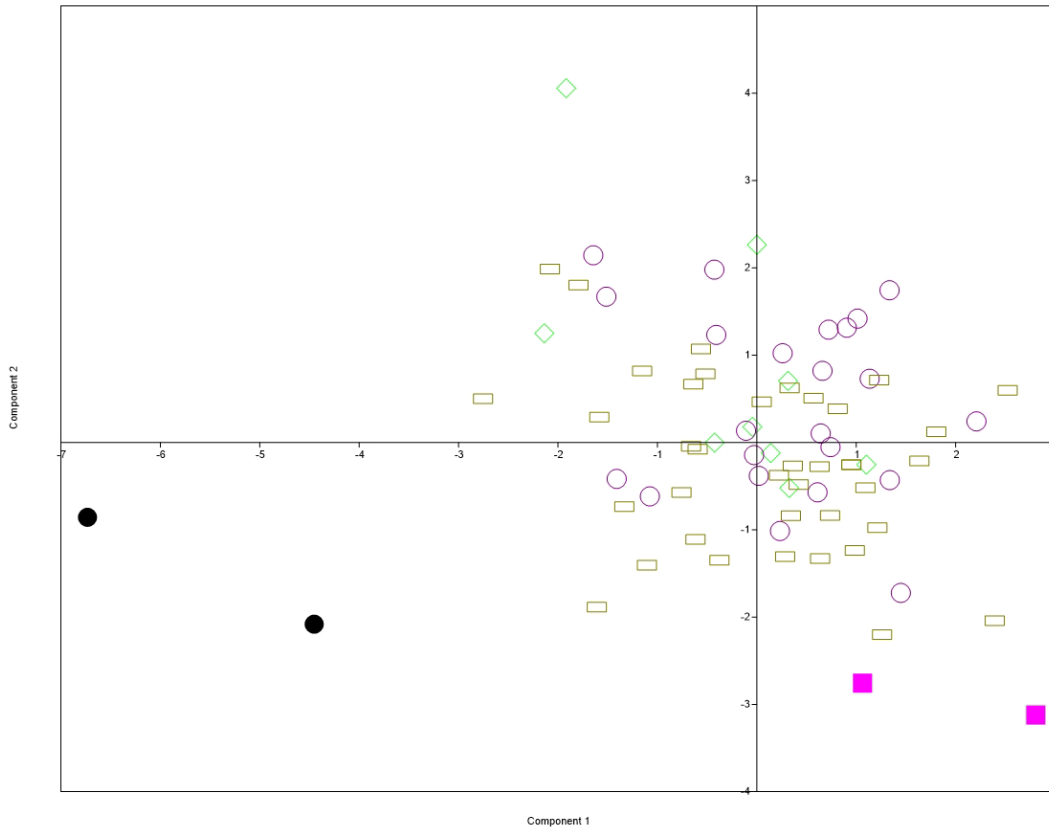

Fig. 3.30a PC1vsPC2

- ● Upper-Paleolithic – △ Bronze - ○ Antiquity - ■ Late Antiquity - ◇ Middle Ages Sicily
- ◇ Bronze-Spain - □ Middle Ages –Spain

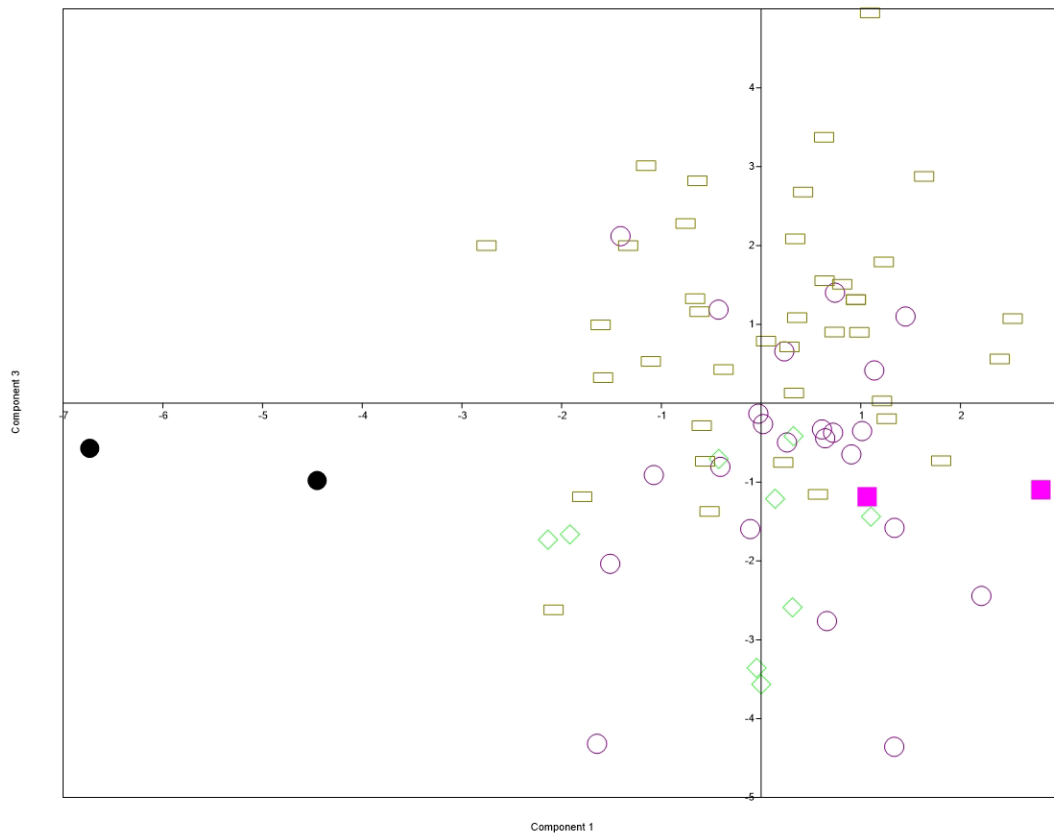

Fig. 3.30b PC1vsPC3

- ● Upper-Paleolithic. – △ Bronze - ○ Antiquity - ■ Late Antiquity - ◇ Middle Ages Sicily
- ◇ Bronze-Spain - □ Middle Age s–Spain

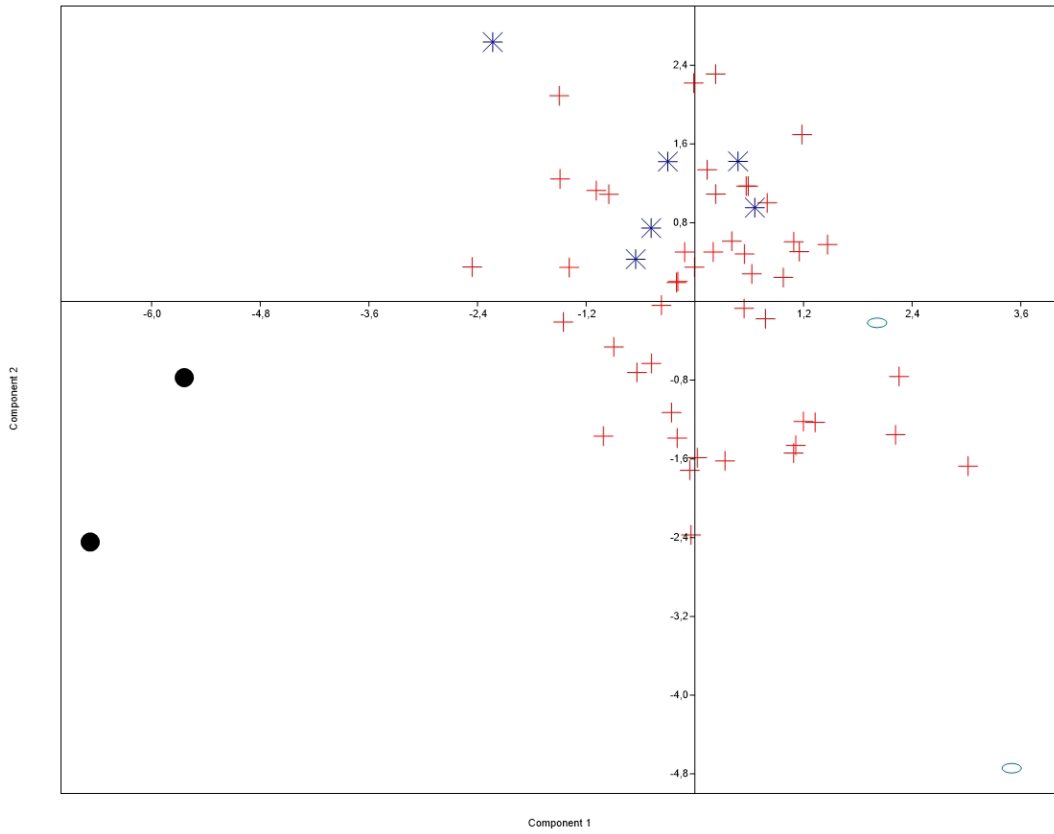

Fig. 3.30a PC1vsPC3

- ● Paleolithic - + Contemporary Sicilian - ○ Contemporary Spanish
- * Contemporary Argentinian

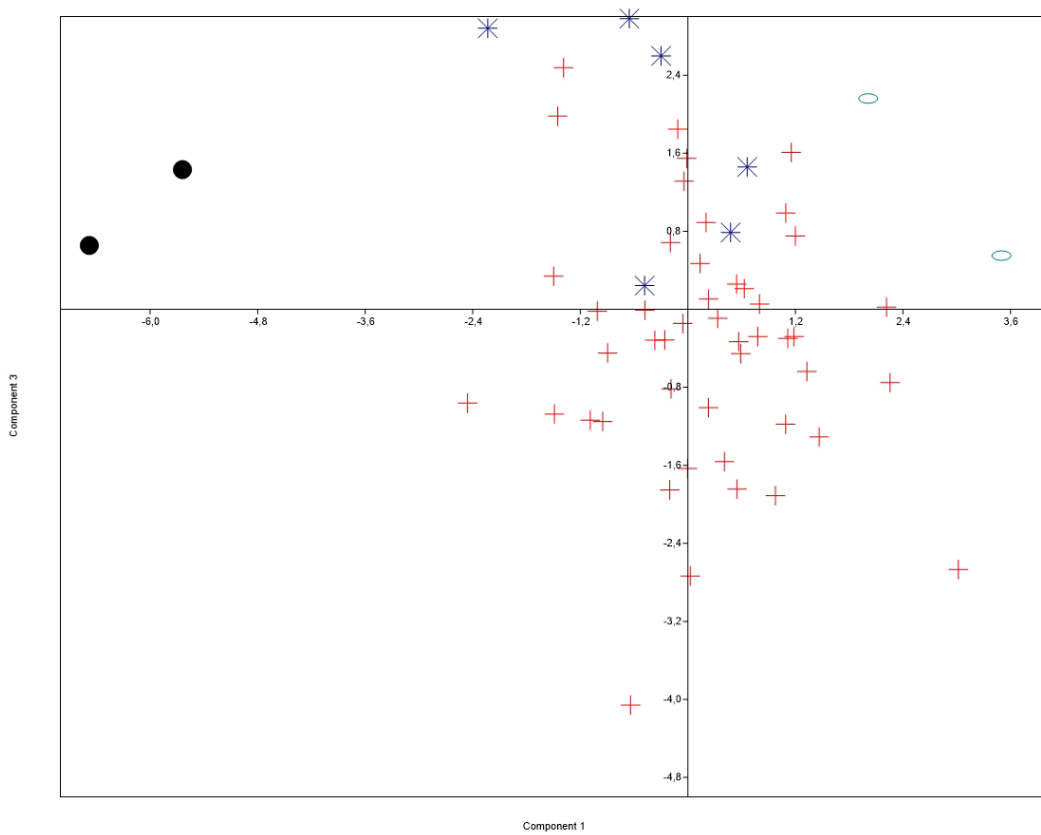

Fig. 3.30b PC1vsPC3

- ● Paleolithic - + Contemporary Sicilian - ○ Contemporary Spanish
- * Contemporary Argentinian

3.2.9 Precis

Recent developments in morphological analysis allow today to better understand the *Homo* migrations in the ancient world ([von Cramon Taubadel 2011](#)).

Timing this movement and the migratory routes, help today reconstruct human life-style during these movements.

The study of population dynamics in Sicily and the island-related issues are currently of great interest.

Geometric Morphometrics was used on Sicilian records to asses' genetic relationships ([Reyes- Centeno et al. 2017](#)) among populations during Prehistory and History.

Significant biological changes (consequently genetic variability [von Cramon Taubadel & Weaver 2009](#)) took place in Sicily through meaningful cultural/biological flows in connection with the climatic and environmental changes and the consequent ecological pressures.

According to the Paleo-Ecological studies is not surprising that the Upper-Palaeolithic of San Teodoro were the first to establish a permanent settlement. Specialist studies demonstrate that temperature of air, surface and sea and severe climatic conditions characterized the last glacial period ([Incarbona et al. 2010](#)) with vegetation look like steppe or semi-steppe environment (Sadori et al., 2008).

Only the final part of Palaeolithic presented climate stability allowing the conditions for the Hunter-Gatherer cyclically occupation of the island and adopting mobile-forager/semi-sedentary ecology ([Sineo et al. 2015](#)).

Only Sicilian Mesolithic peoples (who lived during the post-glacial period) had the ecological conditions favourable to a faunal representation enough large to human foraging and so to establish a permanent settlement ([Zanchetta et al. 2007](#) - [Sadori et al. 2008](#) - [Incarbona et al. 2010](#)).

At the present state of our knowledge, the skeletal records of San Teodoro are the first evidence of Sicily human peopling. Palaeolithic and Mesolithic craniofacial morphometric seems to favour this hypothesis with the first one still morphologically homogenous with the contemporaneous populations of Italy ([Galland et al. 2019](#)). After Paleolithic, the huge human skeletal records available clarified lifestyles of these ancient peoples (dietary, health conditions, subsistence strategies) with data that support the morphological hypothesis of a homogeneous population after this period ([D'Amore et al. 2009](#)).

Multidisciplinary researches based on archaeology and history were carried during the main Historical Periods. That study underlines the influence of anthropic-environmental factors in relation to the important impact of "Population Influx" carried by colonizers (coming from different geographical areas) with the second one the main culprits of the morphological variations (genetic variability - [Matsumura et al. 2018](#)).

Many bio-anthropological aspects occurred between Antiquity and Middle Ages suggested that the homogenous morphospace generated is the result of continuous genetic recombinations who have not allowed a defined typing of the skulls that however kept the general trend of Mesophalizations.

Results based on a Principal Component Analysis highlight the variability of Sicilian and denote only a soft cluster between Upper Paleolithic and Mesolithic with the first one characterized by less variability (always consider sample size). Morphological variability linked with genetic variability is instead clearly present during Bronze and Bronze/Iron transitions and so with first influential human flows from the continent.

The results of human flow will be clear on the Historical periods as underlined by the specimen lying along all the four axes in all the main periods.

As regard form as illustrated Prehistoric was still characterized by elongated occipital bone and more prognathic and narrower face but with wider cranial vault done by the increase of parietal bones, the beginning of the mesophalization. This trend was more stressed during Antiquity and the following period by facial and occipital bones.

Considering all the groups MANOVA/CVA clearly show San Teodoro specimens strongly distinct from Mesolithic Sicilian and closer affinities with Upper-Paleolithic Italian specimens ([D'Amore et. al 2009](#) - [Galland et. al 2019](#)).

Mesolithic Sicilian samples are instead, closer to other Mesolithic samples ([Galland et. al 2019](#)) in a well-defined group in turn separate by the Bronze and Iron one.

Main Historical periods despite undergo to several "Population Influx" clustered in a well-defined morphospace with Medievals and Contemporary separated by PC1 axe from the other and in turn close to each other but separated by PC2 axe.

To sum up, without any doubt, adaptive changes (like masticatory-induced phenotype) are the base of genetic and morphological variability.

Nevertheless, changes are not only due to environmental factors but also due to the genetic influences of human flow ([Betti et al. 2009](#)).

The large differentiation of cranial shapes during the century could not be only explained by the adaptive changes but also by the arrival of new people during the period mentioned before.

Skull morphology was indeed, subjected to selective pressures but is in parallel, impacted by cultural variations with the same plasticity ([Harvati & Weaver 2006](#)).

Our results align with the predictions of the “Population Influx” hypothesis that during the transition Bronze/Iron the first significative human migratory flows begun to produce not negligible variations in Sicilian skull’s morphology.

This is suggested by the distinction between Paleolithic, MesoNeolithic and Bronze samples and the later cultural groups (with a huge increase of variability during Antiquity).

Data presented in this work corroborates major biological changes hypothesized by the main colonial’s period influences and the selective pressures on the overall shape of the cranium.

This analysis (mainly concentrated on the face) show how “Human Flows” have changed Sicilian despite keeping a regional continuity during the temporal variation.

This agrees with previous cranial studies, which have identified differentiation in the same period.

Our results do not suggest a dramatic shift in cranial morphology but some steps of significative variation (Bronze/Iron, Antiquity, and Middle Ages) displayed according the PCA, MANOVA/CVA and Neighbour Joing ScatterPlot.

Is important do not forget that this sample represents an island that is a restricted context and variations between human groups (in a localised geographical region like Sicily) are often stressed by the limited genetic pool ([Bottle Neck and Founder Effect](#)).

Instead of the huge variability produced by the interaction between indigenous and settlers, the PCA does not present a clear dominant pattern along with the axes (concentric organisation) and differences lie in a quite homogeneous morphospace that suggests a continuous slow degree of morphological differentiations significantly increased only by the steps discussed before.

Results indicate that the morphometric approach is extremely precise for the definition of cranial diachronic variability and allows to reconstruct phylogenetic scenarios with the same degree of effectiveness and interest of the scenarios obtained by ancient genomic sequences of DNA.

3.3 Secular Trend

The last character considered to investigate the human biodiversity in Sicily was the secular trend of stature. The work mainly consists in a review of the previous papers and in the measurement of new populations. (Tab.3.13) report populations measured to estimate the secular trend.

Site		Keys	Historical Periods	Populations
San Teodoro	ST		Upper-Paleolithic	Mesolithic Hunter-Gatherers
Grotta del Uzzo	CU	▲	Mesolithic	Mesolithic Hunter-Gatherers
Piano Vento	PV	□	Neolithic	Indigenous
Fossato Stretto Partanna	FSP	□	Neolithic	Indigenous
Roccazzello	RO	○	Eneolithic	Indigenous
Grotta del Vecchiuzzo	CV	○	Eneolithic	Indigenous
Grotta del Fico	CF	*	Copper	Indigenous
Marcita	MA	▲	Bronze	Indigenous
Stretto Partanna	SP	▲	Bronze	Indigenous
Grotta Chiusilla	CC	□	Bronze/Iron	Indigenous
Polizzello	PO	□	Bronze/Iron	Indigenous
Baucina	BA	□	Bronze/Iron	Indigenous
Desueri	DE	●	Iron	Indigenous
Caserna Tukory	CT	○	Antiquity	Phoenician
Contrada Petraro (Entella)	CPE	○	Antiquity	Phoenician
Lilibeo	LIL	○	Antiquity	Phoenician
San Giovanni Marsala	SGM	■	Late Antiquity	Indigenous
Licata	LIC	■	Late Antiquity	Indigenous
Agrigento	AG	■	Late Antiquity	Indigenous
Sant'Agata	SA	■	Late Antiquity	Indigenous
Entella	EN	◇	Middle Ages	Islamic
Castel San Pietro	CSP	◇	Middle Ages	Islamic
Segesta	SE	◇	Middle Ages	Islamic
Monte Iato-Position(A)	MIA	◇	Middle Ages	Islamic
Monte Iato-Position(B)	MIB	◇	Middle Ages	Norman/Swabian
Monte Maranfusa	MAR	◇	Middle Ages	Norman/Swabian
Alia	AL	+	Contemporary	Contemporary Sicilian
Rotoli	ROT	+	Contemporary	Contemporary Sicilian
Contemporary Italian	IT	+	Contemporary	Contemporary Italian

Tab 3.13 Sampled Sicilian Site for the Secular Trend Section

3.3.1 Canonical Statistics

Fig.3.32 and **Tab.3.14** report the average of stature divided for populations and gender. Instead, the huge amount of data appears clear the dependence by gender of this character and the trend of the increasing trough the centuries.

LineGraph (**Fig.3.33**) clearly show the trend with the average that quickly increase during Middle Ages and in the Contemporary populations of Alia (Sicily 19th century), Rotoli (Sicily 21th century) and the data provided by ISTAT on 2013 (with the last one taller than the Sicilian of the same period).

Site	Average M	Average F		Site	Average M	Average F
ST	/	162,7		SGM	168,7	158,3
GU	162,2	152,2		SA	167,5	155,2
PV	161	151		LIC	166,02	156,19
FSP	171,8	146,2		AG	167,1	153,04
RO	162	155		CPE	170,2	154,6
GV	/	157,5		MIA	166	157
CF	163,6	/		MIB	172,8	153,6
MA	165	153		CSP	177,4	157,4
GC	167	157		EN	171,5	157,5
SP	161	151		MAR	167	153,3
BA	158	153,96		SE	171,6	155,3
PO	164,6	150,7		AL	161,08	157,29
DE	168,1	153,7		ROT	163,05	159,09
LIL	167,5	155		IT	175	162
CT	165,2	153,6				

Tab 3.14 Populations - Average in cm of Stature / = no records available

Distinguishing are the values of the Medievals Islamic populations (MIA-CSP-EN-SE) which are indeed, higher compared to the other Medievals indigenous groups.

Peculiar is Monte Iato with MIA taller than the Sicilian but shorter than the other Islamic and MIB, as the same way, shorter than the Islamic but taller than the Sicilian.

Index of a probable genetic exchange between populations.

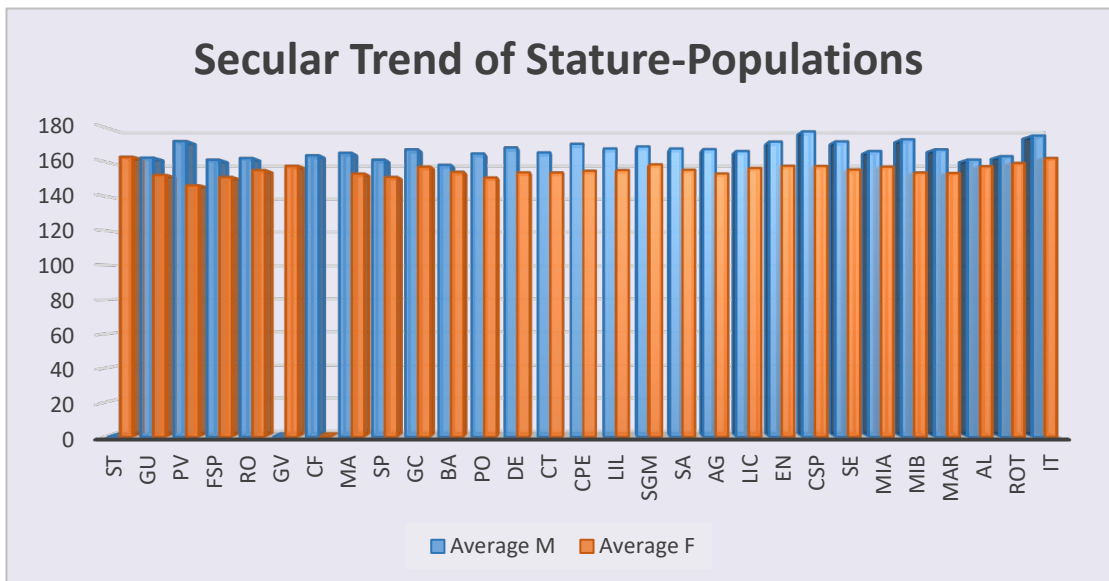

Fig. 3.32 Histogram of Stature-Populations

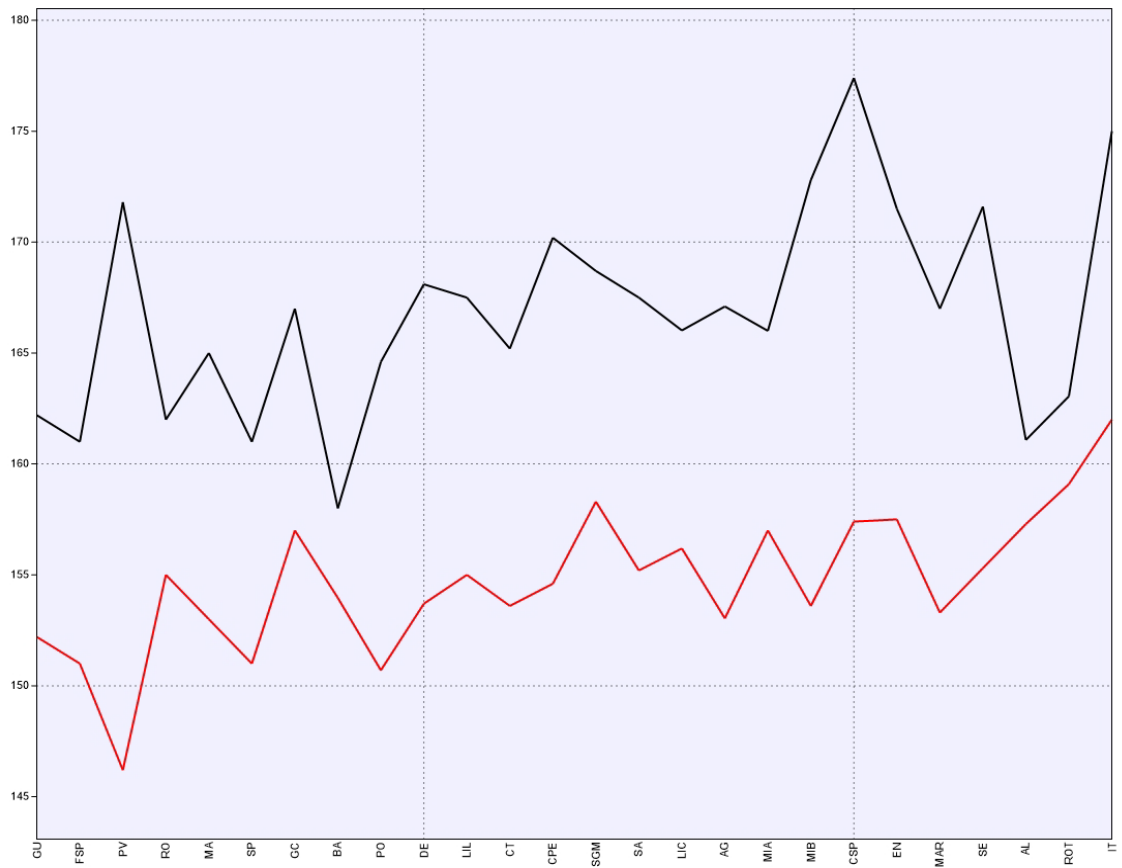

Fig. 3.33 LineGraph of Stature-Populations

-Black: Male
-Red: Female

To a better display of the Secular Trend phenomenon populations were grouped for ages and subsequently was calculated the average (always for gender) as possible to see on **Tab.3.15**

Historical Period	Average M	Average F
Mesolithic	162,2	152,2
Neolithic	166,4	148,6
Eneolithic	162,0	155,0
Bronze	163,0	152,0
Bronze/Iron	163,2	153,9
Iron	168,1	153,7
Antiquity	167,6	154,4
Late Antiquity	167,3	155,7
Middle Ages -Islamic	171,6	156,8
Middle Ages -Indigenous	169,9	153,5
Contemporary Sic.	162,1	158,2
Contemporary Ita.	175,0	162,0

Tab 3.15 Age - Average in cm of Stature

Looking at the values is clear that Stature remained quite constant during Prehistory until Iron Age on which we assist to a first increase (**Fig.3.34**).

Statures so remain stable during Antiquity and Late Antiquity to undergo a significative increase during the Middle Ages.

Another time peculiar are the values of Islamic Medieval specimen all over the average. At the same time, Islamic acheaving values reached only in the Contemporary Age (**Fig.3.35**).

The insular effect is moreover highlighted by the difference between the last three groups (Contemporary Sicilian - 19th century, Contemporary Sicilian – 21th century and Contemporary Italian – 21th the century) with the average in Italy nowadays higher than in Sicily.

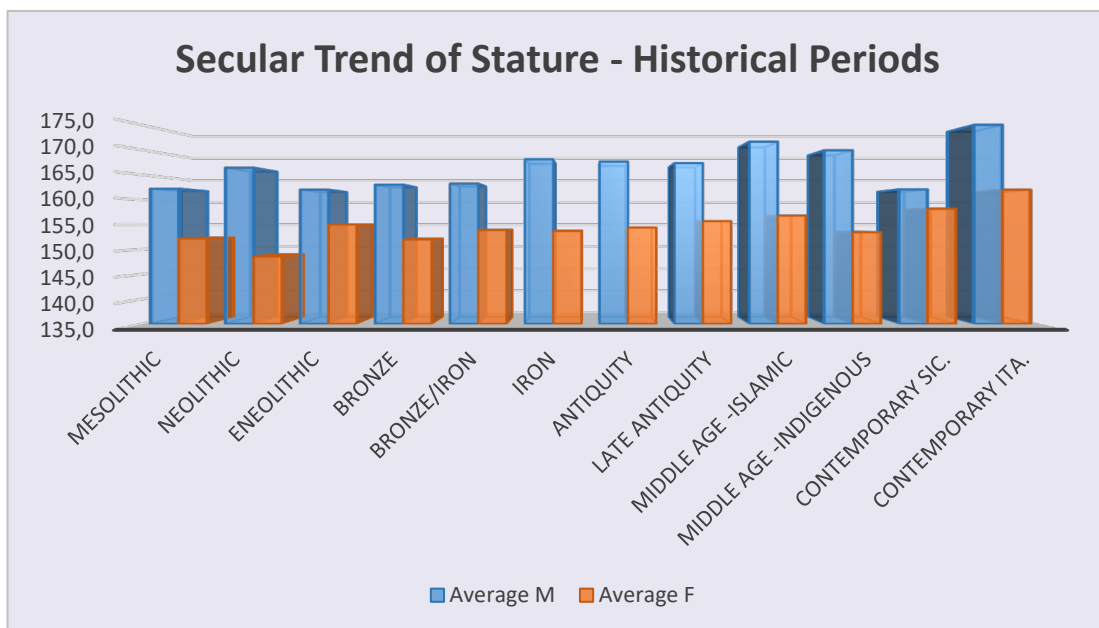

Fig. 3.34 Histogram of Stature-Periods

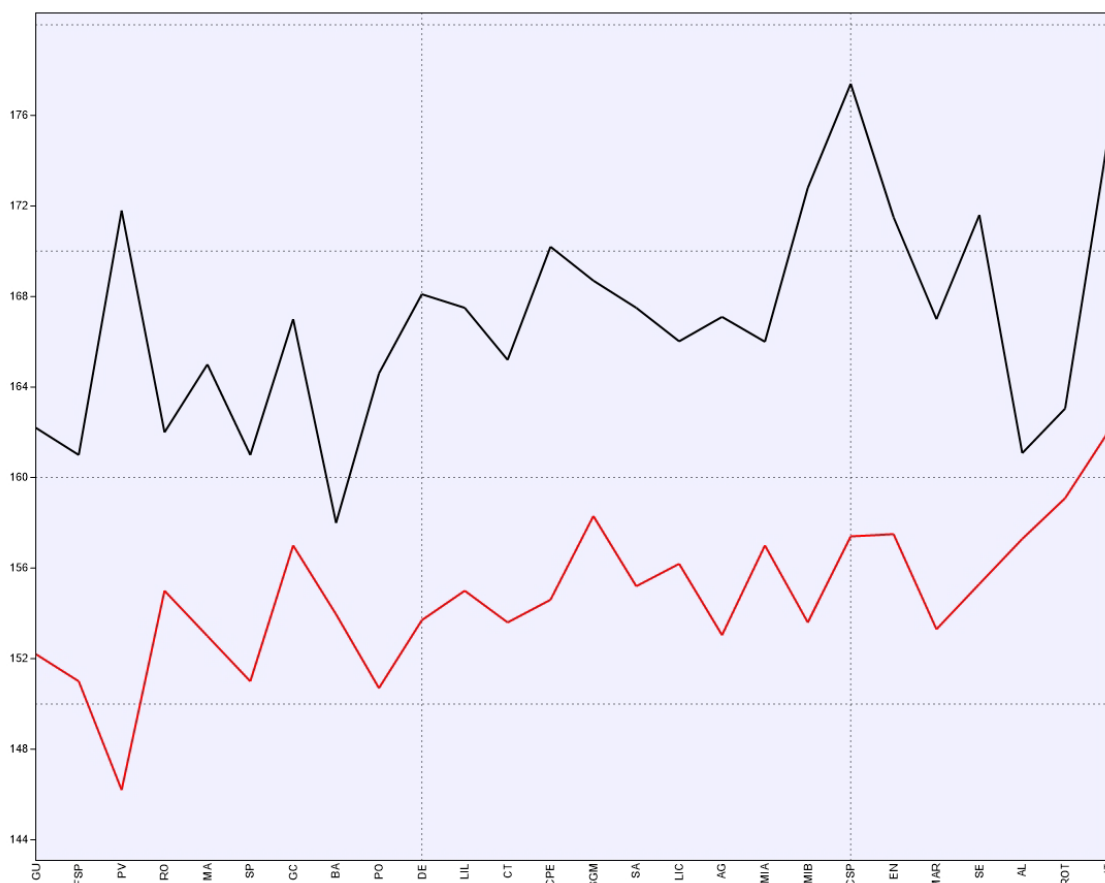

Fig. 3.35 LineGraph of Stature-Periods

-Black: Male
-Red: Female

3.3.2 Multivariate Statistics

Finally, for both the two groups (Populations and Age) were performed a PCA.

(on the analysis were excluded ST, CV and CF for missing record, so data available for one of the gender).

- PCA: PC1 Eigenvalue 22, 03 - % of variance 75, 6 and PC2 Eigenvalue 7, 9, - % of variance 24, 4.

The aim was evidence of the biological distances and the variation of the Stature from Prehistory to nowadays.

Multivariate Analysis confirm and highlights the assumptions made before showing the Prehistorical that lies along the left side of the PC1 axe separated by the Contemporary by PC1 or PC2 axes (**Fig.3.36**).

To notice is the positions of Iron (●), Antiquity (○) and Late antiquity (■) found close to the center of the axes and Middle Ages (◇) and Contemporary (+) quite all on the right side of PC1 axe but separated by PC2 axe.

The exception is the positions of Contemporary Sicilian with the two groups of Sicilian close to each other and further away from the Contemporary Italian (**Fig.3.37**).

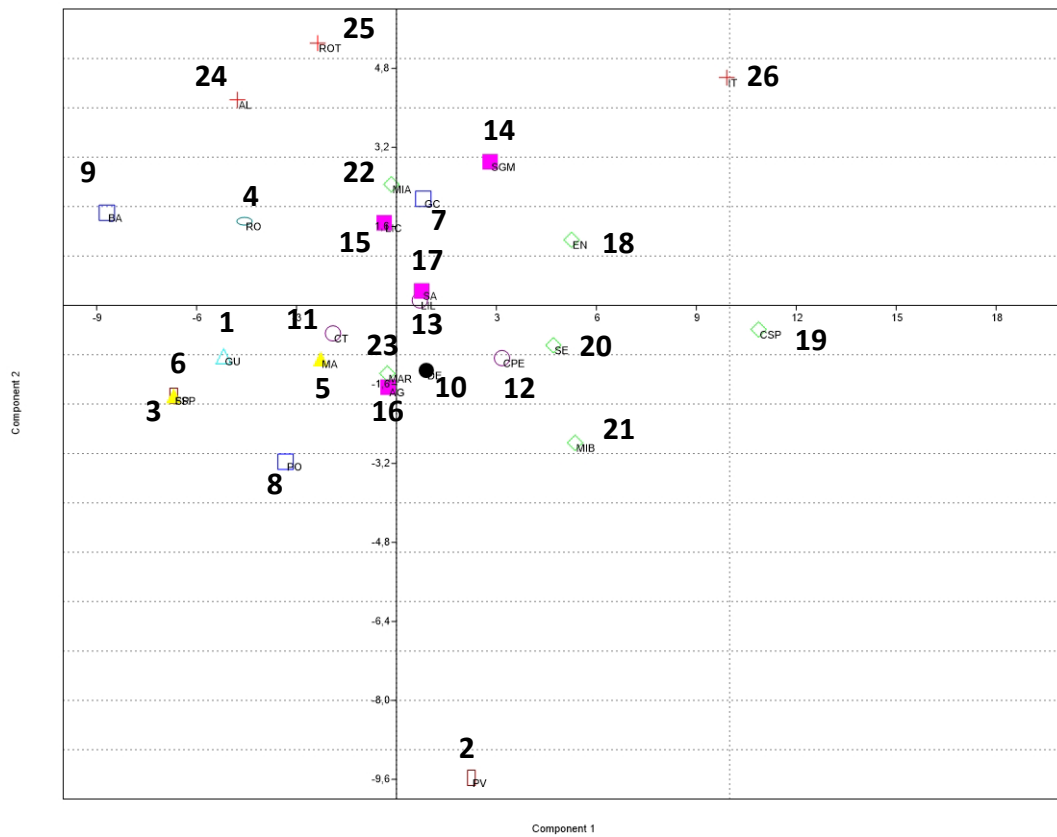

Fig. 3.36 PC1vs PC2 Stature-Populations

- ▲ Mesolithic - ■ Neolithic - ○ Eneolithic - * Copper - ▲ Bronze - □ Bronze/Iron
 - ● Iron - ○ Antiquity - ■ Late Antiquity - ◇ Middle Ages - + Contemporary Age

- 1 Grotta dell'Uzzo (CU)
- 2 Piano Vento (PV)
- 3 Fossato Stretto Partanna (FSP)
- 4 Roccazzello (RO)
- 5 Marcita (MA)
- 6 Sretto Partanna (SP)
- 7 Grotta Chiusilla (CC)
- 8 Polizzello (PO)
- 9 Baucina (BA)
- 10 Desueri (DE)
- 11 Caserma Tukory (TU)
- 12 Contrada Petraro Entella (CPE)
- 13 Lilibeo (LIL)
- 14 San Giovanni Marsala (SGM)
- 15 Licata (LIC)
- 16 Agrigento (AG)
- 17 Sant'Agata (SA)
- 18 Entella (EN)
- 19 Castel san Pietro (CSP)
- 20 Segesta (SE)
- 21 Monte lato A (MIA)
- 22 Monte lato B (MIB)
- 23 Monte Maranfusa (MAR)
- 24 Alia (AL)
- 25 Rotoli (ROT)
- 26 Contemporary Italian (IT)

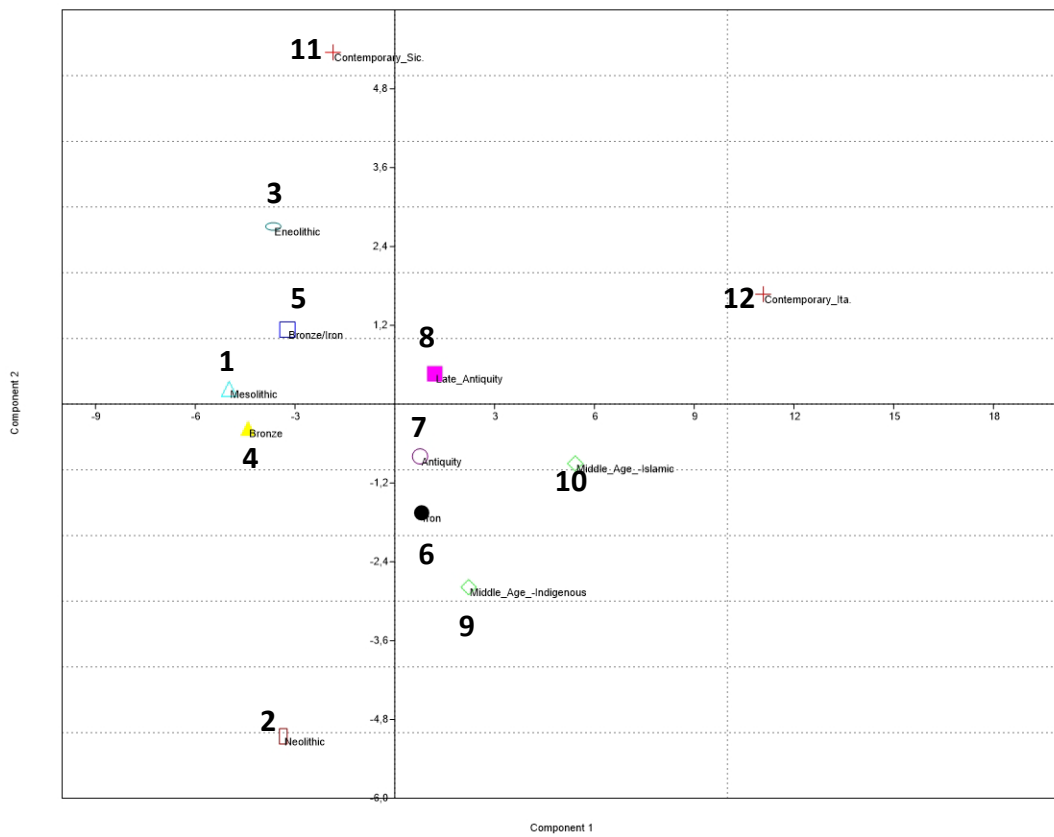

Fig. 3.37 PC1vs PC2 Stature-Age

- Δ Mesolithic - \square Neolithic - \circ Eneolithic - *Copper - Δ Bronze - \square Bronze/Iron
 - \bullet Iron - \circ Antiquity - \blacksquare Late Antiquity - \diamond Middle Ages - $+$ Contemporary Age

- 1 Mesolithic
- 2 Neolithic
- 3 Eneolithic
- 4 Bronze
- 5 Bronze/Iron
- 6 Iron
- 7 Antiquity
- 8 Late Antiquity
- 9 Middle Ages Indigenus
- 10 Middle Ages Islamic
- 11 Contemporary Sicily
- 12 Contemporary Italy

4. Conclusion

Our work denotes the reliability of the methods employed underlying as in a study of biodiversity several characters are indispensable to understand the evolution through the ages. Data also provided to demonstrate the correlation between the morphological characters and the influence carried (not only by the environmental factors) by the human flow on the phenotype.

Results, besides, clearly shows as all the characters evaluated are at the same time involved in the same process of diversification.

Morphological variations show a general decrease of Maxilla Prognathism and a soft Mesocephalization with the skull that becomes tighter and slightly and less elongated and the face that become wider and shorter.

Always considering simple size/composition both Canonical and Multivariate Statistics Analysis display, as the Upper-Paleolithic Würm-Settlers of San Teodoro could reasonably be the first evidence of human colonization in Sicily. This theory is supported by the Mesolithic Hunter-Gatherers specimens that clustered separated from the first one.

Meaningful is the periods of Bronze/Iron transition in we assist to the prime plainness of morphological changes (teeth, skulls and statures) due to the constant and numerically significant "Migratory Flows".

This variation exactly coincides with the first "Population Influx" consequent of the human migrations from the continent.

Instead, Protohistorical samples of some populations, keep some archaic characters after Iron Age (Historical Era) the “Population Continuity” (consequent of the cohabitation and alternations of the several Mediterranean populations) from Antiquity to Middle Ages produced a progressive increase of variability without big variation among Eigenvalue and Principal Component.

The absence of internal relationship caused by the intricate colonization period is on the contrary present on Prehistorical sample on which we can find a clear variation between the PC.

Correlations between “Population Influx” and Variability are observable on the the influence of Islamic settlers on the Indigenous during the Middle Ages. However the wide variability and the homogenous morphospace showed by these groups and the Contemporary resulted in no well-defined populations.

The results reported here underline evident distances and similarities among the Sicilian populations.

We remark:

- Distances between the presumed founders of San Teodoro (that kept morphological affinities with other European contemporaneous) and all the latter specimens (included the Mesolithic).
- Distances between Bronze and Bronze/Iron transition groups and both the other Prehistorical and Historical one.

- Wide variability produced during Antiquity, Late Antiquity and Middle Ages by settlers coming from different Mediterranean geographical areas.

The timing of the peopling of Sicily is a subject of continuing debate.

The interpretation shown in the present study is based on the analysis of skeletal findings available by excavations and institutions permits.

All the data were compared with previous studies on the field of physical anthropology, paleo-ecology, history and archaeology.

Further discoveries and licences by the local institution (on materials already excavated) will help to increase the issues discussed before.

Moreover, results will be compared with future genetic data available in the next years.

Bibliography

A

- Adams, D. C., & Collyer, M. L. (2009). "A general framework for the analysis of phenotypic trajectories in evolutionary studies". *Evolution*, 63, 1143_1154.
- Adams, D. C., & Nistri, A. (2010). "Ontogenetic convergence and evolution of foot morphology in European cave salamanders (Family: Plethodontidae)". *BMC Evolutionary Biology*, 10.
- Anderson, T. W. (1958). "*An introduction to multivariate analysis*". New York: Wiley.
- Anderson, M. J. (2001a). "A new method for non-parametric multivariate analysis of variance". *Austral Ecology*, 26, 32_46.
- Anderson, M. J. (2001b). "Permutation tests for univariate or multivariate analysis of variance and regression". *Canadian Journal of Fisheries and Aquatic Sciences*, 58, 626_639.
- Anderson, M. J. (2006). "Distance-based tests for homogeneity of multivariate dispersions". *Biometrics*, 62, 245_253.
- Anderson, M. J., & Robinson, J. (2001). "Permutation tests for linear models". *Australian & New Zealand Journal of Statistics*, 43, 75_88.

- Anderson, M. J., & Ter Braak, C. J. F. (2003). "Permutation tests for multi-factorial analysis of variance". *Journal of Statistical Computation and Simulation*, 73, 85_113.
- Andrews, P., & Williams, D. B. (1973). "The use of principal components analysis in physical anthropology". *American Journal of Physical Anthropology*, 39(2), 291-303.
- Anstey, R. L., & Pachut, J. F. (1995). "*Phylogeny, diversity history, and speciation in Paleozoic Bryozoans*". In D. H. Erwin, & R. L. Anstey (Eds.), *New approaches to speciation in the fossil record* (pp. 239_284). Columbia University Press.
- Anton, S.C., Jaslow, C.R., Swartz, S.M. (1992) "Sutural complexity in artificially deformed human (*Homo sapiens*) crania". *J Morphol*, 214:321–332.
- Arendt, J. (2010). "Morphological correlates of sprint swimming speed in five species of spadefoot toad tadpoles: Comparison of morphometric methods". *Journal of Morphology*, 271, 1044_1052.
- Aiello, L., & Dean, C. (1990). '*An introduction to human evolutionary anatomy*'. Academic Press.
- Albrecht, G. (1978). "Some comments on the use of ratios". *Systematic Zoology*, 27, 67_71.
- Albright, R.G., Nelson, E.M. (1958). "Cranial kinetics of the generalized colubrid snake *Elaphe obsoleta quadrivittata*". *J Morphol*, 105:193–291.

- Angielczyk, K. D., & Sheets, H. D. (2007). "Investigation of simulated tectonic deformation in fossils using geometric morphometrics". *Paleobiology*, 33, 125_148.
- Arif, S., Adams, D. C., & Wicknick, J. A. (2007). "Bioclimatic modelling, morphology, and behaviour reveal alternative mechanisms regulating the distributions of two parapatric salamander species". *Evolutionary Ecology Research*, 9, 843_854.
- Arnold WH, Sperber GH, Machin GA. (1998). "Cranio-facial skeletal development in three human synophthalmic holoprosencephalic fetuses". *Anat Anz*, 180:45–53.
- Atchley, W. R., & Anderson, D. (1978). "Ratios and the statistical analysis of biological data". *Systematic Zoology*, 27,71_78.
- Atchley, W. R., Gaskins, C. T., & Anderson, D. (1976). "Statistical properties of ratios". I. Empirical results. *Systematic Zoology*, 25, 137_148.
- Atchley, W. R., Plummer, A. A., & Riska, B. (1985). "Genetics of mandible form in the mouse". *Genetics*, 111, 555_577.
- Atchley, W. R., & Hall, B. K. (1991). "A model for development and evolution of complex morphological structures". *Biological Reviews of the Cambridge Philosophical Society*, 66(2), 101_157.
- Alcamo, I. E. (2012). "Anatomy coloring workbook". Princeton Review.

- Alt, K. W., Brace, C. L., & Türp, J. C. (1998). ‘‘The history of dental anthropology’’. In *Dental Anthropology* (pp. 15-39). Springer, Vienna.
- Alvesalo, L. (1971). ‘‘The influence of sex-chromosome genes on tooth size in man’’. *Suomen Hamm. Euran. Toim.*, 67, 3-54.

B

- Baab, K. L., Freidline, S. E., Wang, S. L., & Hanson, T. (2010). ‘‘Relationship of cranial robusticity to cranial form, geography and climate in Homo sapiens’’. *American Journal of Physical Anthropology: The Official Publication of the American Association of Physical Anthropologists*, 141(1), 97-115.
- Barberini, F., Bruner, E., Cartolari, R., Franchitto, G., Heyn, R., Ricci, F., & Manzi, G. (2008). ‘‘An unusually-wide human bregmatic Wormian bone: anatomy, tomographic description, and possible significance’’. *Surgical and radiologic anatomy*, 30(8), 683.
- Barker, M., & Rayens, W. (2003). Partial least squares for discrimination. *Journal of Chemometrics*, 17, 166_173.
- Barrow, E., & Macleod, N. (2008). ‘‘Shape variation in the mole dentary (Talpidae :Mammalia)’’. *Zoological Journal of the Linnean Society*, 153, 187_211.
- Bartlett, M. S. (1947). ‘‘Multivariate analysis’’. *Journal of the Royal Statistical Society, Series B*, 9, 176_197.
- Bastir, M., & Rosas, A. (2004). ‘‘Comparative ontogeny in humans and chimpanzees: Similarities, differences and paradoxes in postnatal growth and

development of the skull”. *Annals of Anatomy-Anatomischer Anzeiger*, 186, 503_509.

- Bastir, M., & Rosas, A. (2005). “Hierarchical nature of morphological integration and modularity in the human posterior face”. *American Journal of Physical Anthropology*, 128, 26_34.

- Bastir, M., Rosas, A., & Sheets, H. D. (2005). “*The morphological integration of the hominoid skull: A partial least squares and PC analysis with morphogenetic implications for European mid-pleistocene mandibles*”. In D. Slice (Ed.), *Modern morphometrics in physical anthropology* (pp. 265_284). New York: Kluwever Academic/Plenum Publishers.

- Bastir, M., & Rosas, A. (2006). “Correlated variation between the lateral basicranium and the face: A geometric morphometric study in different human groups”. *Archives of Oral Biology*, 51, 814_824.

- Bastir, M., O’Higgins, P., & Rosas, A. (2007).” Facial ontogeny in Neanderthals and modern humans”. *Proceedings of the Royal Society B-Biological Sciences*, 274, 1125_1132.

- Bastir, M., Sobral, P. G., Kuroe, K., & Rosas, A. (2008). “Human craniofacial sphericity: A simultaneous analysis of frontal and lateral cephalograms of a Japanese population using geometric morphometrics and partial least squares analysis”. *Archives of Oral Biology*, 53, 295_303.

- Bechtold, B., Frey-Kupper, S., Madella, M., & Brugnone, A. (1999). “*La necropoli di Lilybaeum*”. L’Erma di Bretschneider.

- Becker, M. J. (1985). ‘‘Metric and non-metric data from a series of skulls from mozia, sicily and a related site’’. *Antropologia Contemporanea*, 8(3), 211.
- Becker, M. J. (1995). ‘‘Human Skeletal Remains from Recent Excavations in Various Aresa of the Lilibeo Necropolis at Marsala, Sicily: an analysis of skeleton from the excavations at the Via Cattaneo, Corso De Gasperi and Via Berta. Appendix II of the Bechtold necropolis report’’. *Annali delta Scuola Normale Superiore di Pisa DANIMS*, 25(1-2), 118-187.
- Becker M.J. (1995) ‘‘Skeletal studies of Sicilian populations. A survey’’. *The journal of the Accordia Research Institute* Volume 6, 83-117.
- Becker, M. J. (1995). ‘‘A revised interpretation of the function of la Grotta del Vecchiuzzo near Petralia Sottana and the Grotta dei Cocci at Capaci (Palermo, Sicily) during the Late Neolithic or Early Copper Age based on the analysis of the human remains.’’ *Sicilia archeologica*, 28(87-89), 7-17.
- Becker, M. J. (1998). ‘‘Identifying an 8th-7th century BC Cemetery at Mozia, Sicily: Evaulation of redeposited human skeletal remains to test an archaeological hypothesis’’. *Sicilia archeologica*, 31(Fasc. 96), 7-12.
- Becker, M. J. (2000). ‘‘Skeletal studies of the people of Sicily: an update on research into human remains from archaeological contexts’’. *International Journal of Anthropology*, 15(3-4), 191-239.
- Bellomo, G. (2016). ‘‘Analisi dei marcatori scheletrici di stress occupazionale (MOS) in una popolazione indigena Siciliana (Baucina, PA)’’. Dissertation thesis of Master degree in Natural and Environmental Sciences – University of Palermo.

- Belvedere, O., Burgio, A., Bordonaro, G., & Forgia, V. (2017). ‘‘Baucina (Pa)–Monte Falcone 2014 Indagini nella necropoli’’. *FOLD&R FastiOnLine documents & research*, (380), 1-7.
- de Beer, G. (1985). *‘‘The Development of the Vertebrate Skull’’*. Chicago, University of Chicago Press.
- Bemis, W.E. (1986). ‘‘Feeding Systems of Living Dipnoi: Anatomy and Function’’. *J Morphol Suppl*, 1: 249–275.
- Bemis, W.E., Lauder, G.V (1986). ‘‘Morphology and function of the feeding apparatus of the lungfish, *Lepidosiren paradoxa* (Dipnoi)’’. *J Morphol*, 187:81–108.
- Benitez-Vieyra, S., Medina, A. M., & Cocucci, A. A. (2009). ‘‘Variable selection patterns on the labellum shape of *Geoblasta pennicillata*, a sexually deceptive orchid’’. *Journal of Evolutionary Biology*, 22, 2354_2362.
- Betti, L., Balloux, F., Amos, W., Hanihara, T., & Manica, A. (2009). ‘‘Distance from Africa, not climate, explains within-population phenotypic diversity in humans’’. *Proceedings of the Royal Society B: Biological Sciences*, 276(1658), 809-814.
- Boas F. (1928) *‘‘Anthropology and Modern Life’’* (2004 ed.) ISBN 978-0-7658-0535-5.
- Boas F. (1940) *‘‘Race, Language, and Culture’’* ISBN 978-0-226-06241-9.
- Boas F. (1945) *‘‘Race and Democratic Society’’*, New York, Augustin.

- Bonfiglio, L., Mangano, G., Marra, A., & Masini, F. (2001). ‘‘A new late Pleistocene vertebrate faunal complex from Sicily (S. Teodoro Cave, north-eastern Sicily, Italy)’’. *Bollettino della Società Paleontologica Italiana*, 40(2), 149-158.
- Bonfiglio, L., Marra, A. C., Masini, F., & Petruso, D. (2001). ‘‘Depositi a vertebrati e ambienti costieri pleistocenici della Sicilia e della Calabria meridionale’’. *Biogeographia–The Journal of Integrative Biogeography*, 22(1).
- Bookstein, F. L. (1982). ‘‘The geometric meaning of soft modeling, with some generalizations’’. In K. G. Joˆreskog, & H. Wold (Eds.), *Systems under indirect observation: causality, structure, prediction* (pp. 55_74). New York: North Holland Publishing Co.
- Bookstein, F. L., Chernoff, B. L., Elder, R. L., Humphries, J. M., Jr., Smith, G. R., & Strauss, R. E. (1985). ‘‘*Morphometrics in evolutionary biology*’’. Philadelphia: The Academy of Natural Sciences Philadelphia.
- Bookstein, F. L. (1989). ‘‘Size and shape’’: A comment on semantics. *Systematic Zoology*, 38, 173_190.
- Bookstein, F. L. (1991). ‘‘*Morphometric tools for landmark data: Geometry and biology*’’. Cambridge: Cambridge University Press.
- Bookstein F. (1996) ‘‘*Morphometric tools for landmark data Geometry and Biology*’’. Cambridge University Press. 434

- Bookstein, F. L., Streissguth, A. P., Sampson, P. D., Connor, P. D., & Barr, H. M. (2002). "Corpus callosum shape and neuropsychological deficits in adult males with heavy fetal alcohol exposure". *Neuroimage*, 15, 233_251.pp.
- Bookstein, F. L., Gunz, P., & Ingeborg, H., et al. (2003). "Cranial integration in Homo: Singular warps analysis of the midsagittal plane in ontogeny and evolution". *Journal of Human Evolution*, 44, 167_187.
- Borgognini, S. M., & Repetto, T. E. (1986). "Skeletal indicators of subsistence patterns and activity régime in the Mesolithic sample from Grotta dell'Uzzo (Trapani, Sicily): a case study". *Human Evolution*, 1(4), 331-351.
- Borgognini Tarli, S., Canci, A., Piperno, M., & Repetto, E. (1993). "Dati archeologici e antropologici sulle sepolture mesolitiche della Grotta dell'Uzzo (Trapani)". *Bullettino di Paleontologia Italiana*, 84, 85-179.
- Bowers, C. M. (2006). "Problem-based analysis of bitemark misidentifications: The role of DNA". *Forensic Science International*, 159S, S104_109.
- Boyde, A. (1964). "*The structure and development of mammalian enamel*". (Doctoral dissertation).
- Boyde, A. (1968). "Correlation of ameloblast size with enamel prism pattern: use of scanning electron microscope to make surface area measurements". *Zeitschrift für Zellforschung und Mikroskopische Anatomie*, 93(4), 583-593.
- Boyde, A. (1976). "*Amelogenesis and the development of teeth*". *Scientific Foundation of Dentistry*". B. Choen and I. R. H. Kramer ed, London.

- Boyde, A. (1989). ‘‘ Enamel. Handbook of pf microscopy anatomy’’. V/6, Teeth-Berlin.
- Brace C. L., Mahler P.E. (1971). ‘‘ Post-Pleistocene changes in human dentition’’. *American Journal of Physical Anthropology* XXXIV.
- Bradley, J.P., Levine, J.P., Roth, D.A., McCarthy, J.G., Longaker, M.T. (1996). ‘‘Studies in cranial suture biology. IV. Temporal sequence of posterior frontal cranial suture fusion in the mouse’’. *Plast Reconstr Sur*, 1039–1045.
- Bradfield, J., Hoffman, J., & De Beer, F. (2016). ‘‘Verifying the potential of micro-focus X-ray computed tomography in the study of ancient bone tool function’’. *Journal of Archaeological Science: Reports*, 5, 80-84.
- Brea, L. B., & Cavalier, M. (1965). ‘‘Meligunìs Lipàra: La necropoli greca e romana nella contrada Diana (Vol. 2)’’. Flaccovio.
- Brea, L. B. (2016). ‘‘La Sicilia prima dei greci’’. Il saggiatore.
- Brickley, M. & Ives, R. (2010). ‘‘The bioarchaeology of metabolic bone disease’’. Academic Press. 220 pp.
- Broca, P. (1861). ‘‘Perte de la parole, ramollissement chronique et destruction partielle du lobe antérieur gauche du cerveau’’. *Bull Soc Anthropol*, 2(1), 235-238.
- Bronstein, A. M., Bronstein, M. M., & Kimmel, R. (2006). ‘‘Generalized multidimensional scaling: a framework for isometry-invariant partial surface matching’’. *Proceedings of the National Academy of Sciences*, 103(5), 1168-1172.

- Brothwell, D. R. (1981). *‘Digging up bones’*. Cornell University Press. Ithaca New York.
- Brothwell, D. R. (2014). ‘Dental Anthropology’. Volume V: *Society for the Study of Human Biology* (Vol. 5). Elsevier.
- Bruner, E., Manzi, G., & Passarello, P. (2002). ‘The virtual endocast of saccopastore 1’. General morphology and preliminary comparisons by geometric morphometrics. *BAR International series*, 1049, 17-24.
- Bruner, E., & Manzi, G. (2003). ‘Towards a re-appraisal of the Early Neolithic skeleton from Lama dei Peligni (Abruzzo, Italy). Computed tomography and 3D reconstruction of the cranium’. *Rivista di Antropologia*, 81, 69-78.
- Bruner, E. (2004). ‘Tomografia Computerizzata e Elaborazione di Immagini: Modelli Virtuali per l’Antropologia’. *Atti del Convegno: Lo studio delle Ossa: metodologie della Medicina e dell’Antropologia*. Università degli Studi dell’Insubria. 27 Marzo 2004.
- Bruner, E. (2004). ‘Variability in facial size and shape among North and East African human populations’. *Ital. J. Zool.*, 71: 51-56.
- Bruner, E. (2004). ‘Geometric morphometrics and paleoneurology: brain shape evolution in the genus Homo’. *Journal of Human Evolution*, 47(5), 279-303.
- Bruner, E., & Manzi, G. (2004). ‘Variability in facial size and shape among North and East African human populations’. *Italian Journal of Zoology*, 71(1), 51-56.

- Bruner, E., Saracino, B., Ricci, F., Tafuri, M., Passarello, P., & Manzi, G. (2004). "Midsagittal cranial shape variation in the genus Homo by geometric morphometrics". *Collegium antropologicum*, 28(1), 99-112.
- Bruner, E., & Manzi, G. (2005). "CT-based description and phyletic evaluation of the archaic human calvarium from Ceprano, Italy". *The Anatomical Record Part A: Discoveries in Molecular, Cellular, and Evolutionary Biology: An Official Publication of the American Association of Anatomists*, 285(1), 643-657.
- Bruner, E., & Manzi, G. (2006). "Digital tools for the preservation of the human fossil heritage: Ceprano, Saccopastore, and other case studies". *Human Evolution*, 21(1), 33-44.
- Bruner, E., Manzi, G., Holloway, R. (2006). "Krapina and Saccopastore: endocranial morphology in the pre-Wurmian Europeans". *Periodicum Biologorum*, 108, 433-441.
- Bruner, E. (2007). "Cranial shape and size variation in human evolution: structural and functional perspectives". *Child's Nervous System*, 23(12), 1357-1365.
- Bruner, E., & Jeffery, N. (2007). "Extracting functional, phylogenetic and structural data from the subcortical brain: an exploratory geometric morphometric survey". *J Anthropol Sci*, 85, 125-138.
- Bruner, E., & Ripani, M. (2008). "A quantitative and descriptive approach to morphological variation of the endocranial base in modern humans". *American*

Journal of Physical Anthropology: The Official Publication of the American Association of Physical Anthropologists, 137(1), 30-40.

- Bruner, E. (2009). "New tools and old perspectives in the management of the fossil resources". *Journal of Anthropological Sciences*, 87, 227-228.

- Bruner E. (2013). "The Species Concept as a Cognitive Tool for Biological Anthropology". *American Journal of Primatology* 75:10–15.

- Bruner, E., Averini, M., & Manzi, G. (2020). "Endocranial traits. Prevalence and distribution in a recent human population". *European Journal of Anatomy*, 7(1), 23-33.

- Bruzek J. (2002) "A method for visual determination of sex, using the human hipbone". *American Journal of Physical Anthropology* 117, pp.117-157.

- Buikstra J. & Ubelaker D. H. (1994) "Standards for human collection from human skeletal remains" *Arkansas Archeological Survey Research Series* NO.44.

- Burgio, E., Costanza, M., & Di Patti, C. (2002). "I depositi a vertebrati continentali del Pleistocene della Sicilia occidentale". *Naturalista Siciliano*, 26(3/4), 229-282.

- Bush, M. A., Bush, P. J., & Sheets, H. D. (2011). "A study of multiple bitemarks inflicted in human skin by a single dentition using geometric morphometrics". *Forensic Science International*, 211, 1_8.

- Bjork, A. (1966) "Sutural growth of the upper face studied by the implant method". *Acta Odontol Scand*, 24:109–127.

- Bjork, A., Skieller, V. (1977) "Growth of the maxilla in three dimensions as revealed radiographically by the implant method". *Br J Orthod* , 4:53–64.

C

- Campbell, N. A., & Atchley, W. R. (1981). "The geometry of canonical variates analysis". *Systematic Zoology*, 30, 268_280.

- Camper, P. (1782). 'De l'orang-outang et de quelques autres espèces de singes, dans *Œuvres de Pierre Camper, qui ont pour objet l'histoire naturelle, la physiologie et l'anatomie comparée*'. Bertrand-chez Melon et Cie, 1, 89.

- Canci, A., & Minozzi, S. (2005). "Archeologia dei resti umani: dallo scavo al laboratorio". Carocci ed.

- Cangelosi, A., & Di Patti, C. (2005). "I vertebrati fossili della Grotta di San Ciro (Palermo). informatizzazione di una collezione storico-naturalistica Fossil vertebrates in St. Ciro cave (Palermo). How a historical naturalistic collection was made suitable for a museum". *Quaderni del Museo Geologico Gemellaro Volume*, 8, 75-81.

- Cangelosi E. O. (2017). "Analisi antropologica dei resti inumati rinvenuti nell'ipogeo settore G di Licata (AG)". Dissertation thesis of Master degree in Natural and Environmental Sciences – University of Palermo.

- Carlson, B. M. (1999). "Establishment of the basic embryonic body plan. *Human Embryology and Developmental Biology*". 2nd ed. Mosby, Inc USA, 75.

- Carlson, B.M. (1999). *“Human embryology and developmental biology”*. 2nd ed. St. Louis: Mosby Yearbook.
- Carroll, R. L. (1988). *“Vertebrate palaeontology and evolution”*. W.H. Freeman & C. Ed.
- Castellana, G., & Mallegni, F. (1986). “The Prehistoric Settlement of Piano Vento in the Territory of Palma di Montechiaro (Agrigento, Italy)”. *Archivio per l'Antropologia e la Etnologia* – Vol. CXVI.
- Castellana, G. (1992). *“Dagli scavi di Montevago e di Rocca di Entella, un contributo di conoscenze per la storia dei musulmani della Valle del Belice dal X al XIII secolo: atti del convegno Nazionale”*. Comune di Montevago.
- Caumul, R., & Polly, P. D. (2005). “Phylogenetic and environmental components of morphological variation: Skull, mandible, and molar shape in marmots (Marmota, Rodentia)”. *Evolution*, 59, 2460_2472.
- Cavalier, M. (1995). “New Greek and Roman discoveries from Lipari”. *Mediterranean Archaeology*, 83-88.
- Cazzella, A., & Maniscalco, L. (2012). “L’età del Rame in Sicilia”. *Atti della XLI Riunione Scientifica dell’Istituto Italiano di Preistoria e Protostoria*, 81-104.
- Cesare, S. (2018). *“La Necropoli antistante il Tempio della Concordia: Valutazione Antropologica”*. Dissertation thesis of Master degree in Natural and Environmental Sciences – University of Palermo.

- Chodoronek, M. (2015). “The Use and Application of Photogrammetry for the In-field Documentation of Archaeological Features: Three Case Studies from the Great Plains and Southeastern Alaska”.
- Calude J. (2013). “Log-shape ratios, Procrustes superimposition, elliptic Fourier analysis: three worked examples in R”. *Virtual Morphology and Evolutionary Morphometrics in the new millenium.*, 94.
- Clauset, A., Shalizi, C. R., & Newman, M. E. (2009). “Power-law distributions in empirical data”. *SIAM review*, 51(4), 661-703.
- Costantini, L. (1989). “Plant exploitation at Grotta dell'Uzzo, Sicily: new evidence for the transition from Mesolithic to Neolithic subsistence in southern Europe”.
- Conte, L., Ingoglia, A. K., Martin, A. M. L., & Riolo, L. (2007). “Il culto dell'acqua e la civiltà dei fossati nel territorio di Partanna (Trapani)”. *Annali dell'Università degli Studi di Ferrara ISSN, 1824, 2707*.
- Cussenot, O., Zouaoui. A., Hidden, G. (1990). “Growth of the facial bones of the fetus”. *Surg Radiol Anat*, 12:230–1.
- Chatfield, C., & Collins, A. J. (1980). “*Introduction to multivariate analysis*”. London: Chapman & Hall.
- Chapman, R.E. (1990). “*Conventional Procrustes methods*”. In F. J. Rohlf, & F. Bookstein (Eds.), *Proceedings of the Michigan Morphometrics Workshop* (pp. 251_267). Ann Arbor: University of Michigan Museum of Zoology.

- Cheverud, J. M., Hartman, S. E., Richtsmeier, J. T., & Atchley, W. R. (1991). "A quantitative genetic analysis of localized morphology in mandibles of inbred mice using finite-element scaling analysis". *Journal of Craniofacial Genetics and Developmental Biology*, 11, 122_137.
- Chilardi, S. Galdi. A. (2012). " Il Neolitico siciliano tra caccia e raccolta, tradizione e innovazione: la fauna delle UUSS 1-16 del fossato di Contrada Stretto/Partanna (TP)". *Atti della XLI Riunione Scientifica dell'Istituto Italiano di Preistoria e Protostoria" Dai Ciclopi agli Ecisti. Società e territorio nella Sicilia preistorica e protostorica"(San Cipirrello, Palermo 2006)*, 1121-1125.
- Chimal-Monroy, J., Diaz de Leon, L. (1999). "Expression of N-cadherin, N-CAM, fibronectin and tenascin is stimulated by TGF-beta1, beta2, beta3 and beta5 during the formation of precartilage condensations". *Int J Dev Biol*, 43:59–67.
- Claude, J. (2008). "*Morphometrics*". R. New York: Springer.
- Claverie, T., Chan, E., & Patek, S. N. (2011). "Modularity and scaling in fast movements: Power amplification in mantis shrimp". *Evolution*, 65, 443_461.
- Costa, C., Aguzzi, J., Menesatti, P., Antonucci, F., Rimatori, V., & Mattoccia, M. (2008). "Shape analysis of different populations of clams in relation to their geographical structure". *Journal of Zoology*, 276, 71_80.
- Corner, B. D., Lele, S., & Richtsmeier, J. T. (1992). "Measuring precision of three-dimensional landmark data". *Journal of Quantitative Anthropology*, 3, 347_359.

- Corruccini, R. S. (1977). "Correlation properties of morphometric ratios". *Systematic Zoology*, 26, 211_214.

- Coppa, A., Rubini M. (1996). "Atlante dei caratteri discontinui". Sopr. Arch. Lazio.

- Cramon-Taubadel von, N., Frazier, B. C., & Lahr, M. M. (2007). "The problem of assessing landmark error in geometric morphometrics: theory, methods, and modifications". *American Journal of Physical Anthropology: The Official Publication of the American Association of Physical Anthropologists*, 134(1), 24-35.

- Cramon-Taubadel von, N., & Weaver, T. D. (2009). "Insights from a quantitative genetic approach to human morphological evolution". *Evolutionary Anthropology: Issues, News, and Reviews: Issues, News, and Reviews*, 18(6), 237-240.

- Cramon-Taubadel von, N. (2011). "The relative efficacy of functional and developmental cranial modules for reconstructing global human population history". *American journal of physical anthropology*, 146(1), 83-93.

- Cramon-Taubadel von, N. (2014). "Evolutionary insights into global patterns of human cranial diversity: population history, climatic and dietary effects". *J. Anthropol. Sci*, 92(4).

- Cramon-Taubadel von, N., Strauss, A., & Hubbe, M. (2016). "Evolutionary population history of early Paleoamerican cranial morphology". *Science advances*, 3(2), e1602289.

- Creuzet, S., Schuler, B., Couly, G., Le Douarin, N.M. (1993). “Reciprocal relationships between Fgf8 and neural crest cells in facial and forebrain development”. *Proc Natl Acad Sci USA*, 101:4843–4847.
- Cunningham, C., Scheuer, L., & Black, S. (2016). “*Developmental juvenile osteology*”. Academic Press.
- Cunzolo, V. (2018). “*Analisi paleopatologica dei resti scheletrici della necropoli indigena di Baucina (IV Secolo a.C.)*”. Dissertation thesis of Master degree in Natural and Environmental Sciences – University of Palermo.
- Curnoe, D., & Thorne, A. (2006). “Human origins in Australia: the skeletal evidence”. *Before Farming*, 2006(1), 1-28.

D

- D'Amore G., Di Marco S., Tartarelli G., Bigazzi R., & Sineo L. (2009). “Late Pleistocene human evolution in Sicily: comparative morphometric analysis of Grotta di San Teodoro craniofacial remains”. *Journal of human evolution*, 56(6), 537-550.
- D'Amore G., Di Marco S., Floris G., Pacciani E., Sanna E. (2010) “Craniofacial morphometric variation of the peopling of Sardinia”. *HOMO Journal of Comparative Human Biology*, 61(6), 385-412.
- D'Amore G., Di Marco S., Di Salvo R., Messina A., & Sineo, L. (2010). “Early human peopling of Sicily: Evidence from the Mesolithic skeletal remains from Grotta d'Oriente”. *Annals of human biology*, 37(3), 403-426.

- Darwin C. (1859) “ *The Origin of Species* ” John Murray Editor. London: Albemarle Street.
- Darwin C. (1871) “ *The Descent of Man* ”. John Murray Editor. London: Albemarle Street.
- Daubenton, L. J. M. (1764). “ *Mémoire sur les differences de la situation du grand trou occipal dans l'homme et dans les animaux* ”.
- Davis, J. C., & Sampson, R. J. (1986). “ *Statistics and data analysis in geology (Vol. 646)* ”. New York: Wiley.
- Dietrich, Feil; Stephan J., Ludwig; Nicole, Mölk: Die mittelalterlichen Münzen der Kampagnen 2011-2015 - Ein Überblick. In: Baur, Christoph: Ausgraben - Dokumentieren - Präsentieren. Jahresbericht des Instituts für Archäologien 2015. Innsbruck: Leopold-Franzens-Universität, S. 30-31.
- Di Salvo, R. (1984). “ *Studio antropologico e paleopatologico di resti scheletrici umani rinvenuti nella necropoli ellenistico-romana di Marsala (Trapani)* ”. *Archivio per la Antropologia e la Etnologia – CXIV*.
- Di Salvo, R. (1987). “ *Gli inumati di Manuzza-Selinunte (Trapani) (IV-III sec. a.C.)* ”. *Archivio per la Antropologia e la Etnologia – Vol. CXVII*.
- Di Salvo, R. (1991). “ *Tre resti cranici da Marcita* ”. *Archivio per l'antropologia e l'etnologia – Vol. CXXII*.
- Di Salvo, R., Germanà, F., Tusa, S. (1998). “ *Uomini e Culture della Sicilia Preistorica* ”. Gaia editrice.

- Di Salvo, R. (2004). ‘‘I Musulmani della Sicilia occidentale: aspetti antropologici e paleopatologici’’. *Mélanges de l'école française de Rome Année 2004* 116-1 pp. 389-408 .

- Di Salvo, R., Schimmenti, V. (2006). XLI - Atti della Riunione Scientifica, Istituto Italiano di Preistoria e Protostoria - San Cipirrello (PA) 16-19 novembre 2006.

- Di Salvo, R., Schimmenti, V., Mannino, M., Caramelli, D., LALUEZA-FOW, C., Messina, A., ... & Sineo, L. (2007). ‘‘Ecologia, morfometria e genetica dei reperti paleomesolitici di Grotta D'Oriente (Favignana, TP)’’. In *Atti XVII Congresso degli Antropologi Italiani ‘‘Mediterraneo, crocevia di popoli e culture. Processi microevolutivi delle popolazioni umane* (pp. 52-53).

- Di Salvo, R., Schimmenti, V. (2008). ‘‘Gli inumati della necropoli di San Agata – Piana degli Albanesi (Palermo) di età tardo romana (IV-V sec. d.C.). studio antropologico e paleopatologico’’. *Archivio per la Antropologia e la Etnologia – Vol. CXXXVIII*.

- Di Salvo, R., Schimmenti, V., Messina A. (2008). ‘‘Nota paleobiologia degli inumati del cimitero sub divo si S. Giovanni – Marsala (Trapani-Sicilia) di età paleocristiana (III-IV sec. d.C.). *Archivio per la Antropologia e la Etnologia – Vol. CXXXVIII*.

- Di Salvo, R., Mannino, G., Mannino, M. A., Schimmenti, V., & Sineo, L. (2012). ‘‘Le sepolture della Grotta d'Oriente (Favignana)’’. *Le sepolture della Grotta d'Oriente (Favignana)*, 341-351.

- Di Stefano, C. A., Andaloro, M., & Sicilia. Assessorato dei beni culturali e ambientali e della pubblica istruzione. (1995). “*Federico e la Sicilia: dalla terra alla corona*”. A. Lombardi.
- Di Stefano, C. A. (1995). “Ricerche archeologiche a Palermo”. *FANTAR (MH) et G HAKI M., Actes du III e Congrès International des Etudes Phéniciennes et Puniquees (2 vol.), I(1), 1995.*
- Di Stefano, C. A. & Cadei A. (1997). “*Federico e la Sicilia. Dalla terra alla corona*”. Ediprint.
- Di Stefano, C. A. (1998). “*Palermo punica*”. Sellerio.
- Debat, V., Debelle, A., & Dworkin, I. (2009). “Plasticity, canalization, and developmental stability of the Drosophila wing: Joint effects of mutations and developmental temperature”. *Evolution*, 63, 2864_2876.
- De Miro, E. (1988). “Polizzello, centro della Sicania”. *QuadMess*, 3, 25-41.
- Depew, M.J., Tucker, A., Sharpe, P. (2002). “*Craniofacial development*”; in Rossant J, Tam PPL (eds): *MouseDevelopment: Patterning, Morphogenesis, and Organogenesis*. London, Academic Press, pp 421–498.
- Descoedres, J. P. (1982). “La Grotta del Vecchiuzzo/Jole Bovio Marconi”. *Prudentia*, 14(2), 153-154.
- Dodson, P. (1978). “On the use of ratios in growth studies”. *Systematic Zoology*, 27, 62_67.

- Dryden, I. L., & Mardia, K. V. (1998). *“Statistical shape analysis”*. New York: John Wiley & Sons.

- Ducy, P., Karsenty, G. (1997). “Two distinct osteoblast-specific *cis*-acting elements control expression of a mouse osteocalcin gene”. *Mol Cell Biol*, 15:1858–1869.

- Edgar, H. J. H. (2002). *“Biological Distance and the African American Dentition. Anthropology”*. The Ohio State University, Columbus.

E

- Ehrich, T. H., Vaughn, T. T., Koreishi, S., Linsey, R. B., Pletscher, L. S., & Cheverud, J. M. (2003). “Pleiotropic effects on mandibular morphology I. Developmental morphological integration and differential dominance”. *Journal Of Experimental Zoology Part B _ Molecular And Developmental Evolution*, 296B, 58_79.

- Evin, A., Souter, T., Hulme-Beaman, A., Ameen, C., Allen, R., Viacava, P., & Dobney, K. (2016). “The use of close-range photogrammetry in zooarchaeology: Creating accurate 3D models of wolf crania to study dog domestication”. *Journal of Archaeological Science: Reports*, 9, 87-93.

- Efron, B. (1983). “Estimating the error rate of a prediction rule: Improvement on cross-validation”. *American Statistician*, 37, 36_48.

- Efron, B., & Tibshirani, R. (1995). “*Cross-validation and the bootstrap: Estimating the error rate of a prediction rule*”. Canada: (Technical Report) Department of Statistics, University of Toronto.

- Escoufier, Y. (1973). “*Le traitement des variables vectorielles*”. *Biometrics*, 29, 751_760.

F

- Fabbri, P. F. (1993). “*Nuove determinazioni del sesso e della statura degli individui 1 e 4 del Paleolitico superiore della Grotta di San Teodoro*”. *Rivista di scienze preistoriche*, (45), 219-232.

- Fabbri, P. F. (1995). “*Dental anthropology of the Upper Palaeolithic sample from San Teodoro and inference on the peopling of Sicily*”. *Zeitschrift für Morphologie und Anthropologie*, 311-327.

-Fadda, C., & Corti, M. (1998). “*Geographic variation of Arvicanthis (Rodentia, Muridae) in the Nile Valley*”. *Zeitschrift für Saugetierkunde-International Journal of Mammalian Biology*, 63, 104_113.

- Famà, M. L., & Toti, M. P. (2019). “*La necropoli di Birgi: un esempio d'interazione culturale tra Fenici e Greci nell'eterno banchetto*”. *La necropoli di Birgi: un esempio d'interazione culturale tra Fenici e Greci nell'eterno banchetto*, 395-409.

- Flugel, C., Schram, K., Rohen, J.W. (1993). "Postnatal development of skull base, neuro- and viscerocranium in man and monkey: morphometric evaluation of CT scans and radiograms". *Acta Anat*, 146:71–80.

- Fejerskov, O., & Thylstrup, A. (1989). ' *Embriologia e histologia oral humana* '. Barcelona: Salvat.

- Fink, W. L. (1993). "Revision of the piranha genus *Pygocentrus* (Teleostei, Characiformes)". *Copeia*, 665_687.

- Fink, W. L., & Zelditch, M. L. (1995). "Phylogenetic analysis of ontogenic shape transformations _ a reassessment of the piranha genus *Pygocentrus* (Teleostei)". *Systematic Biology*, 44(3), 343_360.

- Fink, W. L., & Zelditch, M. L. (1996). "Historical patterns of developmental integration in piranhas". *American Zoologist*, 36, 61_69.

- Formicola, V. (1993). "Stature reconstruction from long bones in ancient population samples: an approach to the problem of its reliability". *American Journal of Physical Anthropology*, 90(3), 351-358.

- Fornell, C., & Bookstein, F. (1982). "Two structural equation models: LISREL and PLS applied to consumer exitvoice theory". *Journal of Marketing Research*, 19, 440_452.

- Fornell, R., Cordeiro-Estrela, P., & De Freitas, T. R. O. (2010). "Skull shape and size variation in *Ctenomys minutus* (Rodentia: Ctenomyidae) in geographical,

chromosomal polymorphism, and environmental contexts”. *Biological Journal of the Linnean Society*, 101, 705_720.

- Francis-West, P., Ladher, R., Barlow, A., Graveson, A. (1998) “Signaling interactions during facial development”. *Mech Dev*, 75:3–28.

- Friess, M. (2005). “Multivariate accommodation models using traditional and 3D anthropometry”. *SAE transactions*, 859-862.

- Fully, G. (1956). “Une nouvelle méthode de détermination de la taille”. *Annales de Médecine Légale et de Criminologie*, 36, 266-273.

G

- Galland, M., & Friess, M. (2016). “A three-dimensional geometric morphometrics view of the cranial shape variation and population history in the New World”. *American Journal of Human Biology*, 28(5), 646-661.

- Galland, M., Van Gerven, D. P., von Cramon-Taubadel, N., & Pinhasi, R. (2016). “11,000 years of craniofacial and mandibular variation in Lower Nubia”. *Scientific reports*, 6(1), 1-10.

- Galland, M., D’Amore, G., Friess, M., Miccichè, R., Pinhasi, R., Sparacello, V., S., and Sineo, L. (2019). “Morphological variability of Upper Paleolithic and Mesolithic skulls from Sicily”. *Journal of Antropological Sciences*, 97, 151-172.

- Garn, S. M., Smith, B. H., & Cole, P. E. (1980). “Correlations between root length and face size”. *Journal of Dental Research*, 59, 1178.

- Gartner, L. P., & Hiatt, J. L. (2007). ‘ *Istologia* ’. EdiSES.
- Genovés, S. (1967). “Proportionality of the long bones and their relation to stature among Mesoamericans”. *American Journal of Physical Anthropology*, 26(1), 67-77.
- Germanà, F., & Di Salvo, R. (1994). “Dettagli di paleopatologia in un resto cranico punico dalla Caserma Tukory di Palermo”. *Archivio per l'antropologia e la etnologia* – Vol. CXXIV.
- Gil, O. G., Cambra-Moo, O., Gil, J. A., Nacarino-Meneses, C., Barbero, M. Á. R., Pérez, J. R., & Martín, A. G. (2016). “Investigating histomorphological variations in human cranial bones through ontogeny”. *Comptes Rendus Palevol*, 15(5), 527-535.
- Gill, P.P., VanHook, J., FitzSimmons, J. (1996).” Upper face morphology of second-trimester fetuses”. *Early Hum Dev*, 37:99–106.
- Gingerich, P. D. (1974). “Size variability of the teeth in living mammals and the diagnosis of closely related sympatric fossil species”. *Journal of Palaeontology*, 895-903.
- Gkantidis, N., & Halazonetis, D. J. (2011). “Morphological integration between the cranial base and the face in children and adults”. *Journal of Anatomy*, 218, 426_438.

- Gómez, J. M., Perfectti, F., & Camacho, J. P. M. (2006). “Natural selection on *Erysimum mediohispanicum* flower shape: Insights into the evolution of zygomorphy”. *American Naturalist*, 168, 531_545.
- Gomez, J. M., Abdelaziz, M., Munoz-Pajares, J., & Perfectti, F. (2009). “Heritability and genetic correlation of corolla shape and size in *Erysimum mediohispanicum*”. *Evolution*, 63(7), 1820_1831.
- Gómez-Robles, A., Bermúdez de Castro, J.M., Arsuaga, J.-L., Carbonell, E., Polly, P.D. (2013). “No known hominin species matches the expected dental morphology of the last common ancestor of Neanderthals and modern humans”. *Proceedings of the National Academy of Sciences* 110 (45), 18196e18201.
- González, N.C., Cantalapiedra, Á.N., Pérez, J.R., Cambra-Moo, O., Vilarejo, F. M., Alvaredo, E. C., ... & Martín, A. G. (2016). ‘‘Características paleodemográficas de la población recuperada del cementerio de Marialba de la Ribera (Villaturiel, León, España)(S. IV-XIII)’’. *Munibe Antropologia-Arkeologia*, 67, 151-165.
- Goodrich, E.S. (1958). “*Studies on the Structure and Development of Vertebrates*”. New York, Dover Publications.
- Goose, D. H., & Roberts, E. E. (1982). ‘‘*Size and morphology of children's teeth in North Wales. Teeth: Form, Function and Evolution*’’. Columbia Univ Press: New York, 228-36.
- Gottfries, J., Blennow, K., Wallin, A., & Gottfries, C. G. (1995). “Diagnosis of dementias using partial least squares discriminant analysis”. *Dementia*, 6, 83_88.

- Gould, S. J. (1996). *'The mismeasure of man'*. WW Norton & Company.
- Gower, J. C., & Legendre, P. (1986). "Metric and Euclidean properties of dissimilarity coefficients". *Journal of classification*, 3(1), 5-48.
- Green, W. D. K. (1996). *"The thin-plate spline and images with curving features"*. In K. V. Mardia, C. A. Gill, & I. L. Dryden (Eds.), *Image fusion and shape variability* (pp. 79_87). Leeds: University of Leeds Press.
- Gregory, W.K. (1922). "The origin and evolution of human dentition". Reprinted from *Journal of Dental Research* II-III Baltimore.
- Gregory, W.K. (1933). "Fish skulls. A study of the evolution of natural mechanisms". *Trans Am Phil Soc*, 23:i-vii, 75-481.
- Griffo, M.G. (1997). "La necropoli di Birgi". *Seconde Giornate Internazionali di studi sull'area elima*, 909-21.
- Griffo, M.G. (2008). La necropoli di Birgi. *E. Caruso, A. Spanò Giammellaro (edd.), Lilibeo e il suo territorio. Contributi del Centro Internazionale di Studi Fenici, Punici e Romani per l'archeologia marsalese, Marsala*, 169-176.
- Guatelli-Steinberg, D., Irish, J.D. (2005). "Brief communication: early hominin variability in first molar dental trait frequencies". *American Journal of Physical Anthropology* 128 (2), 477e484.
- Gunz, P., Bookstein, F. L., Mitteroecker, P., Stadlmayr, A., Seidler, H., & Weber, G. W. (2009a). "Early modern human diversity suggests subdivided population

structure and a complex out-of-Africa scenario”. *Proceedings of the National Academy of Sciences*, 106(15), 6094-6098.

- Gunz, P., Mitteroecker, P., Neubauer, S., Weber, G. W., & Bookstein, F. L. (2009). “Principles for the virtual reconstruction of hominin crania”. *Journal of human evolution*, 57(1), 48-62.

- Gussekloo, S.W.S., Vosselman, M.G., Bout, R.G. (2001). “Three-dimensional kinematics of skeletal elements in avian prokinetic and rynchokinetic skulls determined by Roentgen stereophotogrammetry”. *J Exp Biol*; 204:1735–1744.

H

- Hall, B.K. (1990). “Evolutionary issues in craniofacial biology”. *Cleft Palate J*, 27:95–100.

- Hall, B.K. (1994). “*Homology: the Hierarchical Basis of Comparative Biology*”. San Diego, Academic Press.

- Hall, B.K., Miyake, T. (1995). “Divide, accumulate, differentiate: cell condensation in skeletal development revisited”. *Int J Dev Biol*, 39:881–893.

- Hall, B.K., Miyake, T. (2000). “All for one and one for all: condensations and the initiation of skeletal development”. *Bioessays*, 22:138–147.

- Hall, B.K. (2003). “Descent with modification: the unity underlying homology and homoplasy as seen through an analysis of development and evolution”. *Biol Rev Camb Philos Soc*, 78:409–433.

- Halstead, L.B. (1968). *“The Pattern of Vertebrate Evolution”*. San Francisco, Freeman.
- Hammer O., Harper D. (2008). *“Paleontological Data Analysis”* Blackwell Publishing, 347 pp.
- Hanihara, T. (2008). “Morphological variation of major human populations based on nonmetric dental traits”. *American Journal of Physical Anthropology* 136, 169e182.
- Harrison, G. A., Tanner, J. M., Pilbeam, D. R., & Baker, P. T. (2004). ‘Population genetics-gene frequency changes’. *An Introduction to Human Evolution, Variation, Growth, and Adaptability*, 208.
- Harvati, K., & Weaver, T. D. (2006). “Human cranial anatomy and the differential preservation of population history and climate signatures”. *The Anatomical Record Part A: Discoveries in Molecular, Cellular, and Evolutionary Biology: An Official Publication of the American Association of Anatomists*, 288(12), 1225-1233.
- Harvati, K., Gunz, P., & Grigorescu, D. (2007). ‘Cioclovina (Romania): affinities of an early modern European’. *Journal of Human Evolution*, 53(6), 732-746.
- Hemphill, B. E. (2015). ‘Measurement of tooth size (odontometrics)’. *A companion to dental anthropology*, 287-310.
- Harvati, K., Hublin, J. J., & Gunz, P. (2010). “Evolution of middle-late Pleistocene human cranio-facial form: A 3-D approach”. *Journal of human evolution*, 59(5), 445-464.

- Herman, G. T. (2009). *“Fundamentals of computerized tomography: image reconstruction from projections”*. Springer Science & Business Media.
- Herring, S.W., Teng, S. (2000). “Strain in the braincase and its sutures during function”. *Am J Phys Anthropol*, 112:575–593.
- Herring, S.W., Rafferty, K.L. (2000). *“Cranial and facial sutures: functional loading in relation to growth and morphology”*; in Davidovitch Z, Mah J (eds): *Biological Mechanisms of Tooth Movement and Craniofacial Adaptation*. Boston, Harvard Society for the Advancement of Orthodontics, pp 269–276.
- Hartmann, C. (2006). “A Wnt canon orchestrating osteoblastogenesis”. *Trends Cell Biol*,16:151–158.
- Henderson, J.H., Longaker, M.T., Carter, D.R. (2004). “Sutural bone deposition rate and strain magnitude during cranial development”. *Bone*, 34:271–280.
- Henderson, J.H., Chang, L.Y., Song, H.M., Longaker, M.T., Carter, D.R. (2005) “Age-dependent properties and quasi-static strain in the rat sagittal suture”. *J Biomech*, 38:2294–2301.
- Hildebrand, M. (1988). *“Analysis of Vertebrate Structure”*. New York, Wiley.
- Hills, M. (1978). “On ratios _ a response to Atchley, Gaskins and Anderson”. *Systematic Zoology*, 27, 61_62.
- Hillson S. (1986). *“Teeth”*. Cambridge manuals in Archaeology. Cambridge University Press.

- Hodos, T. (2010). ‘‘Globalization and Colonization: A View from Iron Age Sicily’’. *Journal of Mediterranean Archaeology*, 23(1).
- Holloway, R. R. (2002). ‘‘*The archaeology of ancient Sicily*’’. Routledge.
- Hopkins, M. J., & Thurman, C. L. (2010). ‘‘The geographic structure of morphological variation in eight species of fiddler crabs (Ocypodidae: genus *Uca*) from the eastern United States and Mexico’’. *Biological Journal of the Linnean Society*, 100, 248_270.
- Hotelling, H. (1933). ‘‘Analysis of a complex of statistical variables into principal components’’. *Journal of Educational Psychology*, 24: 417–41, 498–520.
- Houle, D., Mezey, J., & Galpern, P. (2002). ‘‘Interpretation of the results of common principal components analysis’’. *Evolution*, 56, 433_440.
- Howells, W.W. (1973). ‘‘*Cranial variation in man: a study by multivariate analysis of patterns of difference among recent human populations*’’. In: Papers of the Peabody Museum of Archaeology and Ethnology, pp. 1e259.
- Howells, W.W. (1984). ‘‘*Introduction to multivariate statistical methods*’’. In: Van Vark, G.N., Howells, W.W. (Eds.), *Multivariate Statistical Methods in Physical Anthropology*. D. Reidel Publishing Company, Dordrecht, pp. 1e12.
- Howells, W.W. (1989). ‘‘*Skull Shapes and the Map: Craniometric Analyses in the Dispersion of Modern Homo*’’. Harvard University Press, Cambridge, MA.
- Howells, W.W. (1996). ‘‘Howells’ craniometric data on the internet’’. *American Journal of Physical Anthropology* 101 (3), 441e442.

- Huerta, M. D. R. G., & Hervás, J. M. (2004). ‘‘*La Península Ibérica en el II milenio AC: poblados y fortificaciones* (No. 77)’’. Univ de Castilla La Mancha.

- Hunter, J.P., Guatelli-Steinberg, D., Weston, T.C., Durner, R., & Betsinger, T.K. (2010). ‘‘Model of tooth morphogenesis predicts Carabelli cusp expression, size, and symmetry in humans’’. *PloS one*, 5(7), e11844.

- Huxley, T. H. (1880). ‘‘On the application of the laws of evolution to the arrangement of the Vertebrata and more particularly of the Mammalia’’. *In* Proceedings of the Zoological Society of London (Vol. 1880, pp. 649-662).

I

- Incarbona, A., Zarcone, G., Agate, M., Bonomo, S., Stefano, E., Masini, F., & Sineo, L. (2010). ‘‘A multidisciplinary approach to reveal the Sicily Climate and Environment over the last 20 000 years’’. *Open Geosciences*, 2(2), 71-82.

- Iordansky, N.N. (1990). ‘‘Evolution of cranial kinesis in lower tetrapods’’. *Neth J Zool*, 40:32–54.

- Irish, J.D., Guatelli-Steinberg, D. (2003). ‘‘Ancient teeth and modern human origins: an expanded comparison of African Plio-pleistocene and recent world dental samples’’. *Journal of Human Evolution* 45, 11.

J

-Jackson, J.E. (1991). ‘‘*A User’s Guide to Principal Components*’’. John Wiley, New York.

3e144.

- Jane, J., Persing, J. (2001). "Neurosurgical treatment of craniosynostosis; in Cohen MJ, Maclean R (eds): Craniosynostosis Diagnosis, Evaluation, and Management". *Oxford, Oxford University Press*, chap 18.
- Janvier, P. (1996). "*Early Vertebrates*". Oxford, Clarendon Press.
- Jantz, R.L., Hunt, D.R., & Meadows, L. (1995). "The measure and mismeasure of the tibia: implications for stature estimation". *Journal of Forensic Science*, 40(5), 758-761.
- Johansen, V.A., Hall S.H. (1982) "Morphogenesis of the mouse coronal suture". *Acta Anat (Basel)*,114:58–67.
- Johansson, F., Soderquist, M., & Bokma, F. (2009). "Insect wing shape evolution: independent effects of migratory and mate guarding flight on dragonfly wings". *Biological Journal of the Linnean Society*, 97, 362_372.
- Jollie, M (1926). "*Chordate Morphology*". New York, Reinhold.
- Jolliffe, I.T. (1986). "*Principal Component Analysis*". Springer Verlag.
- Jolliffe I.T. (2002). "*Principal Component Analysis and Factor Analysis*" 2° Edition. Springer. 477 pp.
- Joreskog, K. G., & Wold, H. (1982). "*Systems under direct observation: Causality_structure_prediction*". North Holland Publishing Co.

- Jurado-Gómez, J. (2007). “*El conocimiento de las poblaciones del pasado a través de los restos óseos: Caracterización de la estancia M1 y comparación con la habitación M4, de la necrópolis medieval de Veranes (S. VI-XIII, Gijón, Asturias)*” (Bachelor's thesis).

- Jurda, M., & Urbanova, P. (2016). “Three-dimensional documentation of Dolní Věstonice skeletal remains: can photogrammetry substitute laser scanning?”. *Anthropologie (1962-), 54(2)*, 109-118.

K

- Katz, D., & Friess, M. (2014). “3D from standard digital photography of human crania—a preliminary assessment”. *American Journal of Physical Anthropology, 154(1)*, 152-15

- Kemsley, E. K. (1996). “Discriminant analysis of high-dimensional data: A comparison of principal components analysis and partial least squares data reduction methods”. *Chemometrics and Intelligent Laboratory Systems, 33*, 47_61.

- Kendall, D. G. (1977). “*The diffusion of shape*”. *Advances in Applied Probability, 9*, 428_430.

- Kenyhercz, M. W., Klales, A. R., & Kenyhercz, W. E. (2014). “Molar size and shape in the estimation of biological ancestry: A comparison of relative cusp location using geometric morphometrics and interlandmark distances”. *American journal of physical anthropology, 153(2)*, 269-279.

- Kendall, D. G., & Kendall, W. S. (1980). ‘*Alignments in two-dimensional random sets of points. Advances in Applied Probability*’. 12, 380_424.
- Kermack, K.A. & J.B.S. Haldane. (1950). “Organic correlation and allometry”. *Biometrika*, 37: 30–41.
- Kieser, J. A., Groeneveld, H. T., McKee, J., & Cameron, N. (1990). “Measurement error in human dental mensuration”. *Annals of human biology*, 17(6), 523-528.
- Kim, K., Sheets, H. D., Haney, R. A., & Mitchell, C. E. (2002). “Morphometric analysis of ontogeny and allometry of the Middle Ordovician trilobite *Triarthrus becki*”. *Paleobiology*, 28(3), 364_377.
- Kistler, E. (2012). “Glocal responses from archaic Sicily”. *Ancient West & East*, 11, 219-233.
- Kistler, E. (2013). “Monte Iato, Sicily”. *The Encyclopedia of Ancient History*, 1-1.
- Kistler, E., Öhlinger, B., Mölk, N., Steger, M. (2014). “Zwischen Aphrodite-Tempel und spätarchaischem Haus". Die Innsbrucker Kampagnen 2012 und 2013 auf dem Monte Iato (Sizilien)”. *In: Jahreshefte des Österreichischen Archäologischen Instituts in Wien* 83, 157 - 200.
- Kistler, E., Öhlinger, B., Dauth, T., Mölk, N., Irovec, R., Wimmer, B., Forstenpointer, G, (2019). “Zwischen Aphrodite-Tempel und spätarchaischem Haus II“. Die Innsbrucker Kampagnen 2015 und 2016 auf dem Monte Iato

(Sizilien)”. In: *Jahreshefte des Österreichischen Archäologischen Instituts in Wien* 87, 249 - 299.

- Kistler, E., Öhlinger, B., Dauth, T., Ludwig, S., Mölk, N., Irovec, R., Wimmer, B. (2019). "Zwischen Aphrodite-Tempel und spätarchaischem Haus II". Die Innsbrucker Kampagnen 2016-2018 auf dem Monte Iato (Sizilien), in: *Jahreshefte des Österreichischen Archäologischen Instituts in Wien* - In Vorbereitung.

- Kjaer, I. (1989) "Prenatal skeletal maturation of the human maxilla". *J Craniofac Genet Dev Biol*, 9:257–64

- Klingenberg, C. P. (1998). "Heterochrony and allometry: The analysis of evolutionary change in ontogeny". *Biological Reviews*, 73, 99_123.

- Klingenberg, C. P., & McIntyre, G. S. (1998). "Geometric morphometrics of developmental instability: Analyzing patterns of fluctuating asymmetry with Procrustes methods". *Evolution*, 52, 1363_1375.

- Klingenberg, C. P., & Zaklan, S. D. (2000). "Morphological integration between developmental compartments in the *Drosophila* wing". *Evolution*, 54, 1273_1285.

- Klingenberg, C. P., Badyaev, A. V., Sowry, S. M., & Beckwith, N. J. (2001). "Inferring developmental modularity from morphological integration: Analysis of individual variation and asymmetry in bumblebee wings". *American Naturalist*, 157, 11_23.

- Klingenberg, C. P., Mebus, K., & Auffray, J. C. (2003). ‘‘Developmental integration in a complex morphological structure: How distinct are the modules in the mouse mandible?’’. *Evolution & Development*, 5, 522_531.
- Klingenberg, C. P. (2008). ‘‘Novelty and ‘‘homology-free’’ morphometrics: What is in a name?’’. *Evolutionary Biology*, 35(3), 186_190.
- Klingenberg, C. P. (2009). ‘‘Morphometric integration and modularity in configurations of landmarks: Tools for evaluating a priori hypotheses’’. *Evolution & Development*, 11, 405_421.
- Knoke, J. D. (1986). ‘‘The robust estimation of classification error rates’’. *Computers and Mathematics with Applications*, 2, 253_260.
- Kuzawa, C.W., & Thayer, Z.M. (2011). ‘‘Timescales of human adaptation: the role of epigenetic processes’’. *Epigenomics*, 3(2), 221-234.
- La Duca, R. (a cura di) (2000). *Storia di Palermo I.I. ‘‘Dal tardo-antico all’Islam’’*. (collana diretta da Rosario La Duca).

L

- Lahr, M. M., & Wright, R. V. (1996). ‘‘The question of robusticity and the relationship between cranial size and shape in *Homo sapiens*’’. *Journal of Human Evolution*, 31(2), 157-191.
- Laffont, R., Renvoise, E., Navarro, N., Alibert, P., & Montuire, S. (2009). ‘‘Morphological modularity and assessment of developmental processes within the

vole dental row (*Microtus arvalis*, Arvicolinae, Rodentia)”. *Evolution & Development*, 11, 302_311.

- Lagler, K. F., Bardach, J. E., & Miller, R. R. (1962). ‘*Ichthyology*’. New York: John Wiley & Sons.

- La Greca, M. (1957). “Considerazioni sull'origine della fauna siciliana”. *Italian Journal of Zoology*, 24(2), 593-631.

- La Greca, M. (1961). *Considerazioni sull'origine e la costituzione della fauna di Sicilia:(discorso inaugurale del 7° Convegno del GIB)*.

- Larocca, P. (2011). ‘*Variabilità cranimetrica e distanze biologiche tra popolazioni preistoriche ed antiche della sicilia*’. (Doctoral dissertation, Università degli Studi di Catania).

- La Torre, G. F., & Raffa, A. T. (2016). “Archeologia dei paesaggi: il territorio di Licata (AG) e la bassa valle dell’Himera meridionale”. In *LAC 2014 proceedings* (p. 12).

- Lautrou, A., Riitano, F., Malignino, G., & Malignino, V. (1982). ‘*Anatomia dentaria*’. Masson Italia.

- Larsen, C.S. (2015). “*Bioarchaeology: interpreting behavior from the human skeleton*”. (Vol.69). Cambridge University Press. 191 pp.

- Lauria, G., & Messina A. (2013). ‘The Cave of Vecchiuzzo: anthropology, paleopathology and hierarchy of the human group with a statistical overview

(Petralia Sottana – Palermo, Italy)’. *Archivio per l’Antropologia e la Etnologia* - Vol. CXLIII.

- Lauria, G., Sconzo, P., Falsone, G., & Sineo, L. (2017). ‘Human Remains and Funerary Rites in the Phoenician Necropolis of Motya (Sicily)’. *International Journal of Osteoarchaeology*, 27(6), 1003-1011.

- Lee, S.K., Kim, Y.S., Lim, C.Y., Chi, J.G. (1992) ‘Prenatal growth pattern of the human maxilla’. *Acta Anat.* 145:1–10.

- Lease, L.R. (2003). ‘*Ancestral Determination of African American and European American Deciduous Dentition Using Metric and Non-metric Analysis. Department of Anthropology*’. The Ohio State University, Columbus.

- Lele, S., & Richtsmeier, J. T. (1991). ‘*Euclidean distance matrix analysis _ A coordinate-free approach for comparing biological shapes using landmark data*’. *American Journal of Physical Anthropology*, 86, 415_427.

- Lele, S., & Richtsmeier, J. T. (2001). ‘*An invariant approach to statistical analysis of shapes. London*’. Chapman & Hall-CRC Press.

- Liem, K. F., Bemis, W. E., Walker, W. F., & Grande, L. (2002). ‘*Anatomia comparata dei Vertebrati*’. EdiSES srl Napoli.

- Linder, W. (2009). ‘*Digital Photogrammetry: A practical course. 2ª ed*’. Springer.

- Lombroso, C. (1896). ‘*L'uomo delinquente in rapporto all'antropologia: alla giurisprudenza ed alle discipline carcerarie*’. (Vol. 2) Fratelli Bocca.

- Lagler, K. F., Bardach, J. E., & Miller, R. R. . (1962). '*Ichthyology*'. New York: John Wiley & Sons.
- Lorenzen, T. J., & Anderson, M. J. (1993). "*Design of experiments: A no-name approach*". New York: Marcel Dekker.
- Lowe, A. A., Ozbeck, M. M., Miyamoto, K., & Fleetham, J. A. (1997). "Cephalometric and demographic characteristics of obstructive sleep apnea: An evaluation with partial least squares analysis". *The Angle Orthodontist*, 67, 143_154.
- Lundrigan, B. (1996). "Morphology of horns and fighting behavior in the family Bovidae". *Journal of Mammalogy*, 77, 462_475.
- Lundy, J. K. (1988). "A report on the use of Fully's anatomical method to estimate stature in military skeletal remains". *Journal of Forensic Science*, 33(2), 534-539.
- Lycett, S. J., & von Cramon-Taubadel, N. (2008). "Acheulean variability and hominin dispersals: a model-bound approach". *Journal of Archaeological Science*, 35(3), 553-562.

M

- Mallegni, F. (2001). '*Denti, ontogenesi, evoluzione, struttura, dimensione, forma, funzione*'. LTU Guarguaglini, Pisa.
- Mandarim-de-Lacerda, C.A., Urania-Alves, M. (1993). "Growth allometry of the human face: analysis of the osseous component of the mid and lower face in Brazilian foetuses". *Anat Anz*, 175:475-9.

- Manica, A., Amos, W., Balloux, F., & Hanihara, T. (2007). "The effect of ancient population bottlenecks on human phenotypic variation". *Nature*, 448(7151), 346-348.

- Mannino, M. A., Thomas, K. D., Leng, M. J., Piperno, M., Tusa, S., & Tagliacozzo, A. (2007). "Marine resources in the Mesolithic and Neolithic at the Grotta dell'Uzzo (Sicily): evidence from isotope analyses of marine shells". *Archaeometry*, 49(1), 117-133.

- Mannino, G. (2016). "Alia, il complesso rupestre della Gurfa". *Notiziario Archeologico della Soprintendenza di Palermo*, 8, 2016.

- Mayr, E. (1963). Animal Species and. *Evolution*, 521.

- Mahalanobis, P. C. (1936). "On the generalized distance in statistics". National Institute of Science of India.

- Manouvrier, L. (1893). "Etude sur les variations morphologiques du corps du fémur dans l'espèce humaine". *Bulletins et Mémoires de la Société d'Anthropologie de Paris*, 4(1), 111-144.

- Martin, R., & Saller, K. (1957). "'Lehrbuch der Anthropologie II'". Stuttgart: Gustav Fischer.

- Martín-Torres, M., De Castro, J.B., Gómez-Robles, A., Arsuaga, J., Carbonell, E., Lordkipanidze, D., Manzi, G., Margvelashvili, A. (2007). "Dental evidence on the hominin dispersals during the Pleistocene". *Proceedings of the National Academy of Sciences of the United States of America* 104 (33), 13279e13282.

- Martín-Torres, M., de Castro, J.M.B., Gómez-Robles, A., Prado-Simón, L., Arsuaga, J.L. (2012). “Morphological description and comparison of the dental remains from Atapuerca-Sima de los Huesos site (Spain)”. *Journal of Human Evolution* 62 (1), 7e58.
- Marquez, E. J. (2008). “A statistical framework for testing modularity in multidimensional data”. *Evolution*, 62, 2688_2708.
- Massa, B., Sbordoni, V., & Vigna Taglianti, A. (2011). “La Biogeografia della Sicilia considerazioni conclusive sul XXXVII Congresso della Societa'Italiana di Biogeografia”. *Biogeographia–The Journal of Integrative Biogeography*, 30(1).
- Mayhall, J. T. (1992). “Techniques for the study of dental morphology”. *Skeletal biology of past peoples: research methods. Nueva York: Wiley-Liss. p*, 59-78.
- Mayhall, J. T. (2000). “Dental morphology: techniques and strategies”. *Biological Anthropology of the Human Skeleton. Wiley-Liss: New York*.
- Mays, S. (2010). “*The archaeology of human bones*”. Routledge.
- Matsumura, H., Shinoda, K. I., Shimanjuntak, T., Oktaviana, A. A., Noerwidi, S., Sofian, H. O., ... & Adachi, N. (2018). “Cranio-morphometric and aDNA corroboration of the Austronesian dispersal model in ancient Island Southeast Asia: Support from Gua Harimau, Indonesia”. *PloS one*, 13(6).
- McArdle, B. H., & Anderson, M. J. (2001). “Fitting multivariate models to community data: A comment on distance-based redundancy analysis”. *Ecology*, 82, 290_297.

- McGuire, J. L. (2010). “Geometric morphometrics of vole (*Microtus californicus*) dentition as a new paleoclimate proxy: Shape change along geographic and climatic clines”. *Quaternary International*, 212, 198_205.
- Menéndez, L. P., Rademaker, K., & Harvati, K. (2019). “Revisiting East–West Skull Patterns and the Role of Random Factors in South America: Cranial Reconstruction and Morphometric Analysis of the Facial Skeleton from Cuncaicha Rockshelter (Southern Peru)”. *PaleoAmerica*, 1-20.
- Menesatti, P., Costa, C., & Paglia, G., et al. (2008). “Shape-based methodology for multivariate discrimination among Italian hazelnut cultivars”. *Biosystems Engineering*, 4, 417_424.
- Messina, A., Sineo, L., Schimmenti, V., & Di Salvo, R. (2008). “Cribra Orbitalia and Enamel Hypoplasia of the Iron Age (IX–VII centuries BC) Human Group of Polizzello (Sicily)”. *Journal of Palaeopathology*, 20(1-3), 53-65.
- Mevic, B. -H., & Wehrens, R. (2007). “The pls package: Principal component and partial least squares regression in R”. *Journal of Statistical Software*, 18, 1_23.
- Mezey, J. G., Cheverud, J. M., & Wagner, G. P. (2000). “Is the genotype-phenotype map modular? A statistical approach using mouse quantitative trait loci data”. *Genetics*, 156, 305_311.
- Michaux, J., Hautier, L., Simonin, T., & Vianey-Liaud, M. (2008). “Phylogeny, adaptation and mandible shape in Sciuridae (Rodentia, Mammalia)”. *Mammalia*, 72, 286_296.

- Miller, R.L. & Kahn, J.S. (1962). “*Statistical Analysis in the Geological Sciences*”. John Wiley, New York.

- Minà, G. (2018). “*La Necropoli Arcaica di Mozia: Nuovi dati Antropologici-Campagna Scavo 2017*”. Dissertation thesis of Master degree in Natural and Environmental Sciences – University of Palermo.

- Miroue, M., Rosenberg, L. (1975). “*The Human Facial Sutures: A Morphometric and Histologic Study of Age Changes from 20 to 95 Years*”. Masters thesis. Seattle, University of Washington.

- Mitteroecker, P., & Bookstein, F. (2007). “The conceptual and statistical relationship between modularity and morphological integration”. *Systematic Biology*, 56, 818_836.

- Mitteroecker, P., & Bookstein, F. (2008). “The evolutionary role of modularity and integration in the hominoid cranium”. *Evolution*, 62, 943_958.

- Mitteroecker, P., & Bookstein, F. (2011). “Linear discrimination, ordination, and the visualization of selection gradients in modern morphometrics”. *Evolutionary Biology*, 38, 100_114

- Myers, P., Lundrigan, B. L., Gillespie, B. W., & Zelditch, M. L. (1996). “Phenotypic plasticity in skull and dental morphology in the prairie deer mouse (*Peromyscus maniculatus bairdii*)”. *Journal of Morphology*, 229, 229_237.

- Modarresi, R., Lafond, T., Roman-Blas, J.A., Danielson, K.G., Tuan, R.S., Seghatoleslami, M.R. (2005). “N-cadherin mediated distribution of beta-catenin

alters MAP kinase and BMP-2 signaling on chondrogenesis-related gene expression". *J Cell Biochem*, 95:53–63.

- Mölk, N.: Giato/Jāṭū, Geschichte einer mittelalterlichen Stadt; unpublizierte Dissertation zur Erlangung des Doktorgrades der Philosophisch-Historischen Fakultät der Leopold-Franzens-Universität Innsbruck am Institut für Archäologien (2019), betreut von Prof. Dr. Erich Kistler, Universität Innsbruck; Prof. Dr. Lukas Clemens, Universität Trier; Prof. em. Dr. Hans Peter Isler, Universität Zürich.

- Monteiro, L. R., Duarte, L. C., & dos Reis, S. F. (2003). "Environmental correlates of geographical variation in skull and mandible shape of the punare rat *Thrichomys apereoides* (Rodentia: Echimyidae)". *Journal of Zoology*, 261, 47_57.

- Monteiro, L. R., Bonato, V., & dos Reis, S. F. (2005). "Evolutionary integration and morphological diversification in complex morphological structures: Mandible shape divergence in spiny rats (Rodentia, Echimyidae)". *Evolution & Development*, 7, 429_439.

- Monteiro, L. R., & Nogueira, M. R. (2009). "Adaptive radiations, ecological specialization, and the evolutionary integration of complex morphological structures". *Evolution*, 64, 724_743.

- Mounier, A., & Lahr, M. M. (2016). "Virtual ancestor reconstruction: revealing the ancestor of modern humans and Neandertals". *Journal of Human Evolution*, 91, 57-72.

- Moore, W.J. (1981). "*The Mammalian Skull*". Cambridge, Cambridge University Press.

- Moorrees, C. F., & Reed, R. B. (1964). "Correlations among crown diameters of human teeth". *Archives of Oral Biology*, 9(6), 685-697.
- Morgan, B., Ford, A. L., & Smith, M. J. (2019). "Standard methods for creating digital skeletal models using structure-from-motion photogrammetry". *American journal of physical anthropology*, 169(1), 152-160.
- Morrison, D. F. (1990). "*Multivariate statistical methods*". New York: McGraw Hill.
- Morton S.G., (1839) "*Crania Americana Crania, a comparative view of the skulls of various aboriginal nations of North and South America, to which is prefixed an essay on the varieties of the human species*". Philadelphia: J. Dobson.
- Morton, S. G. (1842). "An Inquiry into the Distinctive Characteristics of the Aboriginal Race of America". *Read at the Annual Meeting of the Boston Society of Natural History*, Wednesday, April 27, 1842 (Vol. 1, No. 5). Tuttle & Dennett, printers.
- Moss, M.L. (1958). "Fusion of the frontal suture in the rat". *Am J Anat*, 102:141–165.
- Most, D., Levine, J.P., Chang, J., Sung J., McCarthy, J.G., Schendel, S.A., Longaker, M.T. (1998). "Studies in cranial suture biology: up-regulation of transforming growth factor-beta1 and basic fibroblast growth factor mRNA correlates with posterior frontal cranial suture fusion in the rat". *Plast Reconstr Surg*, 101:1431–1440.

- Müller, G. (1935). “Zur bestimmung der Länge beschädigter Extremitätenknochen”. *Anthropologischer Anzeiger*, (H. 1), 70-72.
- Mullin., S.K., & Taylor, P. J. (2002). “The effects of parallax on geometric morphometrics data”. *Computers in Biology and Medicine*, 32, 455_464.

N

- Nichol, C. R. (1989). “Complex segregation analysis of dental morphological variants”. *American Journal of Physical Anthropology*, 78(1), 37-59.
- Nicoletti, F., & Tusa, S. (2012). “L'Età del Bronzo nella Sicilia occidentale”. *L'età del Bronzo nella Sicilia occidentale*, 105-130.
- Noback, M. L., Harvati, K., & Spoor, F. (2011). “Climate-related variation of the human nasal cavity”. *American Journal of Physical Anthropology*, 145, 599_614.
- Nolte, A. W., & Sheets, H. D. (2005). “Shape based assignment tests suggest transgressive phenotypes in natural sculpin hybrids (Teleostei, Scorpaeniformes, Cottidae)”. *Frontiers in Zoology*, 2, 11.
- Nott J. C. & Glidon G. (1860) “*Types of Mankind, Or, Ethnological Researches: Based Upon the Ancient Monuments, Paintings, Sculptures, and Crania of Races, and Upon Their Natural, Geographical, Philological, and Biblical History.*” Lippincott.

O

- Ochoa, C. F., & Díaz, P. G. (1999). "Excavaciones en Santa María de Lugo de Llanera (Asturias)". In *Excavaciones arqueológicas en Asturias: 1995-98* (pp. 163-174). Servicio de Publicaciones.
- O'Higgins, P.A.U.L. (2000). "The study of morphological variation in the hominid fossil record: biology, landmarks and geometry". *The Journal of Anatomy*, 197(1), 103-120.
- Olson, E. C. (1959). "The evolution of mammalian characters". *Evolution*, 13(3), 344-353.
- Opperman, L.A., Sweeney, T.M., Redmon, J., Persing, J.A., Ogle, R.C. (1993). "Tissue interactions with underlying dura mater inhibit osseous obliteration of developing cranial sutures". *Dev Dyn*, 198:312–322.
- Opperman, L.A., Passarelli, R.W., Nolen, A.A., Gamper, T.J., Lin, K.Y.K., Ogle, R.C. (1996), "Dura mater secretes soluble heparin-binding factors required for cranial suture morphogenesis". *In Vitro Cell Dev Biol Animal*, 32:627–632.
- Opperman, L.A., Nolen, A.A., Ogle, R.C. (1997). "TGF-beta 1, TGF-beta 2, and TGF-beta 3 exhibit distinct patterns of expression during cranial suture formation and obliteration in vivo and in vitro". *J Bone Miner Res*, 12:301–310.
- Ortiz, M., Sarabia, L., Symington, C., Santamaria, F., & Iniguez, M. (1996). "Analysis of ageing and typification of vintage ports by partial least squares and soft independent modeling class analogy". *Analyst*, 1009_1013.

- Ortner, D.J. (2003). *“Identification of pathological conditions in human skeletal remains”*. Academic Press. 311 pp.
- Oudhof. H.A.J., van Doorenmaalen W.J. (1983). “Skull morphogenesis and growth: hemodynamic influence”. *Acta Anat*, 117:181–186.
- Oxnard, C. E. (1968). The architecture of the shoulder in some mammals. *Journal of Morphology*, 126, 249_290.
- Oxnard, C. E. (1985). *“Human, Apes and Chinese Fossils: New Implications for Human Evolution (Vol. 1)”*. Hong Kong University Press.
- Ozdemir-Turan, S., Ercan, I., Ozkaya, G., Simsek Cankur, N., & Selim Erdal, Y. (2010). “Geometric morphometric study and cluster analysis of Late Byzantine and modern human crania”. *Collegium antropologicum*, 34(2), 493-499.

P

- Pancucci, D. (1989). “Caltavuturo: le origini.” *Sicilia Archeologica* 71, pp. 65-71.
- Pang, M. K., & Bakholdina, V. Y. (2010). “The Population History of the Korean Peninsula: Dental Evidence”. *Archaeology, Ethnology and Anthropology of Eurasia*, 38(2), 141-145.
- Passafiume, B. (1645). *‘De origine Ecclesiae Cephakaditane eiuquemurbis etet diocesis’*. Brevis descriptio, Venezia.
- Pautasso, A. (2017). “Il Thesmophorion di Entella. Scavi in Contrada Petrarò”.

- Pearson, K. (1899). IV. "Mathematical contributions to the theory of evolution. On the reconstruction of the stature of prehistoric races". *Philosophical Transactions of the Royal Society of London. Series A, Containing Papers of a Mathematical or Physical Character*, (192), 169-244.
- Perez, S. I., Diniz, J. A. F., Rohlf, F. J., & Dos Reis, S. F. (2009). "Ecological and evolutionary factors in the morphological diversification of South American spiny rats". *Biological Journal of the Linnean Society*, 98, 646_660.
- Persson, M., Roy, W. (1979). "Suture development and bony fusion in the fetal rabbit palate". *Arch Oral Biol*, 24:283–291.
- Persson, M., Thilander, B. (1977). "Palatal suture closure in man from 15 to 35 years of age". *Am J Orthod*, 72:42–52.
- Persson, M. (1995). "The role of sutures in normal and abnormal craniofacial growth". *Acta Odontol Scand*, 53:152–161.
- Peyer, B (1968). "*Comparative Odontology*". Chicago, University of Chicago Press.
- Pignatti, S. (2011). "La flora della Sicilia come chiave di lettura per la fitogeografia mediterranea: una visione autobiografica". *Biogeographia–The Journal of Integrative Biogeography*, 30(1).
- Pilloud, M. A., & Hefner, J. T. (Eds.). (2016). "*Biological distance analysis: forensic and bioarchaeological perspectives*". Academic Press.

- Pietrusewsky, M. (2000). '*Metric analysis of skeletal remains: methods and applications*'. Biological Anthropology of the Human Skeleton. Wiley-Liss, New York, 375-415.
- Piras, P., Maiorino, L., & Raia, P., et al. (2010). "Functional and phylogenetic constraints in Rhinocerotinae craniodental morphology". *Evolutionary Ecology Research*, 12, 897_928.
- Press, W. H., Flannery, B. P., Teukolsky, S. A., & Vetterling, W. T. (1992). "*Numerical Recipes in C: The Art of Scientific Computing*". Cambridge University Press.
- Pretty, I. A., & Sweet, D. (2001). "The scientific basis for human bitemark analyses: A critical review". *Science and Justice*, 41, 85_92.
- Pretty, I. A. (2006). "The barriers to achieving an evidence base for bitemark analysis". *Forensic Science International*, Suppl. 1, S110_S120.
- Pritchard, J.J., Scott, J.H., Girgis, F.G. (1956). "The structure and development of cranial and facial sutures". *J Anat*, 90:73–86.
- Pulcini, D., Costa, C., Aguzzi, J., & Cataudella, S. (2008). "Light and shape: A contribution to demonstrate morphological differences in diurnal and nocturnal teleosts". *Journal of Morphology*, 269, 375_385.

Q

- Quinn, G. P., & Keogh, M. J. (2002). "*Experimental design and data analysis for biologists*". Cambridge: Cambridge University Press.

R

- Radlanski, R.J., Renz, H., Lange, S. (2000). "Prenatal development of the human maxilla from 19–76 mm CRL". *Ann Anat*, 182:98.
- Rao, C. R. (1973). "*Linear statistical inference and its applications*". New York: John Wiley & Sons.
- Rascón, J., Montoro, A., González, A. M., Pérez, S. M., Rodríguez, A. I. G., & Cambra, O. M. (2001). "Estudio de cribra orbitalia e hipoplasias del esmalte en la población medieval de la Necrópolis de Veranes (Principado de Asturias)". In *Actas del VI Congreso Nacional de Paleopatología¿ Dónde estamos? Pasado, presente y futuro de la Paleopatología* (pp. 408-416).
- Raxter, M.H., Auerbach, B.M., & Ruff, C.B. (2006). "Revision of the Fully technique for estimating statures". *American Journal of Physical Anthropology: The Official Publication of the American Association of Physical Anthropologists*, 130(3), 374-384.
- Redlich, M., Roos, H.A., Reichenberg, E., Zaks, B., Mussig, D., Baumert, U., Golan, I., Palmon, A. (2004). "Expression of tropoelastin in human periodontal ligament fibroblasts after stimulation of orthodontic force". *Arch Oral Biol*, 49:119–124.
- Relethford, D. J. H., & Harpending, H. C. (1994). "Cranio-metric variation, genetic theory, and modern human origins". *American Journal of Physical Anthropology*, 95(3), 249-270.

- Relethford, J. H., & Smith, F. H. (2018). Cranial measures and ancient DNA both show greater similarity of Neandertals to recent modern Eurasians than to recent modern sub-Saharan Africans. *American journal of physical anthropology*, 166(1), 170-178.
- Reyes-Centeno, H., Ghirotto, S., & Harvati, K. (2017). “Genomic validation of the differential preservation of population history in modern human cranial anatomy”. *American journal of physical anthropology*, 162(1), 170-179.
- Reyment, R.A. (1991). *“Multidimensional Palaeobiology”*. Pergamon Press, Oxford, UK.
- Reyment, R.A., R.E. Blackith, & N.A. Campbell. (1984). *“Multivariate Morphometrics”*. Second edition. Academic Press, London.
- Reyment, R.A. & K.G. Jöreskog. (1993). *“Applied Factor Analysis in the Natural Sciences”*. Cambridge University Press, Cambridge, UK.
- Rencher, A. C. (1995). *“Methods of multivariate analysis”*. New York: John Wiley & Sons.
- Rencher, A. C., & Schaalje, G. B. (2008). *“Linear models in statistics”*. Hoboken, NJ: Wiley.
- Reusser, C., Mohr, M., Russenberger, C., Mango, E., & Badertscher, T. (2010). ‘Forschungen auf dem Monte Iato 2009’. *Antike Kunst*, 53, 114-138.
- Reusser, C., Perifanakis, J., Mohr, M., & Elsener, A. (2015). ‘Forschungen auf dem Monte Iato 2014’. *Antike Kunst*, 58, 111-128.

- Richtsmeier, J. T., & Lele, S. (1993). ‘‘A coordinate-free approach to the analysis of growth-patterns: Models and theoretical considerations’’. *Biological Reviews of the Cambridge Philosophical Society*, 68, 381_411.
- Rice, D.P., Kim, H.J., Thesleff, I. (1997). ‘‘Detection of gelatinase B expression reveals osteoclastic bone resorption as a feature of early calvarial bone development’’. *Bone*, 21:479–486.
- Rice, D.P., Rice, R., (2003) ‘‘Thesleff I: Molecular mechanisms in calvarial bone and suture development, and their relation to craniosynostosis’’. *Eur J Orthod*, 25:139–148.
- Rice, D.P. (2005). ‘‘Craniofacial anomalies: from development to molecular pathogenesis’’. *Curr Mol Med*, 5:699–722
- Rice D.P. (2008) ‘‘*Craniofacial Sutures*’’. Karger. 236 pp.
- Ripley, W. Z. (1899). ‘‘*The races of Europe: A sociological study*’’. (Vol. 189). D. Appleton.
- Rieppel, O. (1993). ‘‘*Patterns of diversity in the reptilian skull*’’. in Haken J, Hall BK (eds): *The Skull*. Chicago, University of Chicago Press, vol 2: *Patterns of Structural and Systematic Diversity*, pp 344–390.
- Rightmire, G. P. (1976). ‘‘Multidimensional scaling and the analysis of human biological diversity in subsaharan Africa’’. *American Journal of Physical Anthropology*, 44(3), 445-451.
- Rollet, E. (1888). ‘‘De la mensuration des os longs des membres’’. *Lyon: Storck*.

- Rohlf, F. J., & Slice, D. E. (1990). "Extensions of the Procrustes method for the optimal superimposition of landmarks". *Systematic Zoology*, 39, 40_59.
- Rohlf, F. J., & Corti, M. (2000). "Use of two-block partial least-squares to study covariation in shape". *Systematic Biology*, 49, 740_753.
- Rohlf, F. J., & Bookstein, F. L. (2003). "Computing the uniform component of shape variation". *Systematic Biology*, 52, 66_69.
- Rohlf, F. J. (2009). "tpsRegr 1.37". *Ecology and evolution*. State University of New York at Stony Brook.
- Romana, L. (a cura di) (2009). '*Caltavuturo*'. Atlante dei beni culturali. Istituto Poligrafico Europeo.
- Romer, A.S. (1958). '*The Osteology of the Reptilia*'. Chicago, University of Chicago Press.
- Roseman, C. C. (2004). "Detecting interregionally diversifying natural selection on modern human cranial form by using matched molecular and morphometric data". *Proceedings of the National Academy of Sciences*, 101(35), 12824-12829.
- Rosing, F.W. (1988). "Korperhohenrekonstruktion aus skelettmassen". *Anthropologie: Handbuch der vergleichenden Biologie des Menschen*.
- Roth, V. L. (1993). '*On three-dimensional morphometrics, and on the identification of landmark points*'. In L. F. Marcus, M. Corti, A. Loy, G. J. P. Naylor, & D. E. Slice (Eds.), *Advances in morphometrics* (pp. 41_62). New York: Plenum.

- Roth, D.A., Longaker, M.T., McCarthy, J.G., Rosen, D.M., McMullen, H.F., Levine, J.P., Sung, J., Gold, L.I. (1997). “Studies in cranial suture biology. I. Increased immunoreactivity for TGF-beta isoforms beta 1, beta 2, and beta 3) during rat cranial suture fusion”. *J Bone Miner Res*, 12:311–321.
- Rothwell, B. R. (1995). “Bitemarks in forensic dentistry: A review of legal, scientific issues”. *Journal of the American Dental Association*, 126, 223_232.
- Ruber, L., & Adams, D. C. (2001). “Evolutionary convergence of body shape and trophic morphology in cichlids from Lake Tanganyika”. *Journal of Evolutionary Biology*, 14, 325_332.
- Ruggieri, G. (1973). “Due parole sulla paleogeografia delle isole minori a Ovest ea Nord della Sicilia”. *Biogeographia–The Journal of Integrative Biogeography*, 3(1).

S

- Sadori, L., Zanchetta, G., & Giardini, M. (2008). “Last Glacial to Holocene palaeoenvironmental evolution at Lago di Pergusa (Sicily, Southern Italy) as inferred by pollen, microcharcoal, and stable isotopes”. *Quaternary International*, 181(1), 4-14.
- Saint-Hilaire, É. G. (1830). *‘Principes de philosophie zoologique’*. Pichon et Didier.

- Saitou, N., & Nei, M. (1987). "The neighbor-joining method: a new method for reconstructing phylogenetic trees". *Molecular biology and evolution*, 4(4), 406-425.
- Sampson, P. D., Streissguth, A. P., Barr, H. M., & Bookstein, F. L. (1989). "Neurobehavioral effects of prenatal alcohol: Part II. Partial least squares analysis". *Neurotoxicology and Teratology*, 11, 477_491.
- Sampson, P. D., Bookstein, F. L., Sheehan, H., & Bolson, E. L. (1996). "Eigenshape analysis of left ventricular outlines from contrast ventriculograms". In L. F. Marcus, M. Corti, A. Loy, G.J.P. Naylor, & D.E. Slice (Eds.), *Advances in Morphometrics* (pp. 131_152). Nato ASI Series, Series A: Life Science. New York.
- Santella, M., & Milner, A. R. (2017). "Coupling focus stacking with photogrammetry to illustrate small fossil teeth". *Journal of Paleontological Techniques*, 18, 1-17.
- Schiavo, R. A., & Hand, D. J. (2000). "Ten more years of error rate research". *International Statistical Review*, 68, 295_310.
- Schimmenti, V., Di Salvo, R. (1997). Progetto del Laboratorio Osteologico per l'archivio informatizzato.
- Scott, G.R. (1980). "Population variation of Carabelli's trait". *Human Biology* 52, 63e78.

- Scott, G.R., Turner C.G. (1997) *“The Anthropology of Human Teeth. Dental morphology and its variations in recent human populations”*. Cambridge Studies in Biological Anthropology, Cambridge: Cambridge University Press.
- Sheets, H. D., Corvino, K. M., Panasiewicz, J. M., & Morris, S. R. (2006). “Comparison of geometric morphometric outline methods in the discrimination of age-related differences in feather shape”. *Frontiers in Zoology*, 3.
- Sheets, H. D., Bush, P. J., & Bush, M. A. (2013). “Patterns of Variation and Match Rates of the Anterior Biting Dentition: Characteristics of a Database of 3 D-Scanned Dentitions”. *Journal of forensic sciences*, 58(1), 60-68.
- Sheets, H. D., Kim, K., & Mitchell, C. E. (2004). *“A combined landmark and outline-based approach to ontogenetic shape change in the Ordovician trilobite *Triarthrus becki*”*. In A. M. T. Elewa (Ed.), *Morphometrics: Applications in biology and paleontology* (pp. 67_82). New York: Springer.
- Shellis, R.P. *“Comparative anatomy of tooth attachment”*; in Berkovitz BKB, Moxham BJ, Newman HN (eds): *The Periodontal Ligament in Health and Disease*. Oxford, Pergamon Press, pp 3–24.
- Siegel, M.I., Mooney, M.P., Kimes, K.R., Todhunter, J. (1991). “Developmental correlates of midfacial components in a normal and cleft lip and palate human fetal sample”. *CleftPalate Craniofac J*, 28:408–12.
- Silvana, M., Borgognini, T., & Elena, R. (1985). *“Dietary patterns in the Mesolithic samples from Uzzo and Molara caves (Sicily): the evidence of teeth”*. *Journal of Human Evolution*, 14(3), 241-254.

- Sineo, L., Bigazzi, R., D'Amore, G., Tartarelli, G., Di Patti, C., Berzero, A., & Caramella Crespi, V. (2002). "I resti umani della Grotta di S. Teodoro (Messina): datazione assoluta con il metodo della spettrometria gamma diretta (U/Pa)". *Antropo*, 2, 9-16.
- Sineo, L., Petruso, D., Forgia, V., Messina, A., & D'Amore, G. (2015). "Human peopling of Sicily during Quaternary".
- Slice, D. E., Bookstein, F. L., Marcus, L. F., & Rohlf, F. J. (1996). "A glossary for geometric morphometrics". In L. F. Marcus, M. Corti, A. Loy, G. J. P. Naylor, & D. E. Slice (Eds.), *Advances in morphometrics* (pp. 531_551). New York: Plenum.
- Slice, D. E. (2005). "Modern morphometrics in physical anthropology". Springer, Boston, MA.
- Slon, V., Sarig, R., Hershkovitz, I., Khalaily, H., & Milevski, I. (2014). "The plastered skulls from the Pre-Pottery Neolithic B site of Yiftahel (Israel)—a computed tomography-based analysis". *PloS one*, 9(2).
- Singleton, M., Rosenberger, A. L., Robinson, C., & O'Neill, R. (2011)." Allometric and metameric shape variation in Pan mandibular molars: A digital morphometric analysis". *Anatomical Record _ Advances in Integrative Anatomy and Evolutionary Biology*, 294, 322_334.
- Skinner, M. M., Gunz, P., Wood, B. A., & Hublin, J. J. (2008). "Enamel_dentine junction (EDJ) morphology distinguishes the lower molars of Australopithecus africanus and Paranthropus robustus". *Journal of Human Evolution*, 55, 979_988.

- Snedecor, G. W., & Cochran, W. G. (1980). *“Statistical methods”*. Iowa State University Press.
- Sokal, R.R. & C.D. Michener. (1958). “A statistical method for evaluating systematic relationships”. *University of Kansas Science Bulletin*, **38**: 1409–38.
- Sokal, R.R. & F.J. Rohlf. (1995). *“Biometry: The Principles and Practice of Statistics in Biological Research”*. 3rd edition. W.H. Freeman, New York.
- Sperber, G.H. (2001) *“Craniofacial Development”*. BC Decker Inc Hamilton • London.
- Stains, J.P., Civitelli, R. (2005). “Cell-cell interactions in regulating osteogenesis and osteoblast function”. *Birth Defects Res C Embryo Today*, **75**:72–80.
- Steele, D. G. (1970). “Estimation of stature from fragments of long limb bones”. *Personal identification in mass disasters*, 85.
- Steele, D.G., & McKern, T.W. (1969). “A method for assessment of maximum long bone length and living stature from fragmentary long bones”. *American Journal of Physical Anthropology*, **31**(2), 215-227.
- Stein, B. R. (1981). “Comparative limb myology of two opossums, *Didelphis* and *Chironectes*”. *Journal of Morphology*, **169**, 113_140.
- Streissguth, A. P., Bookstein, F. L., Sampson, P. D., & Barr, H. M. (1993). *“The enduring effects of prenatal alcohol exposure on child development: Birth through seven years, a partial least squares solution”*. Ann Arbor, MI: University of Michigan Press.

- Spatafora, F. (2010). "Indigeni e Greci negli emporia fenici della Sicilia". In *Meetings between Cultures in the Ancient Mediterranean* (pp. 34-46).
- Sperber G.H., Guttman G.D., Sperber S.M. (2001). "*Craniofacial Development*" BC Decker Inc. 220 pp.
- Spurzheim, J. G., & Gall, F. J. (1815). "*Syllabus of a Demonstrative Course of Lectures on Drs. Gall and Spurzheim's Physiognomical System*". Wood & Company.
- Standring, S. (2017). "*Anatomia del Gray 41*". ed.: 2 Volumi. Edra.
- Stock, J. T., Lahr, M. M., & Kulatilake, S. (2007). "Cranial diversity in South Asia relative to modern human dispersals and global patterns of human variation". In *The evolution and history of human populations in South Asia* (pp. 245-268). Springer, Dordrecht.
- Strauss, R. E., & Bookstein, F. L. (1982). "The truss _ body form reconstructions in morphometrics". *Systematic Zoology*, 31, 113_135.
- Swiderski, D. L. (1993). "Morphological evolution of the scapula in tree squirrels, chipmunks, and ground squirrels (Sciuridae): An analysis using thin-plate splines". *Evolution*, 47, 1854_1873.
- Swiderski, D. L., & Zelditch, M. L. (2010). "Morphological diversity despite isometric scaling of lever arms". *Evolutionary Biology*, 37, 1_18.

T

- Taylor, M. E. (1974). "The functional anatomy of the forelimb of some African Viverridae (Carnivora)". *Journal of Morphology*, 143, 307_336.
- Testut L. (1942). '*Anatomia Umana – apparato digerente*'. L.III, UTET, Torino.
- Thompson, D. A. W. (1992). "*On growth and form: The complete revised edition (2nd ed.)*". New York: Dover reprint of 1942.
- Tibbetts, G. L. (1981). Estimation of stature from the vertebral column in American Blacks. *Journal of Forensic Science*, 26(4), 715-723.
- Todd, T., Lyon, D. (1925). "Cranial suture closure. Its progress and age relationship. II. Ectocranial closure in adult males of white stock". *Am J Phys Anthropol*, 8:23–45.
- Tomes, C.S. (1923). "*A Manual of Dental Anatomy – Human and Comparative*". London, Churchill.
- Trotter, M. (1970). "Estimation of stature from intact long limb bones". *Personal identification in mass disasters*, 71-83.
- Trotter, M., & Gleser, G.C. (1952). "Estimation of stature from long bones of American Whites and Negroes". *American journal of physical anthropology*, 10(4), 463-514.

- Trotter, M., & Gleser, G.C. (1958). "A re-evaluation of estimation of stature based on measurements of stature taken during life and of long bones after death". *American journal of physical anthropology*, 16(1), 79-123.
- Turner II C. G., Nichol M., Scott J. (1991). "Scoring procedures for key morphological traits of the permanent dentition" The Arizona State University Dental Anthropology System". *Advances in Dental Anthropology*, New York.
- Tusa, S., & Valente, I. (1994). "La ricerca archeologica in contrada Stretto-Partanna: il fossato/trincea neolitico". *La Preistoria del Basso Belice e della Sicilia meridionale nel quadro della preistoria siciliana e mediterranea. Società Siciliana di Storia Patria. Palermo*, 177-195.
- Tusa, S., Lentini, L., & Valente, I. (1997). "*L'insediamento dell'età del bronzo con bicchiere campaniforme di Marcita: Castelvetrano (Trapani)*". Soprintendenza per i beni culturali e ambientali.
- Tusa, S., & Di Salvo, R. (1999). "*Partanna nella preistoria: l'insediamento di Stretto*". Edizioni d'Arte" Città di Partanna".
- Tyler, M.S, Hall, B, K., (1977). "Epithelial influences on skeletogenesis in the mandible of the embryonic chick". *Anat Rec*, 188:229–239.

U

- Ubelaker, D. H. (1989). "*Human skeletal remains. Excavation, analysis, interpretation*". Ed Taraxacum Washington.

V

- Vacher de Lapouge G. (1899) ‘L'Aryen et son rôle social’.
- Van Bocxlaer, B., & Schultheiß, R. (2010). “Comparison of morphometrics techniques for shapes with few homologous landmarks based on machine-learning approaches to biological discrimination”. *Paleobiology*, 36, 497_515.
- Van Buskirk, J. (2009). “Natural variation in morphology of larval amphibians: Phenotypic plasticity in nature?”. *Ecological Monographs*, 79, 681_705.
- Vassallo, S. (2009). ‘Indagini preliminari alla Terravecchia di Caltavuturo’. *Kokalos XLVII-XLIII*, pp. 679-686.
- Velhagen, W. A., & Roth, V. L. (1997). “Scaling of the mandible in squirrels”. *Journal of Morphology*, 232, 107_132.
- Virchow R., (1885) "*Nordic mysticism*". Anthropology Congress in Karlsruhe.
- Walker, A., Hoeck, H. N., & Perez, L. (1978). “Microwear of mammalian teeth as an indicator of diet”. *Science*, 201(4359), 908-910.

W

- Walker, J. A. (2000). “Ability of geometric morphometric methods to estimate a known covariance matrix”. *Systematic Biology*, 49, 686_696.
- Wang, J.H-C., Yang, G., Li, Z. (2005). “Controlling cell responses to cyclic mechanical stretching”. *Ann Biomed Eng*, 33:337–342.

- Weber, G. W., Bookstein, F. L., & Strait, D. S. (2011). "Virtual anthropology meets biomechanics". *Journal of biomechanics*, 44(8), 1429-1432.
- Webber, A. J., & Hunda, B. R. (2007). Quantitatively comparing morphological trends to environment in the fossil record (cincinnatian series; upper ordovician). *Evolution*, 61, 1455_1465.
- Webster, M., & Hughes, N. C. (1999). "Compaction-related deformation in Cambrian olenelloid trilobites and its implications for fossil morphometry". *Journal of Paleontology*, 73(2), 355_371.
- Webster, M., Sheets, H. D., & Hughes, N. C. (2001). "Allometric patterning in trilobite ontogeny: testing for heterochrony in *Nephrolenellus*". In M. L. Zelditch (Ed.), *Beyond heterochrony: The evolution of development*. (pp. 105_144). New York: John Wiley & Sons.
- Webster, M. (2007). "Ontogeny and evolution of the early Cambrian trilobite genus *Nephrolenellus* (Olenelloidea)". *Journal of Paleontology*, 81, 1168_1193.
- Webster, M. (2009). "Ontogeny, systematics, and evolution of the effaced early Cambrian trilobites *peachella* Walcott, 1910 and *Eopeachella* new genus (Olenelloidea)". *Journal of Paleontology*, 83, 197_218.
- Wescott, D. J. (2005). "Population variation in femur subtrochanteric shape". *Journal of Forensic science*, 50(2), JFS2004281-8.
- Whitehouse, R. D. (Ed.). (2016). "Gender & Italian Archaeology: Challenging the Stereotypes". *Routledge*.

- Williams, S. T., Hall, A., & Kuklinski, P. (2012). “Unraveling cryptic diversity in the Indo-West Pacific gastropod genus *Lunella* (Turbinidae) using elliptic Fourier analysis”. *American Malacological Bulletin*, 30, 189_206.
- Willmore, K. E., Roseman, C. C., Rogers, J., Cheverud, J. M., & Richtsmeier, J. T. (2009). “Comparison of mandibular phenotypic and genetic integration between baboon and mouse”. *Evolutionary Biology*, 36, 19_36.
- Wilson, R. J. A. (1982). “Archaeology in Sicily, 1977–1981”. *Archaeological Reports*, 28, 84-105.
- Wilson, R. J. A. (1996). “Archaeology in Sicily 1988-1995”. *Archaeological Reports*, 42, 59-123.
- White, T. D., & Folkens, P. A. (2005). ‘*The human bone manual*’. Elsevier.
- White, T. D., Black, M. T., & Folkens, P. A. (2011). “*Human osteology*”. Academic press.
- Witten, I. H., & Frank, E. (2005). “Data mining: Practical machine learning tools and techniques”. San Francisco: Morgan Kaufmann.
- Wold, H. (1966). “*Estimation of principal components and related models by iterative least squares*”. In P. R. Krishnaiah (Ed.), *Multivariate analysis* (pp. 391_420). New York: Academic Press.
- Wold, S., Sjostrom, M., & Erickson, L. (2001). “PLS-regression: A basic tool of chemometrics”. *Chemometrics and Intelligent Laboratory Systems*, 58, 109_130.

- Woo, SL-Y., Akeson, W.H. (1987). “Response of tendons and ligaments to joint loading and movements”; in Helminen HJ, Tammi M, Kiviranta I, Paukkonen K, Säämänen A-M, Jurvelin J (eds): *Joint Loading*. Bristol, Wright, pp 287–315.

- Wood, A. R., Zelditch, M. L., Rountrey, A. N., Eiting, T. P., Sheets, H. D., & Gingerich, P. D. (2007). ‘Multivariate stasis in the dental morphology of the Paleocene-Eocene condylarth. *Ectocion*’. *Paleobiology*, 33, 248_260.

Y

- Yee, W. L., Chapman, P. S., Sheets, H. D., & Unruh, T. R. (2009). “Analysis of body measurements and wing shape to discriminate *Rhagoletis pomonella* and *Rhagoletis zephyria* (Diptera: Tephritidae) in Washington State”. *Annals of the Entomological Society of America*, 102, 1013_1028.

Z

- Zanchetta, G., Borghini, A., Fallick, A. E., Bonadonna, F. P., & Leone, G. (2007). “Late Quaternary palaeohydrology of Lake Pergusa (Sicily, southern Italy) as inferred by stable isotopes of lacustrine carbonates”. *Journal of Paleolimnology*, 38(2), 227-239.

- Zelditch M. L., Swiderski D.L., Sheets H.D. (2012) “*Geometric morphometrics for biologists: a primer*” Academic Press. 478 pp.

- Zelditch, M. L., Bookstein, F. L., & Lundrigan, B. L. (1992). “Ontogeny of integrated skull growth in the cotton rat *Sigmodon fulviventer*”. *Evolution*, 46, 1164_1180.

- Zelditch, M. L., Bookstein, F. L., & Lundrigan, B. L. (1993). "The ontogenetic complexity of developmental constraints". *Journal of Evolutionary Biology*, 6, 121_141.
- Zelditch, M. L., Sheets, H. D., & Fink, W. L. (2000). "Spatiotemporal reorganization of growth rates in the evolution of ontogeny". *Evolution*, 54, 1363_1371.
- Zelditch, M. L., Sheets, H. D., & Fink, W. L. (2003a). "The ontogenetic dynamics of shape disparity". *Paleobiology*, 29, 139_156.
- Zelditch, M. L., Lundrigan, B. L., Sheets, H. D., & Garland, J. T. (2003b). "Do precocial mammals have a fast developmental rate? A comparison between *Sigmodon fulviventer* and *Mus musculus domesticus*". *Journal of Evolutionary Biology*, 16, 708_720.
- Zelditch, M. L., Wood, A. R., Bonett, R. M., & Swiderski, D. L. (2008). "Modularity of the rodent mandible: Integrating bones, muscles, and teeth". *Evolution & Development*, 10(6), 756_768.
- Zelditch, M. L., Wood, A. R., & Swiderski, D. L. (2009). "Building developmental integration into functional systems. Function-induced integration of mandibular shape". *Evolutionary Biology*, 36, 71_87.
- "CT Scan (CAT Scan, Computerized Tomography) Imaging Procedure". *MedicineNet*. Retrieved 2018-11-29.

Appendix1

Didactics.

Received:

- ✓ Statistics.

Prof. Alberto Lombardo. UNIPA 08/11/2016 – 15/12/2016 – 30h.

- ✓ English Course B2.

Various Professors. UNIPA 20/02/2017 – 12/04/2017 – 30h.

- ✓ How to write a great research paper - tips & tricks and what not to do.

Prof. Livan Fratini – Prof. Eleonora Riva. UNIPA 14/03/2017- 4h.

- ✓ Acoustic and councations in cetacean species.

Dr. Elena Papale. UNIPA 24/03/2017 – 2h.

- ✓ Conference- Olte il Transgenico: Nuovi Approcci Sostenibili per una Moderna Agricoltura.

Various Speakers. UNIPA 27/03/2017 – 4h.

- ✓ Spin-off Accademico: fare impresa all'Università di Palermo.

Various Speakers. UNIPA 29/03/2017 – 4h.

- ✓ La determinazione della porosità mediante porosimetro.

Dr. Luca Corno (Univ.of Milano). UNIPA 20/04/2017 – 2h.

- ✓ Porosità e ricerca: indagini sulle strutture cellulari e recalcitranza della biomassa.

Dr. Luca Corno (Univ.of Milano). UNIPA 21/04/2017 – 2h.

- ✓ User experience design and practices.
Various Speakers. UNIPA 15/06/2017 – 2h.
- ✓ Biotechnology for Plant Conservation.
Prof. Jorge M. Canhoto (Univ. of Coimbra). UNIPA 16/06/2017 – 2h.
- ✓ Introduzione alle tecniche cromatografiche.
Dr. Filippo Saiano. UNIPA 29/09/2017 – 2h.
- ✓ PhD Traineeship: Digital natomy and geometric morphometrys,
applied to the study of the human skull.
Dr. Emiliano Bruner. CENIEH 2/10/2017 - 20/10/2017.
- ✓ PhD Co-Tutorship.
Prof. Miguel Jover-Cerdá - Prof. Vicente Domingo Estruch-Fuster.
UPV 23/10/2017 – 23/04/2017.
- ✓ Documentacion Cientifica.
Various Professors. UPV 2017 – 20h.
- ✓ Estadistica y Metodos Matematicos para la Investigacion –
introduccion a las Tecnicas Estadisticas para la Investigacion.
Various Professors. UPV 2017 – 20h.
- ✓ Emprendimiento – Emprendimiento y Creacion de Start-UP.
Various Professors. UPV 2017 – 20h.
- ✓ Perspectiva de Genero en la Investigacion.
Various Professors. UPV 2017 – 20h.
- ✓ Weed Biology.
Prof. Mercedes Vedeguer-Sancho. UPV 2018 – 30h.

- ✓ Elsevir on Campus.
Various Speakers. UNIPA 21/05/2018 – 2h.
- ✓ Bioindicators and Biomarkers: practical examples of the use of immune biomarkers for the study of animal welfare.
Prof. Mirella Vazzana. UNIPA 29/05/2018 – 2h
- ✓ Kick off Meeting: Biotechnologies for Human Health and Bule Growth – BYTHOS.
Prof. Vincenzo Arizza and various speakers. UNIPA 26/06/2018 – 8h.
- ✓ Kick off Meeting: Scarti Ittici-Valorizzazione e sfruttamento biotecnologico.
Prof. Vincenzo Arizza and various speakers. UNIPA 12/07/2018 – 8h.
- ✓ PhD Traineeship: Physical Anthropology.
Prof. Armando González-Martín – Prof. Oscar Cambra-Moo.
UAM 29/10/2018 - 29/04/2019
- ✓ Documentación, excavación y estudio de restos óseos
Prof. Armando-González Martín. UAM 13/02/2019 - 28/02/2019 – 36h.
- ✓ Paleodemografía.
Prof. Armando González-Martín. UAM 20/03/2019 - 05/04/2019 – 36h.

Imparted:

- ✓ Skeletal and Biomechanical aspects in the erect posture in Homo.
Bachelor Degree in Biological Sciences and Bachelor Degree in Natural and Environmental Sciences - Comparative Anatomy Courses.
UNIPA 2017 -2018 - 2019 - 2020.
- ✓ Burned Human Remains - Analysis and Interpretation of Archaeological Findings.
Bachelor Degree in Archaeology -Palaeoanthropology Course.
UNIPA 2017 - 2018 - 2019 - 2020.
- ✓ Determination of Sex through the DSP -Probabilistic Sex Analysis.
Bachelor Degree in Archaeology - Palaeoanthropology Course
UNIPA 2017 - 2018 - 2019 - 2020.
- ✓ Photogrammetry and its Applications on Physical Anthropology.
Master Degree in Natural and Environmental Sciences – Biological Anthropology Course.
UNIPA 2019.
- ✓ Laboratory Practice of Physical Anthropology support and assistance. Master Degree in Natural and Environmental Sciences and Bachelor Degree in Archaeology - Biological Anthropology and Palaeoanthropology Courses.
UNIPA 2017 - 2018 - 2019 - 2020.

✓ Tutor of Life Science.

Providing assistance and Tutoring for Bachelor Degree Students.

UNIPA 26/04/2018-28/10/2018 and 27/06/2019-27/02/2020.

Appendix2

Scientific Production.

Research Publications:

- ✓ PIAZZA ARMERINA, VILLA DEL CASALE: SCAVI E STUDI NEL DECENNIO 2004-2014. Edited by Pensabene P. & Barresi P. <<L'Erma>> di Bretschneider Ed. (2019). Sepolture Medievali nel settore meridionale delle Terme Sud: Saggio II. –Arabito S., Meli F., **Lauria G.** pp. 591-597.
- ✓ PIAZZA ARMERINA–L'AREA NORD DELL' INSEDIAMENTO MEDIOEVALE PRESSO LA VILLA DEL CASALE. INDAGINI ARCHEOLOGICHE 2013-2014. Edited by Bonanno C. Tyche/Edizioni (2018). Relazione antropologica preliminare inumato 1386 -Miccichè R., Valenti P. **Lauria G.** Bellomo G. Sineo L. pp. 161-164.
- ✓ **Lauria G.**, Sconzo P., Falsone G., Sineo L. NEW ANTHROPOLOGICAL DATA FROM THE ARCHAIC NECROPOLIS AT MOTYA (2013 EXCAVATION SEASON). Folia Phoenicia. 2: 250-252 (2018) DOI: 10.19272/201813201037.
- ✓ **Lauria G.**, Sconzo P., Falsone G., Sineo L. HUMAN REMAINS AND FUNERARY RITES IN THE PHOENICIAN NECROOLIS OF MOTYA Sicily). Int. J. Osteoarchaeol. 27: 1003–1011 (2017) DOI: 10.1002/oa.2611.

Conference Posters and Presentations:

- ✓ **Lauria G.** & Sineo L. "PHOTOGRAMMETRY AND GEOMETRIC MORPHOMETRICS IN THE STUDY OF BIODIVERSITY IN *Homo sapiens*". (Indigenous and Settlers in ancient Sicily). In Acts of XXIII Congresso dell'Associazione Antropologica Italiana, patrocinato dall'Università di Padova (Padova –Italia 4-6 Settembre 2019).
- ✓ Mina' G., **Lauria G.**, Sconzo P., Falsone G., Sineo L. "THE ARCHAIC NECROPOLIS OF MOTYA – ANTHROPOLOGICAL ANALYSIS (EXCAVATION 2017)". In Acts of XXIII Congresso dell'Associazione Antropologica Italiana, patrocinato dall'Università di Padova (Padova –Italia 4-6 Settembre 2019).
- ✓ Sineo L., Carotenuto G., Di Patti C., Molino M., Vita G., Garilli V., **Lauria G.**, D'Amore G., Micciche' R. "A TOTAL BODY COMPUTED TOMOGRAPHY OF THE EPIGRAVETTIAN SKELETON OF SAN TEODORO1 (ST1): APPLICATION IN SKELETAL BIOLOGY, 3D MODELING AND DIGITAL DISSEMINATION OF ANTHROPOLOGICAL DATA". In Acts of XXIII Congresso dell'Associazione Antropologica Italiana, patrocinato dall'Università di Padova (Padova –Italia 4-6 Settembre 2019).
- ✓ **Lauria G.**, Sconzo P., Falsone G., Sineo L. "CHILD INHUMATIONS AT THE ARCHAIC NECROPOLIS OF MOTYA (EXCAVATION SEASONS 2013-2017)". IX Congreso Internacional de Estudios Fenicios y Punicos (Merida-España 22-26 Octubre 2018). Poster DOI: 10.13140/RG.2.2.20298.21444.

- ✓ **Lauria G.**, Sconzo P., Falsone G., Sineo L. “STUDI ANTROPOLOGICI A MOZIA (CAMPAGNE 2013-2016)”. In Acts of XXII Congresso dell’Associazione Antropologica Italiana, patrocinato dall’Università di Roma “Tor Vergata” (Villa Mondragone-Monteporzio Catone, Roma 6-8 settembre 2017). Poster DOI: 10.13140/RG.2.2.19623.24487.
- ✓ Cangialosi E.O., **Lauria G.**, Basile R., Bellomo G., Calandra R., Canale A., Cusimano S., Puleri G., Interlandi N., Meli F., Miccichè R., Toscano-Raffa A., Sineo L. “ANALISI ANTROPOLOGICA DEI RESTI TARDO-ANTICHI DI LICATA (AG)”. In Acts of XXII Congresso dell’Associazione Antropologica Italiana, patrocinato dall’Università di Roma “Tor Vergata” (Villa Mondragone Monteporzio Catone, Roma 6-8 settembre 2017).
- ✓ Meli F., **Lauria G.**, Cangialosi E.O., Basile R., Fariselli A.C., Sineo L. “LE INCINERAZIONI TARDO-PUNICHE A PANTELLERIA: LO SCAVO DELLA PROPRIETÀ LO RILLO”. In Acts of XXII Congresso dell’Associazione Antropologica Italiana, patrocinato dall’Università di Roma “Tor Vergata” (Villa Mondragone-Monteporzio Catone, Roma 6-8 settembre 2017).

Acknowledgements

PhD Thesis is The End of a Long Period of three years of Work, Study and Effort.

It would be impossible to do without the support and the encouragement of several people and institutions. For this, it is right to thank all of them!

Special thanks are undoubted, for Professor Luca Sineo and his endless availability and attention shown during my training, from Bachelor Degree to the PhD. Also thanks for the painstaking help to expand my knowledge in the field Physical Anthropology.

In the same way I thank the Phd Coordinator Prof. Maria Antonietta Germana' and my Laboratory (Eamuele Cangialosi, Salvatore Ficarra, Roberto Micciche' and all the others) and PhD colleagues (Leopoldo De Simone, Manuela Mauro, Nicolo' Iacuzzi, Antonino Ioppolo Antonino, Jouini' Amira, Luca Vecchioni), for continuous advice and care during the last years.

I also thank the Referees Prof. Rugero D'Anastasio (Universita' degli Studi "G. d'Annunzio" Chieti-Pescara), Dr. Martin Friess (Muséum national d'Histoire Naturelle, Musée de l'Homme - Paris), Prof. Jesús Marugán-Lobón (Universidad Autonoma de Madrid) and Prof. Alejandro Romero-Rameta (Universidad de Alicante) for the priceless advices and and helpful review.

The **Following Acknowledgements** are for the **Irreplaceable Contributions** given by institutions and people who made this project possible.

For purely practical reasons, other institutions and people that Played a Primary Role will be listed alphabetically (not for importance):

Thanks to:

- Archaeological Museum “A. Salinas”. (Palermo - Sicily – Italy).

Dr. Francesca Spatafora for the authorization to study the materials.

Extremely grateful to Dr. Rosaria Di Salvo and Dr. Vittoria Schimmenti for heir irreplaceable kindful help during the last ten years.

To both my best heartfelt thanks!

- Archaeological Museum “Baglio Anselmi”. (Marsala - Sicily – Italy).

Dr. Maria Grazia Griffo for the authorization to study the materials.

- Archaeological Museum “Bernabò-Brea”. (Aeolian Island - Sicily – Italy).

Dr. Maria Amalia Mastelloni for the authorization to study the materials.

- Centro Nacional de Investigación Sobre la Evolución Humana (CENIEH) – (Burgos – Spain).

Dr. Emiliano Bruner and his research group for the kindful, irreplaceable help, the unending support and friendship shown to me.

- Geological University Museum of Palermo “Gemmellaro”. Sicily – Italy.

Dr. Carolina Di Patti for the authorization to study the materials.

- Laboratorio de Poblaciones del Pasado (LAPP) – Universidad Autonoma de Madrid (UAM) – (Madrid-Spain).

Prof. Armando González Martín, Prof. Oscar Cambra-Moo and the entire laboratory not only for the invaluable help but also for making me feel part of the wonderful group.

- Laboratorio de Ecología Evolutiva Humana (LEEH) - Universidad Nacional del Centro de la Provincia de Buenos Aires (UNCPBA). (Buenos Aires - Argentina).

All the laboratoy directors to provide the modern specimens of reference sample.

- Municipality of Alia. (Sicily – Italy).

The Mayor Mr. Felice Guglielmo, Mr. Salvatore Ventimiglia and Mr. Gioacchino Runfola for the availability shown.

- Municipality of Caltavuturo. (Sicily – Italy).

The Mayor Mr. Domenico Giannopolo, the council member of cultural heritage Mrs. Nieta Gennuso and Dr. Filippo Ianni’ for the excavation seasons and the authorization to study the materials.

- Museum of Mozia. (Sicily – Italy).

The Whitaker foundation and Dr. Pamela Toti for the authorization to study the materials.

- Soprintendenza BB.CC.AA. di Palermo. (Sicily – Italy).

Dr. Stefano Vassallo and Dr. Maria Grazia Cucco for the opportunity of the excavations in Caltavuturo and authorization to study the materials.

- Soprintendenza BB.CC.AA. di Trapani. (Sicily – Italy).

To the Soprintendente and Dr. Rossella Giglio for the authorization to study the materials.

- Township Museum of Mussomeli. (Sicily – Italy).

For the authorization to study the materials

- University of Innsbruck (Austria – Innsbruck).

Prof. Erich Kistler and Dr. Nicole M\"olk for the authorization to study the materials, the kindness and the excellent hospitality.