TESIS DOCTORAL



UNIVERSITAT
POLITÈCNICA
DE VALÈNCIA

Effect of farm management on antimicrobial resistance and intestinal microbiota in poultry production



PhD Thesis by

Laura Montoro Dasí

Thesis Directors

Dra. Clara Marín Orensa

Dra. Arantxa Villagrà García

Valencia, June, 2021

Programa de Doctorado en Ciencia y Tecnología de la Producción Animal

UNIVERSITAT POLITÈCNICA DE VALÈNCIA

**Effect of farm management on
antimicrobial resistance and intestinal
microbiota in poultry production**

A thesis submitted to the Polytechnic University of Valencia in partial fulfilment of the requirements for the degree of Doctor of Philosophy

By

Laura Montoro Dasí

Sig.

Thesis Directors

Dra. Clara Marín Orenga

Dra. Arantxa Villagrà García

Sig.

Sig.

A todas las personas que me han ayudado a llegar hasta aquí

ACKNOWLEDGEMENTS

Si tuviera que definir estos años con una palabra sería, sin duda alguna, intensidad. Nunca imaginé que la realización de una tesis doctoral supusiera tanto esfuerzo físico, mental y emocional. Por todo ello, nada hubiera sido posible sin todas las personas que han estado a mi lado, y a quienes quiero dar las gracias.

Todo empezó un día allá por segundo de carrera, cuando inocentemente le pregunté a Clara Marín si podía colaborar en su grupo... ¡No sabía dónde me metía! Tras miles y miles de medios preparados, risas y llantos, pero sobre todo muchas, muchas, muchas horas de trabajo e infinitas lecciones de microbiología y de vida, empezamos la etapa de la tesis. Todo lo que consiga en mi vida laboral será en gran parte por todo lo que me has enseñado, por tu paciencia infinita y tu cariño con cada fallo o cada crisis (que han sido muchas), por tu alegría con cada uno de mis pequeños logros, y por guiarme y animarme en cada momento de bloqueo durante todos estos años, que ya son muchos. Siempre serás mi jefa, es una realidad, ya lo sabes.

Recuerdo también como si fuera ayer aquel primer día en el CITA, llegando llena de ilusión y de nervios: mi primer día de tesis. En aquel momento, conocí a mi otra directora, Arantxa Villagrà. En cuanto llegué me adoptó con una enorme sonrisa sin ni siquiera conocerme, dándome una de las oportunidades más importantes de mi vida (aunque ahora creo que lo de limpiar las naves el primer día fue una prueba...). Gracias por tu paciencia (especialmente con los pedidos de material y los presupuestos) y por haber estado enseñándome, escuchándome, animándome y cuidándome durante estos tres intensos y dramáticos años.

En este momento, también es necesario nombrar a Fernando Estellés, mi tutor de la UPV, por ayudarme en todos los temas burocráticos de la tesis; pero también a Paco Marco, por enseñarme con tanta paciencia como a una doctoranda más.

Desde el inicio de mi trayectoria en el mundo de la ciencia, he tenido la enorme suerte de formar parte de un gran grupo de investigación: CampySalmo. En él, Santiago Vega, siempre ha estado dispuesto a ayudarnos, desde barrer naves y llenar puntas cuando nos

ha visto sobrepasadas, hasta ilustrarnos con sus ideas y sus conocimientos adquiridos en años y años de educación e investigación.

Pero no solo él, también mis adoradas compañeras, que han llegado a ser mis queridísimas amigas, han estado a mi lado tanto en los momentos buenos como los malos, convirtiendo estos años en inolvidables. Primero llegaron Estefanía Montero y Sandra Sevilla, con las que viví los inicios en el grupo, años que incluyen infinitas anécdotas inenarrables tanto en el laboratorio como en la granja, y viajes eternos en coche, llenos de risa, música y confidencias. Especialmente Sandra, gracias por tu inestimable ayuda durante todo el proceso de la tesis, sin ti sobrevivir hubiera sido imposible... Tiempo después llegó Laura Lorenzo (más conocida como Laura 2) dispuesta a revolucionar el grupo, con su adorable torpeza, sus cotilleos únicos y su energía imparable. Gracias a todos por ayudarme siempre que lo he necesitado, y por vuestra alegría y cariño día a día.

No puedo cerrar el apartado dedicado a la Universidad CEU sin nombrar a todos los alumnos internos que han formado parte del grupo, especialmente a Aitor Devesa y Guillem Valero, que estuvieron a mi lado en la realización de las pruebas experimentales, salvándome la vida y haciendo los días mucho más divertidos, ambientados con canciones a voz de tenor y poses en espejos a altas horas de la tarde.

Durante estas pruebas, también estuvieron a mi lado los pecuarios del CITA, Ángel, Antonio y Pepe, a los que quiero agradecer su ayuda siempre que les he llamado pidiendo auxilio.

Tras terminar esta primera etapa, gracias a la oportunidad de Pablo Catalá, pude empezar a trabajar en CECAV, lo cual incrementó la intensidad del proceso, pero también me ha enseñado muchas cosas. Pablo, gracias por tu paciencia, por hacerme sentir una más desde el primer día, y por ayudarme siempre que puedes en todo lo que necesito, aunque vayas “petao”.

Por supuesto, nunca hubiera llegado hasta aquí sin el apoyo incondicional de mi familia, especialmente de mis padres, que me han convertido en la persona que soy hoy en día.

Gracias por vuestro amor y cariño, gracias por todos los esfuerzos que habéis hecho para traerme hasta aquí, tanto económicos como emocionales. Gracias por escucharme y aconsejarme siempre y gracias, en definitiva, por ser los mejores padres que podría desear. Mamá, gracias por criarnos con tanto amor, pero también con tanta firmeza, que me ha hecho capaz de llegar hasta aquí. Gracias por las cenas en bandejas en los días agotadores o las horas en el hospital con mis migrañas, y gracias por las veces que me has acurrucado mientras lloraba, pero también por las que me has obligado a levantarme. Gracias por ayudarme siempre que puedes, aunque tengas que dejarlo todo, o incluso aunque no estés conmigo, a través de tu abrazo rosa. Gracias. A ti papá, gracias por entenderme siempre, por enseñarme a sacar el lado positivo y divertido de la vida. Gracias por enseñarme a mirar las cosas desde otra perspectiva y relativizar cuando me ahogo en mi propio drama, por acordarte de enfriar una cervecita para disfrutar de nuestras “picaetas”, y por los masajitos en la cabecita cuando no puedo más. Gracias. También me gustaría dar las gracias tanto a Alicia como a Santiago, por quererme y cuidarme, pero también por hacer tan felices a mis padres.

No puedo olvidar a mis increíbles hermanas, Aitana y Vega, por ser un pilar fundamental en mi vida, por admirarme y animarme a esforzarme día a día para ser el mejor ejemplo posible para vosotras; por enseñarme tantas cosas, aunque seáis las pequeñas; por poder disfrutar de veros crecer y por saber que, aunque a veces estemos lejos, siempre estamos y estaremos las unas para las otras.

En este punto, cómo no nombrar a los sabios de la familia, mis tres abuelos (mis yayis y mi yayitongui). Gracias por ser mi inspiración, gracias por vuestro amor incondicional y vuestro cariño eterno (incluyendo comidas y conversaciones que lo curan todo), por vuestras enseñanzas inolvidables y por transmitirnos esa fuerza inagotable y esas ganas de vivir disfrutando de los pequeños detalles. Pero, especialmente en este momento, gracias por todo vuestro apoyo en mi vida profesional, hasta en las cosas que son demasiado liosas para vosotros.

También quiero agradecer su amor y su apoyo incondicional a mis queridos tíos (mi tiita, mi txio Kiki y txio Nach) y a mis primos (mi Tete, Ani, Aliche y Nolon). Gracias por vuestro cariño los días que he estado agotada y por vuestra comprensión los que no he podido ir por estar saturada.

Mi amor, gracias por todo. Gracias por aparecer en mi vida y convertirla en maravillosa, gracias por todos los buenos e inolvidables momentos que hemos vivido juntos, pero también gracias por todos los momentos duros en los que me has apoyado, has estado a mi lado y me has dado fuerzas para seguir adelante. Gracias por darme tantos ánimos y tanta confianza en mí misma, dándome alas para superar mis límites. Además, en este caso en particular, quiero agradecer tu ayuda en la primera etapa de la tesis, juntos en el CITA, fueron unos meses de mucho trabajo y estrés, pero gracias a ti fueron grandiosos. Lo demás ya lo sabes todo. Te quiero infinito.

También me gustaría dar las gracias a la familia que he elegido, a mis chicas: Clara, Noemi, Patri y Silvia. Gracias por ser las mejores amigas que puedo tener, por conocerme mejor que yo a mí misma, por entenderme siempre, aunque ni siquiera yo sepa qué me pasa, por ser mis animadoras incansables, por disfrutar conmigo de mis logros y conseguir que olvide mis dramas. Gracias por todas las anécdotas que hemos vivido a lo largo de nuestra vida y por planificar las que nos quedan. Gracias por animarme siempre a seguir adelante, todo con vosotras es mejor.

Quiero recordar también a mi familia “vet”, mis queridísimos Eva y Alejandro, sabéis que os adoro. Pasamos 5 años juntos (juntos, juntos), fuisteis los que realmente vivisteis mis inicios con Clara... Pasamos horas eternas de prácticas y clases, comidas de “tupper” y “box” del Atlas, cafés muertos de sueño y cervezas que nos hacían olvidar cualquier drama. Aunque ahora estemos lejos, sé que nos tenemos y tendremos siempre. Gracias por todo.

Por último, quiero recordar a mis adorables mascotas, que me han mimado y alegrado a lo largo de estos años. Laika, gracias por cuidarme siempre e inspirarme para entrar en el apasionante mundo de la veterinaria. Piccolino y Glinda, gracias por aparecer en este año tan extraño y complicado, para llenar de nuevo nuestra casa de amor y alegría.

En definitiva, gracias a todos por formar parte de mi vida, sois lo mejor que me llevo. Os quiero mucho a todos, de corazón, GRACIAS.

ABSTRACT / RESUMEN / RESUM

ABSTRACT

Social awareness regarding animal welfare, food safety, antimicrobial resistance and environmental health has increased, creating a new challenge for poultry producers and promoting the implementation of alternative sustainable production systems that include the ‘One Health’ concept in their design. In this sense, poultry production system is in constant development to meet consumer demands. For this reason, different alternatives to be applied at field level have been proposed, centred on the improvement of biosecurity protocols, the use of rustic slow-growing breeds and the implementation of precision livestock farming. In fact, it is demonstrated that an investment in more accurate and animal-friendly management systems could directly affect animal health, increasing animals’ resilience and achieving broilers with a strengthened immune system more able to cope with environmental challenges or infectious diseases.

In this context, microbiota composition and development play an important role in poultry health and performance, in the spread of antimicrobial resistance and in the transmission of zoonotic pathogens throughout the poultry production chain. In this regard, it is demonstrated that an increase in animal welfare not only improve animals’ resilience, but also promotes the presence of beneficial microbiota and the integrity of the intestinal epithelium. As a consequence, protective mechanisms work perfectly and the interactions between environmental and intestinal bacteria are reduced. This way, it could be possible to achieve a reduction in antimicrobial administration at field level, as different studies have demonstrated a close association between antibiotic use in animal production and the appearance of resistance in humans. Moreover, the presence of zoonotic pathogens such as *Salmonella* in the food chain could be reduced. *Salmonella* spp. is the main cause of human foodborne outbreaks in the European Union, with a total of 91 857 cases of salmonellosis, and 1 581 outbreaks reported in 2018. The main sources of infection are poultry products such as eggs and chicken meat, and the main serovars related to these outbreaks are *S. Enteritidis*, *S. Typhimurium*, *S. Typhimurium* monophasic variant and *S. Infantis*, which is currently the most prevalent serovar isolated in broiler chickens.

Therefore, the general objective of this doctoral thesis was to evaluate the effect of alternative production systems of poultry production on the microbiota composition

development, antimicrobial resistance dynamics and *Salmonella* epidemiology. For this purpose, two different experiments were performed.

In the **first experiment**, the effect of the genetic breed was studied by comparing a commercial fast-growing breed vs. an alternative slow-growing breed, reared under their respective management systems. The objectives were to characterise the caecal microbiota and to investigate antimicrobial resistance and multidrug-resistance dynamics throughout the growing period. To do so, two commercial broiler breeds were used, one fast-growing (Ross®) and one slow-growing (Hubbard®), and 576 broilers were located in two identical poultry houses (288 animals in each room: 144 for fast-growing and 144 for slow-growing). Animals from each experimental group were sampled on arrival day, at mid-period (21 days of age) and at the end of the growing period (42 and 63 days of age for fast and slow-growing breeds, respectively), and caecum samples were taken.

To evaluate microbiota composition, 16S rRNA sequencing analysis of caecal content was performed. Results showed that *Firmicutes* represented the dominant phylum for both systems. At the outset, *Proteobacteria* was the second prevalent phylum for fast and slow-growing breeds, outnumbering the *Bacteroidetes*. However, during the rest of the production cycle, *Bacteroidetes* was more abundant than *Proteobacteria* in both groups. Finally, regardless of the management system, the most predominant genera identified were *Oscillospira* spp., *Ruminococcus* spp., *Coprococcus* spp., *Lactobacillus* spp. and *Bacteroides* spp.

To study antimicrobial resistance dynamics, *E. coli* was selected as indicator bacterium, and antibiotic susceptibility testing was assessed according to Decision 652/2013. At the onset of the cycle, significant differences were observed between breeds, as the *Escherichia coli* strains isolated from fast-growing day-old-chicks showed higher antimicrobial resistance rates. However, at the end of the period no significant differences were found between breeds and their presence of resistant bacteria (above 95%). Therefore, although no antibiotics were administered during the growing period, a high level of antimicrobial resistance and multidrug-resistance at slaughter day was demonstrated.

The results of this experiment show that fast and slow-growing broiler microbiota are in constant development throughout rearing, being relatively stable at 21 days of age.

Regarding the genus, it should be noted that the three most abundant groups for both systems, *Ruminococcus* spp., *Lactobacillus* spp. and *Bacteroides* spp., are related to better productive performance and intestinal health. Moreover, high levels of antimicrobial resistance and multidrug-resistance present during the growing period demonstrate that although it is crucial to control both antibiotics use and animal welfare during the growing period, measures should be taken at all levels of the production chain.

In the **second experiment**, the effect of the farm management conditions was evaluated by comparing commercial European density and ventilation conditions vs. improved conditions. The objectives were to characterise the caecal microbiota, to evaluate antimicrobial resistance and multidrug-resistance dynamics, and to investigate the development of *S. Infantis* and its antimicrobial resistance throughout the growing period. To this end, a total of 1062 day-old chicks of a fast-growing broiler breed (Ross®) were housed in two poultry houses under commercial (33 kg/m² density and maximum of 20 ppm ammonia) and optimal (17 kg/m² density and maximum of 10 ppm ammonia) farm conditions. Within each of the houses, 234 animals were located in pens and 327 were housed directly on the bed to simulate real production environment. Moreover, at 24h of rearing, 20% of the animals were orally infected with a *S. Infantis* strain susceptible to all the antibiotics tested. Animals from each experimental group were also sampled on arrival day, at mid-period (21 days of age) and at the end of the growing period (42 days of age), and caecum samples were taken.

To investigate microbiota composition, 16S rRNA sequencing analysis was performed. Results showed a higher level of microbiota complexity in the group reared under optimal farm conditions at the end of rearing. Regarding microbiota composition, *Firmicutes* was the dominant phylum during all the growing period. However, the second most prevalent phylum was *Proteobacteria* at arrival day, and *Bacteroidetes* from mid-period onwards in both groups. Moreover, the most predominant genera identified were *Oscillospira* spp., *Ruminococcus* spp., *Bacteroides* spp. and *Coprococcus* spp.

To evaluate antimicrobial resistance dynamics, as in the first experiment, *E. coli* was selected as indicator bacterium, and antibiotic susceptibility testing was assessed according to Decision 652/2013. Results showed high antimicrobial resistance rates throughout rearing, and no statistical differences were observed between groups. Moreover, both groups presented high multidrug-resistance rates at slaughter day.

Finally, to study *Salmonella* shedding, faeces samples from each experimental group were taken weekly and analysed as per ISO 6579-2:2017. Antibiotic susceptibility was also assessed according to Decision 652/2013. *Salmonella* shedding showed that the lowest counts were observed in the first week post-infection and the highest at slaughter day for both groups. Moreover, 100% of the isolates were multi-resistant after the first week post-infection.

These results also reveal that microbiota diversity increases throughout the growing period, being relatively stable as of the mid-period. However, at the end of rearing there is a significant higher level of microbiota complexity in animals reared under optimal farm conditions, but without statistical differences in composition. Moreover, antimicrobial resistance and multidrug-resistance are present throughout rearing, without differences at the end of the cycle. Regarding the acquisition of antimicrobial resistance by *S. Infantis*, it starts at the onset of the production cycle and is maintained until the end, demonstrating the importance of transmission of antimicrobial resistance in zoonotic bacteria at farm level.

In conclusion, the main results obtained from this doctoral thesis include that microbiota diversity and composition are in constant development throughout the growing period, being affected by farm management factors studied. Moreover, antimicrobial resistance is present in commensal bacteria as of the arrival day and increases until the end of rearing, emphasising the need to control antimicrobial administration in all stages of poultry production. Regarding *S. Infantis* epidemiology, the continuous shedding throughout the growing period and its ability to gain antimicrobial resistance, regardless of farm management conditions, strongly suggest the need for further studies with a view to establishing better control programmes to control the bacteria in the food chain.

RESUMEN

La concienciación social con respecto al bienestar animal, la seguridad alimentaria, las resistencias antimicrobianas y la salud medioambiental ha incrementado en los últimos años, creando un nuevo reto para los productores avícolas y promoviendo la implementación de sistemas de producción alternativos que incluyan el concepto ‘One Health’ (“una sola salud”) en su diseño. Por ello, la producción avícola se encuentra en constante desarrollo para conseguir satisfacer las demandas de los consumidores. Por ello, se han propuesto diferentes alternativas para ser aplicadas a nivel de campo, centradas en la mejora de los protocolos de bioseguridad, el uso de estirpes más rústicas y de crecimiento lento, así como la implementación de la ganadería de precisión. Se ha demostrado que una inversión en sistemas de manejo más precisos y respetuosos con el bienestar animal puede tener un efecto directo sobre la salud de los mismos, aumentando su resiliencia, y consiguiendo pollos con un sistema inmunitario reforzado, más capaces de superar los retos ambientales o las enfermedades infecciosas.

En este contexto, el desarrollo y la composición de la microbiota tienen un papel importante en la salud de los animales, en los índices productivos conseguidos, en la diseminación de resistencias antimicrobianas y en la transmisión de patógenos zoonóticos a lo largo de la cadena alimentaria. Una mejora del bienestar animal no solo incrementa la resiliencia de los animales, sino que también se ha demostrado que promueve la presencia de microbiota intestinal beneficiosa y la integridad del epitelio intestinal. Como consecuencia, los mecanismos de protección funcionan perfectamente y las interacciones entre las bacterias ambientales y las intestinales se reducen. De esta manera, sería posible conseguir una reducción de la administración de antibióticos a nivel de campo, muy necesaria debido a la estrecha relación entre el empleo de antibióticos en producción animal y la aparición de resistencias en humanos, demostrada por diferentes estudios. Además, también se podría reducir la presencia de patógenos zoonóticos, como *Salmonella*, en la cadena alimentaria. *Salmonella* spp. es la principal causa de brotes alimentarios en la Unión Europea, con un total de 91 857 casos de salmonelosis y 1 581 brotes notificados en 2018. La principal fuente de infección son los productos avícolas como huevos y carne de pollo, y los principales serotipos relacionados con estos brotes

son *S. Enteritidis*, *S. Typhimurium*, *S. Typhimurium* monofásica y *S. Infantis*, que actualmente es el serotipo más prevalente en pollos de engorde.

Por todo ello, el objetivo general de esta tesis doctoral fue evaluar el efecto de sistemas alternativos de producción avícola sobre el desarrollo y la composición de la microbiota, la evolución de las resistencias antimicrobianas y la epidemiología de *Salmonella*. Para ello, se realizaron dos experimentos diferentes.

En el **primer experimento**, se estudió el efecto de la estirpe genética, comparando una estirpe comercial de crecimiento rápido frente a una estirpe alternativa de crecimiento lento, producidas bajo sus respectivos sistemas de manejo. Los objetivos de este experimento fueron caracterizar la microbiota cecal e investigar la dinámica de las resistencias y multirresistencias antimicrobianas a lo largo del ciclo productivo. Para ello, se utilizaron dos estirpes comerciales de pollo de engorde, una de crecimiento rápido (Ross®) y otra de crecimiento lento (Hubbard®), y se alojaron 576 pollos en dos naves idénticas (288 animales en cada nave: 144 de crecimiento rápido y 144 de crecimiento lento). Se muestrearon animales de cada grupo experimental el día de la llegada, a mitad de ciclo (21 días de edad) y al final del ciclo (42 y 63 días de edad para las estirpes de crecimiento rápido y lento, respectivamente), y se tomaron muestras de ciego.

Para evaluar la composición de la microbiota, se realizó un análisis de secuenciación del ARNr 16S del contenido cecal. Los resultados mostraron que *Firmicutes* representó el filo dominante para ambos grupos. Al principio del ciclo, *Proteobacteria* fue el segundo filo más predominante para ambas estirpes, superando en número a *Bacteroidetes*. Sin embargo, durante el resto del ciclo productivo, *Bacteroidetes* fue más abundante que *Proteobacteria* en ambos grupos. Finalmente, independientemente del sistema de manejo, los géneros identificados más predominantes fueron *Oscillospira* spp., *Ruminococcus* spp., *Coprococcus* spp., *Lactobacillus* spp. y *Bacteroides* spp.

Para estudiar la evolución de las resistencias antimicrobianas, se seleccionó *Escherichia coli* como bacteria centinela y se evaluó la susceptibilidad de las cepas a los antibióticos de acuerdo con la Decisión 652/2013. Al inicio del ciclo, se observaron diferencias significativas entre las estirpes, ya que las cepas de *E. coli* aisladas de pollitos de un día de la estirpe de crecimiento rápido presentaron un mayor porcentaje de resistencia antimicrobiana. Sin embargo, al final del periodo de engorde, no se encontraron

diferencias significativas entre las estirpes y la presencia de bacterias resistentes (por encima del 95% en ambos grupos). Por lo tanto, aunque no se administraron antibióticos durante el periodo de crecimiento, se observó un alto nivel de resistencia y multirresistencia antimicrobiana el día del sacrificio.

Los resultados de este experimento ponen de manifiesto que la microbiota de los pollos de engorde de las estirpes de crecimiento rápido y crecimiento lento está en constante desarrollo a lo largo del periodo de engorde, siendo relativamente estable desde los 21 días de edad. En cuanto la composición de la misma, a nivel de género cabe destacar que los tres grupos más abundantes para ambas estirpes, *Ruminococcus* spp., *Lactobacillus* spp. y *Bacteroides* spp., están relacionados con un mejor rendimiento productivo y salud intestinal. Además, los elevados niveles de resistencia y multirresistencia antimicrobiana presentes durante el ciclo productivo demuestran que, aunque es crucial controlar tanto el uso de antibióticos como el bienestar de los animales durante el periodo de engorde, deben tomarse medidas en todos los niveles de la cadena de producción.

En el **segundo experimento**, se evaluó el efecto de las condiciones de manejo de la granja, comparando las condiciones comerciales europeas de densidad y ventilación, frente a condiciones mejoradas. Los objetivos fueron caracterizar la microbiota cecal, evaluar la evolución de las resistencias y multirresistencias antimicrobianas, e investigar el desarrollo de *S. Infantis* y sus resistencias antimicrobianas a lo largo del periodo de engorde. Para ello, se alojaron 1062 pollitos de un día de una estirpe comercial de crecimiento rápido (Ross®), en dos naves avícolas bajo condiciones comerciales (33 kg/m² de densidad y un máximo de 20 ppm de amoníaco) y óptimas (17 kg/m² de densidad y un máximo de 10 ppm de amoníaco). Dentro de cada una de las naves, 234 animales se ubicaron en corralinas y 327 se alojaron directamente en la cama para simular el ambiente real de producción. Además, a las 24 horas de la llegada de los animales, el 20% de los mismos fueron infectados por vía oral con una cepa de *S. Infantis* susceptible a todos los antibióticos testados. También se muestrearon animales de cada grupo experimental el día de la llegada, a mitad del ciclo (21 días de edad) y al final del periodo de engorde (42 días de edad), y se tomaron muestras de ciego.

Para investigar la composición de la microbiota, se realizó un análisis de secuenciación del ARNr 16S. Los resultados mostraron un mayor nivel de diversidad en el grupo producido bajo condiciones de manejo óptimas. En cuanto a la composición de la

microbiota, *Firmicutes* fue el filo dominante durante todo el ciclo productivo. Sin embargo, el segundo filo predominante el día de llegada fue *Proteobacteria*, y desde la mitad del periodo fue *Bacteroidetes*, en ambos grupos. Además, los géneros identificados más predominantes fueron *Oscillospira* spp., *Ruminococcus* spp., *Bacteroides* spp. y *Coproccoccus* spp.

Para evaluar la dinámica de las resistencias antimicrobianas, al igual que en el primer experimento, se seleccionó *E. coli* como bacteria centinela y se evaluó la susceptibilidad de las cepas aisladas a los antibióticos de acuerdo con la Decisión 652/2013. Los resultados mostraron altas tasas de resistencia antimicrobiana a lo largo del periodo de engorde, sin diferencias estadísticamente significativas entre los grupos. Además, ambos grupos presentaron altas tasas de multiresistencia el día de sacrificio.

Por último, para estudiar la excreción de *Salmonella*, se tomaron muestras de heces de cada grupo experimental de manera semanal y se analizaron según la norma ISO 6579-2:2017. También se evaluó la susceptibilidad a los antibióticos según la Decisión 652/2013. Los recuentos más bajos de excreción de *Salmonella* se observaron en la primera semana post-infección y los más altos en el día de sacrificio, en ambos grupos. Además, el 100% de las cepas aisladas fueron multiresistentes después de la primera semana post-infección.

Estos resultados también revelan que la diversidad de la microbiota aumenta a lo largo del periodo de engorde, siendo relativamente estable desde mitad de ciclo. Sin embargo, al final del periodo, el nivel de diversidad de la microbiota es significativamente mayor en los animales producidos bajo condiciones óptimas de manejo en granja, pero sin diferencias estadísticas en su composición. Además, las resistencias y multiresistencias antimicrobianas están presentes a lo largo de todo el ciclo productivo, sin diferencias al final del mismo. En cuanto a la adquisición de resistencias antimicrobianas por parte de *S. Infantis*, se inicia al principio del ciclo de producción y se mantiene hasta el final, lo que demuestra la importancia de la transmisión de resistencias a las bacterias zoonóticas en las explotaciones avícolas.

En conclusión, los principales resultados obtenidos en esta tesis doctoral incluyen que la diversidad y la composición de la microbiota están en constante desarrollo a lo largo del periodo de engorde, viéndose afectadas por los factores de manejo estudiados. Además,

las resistencias antimicrobianas están presentes en las bacterias comensales desde el día de llegada, y aumenta hasta el final del ciclo, destacando la necesidad de controlar la administración de antibióticos en todas las etapas de la producción avícola. En cuanto a la epidemiología de *S. Infantis*, la continua excreción durante todo el periodo de engorde y su capacidad de adquirir resistencias, independientemente de las condiciones de manejo en granja, sugieren la necesidad de realizar más estudios para poder establecer mejores programas de control de la bacteria a lo largo de la cadena alimentaria.

RESUM

La conscienciació social amb respecte del benestar animal, la seguretat alimentaria, les resistències antimicrobianes i la salut mediambiental han incrementat en els últims anys, creant un nou repte per als productors avícoles i promovent la implementació de sistemes de producció alternatius que incloguen el concepte ‘*One Health*’ (“només una salut”) en el seu disseny. En aquest sentit, la producció avícola es troba en constant desenvolupament per aconseguir satisfer les demandes dels consumidors. Per aquesta raó, s’han proposat diverses alternatives per ser aplicades a nivell de camp, centrades en la millora dels protocols de bioseguretat, l’ús d’estirps més rústiques i de creixement lent, així com la implementació de la ramaderia de precisió. De fet, s’ha demostrat que una inversió en sistemes de maneig més precisos i respectuosos amb el benestar animal poden tindre un efecte directe sobre la salut dels mateixos, augmentant la seua resiliència, i aconseguint pollastres amb un sistema immunitari reforçat, més capaços de superar els reptes ambientals o les malalties infeccioses.

En aquest context, el desenvolupament i la composició de la microbiota tenen un paper clau en la salut dels animals, en els índexs productius aconseguits, en la disseminació de resistències antimicrobianes i en la transmissió de patògens zoonòtics al llarg de la cadena alimentària. En aquesta línia, s’ha demostrat que una millora del benestar animal no només incrementa la resiliència dels animals, sinó que també promou la presència de microbiota intestinal beneficiosa i la integritat de l’epiteli intestinal. Com a conseqüència, els mecanismes de protecció funcionen perfectament i les interaccions entre els bacteris ambientals i els intestinals es redueixen. D’aquesta manera, pot ser possible aconseguir una reducció de l’administració d’antibiòtics a nivell de camp, molt necessària degut a l’estreta relació entre l’ús d’antibiòtics en producció animal i l’aparició de resistències en éssers humans, demostrada per diferents estudis. A més a més, també es podria reduir la presència de patògens zoonòtics, com *Salmonella*, en la cadena alimentària. *Salmonella* spp. és la principal causa de brots alimentaris en la Unió Europea, amb un total de 91 857 casos de salmonel·losi i 1 581 brots notificats en 2018. La principal font d’infecció són els productes avícoles com ous i carn de pollastre, i els principals serotips relacionats amb aquests brots son *S. Enteritidis*, *S. Typhimurium*, *S. Typhimurium* monofásica i *S. Infantis*, que actualment és el serotip més prevalent en pollastres d’engreixament.

Per tot açò, l'objectiu general d'aquesta tesi doctoral va ser avaluar l'efecte de sistemes alternatius de producció avícola sobre el desenvolupament i la composició de la microbiota, l'evolució de les resistències antimicrobianes i l'epidemiologia de *Salmonella*. Per fer açò, es van realitzar dos experiments diferents.

En el **primer experiment**, es va estudiar l'efecte de l'estirp genètica, comparant una estirp comercial de creixement ràpid front a una estirp alternativa de creixement lent, produïdes davall els seus respectius sistemes de maneig. Els objectius van ser caracteritzar la microbiota fecal i investigar la dinàmica de les resistències i multiresistències antimicrobianes al llarg del cicle productiu. Per fer açò, es van utilitzar dos estirps comercials de pollastre d'engreixament, una de creixement ràpid (Ross®) i altra de creixement lent (Hubbard®), i es van allotjar 576 pollastres en dos naus idèntiques (288 animals en cada nau: 144 de creixement ràpid i 144 de creixement lent). Es van inspeccionar animals de cada grup experimental el dia de l'arribada, a mitat de cicle (21 dies d'edat) i al final del cicle (42 i 63 dies d'edat per a les estirps de creixement ràpid i lent, respectivament), i es van prendre mostres de cec.

Per avaluar la composició de la microbiota, es va realitzar un anàlisi de seqüenciació del ARNr 16S del contingut fecal. Els resultats mostraren que *Firmicutes* va representar el fil dominant per a ambdós grups. Al principi del cicle, *Proteobacteria* va ser el segon fil més predominant per a ambdós estirps, superant en nombre a *Bacteroidetes*. No obstant això, durant la resta del cicle productiu, *Bacteroidetes* va ser més abundant que *Proteobacteria* en ambdós grups. Finalment, independentment del sistema de maneig, els gèneres identificats més predominants van ser *Oscillospira* spp., *Ruminococcus* spp., *Coprococcus* spp., *Lactobacillus* spp. i *Bacteroides* spp.

Per estudiar l'evolució de les resistències antimicrobianes, es va seleccionar *Escherichia coli* com a bacteri sentinella i es va avaluar la susceptibilitat dels ceps als antibiòtics d'acord amb la Decisió 652/2013. A l'inici del cicle, es van observar diferències significatives entre les estirps, ja que els ceps d'*E. coli* aïllats de pollets d'un dia de l'estirp de creixement ràpid van presentar un major percentatge de resistència antimicrobiana. No obstant això, al final del període d'engreixament, no es van encontrar diferències significatives entre les estirps i la seua presència de bacteris resistents (por damunt del 95% en ambdós grups). Per tant, encara que no es van administrar antibiòtics

durant el període de creixement, es va observar un alt nivell de resistència i multirresistència antimicrobiana el dia del sacrifici.

Els resultats d'aquest experiment posen de manifest que la microbiota dels pollastres d'engreixament de les estirps de creixement ràpid i creixement lent es troba en constant desenvolupament al llarg del període d'engreixament, sent relativament estable des de els 21 dies d'edat. Quant a la composició de la mateixa, a nivell de gènere cal destacar que els tres grups més abundants per ambdós estirps, *Ruminococcus* spp., *Lactobacillus* spp. i *Bacteroides* spp., es troben relacionades amb un millor rendiment productiu i salut intestinal. A més a més, els elevats nivells de resistència i multirresistència antimicrobiana presents durant el cicle productiu demostren que, encara que és crucial controlar tant l'ús d'antibiòtics com el benestar dels animals durant el període d'engreixament, deuen prendre's mesures en tots els nivells de la cadena de producció.

En el **segon experiment**, es va avaluar l'efecte de les condicions de maneig de la granja, comparant les condicions comercials europees de densitat i ventilació, front a condicions millorades. Els objectius van ser caracteritzar la microbiota fecal, avaluar l'evolució de les resistències i multirresistències antimicrobianes, i investigar el desenvolupament de *S. Infantis* i les seues resistències antimicrobianes al llarg del període d'engreixament. Per fer açò, es van allotjar 1062 pollets d'un dia d'una estirp comercial de creixement ràpid (Ross®), en dos naus avícoles davall de condicions comercials (33 kg/m² de densitat i un màxim de 20 ppm d'amoniac) i òptimes (17 kg/m² de densitat i un màxim de 10 ppm d'amoniac). Dins de cada una de les naus, 234 animals es van ubicar en corralines i 327 es van allotjar directament al llit per simular l'ambient real de producció. A més a més, a les 24 hores de l'arribada dels animals, el 20% dels mateixos van ser infectats per via oral amb un cep de *S. Infantis* susceptible a tots els antibiòtics testats. També es van inspeccionar animals de cada grup experimental el dia de l'arribada, a mitat del cicle (21 dies d'edat) i al final del període d'engreixament (42 dies d'edat), i es van prendre mostres de cec.

Per investigar la composició de la microbiota, es va realitzar un anàlisi de seqüenciació del ARNr 16S. Els resultats van mostrar un major nivell de diversitat en el grup produït davall condicions de maneig òptimes. Quant a la composició de la microbiota, *Firmicutes* va ser el fil dominant durant tot el cicle productiu. No obstant això, el segon fil predominant el dia d'arribada va ser *Proteobacteria*, i des de la mitat del període va ser

Bacteroidetes, en ambdós grups. A més, els gèneres identificats més predominants van ser *Oscillospira* spp., *Ruminococcus* spp., *Bacteroides* spp. i *Coprococcus* spp.

Per avaluar la dinàmica de les resistències antimicrobianes, igual que en el primer experiment, es va seleccionar *E. coli* com a bacteri sentinella i es va avaluar la susceptibilitat de els ceps aïllats als antibiòtics d'acord amb la Decisió 652/2013. Els resultats van mostrar altes taxes de resistència antimicrobiana al llarg del període d'engreixament, sense diferències estadísticament significatives entre els grups. A més, ambdós grups van presentar altes taxes de multiresistència el dia de sacrifici.

Per últim, per estudiar l'excreció de *Salmonella*, es van prendre mostres d'excrements de cada grup experimental de manera setmanal i es van analitzar segons la norma ISO 6579-2:2017. També es va avaluar la susceptibilitat als antibiòtics segons la Decisió 652/2013. Els recomptes més baixos d'excreció de *Salmonella* es van observar en la primera setmana post-infecció i els més alts en el dia de sacrifici, en ambdós grups. A més a més, el 100% dels ceps aïllats van ser multiresistents després de la primera setmana post-infecció.

Aquests resultats també revelen que la diversitat de la microbiota augmenta al llarg del període d'engreixament, sent relativament estable des de mitat del cicle. No obstant això, al final del període, el nivell de diversitat de la microbiota és significativament major en els animals produïts davall condicions òptimes de maneig en granja, però sense diferències estadístiques en la seua composició. A més, les resistències i multiresistències antimicrobianes es troben presents al llarg de tot el cicle productiu, sense diferències al final del mateix. Quant a l'adquisició de resistències antimicrobianes per part de *S. Infantis*, s'inicia al principi del cicle de producció i es manté fins al final, el que demostra la importància de la transmissió de resistències als bacteris zoonòtics en les explotacions avícoles.

En conclusió, els principals resultats obtinguts en aquesta tesi doctoral inclouen que la diversitat i la composició de la microbiota es troben en constant desenvolupament al llarg del període d'engreixament, veient-se afectades per els factors de maneig estudiats. A més a més, les resistències antimicrobianes es troben presents en els bacteris comensals des del dia d'arribada, i augmenta fins al final del cicle, destacant la necessitat de controlar l'administració d'antibiòtics en totes les etapes de la producció avícola. Quant a

l'epidemiologia de *S. Infantis*, la contínua excreció durant tot el període d'engreixament i la seua capacitat d'adquirir resistències, independentment de les condicions de maneig en granja, sugereixen la necessitat de realitzar més estudis per poder establir millors programes de control del bacteri al llarg de la cadena alimentària.

CONTENT

LIST OF TABLES	5
LIST OF FIGURES	7
LIST OF ABBREVIATIONS	10
CHAPTER I. GENERAL INTRODUCTION	15
1.1 Poultry meat sector	17
1.1.1 Poultry meat production.....	17
1.1.2 Animal welfare and resilience concepts	18
1.1.3 Evolution of poultry production systems	19
1.2 Influence of intestinal health in poultry	21
1.2.1 Intestinal microorganisms in poultry production	21
1.2.1.1 Definitions.....	21
1.2.1.2 Influence on poultry health	23
1.2.1.3 Methods for studying microbial communities	24
1.2.2 Zoonotic microorganisms in poultry production	25
1.2.2.1 <i>Salmonella</i> spp. characteristics, prevalence and control.....	25
1.2.3 Antimicrobial resistance in poultry production	28
1.2.3.1 Definition and development.....	28
1.2.3.2 Commensal <i>Escherichia coli</i> as antimicrobial resistance sentinel bacterium	30
1.2.3.3 Mechanisms of antimicrobial resistance	31
1.2.3.4 Presence of antimicrobial resistance in poultry production	34
1.3 Main control measures for zoonotic and resistant microorganisms in poultry	36

1.3.1 Biosecurity	36
1.3.2 Broiler breeds	38
1.3.3 Precision livestock farming	39
1.4 Study cornerstone.....	39
1.5 References	41
CHAPTER II. OBJECTIVES.....	55
CHAPTER III. EXPERIMENTAL CHAPTERS	59
3.1 Effect of the genetic breed on intestinal microbiota and antimicrobial resistance dynamics.....	61
3.1.1 Fast and slow-growing management systems: characterisation of broiler caecal microbiota development throughout the growing period.....	63
3.1.1.1 Abstract	65
3.1.1.2 Introduction	66
3.1.1.3 Material and methods	67
3.1.1.4 Results	73
3.1.1.5 Discussion	82
3.1.1.6 Conclusion.....	85
3.1.1.7 References	86
3.1.1.8 Supplementary material	94
3.1.2 The dynamic of antibiotic resistance in commensal <i>Escherichia coli</i> throughout the growing period in broiler chickens: fast-growing vs. slow-growing breeds.....	101
3.1.2.1 Abstract	103
3.1.2.2 Introduction	104
3.1.2.3 Material and methods	105

3.1.2.4	Results	107
3.1.2.5	Discussion	113
3.1.2.6	Conclusion.....	115
3.1.2.7	References	116
3.2	Effect of the management system on the intestinal microbiota, the antimicrobial resistance dynamics and <i>Salmonella</i> spp. epidemiology.....	123
3.2.1	Assessment of microbiota modulation in poultry to combat infectious diseases	125
3.2.1.1	Abstract	127
3.2.1.2	Introduction	128
3.2.1.3	Material and methods	129
3.2.1.4	Results	132
3.2.1.5	Discussion	136
3.2.1.6	Conclusion.....	138
3.2.1.7	References	139
3.2.1.8	Supplementary material	145
3.2.2	Commensal <i>Escherichia coli</i> antimicrobial resistance and multidrug-resistance dynamics during broiler growing period: commercial vs. improved farm conditions.....	153
3.2.2.1	Abstract	155
3.2.2.2	Introduction	156
3.2.2.3	Material and methods	157
3.2.2.4	Results	161
3.2.2.5	Discussion	167
3.2.2.6	Conclusion.....	169
3.2.2.7	References	170

3.2.3 Influence of farm management on the dynamics of <i>Salmonella</i> Infantis shedding and antibiotic resistance during growing period: commercial vs. optimal conditions	177
3.2.3.1 Abstract	179
3.2.3.1 Introduction	180
3.2.3.3 Material and methods	181
3.2.3.4 Results	183
3.2.3.5 Discussion	188
3.2.3.6 Conclusion.....	190
3.2.3.7 References	191
 CHAPTER IV. GENERAL DISCUSSION.....	199
4.1 References	211
 CHAPTER V. CONCLUSIONS	223

LIST OF TABLES

Table 1. Composition of starter and grower diets for FG and SG breeds.	70
Table 2. Weight of the animals (weight \pm s.d) and conversion rate (CR \pm s.d.) during the productive cycle for FG and SG management systems.....	74
Table 3. Alpha diversity according to management system (FG or SG) and sampling moment based on Chao 1 index.	76
Table 4. Taxonomic profiles at phylum level according to management system (FG or SG) and sampling moment based on MetagenomeSeq parametric test.	77
Table 5. Taxonomic profiles at genus level according to sampling moment in FG management system.	80
Table 6. Taxonomic profiles at genus level according to the sampling moment in SG management system.	81
Table S1. Statistical comparison of alpha diversity between sample groups based on Chao 1 index.	95
Table S2. Statistical comparison of alpha diversity between sample groups based on Shannon index.....	96
Table S3. Statistical comparison of alpha diversity between sample groups based on Simpson index.....	97
Table S4. Statistical comparison of alpha diversity between sample groups based on Observed OTUs index.....	98
Table S5. Different taxonomic profiles at genus level according to the moment of the growing period in fast (FG) and slow-growing (SG) breeds.	99
Table S6. Statistical comparison between beta-diversity indexes calculated according the different methods.....	100
Table 7. Antibiotic resistance rates according to the antibiotic and the moment of the growing period in FG and SG breeds.....	109
Table 8. Number of <i>E. coli</i> strains isolated resistant to the different number of antibiotics tested according to the sampling moment in FG and in SG breeds.	112

Table 9. Composition of starter and grower diets.	131
Table 10. Alpha diversity (Chao 1 index) according to the moment of the growing period in CFC and OFC.....	134
Table 11. Taxonomic profiles at phylum level according to sampling moment in CFC and OFC.	134
Table S7. Statistical comparison of alpha diversity between sample groups based on Chao 1 index.....	146
Table S8. Statistical comparison of alpha diversity between sample groups based on Shannon index.....	147
Table S9. Statistical comparison of alpha diversity between sample groups based on Simpson index.....	148
Table S10. Statistical comparison of alpha diversity between sample groups based on Observed OTUs index.....	149
Table S11. Statistical comparison between beta diversity indexes calculated according the different methods.....	151
Table 12. Composition of starter and grower diets.	159
Table 13. Mortality rate (MR), body weight (BW), feed intake (FI) and feed conversion rate (FCR) of the animals for both experimental groups: Commercial farm conditions (CFC) and improved farm conditions (IFC), throughout the growing period.	161
Table 14. Antimicrobial resistance rates obtained for each antibiotic in different sampling moments and experimental groups (commercial vs. improved farm conditions) throughout the growing period.....	164
Table 15. Antibiotic resistance isolates according to the antibiotic and the moment of the growing period in CFC and OFC.	186
Table 16. Number of <i>Salmonella</i> strains isolated resistant to the different antibiotics tested according to different environmental farm conditions.....	187

LIST OF FIGURES

Figure 1. Poultry meat production in 2019 (Percentage share of EU members, based on tonnes of carcass weight).	17
Figure 2. Evolution of protection tools in broiler production.	21
Figure 3. A schematic highlighting the composition of the term microbiome.....	22
Figure 4. Characteristic <i>Salmonella</i> cells and related structures.....	26
Figure 5. Distribution (%) of the human EU <i>Salmonella</i> serovars in poultry production.	27
Figure 6. Antimicrobial resistance development and spread, in a ‘One Health’ perspective.....	28
Figure 7. Timeline of antibiotics deployment vs. its antibiotic resistance observed.....	29
Figure 8. Characteristic <i>Escherichia coli</i> cells and related structures.....	31
Figure 9. General antimicrobial resistance mechanisms.	32
Figure 10. Horizontal resistance gene transmission between bacteria: conjugation, transduction and transformation.	33
Figure 11. Microbial community interactions affecting the response to antibiotic exposure. A: Exposure protection: resistant bacteria inactivating antibiotic concentration, protecting sensitive members of bacteria population. B: Collective tolerance: some species unable to form biofilm collaborating in established biofilms of other species. C: Collective resistance: susceptible community member of a bacterial population could activate their resistance mechanisms in the presence of other species. D: Due to the cross-feeding networks, tolerance to antibiotics is lowered to the level of the most susceptible community member, since resistant species are unable to grow due to the loss of essential resources.	34
Figure 12. Holistic definition of biosecurity.	36
Figure 13. Animals’ housing scheme in experiment 1.	68
Figure 14. Experiment design management systems scheme in experiment 1.	69
Figure 15. Sample collection scheme in experiment 1.	71

Figure 16. Evaluation of alpha diversity in fast and slow-growing management systems using different calculation measures. A: Chao 1. B: Shannon. C: Simpson. D: Observed OUTs.	75
Figure 17. Taxonomic analysis at genus level throughout the growing period. A: evolution of genera throughout the growing period for fast-growing management system. B: evolution of genera throughout the growing period for slow-growing management system.....	78
Figure 18. Evaluation of the beta diversity based on Bray-Curtis dissimilarity between sampling moments (arrival day, mid-period and end of the rearing period) for each management system. A: beta diversity represented by PCoA graphic for fast-growing management system. B: beta diversity represented by PCoA graphic for slow-growing management system.	82
Figure 19. Antimicrobial resistant <i>E. coli</i> strains dynamic in fast-growing and slow-growing breed throughout the growing period.....	108
Figure 20. Multidrug-resistant <i>E. coli</i> strains dynamic in fast-growing and slow-growing breed throughout the growing period.	110
Figure 21. Experiment design management systems scheme in experiment 2.	130
Figure 22. Animals' housing scheme in experiment 2.....	130
Figure 23. Sample collection scheme in experiment 2.....	132
Figure 24. Evaluation of alpha diversity in commercial and optimal farm conditions by using different calculation measures: Chao 1, Shannon, Simpson, Observed OUTs. ..	133
Figure 25. Evaluation of the beta diversity based on Bray-Curtis dissimilarity and comparison of genera presence in commercial and optimal farm conditions. A: PCoA graphic and similar vs. different genera for both experimental groups at mid-period. B: PCoA graphic and similar vs. different genera for both experimental groups at the end of the growing period.	136
Figure S1. Evaluation of the beta-diversity in commercial and optimal farm conditions. A: Beta diversity represented by PCoA graphic for both farm conditions at all sampling times. B: Beta diversity represented by Heatmap for both farm conditions at all sampling times.	150

Figure 26. Antimicrobial-resistant *E. coli* isolates dynamic for commercial (CFC) and improved farm conditions (OFC) throughout the growing period.....162

Figure 27. Multidrug-resistant *E. coli* isolates dynamic for commercial (CFC) and optimal farm conditions (IFC) throughout the growing period.....163

Figure 28. Number of *E. coli* strains isolated resistant to the different number of antimicrobials tested and their antimicrobial resistance pattern, according to commercial (CFC) and improved (IFC) farm conditions.166

Figure 29. *Salmonella* excretion dynamic in commercial (CFC) and optimal (OFC) farm conditions during growing period.184

LIST OF ABBREVIATIONS

%	Percentage
°C	Celsius degrees
AB	Antibiotic
AEMPS	Spanish Agency for Medicines and Health Products
AMA	Antimicrobial
AMP	Ampicillin
AMR	Antimicrobial Resistance
ANOVA	Analysis of Variance
API	Identification system for Enterobacteriaceae and other Gram-negative rods
AZM	Azithromycin
CAZ	Ceftazidime
CDC	Centers for Disease Control and Prevention
CECAV	Poultry Quality and Animal Feed Centre of the Valencia Region
CFC	Commercial Farm Conditions
CFU	Colony Forming Units
CHL	Chloramphenicol
CIBIR	Centre for Biomedical Research of La Rioja
CIP	Ciprofloxacin
CITA	Centre for Research and Animal Technology
CR	Conversion Rate
CST	Colistin
CTX	Cefotaxime
DNA	Deoxyribonucleic Acid
<i>E.</i>	<i>Escherichia</i>
EC	European Commission

ECDC	European Centre for Disease Prevention and Control
EFSA	European Food Safety Authority
EMA	European Medicines Agency
ESVAC	European Surveillance of Veterinary Antimicrobial Consumption
EU	European Union
EUCAST	European Committee on Antimicrobial Susceptibility Testing
FAO	Food and Agriculture Organization of the United Nations
g	Grams
GEN	Gentamicyn
GLM	Generalised Linear Model
h	Hours
IFC	Improved Farm Conditions
ISO	International Organisation for Standardisation
IVIA	Valencian Institute for Agrarian Research
Kg	Kilograms
log	Logarithms
m²	Square metres
MDR	Multidrug-resistance
mL	Militres
MS	Member States
n	Number of samples
NAL	Nalidixic Acid
MPN	Most Probable Number
OECD	Organisation for Economic Co-operation and Development
OFC	Optimal Farm Conditions
OHC	One Health Commission
OIE	World Organisation for Animal Health
OTU	Operational Taxonomic Unit

<i>P</i>	Probability value
PCoA	Principal Coordinate Analysis
ppm	Particles Per Million
R²	R-squared
RNA	Ribonucleic Acid
rRNA	Ribosomal Ribonucleic Acid
<i>S.</i>	<i>Salmonella</i>
S.d.	Standard deviation
spp.	Species
std	Standard
SXT	Trimethoprim-sulfamethoxazole
TGC	Tigecycline
TMP	Trimethoprim
U.m.	Unclassified members
vol/vol	Volume to volume
vs.	Versus
WHO	World Health Organisation
wpi	Week Post-Infection
XLD	Xylose-Lysine-Desoxycholate
μL	Microlitres
μg	Micrograms

CHAPTER I. GENERAL INTRODUCTION

1.1 Poultry meat sector

1.1.1 Poultry meat production

Poultry is the fastest growing agricultural sub-sector worldwide, and broiler chicken meat is one of the animal-derived products most consumed across greatly diverse cultures, traditions and religions. On the one hand, in developed countries it is appreciated because it provides high-quality and low-fat protein; on the other hand, in lower-income countries this protein source is considered affordable, healthy and culturally acceptable (FAO, 2020; OECD and FAO, 2020). In fact, poultry production is expected to expand by 16% in the next ten years, with a total of 51 million tonnes produced in 2019 vs. 57 million tonnes expected by 2029 in the 37 countries belonging to the Organisation for Economic Co-operation and Development (OECD) (OECD and FAO, 2020).

In 2020, global poultry meat production increased by about 2.6%, with a total of 137 million tonnes produced (FAO, 2020). The European Union (EU) is the world's third largest poultry meat producer with an annual production of around 13.5 million tonnes in 2019, representing an increase in production of around 0.8%. The main EU producers were Poland (2.6 million tonnes, 19.5%), Spain (1.7 million tonnes, 12.8%) and France (1.7 million tonnes, 12.8%) (Figure 1) (MAPA, 2020; Eurostat, 2021).

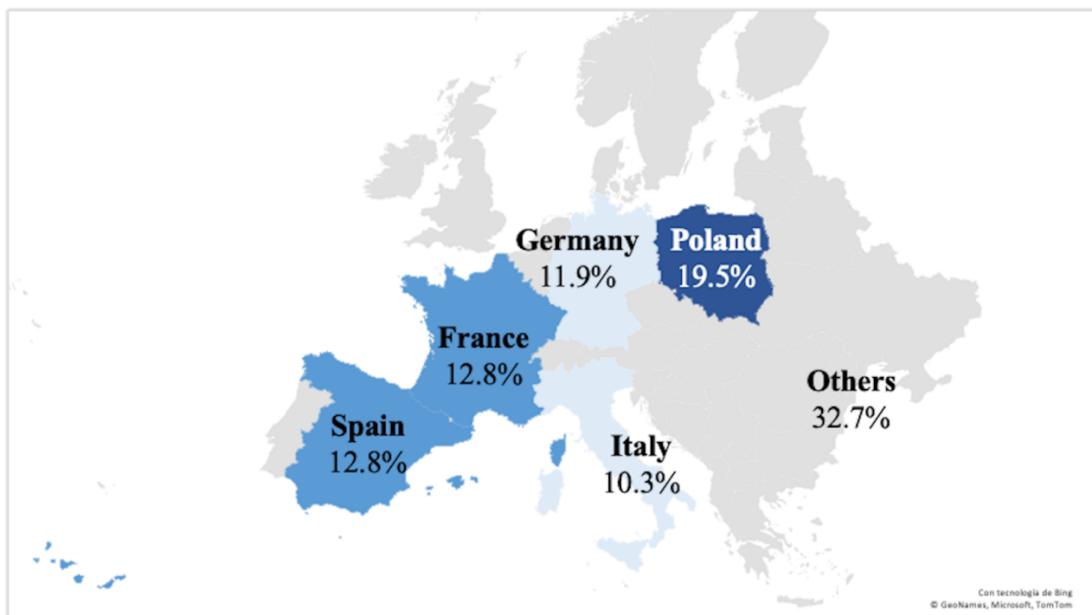

Figure 1. Poultry meat production in 2019 (Percentage share of EU members, based on tonnes of carcass weight). Adapted from Eurostat, 2021.

However, during the last year the European poultry meat sector has been significantly impacted by the COVID-19 crisis. Despite the high demand for poultry meat observed at the beginning of the EU lockdowns, it was not sufficient to compensate for the loss of the catering consumption market. This lack of demand resulted in low production levels throughout the production chain. Even so, the sector has demonstrated both its resilience and its ability to maintain adequate levels of supply, despite the difficulties caused by the virus (AVEC, 2020).

This demonstrates that the poultry production system is in constant development to meet consumer demands (FAO, 2021). Traditionally, it has evolved using strategies based on the intensification and automation of farm facilities (FAO, 2020; MAPA, 2020). However, current consumer awareness requires the implementation of sustainable production systems, respectful with animal welfare and the environment (Gomes *et al.*, 2014; Sassi *et al.*, 2016; Castellini and Dal Bosco, 2017; Mottet and Tempio, 2017; Goo *et al.*, 2019).

1.1.2 Animal welfare and resilience concepts

There are numerous definitions for **animal welfare**, but there is a general consensus that it means a balance between the animal itself and its surrounding environment. Broom stated that animal welfare is its state as regards its attempts to cope with its environment (Broom, 1986). Subsequently, the World Organisation for Animal Health (**OIE**) defined it as ‘an animal is in a good state of welfare if it is healthy, comfortable, well nourished, safe, able to express innate behaviour, and if it is not suffering from unpleasant states such as pain, fear and distress’ (OIE, 2019a).

The concept of animal welfare appeared in Europe in the 19th century, with organisations concerned about the conditions of animals, mainly horses, working in mines and transport. When working animals were successively replaced by machines, farm animals became the main target of animal welfare proponents. In this context, in 1964 Ruth Harrison succeeded, by the publication of 'Animal Machines', that the Britain Government investigated the welfare of farm animals (Harrison, 1964). Subsequently, in 1979 they formalised, by the UK Farm Animal Welfare Council, the ‘Five Freedoms’ (FAWC, 1979). Finally, the European Commission (**EC**) implemented the role of freedom in animal welfare regulation in 1998, showing that the perception of animal

welfare was closely related to the prevailing conditions of society (EC, 1998; Bessei, 2018).

The specific discussion on poultry welfare has been limited for several decades to European countries throughout (Bessei, 2018). However, current EU welfare regulations in broiler production are stricter than in other countries. The EU directive rigorously regulates stocking density, lighting, climate, noxious gases, feed and feeding systems, health care, inspection and hygiene measures (EC, 2007). In Spain, the directive is transposed in the Royal Degree 692/2010 (BOE, 2010), and the global regulation governing this issue is found within the Animal Protection and Welfare Code (BOE, 2020). Great strides have been achieved in recent years, but it is necessary to continue advancing in the study and improvement of animal welfare in animal production.

Moreover, it is demonstrated that an investment in more accurate and animal-friendly management systems in poultry production could directly affect animal health, by increasing animals' **resilience** (Soleimani *et al.*, 2012; FAO, 2013; Gomes *et al.*, 2014; Dawkins, 2017; Swaggerty *et al.*, 2019). Resilience is the capacity of an animal to be minimally affected by external or internal negative agents or to rapidly recover from their influence.

In this line, resilient animals can easily cope with environmental challenges or infectious diseases, so farmers can also reduce their use of antimicrobials (**AMAs**), achieving both healthy and easier-to-manage flocks (Colditz and Hine, 2016), creating a new approach to the development of poultry production systems.

1.1.3 Evolution of poultry production systems

For thousands of years, poultry production has been considered an important productive activity in human civilisation, and breeds and farm systems have been adapted to social cultures and agro-ecological systems (Alders *et al.*, 2018).

Prior to the 20th century, poultry were generally reared in extensive systems, largely free ranging, and dependent on scavenging and some supplementation of feed. However, from mid-century onwards, in response to rapidly increasing demands for animal-derived products driven by human population growth, poultry meat production increased dramatically due to the fast intensification of poultry industry and breed selection,

achieving shorter generation times, enhanced animal performance and higher meat content (Speedy, 2003; Alders *et al.*, 2018; Albrecht *et al.*, 2019). Although this growth has been considered a great success in economic terms, there are serious concerns regarding the long-term sustainability of intensive farming systems (Castellini *et al.*, 2012).

Recently, public awareness regarding animal welfare, food safety and environmental health has increased. The impact of livestock production on global warming and pollution, together with the need to control zoonotic infectious diseases and antimicrobial resistance (**AMR**) in the food chain, has encouraged the development of new production systems, including the ‘One Health’ concept in their design (Castellini *et al.*, 2012; Lusk, 2018a; Albrecht *et al.*, 2019). It is defined by the Centers for Disease Control and Prevention (**CDC**) and the One Health Commission (**OHC**) as ‘a collaborative, multisectoral, and transdisciplinary approach with the goal of achieving optimal health outcomes recognising the interconnection between people, animals, plants, and their shared environment’. It includes issues such as zoonotic diseases, AMR, food safety and food security, vector-borne diseases, environmental contamination and other health threats shared by people, animals and the environment (Mackenzie and Jeggo, 2019; Mayor Zaragoza *et al.*, 2019).

In this context, more sustainable production systems are being developed, focusing on enhanced animal welfare and limiting the use of AMAs by improving biosecurity and vaccination protocols, implementing precision livestock farming systems, and using more resistant and rustic slow-growing breeds, but also maintaining the profitability of broiler farms (Figure 2) (Sassi *et al.*, 2016; Castellini and Dal Bosco, 2017; Clavijo and Flórez, 2018; El-Deek and El-Sabrou, 2019).

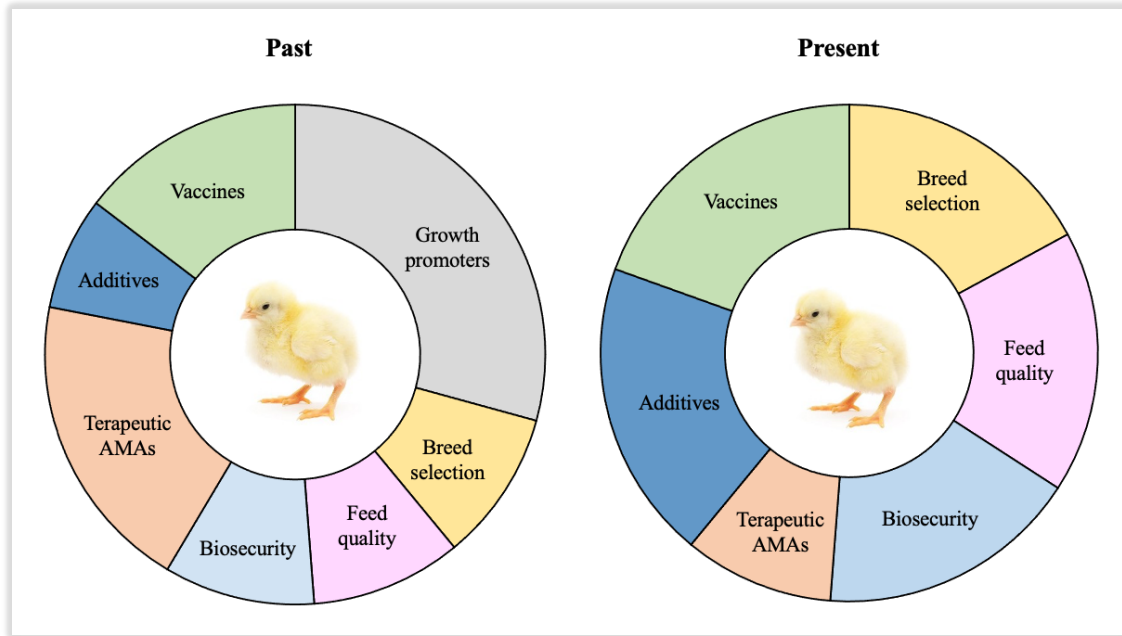

Figure 2. Evolution of protection tools in broiler production.

Finally, all the efforts carried out by the poultry sector to adapt the production systems to consumer demands are materialised in EU and Spanish legislation. The EC has developed different regulations to control animal welfare (EC, 2007) and AMAs administration (EC, 2019), creating the European Surveillance of Veterinary Antimicrobial Consumption (ESVAC) project (EMA, 2016). Moreover, as an EU member, Spain has followed European instructions, establishing the Animal Protection and Welfare Code (BOE, 2020) and the National AMR Plan (PRAN, 2020).

1.2 Influence of intestinal health in poultry

This section deals with the main definitions regarding microbial population, the influence of the microbiota in poultry health and the main methods to study it, as well as the characteristics of one of the main zoonotic pathogens in poultry, *Salmonella* spp.

1.2.1 Intestinal microorganisms in poultry production

1.2.1.1 Definitions

Microbial communities are commonly defined as the assemblage of microorganisms living together (including commensal, symbiotic and pathogenic ones), with their interactions, in a common biome. The **biome** is defined as a reasonably well-defined

habitat which has specific bio-physio-chemical properties (Konopka, 2009; Berg *et al.*, 2020). However, to study their inhabitants, there are three important concepts to distinguish.

Firstly, the term **microbiome** includes the sum of all microorganisms present in a defined biome (bacteria, archaea, phages, viruses, plasmids, prions, viroids, and free DNA) and their action area. Furthermore, this definition also encompasses the whole spectrum of molecules produced by the microorganisms under the influence of the surrounding environmental conditions, including their structural elements (nucleic acids, proteins, lipids, polysaccharides), and metabolites (signalling molecules, toxins, organic, and inorganic molecules). The term **microbiota** only refers to the living microorganisms of this biome, including viruses, bacteria, fungi and protozoa. However, with few exceptions, when discussing the microbiota in poultry intestine one is referring to the bacterial population. Finally, the **metagenome** defines the genetic potential of the microbiota and includes the collection of genomes, genes and plasmids within the different bacterial populations (Figure 3) (Marchesi and Ravel, 2015; Kogut, 2019; Berg *et al.*, 2020).

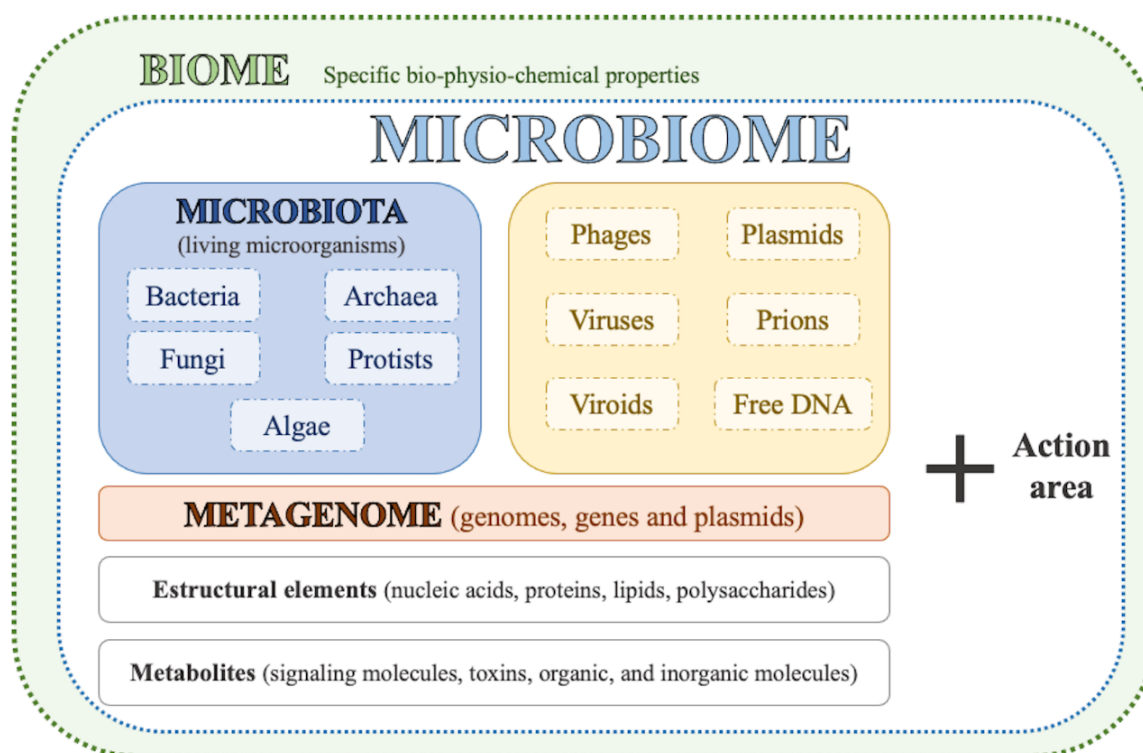

Figure 3. A schematic highlighting the composition of the term microbiome. Adapted from Berg *et al.*, 2020.

1.2.1.2 Influence on poultry health

It is demonstrated that microbiota composition and development have an important influence on animal health, productivity and disease control (Oviedo-Rondón, 2019). In fact, due to the close relationships existing between hosts and their associated microorganisms, it is considered that there is a coevolution between them (Zaneveld *et al.*, 2008; Berg *et al.*, 2020). In poultry, the digestive system is the main reservoir of microorganisms, and commensal bacteria have a considerable effect on its physiology, nutrient exchange, the exclusion of pathogens and also the modulation of the immune system (Clavijo and Flórez, 2018; Carrasco *et al.*, 2019).

The influence of the gut microbiota on the development of the intestinal tract is present since hatching, when the main colonising bacteria are established. These bacteria will compete with the pathogenic ones throughout the growing period, reducing the adhesion and colonisation of pathogens and zoonotic bacteria in the intestine by competitive exclusion. Moreover, regarding nutritional interaction, microbiota contribute nutrients that are important to the metabolism of broiler chickens, including short-chain fatty acids, ammonium, amino acids and vitamins (Pan and Yu, 2014; Clavijo and Flórez, 2018; Kogut, 2019). On the other hand, microbiota plays an important role in modulating both the innate and the acquired immune response of broilers. Regarding innate immune response, the intestinal mucosa is considered the first line of defence against infection. In the acquired immune system, the commensal bacteria provide protection to the mucosa membrane by modulating the immune response, by controlling the quantity of mediators secreted by the cells of the acquired immune system and stimulating the helper T cells (Brisbin *et al.*, 2008; Oakley *et al.*, 2014; Clavijo and Flórez, 2018).

Generally, during the first days of life, the intestinal tract is successively colonised by *Proteobacteria* and by *Firmicutes*. Afterwards, *Firmicutes* dominate the caecal population, followed by *Bacteroidetes* (Wei *et al.*, 2013; Ballou *et al.*, 2016). High levels of *Firmicutes* and *Bacteroidetes* phyla are correlated with good intestinal health, containing bacterial groups with diverse metabolic activities (Kumar *et al.*, 2018; Yacoubi *et al.*, 2018; Rychlik, 2020). In contrast, an increment of *Proteobacteria* population is associated with a disruption of the microbiota composition (dysbiosis) (Neal-McKinney *et al.*, 2012; Shin *et al.*, 2015). Therefore, it might be interesting to

consider microbiota composition as a biomarker of poultry health (Ducatelle *et al.*, 2018; Pandit *et al.*, 2018; Carrasco *et al.*, 2019).

Thus, it is deduced that balanced microbiota confers many benefits to the intestinal physiology of the host. Conversely, stress greatly affects intestinal health, causing dysbiosis, leakage of the mucosal barrier and inflammation. In this situation, pathogens could take the opportunity to colonise and multiply in the intestinal tract (Ducatelle *et al.*, 2018; He *et al.*, 2019; Kogut, 2019; Mandal *et al.*, 2020). In this sense, microbiota has been seen to be an important source of external and internal contamination of the carcass by bacteria of such great importance as *Salmonella* spp. and *Campylobacter* spp. during loading, transport and slaughter (Rasschaert *et al.*, 2008; Ellerbroek *et al.*, 2010). For this reason, defining a healthy microbiota is very important to be able to prevent or correct dysbiosis and minimise its impact on health (Dogra *et al.*, 2020).

In consequence, establishing poultry production systems based on improving animal welfare and biosecurity control could promote the presence of beneficial intestinal microbiota and the integrity of the intestinal epithelium, reducing the interactions between environmental and intestinal bacteria. This fact makes manipulation of the intestinal microbiota to enhance the beneficial components a promising therapeutic strategy for the future (Dawkins, 2019).

1.2.1.3 Methods for studying microbial communities

Traditionally, bacterial identification has been performed by phenotypic identification, using specific culture media and incubation conditions. Classic isolation techniques allow us to study bacterial morphology, development, biochemical characteristics and antimicrobial susceptibility (Bou *et al.*, 2011). However, it is estimated that only 10–20% of caecal bacteria can be cultured. This could be due to the fastidious growth requirement of many intestinal bacteria, the need to co-culture bacteria involved in metabolic cross-feeding, and storage, with general difficulties in reproducing environmental conditions (Stanley *et al.*, 2014; Clavijo and Flórez, 2018).

The recent implementation of molecular techniques in microbiology studies allows to evaluate intestinal bacteria in an overview. Therefore, we are now able to observe not only the target bacteria but also all the microorganisms present and their relationship.

Currently, two main methods for studying microbial communities using high-throughput sequencing are applied: whole-genome shotgun and marker gene studies. Whole-genome shotgun metagenomics sequences all genomes existing in a biome, to analyse the biodiversity and the functional capabilities of the microbial community. In contrast, marker gene analyses are based on the sequencing of a gene-specific region to reveal the diversity and composition of specific taxonomic groups; among these, the principal method used to analyse the presence of bacteria uses the 16S rRNA gene (Pérez-Cobas *et al.*, 2020).

In poultry, the caecum is described as the organ with the greatest taxonomic diversity and abundance (Clavijo and Flórez, 2018). For this reason, applying new metagenomic techniques in caeca samples could afford a better understanding of how the microbiota evolves in poultry and its effect on intestinal health (Ducatelle *et al.*, 2018).

1.2.2 Zoonotic microorganisms in poultry production

As defined by the World Health Organisation (**WHO**), ‘zoonosis is an infectious disease that has jumped from a non-human animals to humans; these pathogens may be bacterial, viral or parasitic, or may involve unconventional agents and can spread to humans through direct contact or through food, water or the environment’ (WHO, 2020).

In poultry, during and after slaughtering, the bacteria from intestinal microbiota and the slaughterhouse environment could contaminate carcasses and their subsequent products, and some of these bacterial contaminants can grow or survive during food processing and storage. For this reason, and due to the increasing trends of consumption and production of poultry derived products in EU, ensuring their microbial safety is an important issue for public health (Rouger *et al.*, 2017; EFSA and ECDC, 2019b). In this sense, *Campylobacter* spp. and *Salmonella* spp. are the two main zoonotic microorganisms involved in human gastroenteritis worldwide; within them, ***Salmonella* spp.** constitutes the main source of human foodborne outbreaks in EU (EFSA and ECDC, 2021).

1.2.2.1 *Salmonella* spp. characteristics, prevalence and control

Salmonella spp. are Gram-negative and facultatively anaerobic members of the family *Enterobacteriaceae*. They are motile and rod-shaped bacilli (Figure 4). Their motility is also conferred by flagella, and the most important species in human health is *S. enterica*,

which comprises more than 2 600 serovars with different specificities for vertebrate hosts (Graziani *et al.*, 2017).

In humans, clinical symptoms of salmonellosis are diarrhoea, abdominal pain, fever, headache, nausea and/or vomiting, lasting from 2 to 7 days, approximately. However, in some cases, particularly in children and elderly patients, the illness could become severe and life-threatening (WHO, 2018). In fact, in 2018 the proportion of cases with hospitalisation status in the EU was 43.2% of all salmonellosis cases (EFSA and ECDC, 2019b).



Figure 4. Characteristic *Salmonella* cells and related structures. Obtained from Centres of Disease Control and Prevention. Available at <https://www.cdc.gov/salmonella/reportspubs/salmonella-atlas/serotyping-importance.html>.

As reported above, it is considered the main source of human foodborne outbreaks in EU. In 2018, the European Food Safety Authority (EFSA) reported 91 857 confirmed cases (8 730 only in Spain) and a total of 1 581 outbreaks. Results for human salmonellosis cases were also similar to those observed in 2017. However, the number of outbreaks was higher compared to previous years. Moreover, it is important to highlight that a significantly increasing trend was observed in Spain between 2014 and 2018, due in part to an improvement in surveillance (EFSA and ECDC, 2019b). In 2019, Spain did not receive complete data due to the COVID-19 crisis, so the case numbers were lower than expected (with a total of 87 923 and 5 103 human cases in EU and in Spain, respectively) (EFSA and ECDC, 2021).

Regarding *Salmonella* serovars involved in human cases, the most commonly reported in 2018 and 2019 were *S. Enteritidis*, *S. Typhimurium*, monophasic *S. Typhimurium* (1,4,[5],12:i:-) and *S. Infantis*. Specifically, *S. Infantis* is widespread among most Member States (MS) and it is an important serovar throughout the poultry production chain. Moreover, the relevance of this serovar is further reinforced by its high levels of multidrug-resistance (MDR). This serovar was markedly related to broiler sources (93%), accounting for 36.5% of isolates from broiler flocks and 56.7% from broiler meat (Figure 5) (EFSA and ECDC, 2019b, 2021).

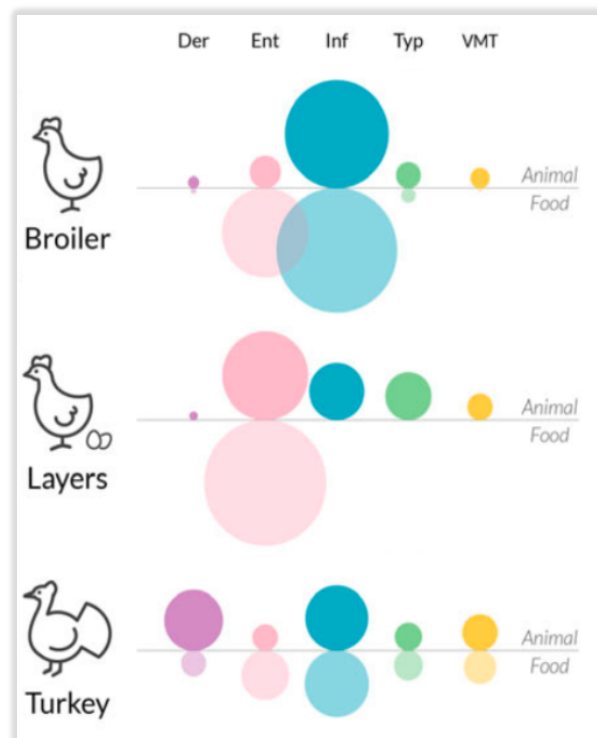

Figure 5. Distribution (%) of the human EU *Salmonella* serovars in poultry production. Adapted from EFSA and ECDC, 2021. Der: *S. Derby*, Ent: *S. Enteritidis*, Inf: *S. Infantis*, Typ: *S. Typhimurium*, VMT: *S. Typhimurium* monophasic variant.

In poultry, the EC established by the European Regulation 2160/2003 and its subsequent amendments, that MS have to set up *Salmonella* National Control Programmes to reduce the prevalence of those serovars considered relevant for public health. In this sense, in broiler production, boot swab samples must be taken before the animals leave for the slaughterhouse, and the target serovars are *S. Enteritidis*, *S. Typhimurium* and monophasic *S. Typhimurium* (1,4,[5],12:i:-) (EC, 2003a, 2012).

1.2.3 Antimicrobial resistance in poultry production

This section deals with a brief definition of AMR and its development, the main characteristics of *Escherichia coli* as AMR sentinel bacterium, the main mechanisms of AMR, and finally, the presence of AMR in poultry production.

1.2.3.1 Definition and development

As reported above, **AMR** is one of the most significant threats to public health worldwide, and also one of the most important concerns for consumers. Indeed, the WHO published that if effective interventions against the increase in AMR are not performed, by 2050 there could be more than 10 million deaths annually as a result of such resistance (WHO, 2019).

AMR occurs when bacteria, viruses, fungi and parasites change over time and develop the ability to defeat the medicines designed to kill them, making infections harder to treat and increasing the risk of disease spread, severe illness and death. As a result, the AMAs become ineffective and infections persist. Moreover, resistant microorganisms are considered a ‘One Health’ problem, because they can spread between people, animals, and the environment (Figure 6) (Davies and Davies, 2010; WHO, 2014; CDC, 2020).

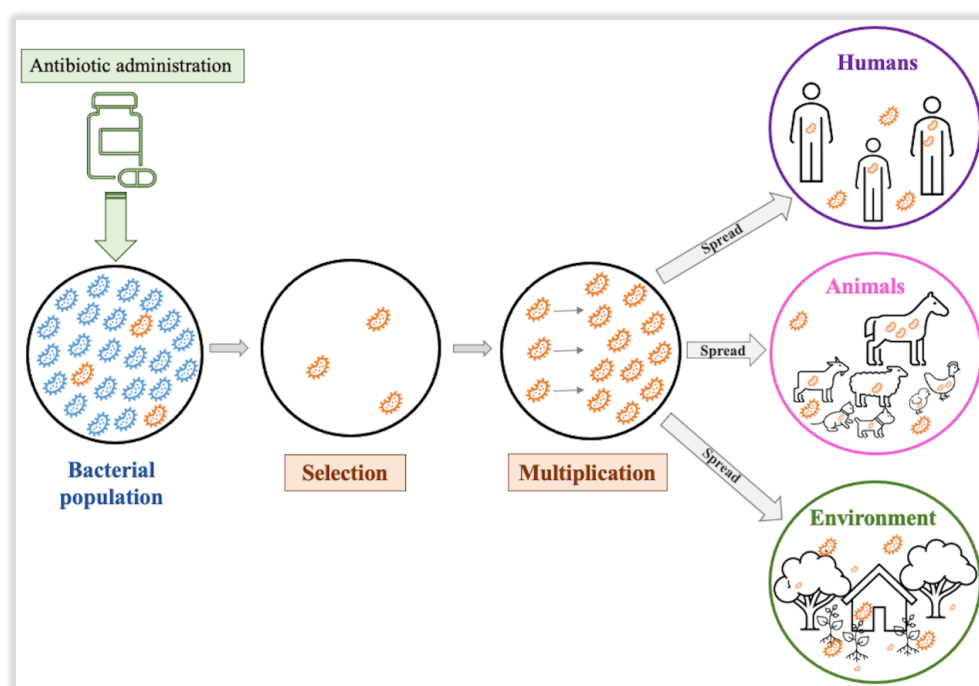

Figure 6. Antimicrobial resistance development and spread in a ‘One Health’ perspective.

Prior to the 20th century, in the pre-AMAs age, death from minor infections was commonplace. It was in 1928 when Alexander Fleming discovered penicillin and its antibiotic (AB) potential, but the first ABs introduced in clinical practice were the sulphonamides, in 1937. As of that moment, ABs were used to treat bacterial infections, saving thousands of lives both in animals and humans. Regrettably, the use of these wonder drugs was accompanied by the rapid appearance of resistant strains; in fact, in 1942 the first resistant bacteria appeared (Figure 7) (Clatworthy *et al.*, 2007; Davies and Davies, 2010; CDC *et al.*, 2020). Indeed, the widespread use of AMAs over the last 60 years has resulted in a significant increase in AMR and MDR bacteria worldwide. Moreover, super-resistant strains or ‘superbugs’ have appeared, with high levels of AMR and enhanced morbidity and mortality, further reducing the therapeutic options for these bacteria (Davies and Davies, 2010).

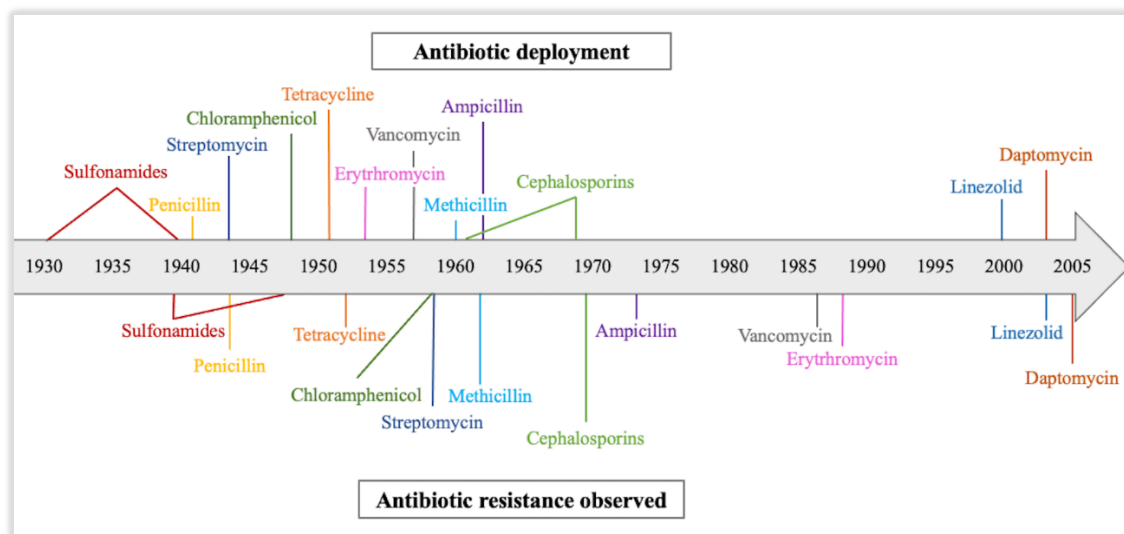

Figure 7. Timeline of antibiotics deployment vs. its antibiotic resistance observed. Adapted from Clatworthy *et al.*, 2007.

Alert to this crisis, the EC implemented the Directive 99/2003 (EC, 2003b), establishing the obligation to collect and analyse comparable data on AMR present in zoonotic agents in food and animals. Subsequently, in 2013 the EC developed Decision 652/2013, detailing and harmonising rules for the monitoring and reporting of AMR in EU MS (EC, 2013).

Thus, different organisms developed programmes to control the evolution of AMR. In the EU, the European Medicines Agency (EMA) started the ESVAC project in 2010, focused on the collection and reporting of data on the use of AMAs in animals from EU (EMA, n.d.). Moreover, EFSA and the European Centre for Disease Prevention and

Control (ECDC) have been drafting annual EU Summary Reports on AMR since 2014 (EFSA and ECDC, 2019a). Finally, in 2015 the WHO set out the Global Action Plan on Antimicrobial Resistance. The main objectives of this project were to improve awareness and understanding of AMR, to strengthen the knowledge base through surveillance and research, reduce the incidence of infection, optimise the use of AMAs in human and veterinary medicine, and to develop new medicines, vaccines and other tools to treat infections (WHO, 2015). In Spain, the National AMR Plan was established in 2014, promoted by the Ministries of Health and Agriculture and coordinated by the Spanish Agency for Medicines and Health Products (AEMPS), with the aim of increasing awareness about the prudent use of AMAs to reduce their application both in veterinary and human medicine (PRAN, 2019).

Regarding the results obtained of these efforts, in 2019 the EFSA demonstrated that legislation has mostly been implemented by the MS, increasing the production of comparable and reliable phenotypic AMR data over time, particularly of the resistance indicator *E. coli* (EFSA and ECDC, 2019a).

However, it is important to highlight that due to the complexity of the processes that contribute to emergence and dissemination of AMR, and the lack of basic knowledge on these topics, there has been so little significant achievement in the effective prevention and control of AMR development (Davies and Davies, 2010).

1.2.3.2 Commensal *Escherichia coli* as antimicrobial resistance sentinel bacterium

Regarding the evaluation of AMR, indicator commensal *E. coli* is considered by the EFSA as the main data of the EU-wide monitoring. It was selected as sentinel bacterium because it is well demonstrated that this bacterial species mirrors the exposure of the population to AMR selection pressure, and it constitutes a reservoir of resistance genes, providing valuable and comparable data between MSs (EFSA and ECDC, 2019a).

E. coli are Gram-negative, facultative anaerobic, motile rod-shaped bacteria (Figure 8), and include several serogroups that differ in pathogenic potential. The majority are non-pathogenic and innocuous residents of the intestine of vertebrates; however, some groups can cause severe diarrhoeal disease, occasionally with fatal outcome (Schaechter, 2009; Percival and Williams, 2013).



Figure 8. Characteristic *Escherichia coli* cells and related structures. Obtained from Centres of Disease Control and Prevention. Available at <https://www.cdc.gov/ecoli/2021/o157h7-02-21/index.html>.

E. coli is related to be the most abundant facultative anaerobe in faeces and intestine of animals. In fact, its prevalence in the intestines of production animals is usually above 90%. Moreover, in both structure and function, it is considered the prototype for members of the *Enterobacteriaceae* family (Schaechter, 2009; Percival and Williams, 2013; EFSA and ECDC, 2019a).

The monitoring of AMR in commensal *E. coli* is essential to provide comprehensive, comparable and reliable information on the development and spread of AMR bacteria, to measure the impact of measures taken to reduce AMR and to monitor progress achieved in the EU. The continually evolving threat from emerging resistance underlines the need to further strengthen AMR monitoring and to constantly review the data collected to inform, update and consolidate national action plans against AMR (EFSA and ECDC, 2019a).

1.2.3.3 Mechanisms of antimicrobial resistance

Bacteria can resist ABs action by different mechanisms, such as AB destruction, AB modification, modification of AB enzymes, target alterations (target replacement, target site mutations, target site enzymatic alterations, target site protection, target overproduction or target bypass), and by reducing AB accumulation due to either decreased permeability and/or increased efflux (Figure 9) (Reygaert, 2018).

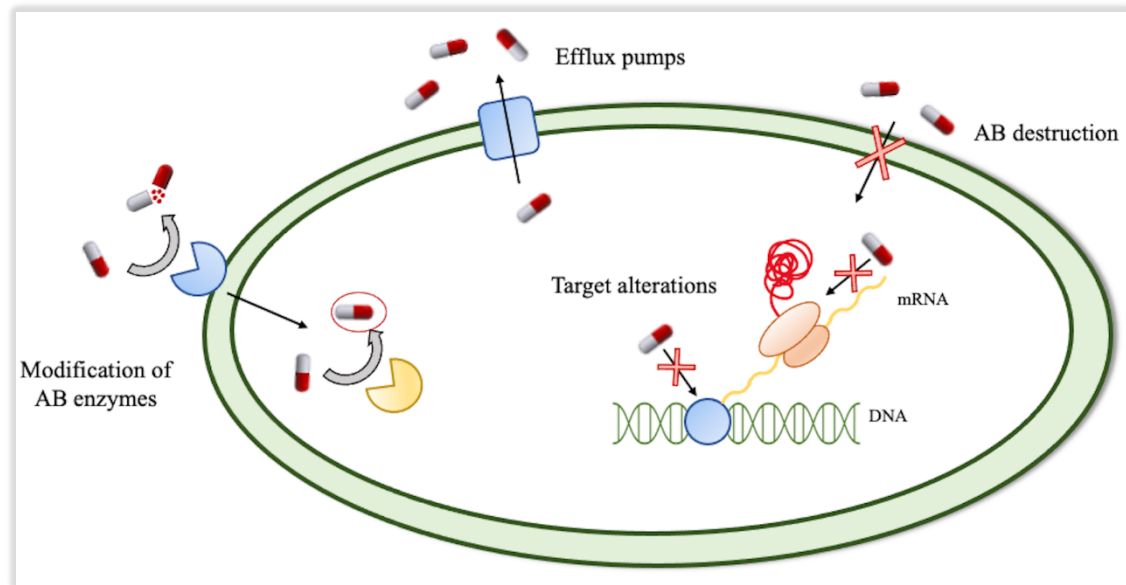

Figure 9. General antimicrobial resistance mechanisms. Adapted from Reygaert, 2018.

These resistance mechanisms exhibited by bacteria can be intrinsic, acquired, or adaptive (Joon-Lee, 2019; Christaki *et al.*, 2020).

Intrinsic resistance is due to the inherent properties of the bacterium. For instance, the impermeability of the outer membrane present in Gram-negative bacteria.

Acquired resistance appears when a previously susceptible bacterium acquires an AMR mechanism by a mutation or horizontal gene transfer. The transmission of new genetic material from exogenous bacteria can occur through three main processes (Figure 10):

- *Conjugation*: This involves the transfer of genetic material from one bacterial cell to another by direct physical contact between the cells, through plasmids transmission. Multiple resistance genes are often present on a single plasmid, enabling the transfer of MDR in a single conjugation event. This is probably the most important mechanism of horizontal gene transfer.
- *Transduction*: The transfer of genetic material between a donor and a recipient bacterium by a bacteriophage.
- *Transformation*: Consists of a genetic recombination in which free DNA fragments from a dead bacterium enter a recipient bacterium and are incorporated into its chromosome (not very common).

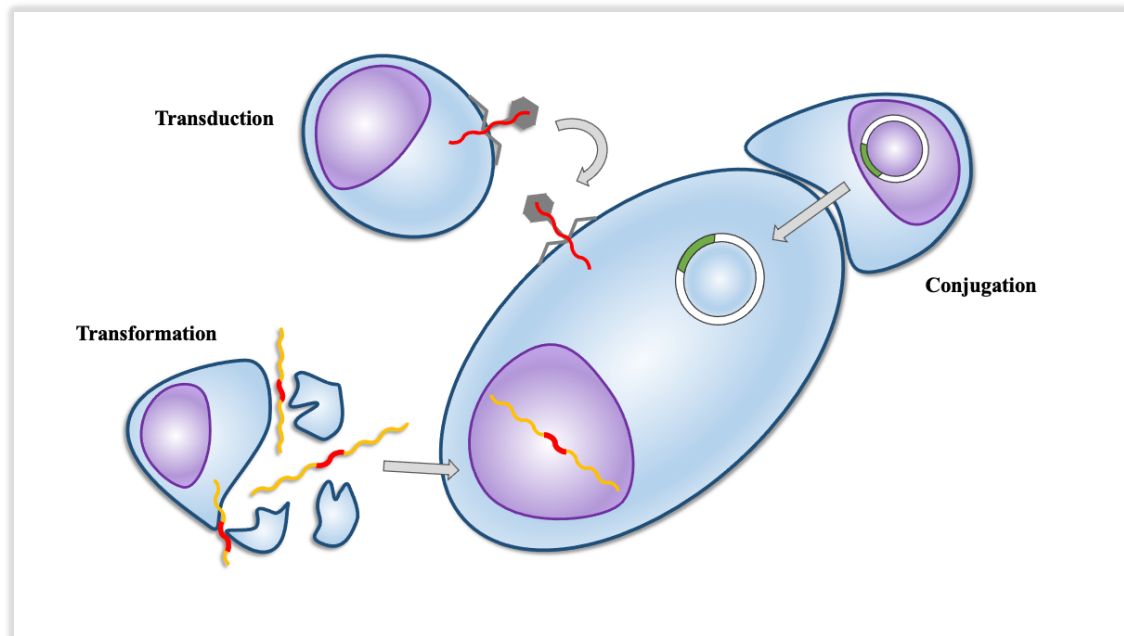

Figure 10. Horizontal resistance gene transmission between bacteria: conjugation, transduction and transformation. Adapted from Holmes *et al.*, 2016.

Finally, **adaptive resistance** is transient, resulting from modulations in gene expression as a response to environmental changes. These mechanisms appear induced by a specific signal (for example, stress, growth state, pH, concentrations of ions, nutrient conditions or sub-inhibitory levels of ABs) (Holmes *et al.*, 2016; Joon-Lee, 2019; Christaki *et al.*, 2020).

However, bacteria typically coexist in complex multi-species microbiomes, and their interactions could have a profound effect upon the response to an AB treatment. There are three main ways in which bacterial communities can survive AB exposure together (Figure 11), and these interactions could have multiple different effects and could occur simultaneously: collective resistance, collective tolerance and exposure protection. **Collective resistance** interactions elevate the ability to resist the action of ABs, continuing to increase the bacterial population. **Collective tolerance** interactions alter the cell state, slowing down the rate of bacterial death in the ABs presence, but without an increment of bacterial population. And, finally, **exposure protection** interactions protect the sensitive members of a bacterial population, reducing the effective concentration of the AB (Vega and Gore, 2014; Meredith *et al.*, 2015; Bottery *et al.*, 2020).

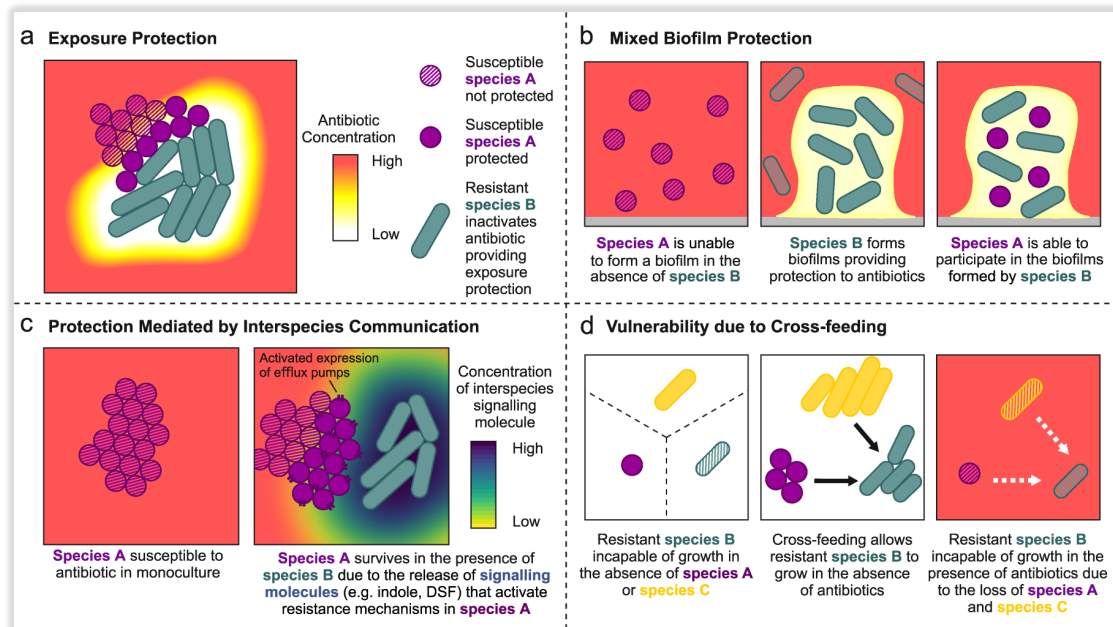

Figure 11. Microbial community interactions affecting the response to antibiotic exposure. A: Exposure protection: Resistant bacteria inactivating antibiotic concentration, protecting sensitive members of bacteria population. **B:** Collective tolerance: Some species unable to form biofilm collaborating in established biofilms of other species. **C:** Collective resistance: Susceptible community member of a bacterial population could activate their resistance mechanisms in the presence of other species. **D:** Due to the cross-feeding networks, tolerance to antibiotics is lowered to the level of the most susceptible community member, as resistant species are unable to grow due to the loss of essential resources. Obtained from Bottery *et al.*, 2020.

In conclusion, bacteria are highly versatile and adaptive, as in order to survive they need to be capable of dealing with toxic substances. However, with the alarming increase in AMR, it is imperative to find alternative and effective treatments to combat these pathogens. Unfortunately, there is no easy solution to this global problem. Perhaps it is necessary to design new AMA agents or to look for alternatives to prevent and treat bacterial infections (Reygaert, 2018).

1.2.3.4 Presence of antimicrobial resistance in poultry production

In animal production, traditionally the main objective of AMAs has been the therapeutic and prophylactic use in control of bacterial infections, but in the 1950s there was a deviation of this function and they began to be used in sub therapeutic doses as growth promoters. As reported above, balanced microbiota increase the resistance to colonisation by pathogenic microorganisms by competitive exclusion. However, these bacteria also entail costs for the host, including competition for nutrients, production of toxic catabolites and decrease of fat digestibility, at the expense of animal growth performance.

Thus, this different use promoted growth and efficiency of broilers (Dibner and Richards, 2005; Oliveira *et al.*, 2020).

Nevertheless, as outlined above, the uncontrolled administration of ABs in the past has resulted in an increased AMR and MDR presence in the food chain (Aarestrup, 2015; Khurana *et al.*, 2017; EFSA and ECDC, 2020). For this reason, the use of AMAs as growth promoters is a production technique banned in the EU since 2006 by the EC Directive 1831/2003 (EC, 2003c).

As a consequence, although the EMA reported that Spain has been the EU country with the highest consumption of ABs in animal production for several years, their consumption has halved (ESVAC, n.d.; EMA, 2020). In fact, there have been important differences between the first and the last EFSA reports regarding AMR in poultry production. During the period from 2006 to 2012, Spain presented the highest levels of AMR to most ABs, especially to quinolones and tetracyclines (EFSA and ECDC, 2014), but in 2020, it reported a decreasing trend in the AMR rates to b-lactams and tetracyclines (EFSA and ECDC, 2020).

These data are the result of the efforts made by the European and Spanish poultry sector to reduce AMA administration at field level. Firstly, by avoiding the entry and spread of pathogen microorganisms, improving biosecurity, farm management and vaccination protocols (Rojo-Gimeno *et al.*, 2016); and secondly, by investing in more accurate and animal-friendly management systems, achieving animals with a strengthened immune system and more resilient to contact with infectious agents (Soleimani *et al.*, 2012b; Gomes *et al.*, 2014; Rouger *et al.*, 2017; Swaggerty *et al.*, 2019). However, different scientific studies underline the importance of developing stricter sanitary measures at the interface between the environment and livestock farming to reduce AMR transmission to poultry chain (Allen *et al.*, 2010; Bengtsson-Palme *et al.*, 2018; Westphal-Settele *et al.*, 2018).

1.3 Main control measures for zoonotic and resistant microorganisms in poultry

In this context, it is essential to establish control measures in poultry farms to eliminate zoonotic and resistant microorganisms from the poultry production chain, such as the improvement of biosecurity protocols, the use of more rustic and slow-growing breeds, and the implementation of precision livestock farming management to better control environmental farm conditions.

1.3.1 Biosecurity

The first barrier created to protect farms from pathogen and AMR microorganisms is **biosecurity**. As defined by the OIE and Food and Agriculture Organisation of the United Nations (FAO), it consists of the measures implemented to reduce the risk of the introduction and spread of disease agents. Biosecurity is based on two basic principles: bio exclusion (the measures established to prevent the entering of infectious agents into the farms, such as introducing only controlled healthy birds and clean supplies of feed, water and litter), and biocontainment (which prevents the spread of the possible infectious agents). In addition, these principles involve segregation of the flocks (controlling the contacts with other animals and/or humans) and adequate cleaning and disinfection protocols (FAO, 2008; Alders *et al.*, 2018).

Subsequently, due to the new consumer concerns and meat market evolution, the FAO set out a holistic definition of biosecurity, including the ‘One Health’ concept: ‘strategic and integrated approach that encompasses the policy and regulatory frameworks (including instruments and activities) for analysing and managing relevant risks to human, animal and plant life and health, and associated risks to the environment’ (Figure 12). This definition includes not only the protection from pathogens, but also the need for a sustainable production, answering society’s demands both in terms of quality of the product and of the production (managing health risks to humans and animals, respectively), protecting the environment and biodiversity, and allowing farmers to make a living from their work and be recognised for it (FAO, 2007).

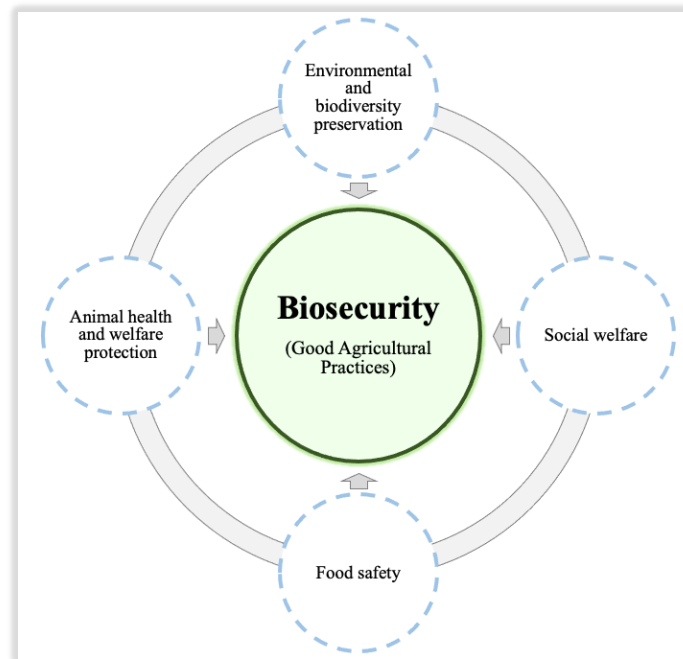

Figure 12. Holistic definition of biosecurity. Adapted from FAO, 2007.

In poultry production, the main biosecurity measures include that poultry farms should be located in a suitably isolated geographical location, surrounded by a security fence to prevent and control the entry of unwanted animals and people, constructed and maintained to prevent the entry of wild birds, rodents and arthropods to the poultry houses, and designed with materials so that correct cleaning and disinfection protocols could be carried out. In addition, all premises should have a written biosecurity plan. Regarding flock management, the ‘all-in all-out’ system is recommended, and all the data on bird health, production, medications, vaccination, mortality and surveillance should be recorded (OIE, 2019b).

Another measure to effectively prevent and control the spread of poultry diseases includes the use of **vaccination**, an important prophylactic tool worldwide. However, vaccines and vaccination programmes vary widely, depending on several local factors, such as type of production, the local pattern of disease, the status of maternal immunity, vaccines available, costs and potential losses (Marangon and Busani, 2006). For instance, with respect to *Salmonella* control in the Valencian Community, future broiler breeders must be vaccinated against *S. Enteritidis* and *S. Typhimurium*, according to European Regulation 2160/2003 (EC, 2003a; PAZ, 2021).

However, the poultry sector needs to keep evolving to overcome the threat of infectious diseases and AMR spread around the EU, which endangers both animal and human

health. More specifically, it is necessary to address all dimensions of the production chain (public safety, economic and environmental), and at multiple scales (local, regional, national and international) (Mottet and Tempio, 2017).

1.3.2 Broiler breeds

As reported above, in response to social awareness regarding animal welfare and AMR transmission through the food chain, new poultry production systems focused on sustainability are being developed. In this sense, producers are motivated to choose genetic breeds selected for their ability to deal with the natural environment, while also maintaining an adequate growth rate (Castellini and Dal Bosco, 2017). However, the balance between productive performance and animal welfare is not easy to achieve.

On the one hand, traditional commercial **fast-growing breeds** are selected for daily gain and feed-conversion rates, reaching the slaughter weight in 6-7 weeks; but they are also designed for intensive poultry production, needing to live under extreme environmental controlled conditions. Being able to satisfy consumer demands for poultry-derived products entails great profitability for broiler farms, but also a higher impact on global warming and greenhouse-gas emissions (Jez *et al.*, 2011). Moreover, these breeds are more susceptible to infectious diseases and more dependent on biosecurity measures and AMAs use (Castellini and Bosco, 2017; Albrecht *et al.*, 2019). On the other hand, **slow-growing breeds** are more adapted to organic poultry systems, being able to support poorer diets and environments, but taking a longer period to grow (about 9-12 weeks). This fact creates a different and more sustainable approach in poultry management, with adaptation to external environmental conditions, reducing local pollution and decreasing global impact (Jez *et al.*, 2011; Alders *et al.*, 2018). Moreover, their selected rustic and well-developed immune system could achieve a reduction in use of AMAs at field level. However, the lengthening of the growing period entails a lower efficiency of poultry production, with lower incomes for farmers or higher prices to consumers (Albrecht *et al.*, 2019).

Nevertheless, to be able to assess the effectiveness of these alternative production systems regarding AMR spread through the food chain, it is necessary to have better knowledge of the epidemiology of AMR throughout the growing period (Sirri *et al.*, 2011; Lusk, 2018b).

1.3.3 Precision livestock farming

Finally, a different approach proposed to solve public concerns regarding poultry production systems is being developed: **precision livestock farming**, focused on the improvement of farm management strategies and environmental farm conditions by using technology and engineering principles, but maintaining the use of fast-growing breeds. The main objective of this method is to create an automatic management system based on real-time monitoring to control animal performance, health and welfare, by recording data from diverse sources collected through smart sensors and compiled in a central database. In consequence, the reduction in health and welfare problems would lead to a more efficient and sustainable production in the long term (Berckmans, 2014; Sassi *et al.*, 2016; Rowe *et al.*, 2019).

In this sense, a large number of factors are considered sources of stress in poultry production, such as environmental deterioration, unsuitable social environments, difficulties in accessing essential resources, overcrowding, inadequate temperatures or diseases. Nevertheless, many of these factors can be controlled through well-established management practices to provide birds an optimal farm conditions (Gomes *et al.*, 2014; Sassi *et al.*, 2016; Goo *et al.*, 2019).

This way, creating a reliable, simple to understand and economically viable precision livestock farming system for widespread use could reduce costs and improve animal welfare and animals' resilience at field level. Moreover, due to the important influence on animal health and productivity of microbiota composition, combining these technological advances with the development of cost-effective and straightforward molecular techniques that allow an understanding of the evolution of microbiota during the growing period and the effect of management practices on its modulation, could help make decisions about the future of the poultry sector (Stanley *et al.*, 2014; Sassi *et al.*, 2016; Hasan and Yang, 2019; Rowe *et al.*, 2019).

1.4 Study cornerstone

In this context, poultry is one of the most important production sectors worldwide (OECD and FAO, 2020), which is in constant development to meet these consumer demands (FAO, 2020, 2021). However, current consumer awareness regarding animal welfare,

sustainability, food safety and AMR spread, all considered under the ‘One Health’ approach, requires the implementation of alternative production systems (Sassi *et al.*, 2016).

The alternatives proposed are focused on the improvement of all dimensions of the production chain, including genetic breeds selected for their ability to deal with the natural environment, but also maintaining an adequate growth rate, and the improvement of environmental conditions and thus animal welfare, and metagenomic studies to better control farm and animal health parameters.

However, to be able to assess the effectiveness of these alternative farm management techniques, it is necessary to have a better knowledge of the evolution of microbiota composition and the epidemiology of AMR in animal production (Sirri *et al.*, 2011; Lusk, 2018b).

In this context, the following chapters were designed to assess the effect of different farm management techniques on microbiota development and AMR dynamics during the growing period in poultry production.

1.5 References

Aarestrup, F. M. 2015. The livestock reservoir for antimicrobial resistance: A personal view on changing patterns of risks, effects of interventions and the way forward. *Philos. Trans. R. Soc. B Biol. Sci.* 370.

Albrecht, A., M. Hebel, M. Mittler, C. Hurck, K. Kustwan, B. Heitkönig, D. Bitschinski, J. Kreyenschmidt, and L. M. Lobato. 2019. Influence of Different Production Systems on the Quality and Shelf Life of Poultry Meat: A Case Study in the German Sector. *J. Food Qual.* 2019.

Alders, R. G., S. E. Dumas, E. Rukambile, G. Magoke, W. Maulaga, J. Jong, and R. Costa. 2018. Family poultry: Multiple roles, systems, challenges, and options for sustainable contributions to household nutrition security through a planetary health lens. *Matern. Child Nutr.* 14:1–14.

Allen, H. K., J. Donato, H. H. Wang, K. A. Cloud-Hansen, J. Davies, and J. Handelsman. 2010. Call of the wild: Antibiotic resistance genes in natural environments. *Nat. Rev. Microbiol.* 8:251–259.

AVEC (Association of Poultry Processors and Poultry Trade in the EU Countries). 2020. Annual Report 2020. Available at <https://avec-poultry.eu/wp-content/uploads/2020/09/05691-AVEC-annual-report-2020.pdf>.

Ballou, A. L., R. A. Ali, M. A. Mendoza, J. C. Ellis, H. M. Hassan, W. J. Croom, and M. D. Koci. 2016. Development of the chick microbiome: How early exposure influences future microbial diversity. *Front. Vet. Sci.* 3.

Bengtsson-Palme, J., E. Kristiansson, and D. G. J. Larsson. 2018. Environmental factors influencing the development and spread of antibiotic resistance. *FEMS Microbiol. Rev.* 42:68–80.

Berckmans, D. 2014. Precision livestock farming technologies for welfare management in intensive livestock systems. *OIE Rev. Sci. Tech.* 33:189–196.

Berg, G., D. Rybakova, D. Fischer, T. Cernava, M. C. C. Vergès, T. Charles, X. Chen, L. Cocolin, K. Eversole, G. H. Corral, M. Kazou, L. Kinkel, L. Lange, N. Lima, A. Loy, J.

A. Macklin, E. Maguin, T. Mauchline, R. McClure, B. Mitter, M. Ryan, I. Sarand, H. Smidt, B. Schelkle, H. Roume, G. S. Kiran, J. Selvin, R. S. C. de Souza, L. Van Overbeek, B. K. Singh, M. Wagner, A. Walsh, A. Sessitsch, and M. Schloter. 2020. Microbiome definition re-visited: old concepts and new challenges. *Microbiome* 8:103.

Bessei, W. 2018. Impact of animal welfare on worldwide poultry production. *Worlds. Poult. Sci. J.* 74:211–224.

BOE (Boletín Oficial del Estado). 2010. Spain. Royal Degree 692/2010, 20th of May 2010, por el que se establecen las normas mínimas para la protección de los pollos destinados a la producción de carne. Available at <https://www.boe.es/buscar/doc.php?id=BOE-A-2010-8824>.

BOE (Boletín Oficial del Estado). 2020. Spain. Código de Protección y Bienestar Animal. Available at <https://boe.es/legislacion/codigos/codigo.php?id=204&modo=1¬a=0&tab=2>.

Bottery, M. J., J. W. Pitchford, and V. P. Friman. 2020. Ecology and evolution of antimicrobial resistance in bacterial communities. *ISME J.*:1–10.

Bou, G., A. Fernández-Olmos, C. García, J. A. Sáez-Nieto, and S. Valdezate. 2011. Métodos de identificación bacteriana en el laboratorio de microbiología. *Enferm. Infecc. Microbiol. Clin.* 29:601–608.

Brisbin, J. T., J. Gong, and S. Sharif. 2008. Interactions between commensal bacteria and the gut-associated immune system of the chicken. *Anim. Health Res. Rev.* 9:101–110.

Broom, D. M. 1986. The scientific assessment of animal welfare. *Appl. Anim. Behav. Sci.* 20:5-19.

Carrasco, J. M. D., N. A. Casanova, and M. E. F. Miyakawa. 2019. Microbiota, gut health and chicken productivity: What is the connection? *Microorganisms* 7:1–15.

Castellini, C., A. Boggia, C. Cortina, A. Dal Bosco, L. Paolotti, E. Novelli, and C. Mugnai. 2012. A multicriteria approach for measuring the sustainability of different poultry production systems. *J. Clean. Prod.* 37:192–201.

Castellini, C. and A. Dal Bosco. 2017. Poultry Quality Evaluation: Quality Attributes and Consumer Values. Pages 335-357 in *Animal Welfare and Poultry Meat in Alternative Production Systems (and Ethics of Poultry Meat Production)*. Woodhead Publishing Series in Food Science, Technology and Nutrition, Elsevier Ltd. 2017.

CDC (Centers for Disease Control and Prevention), NCEZID (National Center for Emerging and Zoonotic Infectious Diseases), and DHQP (Division of Healthcare Quality Promotion). 2020. About Antibiotic Resistance. Available at <https://www.cdc.gov/drugresistance/about.html>.

Christaki, E., M. Marcou, and A. Tofarides. 2020. Antimicrobial Resistance in Bacteria: Mechanisms, Evolution, and Persistence. *J. Mol. Evol.* 88:26–40.

Clatworthy, A. E., E. Pierson, and D. T. Hung. 2007. Targeting virulence: A new paradigm for antimicrobial therapy. *Nat. Chem. Biol.* 3:541–548.

Clavijo, V., and M. J. V. Flórez. 2018. The gastrointestinal microbiome and its association with the control of pathogens in broiler chicken production: A review. *Poult. Sci.* 97:1006–1021.

Colditz, I. G., and B. C. Hine. 2016. Resilience in farm animals: Biology, management, breeding and implications for animal welfare. *Anim. Prod. Sci.* 56:1961–1983.

Davies, J., and D. Davies. 2010. Origins and Evolution of Antibiotic Resistance. *Microbiol. Mol. Biol. Rev.* 74:417–433.

Dawkins, M. S. 2017. Animal welfare and efficient farming: is conflict inevitable? *Anim. Prod. Sci.* 57:201.

Dawkins, M. S. 2019. Animal welfare as preventative medicine. *Anim. Welf.* 28:137–141.

Dibner, J. J., and J. D. Richards. 2005. Antibiotic growth promoters in agriculture: History and mode of action. *Poult. Sci. J.* 84:634-643.

Dogra, S. K., J. Doré, and S. Damak. 2020. Gut Microbiota Resilience: Definition, Link to Health and Strategies for Intervention. *Front. Microbiol.* 11:2245.

Ducatelle, R., E. Goossens, F. De Meyer, V. Eeckhaut, G. Antonissen, F. Haesebrouck, and F. Van Immerseel. 2018. Biomarkers for monitoring intestinal health in poultry: Present status and future perspectives. *Vet. Res.* 49:1–9.

EC (European Commission). 1998. Council Directive 98/58/EC of 20 July 1998 concerning the protection of animals kept for farming purposes. *Off. J. Eur. Communities*:23–27.

EC (European Commission). 2003a. Regulation (EC) No 2160/2003 of the European Parliament and of the Council of 17 November 2003 on the control of *Salmonella* and other specified food-borne zoonotic agents.

EC (European Commission). 2003b. Directive 2003/99/EC of the European Parliament and of the Council of 17 November 2003 on the monitoring of zoonoses and zoonotic agents, amending Council Decision 90/424/EEC and repealing Council Directive 92/117/EEC.

EC (European Commission). 2003c. Regulation (EC) No 1831/2003 of the European Parliament and of the Council of 22 September 2003 on additives for use in animal nutrition.

EC (European Commission). 2007. Council Directive 2007/43/EC of 28 June 2007 laying down minimum rules for the protection of chickens kept for meat production.

EC (European Commission). 2012. Commission Regulation (EU) No 200/2012 of 8 March 2012 concerning a Union target for the reduction of *Salmonella* Enteritidis and *Salmonella* Typhimurium in flocks of broilers, as provided for in Regulation (EC) No 2160/2003 of the European Parliament and of the Council.

EC (European Commission). Commission implementing Decision, of 12 november 2013, on the monitoring and reporting of antimicrobial resistance in zoonotic and commensal bacteria (2013/652/EU).

EC (European Commission). 2019. Regulation (EU) 2019/6 of the European Parliament and of the Council of 11 December 2018 on veterinary medicinal products and repealing Directive 2001/82/EC.

EFSA and ECDC (European Food Safety Authority and European Centre for Disease Prevention and Control). 2014. The European Union Summary Report on antimicrobial resistance in zoonotic and indicator bacteria from humans, animals and food in 2012. EFSA J.12(3):3590.

EFSA and ECDC (European Food Safety Authority and European Centre for Disease Prevention and Control). 2019a. Technical specifications on harmonised monitoring of antimicrobial resistance in zoonotic and indicator bacteria from food-producing animals and food. EFSA J. 17(6):5709.

EFSA and ECDC (European Food Safety Authority and European Centre for Disease Prevention and Control). 2019b. The European Union One Health 2018 Zoonoses Report. EFSA J. 17(12):5926.

EFSA and ECDC (European Food Safety Authority and European Centre for Disease Prevention and Control). 2020. The European Union Summary Report on Antimicrobial Resistance in zoonotic and indicator bacteria from humans, animals and food in 2017/2018. EFSA J. 18.

EFSA and ECDC (European Food Safety Authority and European Centre for Disease Prevention and Control). 2021. The European Union One Health 2019 Zoonoses Report. EFSA J. 19(2):6406.

El-Deek, A., and K. El-Sabrou. 2019. Behaviour and meat quality of chicken under different housing systems. Worlds. Poult. Sci. J. 75:105–114.

Ellerbroek, L. I., J. A. Lienau, and G. Klein. 2010. *Campylobacter* spp. in broiler flocks at farm level and the potential for cross-contamination during slaughter. Zoonoses Public Health 57.

EMA (European Medicines Agency). n.d. European Surveillance of Veterinary Antimicrobial Consumption (ESVAC). Available at <https://www.ema.europa.eu/en/veterinary-regulatory/overview/antimicrobial-resistance/european-surveillance-veterinary-antimicrobial-consumption-esvac> (verified 13 February 2021).

EMA (European Medicines Agency). 2016. ESVAC: Vision, Strategy and Objectives 2016-2020.

EMA (European Medicines Agency). 2020. Sales of veterinary antimicrobial agents in 31 European countries in 2018 (EMA/24309/2020). Trends from 2010 to 2018. Tenth ESVAC Rep. Available at <https://www.who.int/foodsafety/publications/antimicrobials->

ESVAC (European Surveillance of Veterinary Antimicrobial Consumption). European database of sales of veterinary antimicrobial agents. Available at <https://esvacbi.ema.europa.eu/analytics/saw.dll?PortalPages> (verified 22 January 2021).

Eurostat. 2021. Agricultural production - livestock and meat. Available at https://ec.europa.eu/eurostat/statistics-explained/index.php?title=Agricultural_production_-_livestock_and_meat&oldid=470510#Poultry (verified 4 February 2021).

FAO (Food and Agriculture Organization of the United Nations). 2007. FAO Biosecurity Toolkit. Available at <http://www.fao.org/3/a1140e/a1140e.pdf>.

FAO (Food and Agriculture Organization of the United Nations). 2008. Biosecurity for highly pathogenic avian influenza. Issues and options. Available at <http://www.fao.org/3/i0359e/i0359e.pdf>.

FAO (Food and Agriculture Organization of the United Nations). 2013. Poultry Development Review. Available at <http://www.fao.org/3/i3531e/i3531e.pdf>.

FAO (Food and Agriculture Organization of the United Nations). 2020. Meat market review - Overview of global meat market developments in 2019. Available at <http://www.fao.org/publications/card/es/c/CA8819EN/>.

FAO (Food and Agriculture Organization of the United Nations). 2021. Gateway to poultry production and products. Available at <http://www.fao.org/poultry-production-products/production/en/>.

FAWC (Farm Animal Welfare Council). 1979. Five Freedoms. Available at <https://webarchive.nationalarchives.gov.uk/20121010012427/http://www.fawc.org.uk/freedoms.htm>.

Gomes, A. V. S., W. M. Quinteiro-Filho, A. Ribeiro, V. Ferraz-de-Paula, M. L. Pinheiro, E. Baskeville, A. T. Akamine, C. S. Astolfi-Ferreira, A. J. P. Ferreira, and J. Palermo-Neto. 2014. Overcrowding stress decreases macrophage activity and increases *Salmonella* Enteritidis invasion in broiler chickens. *Avian Pathol.* 43:82–90.

Goo, D., J. H. Kim, G. H. Park, J. B. D. Reyes, and D. Y. Kil. 2019. Effect of heat stress and stocking density on growth performance, breast meat quality, and intestinal barrier function in broiler chickens. *Animals* 9.

Graziani, C., C. Losasso, I. Luzzi, A. Ricci, G. Scavia, and P. Pasquali. 2017. *Salmonella*. Pages 133–169 in *Foodborne Diseases*. Elsevier Ltd. 2017.

Harrison, R. 1964. *Animal Machines*. CAB International, Exfordshire, UK.

Hasan, N., and H. Yang. 2019. Factors affecting the composition of the gut microbiota, and its modulation. *PeerJ* 8:1–31.

He, J., Y. He, D. Pan, J. Cao, Y. Sun, and X. Zeng. 2019. Associations of gut microbiota with heat stress-induced changes of growth, fat deposition, intestinal morphology, and antioxidant capacity in ducks. *Front. Microbiol.* 10:1–13.

Holmes, A. H., L. S. P. Moore, A. Sundsfjord, M. Steinbakk, S. Regmi, A. Karkey, P. J. Guerin, and L. J. V. Piddock. 2016. Understanding the mechanisms and drivers of antimicrobial resistance. *Lancet* 387:176–187.

Jez, C., C. Beaumont, and P. Magdelaine. 2011. Poultry production in 2025: Learning from future scenarios. *Worlds. Poult. Sci. J.* 67:105–114.

Joon-Lee, H. 2019. Perspectives towards antibiotic resistance: from molecules to population. *J. Microbiol.* 57:181–184.

Khurana, A., R. Sinha, and M. Nagaraju. 2017. Antibiotic Resistance in Poultry Environment. Spread of Resistance from Poultry Farm to Agricultural Field. *Cent. Sci. Environ.*:1–36.

Kogut, M. H. 2019. The effect of microbiome modulation on the intestinal health of poultry. *Anim. Feed Sci. Technol.* 250:32–40.

Konopka, A. 2009. What is microbial community ecology. *ISME J.* 3:1223–1230.

Kumar, S., C. Chen, N. Indugu, G. O. Werlang, M. Singh, W. K. Kim, and H. Thippareddi. 2018. Effect of antibiotic withdrawal in feed on chicken gut microbial dynamics, immunity, growth performance and prevalence of foodborne pathogens. *PLoS One* 13:1–23.

Lusk, J. L. J. 2018a. Consumer Beliefs, Knowledge, and Willingness-to-Pay for Sustainability-Related Poultry Production Practices Broiler Survey Report. Prepared for the Food Marketing Institute Foundation, Animal Agriculture Alliance, and the Foundation for Food and Agriculture Research.

Lusk, J. L. 2018b. Consumer preferences for and beliefs about slow growth chicken. *Poult Sci.* 97:4159-4166.

Mackenzie, J. S., and M. Jeggo. 2019. The one health approach-why is it so important? *Trop. Med. Infect. Dis.* 4.

Mandal, R. K., T. Jiang, R. F. Wideman, T. Lohrmann, and Y. M. Kwon. 2020. Microbiota Analysis of Chickens Raised Under Stressed Conditions. *Front. Vet. Sci.* 7:482637.

MAPA (Ministerio de Agricultura y Alimentación). 2020. El sector de la avicultura de carne en cifras. Principales Indicadores Económicos 2019. Dirección General De Producciones Y Mercados Agrarios. Available at https://www.mapa.gob.es/es/ganaderia/estadisticas/indicadores2019carneparapublicar_tcm30-419674.pdf.

Marangon, S., and L. Busani. 2006. The use of vaccination in poultry production. *Rev. sci. tech. Off. int. Epiz.* 26(1):265-274.

Marchesi, J. R., and J. Ravel. 2015. The vocabulary of microbiome research: a proposal. *Microbiome* 3.

Mayor Zaragoza, F., F. Fariñas Guerrero, and S. Vega García. 2019. *One health: Cambio climático, contaminación ambiental y el impacto sobre la salud humana y animal* (J Ábrego Bonafonte, Ed.). Amazing Books S.L.

Meredith, H. R., J. K. Srimani, A. J. Lee, A. J. Lopatkin, and L. You. 2015. Collective antibiotic tolerance: Mechanisms, dynamics and intervention. *Nat. Chem. Biol.* 11:182–188.

Mottet, A., and G. Tempio. 2017. Global poultry production: Current state and future outlook and challenges. *Worlds. Poult. Sci. J.* 73:245–256.

Neal-McKinney, J. M., X. Lu, T. Duong, C. L. Larson, D. R. Call, D. H. Shah, and M. E. Konkel. 2012. Production of Organic Acids by Probiotic Lactobacilli Can Be Used to Reduce Pathogen Load in Poultry. *PLoS One* 7.

Oakley, B. B., H. S. Lillehoj, M. H. Kogut, W. K. Kim, J. J. Maurer, A. Pedroso, M. D. Lee, S. R. Collett, T. J. Johnson, and N. A. Cox. 2014. The chicken gastrointestinal microbiome. *FEMS Microbiol. Lett.* 360:100–112.

OECD (Organisation for Economic Co-operation and Development), and FAO (Food and Agriculture Organization of the United Nations). 2020. *OECD-FAO Agricultural Outlook 2020-2029*. Available at <https://www.oecd-ilibrary.org/docserver/1112c23b-en.pdf?expires=1614517687&id=id&accname=guest&checksum=4B996B6B571FC02A178422481DCCBBB2>.

OIE (World Organisation for Animal Health). 2019a. *World Organisation for Animal Health*. Available at <https://www.oie.int/en/standard-setting/terrestrial-code/>.

OIE (World Organization for Animal Health). 2019b. *Biosecurity procedures in poultry production*. In *Terrestrial Animal Health Code 28/06/2019*.

Oliveira, N. A., B. L. Gonçalves, S. H. Lee, O. Caf, and C. Humberto Corassin. 2020. Antibiotics in Animal Production and Its Impact on Human Health. *J Food Chem Nanotechnol* 6:40–47.

Oviedo-Rondón, E. O. 2019. Holistic view of intestinal health in poultry. *Anim. Feed Sci. Technol.* 250:1–8.

Pan, D., and Z. Yu. 2014. Intestinal microbiome of poultry and its interaction with host and diet. *Gut Microbes* 5:108–119.

Pandit, R. J., A. T. Hinsu, N. V. Patel, P. G. Koringa, S. J. Jakhesara, J. R. Thakkar, T. M. Shah, G. Limon, A. Psifidi, J. Guitian, D. A. Hume, F. M. Tomley, D. N. Rank, M. Raman, K. G. Tirumurugaan, D. P. Blake, and C. G. Joshi. 2018. Microbial diversity and community composition of caecal microbiota in commercial and indigenous Indian chickens determined using 16s rDNA amplicon sequencing. *Microbiome* 6:1–13.

PAZ (Plan Anual Zoonosanitario de la Comunidad Valenciana). 2021. Valencian Community. Resolution 268/2021, 12th of January 2021, del director general de Agricultura, Ganadería y Pesca, por la que se aprueban el Plan anual zoonosanitario para 2021 de la Comunitat Valenciana y otras actuaciones complementarias.

Percival, S. L., and D. W. Williams. 2013. *Escherichia coli*. Pages 89–117 in *Microbiology of Waterborne Diseases: Microbiological Aspects and Risks: Second Edition*. Elsevier Ltd.

Pérez-Cobas, A. E., L. Gomez-Valero, and C. Buchrieser. 2020. Metagenomic approaches in microbial ecology: An update on whole-genome and marker gene sequencing analyses. *Microb. Genomics* 6:1–22.

PRAN (Plan Nacional de Resistencia Antibióticos). 2019. Plan Nacional frente a la Resistencia a los Antibióticos 2019-2021. Available at https://resistenciaantibioticos.es/es/system/files/field/files/pran_2019-2021_0.pdf?file=1&type=node&id=497&force=0.

PRAN (Plan Nacional de Resistencia Antibióticos). 2020. Informe Anual PRAN Junio 2019 - Junio 2020. Available at

https://resistenciaantibioticos.es/es/system/files/field/files/informe_anual_pran_2019_2020_0.pdf?file=1&type=node&id=577&force=0.

Rasschaert, G., K. Houf, C. Godard, C. Wildemaewe, M. Pastuszczak-Frąk, and L. De Zutter. 2008. Contamination of carcasses with *Salmonella* during poultry slaughter. *J. Food Prot.* 71:146–152.

Reygaert, W. C. 2018. An overview of the antimicrobial resistance mechanisms of bacteria. *AIMS Microbiol.* 4:482–501.

Rojo-Gimeno, C., M. Postma, J. Dewulf, H. Hogeveen, L. Lauwers, and E. Wauters. 2016. Farm-economic analysis of reducing antimicrobial use whilst adopting improved management strategies on farrow-to-finish pig farms. *Prev. Vet. Med.* 129:74–87.

Rouger, A., O. Tresse, and M. Zagorec. 2017. Bacterial Contaminants of Poultry Meat: Sources, Species, and Dynamics. *Microorganisms* 5:50.

Rowe, E., M. S. Dawkins, and S. G. Gebhardt-Henrich. 2019. A systematic review of precision livestock farming in the poultry sector: Is technology focussed on improving bird welfare? *Animals* 9.

Rychlik, I. 2020. Composition and function of chicken gut microbiota. *Animals* 10.

Sassi, N. Ben, X. Averós, and I. Estevez. 2016. Technology and poultry welfare. *Animals* 6:1–21.

Schaechter, M. 2009. *Escherichia coli*. Pages 125–132 in *Encyclopedia of Microbiology*. Elsevier Inc.

Shin, N. R., T. W. Whon, and J. W. Bae. 2015. Proteobacteria: Microbial signature of dysbiosis in gut microbiota. *Trends Biotechnol.* 33:496–503.

Sirri, F., C. Castellini, M. Bianchi, M. Petracci, A. Meluzzi, and A. Franchini. 2011. Effect of fast-, medium- and slow-growing strains on meat quality of chickens reared under the organic farming method. 91:312–319.

Soleimani, A. F., I. Zulkifli, M. Hair-Bejo, M. Ebrahimi, S. D. Jazayeri, S. R. Hashemi, A. Meimandipour, and Y. M. Goh. 2012. Epigenetic modification: possible approach to reduce *Salmonella enterica* serovar enteritidis susceptibility under stress conditions. *Avian Pathol.* 41:351–354.

Speedy, A. W. 2003. Global Production and Consumption of Animal Source Foods. *J Nutr.* 133:4048S-4053S.

Stanley, D., R. J. Hughes, and R. J. Moore. 2014. Microbiota of the chicken gastrointestinal tract: Influence on health, productivity and disease. *Appl. Microbiol. Biotechnol.* 98:4301–4310.

Swaggerty, C. L., T. R. Callaway, M. H. Kogut, A. Piva, and E. Grilli. 2019. Modulation of the immune response to improve health and reduce foodborne pathogens in poultry. *Microorganisms* 7:1–10.

Vega, N. M., and J. Gore. 2014. Collective antibiotic resistance: Mechanisms and implications. *Curr. Opin. Microbiol.* 21:28–34.

Wei, S., M. Morrison, and Z. Yu. 2013. Bacterial census of poultry intestinal microbiome. *Poult. Sci.* 92:671–683.

Westphal-Settele, K., S. Konradi, F. Balzer, J. Schönfeld, and R. Schmithausen. 2018. The environment as a reservoir for antimicrobial resistance: A growing problem for public health? *Bundesgesundheitsblatt - Gesundheitsforsch. - Gesundheitsschutz* 61:533–542.

WHO (World Health Organization). 2014. Antimicrobial resistance: global report on surveillance 2014. Available at <https://www.who.int/antimicrobial-resistance/publications/surveillancereport/en/>.

WHO (World Health Organization). 2015. Global action plan on antimicrobial resistance. Available at <https://www.who.int/antimicrobial-resistance/publications/global-action-plan/en/>.

WHO (World Health Organization). 2018. *Salmonella* (non-typhoidal). Available at [https://www.who.int/news-room/fact-sheets/detail/salmonella-\(non-typhoidal\)](https://www.who.int/news-room/fact-sheets/detail/salmonella-(non-typhoidal)).

WHO (World Health Organization). 2019. Critically important antimicrobials for human medicine, 6th revision. Available at <https://www.who.int/foodsafety/publications/antimicrobials-sixth/en/>.

WHO (World Health Organization). 2020. Zoonoses. Available at <https://www.who.int/news-room/fact-sheets/detail/zoonoses>.

Yacoubi, N., L. Saulnier, E. Bonnin, E. Devillard, V. Eeckhaut, L. Rhayat, R. Ducatelle, and F. Van Immerseel. 2018. Short-chain arabinoxylans prepared from enzymatically treated wheat grain exert prebiotic effects during the broiler starter period. *Poult. Sci.* 97:412–424.

Zaneveld, J., P. J. Turnbaugh, C. Lozupone, R. E. Ley, M. Hamady, J. I. Gordon, and R. Knight. 2008. Host-bacterial coevolution and the search for new drug targets. *Curr. Opin. Chem. Biol.* 12:109–114.

CHAPTER II. OBJECTIVES

The general objective of this doctoral thesis was to evaluate the effect of improving animal welfare in poultry production on the microbiota composition development, AMR dynamics and *Salmonella* epidemiology. To achieve this goal, two different experiments were performed.

Firstly, the effect of the genetic breed was studied by comparing a commercial fast-growing breed *vs.* an alternative slow-growing breed, reared under their respective management systems. For this purpose, the following objectives were proposed:

1. To characterise the caecal microbiota in two different broiler management systems, fast and slow-growing, during their respective growing periods, using 16S rRNA sequencing analysis.
2. To investigate the AMR and MDR dynamics in two genetic poultry breeds, fast-growing and slow-growing, during the growing period, using commensal *E. coli* as sentinel bacterium.

Secondly, the effect of the farm management conditions was evaluated by comparing commercial European density and ventilation conditions *vs.* improved conditions in a commercial fast-growing breed. To this end, the following objectives were proposed:

3. To analyse the influence on microbiota balance of broilers in standardised commercial farm conditions or under improved farm conditions, using 16S rRNA sequencing analysis.
4. To evaluate the AMR and MDR dynamics during growing period under two different management conditions (commercial *vs.* optimal), using *E. coli* as sentinel bacterium.
5. To investigate the development of *S. Infantis* AMR during the broiler growing period, according to density and ventilation management.

CHAPTER III. EXPERIMENTAL CHAPTERS

3.1 Effect of the genetic breed on intestinal microbiota and antimicrobial resistance dynamics

3.1.1 Fast and slow-growing management systems: characterisation of broiler caecal microbiota development throughout the growing period

A modified version of this chapter has been published with the reference:

L. Montoro-Dasi, A. Villagra, M. de Toro, M.T. Pérez-Gracia, S. Vega, C. Marin. 2020. Fast and slow-Growing management systems: characterisation of broiler caecal microbiota development throughout the growing period. *Animals*; 10(8):1401. doi: 10.3390/ani10081401.

3.1.1.1 Abstract

Caecal microbiota and its modulation play an important role in poultry health, productivity and disease control. Moreover, due to the emergence of antimicrobial-resistant bacteria, society is pressing for a reduction in AB administration by finding effective alternatives at farm level, such as less intensified production systems. Hence, the aim of this study was to characterise the caecal microbiota in two different broiler management systems, fast and slow-growing, using 16S rRNA sequencing analysis. To this end 576 broilers were reared in two different management systems (fast and slow-growing). Results showed that *Firmicutes* represented the dominant phylum for both systems. At the onset, *Proteobacteria* was the second prevalent phylum for fast and slow-growing breeds, outnumbering the *Bacteroidetes*. However, during the rest of the production cycle, *Bacteroidetes* was more abundant than *Proteobacteria* in both groups. Finally, regardless of the management system, the most predominant genera identified were *Oscillospira* spp., *Ruminococcus* spp., *Coprococcus* spp., *Lactobacillus* spp. and *Bacteroides* spp. In conclusion, fast and slow-growing broiler microbiota is in constant development throughout rearing, being relatively stable at 21 days of age. Regarding the genus, it should be noted that the three most abundant groups for both systems, *Ruminococcus* spp., *Lactobacillus* spp. and *Bacteroides* spp., are related to better productive performance and intestinal health.

3.1.1.2 Introduction

Microbiota is defined as the microbial community, including commensal, symbiotic and pathogenic microorganisms, which colonise different areas of animals and have an important influence on animal health, productivity and disease control (Oakley *et al.*, 2014; Stanley *et al.*, 2014; Pourabedin and Zhao, 2015; Sender *et al.*, 2016; Banerjee *et al.*, 2018; Clavijo and Flórez, 2018; Pandit *et al.*, 2018; Shang *et al.*, 2018; Carrasco *et al.*, 2019). Hence, the presence of beneficial microbiota plays an important role in production, protection from pathogens, control of epithelial cell proliferation and differentiation, detoxification (controlling the behavioural and neurological functions of the host) and modulation of the immune system (Sekirov *et al.*, 2010; Clavijo and Flórez, 2018; Carrasco *et al.*, 2019).

Principal factors affecting the microbiota are age, breed, maternal elements, sex, diet, housing, hygiene, temperature, litter, AB administration and gastrointestinal location (Clavijo and Flórez, 2018; Kers *et al.*, 2018). Referring to the last factor mentioned, the caecum is described as the organ with the greatest taxonomic diversity and abundance, which retains food for the longest period, with the greatest water absorption, and it is responsible for urea regulation and carbohydrates fermentation (Clavijo and Flórez, 2018).

Moreover, due to the emergence of antimicrobial-resistant bacteria, society is pressing for a reduction in AB administration by finding effective alternatives to control infectious diseases at farm level (WHO, 2014; Alós, 2015; Gadde *et al.*, 2017; Montoro-Dasi *et al.*, 2020). Some of these alternatives are feed additives (prebiotics, probiotics, symbiotics, organic acids, enzymes, phytochemicals and metals), alternative medical treatments (antibacterial vaccines, immunomodulatory agents, antimicrobial peptides and bacteriophages) and, finally, different, less intensified broiler management systems (Hancock *et al.*, 2012; Cheng *et al.*, 2014; Castellini and Dal Bosco, 2017; Polycarpo *et al.*, 2017; Suresh *et al.*, 2017; Sevilla-Navarro *et al.*, 2018; Alagawany *et al.*, 2018). Although the beneficial effects of many of these alternatives have been demonstrated *in vitro*, the general consensus is that the effect of these products depends on the farm, farmer management and animal characteristics, such as the breed selected (Gadde *et al.*, 2017; Kogut *et al.*, 2017; Kers *et al.*, 2018).

The variability obtained in different studies highlights the need to know, under production conditions, how the microbiota evolves, which could assist in decision-making *in situ*, especially at critical moments of the production period. For example, when the broiler reaches the farm from the incubator, an adaptation moment that will mark the development of the production cycle (Pedroso *et al.*, 2005; Oakley *et al.*, 2013; Kers *et al.*, 2018; Carrasco *et al.*, 2019; Richards *et al.*, 2019); at the stage when the immune and digestive system is already mature, and therefore, will determine the potential of the breed in terms of growth and conversion (Brisbin *et al.*, 2008; Shang *et al.*, 2018; Xi *et al.*, 2019); or at the end of the cycle, a key moment, as it is the step before the animals are transferred to the slaughterhouse. The microbiota has been seen to be an important source of external and internal contamination of the carcass by bacteria of such great importance as *Salmonella* and *Campylobacter* during loading, transport and slaughter (Rasschaert *et al.*, 2008; Ellerbroek *et al.*, 2010; Kogut, 2019; Sevilla-Navarro *et al.*, 2020). Therefore, having a broad knowledge of this composition throughout the cycle can help the sector choose the different control measures to be applied during rearing, which enhance the presence of beneficial microorganisms, as well as the immune system, and can control and even eliminate the presence of pathogenic microorganisms at critical moments in the production cycle (Clavijo and Flórez, 2018; Carrasco *et al.*, 2019; Kogut, 2019). However, today there is still a need to develop cost-effective and straightforward molecular techniques that can be used for this purpose at field level.

In this context, the aim of this study was to characterise the caecal microbiota in two different broiler management systems, fast and slow-growing, during their respective growing periods, using 16S rRNA sequencing analysis.

3.1.1.3 Material and methods

In this experiment, all animals were handled according to the principles of animal care published by Spanish Royal Decree 53/2013 (BOE, 2013).

3.1.1.3.1 Experiment design

The study was performed in an experimental poultry house in the Centre for Animal Research and Technology (CITA-IVIA, in its Spanish acronym, *Centro de Investigación y Tecnología Animal – Instituto Valenciano de Investigaciones Agrarias*, Segorbe,

Spain). To this end, 576 broilers (males and females) provided from the same hatchery were randomly housed in two identical poultry rooms (replicates A and B) and 288 animals were housed in each room (144 fast and 144 slow-growing breeds). In addition, animals were distributed in 24 pens (12 pens for each group, fast and slow-growing broiler management system) of 1.3 m² in a final stocking density of 35 kg/m², with wood shavings as bedding material (Figure 13).

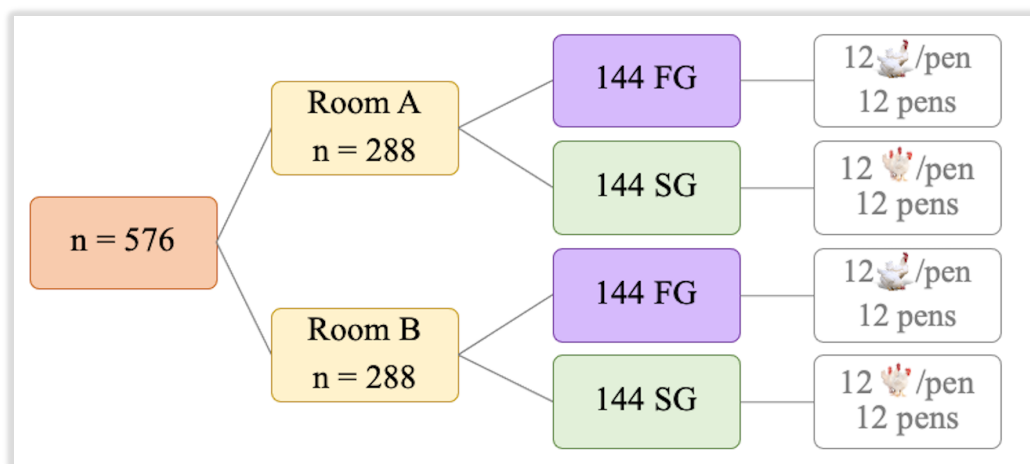

Figure 13. Animals' housing scheme in experiment 1. FG: Fast-growing breed; SG: Slow-growing breed.

Two management systems were evaluated: fast-growing and slow-growing, and two commercial breeds were used (Ross® and Hubbard®, respectively). The fast-growing management is characterised by using an efficient feed conversion and good meat yield breed (Ross, 2019), with the appropriate feed, and an early slaughter age (42 days). In contrast, the slow-growing management system is a less intensified type of production, focused on the criteria of animal welfare and absence of ABs (Valls, 2017), with a different feed and a later slaughter age (63 days) (Figure 14).

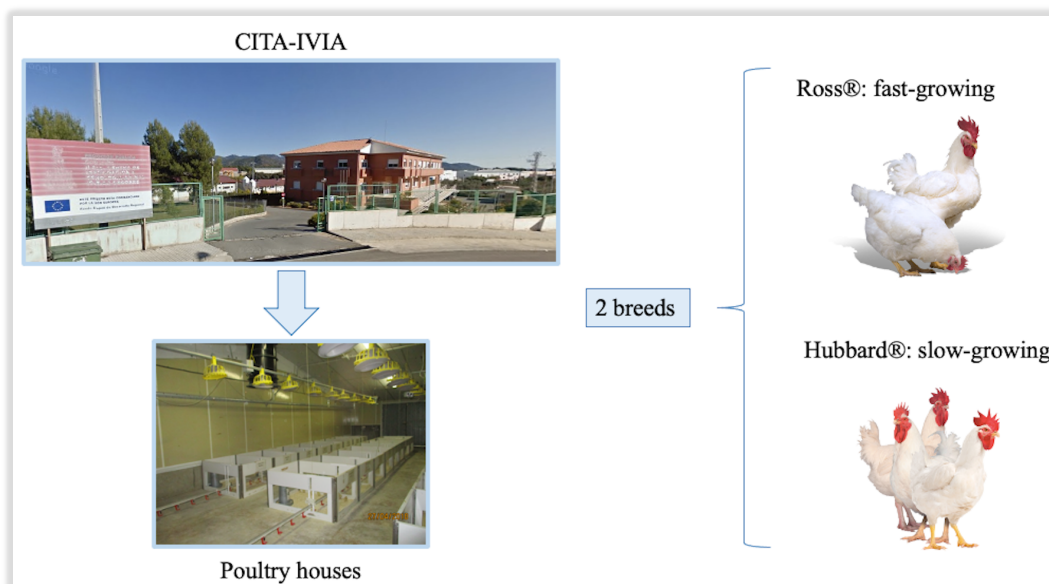

Figure 14. Experiment design management systems scheme in experiment 1.

To simulate the real conditions of broiler production, the houses were supplied with programmable electric lighting, automated electric heating and forced ventilation. The environmental temperature was set at 32 °C on arrival day and gradually reduced to 19 °C by 41 days post hatch. The birds received drinking water and were fed *ad libitum*. Nutritional and product safety analysis were assessed before the arrival of animals in the Poultry Quality and Animal Feed Centre of the Valencia Region (CECAV, in its Spanish acronym, *Centro de Calidad Avícola y Alimentación Animal de la Comunidad Valenciana*, Castellón, Spain). Two different age commercial diets were offered to the animals: from arrival until 21 days post hatch, chicks were fed a pelleted starter diet, and from 21 days old to the slaughter day a pelleted grower diet was offered to animals. The diets for each management system were formulated to meet each breed metabolic requirements and to provide equal nutrient profiles (Santomá and Mateos, 2018). The starter diet was the same for both breeds (Camperbroiler iniciación, Alimentación Animal Nanta, Valencia, Spain), while the grower feed was the standard diet specific for each one: A-32 broiler and A-80 Pollos crecimiento (Alimentación Animal Nanta, Valencia, Spain) for fast-growing and slow-growing breed, respectively. Nutritional composition of the diets has been detailed in Table 1. Only one batch of feed per age (starter and grower) was manufactured. Moreover, no coccidiostats or antimicrobials were added to either diet, and high biosecurity levels were maintained in the experimental poultry house during the rearing. Mortality rates and diarrhoea presence were recorded daily. Finally, animals were weighed at weekly intervals and feed consumption per pen was recorded.

Table 1. Composition of starter and grower diets for FG and SG breeds.

Analytical constituents	Diet		
	Starter (%)	Grower FG (%)	Grower SG (%)
Crude fat	3.5	3.1	3.8
Crude protein	20.5	19.4	18.0
Crude fibre	2.6	3.1	3.2
Crude ash	6.6	5.0	5.5
Lysine	1.14	1.13	0.94
Methionine	0.62	0.51	0.40
Calcium	1.00	0.78	1.00
Phosphorus	0.69	0.51	0.43
Sodium	0.15	0.14	0.17
Ingredients	Corn, soy flour, wheat, soy oil, calcium carbonate, monocalcium phosphate, sodium chloride	Corn, soy flour, rice bran, calcium carbonate, sodium chloride	Wheat, soy flour, barley, soy oil, calcium carbonate, monocalcium phosphate, sodium chloride, sodium bicarbonate

Starter (%): percentage of analytical constituents for starter diet, Grower FG (%): percentage of analytical constituents for grower diet of fast-growing breed, Grower SG (%): percentage of analytical constituents for grower diet of slow-growing breed.

3.1.1.3.2 Sample collection

To assess the development of microbiota composition throughout the growing period, animals from each experimental group were randomly selected and caecal samples were collected at different times of the growing period: on arrival day (1day), at mid-period (21 days for both groups) and before slaughter (42 days of age in fast-growing, and 63 days in slow-growing). On arrival day, 30 animals per group (fast or slow-growing) were selected and sampled just before being assigned to the houses (n=30/group). Later, at mid-period, and before slaughter, caecal samples from 30 animals per group and house were collected again at each sampling moment (n=60/group/sampling moment). Caecal samples were taken individually and placed in sterile jars. The samples were processed immediately after collection (Figure 15).

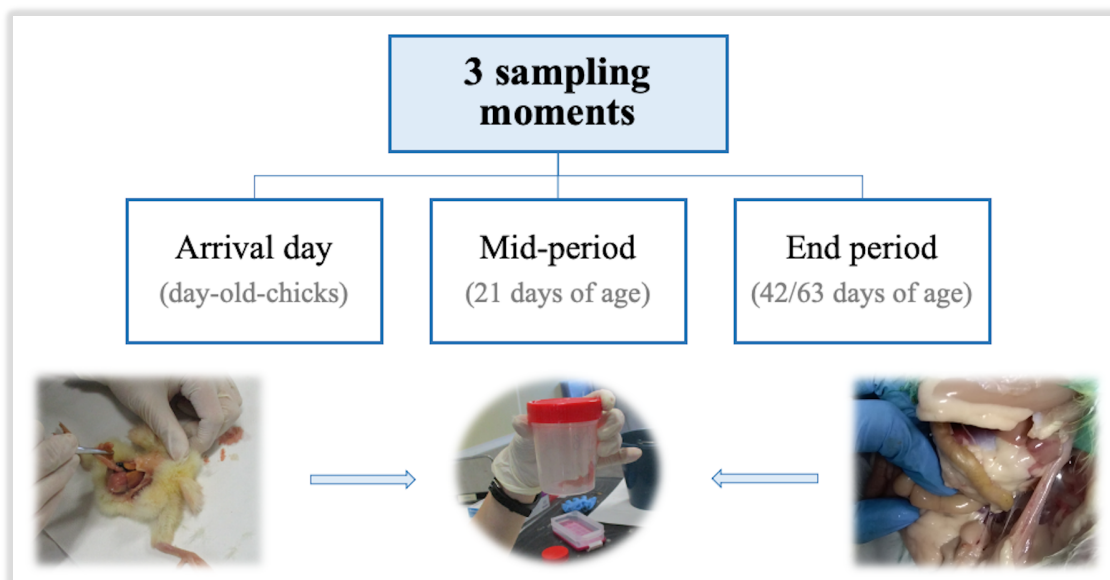

Figure 15. Sample collection scheme in experiment 1.

3.1.1.3.3 DNA extraction

Caecal content was removed and homogenised. On the first day of rearing, five pools of six animals from each experimental group were prepared (n=5/group). Then, for the mid- and end period, five pools of six animals from each group and house were made (n=10/group/sampling moment). DNA of pool content was extracted according to the manufacturer's instructions (QIAamp Power Fecal DNA kit, Werfen, Barcelona, Spain) and frozen at -80 °C for shipment to the Centre for Biomedical Research of La Rioja (CIBIR, in its Spanish acronym, Logroño, Spain).

3.1.1.3.4 16S rRNA sequencing analysis

First, all samples received were analysed in a Fragment Analyzer (Genomic DNA 50Kb kit, AATI) to ensure their integrity. Additionally, the initial DNA concentration was measured by means of a Qubit fluorometer (dsDNA HS Assay kit, Invitrogen). From 12.5 ng of DNA (evaluated in Qubit) of each sample, the library was prepared following the instructions of the 16S rRNA Metagenomic Sequencing Library Preparation (Illumina) protocol

(https://support.illumina.com/documents/documentation/chemistry_documentation/16s/16s-metagenomic-library-prep-guide-15044223-b.pdf). Primer sequences cover the V3-V4 regions of the 16S rRNA gene. The following primers also include the Illumina adapters:

16S Amplicon PCR Forward Primer = 5'

(TCGTCGGCAGCGTCAGATGTGTATAAGAGACAGCCTACGGGNGGCWGCAG) and 16S Amplicon PCR Reverse Primer = 5' (GTCTCGTGGGCTCGGAGATGTGTATAAGAGACAGGACTACHVGGGTATCTA ATCC). The sequencing run was performed in a MiSeq (Illumina) system in 2x300 bp format.

The quality of the raw unprocessed reads was evaluated using the FastQC software (<https://www.bioinformatics.babraham.ac.uk/projects/fastqc/>). After removal of adapters by Trim Galore (https://www.bioinformatics.babraham.ac.uk/projects/trim_galore/), the quality of clean reads was re-evaluated with FastQC. Then, because the fragments sequenced for each of the samples are overlapped in their central region, the V3-V4 region of the 16S rRNA gene was partially reconstructed into fragments of approximately 550-580bp. The Operational Taxonomic Unit (I) picking and analysis was performed with QIIME (v1.9.1) pipeline (Caporaso *et al.*, 2010), following the methodology 'pick open reference OTUs' against the taxonomy reference base Greengenes 13.8 at 97% nucleotide identity. Finally, InteractiVenn software was used for Venn diagram construction (Heberle *et al.*, 2015).

Calculation of the alpha diversity indexes was done by QIIME (v1.9.1), which generates multiple rarefactions on the I table at different sequencing depths, calculates the alpha diversity indexes at each depth, and finally coheres the data, generating rarefaction graphs for each index. To identify OTUs with differential abundance in this study, the analysis was performed using two tests: a non-parametric analysis (Kruskal-Wallis) and a parametric test (MetagenomeSeq). In both cases, analysis set out from the standardised and filtered table of OTUs to eliminate those OTUs that may be spurious. Analysis was carried out at three taxonomic levels: Phylum, Genera and OTU. Then, the alpha diversity indexes were statistically compared between groups of samples through the Python script 'compare_alpha_diversity.py' included in the QIIME v1.9.1 package. It performs a two-sample t-test by using by default, as in our case, a non-parametric (Monte Carlo) method and permutation value of 999. The t-test value and a *P*-value (Bonferroni correction) were obtained for each couple of defined groups. In this study, a rarefaction depth of 72 060 reads were selected for this analysis (Qiime, n.d.).

Beta diversity was evaluated based on indices or coefficients of similarity, dissimilarity or distance between the samples from qualitative (presence/absence of OTUs) or

quantitative (proportional abundance of each OTU) data. The OTU filtering and normalisation from the OTU table was performed using the QIIME v1.9.1 protocol. A threshold of 0.01% was applied, meaning that the OTU sequences with an abundance below the 0.01% are assigned as spurious sequences, and therefore removed from the analysis. The OTU table normalisation, applying the Cumulative Sum Scaling method through the MetagenomeSeq package was chosen as an alternative to the rarefaction one, according to previous studies (Paulson *et al.*, 2013; McMurdie and Holmes, 2014). In QIIME's metagenomics protocol, beta diversity was measured through a distance or dissimilarity matrix between each pair of samples. This matrix was visualised with Principal Coordinate Analysis (**PCoA**) graphs in 2D and 3D, which allow analysis of the distance between each pair of samples.

Moreover, to analyse the statistical significance of sample groupings by using beta diversity distance matrices, the 'compare_categories.py' Qiime v1.9.1 script was used. This script, which uses the R vegan and ape packages, allows analysis of the strength and statistical significance of sample groupings. Several methods are available, and two of them were selected for this study: ANOSIM and Adonis. Both methods were applied to the three different calculated matrices (Bray-Curtis, Unweighted Unifrac and Weighted Unifrac).

3.1.1.3.5 Data availability

Bioproject: PRJNA612272: Assessment of animal husbandry and environmental control as alternatives to antibiotics use in broiler and growing rabbit production. Effect on multi-resistances.

BioSample: SAMN14365530: Fast and slow-growing broiler breeds. Caecal microbiota characterisation.

3.1.1.4 Results

During this study, a total of 50 caecal pools (25 per experimental group) were collected, processed and sequenced. No clinical signs were observed during rearing, and the productive parameters obtained were in accordance with the breed standards (Table 2). There were no statistical differences between replicates (P -value>0.05).

Table 2. Weight of the animals (weight \pm s.d.) and conversion rate (CR \pm s.d.) during the productive cycle for FG and SG management systems.

Days of life	FG		SG	
	Weight (g)	CR	Weight	CR
0	47.20 \pm 0.98		41.31 \pm 1.24	
7	184.80 \pm 8.92	1.16 \pm 0.10	146.05 \pm 6.25	1.26 \pm 0.14
14	492.90 \pm 44.81	1.25 \pm 0.18	368.23 \pm 43.77	1.29 \pm 0.35
21	823.32 \pm 41.88	1.23 \pm 0.16	547.21 \pm 18.42	1.22 \pm 0.63
28	1503.41 \pm 77.66	1.30 \pm 0.15	936.98 \pm 31.20	1.34 \pm 0.44
35	2043.72 \pm 163.78	2.73 \pm 0.74	1283.64 \pm 93.16	2.70 \pm 0.83
42	2605.91 \pm 242.06	3.06 \pm 1.30	1631.83 \pm 105.98	3.29 \pm 1.07
49			2049.22 \pm 146.00	3.05 \pm 1.08
56			2439.40 \pm 183.25	3.17 \pm 1.76
63			2776.33 \pm 181.86	4.34 \pm 1.99

FG: Fast-growing breed, SG: Slow-growing breed, CR: conversion rate.

3.1.1.4.1 rRNA profiling of fast and slow-growing management systems

The MiSeq sequencing of the 50 samples produced a total of 14 143 246 sequencing reads with an average of 282 864.9 reads per sample. Quality and chimera filtering produced a total of 12 661 675 filtered reads with an average of 253 233.5 reads per sample and ranging from 109 447 to 356 331 reads.

Assessment of rarefaction curves based on the Chao1, Shannon, Simpson and Observed OTUs biodiversity indexes calculated for the six sequence read groups (day-old chicks, mid-period and slaughter day results for fast-growing and SG management systems) indicated that four of the curves tended to reach a plateau (Table S1, Table S2, Table S3 and Table S4). However, samples from groups 1 and 2 (day-old chicks from both groups) are at the limit of the rarefaction, leaving a rarefaction number of 72 060 reads (Figure 16).

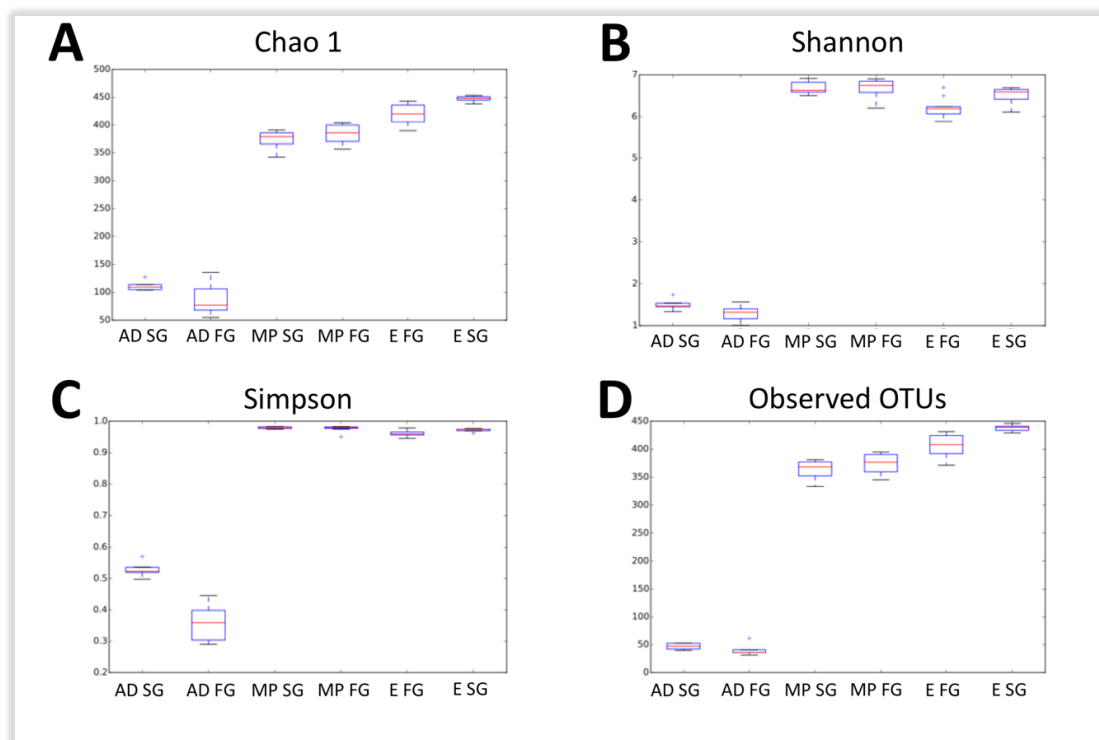

Figure 16. Evaluation of alpha diversity in fast and slow-growing management systems using different calculation measures. **A:** Chao 1. **B:** Shannon. **C:** Simpson. **D:** Observed OTUs. AD SG: Slow-growing breed at arrival day; AD FG: Fast-growing breed at arrival day; MP SG: Slow-growing breed at mid-period; MP FG: Fast-growing breed at mid-period; E FG: Fast-growing breed at the end of the growing period; E SG: Slow-growing breed at the end of the growing period.

The Chao1 alpha diversity index reveals a notable difference between the caecal microbiota depending on the moment of sampling (arrival, mid-, end period) (Table 3). For the fast-growing management system, statistically significant differences (P -value <0.05) were found between sampling moments. Samples from day-old chicks (88.3) displayed a lower level of complexity of the microbiota compared to that found at mid-period (384.4), and samples from mid-period animals displayed a lower level of complexity than the samples from the end of the growing period (420.3). Similarly, for the slow-growing management system, alpha diversity index increased throughout the growing period with statistically significant differences between sampling moments, with a result of 111.9, 373.8 and 447.2 on arrival day, at mid-period and at the end of the growing period, respectively.

Table 3. Alpha diversity according to management system (FG or SG) and sampling moment based on Chao 1 index.

Sampling moment	FG	SG
Arrival day	88.3 ^a	111.9 ^d
Mid-period	384.4 ^b	373.8 ^e
End period	420.3 ^c	447.2 ^f

FG: Fast-growing breed. SG: Slow-growing breed. ^{a,b,c}: Different superscripts within column FG indicate a significant difference within group ($P \leq 0.05$). ^{d,e,f}: Different superscripts within column SG indicate a significant difference within group ($P \leq 0.05$).

3.1.1.4.2 Differential gut microbiota composition

Inspection of predicted taxonomic profiles at phylum level for all samples based on MetagenomeSeq parametric test is summarised in Table 4. This analysis showed that *Firmicutes* represented the dominant phylum of the caecal community in both management systems at all sampling times in the production cycle (P -value <0.05). At the onset of the growing period, *Proteobacteria* was the second prevalent phylum for fast and slow-growing breeds, outnumbering the *Bacteroidetes* phylum. However, during the rest of the production cycle, *Bacteroidetes* phylum was more abundant than *Proteobacteria* in both groups.

For the fast-growing management system, there were statistically significant differences between the phyla prevalence and the time of sampling (arrival day, mid-period and end period). *Proteobacteria* and *Bacteroidetes* phyla were more abundant at the arrival day (36.4% and 5%, respectively). However, *Firmicutes* was the most prevalent phylum at mid-period (95.1%).

For the slow-growing management system, *Bacteroidetes* (5.7% at arrival day) and *Firmicutes* (95.2% at mid-period) showed the same pattern as in the fast-growing breed. However, statistically significant differences were shown between day-old chicks and the mid-period percentage of *Proteobacteria* (32.8% and 1.2%, respectively), which subsequently remained stable until the end of the cycle (1.7%).

Table 4. Taxonomic profiles at phylum level according to management system (FG or SG) and sampling moment based on MetagenomeSeq parametric test.

Breed	FG			SG		
	AD (%)	MP (%)	E (%)	AD (%)	MP (%)	E (%)
<i>Actinobacteria</i>	0.0	0.3	0.5	0.2	0.3	0.4
<i>Bacteroidetes</i>	5.0 ^a	1.9 ^b	5.7 ^c	5.7 ^l	1.9 ^m	9.3 ⁿ
<i>Cyanobacteria</i>	0.0 ^d	0.5 ^d	0.7 ^e	0.0	0.4	1.1
<i>Firmicutes</i>	58.6 ^f	95.1 ^g	90.3 ^h	61.1 ^o	95.2 ^p	85.6 ^q
<i>Proteobacteria</i>	36.4 ⁱ	1.3 ^j	1.5 ^k	32.8 ^r	1.2 ^s	1.7 ^s
<i>Tenericutes</i>	0.0	0.3	0.6	0.2	0.4	1.1
Unassigned;NA	0.0	0.6	0.8	0.0	0.6	0.8

FG: Fast-growing breed; SG: Slow-growing breed; AD (%): Percentage of different phyla at arrival day, MP (%): Percentage of different phyla at mid-period, E: Percentage of different phyla at the end of the growing period. ^{a-k}: Different superscripts indicate a significant difference within each phylum during rearing for fast-growing management system ($P \leq 0.05$). ^{l-s}: Different superscripts indicate a significant difference within each phylum during rearing for slow-growing management system ($P \leq 0.05$).

Furthermore, in this study 46 taxa were identified at genus level (Figure 17). Regardless of the management system and time point, the most predominant genera identified were *Oscillospira* spp. (7.5%), *Ruminococcus* spp. (3.6%), *Coprococcus* spp. (2.9%), *Lactobacillus* spp. (2.5%) and *Bacteroides* spp. (2.0%). In order to further identify microbiota composition for both breeds, we focused on 33 genera, which were shown to be present at an average relative abundance of more than 0.5% in at least one sample group (Mancabelli *et al.*, 2016).

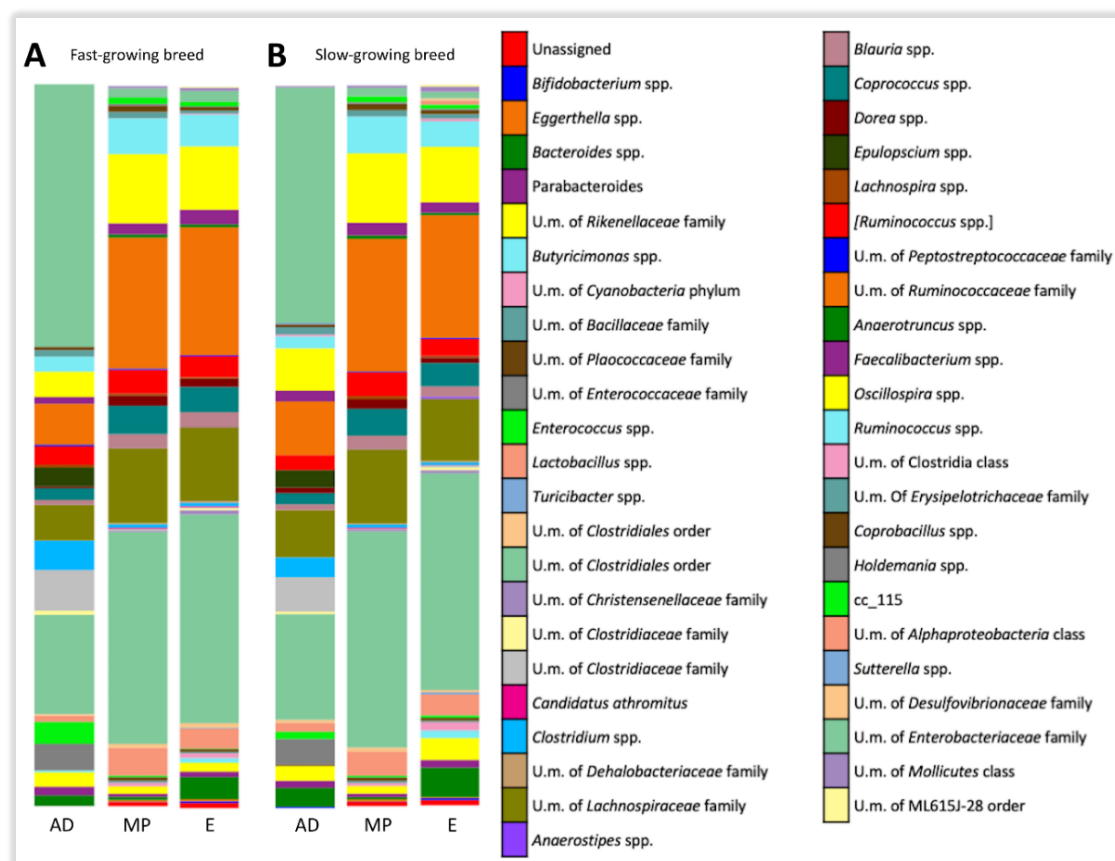

Figure 17. Taxonomic analysis at genus level throughout the growing period. A: Evolution of genera throughout the growing period for fast-growing management system (AD: Arrival day; MP: Mid-period; E: End). B: Evolution of genera throughout the growing period for slow-growing management system (AD: Arrival day, MP: Mid-period, E: end).

In addition, it is important to highlight that 75% (24/32), 93% (40/43) and 97.8% (45/46) are common genera for both experimental groups at the beginning, mid- and end period, respectively (the different genera are detailed in Table S5).

For the fast-growing management system, the results of the genera analysis are shown in Table 5. At arrival day, predominant bacteria of microbiota were Unclassified members (U. m.) of the *Enterobacteriaceae* family (36.4%), U. m. of *Clostridiaceae* family (6.2%), U. m. of the *Ruminococcaceae* family (5.7%), U. m. of *Lachnospiraceae* family (4.9%), *Clostridium* spp. (4.1%), U. m. of *Enterococcaceae* family (3.7%), *Oscillospira* spp. (3.5%) and *Enterococcus* spp. (3.0%). At mid-period, the predominant genera in caecal samples were U. m. of the *Ruminococcaceae* family (18.1%), U. m. of *Lachnospiraceae* family (10.4%), *Oscillospira* spp. (9.6%), *Coprococcus* spp. (4.0%), *Lactobacillus* spp. (3.9%) and *[Ruminococcus]* spp. (3.3%). Finally, at the end of the growing period, the most prevalent bacteria were U. m. of the *Ruminococcaceae* family (17.7%), U. m. of

Lachnospiraceae family (10.2%), *Oscillospira* spp. (8.8%), *Coprococcus* spp. (3.5%) and *Bacteroides* spp. (3.1%).

For the slow-growing management system, the results of the genera analysis are shown in Table 6. The pattern for day-old chicks was similar to that observed at this sampling time for the fast-growing group. The most abundant bacteria were U. m. of the *Enterobacteriaceae* family (32.6%), U. m. of the *Ruminococcaceae* family (7.5%), U. m. of *Lachnospiraceae* family (6.5%), *Oscillospira* spp. (5.8%), U. m. of *Clostridiaceae* family (4.8%) and U. m. of *Enterococcaceae* family (3.6%). At mid-period, predominant genera were U. m. of the *Ruminococcaceae* family (18.4%), U. m. of *Lachnospiraceae* family (10.3%), *Oscillospira* spp. (9.6%), *Coprococcus* spp. (3.8%), *Lactobacillus* spp. (3.4%) and [*Ruminococcus*] spp. (3.3%). Lastly, at slaughter day, U. m. of the *Ruminococcaceae* family (17.0%) were the most abundant bacteria, followed by U. m. of *Lachnospiraceae* family (8.6%), *Oscillospira* spp. (7.7%), *Coprococcus* spp. (3.2%), *Bacteroides* spp. (4.1%) and *Parabacteroides* spp. (3.1%).

Table 5. Taxonomic profiles at genus level according to sampling moment in FG management system.

Phylum	Family	Genus	AD (%)	MP (%)	E (%)
	Unassigned		0.0	0.6	0.8
<i>Bacteroidetes</i>	<i>Bacteroidaceae</i>	<i>Bacteroides</i>	1.5	0.5	3.1
	<i>Porphyromonadaceae</i>	<i>Parabacteroides</i>	1.2	0.4	0.7
	<i>Rikenellaceae</i>	-	2.0	1.1	1.2
	<i>Odoribacteraceae</i>	<i>Butyricimonas</i>	0.3	0.0	0.7
<i>Cyanobacteria</i>	-	-	0.0	0.5	0.7
<i>Firmicutes</i>	<i>Planococcaceae</i>	-	0.0	0.5	0.4
	<i>Enterococcaceae</i>	-	3.7	0.0	0.0
		<i>Enterococcus</i>	3.0	0.2	0.1
	<i>Lactobacillaceae</i>	<i>Lactobacillus</i>	0.9	3.9	2.8
	-	-	0.2	0.5	0.6
	-	-	13.7	29.4	28.9
	<i>Christensenellaceae</i>	-	0.0	0.2	0.6
		-	0.6	0.0	0.3
	<i>Clostridiaceae</i>	-	5.6	0.2	0.2
		<i>Clostridium</i>	4.1	0.5	0.5
		-	4.9	10.4	10.2
		<i>Blauria</i>	0.7	2.0	2.1
		<i>Coprococcus</i>	1.6	4.0	3.5
	<i>Lachnospiraceae</i>	<i>Dorea</i>	0.2	1.4	1.1
		<i>Epulopsium</i>	2.6	0.0	0.0
		<i>[Ruminococcus]</i>	2.5	3.3	2.9
		-	5.7	18.1	17.7
	<i>Anaerotruncus</i>	0.0	0.5	0.4	
<i>Ruminococcaceae</i>	<i>Faecalibacterium</i>	0.9	1.5	2.0	
	<i>Oscillospira</i>	3.5	9.6	8.8	
	<i>Ruminococcus</i>	2.1	5.0	4.4	
	-	0.9	0.9	0.4	
<i>Erysipelotrichaceae</i>	<i>Coprobacillus</i>	0.4	0.9	0.5	
	cc_115	0.0	0.9	0.6	
<i>Proteobacteria</i>	<i>Enterobacteriaceae</i>	-	36.4	1.3	1.5

FG: Fast-growing breed, AD (%): percentage of different genera at arrival day, MP: percentage of different genera at mid-period, E: percentage of different genera at end the end of the growing period.

Table 6. Taxonomic profiles at genus level according to the sampling moment in SG management system.

Phylum	Family	Genus	AD (%)	MP (%)	E (%)	
	Unassigned		0.0	0.6	0.8	
<i>Bacteroidetes</i>	<i>Bacteroidaceae</i>	<i>Bacteroides</i>	2.6	0.4	4.1	
	<i>Porphyromonadaceae</i>	<i>Parabacteroides</i>	1.0	0.5	1.1	
	<i>Rikenellaceae</i>	-	2.0	1.1	3.1	
	<i>Odoribacteraceae</i>	<i>Butyricimonas</i>	0.0	0.0	1.1	
<i>Cyanobacteria</i>			0.0	0.4	1.1	
<i>Firmicutes</i>	<i>Planococcaceae</i>	-	0.2	0.5	0.4	
	<i>Enterococcaceae</i>	-	3.6	0.0	0.0	
		<i>Enterococcus</i>	1.0	0.2	0.4	
	<i>Lactobacillaceae</i>	<i>Lactobacillus</i>	1.2	3.4	2.9	
	-	-	0.4	0.6	0.3	
	-	-	14.6	29.9	30.0	
	<i>Clostridiaceae</i>	-	4.8	0.2	0.3	
		<i>Clostridium</i>	2.7	0.4	0.4	
	<i>Lachnospiraceae</i>	-	6.5	10.3	8.6	
		<i>Blauria</i>	0.8	1.8	1.5	
		<i>Coprococcus</i>	1.6	3.8	3.2	
		<i>Dorea</i>	0.8	1.3	0.7	
		<i>Epulopscium</i>	2.4	0.0	0.0	
		<i>Ruminococcus</i>	2.1	3.3	2.3	
		-	7.5	18.4	17.0	
		<i>Anaerotruncus</i>	0.0	0.5	0.3	
		<i>Ruminococcaceae</i>	<i>Faecalibacterium</i>	1.5	1.8	1.5
			<i>Oscillospira</i>	5.8	9.6	7.7
	<i>Ruminococcus</i>		1.7	5.1	3.6	
	-	1.0	0.9	0.6		
<i>Erysipelotrichaceae</i>	<i>Coprobacillus</i>	0.4	0.9	0.5		
	cc_115	0.0	0.8	0.6		
<i>Proteobacteria</i>	<i>Enterobacteriaceae</i>	-	32.6	1.2	0.9	
<i>Tenericutes</i>	-	-	0.2	0.4	0.7	

SG: Slow-growing breed, AD (%): percentage of different genera at arrival day, MP: percentage of different genera at mid-period, E: percentage of different genera at end the end of the growing period.

Finally, to assess differences in microbiota between sampling moments, beta diversity was analysed based on Bray-Curtis dissimilarity, Weighted UniFrac and Unweighted UniFrac indexes for these groups, after which the UniFrac distance matrix was represented through PCoA. The R^2 values obtained depending on the statistical test used were: Bray-Curtis $R^2 = 0.85$, Unweighted UniFrac $R^2 = 0.73$ and Weighted UniFrac $R^2 = 0.89$ (these data are detailed in Table S6). These results support that microbiota diversity is significantly affected by the age of animals for both management systems (P -value = 0.001) (Figure 18). There is a notable difference between day-old chicks and the rest of the sampling moments for each group. However, mid-period and end sampling moments are also separated in PCoA graphics, indicating that microbiota diversity continued to increase, although to a lesser extent, until the end of the growing period.

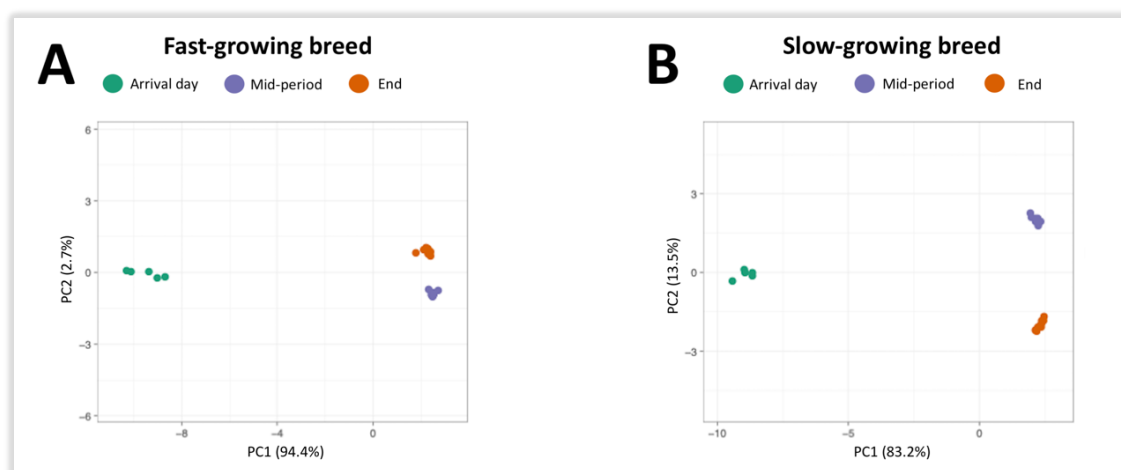

Figure 18. Evaluation of the beta diversity based on Bray-Curtis dissimilarity between sampling moments (arrival day, mid-period and end of the rearing period) for each management system. **A:** Beta diversity represented by PCoA graphic for fast-growing management system. **B:** Beta diversity represented by PCoA graphic for slow-growing management system. PC1: Principal component 1, principal component 2.

3.1.1.5 Discussion

The present study assessed the caecal microbiota in two different management systems: fast-growing and slow-growing, with two different genetic broiler breeds, during their respective growing period. In fact, knowing the main microbiota composition during the growing period and how management practices could influence its modulation could help to take quick decisions at farm level (Wahlström *et al.*, 2016; Hasan and Yang, 2019). In this sense, it might be interesting to consider microbiota composition as a biomarker of poultry health and productive performance (Pandit *et al.*, 2018; Wang *et al.*, 2018; Carrasco *et al.*, 2019). It is well demonstrated that a greater complexity of the gut

microbiota is observed as animals grow (Lu *et al.*, 2003; Mohd Shaufi *et al.*, 2015; Ocejó *et al.*, 2019). Our findings showed that there is an important change in microbiota composition from animals' arrival to the mid-period, and a less pronounced variation has been observed from mid-period to the end of rearing. Microbiota becomes relatively stable at 21 days of rearing, coinciding with the gut maturation in broilers (Lu *et al.*, 2003; Mohd Shaufi *et al.*, 2015; Richards *et al.*, 2019; Xi *et al.*, 2019). Although some authors reported that bacterial diversity in the intestinal tract is higher in breeds with high feed efficiency (Stanley *et al.*, 2012; Carrasco *et al.*, 2019), however results of this study showed a similar microbiota diversity for both breeds through the production cycle (Schokker *et al.*, 2015; Richards *et al.*, 2019). This evidences the importance of flock management during the production cycle in terms of microbiota balance control (Qu *et al.*, 2008; Kers *et al.*, 2018; Carrasco *et al.*, 2019). It is important that any AB alternative introduced in farms, such as feed additives or management practices, should promote microbiota development of phyla related to gut health and productive performance.

Regarding gut microbiota composition, the predominant phyla obtained in this study for both management systems were *Firmicutes* and *Bacteroidetes*, followed by *Proteobacteria* (Wei *et al.*, 2013; Mohd Shaufi *et al.*, 2015; Carrasco *et al.*, 2019; Xi *et al.*, 2019). Colonisation of the gastrointestinal tract starts at the time of hatching (Stanley *et al.*, 2014; Carrasco *et al.*, 2019; Rychlik, 2020). At first days of age, it becomes successively colonised by *Proteobacteria*, specially by *Enterobacteriaceae* family, and by *Firmicutes* (Kers *et al.*, 2018). Afterwards, *Firmicutes* dominate the caecal population, followed by *Bacteroidetes* (Wei *et al.*, 2013; Ballou *et al.*, 2016). *Firmicutes*, constitutes a heterogeneous phylum containing bacterial groups with different metabolic activities, and several studies have shown that a high level of this phylum is correlated with good intestinal health (Ducatelle *et al.*, 2018; Yacoubi *et al.*, 2018). *Bacteroidetes* phylum is stable through the growing period for both systems, playing an important role in converting fermentable starch to simple sugars and these, in turn, to volatile fatty acids to meet the energy demand of the host, so their presence could be particularly affected by diet components (Lu *et al.*, 2003; Kumar *et al.*, 2018; Rychlik, 2020). At the onset of rearing, *Proteobacteria* are also found in a high concentration for both groups. An increment of this phylum is associated with dysbiosis and, consequently, with an increase in the presence of zoonotic bacteria belonging to this phylum, such as *Salmonella* or *Campylobacter*. For this reason, it is important to ensure strict management practices at

the start of the growing period, as any stress could produce an increment of this phylum, and could result in a higher shedding of pathogenic bacteria and environmental contamination throughout rearing (Neal-McKinney *et al.*, 2012; Shin *et al.*, 2015; Ducatelle *et al.*, 2018; Carrasco *et al.*, 2019). It is an important concern for poultry sector to maintain these bacteria under control from the beginning to the end of rearing, the last step before loading, transport and processing of chickens at the slaughterhouse. Nowadays, *Campylobacter* and *Salmonella* are still the two most important causes of zoonotic diseases in Europe, and poultry products are the main source of human infection (EFSA and ECDC, 2019).

At genus level, it is important to highlight that 75%, 93% and 97.8% are common to both management systems, at the beginning, mid- and end period, respectively. These results could mean that despite the management practices in the field, the microbiota could have similar development for both broiler production systems (Zhao *et al.*, 2013; Richards *et al.*, 2019). Moreover, although there exist some variations at genus level, results obtained in terms of microbiota composition are broadly similar for both management systems. According to other authors, slight changes in microbiota composition have not always entailed a performance consequence (Torok *et al.*, 2011; Schokker *et al.*, 2015).

The most predominant genera were *Oscillospira* spp., *Ruminococcus* spp., *Coproccoccus* spp., *Lactobacillus* spp. and *Bacteroides* spp., in line with data reported by other authors (Wei *et al.*, 2013; Hasan and Yang, 2019; Xi *et al.*, 2019). These genera are associated with higher production rates, so it might be said that high levels of these genera are indicators of adequate intestinal health in poultry (Mohd Shaufi *et al.*, 2015; Banerjee *et al.*, 2018; Clavijo and Flórez, 2018; Hasan and Yang, 2019). Among these, *Ruminococcus* spp. is known for its ability to degrade complex carbohydrates and thus may have contributed to an improved degradation of dietary fibre (Flint *et al.*, 2012; Siegerstetter *et al.*, 2017). Moreover, *Lactobacillus* spp. is an important probiotic in promoting healthy gut, as these bacteria are believed to be responsible for starch decomposition and lactate fermentation (Mohd Shaufi *et al.*, 2015; Clavijo and Flórez, 2018; Hasan and Yang, 2019; Rychlik, 2020). In turn, *Bacteroidetes* spp. plays an important role in breaking down complex molecules to simpler compounds which are also essential for growth of the host and gut microbiota development (Flint *et al.*, 2012; Rychlik, 2020). In this aspect, feed has a vital influence on genus development (Zhu *et al.*, 2002; Ducatelle *et al.*, 2018;

Yadav and Jha, 2019; Jha *et al.*, 2019). In this study, fast-growing birds were fed a corn-based diet and slow-growing birds were fed a wheat-based one. Different studies support that diets based on barley or wheat instead of corn-based ones increased the prevalence of *Lactobacillus* spp. at caeca level (Rodríguez *et al.*, 2012; Yadav and Jha, 2019; Paraskeuas and Mountzouris, 2019), but these diets also could favour the proliferation of *Clostridium perfringens* and predispose young chicks to necrotic enteritis (Pan and Yu, 2014; Chen *et al.*, 2015; Jha *et al.*, 2019). Nevertheless, corn- or soy-based diets could be deficient in available phosphorus and supplementation is often necessary (Fernandes *et al.*, 1999). Therefore, the most important aspect of diet management is to meet metabolic requirements of animals by using a balanced diet formulation (Santomá and Mateos, 2018; Jha *et al.*, 2019). The application at field level of management techniques that produce the correct balance of any group of microorganisms that benefit intestinal health could result in animal health and productivity. Likewise, management techniques that favour the development of undesirable bacterial groups always need to be discarded.

In short, there are numerous factors that influence on microbiota composition development, and all of them should be valued globally *in situ*, under its specific production characteristics (Kers *et al.*, 2018). Therefore, developing molecular techniques that can be applied in the field to measure the balance of the microbiota in each specific case could help us assess the impact of different management techniques on day-to-day work, and could be a promising line of research for our sector.

3.1.1.6 Conclusion

In conclusion, fast and slow-growing broiler microbiota is in constant development throughout rearing, being relatively stable at 21 days of age. *Firmicutes* and *Proteobacteria* are the most abundant phyla at the onset of the production cycle. However, while the *Firmicutes* increased their concentration for the two management systems throughout the growing period, the *Proteobacteria* decreased until the end of the cycle. Regarding the genus, it should be noted that the three most abundant groups for both systems, *Ruminococcus* spp., *Lactobacillus* spp. and *Bacteroides* spp., are related to better productive performance and intestinal health.

3.1.1.7 References

Alagawany, M., M. E. Abd El-Hack, M. R. Farag, S. Sachan, K. Karthik, and K. Dhama. 2018. The use of probiotics as eco-friendly alternatives for antibiotics in poultry nutrition. *Environ. Sci. Pollut. Res.* 25:10611–10618.

Alós J. 2015. Resistencia bacteriana a los antibióticos: una crisis global. *Enferm. Infecc. Microbiol. Clin.* 33:692–699.

Ballou, A. L., R. A. Ali, M. A. Mendoza, J. C. Ellis, H. M. Hassan, W. J. Croom, and M. D. Koci. 2016. Development of the chick microbiome: How early exposure influences future microbial diversity. *Front. Vet. Sci.* 3.

Banerjee, S., A. Sar, A. Misra, S. Pal, A. Chakraborty, and B. Dam. 2018. Increased productivity in poultry birds by sub-lethal dose of antibiotics is arbitrated by selective enrichment of gut microbiota, particularly short-chain fatty acid producers. *Microbiol. (United Kingdom)* 164:142–153.

BOE (Boletín Oficial del Estado). Spain. Royal Degree 53/2013, 1st of February 2013, por el que se establecen las normas básicas aplicables para la protección de los animales utilizados en experimentación y otros fines científicos, incluyendo la docencia. Available at https://www.boe.es/diario_boe/txt.php?id=BOE-A-2013-1337.

Brisbin, J. T., J. Gong, and S. Sharif. 2008. Interactions between commensal bacteria and the gut-associated immune system of the chicken. *Anim. Health Res. Rev.* 9:101–110.

Caporaso, J. G., J. Kuczynski, J. Stombaugh, K. Bittinger, F. D. Bushman, E. K. Costello, N. Fierer, A. G. Peña, J. K. Goodrich, J. I. Gordon, G. A. Huttley, S. T. Kelley, D. Knights, J. E. Koenig, R. E. Ley, C. A. Lozupone, D. McDonald, B. D. Muegge, M. Pirrung, J. Reeder, J. R. Sevinsky, P. J. Turnbaugh, W. A. Walters, J. Widmann, T. Yatsunenko, J. Zaneveld, and R. Knight. 2010. QIIME allows analysis of high-throughput community sequencing data. *Nat. Methods* 7:335–336.

Carrasco, J. M. D., N. A. Casanova, and M. E. F. Miyakawa. 2019. Microbiota, gut health and chicken productivity: What is the connection? *Microorganisms* 7:1–15.

Castellini, C. and A. Dal Bosco. 2017. Poultry Quality Evaluation: Quality Attributes and Consumer Values. Pages 335-357 in *Animal Welfare and Poultry Meat in Alternative Production Systems (and Ethics of Poultry Meat Production)*. Woodhead Publishing Series in Food Science, Technology and Nutrition, Elsevier Ltd. 2017.

Chen, J., G. Tellez, J. D. Richards, and J. Escobar. 2015. Identification of potential biomarkers for gut barrier failure in broiler chickens. *Front. Vet. Sci.* 2.

Cheng, G., H. Hao, S. Xie, X. Wang, M. Dai, L. Huang, and Z. Yuan. 2014. Antibiotic alternatives: The substitution of antibiotics in animal husbandry? *Front. Microbiol.* 5:1–15.

Clavijo, V., and M. J. V. Flórez. 2018. The gastrointestinal microbiome and its association with the control of pathogens in broiler chicken production: A review. *Poult. Sci.* 97:1006–1021.

Ducatelle, R., E. Goossens, F. De Meyer, V. Eeckhaut, G. Antonissen, F. Haesebrouck, and F. Van Immerseel. 2018. Biomarkers for monitoring intestinal health in poultry: Present status and future perspectives. *Vet. Res.* 49:1–9.

EFSA and ECDC (European Food Safety Authority and European Centre for Disease Prevention and Control). 2019. The European Union One Health 2018 Zoonoses Report. *EFSA J.* 17:5926.

Ellerbroek, L. I., J. A. Lienau, and G. Klein. 2010. *Campylobacter* spp. in broiler flocks at farm level and the potential for cross-contamination during slaughter. *Zoonoses Public Health* 57.

Fernandes, J. I. M., F. R. Lima, C. X. Mendonça, I. Mabe, R. Albuquerque, and P. M. Leal. 1999. Relative bioavailability of phosphorus in feed and agricultural phosphates for poultry. *Poult. Sci.* 78:1729–1736.

Flint, H. J., K. P. Scott, S. H. Duncan, P. Louis, and E. Forano. 2012. Microbial degradation of complex carbohydrates in the gut. *Gut Microbes* 3.

Gadde, U., W. H. Kim, S. T. Oh, and H. S. Lillehoj. 2017. Alternatives to antibiotics for maximizing growth performance and feed efficiency in poultry: a review. *Anim. Heal. Res. Rev.* 18:26–45.

Hancock, R. E. W., A. Nijnik, and D. J. Philpott. 2012. For bacterial infections. *Nat. Publ. Gr.* 10:243–254 Available at <http://dx.doi.org/10.1038/nrmicro2745>.

Hasan, N., and H. Yang. 2019. Factors affecting the composition of the gut microbiota, and its modulation. *PeerJ* 8:1–31.

Heberle, H., V. G. Meirelles, F. R. da Silva, G. P. Telles, and R. Minghim. 2015. InteractiVenn: A web-based tool for the analysis of sets through Venn diagrams. *BMC Bioinformatics* 16.

Jha, R., A. K. Singh, S. Yadav, J. F. D. Berrocoso, and B. Mishra. 2019. Early Nutrition Programming (in ovo and Post-hatch Feeding) as a Strategy to Modulate Gut Health of Poultry. *Front. Vet. Sci.* 6.

Kers, J. G., F. C. Velkers, E. A. J. Fischer, G. D. A. Hermes, J. A. Stegeman, and H. Smidt. 2018. Host and environmental factors affecting the intestinal microbiota in chickens. *Front. Microbiol.* 9:1–14.

Kogut, M. H. 2019. The effect of microbiome modulation on the intestinal health of poultry. *Anim. Feed Sci. Technol.* 250:32–40.

Kogut, M. H., X. Yin, J. Yuan, and L. Broom. 2017. Gut health in poultry. *CAB Rev. Perspect. Agric. Vet. Sci. Nutr. Nat. Resour.* 12.

Kumar, S., C. Chen, N. Indugu, G. O. Werlang, M. Singh, W. K. Kim, and H. Thippareddi. 2018. Effect of antibiotic withdrawal in feed on chicken gut microbial dynamics, immunity, growth performance and prevalence of foodborne pathogens. *PloS One* 13:1–23.

Lu, J., U. Idris, B. Harmon, C. Hofacre, J. J. Maurer, and M. D. Lee. 2003. Diversity and Succession of the Intestinal Bacterial Community of the Maturing Broiler Chicken. *Appl. Environ. Microbiol.* 69:6816–6824.

- Mancabelli, L., C. Ferrario, C. Milani, M. Mangifesta, F. Turrone, S. Duranti, G. A. Lugli, A. Viappiani, M. C. Ossiprandi, D. Van Sinderen, and M. Ventura. 2016. Insights into the biodiversity of the gut microbiota of broiler chickens. *Environ. Microbiol.* 18:4727–4738.
- McMurdie, P. J., and S. Holmes. 2014. Waste Not, Want Not: Why Rarefying Microbiome Data Is Inadmissible. *PloS Comput. Biol.* 10.
- Mohd Shaufi, M. A., C. C. Sieo, C. W. Chong, H. M. Gan, and Y. W. Ho. 2015. Deciphering chicken gut microbial dynamics based on high-throughput 16S rRNA metagenomics analyses. *Gut Pathog.* 7:1–12.
- Montoro-Dasi, L., A. Villagra, S. Sevilla-Navarro, M. T. Pérez-Gracia, S. Vega, and C. Marin. 2020. The dynamic of antibiotic resistance in commensal *Escherichia coli* throughout the growing period in broiler chickens: fast-growing vs. slow-growing breeds. *Poult. Sci.* 99:1591–1597.
- Neal-McKinney, J. M., X. Lu, T. Duong, C. L. Larson, D. R. Call, D. H. Shah, and M. E. Konkel. 2012. Production of Organic Acids by Probiotic Lactobacilli Can Be Used to Reduce Pathogen Load in Poultry. *PloS One* 7.
- Oakley, B. B., H. S. Lillehoj, M. H. Kogut, W. K. Kim, J. J. Maurer, A. Pedroso, M. D. Lee, S. R. Collett, T. J. Johnson, and N. A. Cox. 2014. The chicken gastrointestinal microbiome. *FEMS Microbiol. Lett.* 360:100–112.
- Oakley, B. B., C. A. Morales, J. Line, M. E. Berrang, R. J. Meinersmann, G. E. Tillman, M. G. Wise, G. R. Siragusa, K. L. Hiatt, and B. S. Seal. 2013. The Poultry-Associated Microbiome: Network Analysis and Farm-to-Fork Characterizations. *PloS One* 8.
- Ocejo, M., B. Oporto, and A. Hurtado. 2019. 16S rRNA amplicon sequencing characterization of caecal microbiome composition of broilers and free-range slow-growing chickens throughout their productive lifespan. *Sci. Rep.* 9:1–14.
- Pan, D., and Z. Yu. 2014. Intestinal microbiome of poultry and its interaction with host and diet. *Gut Microbes* 5:108–119.

Pandit, R. J., A. T. Hinsu, N. V. Patel, P. G. Koringa, S. J. Jakhesara, J. R. Thakkar, T. M. Shah, G. Limon, A. Psifidi, J. Guitian, D. A. Hume, F. M. Tomley, D. N. Rank, M. Raman, K. G. Tirumurugaan, D. P. Blake, and C. G. Joshi. 2018. Microbial diversity and community composition of caecal microbiota in commercial and indigenous Indian chickens determined using 16s rDNA amplicon sequencing. *Microbiome* 6:1–13.

Paraskeuas, V., and K. C. Mountzouris. 2019. Broiler gut microbiota and expressions of gut barrier genes affected by cereal type and phytogetic inclusion. *Anim. Nutr.* 5:22–31.

Paulson, J. N., O. Colin Stine, H. C. Bravo, and M. Pop. 2013. Differential abundance analysis for microbial marker-gene surveys. *Nat. Methods* 10:1200–1202.

Pedroso, A. A., J. F. M. Menten, and M. R. Lambais. 2005. The Structure of Bacterial Community in the Intestines of Newly Hatched Chicks. *J. Appl. Poult. Res.* 14:232–237.

Polycarpo, G. V., I. Andretta, M. Kipper, J. C. Dadalt, P. H. M. Rodrigues, and R. Albuquerque. 2017. Meta-analytic study of organic acids as an alternative performance-enhancing feed additive to antibiotics for broiler chickens. *Poult. Sci.* 96:3645–3653.

Pourabedin, M., and X. Zhao. 2015. Prebiotics and gut microbiota in chickens. *FEMS Microbiol. Lett.* 362:1–8.

Qiime (Quantitative Insights Into Microbial Ecology). `Compare_alpha_diversity.py` – This script compares alpha diversities based on a two-sample t-test using either parametric or non-parametric (Monte Carlo) methods. Available at http://qiime.org/scripts/compare_alpha_diversity.html (verified 18 June 2020).

Qu, A., J. M. Brulc, M. K. Wilson, B. F. Law, J. R. Theoret, L. A. Joens, M. E. Konkel, F. Angly, E. A. Dinsdale, R. A. Edwards, K. E. Nelson, and B. A. White. 2008. Comparative metagenomics reveals host specific metavirulomes and horizontal gene transfer elements in the chicken cecum microbiome. *PloS One* 3.

Rasschaert, G., K. Houf, C. Godard, C. Wildemauwe, M. Pastuszczak-Frąk, and L. De Zutter. 2008. Contamination of carcasses with *Salmonella* during poultry slaughter. *J. Food Prot.* 71:146–152.

Richards, P., J. Fothergill, M. Bernardeau, and P. Wigley. 2019. Development of the caecal microbiota in three broiler breeds. *Front. Vet. Sci.* 6.

Rodríguez, M. L., A. Rebolé, S. Velasco, L. T. Ortiz, J. Treviño, and C. Alzueta. 2012. Wheat- and barley-based diets with or without additives influence broiler chicken performance, nutrient digestibility and intestinal microflora. *J. Sci. Food Agric.* 92:184–190.

Ross. 2019. Ross 308/Ross 308 FF broiler: Performance objectives. Available at http://es.aviagen.com/assets/Tech_Center/Ross_Broiler/Ross308-308FF-BroilerPO2019-EN.pdf (verified 17 June 2020).

Rychlik, I. 2020. Composition and function of chicken gut microbiota. *Animals* 10.

Santomá, G.; Mateos, G.G. *Necesidades Nutricionales para Avicultura: Normas FEDNA*; 2nd ed.; FEDNA (Fundación Española Desarrollo Nutrición Animal).; ISBN 9788409065295.

Schokker, D., G. Veninga, S. A. Vastenhouw, A. Bossers, F. M. de Bree, L. M. T. E. Kaal-Lansbergen, J. M. J. Rebel, and M. A. Smits. 2015. Early life microbial colonization of the gut and intestinal development differ between genetically divergent broiler lines. *BMC Genomics* 16.

Sekirov, I., S. L. Russell, L. Caetano M Antunes, and B. B. Finlay. 2010. Gut microbiota in health and disease. *Physiol. Rev.* 90:859–904.

Sender, R., S. Fuchs, and R. Milo. 2016. Revised Estimates for the Number of Human and Bacteria Cells in the Body. *PloS Biol.* 14.

Sevilla-Navarro, S., C. Marin, V. Cortés, C. García, and P. Catalá-Gregori. 2020. *Campylobacter* prevalence and risk factors associated with exceeding allowable limits in poultry slaughterhouses in Spain. *Vet. Rec.* 186.

Sevilla-Navarro, S., C. Marín, V. Cortés, C. García, S. Vega, and P. Catalá-Gregori. 2018. Autophagy as a control measure for *Salmonella* in laying hens. *Poult. Sci.* 97:4367–4373.

Shang, Y., S. Kumar, B. Oakley, and W. K. Kim. 2018. Chicken gut microbiota: Importance and detection technology. *Front. Vet. Sci.* 5.

Shin, N. R., T. W. Whon, and J. W. Bae. 2015. Proteobacteria: Microbial signature of dysbiosis in gut microbiota. *Trends Biotechnol.* 33:496–503.

Siegerstetter, S. C., S. Schmitz-Esser, E. Magowan, S. U. Wetzels, Q. Zebeli, P. G. Lawlor, N. E. O’Connell, and B. U. Metzler-Zebeli. 2017. Intestinal microbiota profiles associated with low and high residual feed intake in chickens across two geographical locations. *PloS One* 12:1–23.

Stanley, D., S. E. Denman, R. J. Hughes, M. S. Geier, T. M. Crowley, H. Chen, V. R. Haring, and R. J. Moore. 2012. Intestinal microbiota associated with differential feed conversion efficiency in chickens. *Appl. Microbiol. Biotechnol.* 96:1361–1369.

Stanley, D., R. J. Hughes, and R. J. Moore. 2014. Microbiota of the chicken gastrointestinal tract: Influence on health, productivity and disease. *Appl. Microbiol. Biotechnol.* 98:4301–4310.

Suresh, G., R. K. Das, S. K. Brar, T. Rouissi, A. Ramirez, Y. Chorfi, and S. Godbout. 2017. Critical Reviews in Microbiology Alternatives to antibiotics in poultry feed: molecular perspectives. *Crit. Rev. Microbiol.* 0:1–18.

Torok, V. A., R. J. Hughes, L. L. Mikkelsen, R. Perez-Maldonado, K. Balding, R. MacAlpine, N. J. Percy, and K. Ophel-Keller. 2011. Identification and characterization of potential performance-related gut microbiotas in broiler chickens across various feeding trials. *Appl. Environ. Microbiol.* 77:5868–5878.

Valls, M. 2017. Reproductoras y pollos de crecimiento lento como producto diferenciado. Available at <https://avicultura.info/reproductoras-y-pollos-de-crecimiento-lento/> (verified 17 June 2020).

Wahlström, A., S. I. Sayin, H. U. Marschall, and F. Bäckhed. 2016. Intestinal Crosstalk between Bile Acids and Microbiota and Its Impact on Host Metabolism. *Cell Metab.* 24:41–50.

Wang, J., L. T. Nesengani, Y. Gong, Y. Yang, and W. Lu. 2018. 16S rRNA gene sequencing reveals effects of photoperiod on cecal microbiota of broiler roosters. *PeerJ* 2.

Wei, S., M. Morrison, and Z. Yu. 2013. Bacterial census of poultry intestinal microbiome. *Poult. Sci.* 92:671–683.

WHO (World Health Organization). 2014. Antimicrobial resistance: global report on surveillance 2014. World Health Organization. Available at <https://www.who.int/drugresistance/documents/surveillancereport/en/>.

Xi, Y., N. Shuling, T. Kunyuan, Z. Qiuyang, D. Hewen, G. ChenCheng, Y. Tianhe, L. Liancheng, and F. Xin. 2019. Characteristics of the intestinal flora of specific pathogen free chickens with age. *Microb. Pathog.* 132:325–334.

Yacoubi, N., L. Saulnier, E. Bonnin, E. Devillard, V. Eeckhaut, L. Rhayat, R. Ducatelle, and F. Van Immerseel. 2018. Short-chain arabinoxylans prepared from enzymatically treated wheat grain exert prebiotic effects during the broiler starter period. *Poult. Sci.* 97:412–424.

Yadav, S., and R. Jha. 2019. Strategies to modulate the intestinal microbiota and their effects on nutrient utilization, performance, and health of poultry. *J. Anim. Sci. Biotechnol.* 10:1–11.

Zhao, L., G. Wang, P. Siegel, C. He, H. Wang, W. Zhao, Z. Zhai, F. Tian, J. Zhao, H. Zhang, Z. Sun, W. Chen, Y. Zhang, and H. Meng. 2013. Quantitative genetic background of the host influences gut microbiomes in chickens. *Sci. Rep.* 3.

Zhu, X. Y., T. Zhong, Y. Pandya, and R. D. Joerger. 2002. 16S rRNA-based analysis of microbiota from the cecum of broiler chickens. *Appl. Environ. Microbiol.* 68:124–137.

3.1.1.8 Supplementary material

- **Table S1.** Statistical comparison of alpha diversity between sample groups based on Chao 1 index.
- **Table S2.** Statistical comparison of alpha diversity between sample groups based on Shannon index.
- **Table S3.** Statistical comparison of alpha diversity between sample groups based on Simpson index.
- **Table S4.** Statistical comparison of alpha diversity between sample groups based on Observed OTUs index.
- **Table S5.** Different taxonomic profiles at genus level according to the moment of the growing period in fast (FG) and slow-growing (SG) breeds.
- **Table S6.** Statistical comparison between beta-diversity indexes calculated according the different methods.

Table S1. Statistical comparison of alpha diversity between sample groups based on Chao 1 index.

Group1	Group2	Group1 mean	Group1 std	Group2 mean	Group2 std	t stat	P-value
FGAD	FGMP	88.32	29.03	384.44	16.50	-23.41	1.11e-11
FGMP	FGE	384.42	16.50	420.31	17.86	-4.43	0.00
SGAD	SGMP	111.86	8.60	373.82	15.96	31.93	2.93e-13
SGMP	SGE	373.86	15.96	447.22	4.66	-13.24	1.69e-10

FGAD: fast-growing breed at arrival day; FGMP: fast-growing breed at mid-period; FGE: fast-growing breed at the end of the growing period; SGAD: slow-growing breed at arrival day; SGMP: slow-growing breed at mid-period; SGE: slow-growing breed at the end of the growing period.

Table S2. Statistical comparison of alpha diversity between sample groups based on Shannon index.

Group1	Group2	Group1 mean	Group1 std	Group2 mean	Group2 std	t stat	<i>P</i>-value
FGAD	FGMP	1.29e11	0.19	6.69e11	0.21	-4.55e11	2.53e04
FGMP	FGE	6.69e11	0.21	6.21e11	0.23	4.70e11	0.00
SGAD	SGMP	1.51e11	0.13	6.69e11	0.15	6.25e11	0.00
SGMP	SGE	6.69e11	0.15	6.52e11	0.18	2.16e11	0.06

FGAD: fast-growing breed at arrival day; FGMP: fast-growing breed at mid-period; FGE: fast-growing breed at the end of the growing period; SGAD: slow-growing breed at arrival day; SGMP: slow-growing breed at mid-period; SGE: slow-growing breed at the end of the growing period.

Table S3. Statistical comparison of alpha diversity between sample groups based on Simpson index.

Group1	Group2	Group1 mean	Group1 std	Group2 mean	Group2 std	t stat	P-value
FGAD	FGMP	0.36	0.06	0.98	0.01	-3.03e11	4.06e02
FGMP	FGE	0.98	0.01	0.96	0.01	3.87e11	0.00
SGAD	SGMP	0.53	0.02	0.98	0.00	5.48e11	1.67e04
SGMP	SGE	0.98	0.00	0.97	0.00	4.04e11	0.00

FGAD: fast-growing breed at arrival day; FGMP: fast-growing breed at mid-period; FGE: fast-growing breed at the end of the growing period; SGAD: slow-growing breed at arrival day; SGMP: slow-growing breed at mid-period; SGE: slow-growing breed at the end of the growing period.

Table S4. Statistical comparison of alpha diversity between sample groups based on Observed OTUs index.

Group1	Group2	Group1 mean	Group1 std	Group2 mean	Group2 std	t stat	P-value
FGAD	FGMP	41.18	1.05e10	374.46	1.72e10	-3.70e11	3.09e03
FGMP	FGE	374.46	1.72e10	407.56	1.93e11	-3.84e11	0.00
SGAD	SGMP	46.92	5.28e11	363.38	1.60e11	4.01e11	2.55e03
SGMP	SGE	363.38	1.60e11	437.72	5.55e10	-1.31e11	1.85e00

FGAD: fast-growing breed at arrival day; FGMP: fast-growing breed at mid-period; FGE: fast-growing breed at the end of the growing period; SGAD: slow-growing breed at arrival day; SGMP: slow-growing breed at mid-period; SGE: slow-growing breed at the end of the growing period.

Table S5. Different taxonomic profiles at genus level according to the moment of the growing period in fast (FG) and slow-growing (SG) breeds.

Sampling moment	Breed	Phylum	Class	Order	Family	Genus	Percentage	
Arrival day	FG	<i>Bacteroidetes</i>	<i>Bacteroidia</i>	<i>Bacteroidales</i>	<i>[Odoribacteraceae]</i>	<i>Butyricimonas</i>	0.27%	
		<i>Firmicutes</i>	<i>Clostridia</i>	<i>Clostridiales</i>	<i>Peptostreptococcaceae</i>		0.22%	
		<i>Firmicutes</i>	<i>Clostridia</i>	<i>Clostridiales</i>	<i>Lachnospiraceae</i>	<i>Lachnospira</i>	0.45%	
	SG		<i>Actinobacteria</i>	<i>Actinobacteria</i>	<i>Bifidobacteriales</i>	<i>Bifidobacteriaceae</i>	<i>Bifidobacterium</i>	0.20%
			<i>Firmicutes</i>	<i>Bacilli</i>	<i>Bacillales</i>	<i>Planococcaceae</i>	NA	0.20%
			<i>Firmicutes</i>	<i>Clostridia</i>	<i>SHA-98</i>	-	-	0.24%
			<i>Proteobacteria</i>	<i>Betaproteobacteria</i>	<i>Burkholderiales</i>	<i>Alcaligenaceae</i>	<i>Sutterella</i>	0.20%
		<i>Tenericutes</i>	<i>Mollicutes</i>	<i>RF39</i>	-	-	0.19%	
Mid-period	FG	<i>Firmicutes</i>	<i>Clostridia</i>	<i>SHA-98</i>	-	-	0.02%	
		<i>Proteobacteria</i>	<i>Betaproteobacteria</i>	<i>Burkholderiales</i>	<i>Alcaligenaceae</i>	<i>Sutterella</i>	0.01%	
	SG	<i>Proteobacteria</i>	<i>Alphaproteobacteria</i>	<i>RF32</i>	-	-	0.01%	
End	SG	<i>Firmicutes</i>	<i>Clostridia</i>	<i>Clostridiales</i>	<i>Lachnospiraceae</i>	<i>Epulopiscium</i>	0.01%	

Table S6. Statistical comparison between beta-diversity indexes calculated according the different methods.

Beta-diversity matrix	Adonis test			ANOSIM	
	F-stat	R²	P-value	Statistic value	P-value
Bray-Curtis	49.076	0.84795	0.001	0.79932682926829257	0.001
Unweighted-Unifrac	23.453	0.72716	0.001	0.70287804878048776	0.001
Weighted-Unifrac	69.523	0.88764	0.001	0.82837073170731712	0.001

3.1.2 The dynamic of antibiotic resistance in commensal *Escherichia coli* throughout the growing period in broiler chickens: fast-growing vs. slow-growing breeds

L. Montoro-Dasi, A. Villagra, S. Sevilla-Navarro, M.T. Pérez-Gracia, S. Vega, C. Marin. 2020. The dynamic of antibiotic resistance in commensal *Escherichia coli* throughout the growing period in broiler chickens: fast-growing vs. slow-growing breeds. *Poultry Science*; 99:1591-1597. doi: 10.1016/j.psj.2019.10.080.

3.1.2.1 Abstract

AMR is an important threat to public health worldwide. Furthermore, different studies have demonstrated a close association between AB use in animal production and AMR in humans. It is well known that it is necessary to reduce AB administration in farms by finding effective alternative treatments, using more resistant breeds and improving animal welfare. However, to be able to assess the alternatives proposed, it is essential to study the epidemiology of AMR under production conditions. Hence, the aim of this study was to investigate the AMR dynamic in two genetic poultry breeds during the growing period. The study was performed in two experimental poultry houses to simulate real production conditions and no ABs were administered during the growing period. In addition, two poultry breeds were used, fast-growing and slow-growing. To evaluate AMR evolution, *E. coli* was selected as indicator bacterium. To this end, animals from each experimental group were sampled at different times: on day of arrival, at mid-period and at slaughter day. In the laboratory, caecal content was removed and inoculated in selective media. Then, biochemical tests were performed to confirm *E. coli*. Finally, AB susceptibility was assessed according to Decision 652/2013. At the onset of the cycle, significant differences were observed between breeds, as the *E. coli* strains isolated from fast-growing day-old-chicks showed higher AMR rates. However, at the end of the period, no significant differences were found between breeds and their presence of resistant bacteria (above 95%). Therefore, although no ABs were administered during the growing period, a high level of AMR at slaughter day was demonstrated. Further studies are necessary to determine the main risk factors that increase the level of AMR throughout the productive cycle in broiler chickens. In conclusion, it is important to highlight that although it is crucial to control both AB use and animal welfare during the growing period, measures should be taken at all levels of the production chain.

3.1.2.2 Introduction

AMR has become a major threat for public health worldwide (WHO, 2014). One of the main factors contributing to the emergence of resistant bacteria has been the massive use of AMAs for growth promotion and disease prevention for several years in animal production (Guo *et al.*, 2018; Mehdi *et al.*, 2018). However, although nowadays the use of AB in poultry is a controlled practice (ESVAC, 2017), different studies demonstrated a close association between the AB use in animal production and AMR in humans (Marshall and Levy, 2011; Chang *et al.*, 2014; Founou *et al.*, 2016; Horigan *et al.*, 2016; Liu *et al.*, 2016; Sharma *et al.*, 2018) by the transfer of resistance from animal products to humans (Chantziaras *et al.*, 2013). As a result, commonly used ABs have become ineffective in the treatment of a wide variety of bacterial diseases (Khurana *et al.*, 2017; EFSA and ECDC, 2018). For this reason, society is pressing for a reduction in AB administration and greater efforts to find effective alternatives to control infectious diseases in farms (Alós, 2015; Gadde *et al.*, 2017).

Consequently, several classes of alternatives have been proposed and tested in poultry production, including probiotics, prebiotics, symbiotics, organic acids, enzymes, phytogenics, metals, antibacterial vaccines, immunomodulatory agents, antimicrobial peptides, bacteriophages and different broiler chicken growth systems (Hancock *et al.*, 2012; Cheng *et al.*, 2014; Castellini and Dal Bosco, 2017; Polycarpo *et al.*, 2017; Suresh *et al.*, 2018; Alagawany *et al.*, 2018; Sevilla-Navarro *et al.*, 2018).

In response to the social pressure to reduce AB administration and find effective alternatives to control the presence of bacterial infections in farms (Alós, 2015; Gadde *et al.*, 2017; Lusk, 2018a), the alternative poultry production system (organic, free-range) is founded on a different approach, keeping sustainability and animal welfare in consideration. Producers are therefore motivated to choose breeds selected for their ability to deal with the natural environment (Castellini and Dal Bosco, 2017).

However, to be able to assess the effectiveness of these alternatives it is necessary to have better knowledge of the epidemiology of AMR throughout the growing period under animal production conditions (Sirri *et al.*, 2011; Lusk, 2018b). For this purpose, commensal *E. coli* has typically been selected as AMR sentinel, as it provides valuable

data and constitutes a reservoir of resistance genes, which can spread horizontally to zoonotic and other bacteria (EFSA and ECDC, 2019).

Hence, the objective of this study was to investigate the AMR and MDR dynamic in two genetic poultry breeds, fast-growing and slow-growing, during the growing period, using commensal *E. coli* as sentinel bacterium.

3.1.2.3 Material and methods

In this experiment, all animals were handled according to the principles of animal care published by Spanish Royal Decree 53/2013 (BOE, 2013).

3.1.2.3.1 Experiment design

The study was performed in two poultry houses of an experimental poultry house in the CITA-IVIA, to simulate the real conditions of poultry production. Two commercial breeds were used, one fast-growing (Ross®) and the other slow-growing (Hubbard®), the latter being a more animal-friendly alternative and increasingly demanded by consumers. The fast-growing breed is characterised by efficient feed conversion and a good meat yield (Ross, 2019). In contrast, the slow-growing breed is focused on the criteria of animal welfare, meat quality and absence of ABs (Valls, 2017).

To this end, 576 broilers (males and females) provided from the same hatchery were located in two identical poultry rooms (replica A and B) and 288 animals were housed in each room (144 of fast-growing and 144 for slow-growing). The animals were randomly housed in 24 pens (12 pens for each breed) of 1.3 m² in a final stocking density of 35 kg/m², with wood shavings as bedding material. The house was supplied with programmable electrical lights, automated electric heating and forced ventilation. The environmental temperature was gradually decreased from 32 °C (1 day) to 19 °C (42 days) in line with common practice in poultry production. The experimental pelleted feed was commercial feed according to standard diets for broilers. Two different age diets were offered to the birds: starter (1 day to 21 days, Camperbroiler iniciación, Alimentación Animal Nanta, Valencia, Spain) and grower (21 days to 42/63 days, A-32 broiler and A-80 Pollos crecimiento, Alimentación Animal Nanta, Valencia, Spain, for fast-growing and slow-growing breed, respectively). Only one batch of feed per age (starter and grower) was manufactured. The starter diet was the same for both breeds, while the

grower feed was the standard diet specific for each breed. Nutritional and product analysis were assessed before the arrival of animals. Feed was weighed, manually distributed and added *ad libitum*. Furthermore, the mortality and the presence of diarrhoea were recorded daily. Finally, animals were weighed at weekly intervals and feed consumption per pen was recorded.

3.1.2.3.2 Sample collection

To assess the dynamic of AMR rates in the microbiota of broilers throughout the growing period, commensal *E. coli* was selected as sentinel (EFSA and ECDC, 2018). To this end, 30 animals from each experimental group were randomly selected and sampled at different points during the growing period: on arrival (day-old chicks), at the mid-period (21 days old) and before slaughter (42 days of age in fast-growing, and 63 days in slow-growing). Caecum samples were taken individually and placed in sterile jars. The samples were processed within 24h after collection.

3.1.2.3.3 *E. coli* isolation

Caecal content was removed and homogenised. Afterwards, pools of six animals from each replica were prepared (5 pools/treatment) and the pools content was cultured directly onto a non-specific medium: blood agar (Scharlab, S.L., Barcelona, Spain) in aerobic and anaerobic conditions, and 2 Gram-negative specific media: MacConkey agar (Scharlab, S.L., Barcelona, Spain) and Coliform chromogenic agar (Scharlab, S.L., Barcelona, Spain). Agar plates were incubated at $37\text{ °C} \pm 1\text{ °C}$ for 24h. After incubation, suspected colonies were streaked into a nutrient medium (Scharlab, S.L., Barcelona, Spain) and incubated at $37\text{ °C} \pm 1\text{ °C}$ for 24h. Then, API-20E test (Biomerieux, S.L., Barcelona, Spain) was performed to confirm *E. coli*.

3.1.2.3.4 Antimicrobial susceptibility testing

Antimicrobial susceptibility was tested according to the European Committee on Antimicrobial Susceptibility Testing (EUCAST) guidelines (Matuschek, 2014). The source for zone diameters used for interpretation of the test was: http://www.eucast.org/clinical_breakpoints/. *E. coli* strains were inoculated into Mueller-Hinton agar (Scharlab, S.L., Barcelona, Spain) to form a bacterial lawn, the AB discs were added and plates were incubated at 37 °C for 24h. The ABs selected were those set

forth in Decision 652/2013 (EC, 2013), including two quinolones: ciprofloxacin (**CIP**, 5 µg) and nalidixic acid (**NAL**, 30 µg); three b-lactams: ampicillin (**AMP**, 10 µg), cefotaxime (**CTX**, 30 µg) and ceftazidime (**CAZ**, 30 µg); one phenicol: chloramphenicol (**CHL**, 5 µg); one potentiated sulfonamide: trimethoprim-sulfamethoxazole (**SXT**, 1.25/23.75 µg); one polymyxin: colistin (**CST**, 10 µg); one macrolide: azithromycin (**AZM**, 15 µg); one glycyclcline: tigecycline (**TGC**, 15 µg); one aminoglycoside: gentamycin (**GEN**, 10 µg), and one pyrimidine: trimethoprim (**TMP**, 5 µg). MDR was defined as acquired resistance to at least one agent in two or more AMA classes (EFSA and ECDC, 2016).

3.1.2.3.5 Statistical analysis

A Generalised Lineal Model (**GLM**) was used to compare the AMR rates between breeds (fast-growing vs slow-growing breed) and between ABs throughout the growing period (beginning, mid-period and slaughter day). A P -value<0.05 was considered to indicate a statistically significant difference. Analyses were carried out using a commercially available software application (SPSS 24.0 software package; SPSS Inc., Chicago, IL, 2002).

3.1.2.4 Results

During this study, all the productive parameters obtained corresponded to the breed standards and no clinical signs were observed. During growing, a total of 50 pools of caecal content were examined in four agar plates, of which 199 (n=200) were culture positive for *E. coli* (100 for fast-growing breed and 99 for slow-growing breed).

3.1.2.4.1 Prevalence of antimicrobial resistance

AMR rates of *E. coli* isolates from both breeds are presented in Figure 19. For all strains isolated, 98.0% (n=98) and 91.9% (n=91) from fast and slow-growing breed, respectively, were resistant to at least one out of the twelve ABs tested. Moreover, statistically significant differences in AMR rates were shown throughout the growing period according to the breed studied (P -value<0.05). At the onset of the growing period, 100.0% (n=12) and 63.6% (n=11) of the isolates from fast and slow-growing breed were AB resistant and the strains isolated from fast-growing animals presented a higher AMR rate, with statistical differences between breeds (P -value<0.05). However, by the end of

the growth period these differences disappeared; the fast-growing breed reached an AMR rate of 95.6% and the slow-growing breed reached an AMR rate of 96.2%.

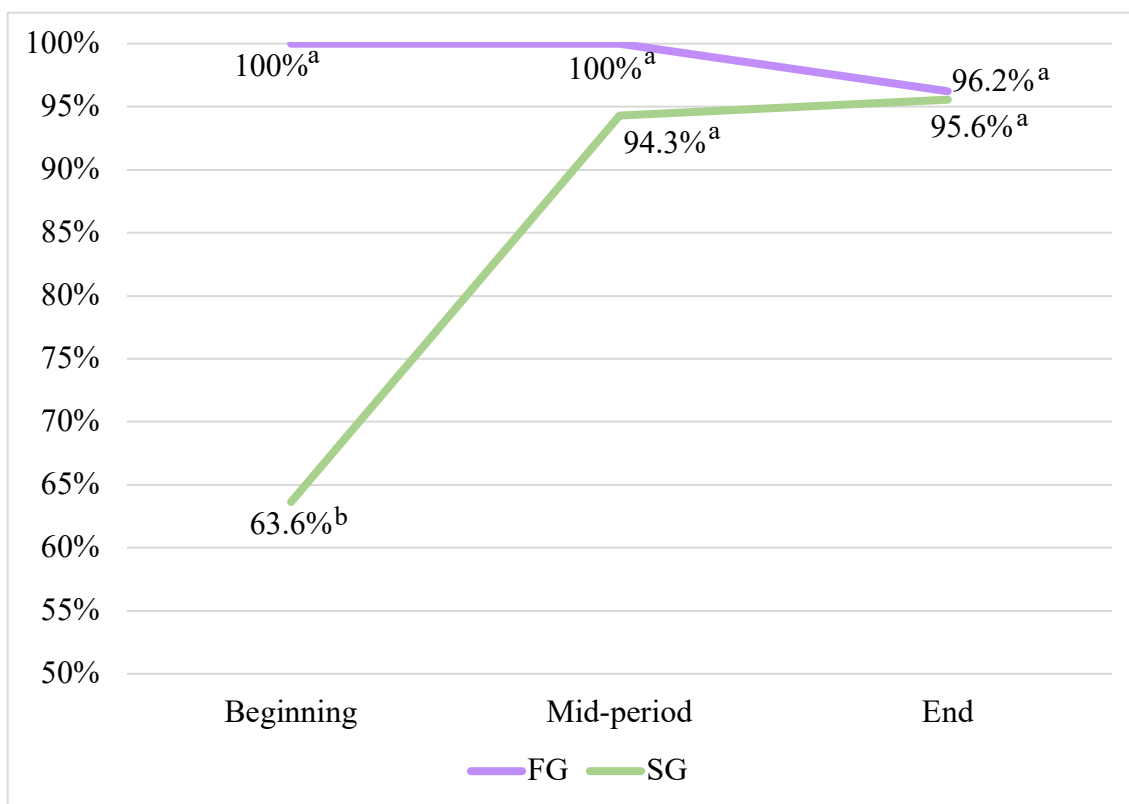

Figure 19. Antimicrobial resistant *E. coli* strains dynamic in fast-growing and slow-growing breed throughout the growing period. ^{a, b}: Different superscripts means significant differences with a *P*-value<0.05.

For the fast and slow-growing breed, *E. coli* AMR rates obtained against different ABs tested over time are summarised in Table 7.

Table 7. Antibiotic resistance rates according to the antibiotic and the moment of the growing period in FG and SG breeds.

Breed	Sampling moment	n	CIP	NAL	CTX	CAZ	AMP	CHL	SXT	CST	AZM	TGC	GEN	TMP
FAST-GROWING BREED	Beginning	12	50 ^b	91.7	8.3	33.3 ^c	91.7 ^b	8.3	41.7	0	8.3 ^a	0	8.3	50
	Mid-period	43	95.4 ^c	83.7	11.6	11.6 ^b	55.8 ^a	2.3	58.1	9.3	9.3 ^a	0	2.3	55.8
	End	45	20 ^a	71.1	0	0 ^a	53.3 ^a	4.4	35.6	8.9	82.2 ^b	0	0	51.1
SLOW-GROWING BREED	Beginning	11	0 ^a	0 ^a	0	27.3	27.3 ^a	0	0	0	0 ^a	0	0	9.1
	Mid-period	35	91.4 ^b	57.1 ^b	17.1	5.7	42.9 ^a	0	28.6	0	2.9 ^a	0	0	31.4
	End	53	11.3 ^a	86.8 ^c	7.6	9.4	66.9 ^b	5.7	26.4	9.4	41.5 ^b	0	1.9	45.3

FG: Fast-growing breed, SG: Slow-growing breed, CIP: ciprofloxacin, NAL: nalidixic acid, CTX: cefotaxime, CAZ: ceftazidime, AMP: ampicillin, CHL: chloramphenicol, SXT: trimethoprim-sulfamethoxazole, CST: colistin, AZM: azithromycin, TGC: tigecycline, GEN: gentamycin and TMP: trimethoprim.

^{a, b, c}: different superscripts in each column means significant differences with a P -value<0.05.

3.1.2.4.2 Prevalence of multidrug-resistance

According to the MDR rates observed in fast-growing *E. coli* strains, on arrival day, 75.0% of the AB resistant strains showed an MDR pattern, and this pattern was maintained until the end of the growing period (83.7%) (P -value>0.05).

Conversely, for slow-growing breed, none of the *E. coli* strains isolated at the start of the growth period showed an MDR pattern (0%), although this percentage increased to 84.3% (43/51) before slaughter (P -value<0.05) (Figure 20).

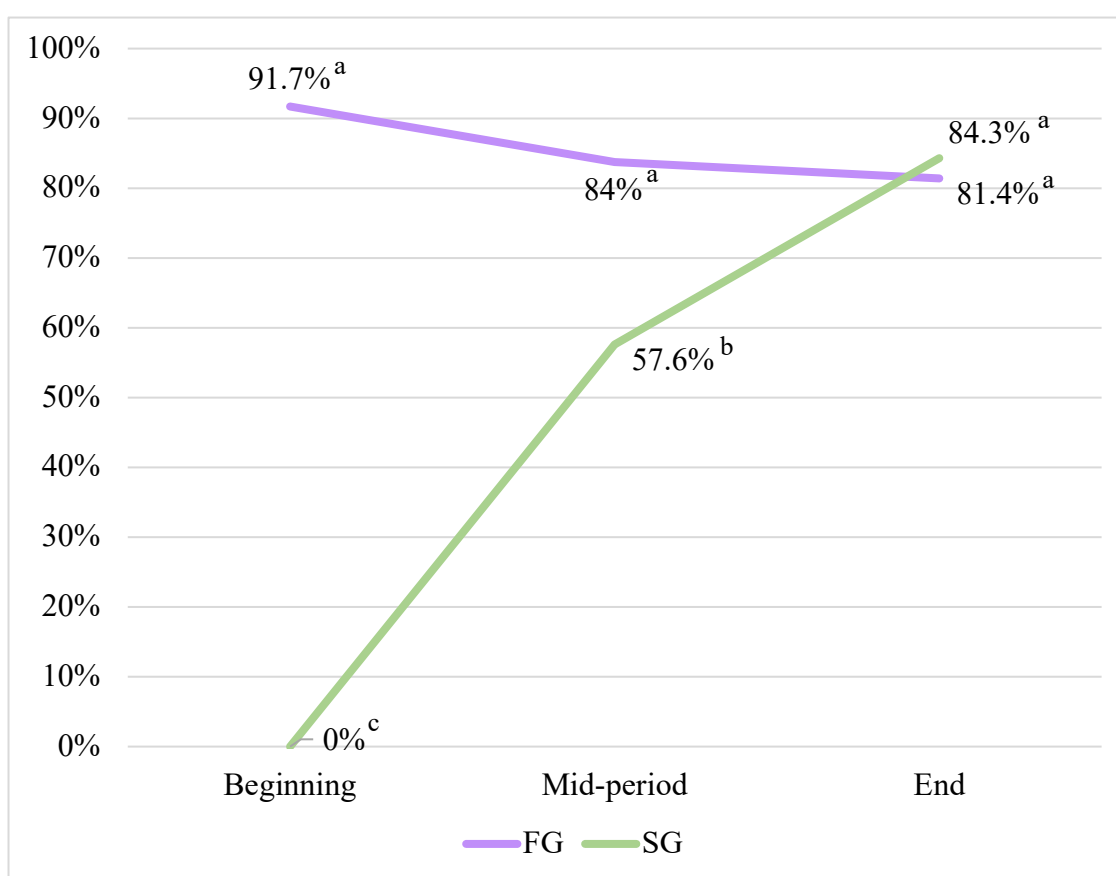

Figure 20. Multidrug-resistant *E. coli* strains dynamic in fast-growing and slow-growing breed throughout the growing period. ^{a, b, c}: Different superscripts means significant differences with a P -value<0.05.

3.1.2.4.3 Antibiotic resistance patterns

For the fast-growing breed, no AMR was observed in 2 (2.0%) of the isolates, 12 *E. coli* strains were resistant to only one AB and 18 (18.0%) to two, 13 (13.0%) to three, 21 (21.0%) to four, 25 (25.0%) to five, 3 (3.0%) to six and to seven and 2 (2.0%) to eight. Only one isolate was resistant to ten of the twelve ABs tested (Table 8).

For the slow-growing breed, 8 (8.1%) *E. coli* isolates were completely susceptible to all the ABs tested, 25 (25.3%) isolates were resistant to only one AB and 13 (13.1%) to two, 21 (21.2%) to three, 18 (18.2%) to four, 7 (7.1%) to five and 3 (3.0%) to six and to seven. Only one isolate was resistant to nine of the twelve ABs tested (Table 8).

Overall, 59 different resistance patterns were observed. The combination of CIP-NAL-AMP-SXT-TMP (n=21, 20%) was the most frequently observed pattern, followed by CIP alone (n=13, 6.5%), the combination of NAL-AMP-SXT-TMP (n=11, 6.5%) and NAL-AMP-TMP (n=11, 6.5%).

AMR to the combination NAL-AMP was found in 56.0% and 46.5% of fast-growing and slow-growing *E. coli* strains, respectively, followed by resistance to the combination CIP-NAL (48.0% for fast-growing breed and 25.3% for slow-growing breed). Finally, it is important to highlight that 35.0% of fast-growing isolates and 18.2% of slow-growing isolates showed resistance to the combination CIP-AMP-NAL.

Table 8. Number of *E. coli* strains isolated resistant to the different number of antibiotics tested according to the sampling moment in FG and in SG breeds.

Breed	Sampling moment	Number of AMR to the indicated number of antibiotics											
		0	1	2	3	4	5	6	7	8	9	10	Total
FAST-GROWING BREED	Beginning	0	1	2	3	1	3	1	0	1	0	0	12
	Mid-period	0	3	7	6	11	13	0	2	0	0	1	43
	End	2	8	9	4	9	9	2	1	1	0	0	45
	Total	2	12	18	13	21	25	3	3	2	0	1	100
SLOW-GROWING BREED	Beginning	4	7	0	0	0	0	0	0	0	0	0	11
	Mid-period	2	10	7	3	6	4	2	1	0	0	0	35
	End	2	8	6	18	12	3	1	2	0	1	0	53
	Total	8	25	13	21	18	7	3	3	0	1	0	99

3.1.2.5 Discussion

The present study assessed the AMR dynamic in fast and slow-growing breeds throughout the growing period under commercial farms conditions. To our best knowledge, this is the first study in the scientific literature to evaluate the relationship between both breeds on AMR evolution under the same production conditions.

Social pressure against intensive production systems demands the prohibition of AB administration during the growing period and the use of new welfare-friendly breeds, which means chickens genetically adapted to less intensive production conditions (Castellini and Dal Bosco, 2017). However, our results demonstrated that although non-ABs were administered during the growing period, the same AMR rates were observed in both breeds (fast and slow-growing) at the end of the growing period.

In 2016, the EFSA reported that 77.8% of *E. coli* isolated from broilers in EU were resistant to ABs. However, there were large differences in AMR rates between EU MS, being notably lower in Nordic countries and higher in Southern countries, especially Spain (EFSA and ECDC, 2018).

Regarding AMR rates obtained for the different ABs assessed, it is important to highlight the results obtained for TGC and CST, as they are the last-resort drugs used to treat human infectious diseases caused by multi-resistant bacteria (Kern, 2018). On the one hand, in this study the AMR to TGC was not detected in any isolate strain. This result agrees with that reported by the EFSA, in the EU, where only four countries presented AMR to this AB (EFSA and ECDC, 2018). The total susceptibility to TGC might be explained by its restricted use to human hospital treatments (PRAN, 2018). On the other hand, resistance to CST was found in both breeds. These results are also similar to those reported by the EFSA, in which only seven countries, including Spain, reported AMR to CST (EFSA and ECDC, 2018). Moreover, in other countries such as China, CST AMR rates reported were also very high (Zhang *et al.*, 2019). This fact can be explained by its use in animal production for several years, especially in swine, to treat infectious diseases and as a growth promotor (EMA, 2017). Thus, the use of CST as a growth promotor has resulted in a high AMR to CST worldwide. It is important to highlight that the use of ABs as a

growth promotor is a production technique has been banned in the EU since 2006 (EC, 2003).

The AMR rates shown in this study to CTX, CAZ, CHL and GEN were low, in accordance with results obtained in previous studies in EU (EFSA and ECDC, 2018; MAPA, 2018). However, Koga *et al.* (2015) recorded higher resistance rates in commercial broiler production in Brazil to all these ABs, except to CAZ.

It is important to highlight the high AMR obtained to CIP, NAL, AMP, SXT, AZM and TMP in this study (Koga *et al.*, 2015; Hussain *et al.*, 2017; Ayandiran *et al.*, 2018; EFSA and ECDC, 2018). Slight variations in AMR rates among isolates in these studies could be due to the different analysis methods employed, the different management systems set up, level of AMR in hatcheries and use of ABs in the study areas (Okorafor *et al.*, 2019). Specifically, for AMP, TMP and SXT, one hypothesis that could explain the results obtained in this study is that these ABs are permitted in Spain as therapeutic agents for bacterial infections and, as reported above for CST, they have been used as a growth promoter in animal production systems for several years (PRAN, 2018).

The results obtained in this study demonstrated the importance of AMR shedding from breeders to day-old chicks. Several authors have shown that day-old-chicks are potential reservoirs of multi-resistant enterobacteria obtained vertically from breeders (Jiménez-Belenguier *et al.*, 2016; Projahn *et al.*, 2017a,b; Okorafor *et al.*, 2019). MDR bacteria could be transmitted through contaminated eggshells and/or from parent stock to hatchery (Daehre *et al.*, 2017; Projahn *et al.*, 2017a; Osman *et al.*, 2018). Indeed, different reports have demonstrated that vertical transmission to chicks from the top of the production pyramid resulted in the introduction and spread of resistance genes in poultry (Borjesson *et al.*, 2016; Osman *et al.*, 2018).

On the other hand, horizontal transmission of AMR seems to be an important concern for the poultry industry (Szmolka and Nagy, 2013; Bengtsson-Palme *et al.*, 2017; Agyare *et al.*, 2018). Genomic analysis of the bacteria indicates that they could acquire their resistance profiles by incorporating different genetic elements through horizontal gene transfer (Agyare *et al.*, 2018). For this reason, different scientific studies underline the importance of developing sanitary measures at the interface between the environment and livestock farming (Allen *et al.*, 2010; Bengtsson-Palme *et al.*, 2018;

Westphal-Settele *et al.*, 2018). However, it is important to highlight that in this study the animals' origin is from the same hatchery. For this reason, further studies are necessary to compare the AMR dynamics from different companies.

3.1.2.6 Conclusion

In conclusion, the fact that the same AMR rates were observed, regardless of the breed studied, strongly suggests the possibility of vertical transmission from hatcheries and dissemination spread through the environment between flocks. Further studies are needed to confirm this hypothesis, and innovative-cost effective tools should be implemented at farm level to avoid AB administration whenever possible throughout the broiler production chain.

3.1.2.7 References

Agyare, C., V. E. Boamah, C. N. Zumbi and F. B. Osei. 2018. Antibiotic Use in Poultry Production and its Effects on Bacterial Resistance. Pages 1-20 in Antimicrobial Resistance – A Global Threat, ed. Yashwant Kumar, London, United Kingdom.

Alagawany, M., M. E. Abd El-Hack, M. R. Farag, S. Sachan, K. Karthik and K. Dhama. 2018. The use of probiotics as eco-friendly alternatives for antibiotics in poultry nutrition. *Environ Sci Pollut Res Int.* 25:10611-10618.

Allen, H. K., J. Donato, H. H. Wang, K. A. Cloud-Hansen, J. Davies and J. Handelsman. 2010. Call of the wild: antibiotic resistance genes in natural environments. *Nat Rev Microbiol.* 8:251-9.

Alós, J. 2015. Resistencia bacteriana a los antibióticos: una crisis global. *Enferm. Infecc. Microbiol. Clin.* 33, 692–699.

Ayandiran, T. O., L. Falgenhauer, J. Schmiede, T. Chakraborty and F. A. Ayeni. 2018. High resistance to tetracycline and ciprofloxacin in bacteria isolated from poultry farms in Ibadan, Nigeria. *J Infect Dev Ctries.* 12:462-470.

Bachiri, T., S. Bakour, R. Ladjouzi, L. Thongpan, J. M. Rolain and A. Touati. 2017. High rates of CTX-M-15-producing *Escherichia coli* and *Klebsiella pneumoniae* in wild boars and Barbary macaques in Algeria. *J Glob Antimicrob Resist.* 8:35-40.

Belmahdi, M., S. Bakour, C. Al Bayssari, A. Touati and J. M. Rolain. 2016. Molecular characterisation of extended-spectrum β -lactamase- and plasmid AmpC-producing *Escherichia coli* strains isolated from broilers. *Integr. Med. Res.* 6, 108–112.

Bengtsson-Palme, J., E. Kristiansson, and D. G. J. Larsson. 2018. Environmental factors influencing the development and spread of antibiotic resistance. *FEMS Microbiol. Rev.* 42:68–80.

BOE (Boletín Oficial del Estado). Spain. Royal Degree 53/2013, 1st of February 2013, por el que se establecen las normas básicas aplicables para la protección de los animales

utilizados en experimentación y otros fines científicos, incluyendo la docencia. Available at https://www.boe.es/diario_boe/txt.php?id=BOE-A-2013-1337.

Borjesson, S., S. Ny, M. Egervarn, J. Bergstrom, A. Rosengren, S. Englund, S. Lofmark and S. Byfors. 2016. Limited dissemination of extended-spectrum beta-lactamase- and plasmid-encoded AmpC-producing *Escherichia coli* from food and farm animals, Sweden. *Emerg. Infect. Dis.* 22: 634-640.

Castellini, C. and A. Dal Bosco. 2017. Poultry Quality Evaluation: Quality Attributes and Consumer Values. Pages 335-357 in *Animal Welfare and Poultry Meat in Alternative Production Systems (and Ethics of Poultry Meat Production)*. Woodhead Publishing Series in Food Science, Technology and Nutrition, Elsevier Ltd. 2017.

Chang, Q., W. Wang, G. Regev-Yochay, M. Lipsitch and W.P. Hanage. 2015. Antibiotics in agriculture and the risk to human health: how worried should we be? *Evol Appl.* 8: 240–247.

Chantziaras, I., F. Boyen, B. Callens and J. Dewulf. 2013. Correlation between veterinary antimicrobial use and antimicrobial resistance in food-producing animals: A report on seven countries. *J Antimicrob Chemother.* 69:827-34.

Cheng, G., H. Hao, S. Xie, X. Wang, M. Dai, L. Huang and Z. Yuan. 2014. Antibiotic alternatives: The substitution of antibiotics in animal husbandry? *Front Microbiol.* 5:217.

Daehre, K., M. Projahn, T. Semmler, U. Roesler and A. Friese. 2017. Extended-spectrum beta-lactamase-/ AmpC beta-lactamase-producing Enterobacteriaceae in broiler farms: Transmission dynamics at farm level. *Microb. Drug Resist.* 24: 511-518.

Dandachi, I., E. S. Sokhn, E. A. Dahdouh, E. Azar, B. El-Bazzal, J-M. Rolain and Z. Daoud. 2018. Prevalence and Characterization of Bacilli Isolated from Lebanese Poultry: A Nationwide Study. *Front Microbiol.* 9:550.

EC (European Commission). Regulation (EC) No 1831/2003 of the European Parliament and of the Council of 22 September 2003 on additives for use in animal nutrition (Text with EEA relevance).

EC (European Commission). Commission implementing Decision, of 12 november 2013, on the monitoring and reporting of antimicrobial resistance in zoonotic and commensal bacteria (2013/652/EU).

EFSA and ECDC (European Food Safety Authority and European Centre for Disease Control). 2016. EU protocol for harmonised monitoring of antimicrobial resistance in human *Salmonella* and *Campylobacter* isolates. Stockholm: ECDC; 2016.

EFSA and ECDC (European Food Safety Authority and European Centre for Disease Control). 2018. The European Union summary report on antimicrobial resistance in zoonotic and indicator bacteria from humans, animals and food in 2016. EFSA Journal 16:5182.

EFSA and ECDC (European Food Safety Authority and European Centre for Disease Control). 2019. Technical specifications on harmonised monitoring of antimicrobial resistance in zoonotic and indicator bacteria from food-producing animals and food. EFSA Journal 17:5709.

EMA (European Medicines Agency). 2017. Sales of veterinary antimicrobial agents in 30 European countries in 2015. Trends from 2010 to 2015. Seventh ESVAC report.

Founou, L.L., R.C. Founou and S.Y. Essack. 2016. Antibiotic Resistance in the Food Chain: A Developing Country-Perspective. Front Microbiol. 7: 1881.

Gadde U., W. H. Kim, S. T. Oh and H. S. Lillehoj. 2017. Alternatives to antibiotics for maximizing growth performance and feed efficiency in poultry: a review. Anim Health Res Rev. 18:26-45.

Guo X., R. D. Stedtfeld, H. Hedman, J. N. S. Eisenberg, G. Trueba, D. Yin, J. M. Tiedje and L. Zhang. 2018. Antibiotic Resistome Associated with Small-Scale Poultry Production in Rural Ecuador. Environ Sci Technol. 52:8165-8172.

Hancock, R. E., A. Nijnik and D. L. Philpott. 2012. Modulating immunity as a therapy for bacterial infections. Nat Rev Microbiol. 10:243-54.

Horigan, V., R.D. Kosmider, R.A. Horton, L. Randall and R.R. Simons. 2016. An assessment of evidence data gaps in the investigation of possible transmission routes of extended spectrum β -lactamase producing *Escherichia coli* from livestock to humans in the UK. *Prev Vet Med.* 124:1-8.

Hussain, A., S. Shaik, A. Ranjan, N. Nandanwar, S.K. Tiwari, M. Majid, R. Baddam, I.A. Qureshi, T. Semmler, L.H. Wieler, M.A. Islam, D. Chakravorty and N. Ahmed. 2017. Risk of Transmission of Antimicrobial Resistant *Escherichia coli* from Commercial Broiler and Free-Range Retail Chicken in India. *Front Microbiol.* 8:2120.

Jiménez-Belenguer, A., E. Doménech, A. Villagrà, A. Fenollar and M.A. Ferrús. 2016. Antimicrobial resistance of *Escherichia coli* isolated in newly hatched chickens and effect of amoxicillin treatment during their growth. *Avian Pathol.* 45: 501-507.

Kern, W.V. 2018. Multiresistant Bacteria - Antibiotic Prescription and Antibiotics of Last Resort. *Dtsch Med Wochenschr.* 143:643-650.

Khurana, A., R. Shina and M. Nagaraju. 2017. Antibiotic Resistance in Poultry Environment: Spread of Resistance from Poultry Farm to Agricultural Field. Centre for Science and Environment, New Delhi.

Koga, V. L., S. Scandorieiro, E. C. Vespero, A. Oba, B. G. de Brito, K. C. de Brito, G. Nakazato and R. K. Kobayashi. 2015. Comparison of Antibiotic Resistance and Virulence Factors among *Escherichia coli* Isolated from Conventional and Free-Range Poultry. *Biomed Res Int.* 618752.

Liu, Y.Y., Y. Wang, T.R. Walsh, L.X. Yi, R. Zhang, J. Spencer, Y. Doi, G. Tian, B. Dong, X. Huang, L.F. Yu, D. Gu, H. Ren, X. Chen, L. Lv, D. He, H. Zhou, Z. Liang, J.H. Liu and J. Shen. 2016. Emergence of plasmid-mediated colistin resistance mechanism MCR-1 in animals and human beings in China: a microbiological and molecular biological study. *Lancet Infect Dis.* 16:161-8.

Lusk J. L. 2018a. Consumer Beliefs, Knowledge, and Willingness-to-Pay for Sustainability-Related Poultry Production Practices Broiler Survey Report. Prepared for the Food Marketing Institute Foundation, Animal Agriculture Alliance, and the Foundation for Food and Agriculture Research.

Lusk, J. L. 2018b. Consumer preferences for and beliefs about slow growth chicken. *Poult Sci.* 97:4159-4166.

Marshall, B. M. and S. B. Levy. 2011. Food Animals and Antimicrobials: Impacts on Human Health. *Clin Microbiol Rev.* 24:718-33.

Matuschek E., D. F. Brown and G. Kahlmeter. 2014. Development of the EUCAST disk diffusion antimicrobial susceptibility testing method and its implementation in routine microbiology laboratories, *Clin Microbiol Infect.* 20 O255-66.

Mehdi Y., M. P. Létourneau-Montminy, M. L. Gaucher, Y. Chorfi, G. Suresh, T. Rouissi, S. K. Brar, C. Côté, A. A. Ramirez and S. Godbout. 2018. Use of antibiotics in broiler production: Global impacts and alternatives. *Anim Nutr.* 4:170-178.

MAPA (Ministry of Agriculture, Fishing and Food). 2018. Informe JIACRA España. Primer análisis integrado del consumo de antibióticos y su relación con la aparición de resistencia. Accessed Jul. 2019. <http://www.resistenciaantibioticos.es/es/publicaciones/informe-jiacra-espana>.

Okorafor, O.N., M. U. Anyanwu, E. O. Nwafor, G. N. Anosa, R. I. Udegbumam. 2019. Multidrug-resistant enterobacteria colonize commercial day-old broiler chicks in Nigeria. *Vet World.* 12:418-423.

Osman, K. M., A. D. Kappell, M. Elhadidy, E. ElMougy, W. A. A. El-Ghany, A. Orabi, A. S. Mubarak, T. M. Dawoud, H. A. Hemeg, I. M. I. Moussa, A. M. Hessain and H. M. Y. Yousef. 2018. Poultry hatcheries as potential reservoirs for antimicrobial-resistant *Escherichia coli*: A risk to public health and food safety. *Sci Rep.* 8:5859.

Polycarpo, G. V., I. Andretta, M. Kipper, V. C. Cruz-Polycarpo, J. C. Dadalt, P. H. M. Rodrigues and R. Albuquerque. 2017. Meta-analytic study of organic acids as an alternative performance-enhancing feed additive to antibiotics for broiler chickens. *Poult Sci.* 96:3645-3653.

PRAN (Plan Nacional Resistencia Antibióticos). 2018. Antibióticos críticos. Accessed Jun. 2019. <http://resistenciaantibioticos.es/es/profesionales/vigilancia/antibioticos-criticos>.

Projahn, M., K. Daehre, U. Roesler and A. Friese. 2017a. Extended-spectrum beta-lactamase and plasmid-encoded cephamycins-producing enterobacteria in broiler hatchery as a potential mode of pseudovertical transmission. *Appl. Environ. Microbiol.* 83:e02364.

Projahn, M., K. Daehre, T. Semmler, S. Guenther, U. Roesler and A. Friese. 2017b. Environmental adaptation and vertical dissemination of ESBL-/pAmpC-producing *Escherichia coli* in an integrated broiler production chain in the absence of antibiotic treatment. *Microb. Biotechnol.* 11:1017-1026.

Ross. 2019. Ross 308/Ross 308 FF broiler: Performance objectives. Accessed Jun. 2019. http://es.aviagen.com/assets/Tech_Center/Ross_Broiler/Ross308-308FF-BroilerPO2019-EN.pdf.

Sevilla-Navarro S., C. Marín, V. Cortés, C. García, S. Vega, and P. Catalá-Gregori. 2018. Autophagy as a control measure for *Salmonella* in laying hens. *Poult Sci.* 97:4367-4373.

Sharma C., N. Rokana N, M. Chandra M, B.P. Singh, R.D. Gulhane, J.P.S. Gill, P. Ray P, A.K. Puniya and H Panwar. 2018. Antimicrobial Resistance: Its Surveillance, Impact, and Alternative Management Strategies in Dairy Animals. *Front Vet Sci.* 8;4:237.

Sirri, F., C. Castellini, M. Bianchi, M. Petracci, A. Merluzzi and A. Franchini. 2011. Effect of fast-, medium- and slow-growing strains on meat quality of chickens reared under the organic farming method. *Animal.* 5:312-9.

Suresh, G., R. K. Das, S. Kaur Brar, T. Rouissi, A. Avalos Ramirez, Y. Chorfi and S. Godbout. 2018. Critical Reviews in Microbiology Alternatives to antibiotics in poultry feed: molecular perspectives. *Crit Rev Microbiol.* 44:318-335.

Szmolka, A and B. Nagy. 2013. Multidrug resistant commensal *Escherichia coli* in animals and its impact for public health. *Front Microbiol.* 4: 258.

Valls, M. 2017. Reproductoras & pollos crecimiento lento. Accessed Jun. 2019. <https://avicultura.info/reproductoras-y-pollos-de-crecimiento-lento/>.

Westphal-Settele, K., S. Konradi, F. Balzer, J. Schönfeld and R. Schmithausen. 2018. The environment as a reservoir for antimicrobial resistance: A growing problem for public health? *Bundesgesundheitsblatt Gesundheitsforschung Gesundheitsschutz*. 61:533-542.

WHO (World Health Organization). 2014. Antimicrobial resistance: global report on surveillance 2014. Available at <https://www.who.int/antimicrobial-resistance/publications/surveillancereport/en/>.

Zhang, X., B. Zhang, Y. Guo, J. Wang, P. Zhao, J. Liu and K. He. 2019. Colistin resistance prevalence in *Escherichia coli* from domestic animals in intensive breeding farms of Jiangsu Province. *Int J Food Microbiol*. 291:87.

3.2 Effect of the management system on the intestinal microbiota, the antimicrobial resistance dynamics and *Salmonella* spp. epidemiology

3.2.1 Assessment of microbiota modulation in poultry to combat infectious diseases

A modified version of this chapter has been published with the reference:

L. Montoro-Dasi, A. Villagra, M. de Toro, M.T. Pérez-Gracia, S. Vega, C. Marin. 2021. Assessment of microbiota modulation in poultry to combat infectious diseases. *Animals*; 11(3):615. doi: 10.3390/ani11030615.

3.2.1.1 Abstract

Poultry is one of the main agricultural sub-sectors worldwide. However, public concern regarding animal welfare and antimicrobial resistance has risen in recent years. Due to the influence of management practices in microbiota, it might be considered to evaluate poultry welfare and health. Therefore, the objective of this research was to analyse the influence on microbiota balance of broilers under commercial and optimal farm conditions, using 16S rRNA sequencing analysis. The research was performed in two identical poultry houses (commercial vs. optimal). Results showed a higher level of microbiota complexity in the group reared under optimal farm conditions at the end of rearing. Regarding microbiota composition, *Firmicutes* was the dominant phylum during all the growing period. However, the second prevalent phylum was *Proteobacteria* at the arrival day, and *Bacteroidetes* since mid-period in both groups. Moreover, the most predominant genera identified were *Oscillospira*, *Ruminococcus*, *Bacteroides* and *Coprococcus*. In conclusion, it is necessary to optimise farm management as much as possible. Using gut microbiota diversity and composition as biomarkers of animal health could be an important tool for infectious disease control with the aim to reduce the administration of ABs at field level.

3.2.1.2 Introduction

Broiler chicken meat is the most consumed worldwide, due to the current demand for cheap and safe protein supplies. In fact, in 2020, global poultry meat production increased by 2.6%, and Spain was the fifth producer country in the EU, producing more than one and a half million tons (FAO, 2019, 2020; MAPA, 2020). These data demonstrate that poultry is the fastest growing agricultural sub-sector. For this reason, producers have historically been driven to intensify farming systems.

However, public concern regarding animal welfare and friendly production systems has increased in recent years (Mottet and Tempio, 2017; Castellini and Dal Bosco, 2017). Thus, legislation in this area is stricter and researchers are focused on the study of livestock management conditions to satisfy social concerns and market demands (Blokhuis *et al.*, 2003; Sassi *et al.*, 2016; Castellini and Dal Bosco, 2017; BOE, 2020). As defined by the OIE, ‘an animal is in a good state of welfare if it is healthy, comfortable, well nourished, safe, able to express innate behaviour, and if it is not suffering from unpleasant states such as pain, fear and distress’ (OIE, 2019). In this sense, a large number of factors are considered sources of stress in poultry production, such as environmental deterioration, unsuitable social environments, difficulties in accessing essential resources, overcrowding, inadequate temperatures or diseases (Gomes *et al.*, 2014; Sassi *et al.*, 2016; Goo *et al.*, 2019).

Historically, to fight against infectious diseases, poultry veterinarians have mainly used AMAs. Social demand for AB-free meat has also increased. For this reason, the main objective is to achieve optimal health and welfare status of the animals to increase their resilience. This way, they will be able to cope easily with the environmental risks, including possible pathogens, without AMAs administration (Guardia *et al.*, 2011; Soleimani *et al.*, 2012b; Franz *et al.*, 2012; Gomes *et al.*, 2014; Sassi *et al.*, 2016; Thaxton *et al.*, 2016; Dawkins, 2017).

In this social context, producers are motivated to choose alternative production systems to avoid the drawbacks of more intensive production, while also trying to maintain the profitability of their farms (Gocsik *et al.*, 2016; El-Deek and El-Sabrou, 2019). To assess the effect of these alternative management measures, intestinal microbiota composition might be considered as a biomarker of animal’s health and stress status (Pandit *et al.*,

2018; Wang *et al.*, 2018; Carrasco *et al.*, 2019). It has been demonstrated that any change in the environment directly affects intestinal bacteria balance, and intestinal bacteria balance is known to have an important influence on animal's health and performance parameters. Thus, the implementation of new and cost effective molecular techniques at field level could help to take rapid and swift management decisions (Clavijo and Flórez, 2018; Pandit *et al.*, 2018; Wang *et al.*, 2018; Carrasco *et al.*, 2019; Hasan and Yang, 2019; He *et al.*, 2019).

Hence, the aim of this study is to analyse the influence on microbiota balance of broilers in standardised commercial farm conditions or under improved farm conditions, using 16S rRNA sequencing analysis.

3.2.1.3 Material and methods

In this trial, handling of experimental animals was approved by the Ethical Review Panel of the Directorate-General for Agriculture, Fisheries and Livestock from the Valencian Community by the code 2018/VSC/PEA/0067, according to Spanish Royal Decree 53/2013 (BOE, 2013).

3.2.1.3.1 Experiment design

In this research, two different environmental farm conditions were studied: commercial farm conditions (**CFC**, house 1: 35 kg/m² of final density and non-optimal ventilation parameters, allowing a maximum ammonia concentration of 25 ppm) and optimal farm conditions (**OFC**, house 2: final density at 17 kg/m² and ventilation within the optimal parameters, allowing a maximum ammonia concentration of 10 ppm) (Figure 21).

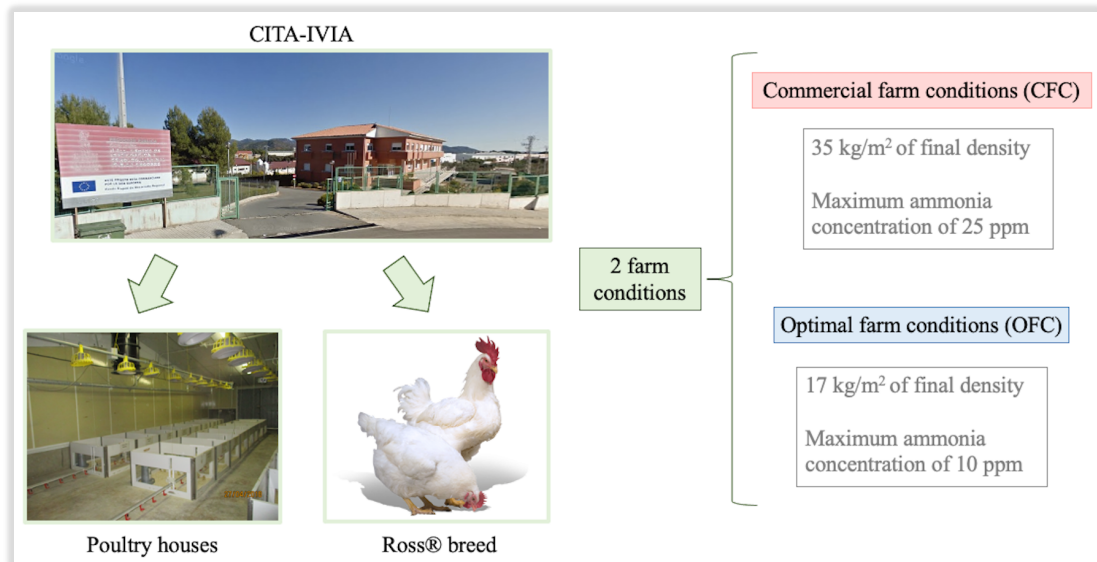

Figure 21. Experiment design management systems scheme in experiment 2.

To this end, a total of 1 062 of day-old-chicks (Ross®) (males and females) were distributed in two poultry houses in an experimental poultry farm at CITA-IVIA. In each of the houses, 204/531 animals were located in 12 pens with wood shavings as bedding material. The rest of the animals (327/531) were housed in the remaining space using also wood shavings as bedding material to simulate production conditions (Figure 22). According to common practice in poultry production, houses were supplied with programmable electrical lights, automated electric heating and forced ventilation. The environmental temperature was gradually lowered from 32 °C (1 day) to 19 °C (42 days). Moreover, high biosecurity levels were maintained in the experimental poultry farm during the rearing.

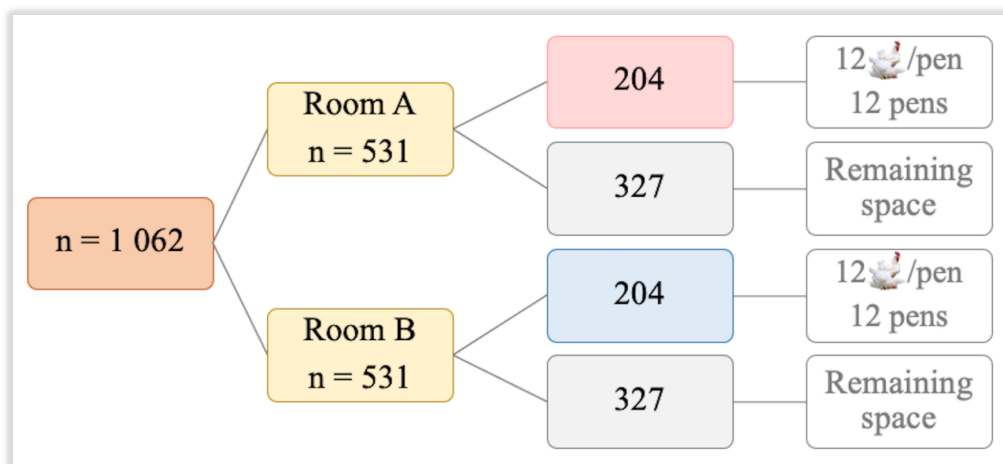

Figure 22. Animals' housing scheme in experiment 2.

Animals were fed with two different diets according to standard diets for broilers: from hatching day until 21 days post hatch, chicks were fed a pelleted starter diet (Camperbroiler iniciación, Alimentación Animal Nanta, Valencia, Spain), and from 21 days of age to the slaughter day (42 days of age) the poultry were offered a pelleted grower diet (A-32 broiler, Alimentación Animal Nanta, Valencia, Spain). Nutritional composition of the diets is detailed in Table 9. Only one batch of feed per age was provided, no coccidiostats or antimicrobials were added, and all the analysis were assessed before the beginning of the experiment. Feed has been supplied *ad libitum*, but to control feed consumption, it was weighed and added manually. Finally, the mortality and the presence of diarrhoea were registered daily, and animals' weight and feed consumption were recorded at weekly intervals.

Table 9. Composition of starter and grower diets.

Analytical constituents	Diet	
	Starter (%)	Grower (%)
Crude fat	3.5	3.1
Crude protein	20.5	19.4
Crude fibre	2.6	3.1
Crude ash	6.6	5.0
Lysine	1.14	1.13
Methionine	0.62	0.51
Calcium	1.00	0.78
Phosphorus	0.69	0.51
Sodium	0.15	0.14
Metabolic Energy (MJ/Kg)	12.20	13.13

Starter (%): percentage of analytical constituents for starter diet, Grower FG (%): percentage of analytical constituents for grower diet.

3.2.1.3.2 Sample collection and DNA extraction

To assess the microbiota evolution, animals from each experimental group were sampled at the arrival day (day-old chicks), at the mid-period (21 days old) and at the slaughter day (42 days of age). On arrival day, animals were selected and caecal samples were collected just before being delivered to the houses (30 samples). Samples were then collected again for each treatment (60 samples/group). Caeca were sampled and placed individually in sterile jars (Figure 23).

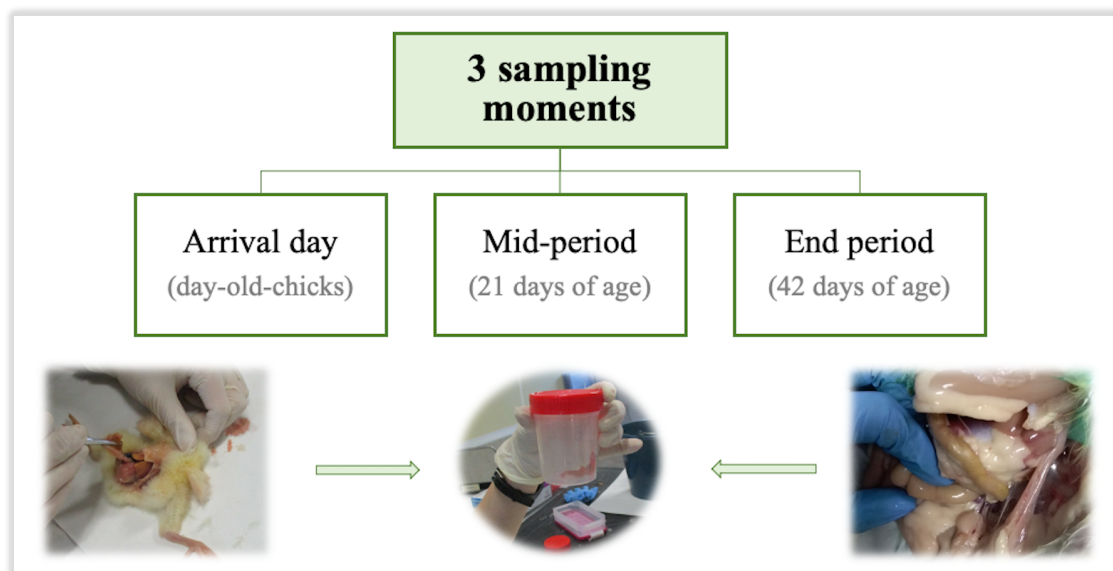

Figure 23. Sample collection scheme in experiment 2.

After sample collection, caecal content was removed and homogenised. Then, pools of six animals from the same experimental group were prepared (5 pools on arrival day and 10 pools/experimental group at mid-period and at the end of rearing), the DNA of pools content was extracted (QIAamp Power Fecal DNA kit, Werfen, Barcelona, Spain) and frozen at -80°C for shipment to the CIBIR, according to manufacturer's instructions.

3.2.1.3.3 16S rRNA gene amplification and MiSeq sequencing

16S rRNA gene amplification and MiSeq Sequencing was performed according to Montoro-Dasi *et al.* 2020 (Montoro-Dasi *et al.*, 2020b).

3.2.1.3.4 Data availability

BioProject: PRJNA612272: Assessment of animal husbandry and environmental control as alternatives to antibiotics use in broiler and growing rabbit production. Effect on multi-resistances.

BioSample: SAMN15190317: Commercial and optimal poultry farm conditions. Caecal microbiota characterisation.

3.2.1.4 Results

A total of 45 caecal pools were collected, processed and sequenced: 5 initial samples and 20 per experimental group throughout the growing period. There were no statistical

differences between pools from the same experimental group (P -value >0.05). Moreover, productive parameters obtained were in accordance with the breed standards, and no clinical signs were observed.

3.2.1.4.1 16 rRNA sequencing

The total of sequencing reads of the 45 samples was 21 961 574 (average 274 519.7 reads/sample), with a total of 19 269 620 filtered reads (average 240 870.3 reads/sample), ranging 121 959-477 578 reads. The rarefaction curves were evaluated according to Shannon, Chao1, Observed OTUs and Simpson biodiversity indexes. Samples from the group 1 (day-old chicks) are at the limit of the rarefaction, leaving a rarefaction number of 54 070 reads (Figure 24).

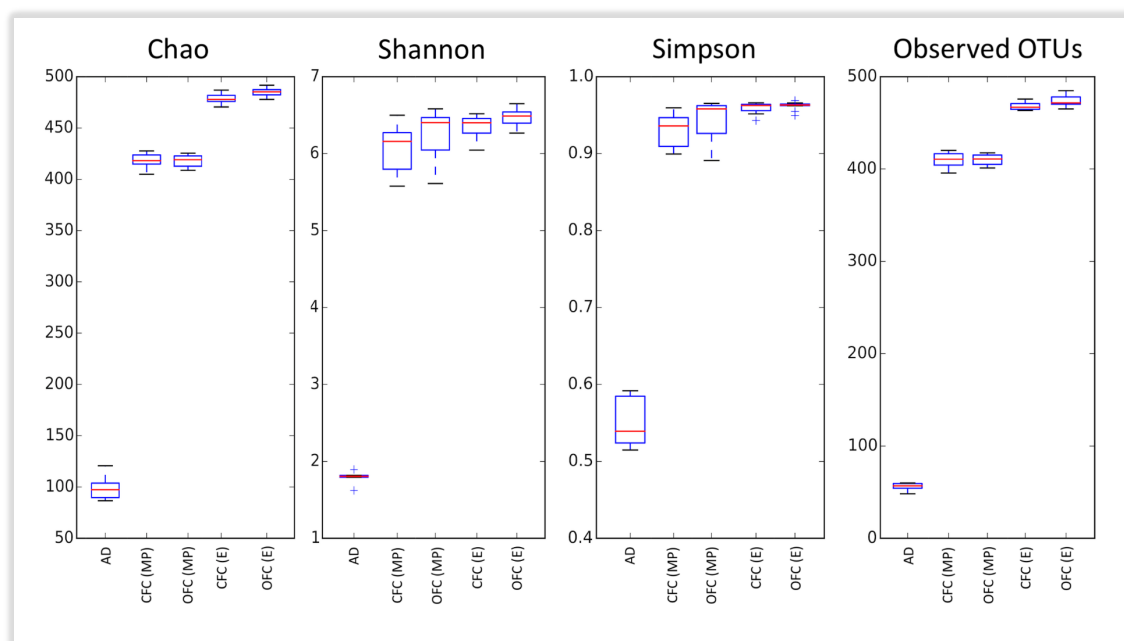

Figure 24. Evaluation of alpha diversity in commercial and optimal farm conditions by using different calculation measures: Chao 1, Shannon, Simpson, Observed OTUs. AD: Arrival day; CFC (MP): Commercial farm conditions at mid-period; OFC (MP): Optimal farm conditions at mid-period; CFC (E): Commercial farm conditions at the end of the growing period; OFC (E): Optimal farm conditions at the end of the growing period.

Rarefaction curves based on the Chao1, Shannon, Simpson and Observed OTUs biodiversity (Table S7, Table S8, Table S9 and Table S10) showed statistically significant differences (P -value <0.05). The Chao1 alpha diversity index reveals a notable difference between the caecal microbiota diversity depending on the moment of sampling (Table 10).

Table 10. Alpha diversity (Chao 1 index) according to the moment of the growing period in CFC and OFC.

Sampling moment	Arrival day	Mid-period	End
CFC	99.6 ^a	417.5 ^b	474.8 ^c
OFC		418.0 ^b	484.8 ^d

CFC: commercial farm conditions, OFC: optimal farm conditions. ^{a, b, c, d}: different superscripts mean significant differences between groups with a P -value<0.05.

3.2.1.4.2 Variation in caecal microbiome structure between farm conditions

Caecal microbiome structures for CFC and OFC at phylum level are represented in Table 11. According to the Kruskal-Wallis and MetagenomeSeq tests, no significant differences were found between farm conditions.

Table 11. Taxonomic profiles at phylum level according to sampling moment in CFC and OFC.

Sampling moment	AD	MP		E	
Farm condition	(%)	CFC (%)	OFC (%)	CFC (%)	OFC (%)
<i>Actinobacteria</i>	0.0	0.1	0.1	0.2	0.2
<i>Bacteroidetes</i>	3.0	4.3	4.1	9.5	9.3
<i>Cyanobacteria</i>	0.0	0.0	0.0	0.5	0.5
<i>Firmicutes</i>	63.2	91.5	91.8	83.8	84.0
<i>Proteobacteria</i>	33.4	1.7	1.7	2.1	2.2
<i>Tenericutes</i>	0.0	1.2	1.2	1.5	1.4
<i>Verrucomicrobia</i>	0.0	0.0	0.1	0.8	0.7
Unassigned	0.3	1.1	1.0	1.6	1.5

CFC: commercial farm conditions, OFC: optimal farm conditions, AD (%): percentage of different phyla at arrival day, MP (%): percentage of different phyla at mid-period, E: percentage of different phyla at the end of the growing period. No statistically significant differences were found between farm conditions at phylum level.

At genus level, 58 taxa were identified and all of them were present in both production conditions. However, we focused on the 25 genera present at an average relative abundance of more than 0.5% in at least one sample group (Mancabelli *et al.*, 2016; Montoro-Dasi *et al.*, 2020b).

In the total sampling, 5 genera were present only in day-old-chicks, 15 appeared at mid-period and 7 at the end of the growing period. Moreover, the most common genera identified were *Oscillospira* spp. (8.8%), *Ruminococcus* spp. (4.0%), *Bacteroides* spp. (3.5%) and *Coprococcus* spp. (3.2%).

In day-old-chicks, the most prevalent genera were Unclassified members (U.m.) of *Proteobacteria* phylum (29.4%), U.m. of *Firmicutes* phylum (13.0%), U.m. of *Ruminococcaceae* family (6.7%), *Oscillospira* spp. (6.0%), *Clostridium* spp. (5.6%), U.m. of *Lachnospiraceae* family (5.3%), *Enterococcus* spp. (3.8%), *Ruminococcus* spp. (3.5%) and U.m. of *Enterococcaceae* family (3.1%).

At mid-period (21 days of age), the predominant bacteria were U.m. of *Firmicutes* phylum (27.4% and 28.0% for CFC and OFC, respectively), U.m. of *Ruminococcaceae* family (18.3% and 18.2%), U.m. of *Lachnospiraceae* family (11.1% and 11.2%), *Oscillospira* spp. (10.4% and 10.3%), *Ruminococcus* spp. (4.4% for both farm conditions) and *Coprococcus* spp. (3.7% for both farm conditions).

Finally, at slaughter day (42 days of age), the most common genera were, likewise, U.m. of *Firmicutes* phylum (28.0% for both experimental groups), U.m. of *Ruminococcaceae* family (16.1% for CFC and 15.6% OFC), U.m. of *Lachnospiraceae* family (9.5% and 9.6%) and *Oscillospira* spp. (8.7% and 8.5%), followed by *Bacteroides* spp. (5.7% and 0.7% for CFC and OFC, respectively), *Ruminococcus* spp. (3.9% for both groups) and *Coprococcus* spp. (3.2% and 3.6%).

Finally, to evaluate differences in microbiota between farm conditions, the R^2 values obtained in beta diversity analysis depending on statistical test used were: Bray-Curtis $R^2 = 0.84517$, Unweighted UniFrac $R^2 = 0.79540$ and Weighted-UniFrac $R^2 = 0.90923$ (these data are represented in Figure S1 and detailed in Table S11). PCoA of the OTU data for each experimental group reveal different profiles depending on the sampling moment (P -value <0.05). The beta diversity comparisons based on Bray-Curtis dissimilarity and genera presence between both experimental groups throughout the growing period are represented in Figure 25, revealing different profiles depending on the sampling time (P -value <0.05).

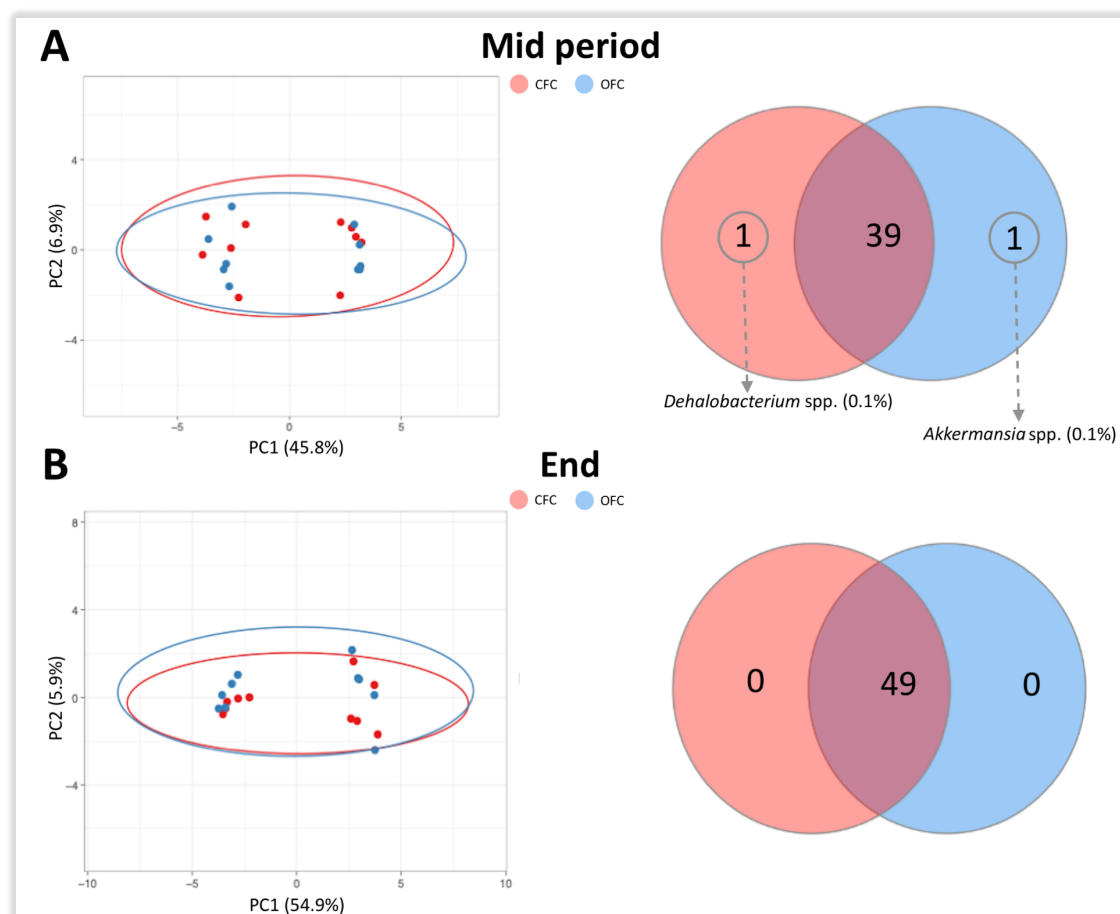

Figure 25. Evaluation of the beta diversity based on Bray-Curtis dissimilarity and comparison of genera presence in commercial and optimal farm conditions. **A:** PCoA graphic and similar vs. different genera for both experimental groups at mid-period. **B:** PCoA graphic and similar vs. different genera for both experimental groups at the end of the growing period. CFC: commercial farm conditions, OFC: optimal farm conditions, PC1: principal component 1, PC2: principal component 2.

3.2.1.5 Discussion

The implementation of molecular techniques in microbiology studies allows to evaluate intestinal bacteria in a ‘before we saw the tree, now the whole forest’ overview. Currently, we are able to observe not only the target bacteria but also all the microorganisms present and their relationship depending on environmental or management conditions.

As described previously, microbiota play a considerable role in animal health. Their composition and richness are directly related with intestinal health, immune system status and performance parameters. Thus, increasing animal welfare in poultry production above the standards laid down in European Union legislation could improve the intestinal microbiota balance, increasing the resilience of the animals, lessening the prevalence of infectious diseases and, in consequence, reducing AB administration in animal

production (Teirlynck *et al.*, 2011; Chen *et al.*, 2015; Ducatelle *et al.*, 2018; Maki *et al.*, 2019; Díaz-Sánchez *et al.*, 2019; Ocejo *et al.*, 2019).

Among the different sources of stress, one of the major problems in poultry production is that avian species are particularly sensitive to environmental challenges associated with temperature and stocking density, especially to heat stress. It is defined as the situation in which temperature and humidity exceed the comfort zone, and it has a significant effect on the productivity and immunology status of animals, causing multiple physiological disturbances. Heat stress is especially problematic in very humid geographic areas, where achieving optimal ventilation parameters in farms is complicated (Lara and Rostagno, 2013; Farag and Alagawany, 2018b; Tsiouris *et al.*, 2018; He *et al.*, 2019; Ranjan *et al.*, 2019).

In this research, animals were reared under two different farm conditions (CFC and OFC) throughout the growing period in order to evaluate the effects of management measures on gut microbiota evolution. There were statistically significant differences in microbiota diversity between farm conditions at slaughter day (42 days of age), when OFC showed a high diversity level. It is well demonstrated that a greater complexity of the gut microbiota is observed as animals grow and became relatively stable as of mid-period (Lu *et al.*, 2003; Amit-Romach *et al.*, 2004; Kers *et al.*, 2018; Shang *et al.*, 2018; Kollarcikova *et al.*, 2019; Montoro-Dasi *et al.*, 2020b). However, overcrowding and heat stress present at the end of the growing period usually induce oxidation alteration, which is closely related to intestinal barrier integrity, which is in turn related to gut microbiota (Song *et al.*, 2014; He *et al.*, 2019; Yang *et al.*, 2019; Paraskeuas and Mountzouris, 2019; Slawinska *et al.*, 2019). Moreover, high stocking density is related to problems in performance and health, possibly caused by the poor access to feed and water, abnormal behaviour and a low air and floor quality (Bessei, 2006; Estevez, 2007; Goo *et al.*, 2019).

Regarding microbiota composition, the most predominant phyla observed in this research were *Firmicutes*, followed by *Proteobacteria* on arrival day and by *Bacteroidetes* during the rest of the growing period, in line with results reported by other authors (Wei *et al.*, 2013; Mohd Shaufi *et al.*, 2015; Kumar *et al.*, 2018; Pandit *et al.*, 2018; Carrasco *et al.*, 2019; Xi *et al.*, 2019). Moreover, the most predominant genera were also in accordance with the bibliography (Wei *et al.*, 2013; Hasan and Yang, 2019; He *et al.*, 2019; Xi *et al.*, 2019). This fact evidences that although the microbiota diversity is low in animals housed

according to the European Union legislation, stress levels are not enough to change the microbiota composition.

3.2.1.6 Conclusion

In conclusion, microbiota diversity increases throughout the growing period, being relatively stable since the mid-period. However, at the end of the rearing, a significant higher level of microbiota complexity was observed in animals reared under optimal farm conditions. Regarding microbiota composition, no statistical differences were observed between experimental groups, for both of them *Firmicutes* was the most abundant phylum during all the research, *Proteobacteria* decreased their concentration throughout the growing, and *Bacteroidetes* increased. At genus level, the most common groups observed for both management systems were *Oscillospira* spp., *Ruminococcus* spp., *Bacteroides* spp. and *Coprococcus* spp. Thus, it could be recommended to reassess the management farm conditions using gut microbiota diversity and composition as biomarkers of animal health. This could be an important tool for infectious disease control with the aim is to reduce the administration of ABs at farm level.

3.2.1.7 References

Amit-Romach, E., D. Sklan, and Z. Uni. 2004. Microflora ecology of the chicken intestine using 16S ribosomal DNA primers. *Poult. Sci.* 83:1093–1098.

Bessei, W. 2006. Welfare of broilers: a review. *Worlds. Poult. Sci. J.* 62:455–466.

Blokhuis, H. J., R. B. Jones, R. Geers, M. Miele, and I. Veissier. 2003. Measuring and monitoring animal welfare: Transparency in the food product quality chain. *Anim. Welf.* 12:445–455.

BOE (Boletín Oficial del Estado). Spain. Royal Degree 53/2013, 1st of February 2013, por el que se establecen las normas básicas aplicables para la protección de los animales utilizados en experimentación y otros fines científicos, incluyendo la docencia. Available at https://www.boe.es/diario_boe/txt.php?id=BOE-A-2013-1337.

BOE (Boletín Oficial del Estado). 2020. Spain. Código de Protección y Bienestar Animal. Available at <https://boe.es/legislacion/codigos/codigo.php?id=204&modo=1¬a=0&tab=2>.

Carrasco, J. M. D., N. A. Casanova, and M. E. F. Miyakawa. 2019. Microbiota, gut health and chicken productivity: What is the connection? *Microorganisms* 7:1–15.

Castellini, C. and A. Dal Bosco. 2017. Poultry Quality Evaluation: Quality Attributes and Consumer Values. Pages 335-357 in *Animal Welfare and Poultry Meat in Alternative Production Systems (and Ethics of Poultry Meat Production)*. Woodhead Publishing Series in Food Science, Technology and Nutrition, Elsevier Ltd. 2017.

Chen, J., G. Tellez, J. D. Richards, and J. Escobar. 2015. Identification of potential biomarkers for gut barrier failure in broiler chickens. *Front. Vet. Sci.* 2.

Clavijo, V., and M. J. V. Flórez. 2018. The gastrointestinal microbiome and its association with the control of pathogens in broiler chicken production: A review. *Poult. Sci.* 97:1006–1021.

Dawkins, M. S. 2017. Animal welfare and efficient farming: is conflict inevitable? *Anim. Prod. Sci.* 57:201.

Díaz-Sánchez, S., A. R. Perrotta, I. Rockafellow, E. J. Alm, R. Okimoto, R. Hawken, and I. Hanning. 2019. Using fecal microbiota as biomarkers for predictions of performance in the selective breeding process of pedigree broiler breeders. *PLoS One* 14.

Ducatelle, R., E. Goossens, F. De Meyer, V. Eeckhaut, G. Antonissen, F. Haesebrouck, and F. Van Immerseel. 2018. Biomarkers for monitoring intestinal health in poultry: Present status and future perspectives. *Vet. Res.* 49:1–9.

El-Deek, A., and K. El-Sabrou. 2019. Behaviour and meat quality of chicken under different housing systems. *Worlds. Poult. Sci. J.* 75:105–114.

Estevez, I. 2007. Density allowances for broilers: Where to set the limits? *Poult. Sci.* 86:1265–1272.

FAO (Food and Agriculture Organization of the United Nations). 2019. Meat Market Review - Overview of global meat market developments in 2018. Available at <http://www.fao.org/3/ca8819en/CA8819EN.pdf>.

FAO (Food and Agriculture Organization of the United Nations). 2020. Meat market review - Overview of global meat market developments in 2019. Available at <http://www.fao.org/publications/card/es/c/CA8819EN/>.

Farag, M. R., and M. Alagawany. 2018. Physiological alterations of poultry to the high environmental temperature. *J. Therm. Biol.* 76:101–106.

Franz, E., H. J. van der Fels-Klerx, J. Thissen, and E. D. van Asselt. 2012. Farm and slaughterhouse characteristics affecting the occurrence of *Salmonella* and *Campylobacter* in the broiler supply chain. *Poult. Sci.* 91:2376–2381.

Gocsik, É., S. D. Broshoof, I. C. de Jong, and H. W. Saatkamp. 2016. Cost-efficiency of animal welfare in broiler production systems: A pilot study using the Welfare Quality® assessment protocol. *Agric. Syst.* 146:55–69.

Gomes, A. V. S., W. M. Quinteiro-Filho, A. Ribeiro, V. Ferraz-de-Paula, M. L. Pinheiro, E. Baskeville, A. T. Akamine, C. S. Astolfi-Ferreira, A. J. P. Ferreira, and J. Palermo-

- Neto. 2014. Overcrowding stress decreases macrophage activity and increases *Salmonella* Enteritidis invasion in broiler chickens. *Avian Pathol.* 43:82–90.
- Goo, D., J. H. Kim, G. H. Park, J. B. D. Reyes, and D. Y. Kil. 2019. Effect of heat stress and stocking density on growth performance, breast meat quality, and intestinal barrier function in broiler chickens. *Animals* 9.
- Guardia, S., B. Konsak, S. Combes, F. Levenez, L. Cauquil, J. F. Guillot, C. Moreau-Vauzelle, M. Lessire, H. Juin, and I. Gabriel. 2011. Effects of stocking density on the growth performance and digestive microbiota of broiler chickens. *Poult. Sci.* 90:1878–1889.
- Hasan, N., and H. Yang. 2019. Factors affecting the composition of the gut microbiota, and its modulation. *PeerJ* 8:1–31.
- He, J., Y. He, D. Pan, J. Cao, Y. Sun, and X. Zeng. 2019. Associations of gut microbiota with heat stress-induced changes of growth, fat deposition, intestinal morphology, and antioxidant capacity in ducks. *Front. Microbiol.* 10:1–13.
- Kers, J. G., F. C. Velkers, E. A. J. Fischer, G. D. A. Hermes, J. A. Stegeman, and H. Smidt. 2018. Host and environmental factors affecting the intestinal microbiota in chickens. *Front. Microbiol.* 9:1–14.
- Kollarčíková, M., T. Kubasová, D. Karasová, M. Crhanová, D. Cejková, F. Sisák, and I. Rychlík. 2019. Use of 16S rRNA gene sequencing for prediction of new opportunistic pathogens in chicken ileal and cecal microbiota. *Poult. Sci.* 98:2347–2353.
- Kumar, S., C. Chen, N. Indugu, G. O. Werlang, M. Singh, W. K. Kim, and H. Thippareddi. 2018. Effect of antibiotic withdrawal in feed on chicken gut microbial dynamics, immunity, growth performance and prevalence of foodborne pathogens. *PLoS One* 13:1–23.
- Lara, L. J., and M. H. Rostagno. 2013. Impact of heat stress on poultry production. *Animals* 3:356–369.

Lu, J., U. Idris, B. Harmon, C. Hofacre, J. J. Maurer, and M. D. Lee. 2003. Diversity and Succession of the Intestinal Bacterial Community of the Maturing Broiler Chicken. *Appl. Environ. Microbiol.* 69:6816–6824.

Maki, J. J., C. L. Klima, M. J. Sylte, and T. Looft. 2019. The microbial pecking order: Utilization of intestinal microbiota for poultry health. *Microorganisms* 7.

Mancabelli, L., C. Ferrario, C. Milani, M. Mangifesta, F. Turrone, S. Duranti, G. A. Lugli, A. Viappiani, M. C. Ossiprandi, D. van Sinderen, and M. Ventura. 2016. Insights into the biodiversity of the gut microbiota of broiler chickens. *Environ. Microbiol.* 18:4727–4738.

MAPA (Ministerio de Agricultura y Alimentación). 2020. El sector de la avicultura de carne en cifras. Principales Indicadores Económicos 2019. Dirección General De Producciones Y Mercados Agrarios. Available at https://www.mapa.gob.es/es/ganaderia/estadisticas/indicadores2019carneparapublicar_tcm30-419674.pdf.

Mohd Shaufi, M. A., C. C. Sieo, C. W. Chong, H. M. Gan, and Y. W. Ho. 2015. Deciphering chicken gut microbial dynamics based on high-throughput 16S rRNA metagenomics analyses. *Gut Pathog.* 7:1–12.

Montoro-Dasi, L., A. Villagra, M. de Toro, M. T. Pérez-Gracia, S. Vega, and C. Marin. 2020. Fast and Slow-Growing Management Systems: Characterisation of Broiler Caecal Microbiota Development throughout the Growing Period. *Animals* 10:1401.

Mottet, A., and G. Tempio. 2017. Global poultry production: Current state and future outlook and challenges. *Worlds. Poult. Sci. J.* 73:245–256.

OIE (World Organisation for Animal Health). 2019. World Organisation for Animal Health. Available at <https://www.oie.int/en/standard-setting/terrestrial-code/>.

Ocejo, M., B. Oporto, and A. Hurtado. 2019. 16S rRNA amplicon sequencing characterization of caecal microbiome composition of broilers and free-range slow-growing chickens throughout their productive lifespan. *Sci. Rep.* 9:1–14.

- Pandit, R. J., A. T. Hinsu, N. V. Patel, P. G. Koringa, S. J. Jakhesara, J. R. Thakkar, T. M. Shah, G. Limon, A. Psifidi, J. Guitian, D. A. Hume, F. M. Tomley, D. N. Rank, M. Raman, K. G. Tirumurugaan, D. P. Blake, and C. G. Joshi. 2018. Microbial diversity and community composition of caecal microbiota in commercial and indigenous Indian chickens determined using 16s rDNA amplicon sequencing. *Microbiome* 6:1–13.
- Paraskeuas, V., and K. C. Mountzouris. 2019. Broiler gut microbiota and expressions of gut barrier genes affected by cereal type and phytogetic inclusion. *Anim. Nutr.* 5:22–31.
- Ranjan, A., R. Sinha, I. Devi, A. Rahim, and S. Tiwari. 2019. Effect of Heat Stress on Poultry Production and their Managemental Approaches. *Int. J. Curr. Microbiol. Appl. Sci.* 8:1548–1555.
- Sassi, N. Ben, X. Averós, and I. Estevez. 2016. Technology and poultry welfare. *Animals* 6:1–21.
- Shang, Y., S. Kumar, B. Oakley, and W. K. Kim. 2018. Chicken gut microbiota: Importance and detection technology. *Front. Vet. Sci.* 5.
- Slawinska, A., S. Mendes, A. Dunislawska, M. Siwek, M. Zampiga, F. Sirri, A. Meluzzi, S. Tavaniello, and G. Maiorano. 2019. Avian model to mitigate gut-derived immune response and oxidative stress during heat. *BioSystems* 178:10–15.
- Soleimani, A. F., I. Zulkifli, M. Hair-Bejo, M. Ebrahimi, S. D. Jazayeri, S. R. Hashemi, A. Meimandipour, and Y. M. Goh. 2012. Epigenetic modification: possible approach to reduce *Salmonella enterica* serovar enteritidis susceptibility under stress conditions. *Avian Pathol.* 41:351–354.
- Song, J., K. Xiao, Y. L. Ke, L. F. Jiao, C. H. Hu, Q. Y. Diao, B. Shi, and X. T. Zou. 2014. Effect of a probiotic mixture on intestinal microflora, morphology, and barrier integrity of broilers subjected to heat stress. *Poult. Sci.* 93:581–588.
- Teirlynck, E., M. D. E. Gussem, J. Dewulf, F. Haesebrouck, R. Ducatelle, and F. van Immerseel. 2011. Morphometric evaluation of ‘dysbacteriosis’ in broilers. *Avian Pathol.* 40:139–144.

Thaxton, Y. V., K. D. Christensen, J. A. Mench, E. R. Rumley, C. Daugherty, B. Feinberg, M. Parker, P. Siegel, and C. G. Scanes. 2016. Symposium: Animal Welfare Challenges for Today and Tomorrow - PubMed. *Poult. Sci.* 95:2198–2207.

Tsiouris, V., I. Georgopoulou, C. Batzios, N. Pappaioannou, R. Ducatelle, and P. Fortomaris. 2018. Heat stress as a predisposing factor for necrotic enteritis in broiler chicks. *Avian Pathol.* 47:616–624.

Wang, J., L. T. Nesengani, Y. Gong, Y. Yang, and W. Lu. 2018. 16S rRNA gene sequencing reveals effects of photoperiod on cecal microbiota of broiler roosters. *PeerJ* 2.

Wei, S., M. Morrison, and Z. Yu. 2013. Bacterial census of poultry intestinal microbiome. *Poult. Sci.* 92:671–683.

Xi, Y., N. Shuling, T. Kunyuan, Z. Qiuyang, D. Hewen, G. ChenCheng, Y. Tianhe, L. Liancheng, and F. Xin. 2019. Characteristics of the intestinal flora of specific pathogen free chickens with age. *Microb. Pathog.* 132:325–334.

Yang, C., Q. Deng, J. Xu, X. Wang, C. Hu, H. Tang, and F. Huang. 2019. Sinapic acid and resveratrol alleviate oxidative stress with modulation of gut microbiota in high-fat diet-fed rats. *Food Res. Int.* 116:1202–1211.

3.2.1.8 Supplementary material

- **Table S7.** Statistical comparison of alpha diversity between sample groups based on Chao 1 index.
- **Table S8.** Statistical comparison of alpha diversity between sample groups based on Shannon index.
- **Table S9.** Statistical comparison of alpha diversity between sample groups based on Simpson index.
- **Table S10.** Statistical comparison of alpha diversity between sample groups based on Observed OTUs index.
- **Figure S1.** Evaluation of the beta-diversity in commercial and optimal farm conditions. A: Beta diversity represented by PCoA graphic for both farm conditions at all sampling times. B: Beta diversity represented by Heatmap for both farm conditions at all sampling times.
- **Table S11.** Statistical comparison between beta diversity indexes calculated according the different methods.

Table S7. Statistical comparison of alpha diversity between sample groups based on Chao 1 index.

Group 1	Group 2	Group 1 mean	Group 1 std	Group 2 mean	Group 2 std	t stat	P-value
OFC E	AD	484.78	4.27	99.61	12.15	83.56	0.0
CFC MP	AD	417.51	7.43	99.62	12.15	58.25	0.0
CFC E	AD	478.83	4.96	99.62	12.15	79.56	0.0
OFC MP	AD	417.99	5.71	99.62	12.15	64.23	0.0
OFC MP	CFC MP	417.99	5.71	417.51	7.43	0.16	0.88
CFC E	CFC MP	478.84	4.97	417.51	7.43	20.59	3.19E-13
OFC E	OFC MP	484.78	4.27	417.99	5.71	28.09	2.09E-15
OFC E	CFC MP	484.78	4.27	417.50	7.43	23.55	3.46
CFC E	OFC MP	478.83	4.96	417.99	5.71	24.12	2.49E-14
CFC E	OFC E	478.83	4.96	484.72	4.27	-2.72	0.02

AD: arrival day; CFC MP: commercial farm conditions at mid period; OFC MP: optimal farm conditions at mid period; CFC E: commercial farm conditions at the end of the growing period; OFC E: optimal farm conditions at the end of the growing period.

Table S8. Statistical comparison of alpha diversity between sample groups based on Shannon index.

Group 1	Group 2	Group 1 mean	Group 1 std	Group 2 mean	Group 2 std	t stat	P-value
OFC E	AD	6.48	0.11	1.79	0.09	74.92	0.0
CFC MP	AD	6.07	0.30	1.79	0.09	29.15	4.14
CFC E	AD	6.36	0.14	1.79	0.09	62.06	0.0
OFC MP	AD	6.25	0.32	1.79	0.09	28.13	4.67
OFC MP	CFC MP	6.25	0.32	6.07	0.30	1.23	0.29
CFC E	CFC MP	6.36	0.14	6.07	0.30	2.64	0.03
OFC E	OFC MP	6.48	0.11	6.25	0.32	1.97	0.10
OFC E	CFC MP	6.48	0.11	6.07	0.30	3.81	0.0
CFC E	OFC MP	6.36	0.14	6.25	0.32	0.93	0.42
CFC E	OFC E	6.36	0.14	6.48	0.11	-1.92	0.11

AD: arrival day; CFC MP: commercial farm conditions at mid period; OFC MP: optimal farm conditions at mid period; CFC E: commercial farm conditions at the end of the growing period; OFC E: optimal farm conditions at the end of the growing period.

Table S9. Statistical comparison of alpha diversity between sample groups based on Simpson index.

Group 1	Group 2	Group 1 mean	Group 1 std	Group 2 mean	Group 2 std	t stat	P-value
OFC E	AD	0.96	0.01	0.55	0.03	37.28	4.40E-13
CFC MP	AD	0.93	0.02	0.55	0.03	25.72	1.71E-11
CFC E	AD	0.96	0.01	0.55	0.03	36.31	3.08E-13
OFC MP	AD	0.94	0.03	0.55	0.03	23.18	4.84E-11
OFC MP	CFC MP	0.94	0.03	0.93	0.02	1.06	0.43
CFC E	CFC MP	0.96	0.01	0.93	0.02	3.82	0.0
OFC E	OFC MP	0.96	0.01	0.94	0.03	2.03	0.09
OFC E	CFC MP	0.96	0.01	0.93	0.02	4.27	0.0
CFC E	OFC MP	0.96	0.01	0.94	0.03	1.72	0.16
CFC E	OFC E	0.96	0.01	0.96	0.01	-0.90	0.51

AD: arrival day; CFC MP: commercial farm conditions at mid period; OFC MP: optimal farm conditions at mid period; CFC E: commercial farm conditions at the end of the growing period; OFC E: optimal farm conditions at the end of the growing period.

Table S10. Statistical comparison of alpha diversity between sample groups based on Observed OTUs index.

Group 1	Group 2	Group 1 mean	Group 1 std	Group 2 mean	Group 2 std	t stat	P-value
OFC E	AD	473.47	5.85	55.68	4.24	132.33	0.0
CFC MP	AD	409.23	8.54	55.68	4.24	81.33	0.0
CFC E	AD	468.05	4.14	55.68	4.24	167.86	0.0
OFC MP	AD	410.0	5.92	55.68	4.24	111.18	0.0
OFC MP	CFC MP	410.0	5.92	409.23	8.54	0.22	0.84
CFC E	CFC MP	468.05	4.14	409.23	8.54	18.59	1.72E-12
OFC E	OFC MP	473.47	5.85	410.0	5.92	22.88	6.16E-14
OFC E	CFC MP	473.47	5.85	409.23	8.54	18.62	1.81E-12
CFC E	OFC MP	468.05	4.14	410.0	5.92	24.10	2.77E-14
CFC E	OFC E	468.05	4.14	473.47	5.85	-2.27	0.04

AD: arrival day; CFC MP: commercial farm conditions at mid period; OFC MP: optimal farm conditions at mid period; CFC E: commercial farm conditions at the end of the growing period; OFC E: optimal farm conditions at the end of the growing period.

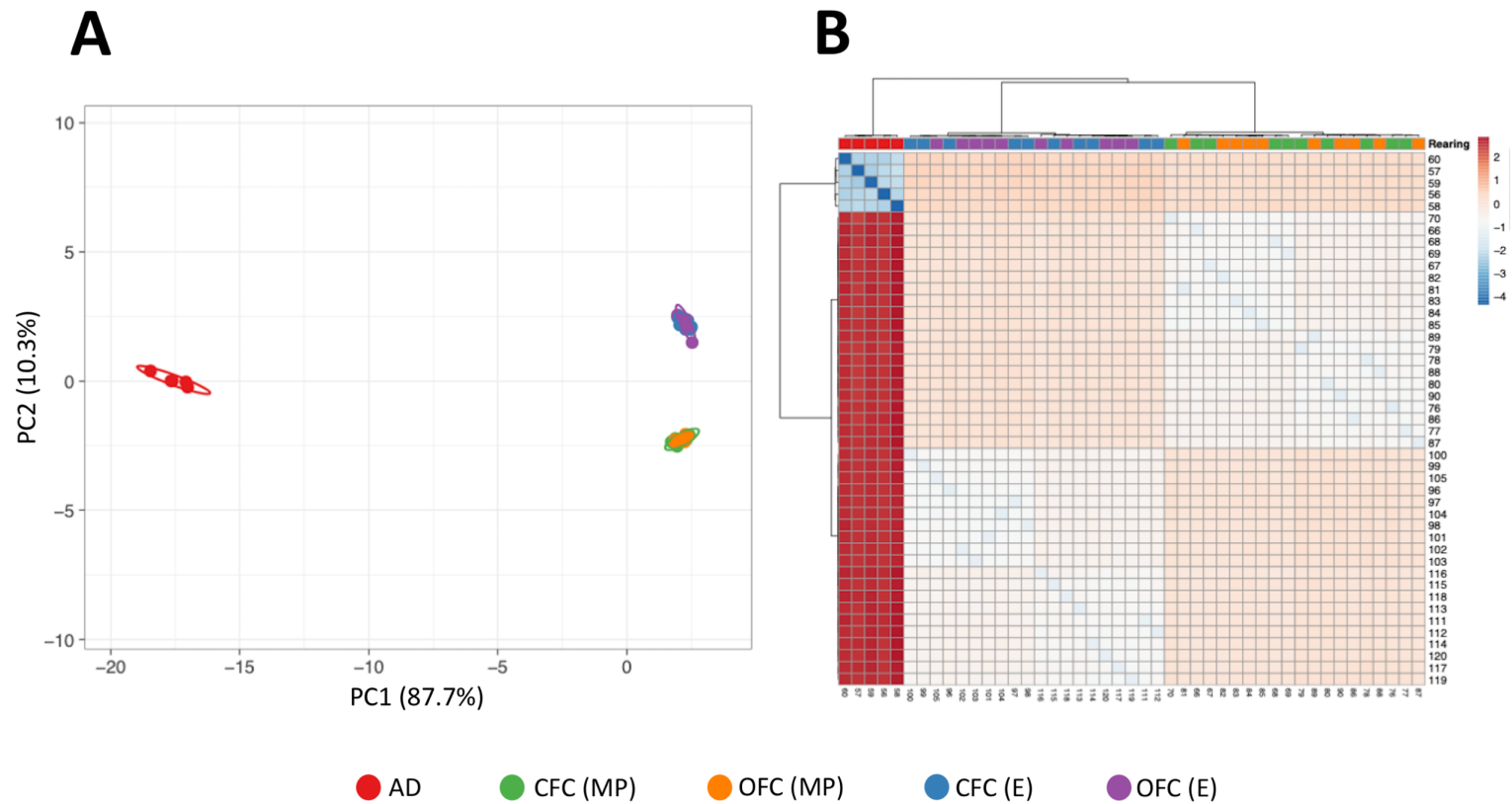

Figure S1. Evaluation of the beta-diversity in commercial and optimal farm conditions. A: Beta diversity represented by PCoA graphic for both farm conditions at all sampling times. B: Beta diversity represented by Heatmap for both farm conditions at all sampling times. AD: arrival day; CFC (MP): Commercial farm conditions at mid period; OFC (MP): Optimal farm conditions at mid period; CFC (E): Commercial farm conditions at the end of the growing period; OFC (E): Optimal farm conditions at the end of the growing period.

Table S11. Statistical comparison between beta diversity indexes calculated according the different methods.

Beta-diversity matrix	Adonis test			ANOSIM	
	F-stat	R²	P-value	Statistic value	P-value
Bray-Curtis	54.586	0.84517	0.001	0.67777631578947362	0.001
Unweighted-Unifrac	38.876	0.79540	0.001	0.6668026315789474	0.001
Weighted-Unifrac	100.17	0.90923	0.001	0.688736842105263	0.001

3.2.2 Commensal *Escherichia coli* antimicrobial resistance and multidrug-resistance dynamics during broiler growing period: commercial vs. improved farm conditions.

L. Montoro-Dasi, A. Villagra, S. Sevilla-Navarro, M.T. Pérez-Gracia, S. Vega, C. Marin. 2021. Commensal *Escherichia coli* antimicrobial resistance and multidrug-resistance dynamics during broiler growing period: commercial vs. improved farm conditions. *Animals*. 11:1005. doi: 10.3390/ani11041005.

3.2.2.1 Abstract

New measures applied to reduce AMR at field level in broiler production are focused on improving animals' welfare and resilience. However, it is necessary to have better knowledge of AMR epidemiology. Thus, the aim of this study was to evaluate AMR and MDR dynamics during the rearing of broilers under commercial (33 kg/m² density and max. 20 ppm ammonia) and improved (17 kg/m² density and max. 10 ppm ammonia) farm conditions. Day-old chicks were housed in two poultry houses (commercial vs. improved), and no AMA agents were administered at any point. Animals were sampled at arrival day, mid-period and at slaughter day. High AMR rates were observed throughout rearing. No statistical differences were observed between groups. Moreover, both groups presented high MDR at slaughter day. These results could be explained by vertical or horizontal resistance acquisition. In conclusion, AMR and MDR are present throughout rearing. Moreover, although a lower level of MDR was observed at mid-period in animals reared under less intensive conditions, no differences were found at the end. In order to reduce the presence of AMR bacteria in poultry, further studies are needed to better understand AMR acquisition and prevalence in differing broiler growing conditions.

3.2.2.2 Introduction

AMR is one of the most significant threats to public health worldwide. Indeed, the WHO published that by 2050, if effective interventions against the increase in AMR are not carried out, there could be more than 10 million deaths annually as a result of such resistance (WHO, 2019). Increased awareness of the health threats related to AMR has resulted in greater social demand for antibiotic-free food production, especially antibiotic-free meat, in recent years (Marshall and Levy, 2011; Chang *et al.*, 2015; Horigan *et al.*, 2016; Liu *et al.*, 2016; Founou *et al.*, 2016; Sharma *et al.*, 2018).

The EMA reported that Spain has been the European country with the highest consumption of AMAs since data became available (ESVAC database, n.d.). In this sense, it is claimed that the uncontrolled administration of AMAs in the past, as treatment for infectious diseases or as a growth promoter, has resulted in an increased MDR presence in the food chain (Aarestrup, 2015; Khurana *et al.*, 2017; EFSA and ECDC, 2020). In fact, the notable prevalence of colistin resistance is particularly worrying, due to its widespread use in veterinary medicine over many years, as it is a last-resort AMA reserved to treat MDR bacterial infections in human medicine (Apostolakis and Piccirillo, 2018).

However, due to the strict control of AMA administration since the National AMR Plan was established in 2014, their consumption in animal production has halved (EMA, 2020). Specifically, between 2015 and 2019, in poultry a reduction of 71% in total AMA administration has been reported, along with a 95% falloff in colistin administration during 2019, recording the largest European drop in consumption of critical AMAs (PRAN, 2020).

These data are the result of the efforts carried out by the poultry sector to reduce AMA administration at field level. Firstly, by avoiding the entry and spread of pathogen microorganisms, improving biosecurity, farm management and vaccination protocols (Rojo-Gimeno *et al.*, 2016); and secondly, by investing in more accurate and animal-friendly management systems, achieving animals with a strengthened immune system and more resilient to contact with infectious agents (Soleimani *et al.*, 2012b; Gomes *et al.*, 2014; Rouger *et al.*, 2017; Swaggerty *et al.*, 2019). To this end, the use of alternative production systems has been promoted, focused on slow-growing breeds selected for their

ability to deal with the natural environment (Montoro-Dasi *et al.*, 2020a), and the implementation of less intensive production systems, more sustainable and animal-welfare-friendly, but also maintaining the profitability of broiler farms (Gocsik *et al.*, 2016; El-Deek and El-Sabrout, 2019).

However, to be able to assess the effectiveness of these measures, it is necessary to have better knowledge of the epidemiology of AMR throughout the growing period under different farm conditions (Sirri *et al.*, 2011; Lusk, 2018). For this purpose, commensal *Escherichia coli* has typically been selected as AMR sentinel, as it provides valuable data and constitutes a reservoir of resistance genes, which can spread to zoonotic and other bacteria (Montoro-Dasi *et al.*, 2020a; EFSA and ECDC, 2019).

Nevertheless, further studies are still needed to achieve more resilient animals to ensure that AMA administration continues to decrease at field level. In this context, the aim of this study was to evaluate the AMR and MDR dynamics in broiler chickens during the rearing period under two different management conditions (commercial *vs.* improved), using *E. coli* as sentinel bacterium.

3.2.2.3 Material and methods

In this experiment, animals were handled according to the principles of animal care published by Spanish Royal Decree 53/2013 (BOE, 2013). Moreover, all protocols were approved by the Ethical Review Panel of the Directorate-General for Agriculture, Fisheries and Livestock from the Valencian Community, by the code 2018/VSC/PEA/0067.

3.2.2.3.1 Experiment design

The study was carried out in an experimental poultry farm at the CITA-IVIA. The cleaning and disinfection protocol applied in the poultry farm was according to the Kersia Group protocol (Kersia Group, n.d.). The product used to clean the poultry houses was Hyprelva Net Plus (Hypred S.L., Orcoyen, Spain), and the product employed to disinfect them was Virobacter (Hypred S.L., Orcoyen, Spain). Finally, the product used to disinfect the pipelines was Deptal SMP 5% (Hypred S.L., Orcoyen, Spain).

A total of 1062 day-old-chicks (Ross®) (males and females) were housed in two identical poultry houses (531 animals in each house). Within each of the houses, 204 animals were located in 12 pens and the rest of them (327) were on the floor out of the pens, all with wood shavings as bedding material. Moreover, two different management conditions were evaluated: commercial farm conditions (CFC, house 1) and improved farm conditions (IFC, house 2). In house 1 (CFC) animals were kept at 33 kg/m² density and non-optimal parameters of ventilation were applied (allowing a maximum concentration of ammonia of 20 ppm), while in house 2 (IFC) chicks were kept at 17 kg/m² density and ventilation was provided within the optimal parameters (allowing a maximum concentration of ammonia of 10 ppm). Ammonia concentration was continuously measured from the air, using a Exafan climatic sensor DOL 53, installed near the outlet to obtain representative values of the room concentrations. Moreover, both houses were equipped with programmable electrical lights, automated electric heating and forced ventilation. The lighting programme was decreasing from 23L:1D on the arrival day to 16L:8D from day 15 to the end of the growing period. Light intensity was guaranteed at least 20 lux in all parts of the farm at the height of the animals, and the light was provided through white bulb lamps uniformly distributed throughout the poultry house. The environmental temperature was set at 32 °C on arrival day and gradually reduced to 19 °C by 41 days post hatch in line with common practice in poultry production.

Day-old chicks were vaccinated in the hatchery against Gumboro disease, Marek disease, and Infectious Bronchitis (IBV). During the growing period, no vaccines were administered.

Animals received drinking water and were fed *ad libitum*, feed was weighed and distributed manually. Two different age commercial diets were used to meet animals' metabolic requirements (Table 12): from arrival day until 21 days post hatch, a pelleted starter diet was offered to the birds (Camperbroiler iniciación, Alimentación Animal Nanta, Valencia, Spain), and from 21 days old until slaughter day they were fed a pelleted grower diet (A-32 broiler, Alimentación Animal Nanta, Valencia, Spain). Nutritional and product analysis were assessed before the arrival of animals and only one batch of feed per age was manufactured. Moreover, no coccidiostats or AMAs were added to either diet, and high biosecurity levels were maintained in the experimental poultry house

during the rearing. Finally, the mortality rates and presence of diarrhoea were registered daily, and animals' weight and feed consumption were recorded at weekly intervals.

Table 12. Composition of starter and grower diets.

Analytical constituents	Diet	
	Starter (d 1-21) (%)	Grower (d22-42) (%)
Crude fat	3.5	3.1
Crude protein	20.5	19.4
Crude fibre	2.6	3.1
Crude ash	6.6	5.0
Lysine	1.14	1.13
Methionine	0.62	0.51
Calcium	1.00	0.78
Phosphorus available	0.69	0.51
Sodium	0.15	0.14
Ingredients	Corn, soy flour, wheat, soy oil, calcium carbonate, monocalcium phosphate, sodium chloride	Corn, soy flour, rice bran, calcium carbonate, sodium chloride

Starter (%): percentage of analytical constituents for starter diet, Grower FG (%): percentage of analytical constituents for grower diet.

3.2.2.3.2 Sample collection

To evaluate the dynamic of AMR rates in the microbiota of broilers throughout the growing period, commensal *E. coli* was selected as sentinel bacterium (EFSA and ECDC, 2019; Montoro-Dasi *et al.*, 2020).

For this purpose, animals were randomly selected from each experimental group and caeca samples were collected. Three different sampling moments were established: at arrival (day-old chicks), at the mid-period (21 days old) and at the end of the production cycle (42 days of age). On arrival day, animals were selected and sampled just before being delivered to the houses (30 samples). Then, caecal samples were collected per each treatment (60 samples farm condition/house). Caeca were taken individually and placed in sterile jars. Samples were processed within 24h after collection.

3.2.2.3.3 *E. coli* isolation

First, caecal content was removed and homogenised. Then, pools of six animals from the same experimental group were prepared: 5 pools from day-old-chicks (30 samples), 10 pools from animals in CFC at mid-period (60 samples), 10 from animals in IFC at mid-period (60 samples), 10 pools from animals in CFC at the end of the growing period (60

samples) and 10 pools from animals in IFC at the end of the growing period (60 samples). Pools content was cultured directly onto a Coliform Chromogenic agar (Scharlab, S.L., Barcelona, Spain) in duplicate, and agar plates were incubated at 37 ± 1 °C for 24 hours. After incubation, suspected colonies were streaked onto a nutrient medium (Scharlab, S.L., Barcelona, Spain) and incubated at 37 ± 1 °C for 24 hours. Then, API-20E test (Biomérieux, S.L., Barcelona, Spain) was performed to confirm *E. coli*.

3.2.2.3.4 Antimicrobial susceptibility testing

The protocol established to study the antimicrobial susceptibility of the isolates was according to Montoro-Dasi *et al.* (2020) (Montoro-Dasi *et al.*, 2020a). Briefly, the bacteria were inoculated onto Mueller-Hinton agar (Scharlab, S.L., Barcelona, Spain) and the AB discs were added. Plates were incubated at 37 ± 1 °C for 24h. The analysis was carried out according to EUCAST guidelines (Matuschek *et al.*, 2014) and the source for zone diameters used for interpretation of the test was: http://www.eucast.org/clinical_breakpoints/. The AMAs selected were those set forth in Decision 652/2013 (EC, 2013), including CIP (5 µg), NAL (30 µg), AMP (10 µg), CTX (30 µg), CAZ (30 µg), CHL (5 µg), SXT (1.25/23.75 µg), CST (10 µg), AZM (15 µg), TGC (15 µg), GEN (10 µg), and TMP (5 µg). MDR was defined as acquired resistance to at least one agent in three or more antimicrobial classes (EFSA and ECDC, 2019; Montoro-Dasi *et al.*, 2020).

3.2.2.3.5 Statistical analysis

Statistical Analysis was performed according to Montoro-Dasi *et al.* 2020 [20]. A GLM test was used to compare the AMR and MDR rates between farm conditions (CFC vs. IFC) and between sampling moments (arrival day, mid-period and slaughter day). To do so, we fitted GLM where the occurrence of resistance was the response variable, and experimental group was the fixed effect. For this analysis, the error was designated as having a binomial distribution and the probit link function was used. Binomial data for each sample were assigned a 1 if the *E. coli* isolates were resistant or a 0 if not. Similarly, AMR rates of each antibiotic throughout the growing period (arrival day, mid-period and slaughter day) were evaluated, using a GLM as previously. A *p*-value of <0.05 was considered to indicate a statistically significant difference. Analyses were carried out

using a commercially available software application (SPSS 24.0 software package; SPSS Inc., Chicago, IL, 2002).

3.2.2.4 Results

During this experiment, all the productive parameters, including mortality rates, animals' weight, feed intake and feed conversion rate (Table 13), were according to the breed standards (Aviagen, 2019) and no intestinal signs or disease were observed. Thus, no AMAs were administered. In this study, a total of 45 pools of cecal content were analysed in duplicate, and all of them were culture positive for *E. coli* (n=90).

Table 13. Mortality rate (MR), body weight (BW), feed intake (FI) and feed conversion rate (FCR) of the animals for both experimental groups: Commercial farm conditions (CFC) and improved farm conditions (IFC), throughout the growing period.

Days of life	CFC				IFC			
	MR (%)	BW (g)	FI (Kg)	FCR	MR (%)	BW (g)	FI (Kg)	FCR
7	1.47	157.73	0.13	1.19	0.98	160.42	0.13	1.12
14	0.50	413.17	0.37	1.35	1.49	428.59	0.36	1.38
21	0	788.25	0.71	2.02	0	789.15	0.67	1.89
28	0	1234.59	1.17	2.66	0	1233.51	1.09	2.46
35	0	1810.06	1.45	2.54	0	1788.30	1.27	2.27
42	0	2471.14	1.51	2.25	0	2461.13	1.36	2.09

3.2.2.4.1 Prevalence of antimicrobial resistance and multidrug-resistance

From all *E. coli* isolates, 83.3% (n=75/90) were resistant to at least one of the 12 AMAs tested, and no statistically significant differences were found between replicates. In addition, no statistically significant differences were found between the percentage of resistant *E. coli* strains isolated from the two sampling groups (CFC vs. IFC) (P -value>0.05) (Figure 26).

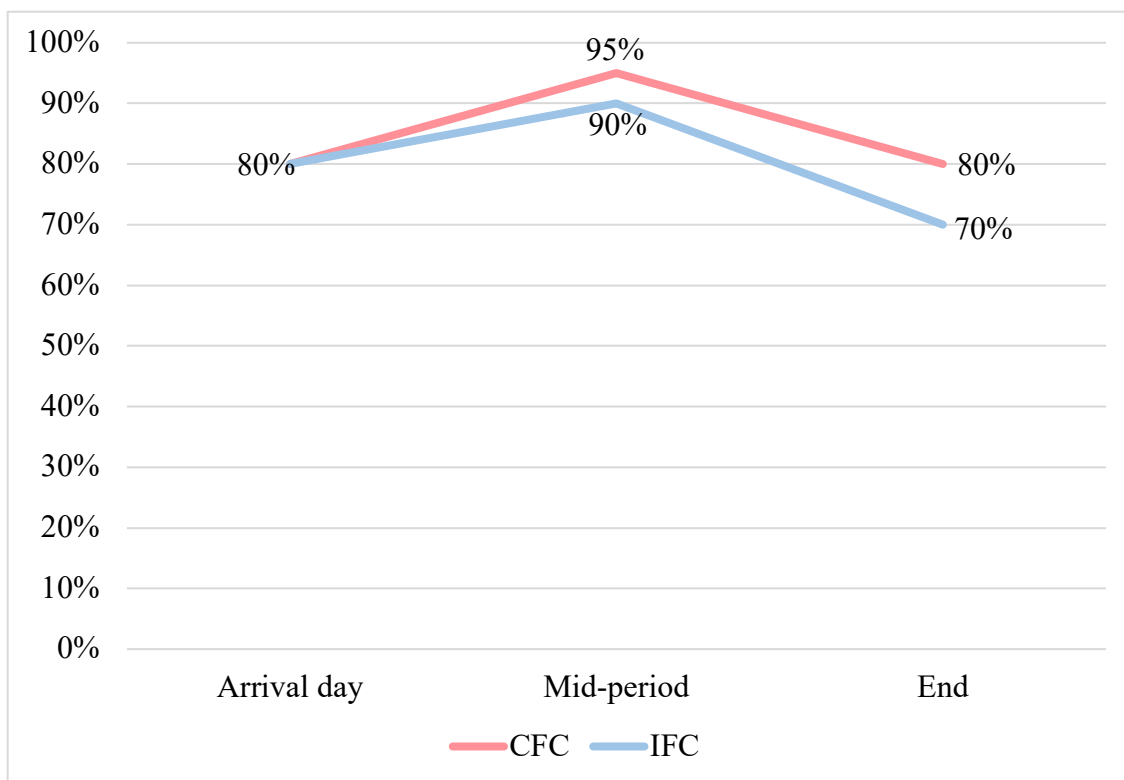

Figure 26. Antimicrobial-resistant *E. coli* isolates dynamic for commercial (CFC) and improved farm conditions (OFC) throughout the growing period. No statistically significant differences were observed.

Furthermore, 57.3% of the resistant isolates ($n=43/75$) showed a MDR pattern, with statistically significant differences between experimental groups (Figure 27). At the onset of the growing period, 62.5% of the isolates ($n=5/8$) were MDR. For CFC, similar rates were maintained until the end of rearing, with a total of 68.8% ($n=11/16$) and 57.9% ($n=11/19$) of MDR isolates at mid-period and on slaughter day, respectively. However, for IFC group there were statistically significant differences between sampling moments (P -value <0.05): mid-period samples (14.3%, $n=2/14$) displayed a lower level of MDR isolates than those obtained from animals at end of the growing period (77.8%, $n=14/18$). Moreover, when the percentages of MDR were analysed between experimental groups, statistically significant differences were found at mid-period (P -value <0.05).

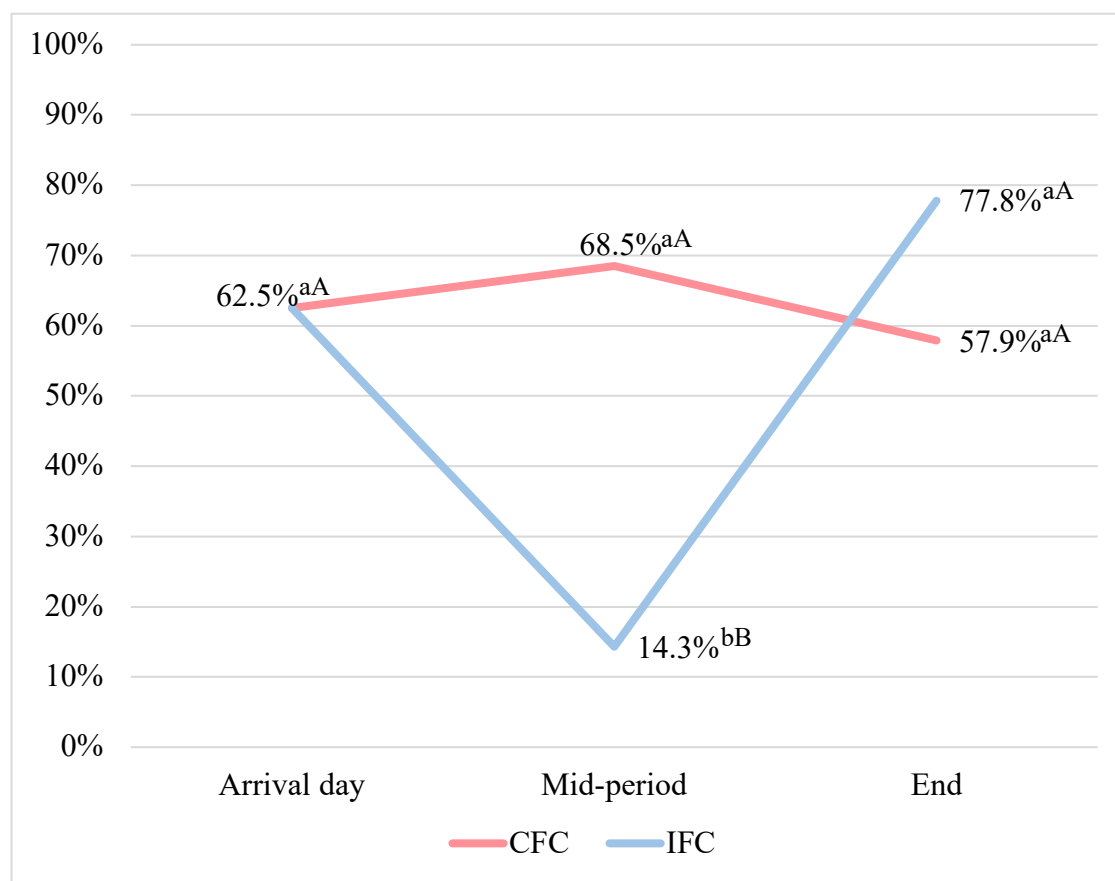

Figure 27. Multidrug-resistant *E. coli* isolates dynamic for commercial (CFC) and optimal farm conditions (IFC) throughout the growing period. ^{a,b}: Different superscripts means significant differences within group with a P -value <0.05 . ^{A,B}: Different superscripts means significant differences between groups with a P -value <0.05 .

E. coli AMR rates obtained against the different AMAs tested over time for both experimental groups are described in Table 14.

Table 14. Antimicrobial resistance rates obtained for each antibiotic in different sampling moments and experimental groups (commercial vs. improved farm conditions) throughout the growing period.

Experimental group	Sampling moment	n	CIP	NAL	CTX	CAZ	AMP	CHL	SXT	CST	AZM	TGC	GEN	TMP
CFC	Arrival day	10	70 ^b	70	0	0	50	0	30 ^{ab}	0 ^b	0 ^b	0	30 ^{bc}	40 ^a
	Mid-period	20	60 ^b	75	0	0	30	0	55 ^a	0 ^b	0 ^b	0	10 ^c	55 ^a
	End	20	60 ^b	65	0	2	45	0	10 ^b	60 ^a	1 ^{ab}	0	75 ^a	60 ^a
IFC	Arrival day	10	70 ^b	70	0	0	50	0	30 ^{ab}	0 ^b	0 ^b	0	30 ^{bc}	40 ^a
	Mid-period	20	30 ^a	55	0	0	20	0	10 ^b	0 ^b	0 ^b	0	15 ^c	10 ^b
	End	20	50 ^b	65	0	4	35	0	35 ^a	45 ^a	5 ^a	0	65 ^{ab}	55 ^a

^{a,b,c}: Different superscripts in each antibiotic means significant differences with a p -value<0.05. n: total of isolates from each experimental group in each sampling moment. CFC: Commercial farm conditions, IFC: Improved farm conditions, CIP: Ciprofloxacin, NAL: Nalidixic acid, AMP: Ampicillin, CTX: Cefotaxime, CAZ: Ceftazidime, CHL: Chloramphenicol, SXT: Trimethoprim-sulfamethoxazole, CST: Colistin, AZM: Azithromycin, TGC: Tigecycline, GEN: Gentamycin, TMP: Trimethoprim.

3.2.2.4.2 Antimicrobial resistance patterns

AMR patterns are described in Figure 28. At the arrival day, 20% (n=2) of the isolates were susceptible to all the AMAs tested, 10% (n=1) of the isolates were resistant to only 1 AMA, 20% (n=2) to 2, 20% (n=2) to 4, 20% (n=2) to 5, and 10% (n=1) to 6.

For CFC, 25% (n=5) of the isolates were completely susceptible, 2.5% (n=1) were resistant to one of the 12 AMAs tested, 10% (n=4) to 2, 15% (n=6) to 3, 32.5% (n=13) to 4, 10% (n=4) to 5, 5% (n=2) to 6, and only 2.5% (n=1) were resistant to 8 of the AMAs tested.

Finally, for IFC, 20% (n=8) of the *E. coli* isolates were susceptible to all the AMAs analysed, 22.5% (n=9) of the isolates were resistant to 1 AMA, 10% (n=4) to 2, 15% (n=6) to 3, 17.5% (n=7) to 4, 7.5% (n=3) to 5, 5% (n=2) to 6, and only 2.5% (n=1) were resistant to 8 of the AMAs tested.

Overall, 34 different resistant patterns were observed, and the most prevalent were GEN (n=8), CIP-NAL-SXT-TMP (n=8), NAL (n=6), CIP-NAL (n=6), CIP-NAL-GEN-TMP (n=5) and CIP-NAL-AMP-SXT-TMP (n=5).

Group	n	Number of AMR to the indicated number of antibiotics								
		0	1	2	3	4	5	6	7	8
AD	10	2	1	2	0	2	2	1	0	0
CFC	40	5	5	4	6	13	4	2	0	1
IFC	40	8	9	4	6	7	3	2	0	1
Total	90	15	15	10	12	22	9	5	0	2
		AMP (1) GEN (8) NAL (6)								
		AMP-GEN (2) CIP-NAL (6) NAL-AMP (1) NAL-GEN (1)								
		AMP-AZM-GEN (1) AMP-SXT-TMP (1) CAZ-AZM-GEN (1) CIP-NAL-AMP (3) CIP-NAL-GEN (3) CIP-NAL-TMP (2) NAL-AMP-SXT (1)								
		AMP-AZM-GEN-TMP (1) AMP-SXT-GEN-TMP (1) CIP-NAL-AMP-GEN (1) CIP-NAL-AMP-TMP (3) CIP-NAL-CAZ-TMP (1) CIP-NAL-GEN-TMP (5) CIP-NAL-SXT-TMP (8) NAL-AMP-GEN-TMP (1) NAL-AMP-SXT-TMP (1)								
		CIP-NAL-AMP-GEN-TMP (2) CIP-NAL-AMP-SXT-TMP (5) CIP-NAL-SXT-GEN-TMP (2)								
		CIP-NAL-AMP-SXT-GEN-TMP (3) CIP-NAL-CAZ-AMP-GEN-TMP (1) NAL-CAZ-SXT-AZM-GEN-TMP (1)								
		CIP-NAL-CAZ-AMP-SXT-AZM-GEN-TMP (2)								

Figure 28. Number of *E. coli* strains isolated resistant to the different number of antimicrobials tested and their antimicrobial resistance pattern, according to commercial (CFC) and improved (IFC) farm conditions. n: Total isolates from each experimental group. AMR: Antimicrobial resistances. CFC: Commercial farm conditions; IFC: Improved farm conditions; CIP: Ciprofloxacin, NAL: Nalidixic acid, AMP: Ampicillin, CTX: Cefotaxime, CAZ: Ceftazidime, CHL: Chloramphenicol, SXT: Trimethoprim-sulfamethoxazole, CST: Colistin, AZM: Azithromycin, TGC: Tigecycline, GEN: Gentamycin, TMP: Trimethoprim.

3.2.2.5 Discussion

Despite the fact that no AMAs were administered during the experiment, it was observed that 83.3% of *E. coli* isolates obtained were AMR, and 57.3% of them were MDR, with slight variations between sampling moments. These data are in line with those reported by the last EFSA report (EFSA and ECDC, 2020), and could be explained by a vertical or a horizontal resistance acquisition from breeders (Osman *et al.*, 2018; Marin *et al.*, 2020) or the environment (Oikarainen *et al.*, 2019; Montoro-Dasi *et al.*, 2020a), respectively.

At the beginning of the study, on arrival day, the animals presented 80% of resistant *E. coli* isolates, and 62.5% of them were MDR. These results show the importance of AMR and MDR acquired from breeding, hatching or transport environment (Poulsen *et al.*, 2017; Dame-Korevaar *et al.*, 2019). It has been reported that day-old chicks could be colonised by direct vertical transmission through breeders' microbiota (Nilsson *et al.*, 2014) or by the resistant bacteria persistent in the hatchery or on delivery transport surfaces (Projahn *et al.*, 2017, 2018; Oikarainen *et al.*, 2019), being an important threat requiring strict management control in the initial stages to reduce the selective AMR/MDR pressure on breeders, hatcheries and farm environments (Dierikx *et al.*, 2013; Aarestrup, 2015).

Among the most relevant results observed in the dynamics of AMAs studied, the highest resistances were observed against ciprofloxacin, nalidixic acid and ampicillin, in line with results reported by the EFSA (EFSA and ECDC, 2020). It is important to highlight the absence of bacteria resistant to colistin and trimethoprim, as they are critically important AMAs, reserved to treat serious infections caused by MDR bacteria in human medicine (WHO, 2019). These results reveal that the strategies implemented by governments and poultry industry to control the use of critical AMAs, such as 'stop-colistin', are having an important effect at field level (WHO, 2011). In line with these findings, further efforts are needed to achieve a greater decrease in the use of other AMAs.

Moreover, in this study at the end of the growing period, resistant bacteria to ceftazidime and azithromycin appeared, and the resistant bacteria to gentamycin and tigecycline increased. This could be explained due to an horizontal transmission of resistance genes from the environment, which is considered a critical point in livestock production. Several

authors demonstrated that horizontal transmission of resistances from the environment could be more important than vertical transmission in broiler production (Oikarainen *et al.*, 2019). In fact, previous studies demonstrated that residual faeces or dust are important reservoirs for resistant bacteria and AMR genes between different flocks in commercial farms, due to the high survival of resistant microorganisms after cleaning and disinfection procedures (Marin *et al.*, 2011; Davies and Wales, 2019; Chuppava *et al.*, 2019; Luiken *et al.*, 2020), the application of proper cleaning and disinfection protocols being mandatory to avoid the survival of bacteria (Carrique-Mas *et al.*, 2009; Maertens *et al.*, 2019).

In this regard, it is demonstrated that an increase in animal welfare promotes the presence of beneficial microbiota and the integrity of the intestinal epithelium. As a consequence, the protective mechanisms are working perfectly and the interactions between environmental and intestinal bacteria are reduced. In contrast, stress situations such as the arrival to new facilities or the high-density levels presented at the end of the growing period reduce the effectiveness of these protective mechanisms, increasing the colonisation of potential pathogens and resistant bacteria to the intestinal tract of broilers, increasing interactions and transmission of resistant genes (Burkholder *et al.*, 2008; Dawkins, 2019; He *et al.*, 2019; Mandal *et al.*, 2020). In this sense, animal welfare could be considered as preventive medicine, promoting immunologically stronger animals that are better able to cope with infectious diseases without AMAs administration (Burbarelli *et al.*, 2015; Rojo-Gimeno *et al.*, 2016; Dawkins, 2019). However, in this study it has been observed that although animals subjected to less intensive production conditions showed a lower level of MDR at mid-period, at the end of the growing stage the presence of AMR and MDR were particularly high, regardless of the poultry being under less or more intensive conditions, at around 70% and 77.8%, respectively. This fact could be explained by the high AMR rates at the arrival day, and the short time of rearing (42 days), highlighting the importance of controlling the use of AMAs in the first stages of poultry production system (Dierikx *et al.*, 2013). In addition, it is important not to forget that at the end of the growing period, when the highest levels of AMR have been observed, animals are handled for transport to the slaughterhouse, which could involve an increase in stress, intestinal dysbiosis and excretion of microorganisms in faeces just before processing of the carcasses, constituting an important threat to consumers (Marin and Lainez, 2009; Gregova *et al.*, 2012; Althaus *et al.*, 2017; Sevilla-Navarro *et al.*, 2020).

Therefore, it is essential to develop more accurate and cost-effective techniques to be applied at farm level to avoid the presence of AMR and MDR microorganisms upon arrival at the slaughterhouse.

3.2.2.6 Conclusion

In conclusion, AMR and MDR are present throughout the growing period, although no AMAs were administered. Moreover, although a lower level of MDR was observed at mid-period in animals reared under less intensive farm conditions, no differences were found between the two experimental groups at the end of the growing period. For this reason, further studies are needed to evaluate how management could reduce the presence of AMR and MDR bacteria in poultry production at all production stages.

3.2.2.7 References

Aarestrup, F. M. 2015. The livestock reservoir for antimicrobial resistance: A personal view on changing patterns of risks, effects of interventions and the way forward. *Philos. Trans. R. Soc. B Biol. Sci.* 370.

Althaus, D., C. Zweifel, and R. Stephan. 2017. Analysis of a poultry slaughter process: Influence of process stages on the microbiological contamination of broiler carcasses. *Ital. J. Food Saf.* 6:190–194.

Apostolakos, I., and A. Piccirillo. 2018. A review on the current situation and challenges of colistin resistance in poultry production. *Avian Pathol.* 47:546–558.

Aviagen. 2019. Ross 308: Broiler Performance Objectives. Aviagen Inc., Huntsville, AL. Available at <https://en.aviagen.com/brands/ross/products/ross-308>.

BOE (Boletín Oficial del Estado). Spain. Royal Degree 53/2013, 1st of February 2013, por el que se establecen las normas básicas aplicables para la protección de los animales utilizados en experimentación y otros fines científicos, incluyendo la docencia. Available at https://www.boe.es/diario_boe/txt.php?id=BOE-A-2013-1337.

Burbarelli, M. F. C., C. E. B. Merseguel, P. A. P. Ribeiro, K. D. Lelis, G. V. Polycarpo, A. C. P. Carão, R. A. Bordin, A. M. Fernandes, R. L. M. Souza, M. E. G. Moro, and R. Albuquerque. 2015. The effects of two different cleaning and disinfection programs on broiler performance and microbiological status of broiler houses. *Rev. Bras. Cienc. Avic.* 17:575–580.

Burkholder, K. M., K. L. Thompson, M. E. Einstein, T. J. Applegate, and J. A. Patterson. 2008. Influence of stressors on normal intestinal microbiota, intestinal morphology, and susceptibility to *Salmonella* Enteritidis colonization in broilers. *Poult. Sci.* 87:1734–1741.

Carrique-Mas, J. J., C. Marín, M. Breslin, I. McLaren, and R. Davies. 2009. A comparison of the efficacy of cleaning and disinfection methods in eliminating *Salmonella* spp. from commercial egg laying houses. *Avian Pathol.* 38:419–424.

Chang, Q., W. Wang, G. Regev-Yochay, M. Lipsitch, and W. P. Hanage. 2015. Antibiotics in agriculture and the risk to human health: How worried should we be? *Evol. Appl.* 8:240–247.

Chuppava, B., B. Keller, A. Abd El-Wahab, C. Sürie, and C. Visscher. 2019. Resistance Reservoirs and Multi-Drug Resistance of Commensal *Escherichia coli* From Excreta and Manure Isolated in Broiler Houses With Different Flooring Designs. *Front. Microbiol.* 10.

Dame-Korevaar, A., E. A. J. Fischer, J. van der Goot, F. Velkers, J. van den Broek, K. Veldman, D. Ceccarelli, D. Mevius, and A. Stegeman. 2019. Effect of challenge dose of plasmid-mediated extended-spectrum β -lactamase and AmpC β -lactamase producing *Escherichia coli* on time-until-colonization and level of excretion in young broilers. *Vet. Microbiol.* 239:108446.

Davies, R., and A. Wales. 2019. Antimicrobial Resistance on Farms: A Review Including Biosecurity and the Potential Role of Disinfectants in Resistance Selection. *Compr. Rev. Food Sci. Food Saf.* 18:753–774.

Dawkins, M. S. 2019. Animal welfare as preventative medicine. *Anim. Welf.* 28:137–141.

Dierikx, C. M., J. A. van der Goot, H. E. Smith, A. Kant, and D. J. Mevius. 2013. Presence of ESBL/AmpC -Producing *Escherichia coli* in the Broiler Production Pyramid: A Descriptive Study (A Cloeckaert, Ed.). *PLoS One* 8:e79005.

EC (European Commission). 2013. Commission implementing decision, of 12 november 2013, on the monitoring and reporting of antimicrobial resistance in zoonotic and commensal bacteria (2013/652/EU).

EFSA and ECDC (European Food Safety Authority and European Centre for Disease Prevention and Control). 2019. Technical specifications on harmonised monitoring of antimicrobial resistance in zoonotic and indicator bacteria from food-producing animals and food. *EFSA J.* 17.

EFSA and ECDC (European Food Safety Authority and European Centre for Disease Prevention and Control). 2020. The European Union Summary Report on Antimicrobial Resistance in zoonotic and indicator bacteria from humans, animals and food in 2017/2018. EFSA J. 18.

El-Deek, A., and K. El-Sabrouh. 2019. Behaviour and meat quality of chicken under different housing systems. Worlds. Poult. Sci. J. 75:105–114.

EMA. 2020. Sales of veterinary antimicrobial agents in 31 European countries in 2018 (EMA/24309/2020). Sales Vet. Antimicrob. agents 31 Eur. Ctries. 2018 Trends from 2010 to 2018 Tenth ESVAC Rep.:1–104 Available at <https://www.who.int/foodsafety/publications/antimicrobials->

ESVAC (European Medicines Agency). European database of sales of veterinary antimicrobial agents. Available at <https://esvacbi.ema.europa.eu/analytics/saw.dll?PortalPages>.

Founou, L. L., R. C. Founou, and S. Y. Essack. 2016. Antibiotic Resistance in the Food Chain: A Developing Country-Perspective. Front. Microbiol. 7:1881.

Gocsik, É., S. D. Brooshooft, I. C. de Jong, and H. W. Saatkamp. 2016. Cost-efficiency of animal welfare in broiler production systems: A pilot study using the Welfare Quality® assessment protocol. Agric. Syst. 146:55–69.

Gomes, A. V. S., W. M. Quinteiro-Filho, A. Ribeiro, V. Ferraz-de-Paula, M. L. Pinheiro, E. Baskeville, A. T. Akamine, C. S. Astolfi-Ferreira, A. J. P. Ferreira, and J. Palermo-Neto. 2014. Overcrowding stress decreases macrophage activity and increases *Salmonella* Enteritidis invasion in broiler chickens. Avian Pathol. 43:82–90.

Gregova, G., M. Kmetova, V. Kmet, J. Venglovsky, and A. Feher. 2012. Antibiotic resistance of *Escherichia coli* isolated from a poultry slaughterhouse. Ann. Agric. Environ. Med. 19:75–77.

He, J., Y. He, D. Pan, J. Cao, Y. Sun, and X. Zeng. 2019. Associations of gut microbiota with heat stress-induced changes of growth, fat deposition, intestinal morphology, and antioxidant capacity in ducks. Front. Microbiol. 10:1–13.

Horigan, V., R. D. Kosmider, R. A. Horton, L. Randall, and R. R. L. Simons. 2016. An assessment of evidence data gaps in the investigation of possible transmission routes of extended spectrum β -lactamase producing *Escherichia coli* from livestock to humans in the UK. *Prev. Vet. Med.* 124:1–8.

Kersia Group. n.d. Pig & Poultry Farming. Available at <https://www.kersia-group.com/activities/pig-poultry-farming/>.

Khurana, A., R. Sinha, and M. Nagaraju. 2017. Antibiotic Resistance in Poultry Environment. Spread of Resistance from Poultry Farm to Agricultural Field. *Cent. Sci. Environ.*:1–36.

Liu, Y. Y., Y. Wang, T. R. Walsh, L. X. Yi, R. Zhang, J. Spencer, Y. Doi, G. Tian, B. Dong, X. Huang, L. F. Yu, D. Gu, H. Ren, X. Chen, L. Lv, D. He, H. Zhou, Z. Liang, J. H. Liu, and J. Shen. 2016. Emergence of plasmid-mediated colistin resistance mechanism MCR-1 in animals and human beings in China: A microbiological and molecular biological study. *Lancet Infect. Dis.* 16:161–168.

Luiken, R. E. C., L. Van Gompel, A. Bossers, P. Munk, P. Joosten, R. B. Hansen, B. E. Knudsen, S. García-Cobos, J. Dewulf, F. M. Aarestrup, J. A. Wagenaar, L. A. M. Smit, D. J. Mevius, D. J. J. Heederik, and H. Schmitt. 2020. Farm dust resistomes and bacterial microbiomes in European poultry and pig farms. *Environ. Int.* 143.

Lusk, J. L. 2018b. Consumer preferences for and beliefs about slow growth chicken. *Poult Sci.* 97:4159-4166.

Maertens, H., K. De Reu, E. Meyer, E. Van Coillie, and J. Dewulf. 2019. Limited association between disinfectant use and either antibiotic or disinfectant susceptibility of *Escherichia coli* in both poultry and pig husbandry. *BMC Vet. Res.* 15:1–12.

Mandal, R. K., T. Jiang, R. F. Wideman, T. Lohrmann, and Y. M. Kwon. 2020. Microbiota Analysis of Chickens Raised Under Stressed Conditions. *Front. Vet. Sci.* 7:482637.

Marin, C., S. Balasch, S. Vega, and M. Lainez. 2011. Sources of *Salmonella* contamination during broiler production in Eastern Spain. *Prev. Vet. Med.* 98:39–45.

Marin, C., and M. Lainez. 2009. *Salmonella* detection in feces during broiler rearing and after live transport to the slaughterhouse. *Poult. Sci.* 88:1999–2005.

Marin, C., S. Sevilla-Navarro, R. Lonjedo, P. Catalá-Gregori, M. A. Ferrús, S. Vega, and A. Jiménez-Belenguer. 2020. Genotyping and molecular characterization of antimicrobial resistance in thermophilic *Campylobacter* isolated from poultry breeders and their progeny in Eastern Spain. *Poult. Sci.* 99:5096–5104.

Marshall, B. M., and S. B. Levy. 2011. Food Animals and Antimicrobials : Impacts on Human Health. *Clinical microbiological reviews.* 24:718–733.

Matuschek, E., D. F. J. Brown, and G. Kahlmeter. 2014. Development of the EUCAST disk diffusion antimicrobial susceptibility testing method and its implementation in routine microbiology laboratories. *Clin. Microbiol. Infect.* 20.

Montoro-Dasi, L., A. Villagra, S. Sevilla-Navarro, M. T. Pérez-Gracia, S. Vega, and C. Marin. 2020. The dynamic of antibiotic resistance in commensal *Escherichia coli* throughout the growing period in broiler chickens: fast-growing vs. slow-growing breeds. *Poult. Sci.* 99:1591–1597.

Nilsson, O., S. Börjesson, A. Landén, and B. Bengtsson. 2014. Vertical transmission of *Escherichia coli* carrying plasmid-mediated AmpC (pAmpC) through the broiler production pyramid. *J. Antimicrob. Chemother.* 69:1497–1500.

Oikarainen, P. E., L. K. Pohjola, E. S. Pietola, and A. Heikinheimo. 2019. Direct vertical transmission of ESBL/pAmpC-producing *Escherichia coli* limited in poultry production pyramid. *Vet. Microbiol.* 231:100–106.

Osman, K. M., A. D. Kappell, M. Elhadidy, F. Elmougy, W. A. A. El-Ghany, A. Orabi, A. S. Mubarak, T. M. Dawoud, H. A. Hemeg, I. M. I. Moussa, A. M. Hessain, and H. M. Y. Yousef. 2018. Poultry hatcheries as potential reservoirs for antimicrobial-resistant *Escherichia coli*: A risk to public health and food safety. *Sci. Rep.* 8:1–14.

Poulsen, L. L., I. Thøfner, M. Bisgaard, J. P. Christensen, R. H. Olsen, and H. Christensen. 2017. Longitudinal study of transmission of *Escherichia coli* from broiler breeders to broilers. *Vet. Microbiol.* 207:13–18.

PRAN (Plan Nacional de Resistencia Antibióticos). 2020. Informe Anual PRAN Junio 2019 - Junio 2020.

Projahn, M., K. Daehre, U. Roesler, and A. Friese. 2017. Extended-spectrum-beta-lactamase and plasmid-encoded cephamycinase-producing enterobacteria in the broiler hatchery as a potential mode of pseudovertical transmission. *Appl. Environ. Microbiol.* 83.

Projahn, M., K. Daehre, T. Semmler, S. Guenther, U. Roesler, and A. Friese. 2018. Environmental adaptation and vertical dissemination of ESBL-/pAmpC-producing *Escherichia coli* in an integrated broiler production chain in the absence of an antibiotic treatment. *Microb. Biotechnol.* 11:1017–1026.

Rojo-Gimeno, C., M. Postma, J. Dewulf, H. Hogeveen, L. Lauwers, and E. Wauters. 2016. Farm-economic analysis of reducing antimicrobial use whilst adopting improved management strategies on farrow-to-finish pig farms. *Prev. Vet. Med.* 129:74–87.

Rouger, A., O. Tresse, and M. Zagorec. 2017. Bacterial Contaminants of Poultry Meat: Sources, Species, and Dynamics. *Microorganisms* 5:50.

Sevilla-Navarro, S., C. Marin, V. Cortés, C. García, and P. Catalá-Gregori. 2020. *Campylobacter* prevalence and risk factors associated with exceeding allowable limits in poultry slaughterhouses in Spain. *Vet. Rec.* 186.

Sharma, C., N. Rokana, M. Chandra, B. P. Singh, R. D. Gulhane, J. P. S. Gill, P. Ray, A. K. Puniya, and H. Panwar. 2018. Antimicrobial resistance: Its surveillance, impact, and alternative management strategies in dairy animals. *Front. Vet. Sci.* 4.

Sirri, F., C. Castellini, M. Bianchi, M. Petracci, A. Meluzzi, and A. Franchini. 2011. Effect of fast-, medium- and slow-growing strains on meat quality of chickens reared under the organic farming method. *91:312–319.*

Soleimani, A. F., I. Zulkifli, M. Hair-Bejo, M. Ebrahimi, S. D. Jazayeri, S. R. Hashemi, A. Meimandipour, and Y. M. Goh. 2012. Epigenetic modification: possible approach to reduce *Salmonella enterica* serovar enteritidis susceptibility under stress conditions. *Avian Pathol.* 41:351–354.

Swaggerty, C. L., T. R. Callaway, M. H. Kogut, A. Piva, and E. Grilli. 2019. Modulation of the immune response to improve health and reduce foodborne pathogens in poultry. *Microorganisms* 7:1–10.

WHO (World Health Organization). 2011. European strategic action plan on antibiotic resistance. Available at http://www.euro.who.int/__data/assets/pdf_file/0008/147734/wd14E_AntibioticResistance_111380.pdf.

WHO (World Health Organization). 2019. Critically important antimicrobials for human medicine, 6th revision. Available at <https://www.who.int/foodsafety/publications/antimicrobials-sixth/en>.

3.2.3 Influence of farm management on the dynamics of *Salmonella* Infantis shedding and antibiotic resistance during growing period: commercial vs. optimal conditions

L. Montoro-Dasi, A. Villagra, S. Vega, C. Marin. 2021. Influence of farm management on the dynamics of *Salmonella* Infantis shedding and antibiotic resistance during growing period: commercial vs. optimal conditions. Vet Record. 2021;e302. doi: 10.1002/vetr.302.

3.2.3.1 Abstract

Salmonella Infantis is a zoonotic pathogen isolated in broilers causing great economic losses in the European poultry sector. It is demonstrated that an investment in management measures at farm level could directly affect the control of food chain microorganisms. The aim of this study was to investigate the development of *S. Infantis* AMR patterns during the growing period, according to flock density and ventilation management, without AB administration. The experiment was performed in two identical poultry houses, evaluating commercial and optimal farm conditions. At 24h of rearing, 20% of the animals were orally infected with a *S. Infantis* strain susceptible to all the ABs tested. To study *Salmonella* shedding, faeces samples from each experimental group were taken weekly and analysed as per ISO 6579-2:2017. AB susceptibility was assessed according to Decision 652/2013. *Salmonella* shedding showed that the lowest counts were observed in the first week post-infection and highest at slaughter day for both groups. Moreover, 100% of the isolates were multi-resistant. The acquisition of AMR by *S. Infantis* starts at the onset of the production cycle and is maintained until the end, demonstrating the importance of transmission of AMR in zoonotic bacteria at farm level.

3.2.3.1 Introduction

Animal welfare and food safety are increasing concerns for poultry product consumers (Bhaisare *et al.*, 2014). Both issues are closely related, as it has been demonstrated that if animals are in good welfare status, their resilience is increased, and they can cope with environmental challenges or infectious diseases (Soleimani *et al.*, 2012; Gomes *et al.*, 2014; Dawkins, 2017; Swaggerty *et al.*, 2019). For this reason, an investment in more efficient and animal-friendly management measures in the poultry sector could directly affect animal health (Guardia *et al.*, 2011; Franz *et al.*, 2012; Gomes *et al.*, 2014; Sassi *et al.*, 2016; Rouger *et al.*, 2017). In this sense, a good ventilation system is essential for heat stress management, a factor that undermines the productivity and immunology of livestock (Frag and Alagawany, 2018; Ranjan *et al.*, 2019). Likewise, high stocking density also has an adverse effect on the performance and immune status of broilers (Farhadi *et al.*, 2016; Qaid *et al.*, 2016; Desoky, 2018).

Furthermore, despite the strict legislation against *Salmonella*, these bacteria remain the principal source of human foodborne disease in Europe, and poultry products are the main source involved in human outbreaks (EFSA and ECDC, 2004; Bhaisare *et al.*, 2014; EFSA and ECDC, 2019c). Moreover, *S. Infantis* is an emerging serovar of great concern for European broiler production, as it has been demonstrated that this serovar is present in 50% of *Salmonella* contaminated broiler meat samples analysed (EFSA and ECDC, 2019a,c). Consequently, nowadays *S. Infantis* control at farm level is one of the main objectives for the poultry sector.

One hypothesis that explains the emergence of *S. Infantis* in the poultry sector is its ability to gain AMR from the gut microbiota and/or environment (Shah *et al.*, 2016; Abdi *et al.*, 2017; Cohen *et al.*, 2020). Moreover, a novel megaplasmid has been identified that represents a recent evolutionary change in the pathogenicity and stress tolerance of local *S. Infantis* population (Aviv *et al.*, 2016). In this context, AMR control in the field requires effective surveillance programmes, proper food handling practices and prudent use of ABs throughout the production cycle (Wallmann, 2014; Sohan Rodney Bangera *et al.*, 2019). However, to be able to establish adequate control measures it is necessary to have better knowledge of the epidemiology of this serovar.

In accordance with the increasing consumer concern for animal welfare and the public health issue of AMR, the objective of this study was to investigate the development of *S. Infantis* AMR during the broiler growing period, according to density and ventilation management.

3.2.3.3 Material and methods

In this experiment, all animals were handled according to the principles of animal care published by Spanish Royal Decree 53/2013 (BOE, 2013), and approved by the Ethical Review Panel of the Directorate-General for Agriculture, Fisheries and Livestock from the Valencian Community by the code 2018/VSC/PEA/0067

3.2.3.3.1 Experiment design

The study was performed in two identical poultry houses of an experimental poultry farm at the CITA-IVIA. For this purpose, two different environmental farm conditions: CFC (house 1) and OFC (house 2), were evaluated. For CFC, chicks were housed at 35 kg/m² density and non-optimal parameters of ventilation were applied (allowing a maximum concentration of ammonia of 25 ppm). While in OFC, the animals were housed in low density at 17 kg/m² and ventilation was provided within the optimal parameters (allowing a maximum concentration of ammonia of 10 ppm).

To this end, day-old-chicks (Ross®) (males and females) were distributed in two identical poultry houses (n=1 062, 531 per house). Within each of the houses, 204/531 animals were located in 12 pens with wood shavings as bedding material. The rest of the animals (327/531) were housed in the remaining space using also wood shavings as bedding material to simulate production conditions. The house was supplied with programmable electrical lights, automated electric heating and forced ventilation. The environmental temperature was gradually decreased from 32 °C (1 day) to 19 °C (42 days) following common practice in poultry production. The experimental pelleted feed was commercial feed according to standard diets for broilers. Two different diets were offered to the birds: starter (1 day to 21 days) and grower (21 days to 42 days). Only one batch of feed per age (starter and grower) was provided. Nutritional and product analysis were assessed before the arrival of animals. Feed was weighed, manually distributed and added *ad libitum*.

Furthermore, the mortality and the presence of diarrhoea were registered daily. Finally, animals were weighed at weekly intervals and feed consumption per pen was recorded.

3.2.3.3.2 *Salmonella* infection

At 24h after placing, 20% of birds/pen were orally infected with *S. Infantis*. The experimental infection was done with 100 µL of a *S. Infantis* diluted at an infective titer of 10⁴ CFU/mL. The strain was selected from a database of *Salmonella* strains isolated from the *Salmonella* National Control Program (CECAV). To ensure that this strain was susceptible to all ABs studied, antimicrobial susceptibility was tested according to the EUCAST guidelines (Matuschek *et al.*, 2014). The source for zone diameters used for interpretation of the test was: http://www.eucast.org/clinical_breakpoints/. The strain of *S. Infantis* was inoculated into Mueller-Hinton agar (Scharlab, S.L., Barcelona, Spain) to form a bacterial lawn, the AB discs were added, and plates were incubated at 37 °C ± 1 °C for 24 ± 3h.

3.2.3.3.3 *Salmonella* detection and identification

Salmonella status of the chicken houses were tested before the arrival of the animals in accordance with ISO 6579-1:2017 (ISO, 2017a). In addition, *Salmonella* status of the flock was tested at the arrival day, collecting samples of meconium (n=250) and delivery box liners (n=10) (MAPA, 2003).

Salmonella enumeration was assessed as per ISO 6579-2:2017 (ISO, 2017b). Animals were sampled at different times throughout the growing period (7, 14, 21, 28, 35 and 42 days of age). For each sampling time and house (CFC vs. OFC), faeces samples (25g) were directly collected from each pen per duplicate (n=24). Once in the laboratory, two pools of samples from each replicate per house (n=2 pools/treatment/house) were homogenised and transferred into 225 mL of Buffered Peptone Water (BPW, Scharlab, S.L., Barcelona, Spain). Afterwards, 2.5 mL of the suspension were transferred into an empty tube. Serial 1:5 dilutions were made from each tube and incubated at 37 °C for 18 ± 2h. After incubation, 20 µL were transferred onto Rappaport Vasiliadis agar plates (MSRV, Difco, Valencia, Spain) and incubated at 41.5 °C for 24 to 48h. Suspected plates were streaked into XLD medium (Scharlab, S.L., Barcelona, Spain) and incubated at 37 °C ± 1 °C for 24 ± 3h. Then, API-20E test (Biomerieux, S.L., Barcelona, Spain) was

performed to confirm *Salmonella*. Finally, for the estimation of Most Probable Number (MPN), the software described by Jarvis *et al.* (2010) was used and the results were transformed into logarithms (\log_{10} CFU/g) (Jarvis *et al.*, 2010). To confirm that the isolates were obtained from the original inoculum, *Salmonella* strains were serotyped at CECAV, using the Kauffman-White-Le Minor scheme (WHO, 2007).

3.2.3.3.4 Antimicrobial susceptibility testing

Antimicrobial susceptibility of the strains isolated was tested as reported above. The ABs selected were those set forth in Decision 652/2013 (EC, 2013) including two quinolones: CIP (5 μ g) and NAL (30 μ g); three b-lactams: AMP (10 μ g), CTX (30 μ g) and CAZ (30 μ g); one phenicol: CHL (5 μ g); one potentiated sulfonamide: SXT (1.25/23.75 μ g); one polymyxin: CST (10 μ g); one macrolide: AZM (15 μ g); one glycylicycline: TGC (15 μ g); one aminoglycoside: GEN (10 μ g), and one pyrimidine: TMP (5 μ g). MDR was defined as acquired resistance to at least one agent in two or more antimicrobial classes (EFSA and ECDC, 2016).

3.2.3.3.5 Statistical analysis

An analysis of variance (ANOVA) test was used to study the dynamics of *S. Infantis* shedding and AMR during growing period under different farm conditions (CFC and OFC). A P -value <0.05 was considered to indicate a statistically significant difference. Analyses were carried out using a commercially available software application (SPSS 24.0 software package; SPSS Inc., Chicago, IL, 2002).

3.2.3.4 Results

During this experiment, all the productive parameters were according to the breed standards and no signs of intestinal disease were observed. Thus, no ABs were administered in this study.

3.2.3.4.1 *Salmonella* excretion

At the start of the trial, negative *Salmonella* status of the chicken houses and the day-old-chickens was confirmed. Moreover, all the *Salmonella* strains isolated during this study were serotyped as *S. Infantis*.

Results obtained for CFC and OFC are presented in Figure 29. For both environmental farm conditions studied, the lowest excretion of *S. Infantis* was observed in the first week post-infection (**wpi**). Then, for CFC, *S. Infantis* detection increased until 14 days and then became stable until the end of growing period (P -value <0.05). However, for OFC, *S. Infantis* counts increased until 21 days of the growing period and then remained stable until the end of growing (P -value <0.05). However, no statistically significant differences were found between treatments (CFC vs OFC) in *Salmonella* counts (P -value >0.05).

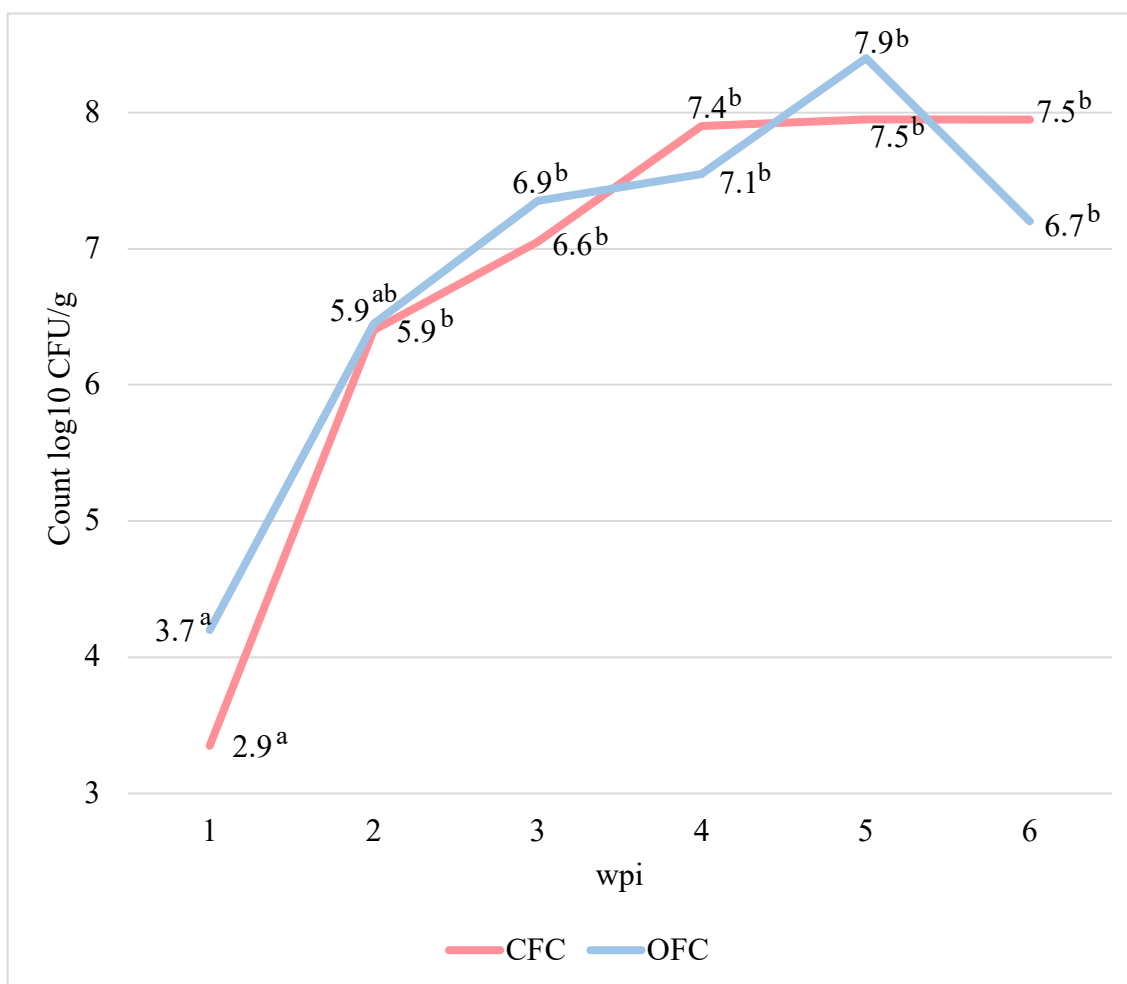

Figure 29. *Salmonella* excretion dynamic in commercial (CFC) and optimal (OFC) farm conditions during growing period. ^{a, b}: Different superscripts means significant differences with a P -value <0.05 .

3.2.3.4.2 Prevalence of antimicrobial resistance and multidrug-resistance

Although the *S. Infantis* strain used to infect the animals was completely susceptible to all ABs tested at the time of infection and no ABs were administered during the growing period, *Salmonella* isolates obtained from both groups (n=24) were MDR after 1 wpi. No statistically differences were found between experimental conditions (CFC vs OFC) and the time of sampling (P -value >0.05).

For CFC, the highest percentages of AMR were found to CIP (100%, n=12), NAL (100%, n=12) and TMP (100%, n=12), followed by SXT (91.7%, n=11), CTX (25.0%, n=3), CAZ (25.0%, n=3), AZM (16.7%, n=2) and finally, CST (8.3%, n=1). No resistance was found against AMP, CHL, GEN and TGC. Regarding resistance dynamic through the entire growing period, at 1 wpi, *S. Infantis* strains showed resistance to CIP, NAL, CTX, CAZ, SXT and TMP. It is important to highlight that at 2 wpi, resistance to CST also appeared. However, from the third wpi onwards, only resistance to CIP, NAL, SXT and TMP remained until slaughter day (Table 15).

In the case of OFC, the highest AMR percentages were observed to CIP (100%, n=12), NAL (100%, n=12) and SXT (100%, n=12), followed by TMP (91.7%, n=11). The remaining ABs showed a lower AMR percentage: CTX (33.3%, n=4), CAZ (16.7%, n=2), AMP (16.7%, n=2), AZM (16.7%, n=2) and CHL (8.3%, n=1). Regarding the AMR dynamics during the growing period, at 1 wpi and at the slaughter day, *S. Infantis* strains were resistant to the same ABs of CFC isolated strains. However, in OFC no resistance to CST appeared during the growing period (Table 15).

3.2.3.4.3 Antibiotic resistance patterns

The number of *Salmonella* strains isolated resistant to the different ABs tested according to different environmental farm conditions (CFC and OFC) are presented in Table 16.

Overall, 11 different resistance patterns were observed. The combination of CIP-NAL-SXT-TMP (37.5%, n=9) was the pattern most frequently observed, followed by CIP-NAL-SXT-AZM-TMP (16.67%, n=4).

Table 15. Antibiotic resistance isolates according to the antibiotic and the moment of the growing period in CFC and OFC.

Environmental conditions	wpi	N pools	CIP	NAL	CTX	CAZ	AMP	CHL	SXT	CST	AZM	TGC	GEN	TMP	
CFC	1	2	2	2	2	1	0	0	2	0	0	0	0	2	
	2	2	2	2	1	1	0	0	2	1	0	0	0	2	
	3	2	2	2	0	0	0	0	2	0	0	0	0	2	
	4	2	2	2	2	0	1	0	0	2	0	0	0	2	
	5	2	2	2	2	0	0	0	0	1	0	0	0	2	
	6	2	2	2	2	0	0	0	0	2	0	2	0	0	2
	Total	12	12	12	12	3	3	0	0	11	1	2	0	0	12
OFC	1	2	2	2	2	1	0	0	2	0	0	0	0	2	
	2	2	2	2	1	0	1	1	2	0	0	0	0	1	
	3	2	2	2	0	0	0	0	2	0	0	0	0	2	
	4	2	2	2	2	1	1	1	0	2	0	0	0	2	
	5	2	2	2	2	0	0	0	0	2	0	0	0	2	
	6	2	2	2	2	0	0	0	0	2	0	2	0	0	2
	Total	12	12	12	12	4	2	2	1	12	0	2	0	0	11

CFC: commercial farm conditions, OFC: optimal farm conditions, CIP: ciprofloxacin, NAL: nalidixic acid, CTX: cefotaxime, CAZ: ceftazidime, AMP: ampicillin, CHL: chloramphenicol, SXT: trimethoprim-sulfamethoxazole, CST: colistin, AZM: azithromycin, TGC: tigecycline, GEN: gentamycin and TMP: trimethoprim.

Table 16. Number of *Salmonella* strains isolated resistant to the different antibiotics tested according to different environmental farm conditions.

Environmental conditions	Number of AMR to the indicated number of antibiotics											Total
	0	1	2	3	4	5	6	7	8	9	10	
CFC	0	0	0	1	4	5	2	0	0	0	0	12
OFC	0	0	0	1	5	3	1	2	0	0	0	12

AMR: antimicrobial resistance; CFC: commercial farm conditions; OFC: optimal farm conditions

3.2.3.5 Discussion

The present study examined the development of *S. Infantis* AMR in broiler chickens during the growing period, comparing two different environmental conditions according to density and ventilation parameters. To our best knowledge, this is the first study in scientific literature to evaluate the effect of these management measures at farm level on *S. Infantis* epidemiology.

On the day of placement, the negative *Salmonella* status of the chickens was confirmed. After infection, for CFC experimental group *S. Infantis* counts increased until 14 days and, for OFC until 21 days, without statistically significant differences between treatments. Our results agree with those reported previously by Marin and Lainez (2009), when *Salmonella* detection in faeces increased until second week of age, coinciding with the maturation of the animals' immune system and remaining stable until processing day (Marin and Lainez, 2009; Cosby *et al.*, 2015).

In the EU a strict poultry welfare legislation has been set out at farm level (EC, 2007). However, a large section of society calls for a continuous increase in animal welfare during the grow-out period (Bhaisare *et al.*, 2014). In fact, different authors indicate that lower stress situations increase the potential of the immune system to protect the individual against pathogens (Soleimani *et al.*, 2012; Gomes *et al.*, 2014; Scanes, 2016; Calefi *et al.*, 2017; Dawkins, 2017; Desoky, 2018; Farag and Alagawany, 2018a; EFSA and ECDC, 2019a,d). However, the results of our study showed that the improvement in ventilation or density parameters of the flock has no effects in terms of either *Salmonella* shedding which is in line with Velasquez *et al.* (2018) and Pulido-Landínez (2019) (Velasquez *et al.*, 2018; Pulido-Landínez, 2019).

AMR rates of *Salmonella* isolates obtained since the start of the trial showed that no statistical differences were found between treatments, despite the improvement in management conditions. In addition, it is important to underscore that a high percentage of *S. Infantis* isolated during the growing period were MDR, although no ABs were administrated (Andoh *et al.*, 2016; Sohan Rodney Bangera *et al.*, 2019; EFSA and ECDC, 2019c).

Different hypotheses could explain this fact. Previous studies using genomic analysis of bacteria indicated they could acquire resistance profiles by incorporating different genetic elements through horizontal gene transfer from other bacteria and/or from the environment (Cosby *et al.*, 2015; Projahn *et al.*, 2017, 2018; Osman *et al.*, 2018; Daehre *et al.*, 2018; Agyare *et al.*, 2018; Okorafor *et al.*, 2019). In this sense, the commensal microbiota could acquire the AMR and, intestinal zoonotic bacteria such as *Salmonella*, could acquire the AMR by conjugation, transformation or transduction mechanisms (Tripathi and Tripathi, 2017; EFSA and ECDC, 2020). For this reason, different scientific studies underline the importance of developing sanitary measures at the interface between the environment and livestock farming (Allen *et al.*, 2010; Bengtsson-Palme *et al.*, 2018; Westphal-Settele *et al.*, 2018). However, further studies are needed to confirm the main source of AMR of the *Salmonella* strains at farm level.

Moreover, in reference to AMR percentages obtained from different ABs assessed, it is important to highlight the results obtained against CST and TGC, as they are considered critically important antimicrobials used as last-resort drugs to treat human infectious diseases (Kern, 2018; EFSA and ECDC, 2020). On the one hand, no isolates showed AMR to TGC. The results agree with that reported by the EFSA (EFSA and ECDC, 2020), and it might be explained by the restricted use to human in hospital treatments (WHO, 2019). Conversely, the presence of AMR against CST could be due to its use in animal production for several years to treat infectious diseases and as a growth promotor (EMA, 2018) and, as indicated by previous studies, resistant genes could remain in the environment and reach the microbiota of animals, and from there transmitted to zoonotic bacteria. Furthermore, it is important to note that the highest AMR obtained are to CIP, NAL, SXT and TMP. In 2020, EFSA reported very high levels of resistance to CIP, NAL and SXT in *Salmonella* isolated from broilers, and low levels of resistance to AMP and CHL, matching our results (EFSA and ECDC, 2020). Moreover, specifically for SXT and TMP, one hypothesis that could explain the results obtained in this study is that these ABs are permitted in Spain as therapeutic agents for antibacterial therapy in animal (WHO, 2019). This study reveals the importance of AMR monitoring in zoonotic and commensal bacteria in food-producing animals and their food products to be able to understand the development and diffusion of resistance, providing relevant risk assessment data, and evaluating targeted interventions (EFSA and ECDC, 2019b, 2020).

3.2.3.6 Conclusion

In conclusion, the results of this study showed that when chicks are infected with the serovar *S. Infantis* at day one of the growing period, they continue shedding the bacteria in faeces until the processing day. Besides, the acquisition of AMR began at the onset of the production cycle and continue until the end, regardless of different management conditions applied. Nevertheless, it is important to highlight that no molecular studies of the microbiota interaction have been done in this study, which may restrict the interpretation of the results obtained. Thus, further deeply studies of the plasmids, pathogenicity islands or transposons are needed to achieve a better knowledge of *S. Infantis* AMR dynamics at the farm level, in order to establish better control programmes and reduce its prevalence throughout the food chain.

3.2.3.7 References

Abdi, R. D., F. Mengstie, A. F. Beyi, T. Beyene, H. Waktole, B. Mammo, D. Ayana, and F. Abunna. 2017. Determination of the sources and antimicrobial resistance patterns of *Salmonella* isolated from the poultry industry in Southern Ethiopia. *BMC Infect. Dis.* 17:1–12.

Agyare, C., V. E. Boamah, C. N. Zumbi and F. B. Osei. 2018. Antibiotic Use in Poultry Production and its Effects on Bacterial Resistance. Pages 1-20 in *Antimicrobial Resistance – A Global Threat*, ed. Yashwant Kumar, London, United Kingdom.

Allen, H. K., J. Donato, H. H. Wang, K. A. Cloud-Hansen, J. Davies, and J. Handelsman. 2010. Call of the wild: Antibiotic resistance genes in natural environments. *Nat. Rev. Microbiol.* 8:251–259.

Andoh, L. A., A. Dalsgaard, K. Obiri-Danso, M. J. Newman, L. Barco, and J. E. Olsen. 2016. Prevalence and antimicrobial resistance of *Salmonella* serovars isolated from poultry in Ghana. *Epidemiol. Infect.* 144:3288–3299.

Aviv, G., G. Rahav, and O. Gal-Mor. 2016. Horizontal transfer of the *Salmonella enterica* serovar infantis resistance and virulence plasmid pESI to the gut microbiota of warm-blooded hosts. *MBio* 7.

Bengtsson-Palme, J., E. Kristiansson, and D. G. J. Larsson. 2018. Environmental factors influencing the development and spread of antibiotic resistance. *FEMS Microbiol. Rev.* 42:68–80.

Bhaisare, D. B., D. Thyagarajan, R. R. Churchil, and N. Punniamurthy. 2014. Bacterial Pathogens in Chicken Meat: Review. *Int. J. Life Sci. Res.* ISSN 2:2348–313.

BOE (Boletín Oficial del Estado). Spain. Royal Degree 53/2013, 1st of February 2013, por el que se establecen las normas básicas aplicables para la protección de los animales utilizados en experimentación y otros fines científicos, incluyendo la docencia. Available at https://www.boe.es/diario_boe/txt.php?id=BOE-A-2013-1337.

Calefi, A. S., W. M. Quinteiro-Filho, A. J. P. Ferreira, and J. Palermo-Neto. 2017. Neuroimmunomodulation and heat stress in poultry. *Worlds. Poult. Sci. J.* 73:493–504.

Cohen, E., M. Davidovich, A. Rokney, L. Valinsky, G. Rahav, and O. Gal-Mor. 2020. Emergence of new variants of antibiotic resistance genomic islands among multidrug-resistant *Salmonella enterica* in poultry. *Environ. Microbiol.* 22:413–432.

Cosby, D. E., N. A. Cox, M. A. Harrison, J. L. Wilson, R. Jeff Buhr, and P. J. Fedorka-Cray. 2015. *Salmonella* and antimicrobial resistance in broilers: A review. *J. Appl. Poult. Res.* 24:408–426.

Daehre, K., M. Projahn, T. Semmler, U. Roesler, and A. Friese. 2018. Extended-Spectrum Beta-Lactamase-/AmpC Beta-Lactamase-Producing Enterobacteriaceae in Broiler Farms: Transmission Dynamics at Farm Level. *Microb. Drug Resist.* 24:511–518.

Dawkins, M. S. 2017. Animal welfare and efficient farming: is conflict inevitable? *Anim. Prod. Sci.* 57:201.

Desoky, A. A. 2018. Growth Performance and Immune Response of Broiler Chickens Reared Under High Stocking Density and Vitamin E Supplementation. 5623.

EC (European Commission). 2007. Council Directive 2007/43/EC of 28 June 2007 laying down minimum rules for the protection of chickens kept for meat production (Text with EEA relevance).

EC (European Commission). 2013. Commission Implementing Decision of 12 November 2013 on the monitoring and reporting of antimicrobial resistance in zoonotic and commensal bacteria (notified under document C(2013) 7145).

EFSA and ECDC (European Food Safety Authority and European Centre for Disease Prevention and Control). 2004. Opinion of the Scientific Panel on biological hazards (BIOHAZ) related to the use of vaccines for the control of *Salmonella* in poultry. *EFSA J.* 2:1–74.

EFSA and ECDC (European Food Safety Authority and European Centre for Disease Prevention and Control). 2016. EU protocol for harmonised monitoring of antimicrobial resistance in human *Salmonella* and *Campylobacter* isolates - June 2016.

EFSA and ECDC (European Food Safety Authority and European Centre for Disease Prevention and Control). 2019a. Technical specifications on harmonised monitoring of antimicrobial resistance in zoonotic and indicator bacteria from food-producing animals and food. EFSA J. 17.

EFSA and ECDC (European Food Safety Authority and European Centre for Disease Prevention and Control). 2019b. *Salmonella* control in poultry flocks and its public health impact. EFSA J. 17.

EFSA and ECDC (European Food Safety Authority and European Centre for Disease Prevention and Control). 2019c. The European Union One Health 2018 Zoonoses Report. EFSA J. 2019;17:5926.

EFSA and ECDC (European Food Safety Authority and European Centre for Disease Prevention and Control). 2020. The European Union Summary Report on Antimicrobial Resistance in zoonotic and indicator bacteria from humans, animals and food in 2017/2018. EFSA J. 18.

EFSA and ECDC (European Food Safety Authority and European Centre for Disease Prevention and Control), K. Koutsoumanis, A. Allende, A. Alvarez-Ordóñez, D. Bolton, S. Bover-Cid, M. Chemaly, A. De Cesare, L. Herman, F. Hilbert, R. Lindqvist, M. Nauta, L. Peixe, G. Ru, M. Simmons, P. Skandamis, E. Suffredini, J. Dewulf, T. Hald, V. Michel, N. Taina, A. Ricci, E. Snary, F. Boelaert, W. Messens, and R. Davies. 2019. Opinion of the Scientific Panel on biological hazards (BIOHAZ) on the *Salmonella* control in poultry flocks and its public health impact.pdf. EFSA J. 17:5596.

ESVAC (European Medicines Agency). 2018. Sales of veterinary antimicrobial agents in 30 European countries in 2016- Trends from 2010 to 2016- Eight ESVAC report. Eur. Med. Agency:176.

Farag, M. R., and M. Alagawany. 2018a. Physiological alterations of poultry to the high environmental temperature. J. Therm. Biol. 76:101–106.

Farag, M. R., and M. Alagawany. 2018b. Physiological alterations of poultry to the high environmental temperature. *J. Therm. Biol.* 76:101–106.

Farhadi, D., S. M. Hosseini, and B. T. Dezfuli. 2016. Effect of house type on growth performance, litter quality and incidence of foot lesions in broiler chickens reared in varying stocking density. *J. BioSci. Biotech.* 5:69–78.

Franz, E., H. J. van der Fels-Klerx, J. Thissen, and E. D. van Asselt. 2012. Farm and slaughterhouse characteristics affecting the occurrence of *Salmonella* and *Campylobacter* in the broiler supply chain. *Poult. Sci.* 91:2376–2381.

Gomes, A. V. S., W. M. Quinteiro-Filho, A. Ribeiro, V. Ferraz-de-Paula, M. L. Pinheiro, E. Baskeville, A. T. Akamine, C. S. Astolfi-Ferreira, A. J. P. Ferreira, and J. Palermo-Neto. 2014. Overcrowding stress decreases macrophage activity and increases *Salmonella* Enteritidis invasion in broiler chickens. *Avian Pathol.* 43:82–90.

Guardia, S., B. Konsak, S. Combes, F. Levenez, L. Cauquil, J. F. Guillot, C. Moreau-Vauzelle, M. Lessire, H. Juin, and I. Gabriel. 2011. Effects of stocking density on the growth performance and digestive microbiota of broiler chickens. *Poult. Sci.* 90:1878–1889.

ISO (International Organisation for Standardisation). 2017a. ISO 6579-1:2017. Microbiology of the food chain — Horizontal method for the detection, enumeration and serotyping of *Salmonella* — Part 1: Detection of *Salmonella* spp. International Organisation for Standardisation, Genève, Switzerland.

ISO (International Organisation for Standardisation). 2017b. ISO/TS 6579-2:2017. Microbiology of food and animal feed — Horizontal method for the detection, enumeration and serotyping of *Salmonella* — Part 2: Enumeration by a miniaturized most probable number technique. International Organisation for Standardisation, Genève, Switzerland.

Jarvis, B., C. Wilrich, and P. T. Wilrich. 2010. Reconsideration of the derivation of Most Probable Numbers, their standard deviations, confidence bounds and rarity values. *J. Appl. Microbiol.* 109:1660–1667.

Kern, W. V. 2018. Multiresistant Bacteria - Antibiotic Prescription and Antibiotics of Last Resort. *Dtsch. Medizinische Wochenschrift* 143:643–650.

MAPA (Ministerio de Agricultura Pesca y Agricultura). Real Decreto 328 / 2003, de 14 de marzo, por el que se establece y regula el plan sanitario avícola. *Boletín Oficial del Estad* 2003 p. 1–21.

Marin, C., and M. Lainez. 2009. *Salmonella* detection in feces during broiler rearing and after live transport to the slaughterhouse. *Poult. Sci.* 88:1999–2005.

Matuschek, E., D. F. J. Brown, and G. Kahlmeter. 2014. Development of the EUCAST disk diffusion antimicrobial susceptibility testing method and its implementation in routine microbiology laboratories. *Clin. Microbiol. Infect.* 20.

Okorafor, O. N., M. U. Anyanwu, E. O. Nwafor, G. N. Anosa, and R. I. Udegbumam. 2019. Multidrug-resistant enterobacteria colonize commercial day-old broiler chicks in Nigeria. *Vet. World* 12:418–423.

Osman, K. M., A. D. Kappell, M. Elhadidy, F. Elmougy, W. A. A. El-Ghany, A. Orabi, A. S. Mubarak, T. M. Dawoud, H. A. Hemeg, I. M. I. Moussa, A. M. Hessain, and H. M. Y. Yousef. 2018. Poultry hatcheries as potential reservoirs for antimicrobial-resistant *Escherichia coli*: A risk to public health and food safety. *Sci. Rep.* 8:1–14.

Projahn, M., K. Daehre, U. Roesler, and A. Friese. 2017. Extended-spectrum-beta-lactamase and plasmid-encoded cephamycinase-producing enterobacteria in the broiler hatchery as a potential mode of pseudovertical transmission. *Appl. Environ. Microbiol.* 83.

Projahn, M., K. Daehre, T. Semmler, S. Guenther, U. Roesler, and A. Friese. 2018. Environmental adaptation and vertical dissemination of ESBL-/pAmpC-producing *Escherichia coli* in an integrated broiler production chain in the absence of an antibiotic treatment. *Microb. Biotechnol.* 11:1017–1026.

Pulido-Landínez, M. 2019. Food safety - *Salmonella* update in broilers. *Anim. Feed Sci. Technol.* 250:53–58.

Qaid, M., H. Albatshan, T. Shafey, E. Hussein, and A. M. Abudabos. 2016. Effect of stocking density on the performance and immunity of 1-to 14-d- old broiler chicks. *Rev. Bras. Cienc. Avic.* 18:683–692.

Ranjan, A., R. Sinha, I. Devi, A. Rahim, and S. Tiwari. 2019. Effect of Heat Stress on Poultry Production and their Managemental Approaches. *Int. J. Curr. Microbiol. Appl. Sci.* 8:1548–1555.

Rouger, A., O. Tresse, and M. Zagorec. 2017. Bacterial Contaminants of Poultry Meat: Sources, Species, and Dynamics. *Microorganisms* 5:50.

Sassi, N. Ben, X. Averós, and I. Estevez. 2016. Technology and poultry welfare. *Animals* 6:1–21.

Scanes, C. G. 2016. Biology of stress in poultry with emphasis on glucocorticoids and the heterophil to lymphocyte ratio. *Poult. Sci.* 95:2208–2215.

Shah, D. H., N. C. Paul, W. C. Sisco, R. Crespo, and J. Guard. 2016. Population dynamics and antimicrobial resistance of the most prevalent poultry-associated *Salmonella* serotypes. *Poult. Sci.* 96:687–702.

Sohan Rodney Bangera, S. Umakanth, G. Chowdhury, Rudra Narayan Saha, A. K. Mukhopadhyay, and M. Ballal. 2019. Poultry: A receptacle for non-typhoidal *salmonellae* and antimicrobial resistance. *Iran. J. Microbiol.* 11:31–38.

Soleimani, A. F., I. Zulkifli, M. Hair-Bejo, M. Ebrahimi, S. D. Jazayeri, S. R. Hashemi, A. Meimandipour, and Y. M. Goh. 2012a. Epigenetic modification: possible approach to reduce *Salmonella enterica* serovar enteritidis susceptibility under stress conditions. *Avian Pathol.* 41:351–354.

Soleimani, A. F., I. Zulkifli, M. Hair-Bejo, M. Ebrahimi, S. D. Jazayeri, S. R. Hashemi, A. Meimandipour, and Y. M. Goh. 2012b. Epigenetic modification: possible approach to reduce *Salmonella enterica* serovar enteritidis susceptibility under stress conditions. *Avian Pathol.* 41:351–354.

Swaggerty, C. L., T. R. Callaway, M. H. Kogut, A. Piva, and E. Grilli. 2019. Modulation of the immune response to improve health and reduce foodborne pathogens in poultry. *Microorganisms* 7:1–10.

Tripathi V, Tripathi P. Antibiotic Resistance Genes: An Emerging Environmental Pollutant. In: *Perspectives in Environmental Toxicology*. Environmental Science and Engineering, ed Kesari K, Switzerland, 2017:183-201.

Velasquez, C. G., K. S. MacKlin, S. Kumar, M. Bailey, P. E. Ebner, H. F. Oliver, F. S. Martin-Gonzalez, and M. Singh. 2018. Prevalence and antimicrobial resistance patterns of *Salmonella* isolated from poultry farms in southeastern United States. *Poult. Sci.* 97:2144–2152.

Wallmann, J. 2014. Antimicrobial resistance: Challenges ahead. *Vet. Rec.* 175:323–324.

Westphal-Settele, K., S. Konradi, F. Balzer, J. Schönfeld, and R. Schmithausen. 2018. The environment as a reservoir for antimicrobial resistance: A growing problem for public health? *Bundesgesundheitsblatt - Gesundheitsforsch. - Gesundheitsschutz* 61:533–542.

WHO (World Health Organisation). Collaborating Centre for Reference and Research on *Salmonella*, Grimont PAD, Weill F-X. Antigenic formulae of the *Salmonella* serovars. 9th ed. Paris; 2007.

WHO (World Health Organization). 2019. Critically important antimicrobials for human medicine, 6th revision. Available at <https://www.who.int/foodsafety/publications/antimicrobials-sixth/en/>.

CHAPTER IV. GENERAL DISCUSSION

Poultry production is one of the most important livestock sectors due to its high degree of specialisation and the production of healthy, nutritious and competitive protein for the population. In addition, society increasingly demands less intensive production, more respectful of animal welfare, environment and biodiversity, encompassed under the 'One Health' approach (Lusk, 2018). However, new and worrying challenges, such as AMR, are emerging in the sector. These days, AMR is one of the most important threats to public health worldwide (WHO, 2019). In consequence, alternative production systems are being developed, focused on enhancing animal welfare and reducing the use of AMAs by using more rustic breeds and implementing precision livestock farming systems (Castellini and Dal Bosco, 2017). Thus, this doctoral thesis has been focused on evaluating the effect of alternative management tools on the microbiota composition development and AMR dynamics in poultry production, both by modifying the breed selection criteria and by improving environmental farm conditions.

Nowadays, producers are motivated to choose more rustic breeds for their ability to deal with the natural environment, reducing the use of AMAs and the impact on farms of global warming and pollution. However, the balance between productive performance and animal welfare is not easy to achieve (Castellini and Dal Bosco, 2017). So, the aim of the first experiment was to study the effect of the genetic breed, by comparing a commercial fast-growing breed *vs.* an alternative slow-growing breed, on microbiota development and AMR dynamics.

In the first study, the caecal microbiota was characterised in two different broiler management systems, fast and slow-growing, during their respective growing periods, using 16S rRNA sequencing analysis.

Microbiota are defined as the microbial communities that colonise different areas of animals and have an important influence on animal health, productivity and disease control (Oakley *et al.*, 2014; Stanley *et al.*, 2014; Pourabedin and Zhao, 2015; Sender *et al.*, 2016; Banerjee *et al.*, 2018; Clavijo and Flórez, 2018; Pandit *et al.*, 2018; Shang *et al.*, 2018; Carrasco *et al.*, 2019). Hence, the presence of beneficial microbiota plays an important part in production, protection from pathogens, and modulation of the immune system (Sekirov *et al.*, 2010; Clavijo and Flórez, 2018; Carrasco *et al.*, 2019). Moreover, it is demonstrated that microbiota composition and development is affected by both

intrinsic (such as age breed, maternal elements, sex and gastrointestinal location) and external factors (diet, housing, hygiene, temperature, litter or AB administration) (Clavijo and Flórez, 2018; Kers *et al.*, 2018). In this sense, the caecum is described as the organ with the greatest taxonomic diversity and abundance, and it is responsible for different important nutritional functions (Clavijo and Flórez, 2018).

Due to the emergence of MDR bacteria, society is pressing for a reduction in AMAs administration by finding effective alternatives to control infectious diseases at farm level (WHO, 2014; Alós, 2015; Gadde *et al.*, 2017). The variability obtained in different studies highlights the need to know how the microbiota evolves throughout the growing period under production conditions. The main results obtained in this study showed that there is a significant variation in microbiota diversity from arrival day to mid-period, and a less pronounced change from this point to the slaughter day, for both experimental groups. According to other authors, it could be deduced that fast and slow-growing broiler microbiota are in constant development throughout rearing, being relatively stable as of 21 days of age (Lu *et al.*, 2003; Mohd Shaufi *et al.*, 2015; Richards *et al.*, 2019; Xi *et al.*, 2019). Although some authors reported that bacterial diversity in the intestinal tract is higher in fast-growing breeds (Stanley *et al.*, 2012; Carrasco *et al.*, 2019), the results of this study showed a similar microbiota diversity for both breeds throughout the production cycle (Schokker *et al.*, 2015; Richards *et al.*, 2019). These results evidence that flock management during the production cycle is even more important than breed selected, in terms of microbiota balance control (Qu *et al.*, 2008; Kers *et al.*, 2018; Carrasco *et al.*, 2019).

Firmicutes and *Proteobacteria* were the most abundant phyla at the onset of the production cycle. However, while the *Firmicutes* increased their concentration for the throughout the growing period, the *Proteobacteria* decreased until the end of the cycle. *Proteobacteria* was found in a high concentration for both groups at the arrival day. However, in other moments of the growing period, an increment of this phylum is associated with dysbiosis and, consequently, with an increase in the presence of zoonotic bacteria belonging to this phylum, such as *Salmonella* or *Campylobacter* (Lu *et al.*, 2003; Ducatelle *et al.*, 2018; Kumar *et al.*, 2018; Yacoubi *et al.*, 2018; Rychlik, 2020). For this reason, it is important to ensure strict management practices from the start of the growing period, as any stress could produce an increment of this phylum, and could result in a

higher shedding of pathogenic bacteria and environmental contamination throughout rearing (Neal-McKinney *et al.*, 2012; Shin *et al.*, 2015; Ducatelle *et al.*, 2018; Carrasco *et al.*, 2019). It is an important concern for poultry sector to maintain these bacteria under control from the beginning to the end of rearing, the last step before loading, transport and processing of chickens at the slaughterhouse. Nowadays, *Campylobacter* and *Salmonella* are still the two most important causes of zoonotic diseases in Europe, and poultry products are the main source of human infection (EFSA and ECDC, 2019a).

Regarding the genus, it should be noted that the three most abundant groups for both groups, *Ruminococcus* spp., *Lactobacillus* spp. and *Bacteroides* spp., are related to better productive performance and intestinal health, so they could be considered indicators of adequate intestinal health in poultry. It is important to highlight that 75%, 93% and 97.8% of genus were common to both breeds, at the beginning, mid- and end period, respectively. These results could mean that microbiota would have similar development for both broiler breeds despite the rusticity (Zhao *et al.*, 2013; Richards *et al.*, 2019). Moreover, although there existed some variations at genus level, results obtained were also broadly similar for both breeds. According to other authors, slight changes in microbiota composition have not always entail a performance consequence (Torok *et al.*, 2011; Schokker *et al.*, 2015).

There are numerous factors that influence on microbiota composition development, and all of them should be valued globally *in situ*, under its specific production characteristics (Kers *et al.*, 2018). Therefore, developing molecular techniques that can be applied in the field to measure the balance of the microbiota in each specific case could help us assess the impact of different management techniques on day-to-day work, and could be a promising line of research for our sector.

In addition to the study of the microbiota throughout the production cycle, in the second study AMR and MDR dynamic in two genetic poultry breeds, fast-growing and slow-growing, during the growing period, using commensal *E. coli* as sentinel bacterium was studied.

It is well known that it is necessary to reduce AMAs administration in farms by finding effective alternative treatments, such as using more resistant breeds to improve animal welfare. However, to be able to assess the effect of the alternatives proposed, it is essential

to study the epidemiology of AMR under production conditions. The main results of this study demonstrated that although non-ABs were administered at any point, similar AMR rates were observed in both breeds (fast and slow-growing) at the end of the growing period. The results obtained were in accordance with those reported by the EFSA, which indicates that in 2016, the 77.8% of *E. coli* isolated from broilers in EU were AMR. However, there were large differences in AMR rates between EU MS, being notably lower in Nordic countries and higher in Southern countries, especially Spain (EFSA and ECDC, 2018). Regarding the different AB assessed, it is important to note that resistance to CST was found in both breeds, and it is a last-resort drug used to treat human infectious diseases caused by MDR bacteria (Kern, 2018). This fact can be explained by CST use in animal production for several years as a growth promoter, and its consequent high resistance level worldwide, including Europe, where growth promoters have been banned since 2006. The AMR rates observed in other ABs studied, such as CTX, CAZ, CHL and GEN were low, in accordance with results obtained in previous studies performed in the EU (EFSA and ECDC, 2018; MAPA, 2018). However, Koga *et al.* (2015) recorded higher resistance rates in commercial broiler production in Brazil to all these ABs, except to CAZ. Moreover, it is important to highlight the high AMR to CIP, NAL, AMP, SXT, AZM and TMP found in this study (Koga *et al.*, 2015; Hussain *et al.*, 2017; Ayandiran *et al.*, 2018; EFSA and ECDC, 2018). It is reported that slight variations in AMR rates among isolates between different studies could be due to the different analysis methods employed, the different management systems set up, level of AMR present in hatcheries and previous use of ABs in the study areas (Okorafor *et al.*, 2019). Specifically, for AMP, TMP and SXT, one hypothesis that could explain the results obtained in this study is that these ABs are permitted in Spain as therapeutic agents for bacterial infections (PRAN, 2018).

These results demonstrate the importance of AMR shedding from breeders to day-old chicks. In fact, several authors have shown that day-old-chicks are potential reservoirs of MDR enterobacteria obtained vertically from breeders (Jiménez-Belenguier *et al.*, 2016; Projahn *et al.*, 2017a,b; Okorafor *et al.*, 2019). These MDR bacteria could be transmitted through contaminated eggshells and/or from parent stock to hatchery (Daehre *et al.*, 2017; Projahn *et al.*, 2017a; Osman *et al.*, 2018). Indeed, it is demonstrated that vertical transmission to chicks from the top of the production pyramid origins the introduction

and spread of resistance genes in the poultry production chain (Borjesson *et al.*, 2016; Osman *et al.*, 2018).

Moreover, horizontal transmission of AMR is also an important concern for the poultry industry (Szmolka and Nagy, 2013; Bengtsson-Palme *et al.*, 2017; Agyare *et al.*, 2018). Actually, genomic analysis of the bacteria indicates that they could acquire their resistance profiles by incorporating different genetic elements through horizontal gene transfer (Agyare *et al.*, 2018). For this reason, different scientific studies underline the importance of developing sanitary measures at the interface between the environment and livestock farming (Allen *et al.*, 2010; Bengtsson-Palme *et al.*, 2018; Westphal-Settele *et al.*, 2018). However, it is important to highlight that in this study the animals' origin is from the same hatchery. For this reason, further studies are necessary to compare the AMR dynamics from different companies.

In conclusion, the fact that similar AMR rates were observed in both breeds, strongly suggests the possibility of vertical transmission from hatcheries and the subsequent dissemination through the environment and between flocks. However, further studies are needed to confirm this hypothesis. Moreover, innovative-cost effective tools should be implemented at farm level to avoid AMAs administration whenever possible in all the broiler production chain.

Historically, poultry veterinarians have mainly used AMAs to fight against infectious diseases. However, current social demand for AB-free meat has increased. In this social context, alternative production systems are being developed, to avoid the drawbacks of more intensive production, while also trying to maintain the profitability of their farms (Gocsik *et al.*, 2016; El-Deek and El-Sabrou, 2019). As described previously, microbiota play a considerable role in animal health. Thus, increasing animal welfare in poultry production above the standards laid down in European Union legislation could improve the intestinal microbiota balance, increasing the resilience of the animals, lessening the prevalence of infectious diseases and, in consequence, reducing AB administration in animal production (Teirlynck *et al.*, 2011; Chen *et al.*, 2015; Ducatelle *et al.*, 2018; Maki *et al.*, 2019; Díaz-Sánchez *et al.*, 2019; Ocejó *et al.*, 2019). In this context, the aim of the second experiment was to study the effect of the management system (density and ventilation) on the intestinal microbiota, antimicrobial resistance dynamics and *Salmonella* spp. epidemiology.

The first study assessed the influence on microbiota balance of broilers in standardised commercial farm conditions or under improved farm conditions, using 16S rRNA sequencing analysis.

As reported above, poultry is one of the main agricultural sub-sectors worldwide. However, public concern regarding animal welfare and AMR has risen in recent years. In this context, microbiota might be considered to evaluate poultry welfare and health, due to the influence of management practices in its composition. In fact, the main results of this study demonstrated significant differences on microbiota diversity between farm conditions at slaughter day (42 days of age), where animals reared under less intensive farm conditions showed a high diversity level. It is well known that a greater complexity of the gut microbiota is observed as animals grow and became relatively stable as of mid-period (Lu *et al.*, 2003; Amit-Romach *et al.*, 2004; Kers *et al.*, 2018; Shang *et al.*, 2018; Kollarčíková *et al.*, 2019), but high stocking density and heat stress present at the end of the cycle usually induce oxidation alteration, which is closely related to intestinal barrier integrity, which is in turn related to gut microbiota balance (Song *et al.*, 2014; He *et al.*, 2019; Yang *et al.*, 2019; Paraskeuas and Mountzouris, 2019; Slawinska *et al.*, 2019).

Regarding microbiota composition, the most predominant phyla observed were *Firmicutes*, followed by *Proteobacteria* at the onset of the growing period, and by *Bacteroidetes* during the rest of the cycle, and the most common groups observed at genus level for both management systems were *Oscillospira* spp., *Ruminococcus* spp., *Bacteroides* spp. and *Coprococcus* spp. Both predominant phyla and genera were in accordance with the bibliography (Wei *et al.*, 2013; Mohd Shaufi *et al.*, 2015; Kumar *et al.*, 2018; Pandit *et al.*, 2018; Carrasco *et al.*, 2019; Hasan and Yang, 2019; He *et al.*, 2019; Xi *et al.*, 2019). This fact evidences that although the microbiota diversity is low in animals housed according to the European Union legislation, stress levels are not enough to change the microbiota composition.

In conclusion, microbiota diversity increases throughout the growing period, being relatively stable since the mid-period. However, at the end of the rearing, a significant higher level of microbiota complexity was observed in animals reared under less intensive farm conditions. Regarding microbiota composition, no statistical differences were observed between experimental groups. For both of them *Firmicutes* was the most abundant phylum during all the growing period, *Proteobacteria* decreased their

concentration throughout the growing, and *Bacteroidetes* increased. At genus level, the predominant groups for both management systems were *Oscillospira* spp., *Ruminococcus* spp., *Bacteroides* spp. and *Coprococcus* spp. Thus, it could be recommended to reassess the management farm conditions using gut microbiota diversity and composition as biomarkers of animal health. This could be an important tool for infectious diseases control to reduce the AMAs administration at farm level.

In addition to the study of the microbiota throughout the production cycle, the AMR and MDR dynamics in broiler chickens during the rearing period under two different management conditions (commercial vs. improved), using *E. coli* as sentinel bacterium was studied. The most relevant results obtained showed that despite the fact that no ABs were administered, the 83.3% of *E. coli* isolates obtained were AMR, and 57.3% of them were MDR, with slight variations between sampling moments. These data could be explained by a vertical or a horizontal resistance acquisition from breeders (Osman *et al.*, 2018; Marin *et al.*, 2020) or the environment (Oikarainen *et al.*, 2019), respectively.

At the beginning of the study, 80% of the *E. coli* isolates were AMR, and 62.5% of them were MDR. These results show the importance of AMR and MDR acquisition from breeding, hatching or transport environment (Poulsen *et al.*, 2017; Dame-Korevaar *et al.*, 2019), being an important threat requiring strict management control in these initial stages to reduce the selective AMR/MDR pressure (Dierikx *et al.*, 2013; Aarestrup, 2015).

The highest resistances observed were to CIP, NAL and AMP, in line with results reported by the EFSA (EFSA and ECDC, 2020). However, any strain resistant against CST and TGC was isolated, revealing that the strategies implemented by governments and poultry industry to control the use of critical AMAs are having an important effect at field level (WHO, 2011).

Moreover, in this study, resistant bacteria to CAZ and AZM appeared at the end of the growing period, and the resistant bacteria to GEN and TMP increased. This could be explained due to a horizontal transmission of resistance genes from the environment, which is considered a critical point in livestock production. Thus, it is important to highlight the role of proper protocols of cleansing and disinfection at the end or rearing to avoid horizontal dissemination of resistances between flocks (Marin *et al.*, 2011; Davies and Wales, 2019; Chuppava *et al.*, 2019; Luiken *et al.*, 2020).

It has been demonstrated that an increase in animal welfare reduces interactions between environmental and intestinal bacteria because it promotes the presence of beneficial microbiota and the integrity of the intestinal epithelium. However, in this study it has been observed that although animals subjected to less intensive production conditions showed a lower level of MDR at mid-period, at the slaughter day the presence of AMR and MDR were particularly high for both groups. This fact could be explained by the high AMR rates observed at the arrival day, and the short time of rearing (42 days), highlighting the importance of controlling the use of AMAs in the first stages of poultry production system (Dierikx *et al.*, 2013). In addition, it is important not to forget that at the end of the growing period, when the highest levels of AMR have been observed, animals are handled for transport to the slaughterhouse, which could involve an increase in stress, intestinal dysbiosis and excretion of microorganisms in faeces just before processing of the carcasses, constituting an important threat to consumers (Marin and Lainez, 2009; Gregova *et al.*, 2012; Althaus *et al.*, 2017; Sevilla-Navarro *et al.*, 2020). For this reason, further studies are needed to evaluate how management could reduce the presence of AMR and MDR bacteria in poultry production at all production stages.

In accordance with the increasing consumer concern for animal welfare and the public health issue of AMR, the development of *S. Infantis* AMR during the broiler growing period, according to density and ventilation management was also assessed in the last study.

Despite the strict legislation against *Salmonella*, these bacteria remain the principal source of human foodborne outbreaks in Europe, and poultry products are the main source involved in human cases of salmonellosis (EFSA and ECDC, 2004; Bhaisare *et al.*, 2014; EFSA and ECDC, 2019a,b). Moreover, *S. Infantis* is an emerging serovar of great concern for European broiler production, as it has been demonstrated that this serovar is present in 50% of *Salmonella* contaminated broiler meat samples analysed (EFSA and ECDC, 2019a,c). One hypothesis that explains the emergence of *S. Infantis* in the poultry sector is its great ability to gain AMR from the gut microbiota and/or environment (Shah *et al.*, 2016; Abdi *et al.*, 2017; Cohen *et al.*, 2020). Consequently, nowadays *S. Infantis* control at farm level is one of the main objectives for the poultry sector.

Different authors indicate that less intensive production systems, increase the potential of the animals' immune system to protect them against pathogens (Soleimani *et al.*, 2012;

Gomes *et al.*, 2014; Scanes, 2016; Calefi *et al.*, 2017; Dawkins, 2017; Desoky, 2018; Farag and Alagawany, 2018a; EFSA and ECDC, 2019a). However, the results of this study showed that AMR rates of *Salmonella* isolates did not present statistical differences between treatments, despite the improvement in management conditions. In addition, it is important to underscore that a high percentage of *S. Infantis* isolates obtained during the growing period were MDR, although no ABs were administrated (Andoh *et al.*, 2016; Sohan Rodney Bangera *et al.*, 2019; EFSA and ECDC, 2019c). Different hypotheses could explain this fact. Previous studies, using genomic analysis, indicated that bacteria could acquire resistance genes by incorporating different genetic elements through horizontal gene transfer from other bacteria and/or from the environment (Cosby *et al.*, 2015; Projahn *et al.*, 2017a,b; Osman *et al.*, 2018; Daehre *et al.*, 2018; Agyare *et al.*, 2018; Okorafor *et al.*, 2019). In consequence, the commensal microbiota could acquire the AMR from the environment, and intestinal zoonotic bacteria such as *Salmonella*, could acquire the AMR genes by conjugation, transformation or transduction mechanisms (Tripathi and Tripathi, 2017; EFSA and ECDC, 2020). For this reason, different scientific studies underline the importance of developing sanitary measures at the interface between the environment and livestock farming (Allen *et al.*, 2010; Bengtsson-Palme *et al.*, 2018; Westphal-Settele *et al.*, 2018). However, further studies are needed to confirm the main source of AMR present in *Salmonella* strains at farm level. Moreover, it is important to highlight the results obtained against CST and TGC, as they are considered critically important antimicrobials used as last-resort drugs to treat human infectious diseases (Kern, 2018; EFSA and ECDC, 2020). On the one hand, no isolates showed AMR to TGC. The results agree with that reported by the EFSA (EFSA and ECDC, 2020), and it might be explained by the restricted use to human in hospital treatments (WHO, 2019). Conversely, the presence of AMR against CST could be due to its use in animal production for several years to treat infectious diseases and as a growth promotor (EMA, 2018) and, as indicated by previous studies, resistant genes could remain in the environment and reach the microbiota of animals, and from there transmitted to zoonotic bacteria. This study reveals the importance of AMR monitoring in zoonotic and commensal bacteria in food-producing animals and their food products to be able to understand the development and diffusion of resistance (EFSA and ECDC, 2019d, 2020).

In conclusion, the results of this study showed that when chicks are infected with the serovar *S. Infantis* at day one of the growing period, they continue shedding the bacteria

in faeces until the slaughter day. Besides, the acquisition of AMR began at the onset of the production cycle and continue until the end, regardless of different management conditions applied. Nevertheless, it is important to highlight that no molecular studies of the microbiota interaction have been done in this study, which may restrict the interpretation of the results obtained. Thus, further deeply studies of the plasmids, pathogenicity islands or transposons are needed to achieve a better knowledge of *S. Infantis* AMR dynamics at the farm level, in order to establish better control programmes and reduce its prevalence throughout the food chain.

As final conclusion of this doctoral thesis, the main results obtained include that microbiota diversity and composition are in constant development throughout the growing period, being affected by farm management factors, and evidencing real health and welfare status of animals. Moreover, AMR is present in commensal bacteria as of the arrival day and increases until the end of the rearing period, emphasising the need to control AMAs administration in all the stages of poultry production. Regarding *S. Infantis* epidemiology, the continuous shedding during all the growing period and its ability to gain AMR, regardless of farm management conditions, strongly suggest the need for further studies to being able to establish better control programmes to control the bacteria presence in the food chain. This doctoral thesis constitutes a transversal tool to evaluate the alternative poultry production systems developed to meet consumer demands under a new future perspective, connecting sustainability and technology in benefit of animal, human and environmental health.

4.1 References

- Aarestrup, F. M. 2015. The livestock reservoir for antimicrobial resistance: A personal view on changing patterns of risks, effects of interventions and the way forward. *Philos. Trans. R. Soc. B Biol. Sci.* 370.
- Abdi, R. D., F. Mengstie, A. F. Beyi, T. Beyene, H. Waktole, B. Mammo, D. Ayana, and F. Abunna. 2017. Determination of the sources and antimicrobial resistance patterns of *Salmonella* isolated from the poultry industry in Southern Ethiopia. *BMC Infect. Dis.* 17:1–12.
- Agyare, C., V. E. Boamah, C. N. Zumbi and F. B. Osei. 2018. Antibiotic Use in Poultry Production and its Effects on Bacterial Resistance. Pages 1-20 in *Antimicrobial Resistance – A Global Threat*, ed. Yashwant Kumar, London, United Kingdom.
- Allen, H. K., J. Donato, H. H. Wang, K. A. Cloud-Hansen, J. Davies, and J. Handelsman. 2010. Call of the wild: Antibiotic resistance genes in natural environments. *Nat. Rev. Microbiol.* 8:251–259.
- Alós J. 2015. Resistencia bacteriana a los antibióticos: una crisis global. *Enferm. Infecc. Microbiol. Clin.* 33:692–699.
- Althaus, D., C. Zweifel, and R. Stephan. 2017. Analysis of a poultry slaughter process: Influence of process stages on the microbiological contamination of broiler carcasses. *Ital. J. Food Saf.* 6:190–194.
- Amit-Romach, E., D. Sklan, and Z. Uni. 2004. Microflora ecology of the chicken intestine using 16S ribosomal DNA primers. *Poult. Sci.* 83:1093–1098.
- Andoh, L. A., A. Dalsgaard, K. Obiri-Danso, M. J. Newman, L. Barco, and J. E. Olsen. 2016. Prevalence and antimicrobial resistance of *Salmonella* serovars isolated from poultry in Ghana. *Epidemiol. Infect.* 144:3288–3299.
- Ayandiran, T. O., L. Falgenhauer, J. Schmiede, T. Chakraborty and F. A. Ayeni. 2018. High resistance to tetracycline and ciprofloxacin in bacteria isolated from poultry farms in Ibadan, Nigeria. *J Infect Dev Ctries.* 12:462-470.

Banerjee, S., A. Sar, A. Misra, S. Pal, A. Chakraborty, and B. Dam. 2018. Increased productivity in poultry birds by sub-lethal dose of antibiotics is arbitrated by selective enrichment of gut microbiota, particularly short-chain fatty acid producers. *Microbiol. (United Kingdom)* 164:142–153.

Bengtsson-Palme, J., E. Kristiansson, and D. G. J. Larsson. 2018. Environmental factors influencing the development and spread of antibiotic resistance. *FEMS Microbiol. Rev.* 42:68–80.

Bhaisare, D. B., D. Thyagarajan, R. R. Churchil, and N. Punniamurthy. 2014. Bacterial Pathogens in Chicken Meat: Review. *Int. J. Life Sci. Res.* ISSN 2:2348–313.

Borjesson, S., S. Ny, M. Egervarn, J. Bergstrom, A. Rosengren, S. Englund, S. Lofmark and S. Byfors. 2016. Limited dissemination of extended-spectrum beta-lactamase- and plasmid-encoded AmpC-producing *Escherichia coli* from food and farm animals, Sweden. *Emerg. Infect. Dis.* 22: 634-640.

Calefi, A. S., W. M. Quinteiro-Filho, A. J. P. Ferreira, and J. Palermo-Neto. 2017. Neuroimmunomodulation and heat stress in poultry. *Worlds. Poult. Sci. J.* 73:493–504.

Carrasco, J. M. D., N. A. Casanova, and M. E. F. Miyakawa. 2019. Microbiota, gut health and chicken productivity: What is the connection? *Microorganisms* 7:1–15.

Castellini, C. and A. Dal Bosco. 2017. Poultry Quality Evaluation: Quality Attributes and Consumer Values. Pages 335-357 in *Animal Welfare and Poultry Meat in Alternative Production Systems (and Ethics of Poultry Meat Production)*. Woodhead Publishing Series in Food Science, Technology and Nutrition, Elsevier Ltd. 2017.

Chen, J., G. Tellez, J. D. Richards, and J. Escobar. 2015. Identification of potential biomarkers for gut barrier failure in broiler chickens. *Front. Vet. Sci.* 2.

Chuppava, B., B. Keller, A. Abd El-Wahab, C. Sürrie, and C. Visscher. 2019. Resistance Reservoirs and Multi-Drug Resistance of Commensal *Escherichia coli* From Excreta and Manure Isolated in Broiler Houses With Different Flooring Designs. *Front. Microbiol.* 10.

Clavijo, V., and M. J. V. Flórez. 2018. The gastrointestinal microbiome and its association with the control of pathogens in broiler chicken production: A review. *Poult. Sci.* 97:1006–1021.

Cohen, E., M. Davidovich, A. Rokney, L. Valinsky, G. Rahav, and O. Gal-Mor. 2020. Emergence of new variants of antibiotic resistance genomic islands among multidrug-resistant *Salmonella enterica* in poultry. *Environ. Microbiol.* 22:413–432.

Cosby, D. E., N. A. Cox, M. A. Harrison, J. L. Wilson, R. Jeff Buhr, and P. J. Fedorka-Cray. 2015. *Salmonella* and antimicrobial resistance in broilers: A review. *J. Appl. Poult. Res.* 24:408–426.

Daehre, K., M. Projahn, T. Semmler, U. Roesler, and A. Friese. 2018. Extended-Spectrum Beta-Lactamase-/AmpC Beta-Lactamase-Producing Enterobacteriaceae in Broiler Farms: Transmission Dynamics at Farm Level. *Microb. Drug Resist.* 24:511–518.

Dame-Korevaar, A., E. A. J. Fischer, J. van der Goot, F. Velkers, J. van den Broek, K. Veldman, D. Ceccarelli, D. Mevius, and A. Stegeman. 2019. Effect of challenge dose of plasmid-mediated extended-spectrum β -lactamase and AmpC β -lactamase producing *Escherichia coli* on time-until-colonization and level of excretion in young broilers. *Vet. Microbiol.* 239:108446.

Davies, R., and A. Wales. 2019. Antimicrobial Resistance on Farms: A Review Including Biosecurity and the Potential Role of Disinfectants in Resistance Selection. *Compr. Rev. Food Sci. Food Saf.* 18:753–774.

Dawkins, M. S. 2017. Animal welfare and efficient farming: is conflict inevitable? *Anim. Prod. Sci.* 57:201.

Desoky, A. A. 2018. Growth Performance and Immune Response of Broiler Chickens Reared Under High Stocking Density and Vitamin E Supplementation. 5623.

Díaz-Sánchez, S., A. R. Perrotta, I. Rockafellow, E. J. Alm, R. Okimoto, R. Hawken, and I. Hanning. 2019. Using fecal microbiota as biomarkers for predictions of performance in the selective breeding process of pedigree broiler breeders. *PLoS One* 14.

Dierikx, C. M., J. A. van der Goot, H. E. Smith, A. Kant, and D. J. Mevius. 2013. Presence of ESBL/AmpC -Producing *Escherichia coli* in the Broiler Production Pyramid: A Descriptive Study (A Cloeckaert, Ed.). PLoS One 8:e79005.

Ducatelle, R., E. Goossens, F. De Meyer, V. Eeckhaut, G. Antonissen, F. Haesebrouck, and F. Van Immerseel. 2018. Biomarkers for monitoring intestinal health in poultry: Present status and future perspectives. Vet. Res. 49:1–9.

EFSA and ECDC (European Food Safety Authority and European Centre for Disease Prevention and Control). 2004. Opinion of the Scientific Panel on biological hazards (BIOHAZ) related to the use of vaccines for the control of *Salmonella* in poultry. EFSA J. 2:1–74.

EFSA and ECDC (European Food Safety Authority and European Centre for Disease Control). 2018. The European Union summary report on antimicrobial resistance in zoonotic and indicator bacteria from humans, animals and food in 2016. EFSA Journal 16:5182.

EFSA and ECDC (European Food Safety Authority and European Centre for Disease Prevention and Control). 2019a. The European Union One Health 2018 Zoonoses Report. EFSA J. 2019;17:5926.

EFSA and ECDC (European Food Safety Authority and European Centre for Disease Prevention and Control). 2019b. *Salmonella* control in poultry flocks and its public health impact. EFSA J. 17.

EFSA and ECDC (European Food Safety Authority and European Centre for Disease Prevention and Control). K. Koutsoumanis, A. Allende, A. Alvarez-Ordóñez, D. Bolton, S. Bover-Cid, M. Chemaly, A. De Cesare, L. Herman, F. Hilbert, R. Lindqvist, M. Nauta, L. Peixe, G. Ru, M. Simmons, P. Skandamis, E. Suffredini, J. Dewulf, T. Hald, V. Michel, N. Taina, A. Ricci, E. Snary, F. Boelaert, W. Messens, and R. Davies. 2019c. Opinion of the Scientific Panel on biological hazards (BIOHAZ) on the *Salmonella* control in poultry flocks and its public health impact.pdf. EFSA J. 17:5596.

EFSA and ECDC (European Food Safety Authority and European Centre for Disease Prevention and Control). 2019d. Technical specifications on harmonised monitoring of

antimicrobial resistance in zoonotic and indicator bacteria from food-producing animals and food. EFSA J. 17.

EFSA and ECDC (European Food Safety Authority and European Centre for Disease Prevention and Control). 2020. The European Union Summary Report on Antimicrobial Resistance in zoonotic and indicator bacteria from humans, animals and food in 2017/2018. EFSA J. 18.

El-Deek, A., and K. El-Sabrou. 2019. Behaviour and meat quality of chicken under different housing systems. Worlds. Poult. Sci. J. 75:105–114.

EMA (European Medicines Agency). 2020. Sales of veterinary antimicrobial agents in 31 European countries in 2018 (EMA/24309/2020). Trends from 2010 to 2018. Tenth ESVAC Rep. Available at <https://www.who.int/foodsafety/publications/antimicrobials->.

Farag, M. R., and M. Alagawany. 2018. Physiological alterations of poultry to the high environmental temperature. J. Therm. Biol. 76:101–106.

Gadde, U., W. H. Kim, S. T. Oh, and H. S. Lillehoj. 2017. Alternatives to antibiotics for maximizing growth performance and feed efficiency in poultry: a review. Anim. Heal. Res. Rev. 18:26–45.

Gocsik, É., S. D. Brooshooft, I. C. de Jong, and H. W. Saatkamp. 2016. Cost-efficiency of animal welfare in broiler production systems: A pilot study using the Welfare Quality® assessment protocol. Agric. Syst. 146:55–69.

Gomes, A. V. S., W. M. Quinteiro-Filho, A. Ribeiro, V. Ferraz-de-Paula, M. L. Pinheiro, E. Baskeville, A. T. Akamine, C. S. Astolfi-Ferreira, A. J. P. Ferreira, and J. Palermo-Neto. 2014. Overcrowding stress decreases macrophage activity and increases *Salmonella* Enteritidis invasion in broiler chickens. Avian Pathol. 43:82–90.

Gregova, G., M. Kmetova, V. Kmet, J. Venglovsky, and A. Feher. 2012. Antibiotic resistance of *Escherichia coli* isolated from a poultry slaughterhouse. Ann. Agric. Environ. Med. 19:75–77.

Hasan, N., and H. Yang. 2019. Factors affecting the composition of the gut microbiota, and its modulation. PeerJ 8:1–31.

He, J., Y. He, D. Pan, J. Cao, Y. Sun, and X. Zeng. 2019. Associations of gut microbiota with heat stress-induced changes of growth, fat deposition, intestinal morphology, and antioxidant capacity in ducks. *Front. Microbiol.* 10:1–13.

Hussain, A., S. Shaik, A. Ranjan, N. Nandanwar, S.K. Tiwari, M. Majid, R. Baddam, I.A. Qureshi, T. Semmler, L.H. Wieler, M.A. Islam, D. Chakravorty and N. Ahmed. 2017. Risk of Transmission of Antimicrobial Resistant *Escherichia coli* from Commercial Broiler and Free-Range Retail Chicken in India. *Front Microbiol.* 8:2120.

Kern, W.V. 2018. Multiresistant Bacteria - Antibiotic Prescription and Antibiotics of Last Resort. *Dtsch Med Wochenschr.* 143:643-650.

Kers, J. G., F. C. Velkers, E. A. J. Fischer, G. D. A. Hermes, J. A. Stegeman, and H. Smidt. 2018. Host and environmental factors affecting the intestinal microbiota in chickens. *Front. Microbiol.* 9:1–14.

Koga, V. L., S. Scandorieiro, E. C. Vespero, A. Oba, B. G. de Brito, K. C. de Brito, G. Nakazato and R. K. Kobayashi. 2015. Comparison of Antibiotic Resistance and Virulence Factors among *Escherichia coli* Isolated from Conventional and Free-Range Poultry. *Biomed Res Int.* 618752.

Kollarcikova, M., T. Kubasova, D. Karasova, M. Crhanova, D. Cejkova, F. Sisak, and I. Rychlik. 2019. Use of 16S rRNA gene sequencing for prediction of new opportunistic pathogens in chicken ileal and cecal microbiota. *Poult. Sci.* 98:2347–2353.

Kumar, S., C. Chen, N. Indugu, G. O. Werlang, M. Singh, W. K. Kim, and H. Thippareddi. 2018. Effect of antibiotic withdrawal in feed on chicken gut microbial dynamics, immunity, growth performance and prevalence of foodborne pathogens. *PLoS One* 13:1–23.

Lu, J., U. Idris, B. Harmon, C. Hofacre, J. J. Maurer, and M. D. Lee. 2003. Diversity and Succession of the Intestinal Bacterial Community of the Maturing Broiler Chicken. *Appl. Environ. Microbiol.* 69:6816–6824.

Luiken, R. E. C., L. Van Gompel, A. Bossers, P. Munk, P. Joosten, R. B. Hansen, B. E. Knudsen, S. García-Cobos, J. Dewulf, F. M. Aarestrup, J. A. Wagenaar, L. A. M. Smit,

D. J. Mevius, D. J. J. Heederik, and H. Schmitt. 2020. Farm dust resistomes and bacterial microbiomes in European poultry and pig farms. *Environ. Int.* 143.

Lusk, J. L. 2018. Consumer preferences for and beliefs about slow growth chicken. *Poult Sci.* 97:4159-4166.

Maki, J. J., C. L. Klima, M. J. Sylte, and T. Looft. 2019. The microbial pecking order: Utilization of intestinal microbiota for poultry health. *Microorganisms* 7.

MAPA (Ministry of Agriculture, Fishing and Food). 2018. Informe JIACRA España. Primer análisis integrado del consumo de antibióticos y su relación con la aparición de resistencia. Accessed Jul. 2019. <http://www.resistenciaantibioticos.es/es/publicaciones/informe-jiacra-espana>.

Marin, C., S. Balasch, S. Vega, and M. Lainez. 2011. Sources of *Salmonella* contamination during broiler production in Eastern Spain. *Prev. Vet. Med.* 98:39–45.

Marin, C., and M. Lainez. 2009. *Salmonella* detection in feces during broiler rearing and after live transport to the slaughterhouse. *Poult. Sci.* 88:1999–2005.

Marin, C., S. Sevilla-Navarro, R. Lonjedo, P. Catalá-Gregori, M. A. Ferrús, S. Vega, and A. Jiménez-Belenguer. 2020. Genotyping and molecular characterization of antimicrobial resistance in thermophilic *Campylobacter* isolated from poultry breeders and their progeny in Eastern Spain. *Poult. Sci.* 99:5096–5104.

Mohd Shaufi, M. A., C. C. Sieo, C. W. Chong, H. M. Gan, and Y. W. Ho. 2015. Deciphering chicken gut microbial dynamics based on high-throughput 16S rRNA metagenomics analyses. *Gut Pathog.* 7:1–12.

Neal-McKinney, J. M., X. Lu, T. Duong, C. L. Larson, D. R. Call, D. H. Shah, and M. E. Konkel. 2012. Production of Organic Acids by Probiotic Lactobacilli Can Be Used to Reduce Pathogen Load in Poultry. *PLoS One* 7.

Oakley, B. B., H. S. Lillehoj, M. H. Kogut, W. K. Kim, J. J. Maurer, A. Pedroso, M. D. Lee, S. R. Collett, T. J. Johnson, and N. A. Cox. 2014. The chicken gastrointestinal microbiome. *FEMS Microbiol. Lett.* 360:100–112.

Ocejo, M., B. Oporto, and A. Hurtado. 2019. 16S rRNA amplicon sequencing characterization of caecal microbiome composition of broilers and free-range slow-growing chickens throughout their productive lifespan. *Sci. Rep.* 9:1–14.

Oikarainen, P. E., L. K. Pohjola, E. S. Pietola, and A. Heikinheimo. 2019. Direct vertical transmission of ESBL/pAmpC-producing *Escherichia coli* limited in poultry production pyramid. *Vet. Microbiol.* 231:100–106.

Okorafor, O. N., M. U. Anyanwu, E. O. Nwafor, G. N. Anosa, and R. I. Udegbonam. 2019. Multidrug-resistant enterobacteria colonize commercial day-old broiler chicks in Nigeria. *Vet. World* 12:418–423.

Osman, K. M., A. D. Kappell, M. Elhadidy, F. Elmougy, W. A. A. El-Ghany, A. Orabi, A. S. Mubarak, T. M. Dawoud, H. A. Hemeg, I. M. I. Moussa, A. M. Hessain, and H. M. Y. Yousef. 2018. Poultry hatcheries as potential reservoirs for antimicrobial-resistant *Escherichia coli*: A risk to public health and food safety. *Sci. Rep.* 8:1–14.

Pandit, R. J., A. T. Hinsu, N. V. Patel, P. G. Koringa, S. J. Jakhesara, J. R. Thakkar, T. M. Shah, G. Limon, A. Psifidi, J. Guitian, D. A. Hume, F. M. Tomley, D. N. Rank, M. Raman, K. G. Tirumurugaan, D. P. Blake, and C. G. Joshi. 2018. Microbial diversity and community composition of caecal microbiota in commercial and indigenous Indian chickens determined using 16s rDNA amplicon sequencing. *Microbiome* 6:1–13.

Paraskeuas, V., and K. C. Mountzouris. 2019. Broiler gut microbiota and expressions of gut barrier genes affected by cereal type and phytogetic inclusion. *Anim. Nutr.* 5:22–31.

Poulsen, L. L., I. Thøfner, M. Bisgaard, J. P. Christensen, R. H. Olsen, and H. Christensen. 2017. Longitudinal study of transmission of *Escherichia coli* from broiler breeders to broilers. *Vet. Microbiol.* 207:13–18.

Pourabedin, M., and X. Zhao. 2015. Prebiotics and gut microbiota in chickens. *FEMS Microbiol. Lett.* 362:1–8.

PRAN (Plan Nacional Resistencia Antibióticos). 2018. Antibióticos críticos. Accessed Jun. 2019. <http://resistenciaantibioticos.es/es/profesionales/vigilancia/antibioticos-criticos>.

- Projahn, M., K. Daehre, U. Roesler and A. Friese. 2017. Extended-spectrum beta-lactamase and plasmid-encoded cephamycins-producing enterobacteria in broiler hatchery as a potential mode of pseudovertical transmission. *Appl. Environ. Microbiol.* 83:e02364.
- Projahn, M., K. Daehre, T. Semmler, S. Guenther, U. Roesler and A. Friese. 2017b. Environmental adaptation and vertical dissemination of ESBL-/pAmpC-producing *Escherichia coli* in an integrated broiler production chain in the absence of antibiotic treatment. *Microb. Biotechnol.* 11:1017-1026.
- Qu, A., J. M. Brulc, M. K. Wilson, B. F. Law, J. R. Theoret, L. A. Joens, M. E. Konkel, F. Angly, E. A. Dinsdale, R. A. Edwards, K. E. Nelson, and B. A. White. 2008. Comparative metagenomics reveals host specific metavirulomes and horizontal gene transfer elements in the chicken cecum microbiome. *PLoS One* 3.
- Richards, P., J. Fothergill, M. Bernardeau, and P. Wigley. 2019. Development of the caecal microbiota in three broiler breeds. *Front. Vet. Sci.* 6.
- Rychlik, I. 2020. Composition and function of chicken gut microbiota. *Animals* 10.
- Scanes, C. G. 2016. Biology of stress in poultry with emphasis on glucocorticoids and the heterophil to lymphocyte ratio. *Poult. Sci.* 95:2208–2215.
- Schokker, D., G. Veninga, S. A. Vastenhouw, A. Bossers, F. M. de Bree, L. M. T. E. Kaal-Lansbergen, J. M. J. Rebel, and M. A. Smits. 2015. Early life microbial colonization of the gut and intestinal development differ between genetically divergent broiler lines. *BMC Genomics* 16.
- Sekirov, I., S. L. Russell, L. Caetano M Antunes, and B. B. Finlay. 2010. Gut microbiota in health and disease. *Physiol. Rev.* 90:859–904.
- Sender, R., S. Fuchs, and R. Milo. 2016. Revised Estimates for the Number of Human and Bacteria Cells in the Body. *PloS Biol.* 14.
- Sevilla-Navarro, S., C. Marin, V. Cortés, C. García, and P. Catalá-Gregori. 2020. *Campylobacter* prevalence and risk factors associated with exceeding allowable limits in poultry slaughterhouses in Spain. *Vet. Rec.* 186.

Shah, D. H., N. C. Paul, W. C. Sisco, R. Crespo, and J. Guard. 2016. Population dynamics and antimicrobial resistance of the most prevalent poultry-associated *Salmonella* serotypes. *Poult. Sci.* 96:687–702.

Shang, Y., S. Kumar, B. Oakley, and W. K. Kim. 2018. Chicken gut microbiota: Importance and detection technology. *Front. Vet. Sci.* 5.

Shin, N. R., T. W. Whon, and J. W. Bae. 2015. Proteobacteria: Microbial signature of dysbiosis in gut microbiota. *Trends Biotechnol.* 33:496–503.

Slawinska, A., S. Mendes, A. Dunislawska, M. Siwek, M. Zampiga, F. Sirri, A. Meluzzi, S. Tavaniello, and G. Maiorano. 2019. Avian model to mitigate gut-derived immune response and oxidative stress during heat. *BioSystems* 178:10–15.

Sohan Rodney Bangera, S. Umakanth, G. Chowdhury, Rudra Narayan Saha, A. K. Mukhopadhyay, and M. Ballal. 2019. Poultry: A receptacle for non-typhoidal *salmonellae* and antimicrobial resistance. *Iran. J. Microbiol.* 11:31–38.

Soleimani, A. F., I. Zulkifli, M. Hair-Bejo, M. Ebrahimi, S. D. Jazayeri, S. R. Hashemi, A. Meimandipour, and Y. M. Goh. 2012. Epigenetic modification: possible approach to reduce *Salmonella enterica* serovar enteritidis susceptibility under stress conditions. *Avian Pathol.* 41:351–354.

Song, J., K. Xiao, Y. L. Ke, L. F. Jiao, C. H. Hu, Q. Y. Diao, B. Shi, and X. T. Zou. 2014. Effect of a probiotic mixture on intestinal microflora, morphology, and barrier integrity of broilers subjected to heat stress. *Poult. Sci.* 93:581–588.

Stanley, D., S. E. Denman, R. J. Hughes, M. S. Geier, T. M. Crowley, H. Chen, V. R. Haring, and R. J. Moore. 2012. Intestinal microbiota associated with differential feed conversion efficiency in chickens. *Appl. Microbiol. Biotechnol.* 96:1361–1369.

Stanley, D., R. J. Hughes, and R. J. Moore. 2014. Microbiota of the chicken gastrointestinal tract: Influence on health, productivity and disease. *Appl. Microbiol. Biotechnol.* 98:4301–4310.

Szmolka, A and B. Nagy. 2013. Multidrug resistant commensal *Escherichia coli* in animals and its impact for public health. *Front Microbiol.* 4: 258.

Teirlynck, E., M. D. E. Gussem, J. Dewulf, F. Haesebrouck, R. Ducatelle, and F. van Immerseel. 2011. Morphometric evaluation of ‘dysbacteriosis’ in broilers. *Avian Pathol.* 40:139–144.

Torok, V. A., R. J. Hughes, L. L. Mikkelsen, R. Perez-Maldonado, K. Balding, R. MacAlpine, N. J. Percy, and K. Ophel-Keller. 2011. Identification and characterization of potential performance-related gut microbiotas in broiler chickens across various feeding trials. *Appl. Environ. Microbiol.* 77:5868–5878.

Tripathi V, Tripathi P. Antibiotic Resistance Genes: An Emerging Environmental Pollutant. In: *Perspectives in Environmental Toxicology. Environmental Science and Engineering*, ed Kesari K, Switzerland, 2017:183-201.

Wei, S., M. Morrison, and Z. Yu. 2013. Bacterial census of poultry intestinal microbiome. *Poult. Sci.* 92:671–683.

Westphal-Settele, K., S. Konradi, F. Balzer, J. Schönfeld, and R. Schmithausen. 2018. The environment as a reservoir for antimicrobial resistance: A growing problem for public health? *Bundesgesundheitsblatt - Gesundheitsforsch. - Gesundheitsschutz* 61:533–542.

WHO (World Health Organization). 2011. European strategic action plan on antibiotic resistance. Available at http://www.euro.who.int/__data/assets/pdf_file/0008/147734/wd14E_AntibioticResistance_111380.pdf.

WHO (World Health Organization). 2014. Antimicrobial resistance: global report on surveillance 2014. Available at <https://www.who.int/antimicrobial-resistance/publications/surveillancereport/en/>.

WHO (World Health Organization). 2019. Critically important antimicrobials for human medicine, 6th revision. Available at <https://www.who.int/foodsafety/publications/antimicrobials-sixth/en/>.

Xi, Y., N. Shuling, T. Kunyuan, Z. Qiuyang, D. Hewen, G. ChenCheng, Y. Tianhe, L. Liancheng, and F. Xin. 2019. Characteristics of the intestinal flora of specific pathogen free chickens with age. *Microb. Pathog.* 132:325–334.

Yacoubi, N., L. Saulnier, E. Bonnin, E. Devillard, V. Eeckhaut, L. Rhayat, R. Ducatelle, and F. Van Immerseel. 2018. Short-chain arabinoxylans prepared from enzymatically treated wheat grain exert prebiotic effects during the broiler starter period. *Poult. Sci.* 97:412–424.

Yang, C., Q. Deng, J. Xu, X. Wang, C. Hu, H. Tang, and F. Huang. 2019. Sinapic acid and resveratrol alleviate oxidative stress with modulation of gut microbiota in high-fat diet-fed rats. *Food Res. Int.* 116:1202–1211.

Zhao, L., G. Wang, P. Siegel, C. He, H. Wang, W. Zhao, Z. Zhai, F. Tian, J. Zhao, H. Zhang, Z. Sun, W. Chen, Y. Zhang, and H. Meng. 2013. Quantitative genetic background of the host influences gut microbiomes in chickens. *Sci. Rep.* 3.

CHAPTER V. CONCLUSIONS

1. Fast and slow-growing broiler microbiota was in constant development throughout rearing, becoming relatively stable at 21 days of age. *Firmicutes* and *Proteobacteria* were the most abundant phyla at the onset of the production cycle. However, while the *Firmicutes* increased their concentration for the two management systems throughout the growing period, the *Proteobacteria* decreased until the end of the cycle. Regarding the genus, it should be noted that the three most abundant groups for both systems, *Ruminococcus* spp., *Lactobacillus* spp. and *Bacteroides* spp., are related to better productive performance and intestinal health.
2. The fact that the same AMR rates were observed, regardless of the breed studied, strongly suggests the possibility of vertical transmission from hatcheries and dissemination spread through the environment between flocks. Further studies are needed to confirm this hypothesis, and innovative-cost effective tools should be implemented at farm level to avoid AB administration whenever possible throughout the broiler production chain.
3. Microbiota diversity increased throughout the growing period, being relatively stable since the mid-period, for both farm conditions. However, at the end of the rearing, a significant higher level of microbiota complexity was observed in animals reared under optimal farm conditions. Regarding microbiota composition, no statistical differences were observed between experimental groups, for both of them *Firmicutes* was the most abundant phylum during all the research, *Proteobacteria* decreased their concentration throughout the growing, and *Bacteroidetes* increased. At genus level, the most common groups observed for both management systems were *Oscillospira* spp., *Ruminococcus* spp., *Bacteroides* spp. and *Coprococcus* spp. Thus, it could be recommendable to reassess the management farm conditions using gut microbiota diversity and composition as biomarkers of animal health. This could be an important tool for infectious disease control with the aim of reducing the administration of ABs at farm level.
4. In both experimental groups, AMR and MDR were present throughout the growing period, although no AMAs were administered. Moreover, although a lower level of MDR was observed at mid-period in animals reared under less intensive farm

conditions, no differences were found between the two experimental groups at the end of the growing period. For this reason, further studies are needed to evaluate how management could reduce the presence of AMR and MDR bacteria in poultry production at all production stages.

5. The results of this study showed that when chicks are infected with the serovar *S. Infantis* at day one of the growing period, they continue shedding the bacteria in faeces until the processing day. Besides, the acquisition of AMR began at the onset of the production cycle and continued until the end, regardless of the different management conditions applied. Nevertheless, it is important to highlight that no molecular studies of microbiota interaction were performed in this study, which may restrict the interpretation of the results obtained. Thus, further in-depth studies of the plasmids, pathogenicity islands or transposons are needed to achieve a better knowledge of *S. Infantis* AMR dynamics at the farm level, in order to establish better control programmes and reduce its prevalence throughout the food chain.

