

REGENERACIÓN URBANA DEL BARRIO DE MALILLA REVALORIZACIÓN DE LA HUERTA MEDIANTE UN MERCADO Y SU ENTORNO

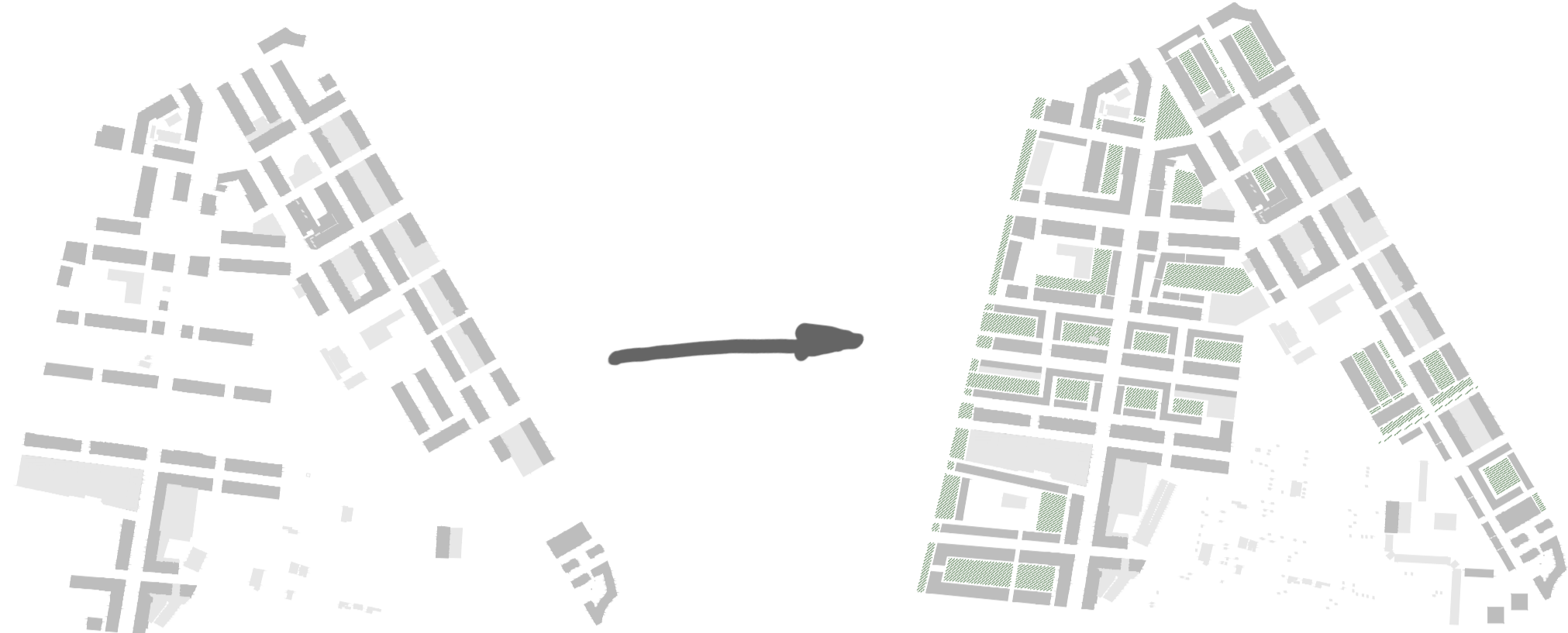

VACÍOS//RETALES

COLMATACIÓN//DENSIDAD

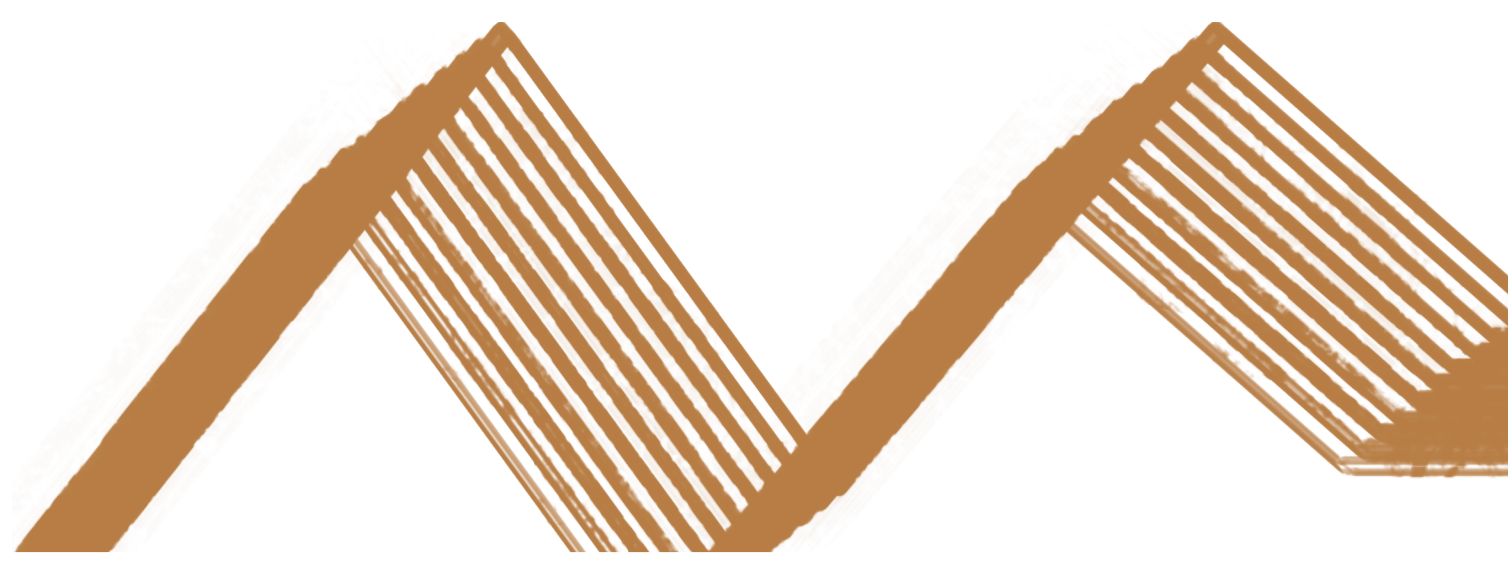

DESCONEXIÓN//AISLAMIENTO



CONEXIÓN//HUMANIZACIÓN DE LÍMITES

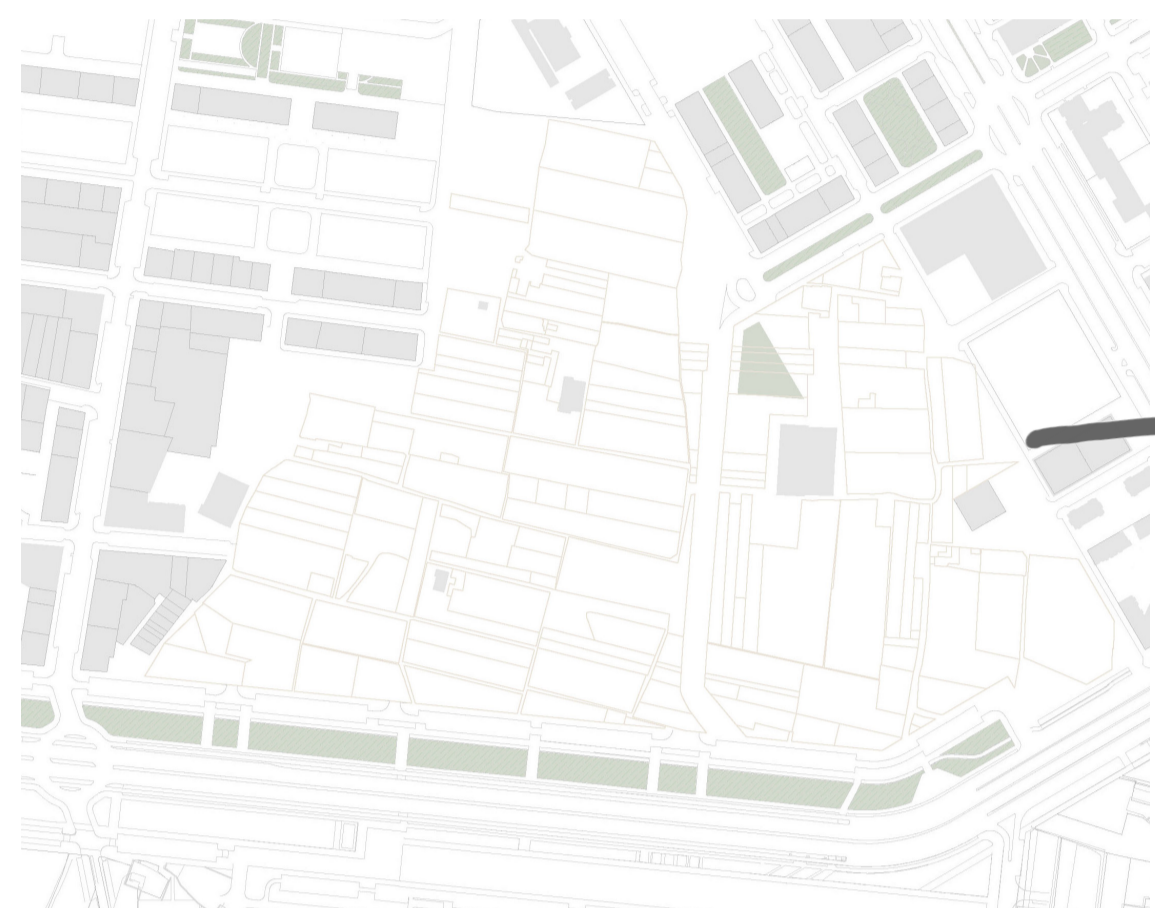

OBSTÁCULO//CONFLICTO

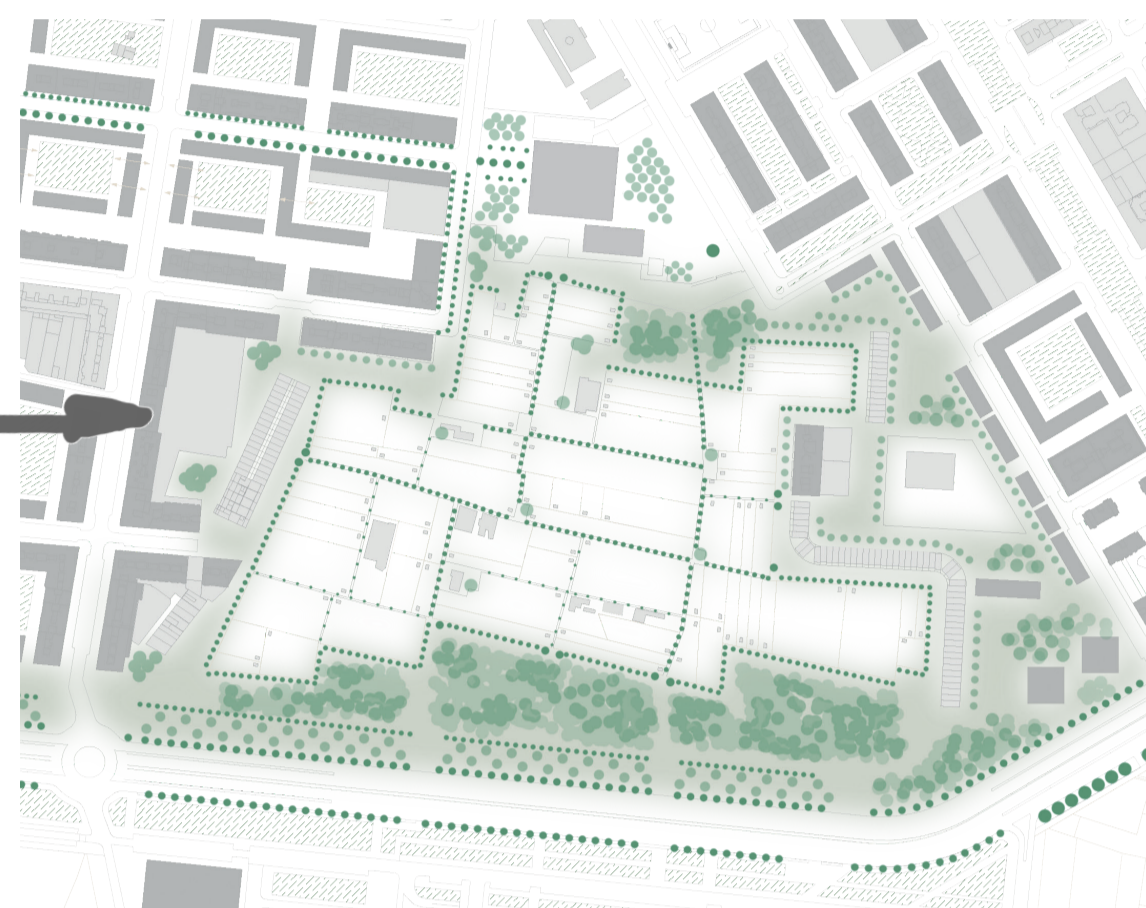

CONVIVENCIA//PAISAJE



CORAZÓN DEL BARRIO// CENTRO CÍVICO



CONEXIÓN

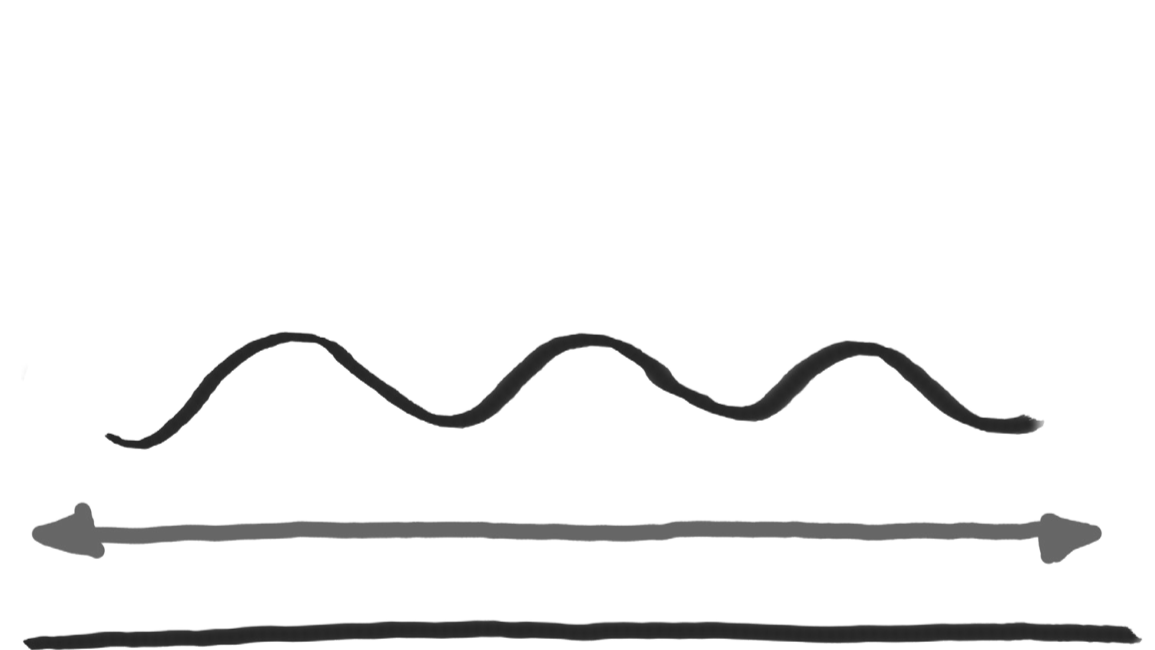
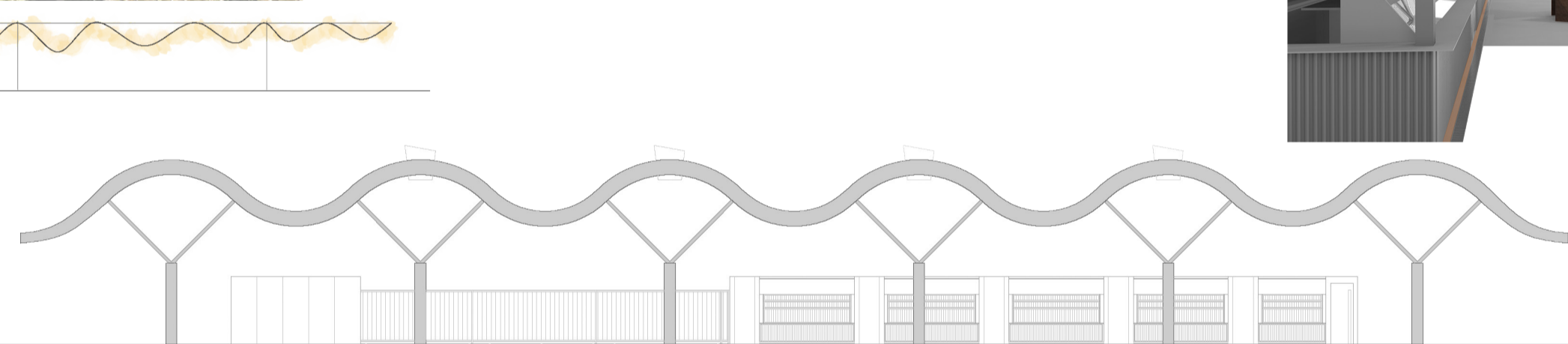
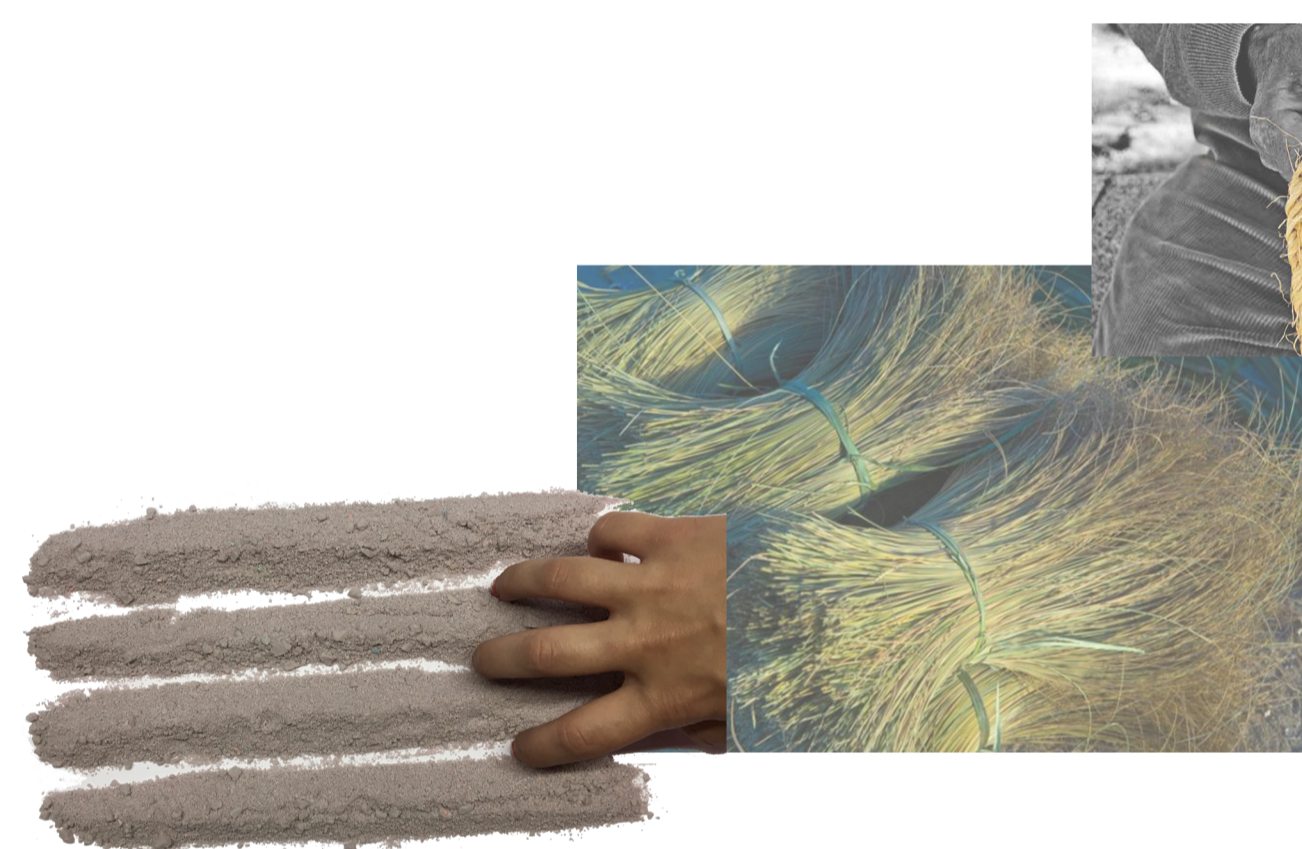

UNA CUBIERTA

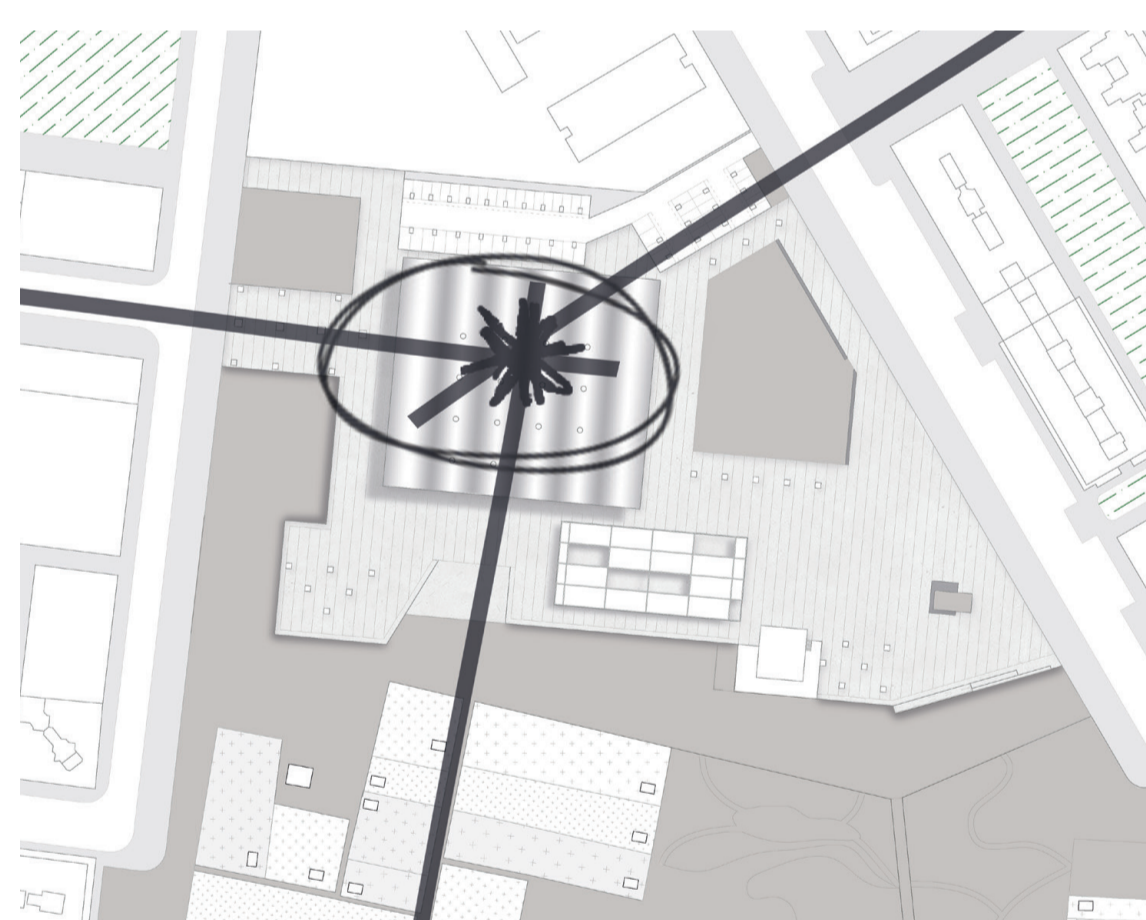

ENCUENTRO//CRUCE

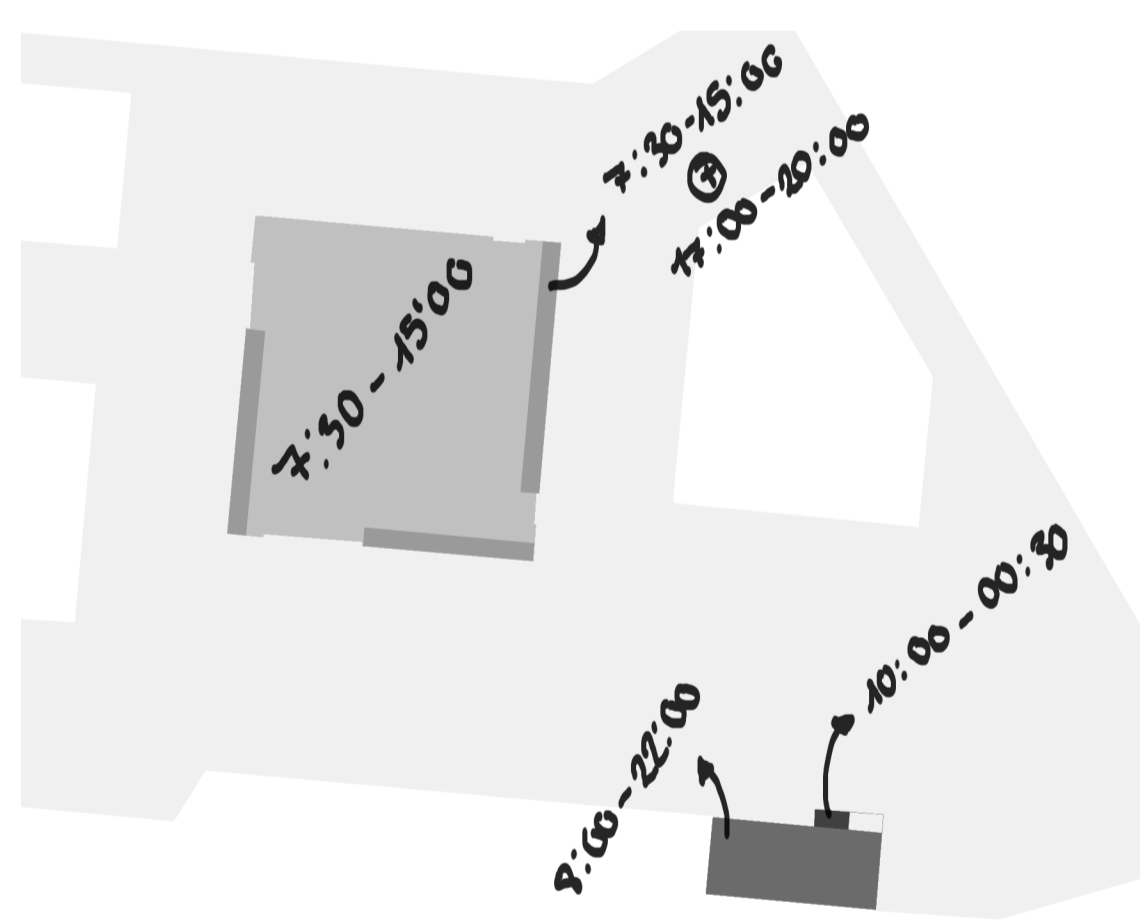

FRANJA HORARIO

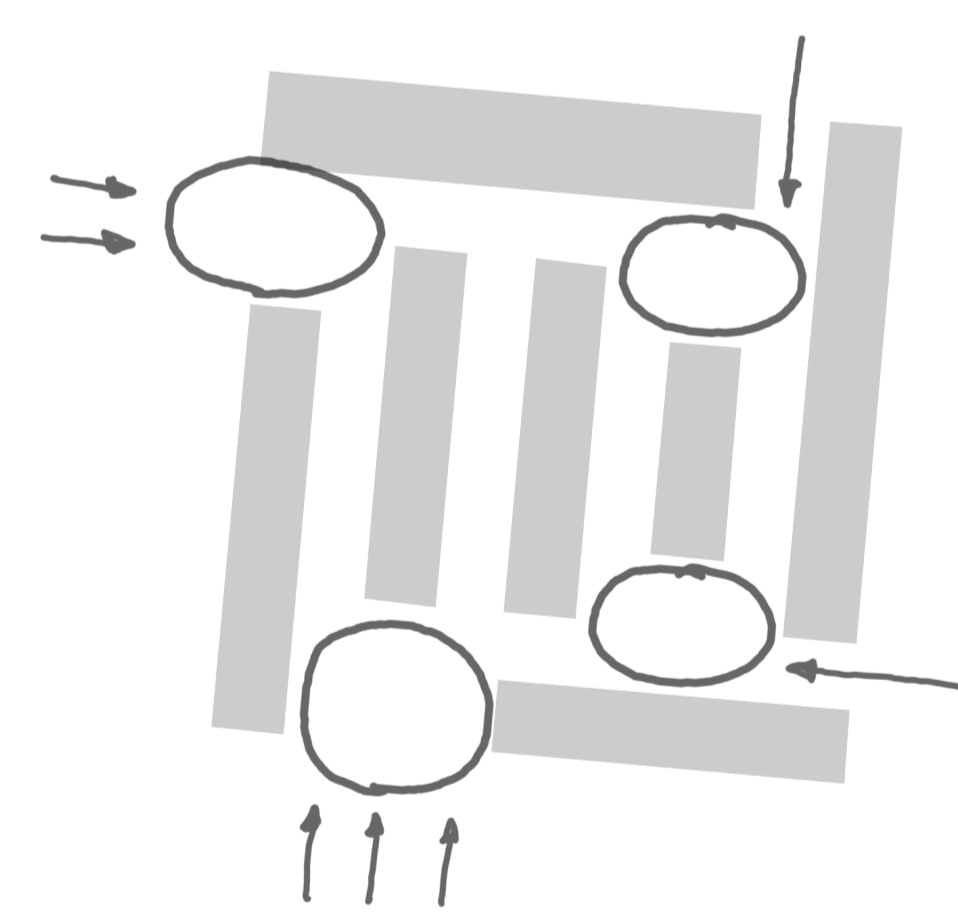

ACCESOS//PLAZAS

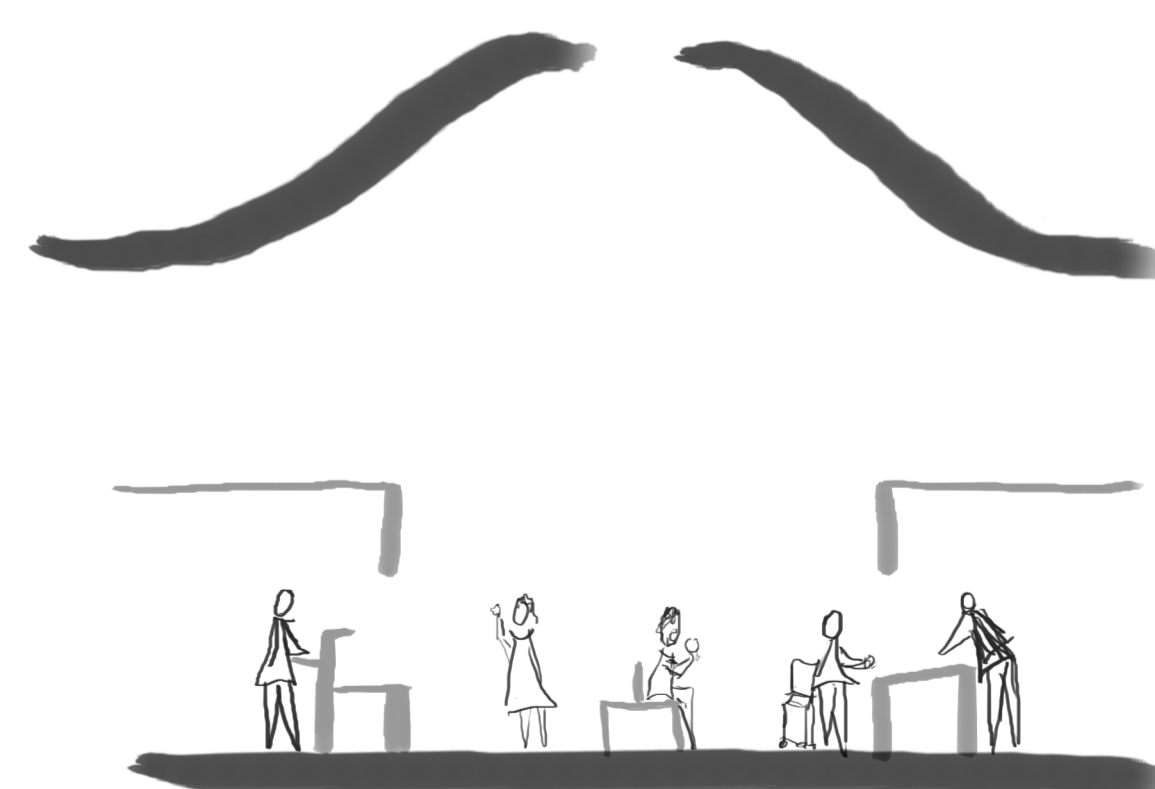

DISEÑO DEL ESPACIO

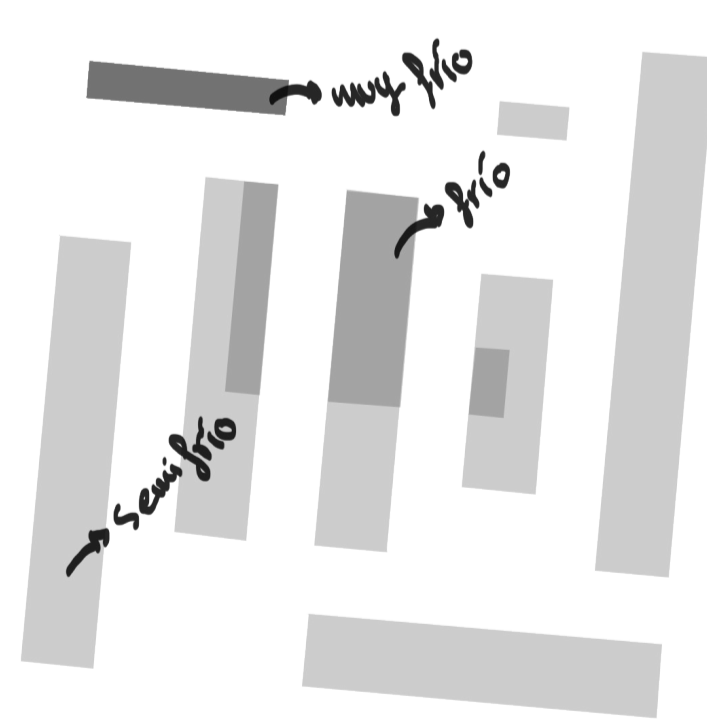

DISTRIBUCIÓN DE PUESTOS

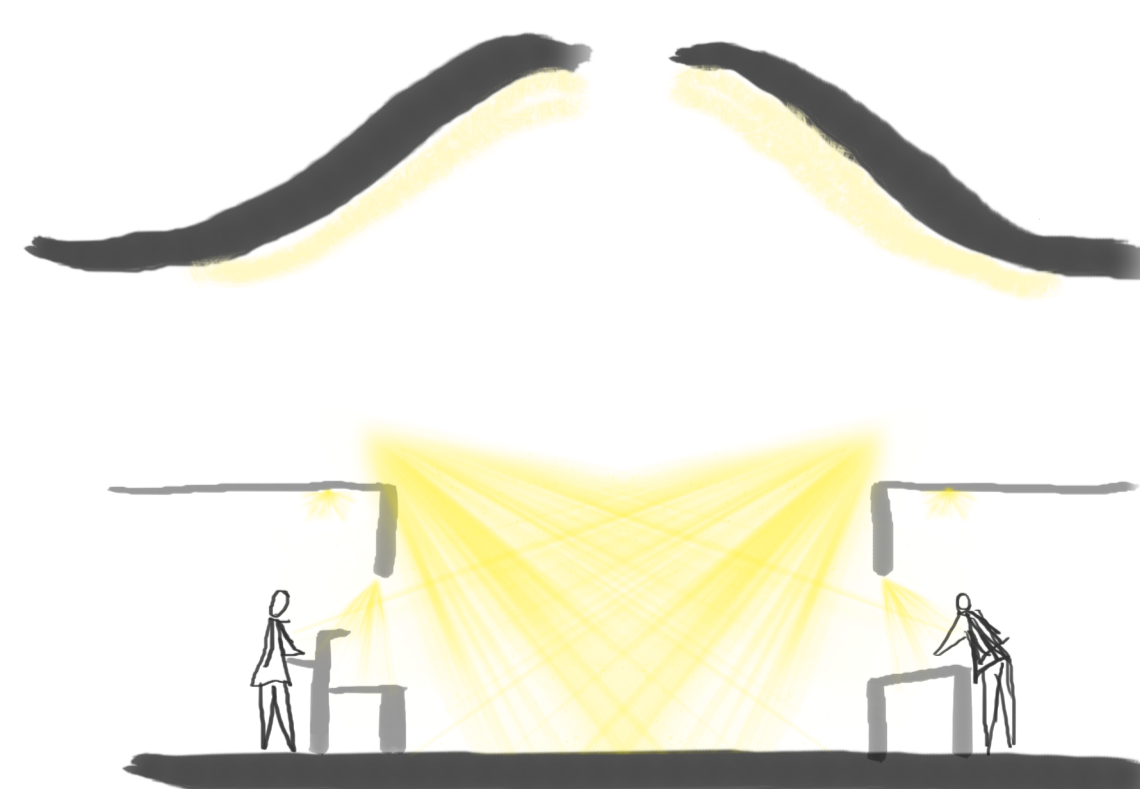

DOS ATMÓSFERAS DE LUZ

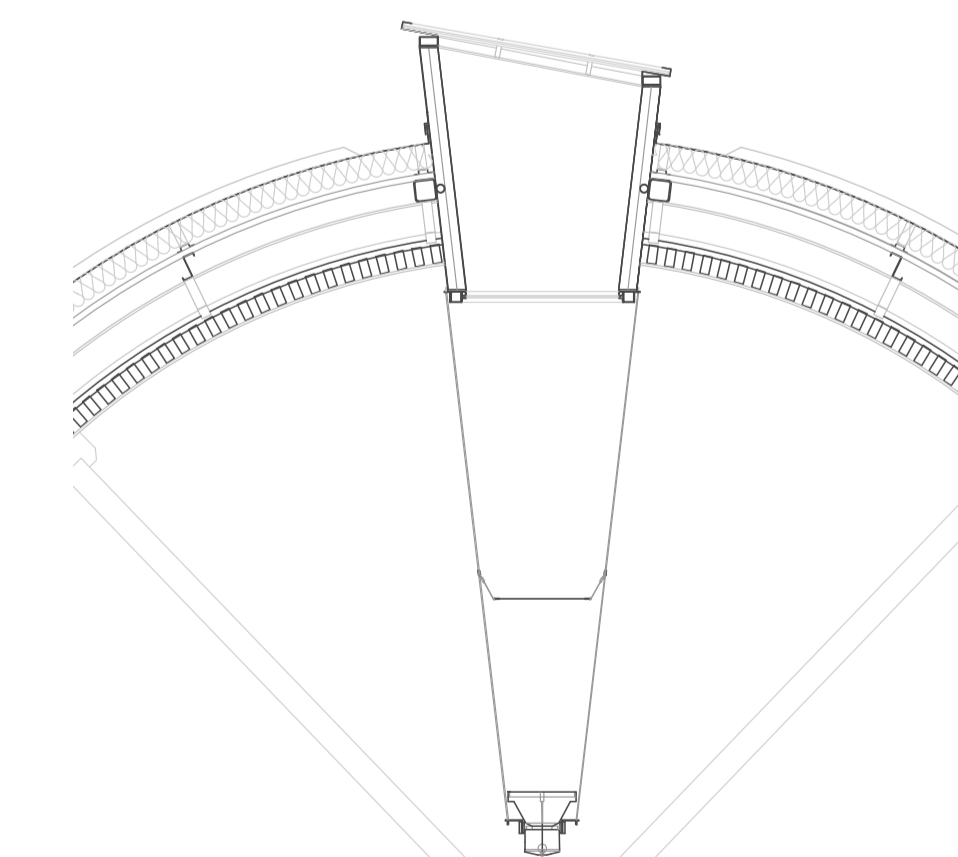

DISEÑO DE ELEMENTOS//CONSTRUCCIÓN

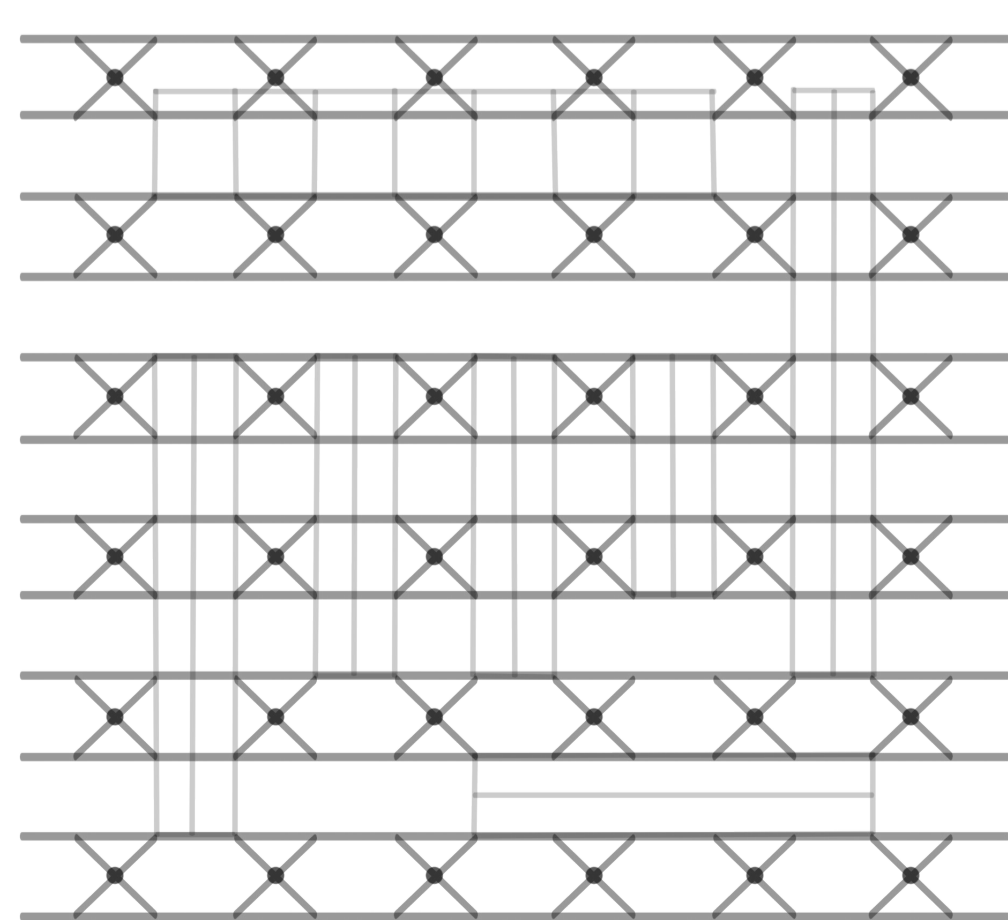

ESTRUCTURAS

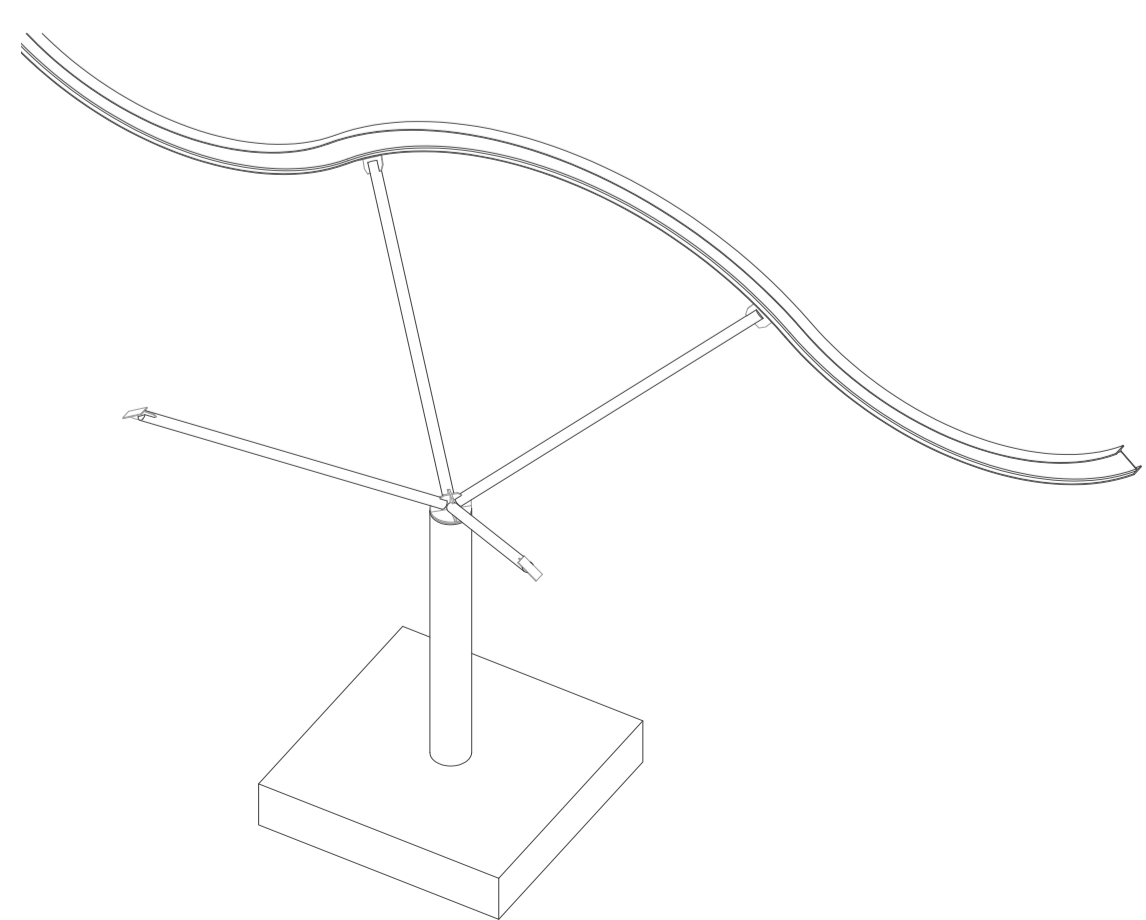

ESTRUCTURA PRINCIPAL

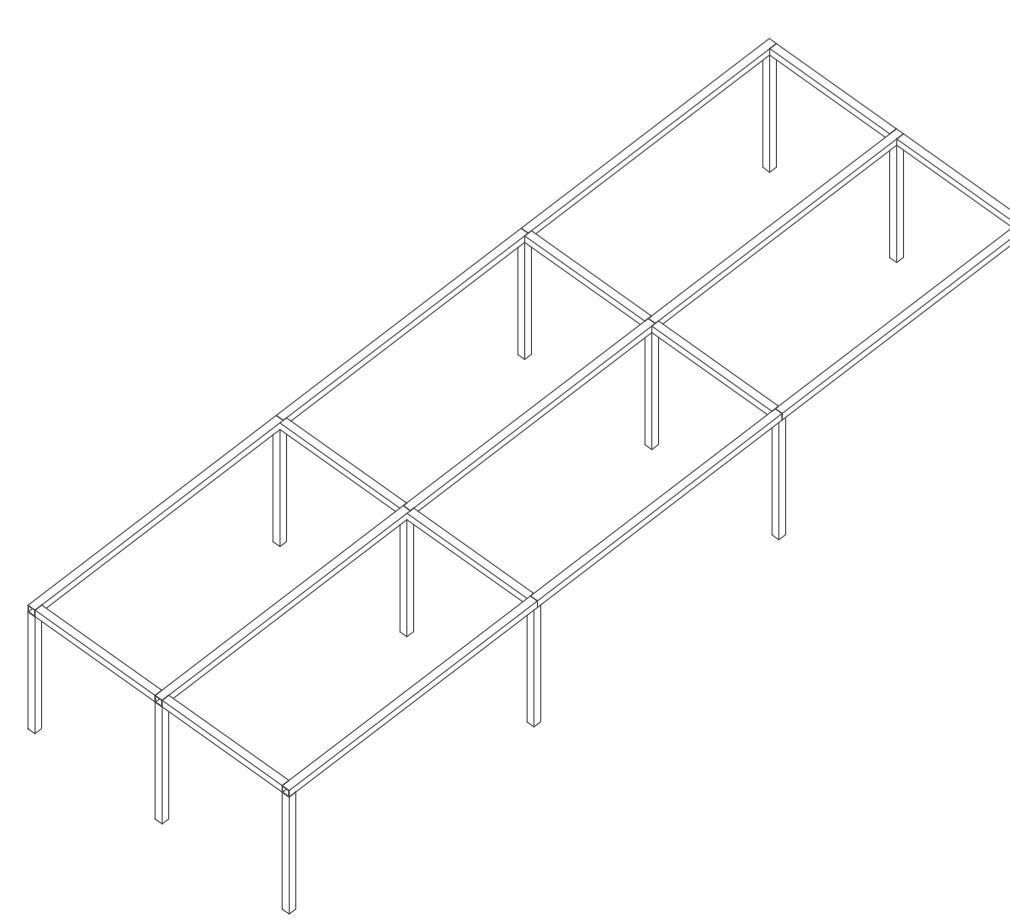

ESTRUCTURA SECUNDARIA

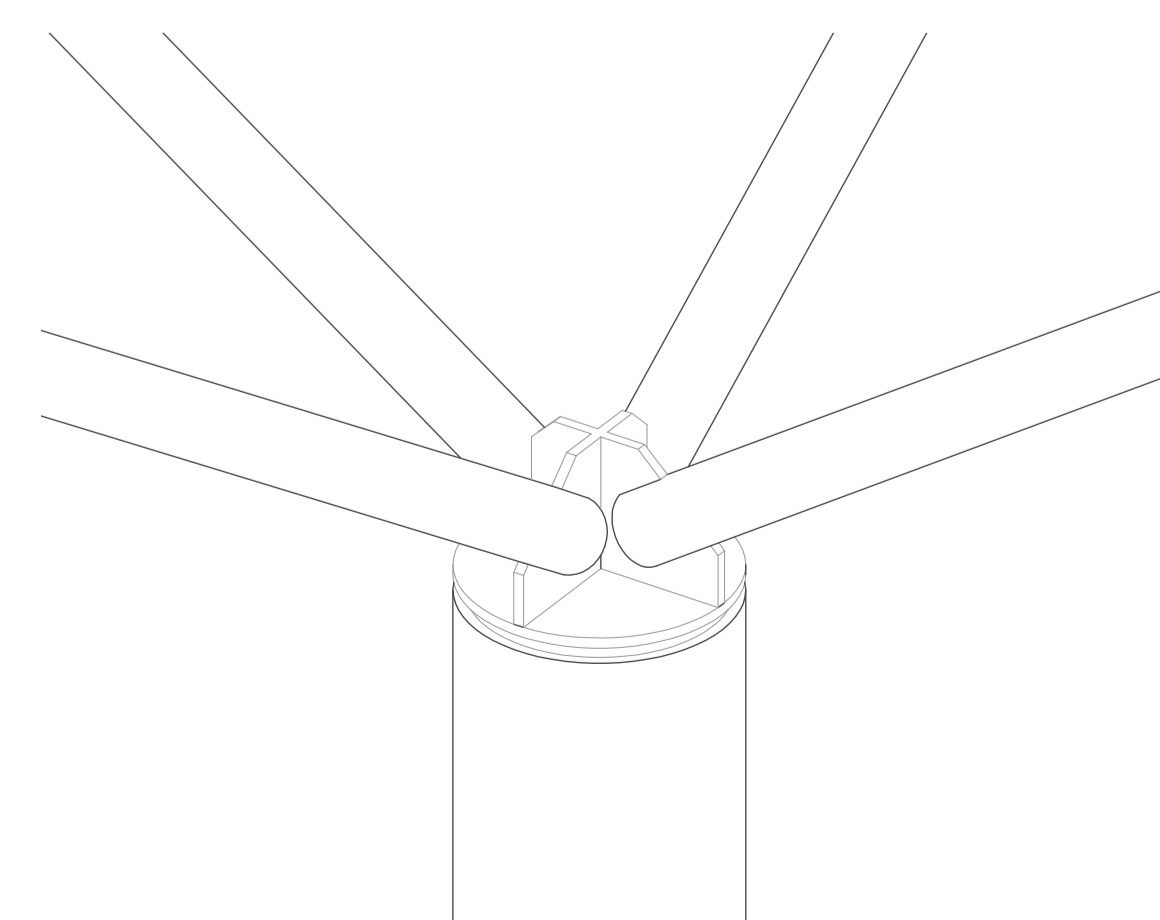

DISEÑO DE ENCUENTROS