

REVISTA AIDIS

de Ingeniería y Ciencias Ambientales:
Investigación, desarrollo y práctica.

MEMBRANE BIOREACTOR APPLIED TO THE TREATMENT OF A FRUIT PROCESSING INDUSTRY WASTEWATER IN NORTHEAST BRAZIL

* Carlos Eduardo Pereira de Morais¹
Lisa Christina Awater²
Gilson Babosa Athayde Júnior¹
Rennio Félix de Sena³
Manuel César Martí-Calatayud^{2,4}
Christoph Bohner⁵

Recibido el 25 de mayo de 2020. Aceptado el 17 de mayo de 2021

Abstract

*The market for Membrane Bioreactors (MBR) technology has recently grown due to increasingly strict standards for effluent discharge and the need for alternative water sources. The high quality of the effluent produced, enabling the possibility of reuse is one of the most attractive characteristics of this technology. The objective of this article was to evaluate the treatment efficiency of a pilot-scale MBR plant in a fruit processing industry, including an analysis of the possibilities for effluent reuse. The pilot plant comprised a MBR with approximately 5000L in capacity, with porous type ultrafiltration grade polyethersulfone membranes. Other details for the membranes were: submerged configuration, flat plate type geometry, pore diameter ranging from 0.035 to 0.1 μm and total area of 25m². The industrial effluent came from fruits processing, floors and machinery washing, and was characterized by physical, chemical and bacteriological parameters. Results showed that permeability decreased about 50% during the monitoring, indicating the need of membrane cleaning. The removal efficiency for COD, BOD₅, total nitrogen and total phosphorus, was 97.1%, 98.7%, 95.7 % and 53.5%, respectively. There was an absence of both total coliform and *E. Coli* at the inlet and outlet of the system. The permeate fits into agricultural, urban, environmental, industrial and aquaculture reuse modalities.*

Keywords: industrial effluents, mbr, reuse, water scarcity, ultrafiltration.

¹ Departamento de Engenharia Civil e Ambiental, Universidade Federal da Paraíba, Brasil.

² Chemical Process Engineering Department, RWTH Aachen University, Aachen, Germany.

³ Departamento de Engenharia Química, Universidade Federal da Paraíba, Brasil.

⁴ Departament d'Enginyeria Química i Nuclear, Universitat Politècnica de València, València, España.

⁵ EnviroChemie GmbH, Rossdorf, Germany.

* *Corresponding author:* Programa de Pós-Graduação em Engenharia Civil e Ambiental, Universidade Federal da Paraíba, cidade universitária, s/n, João Pessoa, Paraíba. CEP: 58051-900, Brasil. Email: carlospereira.sjp@gmail.com

Introduction

A depletion of water resources coupled with population growth results in a water crisis in both quantitative and qualitative terms (Sehar and Nasser, 2019). Moreover, increasing industrial demand increases the generation of industrial wastes. Food industry wastewaters are a significant source of pollution of water resources due to the large amounts and variety of pollutants they contain (Sawadogo *et al.*, 2018).

As in other food industries, fruit processing companies use water in a range of steps (Mundi *et al.*, 2017; Moore *et al.*, 2016). Treatment of wastewater from fruit processing involves additional difficulties due to the high organic load, the chemicals used in the process and seasonal variations in pH and flow rates (Tekerlekopoulou *et al.*, 2020; Moore *et al.*, 2016). Moreover, strict standards for industrial effluent discharge into the environment, are becoming a greater challenge (Sehar and Nasser, 2019; Casani *et al.*, 2005). Regarding industrial wastewater treatment, conventional activated sludge (CAS) and membrane bioreactors (MBR) are the most commonly used technologies (Pirsaheb *et al.*, 2019). MBR technology has recently been gaining more attention than CAS due to more stringent discharge requirements and the need for effluent reuse (Khouni *et al.*, 2020; Andrade *et al.*, 2013).

The use of MBR for the treatment of wastewater has grown worldwide since the mid-1990s, both in quantity and in treatment capacity, since such technology has been at the forefront of technological advances, and has increasingly assumed a prominent position in the competitiveness of deployment and operation costs (Xiao *et al.*, 2019; Ziegler *et al.*, 2016; Grull, 2013; Santos *et al.*, 2011).

Moreover, the existence of competitive MBR suppliers (Qiblawey and Judd, 2019), as well as the accumulation of operational data through academic and field studies (Park *et al.*, 2015) has accelerated the application of MBR technology, so that large plants are currently in operation. Xiao *et al.*, (2019) reports on an MBR plant under expansion phase in Sweden, that when finished, will be the largest plant of this kind in the world, with treatment capacity of 864.000 m³.d⁻¹.

The development of submerged membranes has taken MBR applicability to a new level, considering that they require much less energy to function, can be adapted to larger systems and make costs competitive with conventional wastewater treatment technologies (Grull, 2013; Judd, 2006). In addition, the costs of replacing membrane modules have diminished and the replacement cycles of the modules are increasingly longer (Qiblawey and Judd, 2019; Baker, 2012). In this perspective, Qiblawey and Judd (2019) report that for even greater cost reduction, efficient pretreatment as well as system automation should be considered. Park *et al.* (2015) report that recent developments and improvements in membrane fouling control have led to more favorable projections of membrane life and significantly reduced overall operational and maintenance costs.

The main objective of MBR is to produce clarified and disinfected effluent (Judd, 2016). Investigations in MBR show that such processes present efficient and stable treatment of organic matter, nutrients, pathogens, besides presenting promising potential for the removal of emerging pollutants (Martí-Calatayud *et al.* 2020; Xiao *et al.*, 2019). Hao (2014) and Deowan *et al.* (2016) report that MBR technology has been increasingly used in the treatment of industrial wastewater since they produce a final effluent with quality compatible with several reuse options.

In Brazil, MBR technology is still considered emerging, with some research papers in the area and few applications on a real scale (Belli, 2015). Moreover, most studies with MBR focus on domestic wastewater treatment (Da Costa *et al.*, 2018; Belli *et al.*, 2017; Subtil *et al.*, 2013; Belli *et al.*, 2012). Regarding industrial wastewater, Andrade *et al.* (2013) evaluated MBR applied to the wastewater treatment of dairy industries. When it comes to MBR applied to the wastewater treatment of fruit processing industries, studies are still scarce.

In this context, this study aimed to evaluate the performance of a pilot-scale MBR in the treatment of the effluent in a fruit processing industry located in Northeast Brazil, as well as to verify the possibilities of reusing the treated effluent.

Materials and method

Description of the system

This study examined a MBR pilot-plant from the *Brazil Managed Aquifer Recharge Project* (BRAMAR). BRAMAR is a Brazil-Germany bilateral cooperation research project, and provided a pilot-scale treatment plant for use by a fruit processing company in João Pessoa-PB/Brazil, where the study was conducted. The wastewater produced by the company came from the washing and processing of fruits, as well as floor and machinery cleaning. The effluent drained by gravity through a channel to the place where the treatment plant was installed. A flowchart of the pilot plant is detailed in Figure 1.

Wastewater was collected with an eccentric pump, which drew the effluent from the channel through a 1 mm mesh sieve filter. The wastewater was then sent to a 1000L tank (equalization tank), with a mixer inside to avoid sedimentation and homogenize the effluent. Another eccentric pump, identical to the previous one, then passed the effluent from the equalization tank to the electroflotation tank. After electroflotation, a 200L tank (MBR feed tank) used an automatic level control that activated a drainage pump to feed the MBR tank.

The MBR tank had approximately 5000L capacity, with an immersed ultrafiltration membrane module. The membrane was porous, with pore diameter ranging from 0.035 to 0.1 μm , and the membrane material was polyethersulphone (PES). The membrane geometry was flat plate type,

with submerged configuration and the total module area was 25m². Three aerators were used, two to provide oxygen to the MBR tank and one for membrane scouring. Whenever the dissolved oxygen (DO) concentration reached values below 2 mg.L⁻¹, the minimum recommended for biological treatment, aeration was triggered.

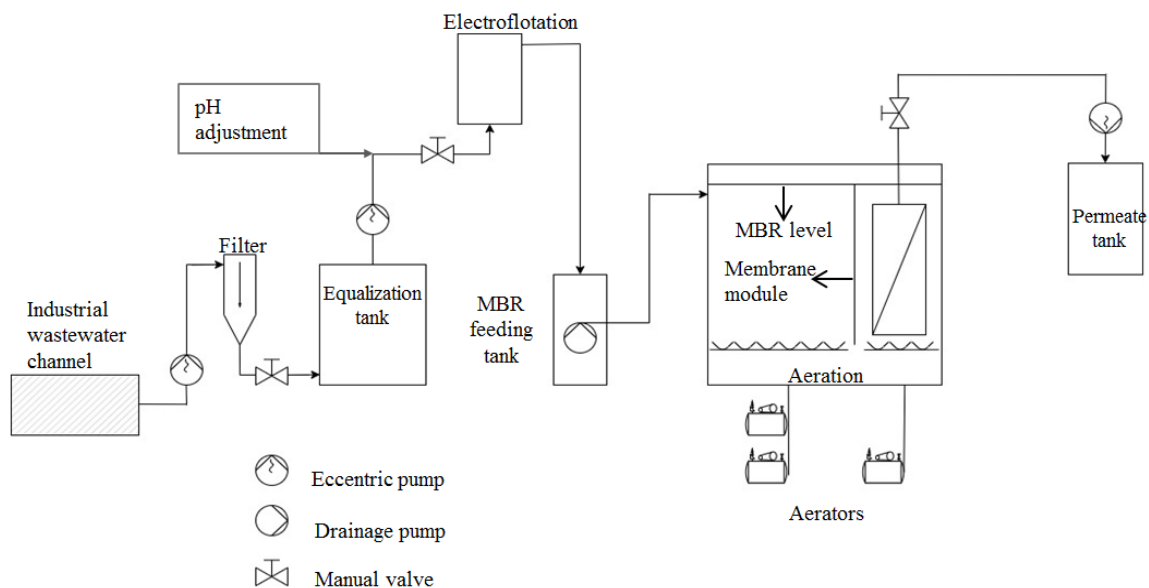

Figure 1. Scheme of the MBR pilot plant.

Finally, the treated effluent (permeate) was pumped by an eccentric pump to a tank with a capacity of 400L, which was used to collect the final effluent. The pilot plant had an ultrasonic flow meter (Flowmax 44i MIB GmbH). The MBR monitoring period was 4 months, between December 2016 and April 2017, a period preceded by a 15-day period of acclimatization. Average flow during the days of operation was 1.6 m³.day⁻¹. During this period no chemical cleaning of the membrane was performed. In the acclimatization phase, sludge from an activated sludge plant was inoculated into the MBR module.

Industrial wastewater characterization

For most of the time of operation the fruits processed in the industry were pineapple, acerola, mango and guava. MBR performance was evaluated by collecting samples from three distinct points: in the equalization tank (point 1), in the MBR feed tank (point 2) and in the permeate tank (point 3). A data acquisition system coupled to the *ACRON Reporter* software collected and stored the following parameters: pH, DO, temperature, mixed liquor level in the reactor and permeate

flow and transmembrane pressure. The physical and chemical analyses performed were: Chemical Oxygen Demand (COD), Biological Oxygen Demand (BOD₅), Total Suspended Solids (TSS), Total Nitrogen (TN), Total Phosphorus (TP), as well as measurements of pH, Temperature (T), and electric conductivity (EC) with the aid of a multiparameter probe (Hanna). Total coliform and *E. coli* tests were performed for the microbiological analysis.

Due to the high organic load it was necessary to add nitrogen and phosphorus in the reactor, since such nutrients were present in low concentration in the industrial effluent and are essential for the growth of bacteria. The lack of nitrogen and phosphorus is common in the treatment of effluents from food processing industries with high organic content (Metcalf & Eddy, 2016). Thus, rather than evaluating the efficiency of TN and TP removal, these parameters were of paramount need to calculate the necessary dosage of these nutrients to be added into the reactor, always seeking to maintain the COD:N:P ratio close to 200:5:1. Urea was used as a source of nitrogen and phosphoric acid and/or diammonium hydrogen phosphate as a source of phosphorus.

Table 1. Physical, chemical and microbiological analysis.

Parameter	Method
COD	Closed reflux colorimetric method
BOD ₅	Oxidirect (BOD System)
TSS	APHA (2012)
TN	HACH 10.071
TP	HACH 8.190
EC	Hanna Combo waterproof pH/EC/TDS/Temp
pH	Hanna Combo waterproof pH/EC/TDS/Temp
T	Hanna Combo waterproof pH/EC/TDS/Temp
Total coliform and <i>E. coli</i>	APHA (2012) and Colilert

Results and discussion

MBR operation and control

The volume of the reactor was controlled by a level sensor to operate between 87% and 94% of the total capacity. When the level reached 94%, the feeding was stopped, and when the level was at 88%, the feeding pump was turned on again. Along the monitoring period, the mean level in the reactor was 88.4% of the full capacity (Figure 2 – A). Levels lower than 87% occurred only at sludge discharge occasions.

With regard to TSS, the ideal band for the operation of MBR is considered as 8-12 g.L⁻¹ (Metcalf & Eddy, 2016; Park *et al.*, 2015), while the maximum value to avoid flux reduction due to fouling is

18 g.L⁻¹ (Metcalf & Eddy, 2016). In this study the MBR was operated with TSS between 12 and 18 g.L⁻¹, as shown in Figure 2 (B). Sludge discharge actions were used to keep the TSS concentration under this mentioned range.

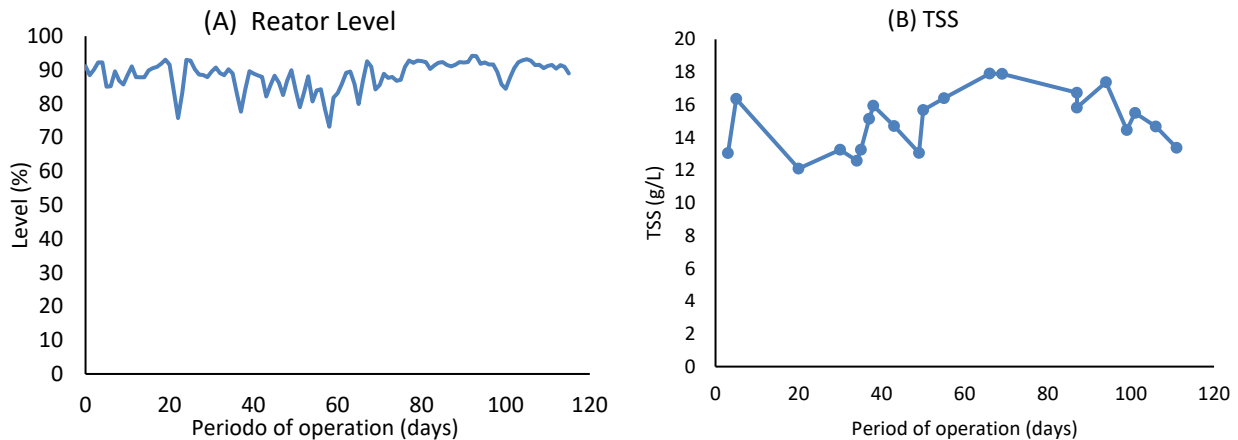

Figure 2. Level variation in the reactor (A) and TSS in the mixed liquor (B) along the monitoring period of the MBR.

The level in the reactor and the transmembrane pressure were used for permeability calculation. When reactor level was lower than 94%, an additional volume of 2.17% was used for the correction of the transmembrane pressure due to the liquor volume that was not occupying the reactor.

Figure 3 (A) shows that membranes' permeability decreased about 50% from the beginning to the end of the monitoring period, indicating the need for cleaning. Viero (2006) reports that the reduction on the effective filtration area, and consequently membrane permeability, is related to flux reduction, due to membrane fouling. Figure 3 (B) shows the initial flux of the membranes, between 13 and 15 L.m⁻².h⁻¹, where intermittent cycles of suction and relaxation were alternated (suction: 10 min.; relaxation: 2 min).

Temperature in the mixed liquor are presented in Figure 4 (A), where the values varied inside the ideal range of 25-35 °C (Jordão e Pessoa, 2011) for aerobic treatment processes. The mean temperature in the mixed liquor suspended solids (MLSS) was 29.7°C. Temperature is an important parameter in MBR performance, since it governs microbial metabolism (Park *et al.*, 2015).

Mean value for DO in the MLSS was 3.4 mg.L⁻¹, which is above the minimum recommended value (Metcalf & Eddy, 2016; Moore *et al.*, 2016) of 2.0 mg.L⁻¹. Low values of DO initially recorded are

due to the reduced active biomass in the MLSS, since the reactor was inoculated with sludge 15 days before the monitoring began. Figure 4 (B) shows DO concentration in the MLSS. Aeration was always turned on when DO was as low as $2.0 \text{ mg}\cdot\text{L}^{-1}$.

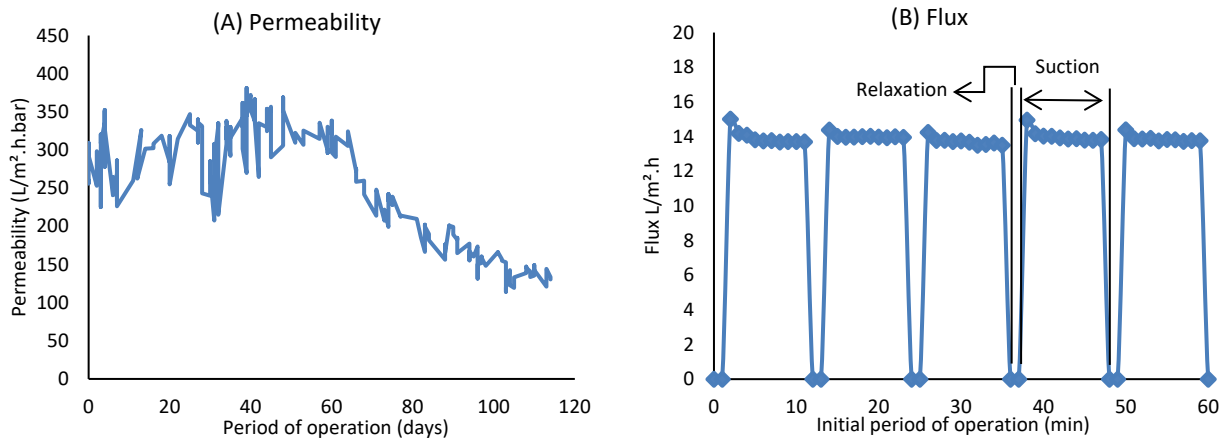

Figure 3. Membrane permeability (A) and operational strategy (B) along MBR monitoring period.

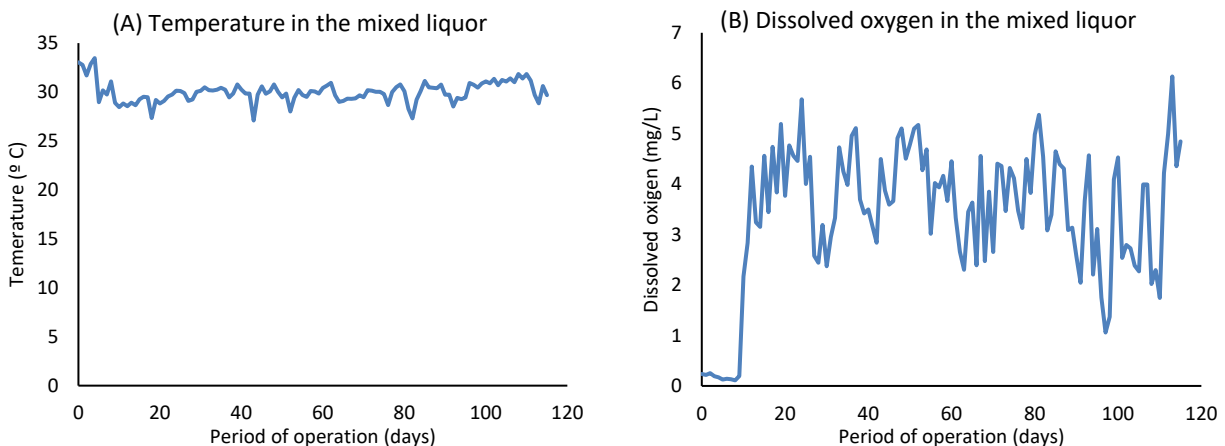

Figure 4. Temperature (A) and dissolved oxygen (B) in the MLSS along the MBR monitoring period.

Mean values of pH, temperature (T) and electric conductivity (EC) recorded for the three monitoring points (MP) are shown in Table 2. Initially, the values were recorded at different times along the day, and because there were no accentuated variations, the mean values were calculated for each day.

Table 2. Characterization of the industrial wastewater (MP1), eletroflotation effluent (MP2) and permeate (MP3).

	MP1 (wastewater, inlet)			MP2 (eletroflotation effluent)			MP3 (permeate)		
	pH	T (°C)	EC (mS/cm)	pH	T (°C)	EC (mS/cm)	pH	T (°C)	EC (mS/cm)
Mean	4.5	32.0	1.9	4.9	32.5	2.1	7.9	33.1	2.2

There was an increase on mean pH values from the industrial wastewater (4.5) to the permeate (7.9). Low pH values in the industrial wastewater are due to the type of fruits processed and to the acids used in the machinery cleaning operations. Moore (2015) also reported similar results, when pH rose from 4.9 in the influent wastewater to 8.0 in the MBR permeate, where it was attributed to denitrification process.

According to Brazilian legislation (CONAMA Resolution 430/2011), effluents of any source can be discharged in water bodies only if, among other conditions, pH is between 5 and 9 (Brasil, 2011). The mean pH values in the permeated complies with this discharge requirement and also with the recommendation of effluent quality for reuse according to NBR 13.969/1997 (ABNT, 1997) and COEMA Resolution 2/2017 (Ceará, 2017).

It can be noticed that EC did not varied significantly along the treatment phases (MP1, MP2 and MP3). According to Metcalf & Eddy (2016), EC is very important for effluent reuse considerations, since it is strongly related with salinity. Increased salinity can have a significant impact in terms of biokinetic as well as fouling behaviour in the MBR (Di Bella *et al.*, 2013). In this study, EC complied with the standards recommended for reuse (maximum 3 mS/cm) according to COEMA Resolution N° 2/2017 (Ceará, 2017).

MBR performance

Figure 5 (A) shows COD in the monitoring points 1, 2 and 3, where mean values were 6,837, 6,019 e 196 mgO₂.L⁻¹, respectively. Average overall COD removal efficiency (from MP1 to MP3) was about 97.1%. Moore (2015) also reported similar results when studying the performance of an MBR (bench scale) on the treatment of fruit (and other vegetables) industries: 97.0% COD removal. Fraga *et al.* (2017) found COD removal efficiency of 94.1% when studying an MBR treating dairy industry wastewater. Belli (2015), when studying an MBR treating sanitary wastewater, also reported COD removal efficiency of 97.0%. Therefore, the removal efficiency herein found is in accordance with literature results.

Figure 6 (A) shows BOD₅ in the three monitoring points (MP1, MP2 and MP3), where mean values were 3,730, 3,238 and 42 mgO₂.L⁻¹, respectively. Average overall BOD₅ removal efficiency (from MP1 to MP3) was 98.7%, higher than the requested value of up to 60% as recommended by CONAMA Resolution 430 (Brasil, 2011). Thus, the removal efficiency for BOD₅ herein found is in

accordance with literature results, where Moore (2015) reached 99.9% BOD₅ removal in an MBR treating a fruit processing industry wastewater, and Fraga *et al.* (2017) found BOD₅ removal efficiency of 98.1% when studying an MBR treating dairy industry effluent.

High efficiency for both COD and BOD₅ were kept even for high organic loads, showing good capacity of the MBR to resist to such picks.

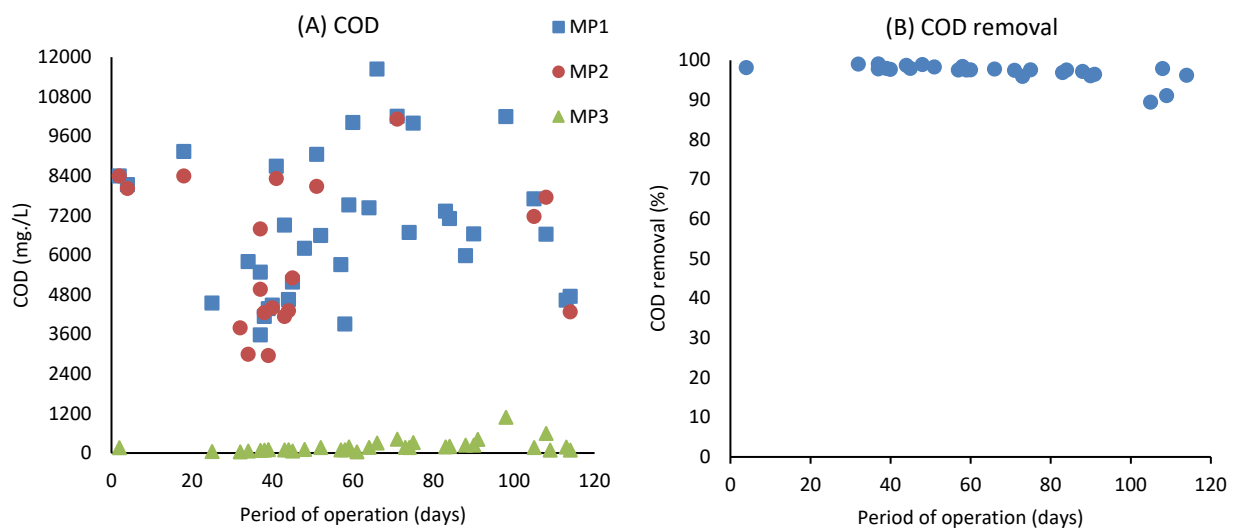

Figure 5. COD concentration in the three monitoring points (A) and removal efficiencies (B).

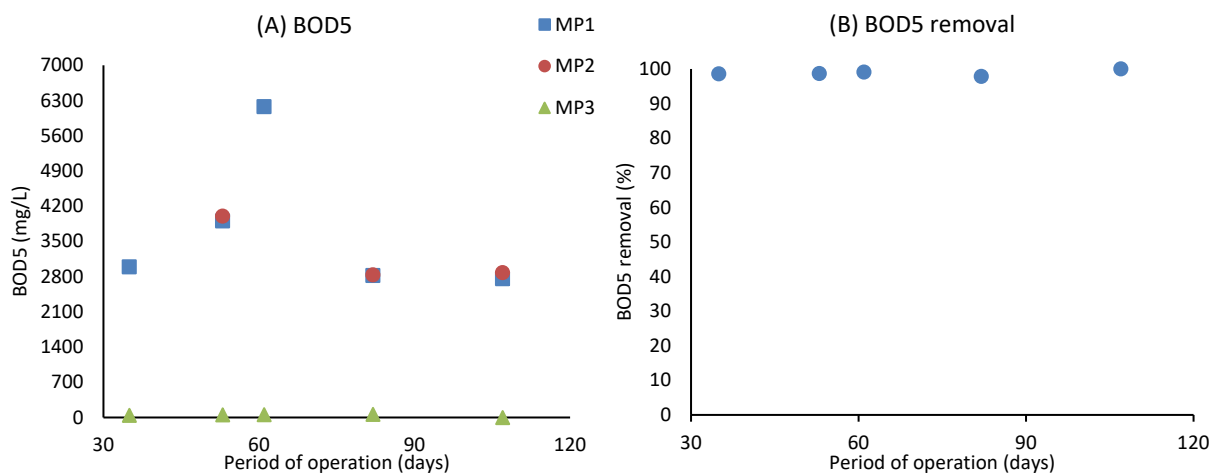

Figure 6. BOD₅ concentration in the three monitoring points (A) and removal efficiencies (B).

Figure 7 (A) shows total nitrogen (TN) concentration in the three monitoring points, where mean values were 39.9 and 4.4 mg.L⁻¹ for MP1 and MP3, respectively. Figure 7 (B) shows removal efficiency for TN in the MBR system. Average overall TN removal efficiency (from MP1 to MP3) was 95.7%. Fraga et al. (2017) also found TN removal efficiency (93.1%) similar to the present study.

Figure 8 (A) shows total phosphorus (TP) concentration in the three monitoring points, where mean values were 13.5 and 8.5 mg.L⁻¹ for MPs 1 and 3, respectively. Figure 7 (B) shows removal efficiency for TP in the MBR system. The mean global removal efficiency for TP was 53.5%. It must be stated that the removal efficiency for TN and TP is even higher than 95.7% and 53.5%, respectively, since nitrogen (as urea) and phosphorus (as phosphoric acid) were added in the MLSS as nutrient source for bacterial growth.

Moore (2015) reported TP removal efficiency of 60% when studying a MBR applied to the treatment of fruit (and other vegetables) industries, which is higher than the result herein found.

With regard to microbiological content, both total coliform and *E.coli* were absent in both monitoring points (MP1 and MP3). This confirms that sanitary wastewater is not connected to the industrial wastewater stream. Subtil *et al.* (2013), when studying an MBR treating sanitary wastewater found that microbiological content, in terms of total coliform and *E.coli* was compatible with unrestricted urban reuse of the treated wastewater. Therefore, whether these bacteria were present in the industrial wastewater, they are expected to be efficiently removed by the ultrafiltration membranes.

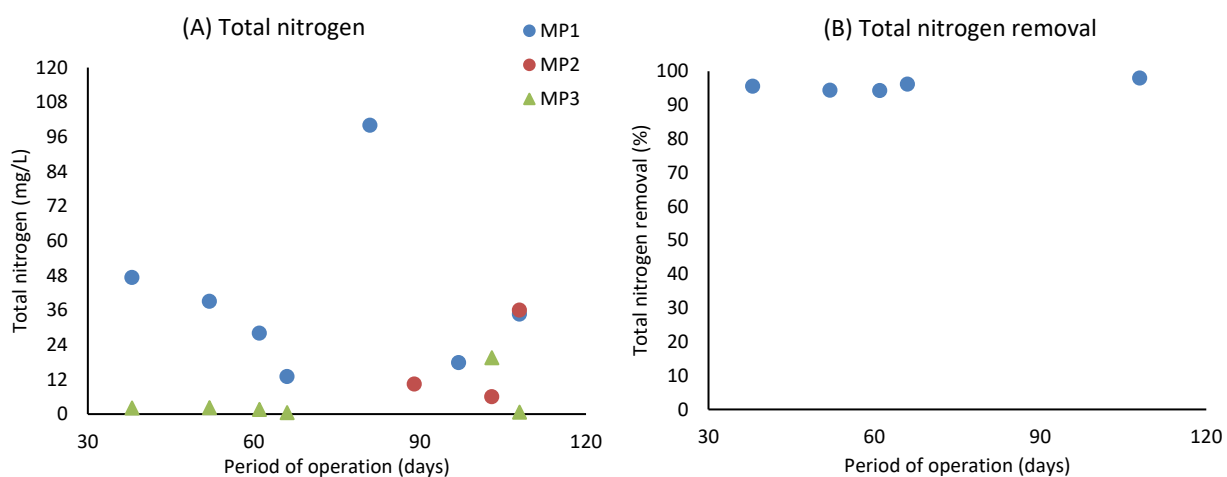

Figure 7. TN concentration in the three monitoring points (A) and removal efficiencies (B).

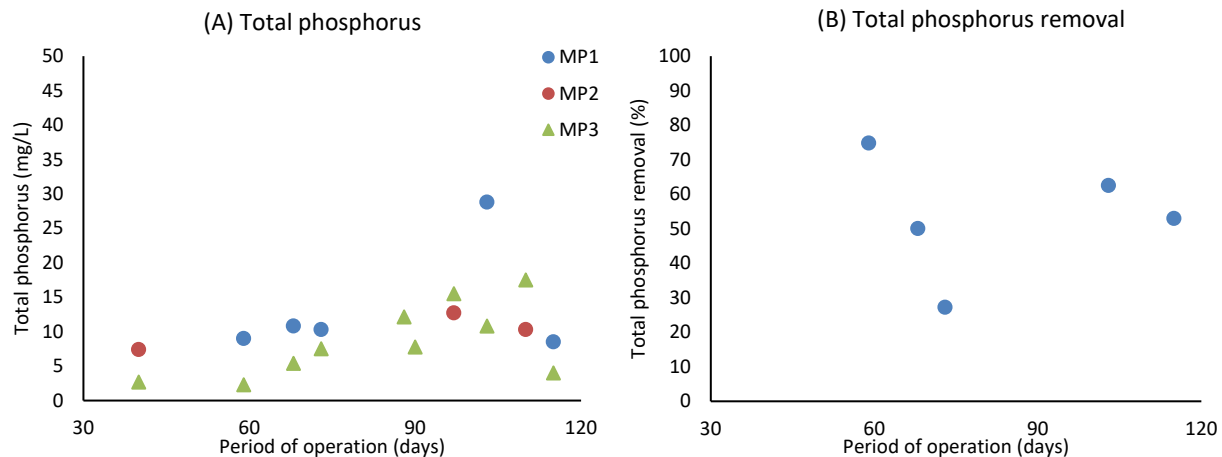

Figure 8. TP concentration in the three monitored points (A) and removal efficiencies (B).

Effluent reuse according to Brazilian standards

Permeate quality attended the recommendation of NBR 13.969 (ABNT, 1997) for reuse in class I (car washing), class II (floor washing, garden watering and ornamental purposes), class III (toilet flushing) and class IV (irrigation of fruit tree, cereals and forage crops) and COEMA Resolution 2/2017 (Ceará, 2017) for all reuse categories (urban reuse, agriculture and forest reuse, environment reuse, industry reuse, aquaculture reuse). Because permeate was absent from both total coliform and *E.coli*, it can be reuse for unrestricted irrigation according to World Health Organization (WHO, 2006). Therefore, permeate produced in the MBR herein reported, can be reuse in a variety of usages, including some in the industry where it was located.

Conclusions

MBR showed to be very efficient on the removal of COD, BOD₅, total nitrogen and total phosphorus from a fruit processing industry wastewater. Removal efficiencies for BOD₅ attended Brazilian legislation for effluent discharge. MBR also showed good resilience, since high efficiencies were maintained regardless the high organic loads.

Permeate quality was found to be in accordance with Brazilian reuse standards recommended in NBR 13.969 (ABNT, 1997) and COEMA Resolution 2 (Ceará, 2017) for a variety of uses, such as: car washing, floor washing, garden watering, ornamental purposes, environmental restoration, toilet flushing, irrigation of fruit tree, cereals and forage crops, aquaculture and industrial uses.

Application of MBR technology can therefore contribute to water saving in the industry herein reported, since the final effluent is suitable for reuse in several common activities in the industrial sector.

Acknowledgments

This article is part of a master dissertation presented at the Postgraduate Program of Civil and Environmental Engineering of Federal University of Paraíba (Brazil) – PPGECAM/UFPB.

Acknowledgments are also due to CNPq (scholarship), FINEP and BMBF for research funding (BRAMAR Project). We also acknowledge the Brazilian National Council for Scientific and Technological Development - CNPq (through funding process 423869/2016-7 - Project Universal) for financial support.

References

- American Public Health Association - APHA. *Standard Methods for the Examination of Water and Wastewater*. 22. ed. Washington D C. 2012.
- Andrade, L. H., Motta, G. E., Amaral, M. C. S. (2013) Treatment of dairy wastewater with a membrane bioreactor. *Brazilian Journal of Chemical Engineering* **30** (4), 759–770. <https://doi.org/10.1590/S0104-66322013000400008>
- Associação Brasileira de Normas Técnicas. *NBR 13969*. Tanques sépticos - Unidades de tratamento complementar e disposição final dos efluentes líquidos - Projeto, construção e operação. Rio de Janeiro, 1997. 60 pp.
- Baker, R. W. (2012) *Membrane Technology and applications*. 3ª ed. John Wiley & Sons LTDA. 575 pp.
- Belli, T. J., Bernardelli, J. K. B., Da Costa, R. E., Bassin, J. P., Amaral M. C. S., Lapolli, F. R. (2017) Effect of solids retention time on nitrogen and phosphorus removal from municipal wastewater in a sequencing batch membrane bioreactor, *Environmental Technology*, **38**(7), 806-815. <https://doi.org/10.1080/09593330.2016.1212934>
- Belli, T. J. (2015). *Biorreator à membrana em batelada sequencial para a remoção de nutrientes de esgoto sanitário: desempenho do tratamento, colmatção das membranas e estratégias de otimização*. Tese (Doutorado em Engenharia Ambiental) – Universidade Federal de Santa Catarina, Florianópolis. 275 pp
- Belli, T. J., Amaral, P. A. P., Recio, M. A. L., Vidal. C. M. S., Lapolli, F. R. (2012) Biorreator à membrana em batelada sequencial aplicado ao tratamento de esgoto visando à remoção de nutrientes. *Engenharia Sanitária e Ambiental*, **17**, 143-154. <http://dx.doi.org/10.1590/S1413-41522012000200003>
- Brasil, Ministério do Meio Ambiente. *Conselho Nacional do Meio Ambiente - CONAMA*. Resolução Nº 430 de 13/05/2011 (Federal) - Dispõe sobre as condições e padrões de lançamento de efluentes, complementa e altera a Resolução Nº 357, de 17 de março de 2005, do Conselho Nacional do Meio Ambiente - CONAMA. 2011. Disponível em: <http://www.mma.gov.br/port/conama/res/res11/res43011.pdf>
- Casani, S., Rouhany, M., Knøchel, S. (2005). A discussion paper on challenges and limitations to water reuse and hygiene in the food industry. *Water Research*, **39**(6), 1134–1146. <https://doi:10.1016/j.watres.2004.12.015>
- Ceará. *Conselho Estadual de Meio Ambiente*. resolução Coema Nº 02, de 02 de fevereiro de 2017. Dispõe sobre padrões e condições para lançamento de efluentes líquidos gerados por fontes poluidoras, revoga as Portarias SEMACE nº 154, de 22 de julho de 2002 e nº 111, de 05 de abril de 2011, e altera a Portaria SEMACE nº 151, de 25 de novembro de 2002. Disponível em: <https://www.semace.ce.gov.br/wp-content/uploads/sites/46/2019/09/COEMA-02-2017.pdf>
- Da Costa, R. E., Lobo-Recio, M. A., Battistelli, A. A. Comparative study on treatment performance, membrane fouling, and microbial community profile between conventional and hybrid sequencing batch membrane bioreactors for municipal wastewater treatment. *Environ Sci Pollut Res*, **25**, 32767–32782. <https://doi.org/10.1007/s11356-018-3248-8>.

- Deowan, S. A., Galiano, F., Hoinkis, J., Johnson, D., Altinkaya, S. A., Gabriele, B., Hilal, N., Drioli, E., Figoli, A. (2016) Novel low-fouling membrane bioreactor (MBR) for industrial wastewater treatment, *Journal of Membrane Science*, **510**, 524–532. <https://doi.org/10.1016/j.memsci.2016.03.002>
- Di Bella, G., Di Trapani, D., Torregrossa, M., Viviani, G. Performance of a MBR pilot plant treating high strength wastewater subject to salinity increase: Analysis of biomass activity and fouling behaviour, *Bioresource Technology*, **147**, 614–618, 2013.
- Fraga, F. A., Garcia, H. A., Hooijmans, C. M., Miguez, D., Brdjanovic, D. (2017) Evaluation of a membrane bioreactor on dairy wastewater treatment and reuse in Uruguay. *International Biodeterioration & Biodegradation*, **119**, 552–564. <https://doi.org/10.1016/j.ibiod.2016.11.025>
- Grull, D. (2013) Remediação e readequação de sistemas aquáticos superficiais contaminados. IN: Calijuri, M. C., Cunha, D. G. F. (Org.). *Engenharia Ambiental: Conceitos, Tecnologia e Gestão*. 1ª ed. São Paulo, Elsevier. p. 620–641.
- Hao, L. (2014) *Effects of Nutrients Conditions and Solids Retention Time (SRT) on Performance and Membrane Fouling of Aerobic Membrane Bioreactors (MBRs)*. Dissertação (Mestrado em Engenharia) - Lakehead University, Ontário. 122 pp.
- Jordão, E. P.; Pessoa, C. A. *Tratamento de esgotos domésticos*, 6ª. Edição, Rio de Janeiro: ABES, 2011. 994 pp.
- Judd, S. (2016) The status of industrial and municipal effluent treatment with membrane bioreactor technology, *Chemical Engineering Journal*, **305**, 1 December 2016, 37–45. <https://doi.org/10.1016/j.cej.2015.08.141>
- Judd, S. (2006) *The MBR Book: Principles and Applications of Membrane Bioreactors in Water and Wastewater Treatment*. 1ª ed – Elsevier Ltd, Oxford, UK. 325 pp.
- Khouni, I., Louhichi, G., Ghrabi, A. (2020). Assessing the performances of an aerobic membrane bioreactor for textile wastewater treatment: Influence of dye mass loading rate and biomass concentration. *Process Safety and Environmental Protection*, **135**(March 2020), 364–382. <https://doi.org/10.1016/j.psep.2020.01.011>
- Martí-Calatayud, M.C., Heßler, R., Schneider, S., Bohner, C., Yüce, S., Wessling, M., de Sena, R.F., Athayde Júnior, G.B. (2020) Transients of micropollutant removal from high-strength wastewaters in PAC assisted MBR and MBR coupled with high-retention membranes. *Separation and Purification Technology* **246**(September 2020), 116863. <https://doi.org/10.1016/j.seppur.2020.116863>
- Metcalf, L.; Eddy, H. P. *Tratamento de Efluente e Recuperação de Recursos*. Tradução de Hespanhol, I.; Mierzwa, J. C. - 5. ed. Porto Alegre: AMGH, 2016. 1980pp.
- Moore, A. W., Zytner, R. G., Chang, S. (2016). Potential Water Reuse for High Strength Fruit and Vegetable Processor Wastewater with an MBR. *Water Environment Research*, **88**(9), 852–870. <https://doi.org/10.2175/106143016X14609975747649>
- Moore, A. (2015). Potential of water reuse for high strength fruit and vegetable processor wastewater by Membrane Bioreactor (MBR). Master of Applied Science in Engineering. The University of Guelph. Ontario. 240pp.
- Mundi, G., Zytner, R. G., Warriner, K. (2017). FRUIT AND VEGETABLE WASH-WATER CHARACTERIZATION, TREATMENT FEASIBILITY STUDY AND DECISION MATRICES. *Canadian Journal of Civil Engineering*, **44**(11), 971–983. <https://doi.org/10.1139/cjce-2017-0214>
- Park, Hee-Deung; Chang, In-Soung; Lee, Kwang-Jin. (2015) Principles of Membrane Bioreactors for Wastewater Treatment. Boca Raton, Flórida: Taylor & Francis Group, LLC, 2015. 436 pp.
- Pirsaheb M., Mohammad H. D. A. F., Zinadini S., Zinatizadeh A. A., Rahimi M., Vatanpour V. (2019) Fabrication of high-performance antibiofouling ultrafiltration membranes with potential application in membrane bioreactors (MBRs) comprising polyethersulfone (PES) and polycitrate-Alumoxane (PC-A), *Sep. Purif. Technol.*, **211**, 618–627. <https://doi.org/10.1016/j.seppur.2018.10.041>
- Qiblawey, H., Judd, S. (2019) Industrial effluent treatment with immersed MBRs: treatability and cost. *Water Sci Technol* 15 August 2019; **80**(4): 762–772. <https://doi.org/10.2166/wst.2019.318>
- Santos, A., Ma, W., Judd, S. (2011). Membrane bioreactors: Two decades of research and implementation, *Desalination*, **273**(1), 1 June 2011, 148–154. <https://doi.org/10.1016/j.desal.2010.07.063>

- Sawadogo, B., Konaté, Y., Lesage, G., Zaviska, F., Monnot, M., Heran, M., & Karambiri, H. (2018). Brewery wastewater treatment using MBR coupled with nanofiltration or electrodialysis: biomass acclimation and treatment efficiency. *Water Science and Technology*, **77**(11), 2624–2634. <https://doi.org/10.2166/wst.2018.232>
- Sehar, S., Nasser, H. A. A. (2019) Wastewater treatment of food industries through constructed wetland: a review. *Int. J. Environ. Sci. Technol.* **16**, 6453–6472. <https://doi.org/10.1007/s13762-019-02472-7>
- Subtil, E. L., Hespanhol, I., Mierzwa, J. C. (2013) Biorreatores com membranas submersas (BRMs): alternativa promissora para o tratamento de esgotos sanitários para reúso. *Revista Ambiente & Água*, **8**(3), 129-142. <https://doi.org/10.4136/ambi-agua.1230>
- Tekerlekopoulou, A. G., Economou, Ch. N., Tatoulis, T. I., Akratos, C. S., Vayenas, D. V. (2020). *Wastewater treatment and water reuse in the food industry*. Editor(s): Charis Galanakis, The Interaction of Food Industry and Environment, 2020, 245-280, <https://doi.org/10.1016/B978-0-12-816449-5.00008-4>
- Viero, A. F. *Avaliação do desempenho de um Biorreator com Membrana submersa para tratamento de efluente*. Tese do Instituto Alberto Luiz Coimbra de Pós-Graduação e Pesquisa de Engenharia (COPPE), Universidade Federal do Rio de Janeiro - UFRJ, 2006. 174 pp.
- WHO – World Health Organization (2006) *Guidelines for the safe use of wastewater, excreta and greywater – Volume 1 – Policy and regulatory aspects*. WHO Library, 114 pp.
- Xiao, K., Liang, S., Wang, X., Chen, C., Huang, X. (2019). Current state and challenges of full-scale membrane bioreactor applications: A critical review. *Bioresource Technology*, **271**, January 2019, 473-481. <https://doi.org/10.1016/j.biortech.2018.09.061>
- Ziegler, A.S., Mcilroy, S.J., Larsen, P., Albertsen, M., Hansen, A. A., Heinen, N., Nielsen, P. H. (2016). Dynamics of the fouling layer microbial community in a membrane bioreactor. *PLoS ONE*, **11**(7), 1-14. <https://doi.org/10.1371/journal.pone.0158811>