

RE-DESIGNING OF HAIR CLIPPER USING DESIGN FOR MANUFACTURING AND ASSEMBLY

Abhishek Prasad ^{a1}, Rahul Jadhav ^{a2}, Tarun Kasireddi ^{a3}, Pravin Pawar ^{a4,*}

^aDepartment of Mechanical Engineering, National Institute of Technology Goa, Ponda, Goa, India, 403401.

^{a1}abhishek.prasad1807@gmail.com, ^{a2}rahuljadhav26102000@gmail.com, ^{a3}tarunkasireddi24@gmail.com, ^{a4*}pravinpawar@nitgoa.ac.in

Abstract:

Evaluating the product functions and associating them with the manufacturing technique is crucial to reducing the manufacturing cost. Design for Manufacturing and Assembly (DFMA) is a concurrent engineering technique that plays a vital role in redesigning of existing product or service by reducing its manufacturing and assembly cost and time, have the desired level of quality and reliability. In this research work is apply DFMA on existing hair clipper and decrease the net manufacturing cost of the hair clipper. Hair clipper is very popular for at-home use and is seen as an essential tool in hair grooming. The analysis of design for manufacturing and assembly is done using guideline of Boothroyd Dewhurst DFMA. The components of the Hair clipper were undergone alteration by using DFMA and redesigned approaches. In the same platform, the actual model had the redesign. The assembly time for redesign exhibited an enhancement of 49.25% where the assembly time was decreased from 322.91 s to 163.81 s and design efficiency was improved 7.219% from 7.432% to 14.651%. Hence, the best design of hair clipper was made which is having optimal value is achieved.

Keywords: DFMA, hair clipper, boothroyd dewhurst, trimmer, design efficiency.

Cite as: Prasad, A., Jadhav, R., Kasireddi, T., Pawar, P. (2023). Re-designing of hair clipper using design for manufacturing and assembly. *J Appl Res Eng Technol & Engineering*, 4(1), 25-36. <https://doi.org/10.4995/jarte.2023.18810>

1. Introduction

The first electric clipper was developed in the 19th century by Leo Wahl. The global electric hair trimmer as well as clipper market size was valued at USD 5.3 billion in 2018. Raising demand for hair clipper is associated with increasing interest in personal grooming. Easy to use and safety parameter has increased demand of hair clipper over conventional razer. The main features of the product include cordless/corded usage, waterproof, travel lock, and stainless-steel body. The electric clippers are largely preferred among consumers over traditional razors due to their skin-friendliness and safety features. The rising importance of self-grooming is the key factor surging the requirement for electric hair clippers & trimmers (Nana et al., 2018; Million Insights, 2020). Design for manufacture and assembly (DFMA) includes two methodologies i.e. design for manufacture (DFM) as well as design for assembly (DFA). DFM helps in analyzing the materials and process used for manufacturing and helps in ease of manufacturing.

DFA helps in minimizing the assembly time and total number of parts by removing or reducing the unnecessary parts, thus helps in increasing the efficiency of the product. DFMA is applied to the product in the beginning stages of the product design, so that the manufacturing and assembly expenses of the parts or assemblies can be estimated well before the product design. It will give a better idea of optimal product design which helps a company to be profitable. Design for Manufacturing and Assembly (DFMA) is required to improve upon current manufacturing process and to decrease the number of

parts for ease of assembly process. DFMA highlights on the idea of making products right at the first time, rather than rushing into tooling, design and manufacturing, and modify repeatedly after the products are made. Design for Manufacturing and assembly is a methodical procedure for analyzing present designs from the outlook of assembly processes. To get better results of DFMA, it should be applied in the earlier stages of designing process. In return, an easier design requires less time and fewer resources for production, so it will be less expensive. It has the advantages of reducing the cycle time of product development and launching. Cost cutting of design change and manufacturing, reducing the cost of assembly and improving the quality of the product. (Edwards, 2002; Naiju, 2021; Gao et al. 2018; Hatcher et al., 2021; Butt & Jedi, 2020; Langston et al., 2021; Formentini, 2022).

The manufacturing expenses and assembly expenses of each and every part and assembly are analyzed again using DFM and DFA for the new design. The total manufacturing and assembly expenses can be obtained by summing up the expenses of all parts and all the assemblies. In this way DFMA helps in estimating the expenses of manufacturing and assembly in the beginning stages of the design of product (Annamalai, 2013). The efficiency of present design and redesigning it with the help of DFMA principles. The methodology for this product proceeds from designing the concept in CAD then applying DFA then calculating the efficiency of the design and finally DFM will be applied. So first the model

*Corresponding author: P. Pawar, pravinpawar@nitgoa.ac.in

of product design is developed in CAD. Then, it proceeds for DFA. The assembly, assembly time and number of parts in it are inspected. If any of the part is not needed, then it will be removed or it is redesigned. Then the design efficiency is calculated for the product. Finally, DFM is applied on it. For making the design of each component of final product easier, the material and process are analyzed. The unnecessary parts will be removed or reduced for getting better efficiency of the design. Then the redesigned product is compared with the present product and developments in every aspect is observed. The assembly time and expenses of manufacturing are reduced (Salikan et al., 2020).

Nowadays, DFMA is used in most of the industries but when it comes to construction industry, its implementation is slow. When DFMA is compared with traditional construction, it is found that DFMA has advantages over traditional construction. DFMA involves all technical and non-technical teams to actively participate in the process of design and planning, minimized expenses and improved efficiency, superior quality of construction, care for labor health and their safety, minimized wastage etc. some construction industries have followed the DFMA and obtaining the advantages of DFMA. But there are still challenges for DFMA to be adopted by many construction industries. Adopting DFMA will help an industry in design solution and developments in the methodology of construction and when compared to traditional construction it helps in minimizing labor, minimized time, minimized expenses, quality development, and developments in environmental performance. (McFarlane & Stehle, 2014). DFMA is a methodology of developing a product design by using the techniques that helps in reducing the complexity of assembling and manufacturing of the product parts. The techniques includes minimizing total number of parts, assembly expenses and time and total product expenses. Boothroyd Dewhurst methodology is used in this case, which has the following procedure. First product model is developed in CAD. Then the product is processed to DFA in order to calculate the assembly expenses and time for the product. This DFA helps in inspecting the assembly and gives indications for better assembly design. Then the parts that are not necessary are removed or minimized for the better efficiency of the product. DFA index helps in deciding whether the part is necessary or not. Part count and complexity of assembly are the factors that affects the expenses of assembly. Then finally part proceeds for DFM in which the part that is to be designed, is inspected for easy manufacturing. In DFM, the material and the process for manufacturing that will make the design easier will be identified (Lu, 2021).

In this work, DFMA methodology is used to analyze the design of product and expenses related to it. This helps in reducing the complexity of manufacturing and assembly process while designing the product. DFMA is applied on the vehicle parts at the beginning stages of the product development to get better design with optimal expenses. By applying DFMA processing time is minimized for each part and by minimizing the part count, the overall assembly time is also minimized. Also, overall production expenses will be reduced by reducing the complexity of the product structure. DFMA design when compared to traditional design has advantages like, the time taken for development and releasing of product is reduced,

minimizing the assembly and manufacturing expenses and development in the quality of the product. Here with the help of DFMA, the assembly and manufacturing process of the overall product is analyzed by the product engineer. Each design element is checked whether it is important and finally, a lean design is obtained (Ni, 2019). Design for environment (DFE) helps in economic development without depletion of natural resources so that they will be available to upcoming generations. DFMA helps in the development of product in the beginning stages by reducing the mistakes in design. This in total helps the product to be eco-friendly and helps the company in getting profits. The materials used for manufacturing are selected based on reduced impact on environment which includes quality of ecosystem, human health and depletion of resources. So DFE and DFMA helps in minimizing the time required for design evaluation and thus they should be considered in the process of design selection. These methods helps in product design in which designs can be produced at lesser costs and with lesser impact on environment and helps the companies which follow these methodologies to be much profitable (Chowdary & Harri, 2009). In order to reduce use of precious resources and make product environment friendly to turn towards DFMA to help us achieve less carbon footprint and sustainability. There is scope for improvement in every product. Nowadays, Hair clipper is commonly used for hair grooming and styling. Hair clipper is grown to become a daily grooming product. Hair clippers are sold in market under various types and price tag. The method such as DFMA is an attractive method to satisfy customer needs for affordable price. However, in order to implement a new design, some drawback will be encountered such as a problem with feasibility of the diagnosis tasks and design reliability. The objectives of this research work is to propose a new design for hair clipper. To reduce the part counts in hair clipper. To evaluate the design efficiency for hair clipper. The chosen product for design improvement is hair clipper. DFMA Pro software is preferred as the DFMA tool. The hair clipper design modeling by applying SOLIDWORKS for current design and improve design.

2. Methodology

In this section explaining the disassembly of current design, describing all components. The disassembly process described with step by step in figures. Table 1 includes description of all components with figures, it contains the number of subparts found during disassembly. Then the function of each part is described separately with figure. The manufacturing material is also described in the table. The 3-D model is generated with measurement for further analysis. The design for manufacturing process and design for assembly guidelines are discussed further with the efficiency calculating process. The analysis is done for cost reduction when produced in bulk and thus, it will make it more simplified and cheaper with customer satisfaction. In this hair clipper four screws were visible on outer casing, two on stationary blade and other two on lower side. Opening stationary blade screws, it detached the blade and underneath was stationary blade platform. Next, to remove two screws holding cutting adjustment lever mechanism to outer body, and two lower screws which remove lower body. The blue coloured coil, long armature as two major working components. Unscrewing

Table 1: Assembled and Disassembled Hair clipper.

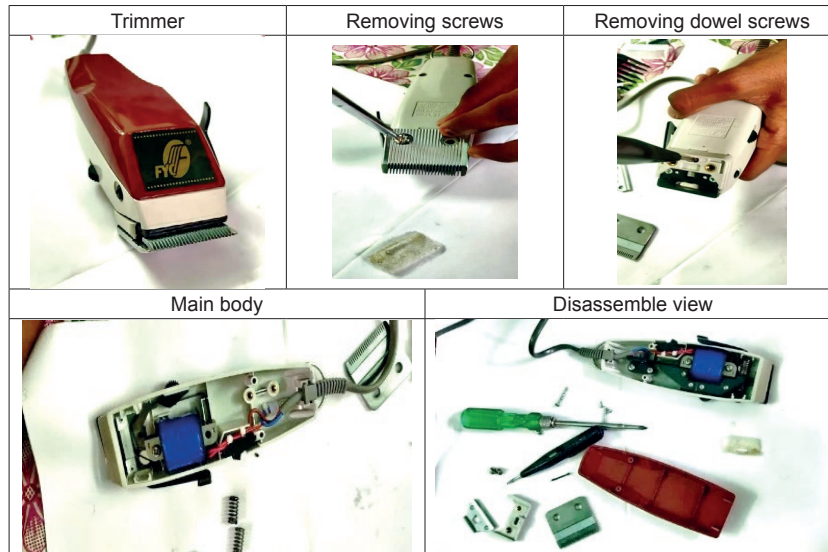

the bottom armature screws are separate armature, along with armature springs and power screw is also separated. Also the length adjustment lever mechanism, which can slide out. Lock of adjustment lever and leaf spring is easily removed. Switch is a separate component which is soldered to coil and power cord. Coil is held in place with help of two screws, and iron core is placed in between through coil.

To analyse DFMA, model was constructed to further redesign outer body parts to follow DFA guidelines. Model is important to visualise and make changes whenever found. Creo software was used to make model.

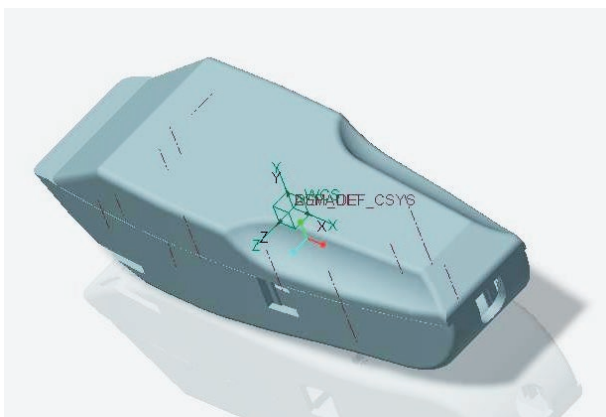

Figure 1: 3D Model.

2.1. Design for Assembly (DFA)

Firstly, for DFA have lot of sub categories, For guidelines regarding part handling have;

1. Parts should have end to end and rotational symmetry, if this can't be done then maximum symmetry must be achieved.
2. Parts when stored in bulk must not jam and get entangle into each other.

Slippery, delicate, very small parts should be avoided.

2.2. Guidelines for Insertion and Fastening

1. For ease of assembly, generous amount of clearance must be provided to avoid parts to jam as well as hang.
2. Standard common parts and processes must be used to permit interchangeability across products.
3. Pyramid assembly should be followed for progressive line assembly, in general it is best to assemble from above.
4. It should not be necessity to hold a part during sub assembly, part should be easily secured as it is inserted.
5. Snap fitting, plastic bending, riveting, and screw fastening are the mechanical fasteners in descending sequence of increasing assembly cost.
6. Repositioning of existing assembly should be avoided to reduce time.

The below table represent symmetry angle and theoretical count following the guidelines of DFMA Boothroyd Dewhurst. For ease of insertion, part must be symmetrical. There are 2 kinds of symmetry;

1. Alpha symmetry: depends upon the angle through which part must be rotated about axis perpendicular to axis insertion to repeat its orientation.
2. Beta symmetry: depends on angle through which part must be rotated about axis of insertion to repeat its orientation.

To know theoretical minimum part count is essential to identify possible simplification in product. To identify;

1. During operation part moves relative to other assembled parts.
2. If part is made up of different material, or must be isolated.

On this basis parts will be integrated and redesigned for easier assembly. DFA index or assembly efficiency is

obtained by dividing theoretical minimum assembly time by actual assembly time.

$$DFA = \frac{\text{Theoretical Part Count} \times 3 \text{ s}}{\text{Total Assembly Time}}$$

2.3. Time Calculation Procedure

To calculate assembly time, it is needed handling time and insertion time. A predetermined table is present for both handling and insertion for different size parts and according to different scenarios. To calculate time a 2-digit

code is assigned, for handling time ten's digit signifies sum of symmetry angles alpha and beta. One's digit signifies combination of size and thickness. For insertion, ten's digit tells us whether parts are secured and ease to reach the place. One's digit tells us about ease of alignment, holding down requirement and operation. Finding the cell which corresponds to given code gives required time. Table 3 shows that total count of theoretical parts is 8, total assembly time is equal to 322.9 seconds. Therefore, Design efficiency of old model came out to be, 7.432%. Due to removal of above sub parts, several other small parts and fasteners are also removed, hence total no. of parts reduced are 29.

Table 2: Hair clipper Parts Table.

S. No.	Part Name	Qty.	Material	Picture	Part function
1	Stationary Mounting Blade	1	Stainless steel		Stationary part of blade which contact with skin
2	Reciprocating Blade	1	Stainless steel		Blade which reciprocates and perform cutting
3	Blade Mounting Screw	2	Steel		
4	Blade Mounting Platform	1	Polyoxymethylene		Stationary part of blade is mounted on this.
5	Dowel Screw	1			Connects blade platform and internal adjustment level
6	Small Upper Star Screw	2	Steel		Holds cutting length adjustment lever mechanism to outer casing
7	Long Lower Star Screw	2	Steel		Joins outer casing to Bottom holder case
8	Back Lid	1	Polyoxymethylene		Encases entire assembly at the end
9	Outer Casing	1	Polyoxymethylene		Holds entire sub- assembly
10	Lower Armature Screws	2	Steel		Joins armature to outer casing
11	Lower Armature Screw Washers	2	Steel		
13	Armature	1			Main component that reciprocates the blade
14	Springs	2	Steel		To restrict motion of armature
15	Power Screw	1			To adjust length of spring to change reciprocating frequency
16	Square Nut	1			

(Table 2 continues in the next page)

Re-designing of hair clipper using design for manufacturing and assembly

(Table 2 continues from the previous page)









S. No.	Part Name	Qty.	Material	Picture	Part function
17	Cutting Length Adjustment Lever Mechanism	1			Moves stationary blade to adjust length of cutting
18	Lock Of Adjustment Lever	1			To fix the adjusted length
19	Leaf Spring of Lock	1	steel		
20	Screws To Hold Coil	2	Steel		Fixes coil to outer casing
21	Coil Screws Washers	2	Steel		
22	Coil	1	Copper with iron core		Produces magnetic field to attract armature and get reciprocating motion
23	Switch	1			To turn trimmer on and off
24	Brass Internal Threads	6	brass		To provide internal threading for screws in plastic body
25	Wires	1	copper		To carry electricity or power
26	Cord	1			Insulation for power cord
27	Ring On Case	1	steel		To hang or place it on wall

Table 3: Manual handling time and Manual insertion time of original product.

Part name	Theoretical	alpha	beta	Qty.	Insertion time	Handling time	Total
Stationary Mounting Blade	1	360	360	1	2	2	3
Reciprocating Blade	1	360	360	1	2	3	4
Blade Mounting Screw	0	360	0	2	6	3	18
Blade Mounting Platform	0	360	360	1	2	2	4
Dowel Screw	0	360	0	1	12	6	18
Small Upper Star Screw	0	360	0	2	9	3	22
Long Lower Star Screw	0	360	0	2	6	2	17
Bottom Holder Case	1	360	360	1	5	3	8
Outer Casing	1	360	360	1	5	3	8
Lower Armature Screws	0	360	0	2	6	3	17
Lower Armature Screw Washers	0	180	0	2	2	3	9
Armature	1	360	360	1	6	2	7

(Table 3 continues in the next page)

(Table 3 continues from the previous page)

Part name	Theoretical	alpha	beta	Qty.	Insertion time	Handling time	Total
Bend Sheet Parts							-
Sheet Without Bend		180	180	4			-
Sheet With Bend		360	360	4			-
Rivet		360	0	10			-
Plastic Tab		360	360	1			-
Iron Core		360	360	1			-
Springs	1	180	0	2	5	4	18
Power Screw Assembly	0	360	90	1	6	2	7
Power Screw	0	360	0	1			-
Square Nut	0	180	90	1			-
Cutting Length Adjustment Lever Mechanism	0			1			-
Outer Lever		360	360	1	4	3	6
Platform Connector		360	360	1	11	3	13
Coil Spring		360	360	1	8	3	11
Screw		360	0	1	8	3	11
Lock Of Adjustment Lever	0	360	360	1	3	2	5
Leaf Spring Of Lock	0	360	360	1	5	3	8
Screws To Hold Electromagnet	0	360	0	2	6	2	17
Electromagnet Screws Washers	0	180	0	2	2	3	9
Electromagnet	1	360	360	1	2	2	3
Switch	1	360	360	1	10	2	12
Brass Internal Threads	0	360	0	4	12	3	58
Ring On Case	0	360	180	1	4	6	10
				Total parts	57	Total time	323

Table 4 shows that theoretical part count remains same. Total assembly time is equal to 163.8 seconds. Therefore, Design efficiency of old model came out to be, 14.651%.

2.4. Design for Manufacturing (DFM) Approach

Design for Manufacturing is the process of designing the products or components of products for making the manufacturing process easier which results in design of a better product with minimized cost. In this case using Design for manufacturing, the material and the manufacturing process used to make the product will be identified to simplify the design of the hair clipper assembly. The following guidelines are used for current research study (Boothroyd, 2005; Boothroyd et al., 2010; Xin, 2019).

1.1.1. DFM helps in

1. Minimize the number of product parts: Minimizing the part count in the product is a simple way to reduce the cost of a product. Because minimizing the number of parts will simultaneously minimize the material amount and labor required for its assembly. Minimizing the part count also indicates less engineering, less production and less transportation costs.
2. Use standardized parts wherever possible: Modification of parts results in more cost as well as consumes more time. So, the standardized parts which are already made to meet the same quality measurements. They are already tooled. So, this can reduce the costs.
3. Create a modular design: Dividing the product into modules will help us in making any future product redesign easier and allows the usage of standardized parts
4. Design multi-functional parts: Designing multi-functional parts i.e., parts which have more than one function, is an easiest way to minimize the part count.
5. Design multi-use products: Designing multi-use products helps different products share parts that have been designed for multi-use.
6. Design for ease of fabrication: Choose the optimized combination of material and manufacturing process that will reduce the production costs. Avoid tight tolerances because the tighter the tolerance, the more the product will cost to manufacture.
7. Design your product to join without using screws, fasteners or adhesives: Screws add only 5% to the material cost whereas they add 75% to the labor assembles it. So, check for the possibility of the

Table 4: Manual handling time and Manual insertion time of Redesigned product.

Part Name	Theoretical	Alpha	Beta	Qty.	Insertion time	Handling time	Total time
Stationary Mounting Blade	1	360	360	1	2	2	4
Reciprocating Blade	1	360	360	1	2	3	4
Blade Mounting Screw	0	360	0	2	6	3	18
Blade Mounting Platform	0	360	360	0	2	2	0
Dowel Screw	0	360	0	0	12	6	0
Small Upper Star Screw	0	360	0	0	9	3	0
Long Lower Star Screw	0	360	0	0	6	2	0
Bottom Holder Case	1	360	360	1	5	3	8
Outer Casing	1	360	360	1	5	3	8
Lower Armature Screws	0	360	0	1	6	3	9
Lower Armature Screw Washers	0	180	0	1	2	3	5
Armature	1	360	360	1	6	2	8
Bend Sheet Parts							0
Sheet Without Bend		180	180	0			0
Sheet With Bend		360	360	3			0
Rivet		360	0	5			0
Plastic Tab		360	360	0			0
Iron Core		360	360	1			0
Springs	1	180	0	2	5	4	18
Power Screw Assembly	0	360	90	0	6	2	0
Power Screw	0	360	0	0			0
Square Nut	0	180	90	0			0
Cutting Length Adjustment Lever Mechanism	0			0			0
Outer Lever		360	360	0	4	3	0
Platform Connector		360	360	0	11	3	0
Coil Spring		360	360	0	8	3	0
Screw		360	0	0	8	3	0
Lock Of Adjustment Lever	0	360	360	0	3	2	0
Leaf Spring of Lock	0	360	360	0	5	3	0
Screws To Hold Electromagnet	0	360	0	2	6	2	17
Electromagnet Screws Washers	0	180	0	2	2	3	9
Electromagnet	1	360	360	1	2	2	3
Switch	1	360	360	1	10	2	12
Brass Internal Threads	0	360	0	3	12	3	44
Ring On Case	0	360	180	0	4	6	0
				Total Parts	28	Total Time	164







product to interlock or clip together. If fasteners are required, try to limit their count, size and type to a minimum and if possible, try to use standard fasteners.

8. Design your part to minimize handling, especially during production and assembly: Handling of a part includes its orientation, positioning and fastening. As the orientation of similar parts is easier to understand, using them will help in minimizing the handling.
9. Minimizing assembly direction: Assembling the parts from one direction will make assembling

easier. Generally, placing the parts should be done from above, in the direction of gravity i.e., downwards. In this format, the assembling will be easier due to gravity rather than opposed by it.

10. Design your part to maximize compliance: Built-in design features like chamfers or tapers or moderate radius sizes to assist in insertion of parts and to avoid the part damage.

Table 5: Parts removed and Its Reason.

Sr. No.	Part Removed	Part Image	Reason
1	Cutting Length Adjustment Lever Mechanism		The motion imparted due to mechanism was irrelevant that's why modern trimmers do not incorporate it to reduce their manufacturing cost.
2	Blade Mounting Platform		This platform was used to transmit sliding motion in above mechanism which was not necessary for relevant function of trimmer, that lead to integration with body frame.
3	Dowel Screw		It connects part 2 with 1, which are removed and integrated as a result this part was also removed.
4	Lock of Adjustment Lever		Not relevant
5	Leaf Spring of Lock		Not relevant
6	Lower Star Screw		Alternate is provided which is integrated
7	Ring On The Case		Irrelevant

2.5. In this case to apply DFM on outer body, guidelines related to injection moulding should be followed

1. Thickness of the part must be of constant for fast and even cooling. In order to ensure this suitable boss height must be selected as tall features increases base thickness and hence features with higher base thickness need to be provided with recess.
2. In order to minimize the complication in making of mold design, parts and its features like ribs and bosses need to have same pull direction.
3. In order to minimize further processing and supply enough strength to the part, proper filet and chamfer must be directly incorporated in the mold design.
4. In order to pull the part easily out of the mold, small draft angles need to be provided.

5. In order to lower the cost, generous tolerances should be provided and use the shrinkage factor in favor to get suitable dimensions.

2.6. For bend sheet metal parts such as armature, the following guidelines are to be used

1. Minimum distance from extruded hole to part edge: Deformation or tearing of the metal may takes place if the extruded hole is too near to the part edge. The minimum recommended distance between the extruded holes to the part edge need to be minimum three times the thickness of sheet metal.
2. Minimum distance between extruded holes: Certain distance need to be maintained between two extruded holes in sheet metal designs. If extruded holes are too near to each other, it may cause metal deformation. The minimum recommended distance between two extruded holes must be six times the thickness of sheet metal.

Table 6: The material used and process that exist in hair clipper for each part of it.

Part Name	Material	Process
Stationary Mounting Blade	Plane Carbon Steel	Machining
Reciprocating Blade	Alloy Steel	Machining
Bottom Holder Case	ABS	Inject Moulding
Outer Casing	ABS	Inject Moulding
Lower Armature Screws	Aluminium Alloy	Thread rolling
Lower Armature Screw Washers	Aluminium Alloy	Stamping
Springs	AISI 1045 Steel	Cold Drawing & Bending
Power Screw Assembly	ABS	Inject Moulding
Electromagnet Screws	Aluminium Alloy	Machining
Coil Screws Washers	Aluminium Alloy	Machining
Electromagnet	Copper With Iron Core	
Switch	ABS	Inject Moulding
Brass Internal Threads	Brass	Machining
Ring On Case	Material	Process

3. Minimum bend radius: When the minimum bend radius is less than the recommended value, it can cause fracturing in hard material and material flow problems in soft material. In such cases localized necking or fracture may also occur. The minimum recommended inner bend radius needs to be equal to material thickness.

3. Results and Discussion

This section deals with design for manufacturing analysis and design for assembly analysis is done separately on the current design. The problems based on current design are discussed. The comparative study has been done in between existing model and redesigned model shown in Figure 2.



Figure 2: Redesigned Trimmer

3.1. Redesign of Back-lid

In the previous design the back lid is connected to the remaining parts of the trimmer with the help of screws whereas in the redesigned one, the screws and the holes for inserting the screws were removed. Instead, the back lid and the other parts were connected by snap fit. For the older model polyoxymethylene was used as the material and for the redesigned model ABS was used as the material.

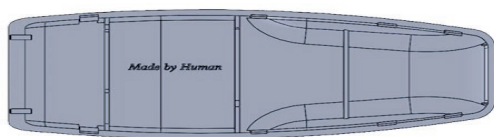

Figure 3: Redesigned Back-lid.

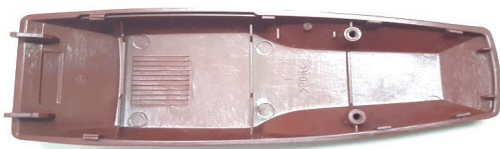

Figure 4: Old Back-lid.

For the older model the edge on the back lid was sharp. It was smoothened and changed to curved shape. With these changes the weight of the new model was reduced when compared to the older model as the material is changed and few parts are reduced.

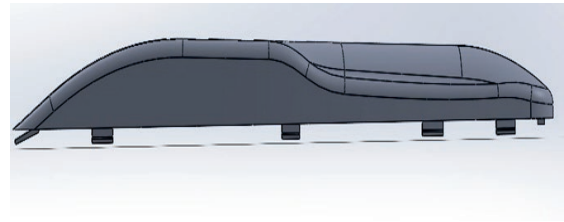

Figure 5: Redesigned Back-lid Front view.

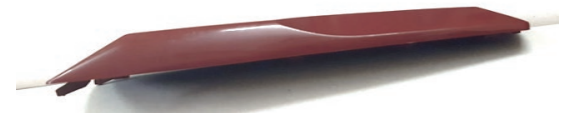

Figure 6: Old Back-lid Front view.

3.2. Redesign of Armature

Previous design of armature included many small sub parts connected using external fasteners, rivets. Armature is redesigned into two parts, lower and upper, which can be made with sheet metal and bending.

Lower part: Entire lower part is integrated into one sheet metal feature. This leads to reduction of three back attachment plates and four used to join them. This also helps in reduction of no of interface and alignment required to secure and assemble the part, which in turn leads to reduction of assembly time and saves material and energy required for their processing.

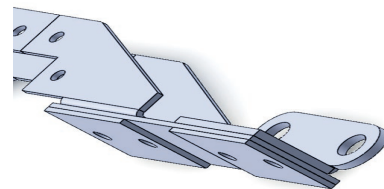

Figure 7: Old Lower Armature.

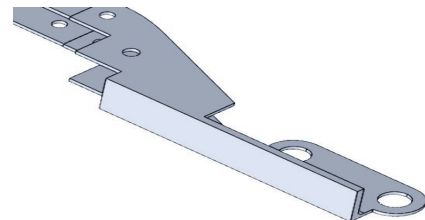

Figure 8: Redesigned Lower Armature.

Upper part: Similar to previous one, requirement for alignment is removed and large fasteners are used to serve the purpose of securing springs in place to ease further assembly process. Above changes eliminate possibility of placing different parts in wrong order.

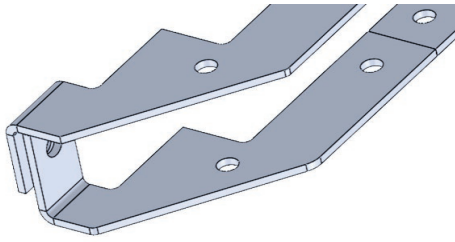

Figure 9: Old Upper Armature.

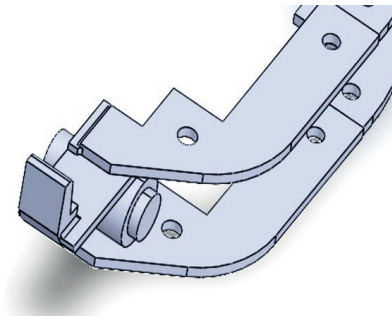

Figure 10: Redesigned Upper Armature.

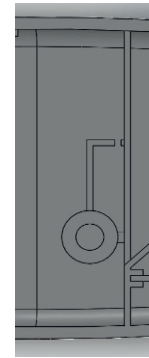

Figure 13: Section of old lower-case.

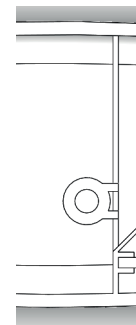

Figure 14: Section of Redesigned Lower-case.

3.3. Redesign of Lower Part of Case

Instead of 2 fixed screw points, one screw was eliminated and replaced with rigid pivot element to achieve same constraint. Extra 2 holes to join both casings are replaced by press fit.

The rectangular cutout space for “lock for adjustment lever” and circular space for power screw is removed, as both mechanisms were non theoretical.

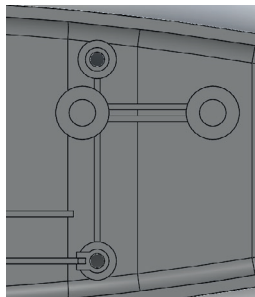

Figure 11: Old Lower-case.

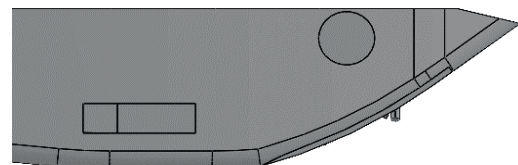

Figure 15: Section of old lower-case.

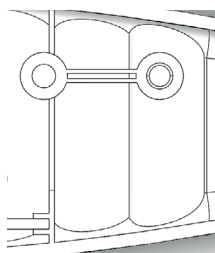

Figure 12: Redesigned Lower-case.

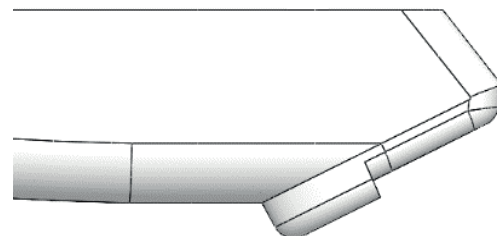

Figure 16: Section of Redesigned Lower-case.

The L shaped rib was required to hold leaf spring for lock mechanism, after removal of lock mechanism the rib is also removed.

Instead of sliding blade mounting platform in previous design integrated it on the body as sliding motion is non theoretical and the “cutting length adjustment lever mechanism was removed”.

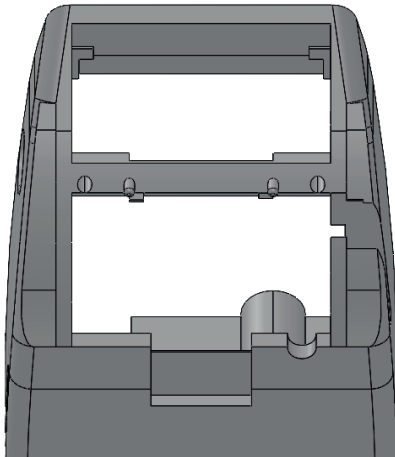

Figure 17: Section of old lower-case.

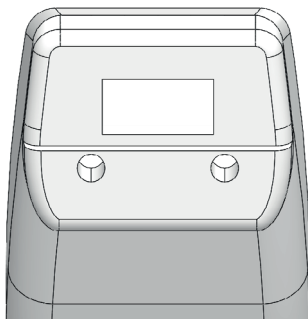

Figure 18: Section of Redesigned Lower-case.

Taking ergonomics into consideration, grip imprinted on back casing to ease holding of trimmer.

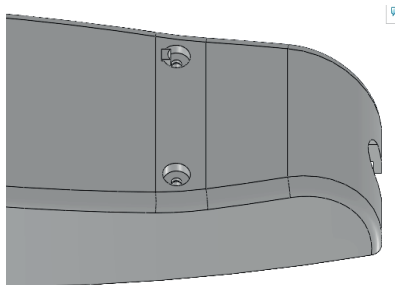

Figure 19: Section of old lower-case.

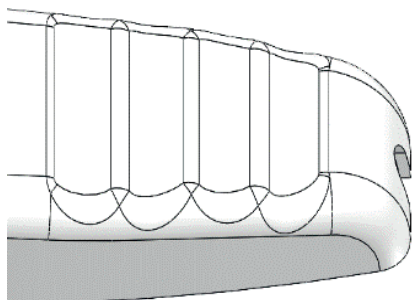

Figure 20: Section of Redesigned Lower-case.

3.4. Design Improvement Table

Table 7 represents the correlation of the handling time, insertion time, part quantity, design efficiency, assembly time among the existing design and enhanced design of Hair clipper. This table shows an improvement in design efficiency of 7.219 % because of 29 parts have removed during the redesign process. The result for the part count percentage is 50.87%, which is thought to be a positive result since the redesign process has eliminated 50% of the total number of components. Calculation-based evidence indicates that the insertion time being minimised is greater than the handling time, which is 109 and 50.1 seconds, respectively. A total of 159.1 seconds are being cut out of the assembly time. As a result, by having fewer parts, the redesign can shorten the overall production time and lower costs. From this study, the time as well as cost of material is decreased which is outcome of this research work.

Table 7: Final Results.

	Existing	Redesign	Differences	Improvement
Part Quantity	57	28	29	50.87%
Handling Time	103.41	53.31	50.1	48.44%
Insertion time	219.5	110.5	109	49.65%
Assembly Time	322.91	163.81	159.1	49.25%
Design Efficiency	7.432%	14.651%	7.219%	7.219%

4. Conclusion

Engineers can evaluate a product's overall manufacturability and simplicity of assembly using the DFMA. It incorporates manufacturing process information, enabling users to calculate manufacturing costs and make critical decisions about the selection of materials. The application of DFMA has been shown to be a fruitful method for improving the overall quality of the product while optimizing the design for reducing manufacturing costs and streamlining the assembly process. The product's design determines its overall cost, and DFMA analysis at the beginning of the design process might inspire initiatives to save costs. The cheapest method to accomplish that goal is through DFMA. In order to establish the redesign comparison outcome of design for assembly and manufacturing and the sustainable of the product, the existing and improvement design have been studied. The assembly time for redesign exhibited an enhancement of 49.25% where the assembly time was decreased from 322.91 s to 163.81 s and design efficiency was improved 7.219% from 7.432% to 14.651%. The distinction demonstrates clearly that fresh advancements are superior than existing ones in a number of ways. A product that is environmentally friendly can therefore be indicated by an improved design. This study achieved reduction of time as well as cost of hair clipper which is also helpful for future research wok.

References

- Annamalai, K., Naiju, C.D., Karthik, S., & Prashanth, M.M. (2013). Early Cost Estimate of Product During Design Stage Using Design for Manufacturing and Assembly (DFMA) Principles, *Advanced Materials Research*, 622-623, 540-544. <https://doi.org/10.4028/www.scientific.net/AMR.622-623.540>
- Boothroyd, G. (2005). *Assembly automation and product design*. CRC press. <https://doi.org/10.1201/9781420027358>
- Boothroyd, G., Dewhurst, P., & Knight, W.A. (2010). *Product design for manufacture and assembly*, CRC press. <https://doi.org/10.1201/9781420089288>
- Butt, J., & Jedi, S. (2020). Redesign of an in-market conveyor system for manufacturing cost reduction and design efficiency using DFMA methodology. *Designs*, 4(1), 6. <https://doi.org/10.3390/designs4010006>
- Chowdary, B.V., & Harri, A. (2009). Integration of DFMA and DFE for development of a product concept: A case study. In *Proceedings of the 7th Latin American and Caribbean Conference for Engineering and Technology*, 1-8.
- Edwards, K.L. (2002). Towards more strategic product design for manufacture and assembly: priorities for concurrent engineering. *Materials & design*, 23(7), 651-656. [https://doi.org/10.1016/S0261-3069\(02\)00050-X](https://doi.org/10.1016/S0261-3069(02)00050-X)
- Formentini, G., Boix Rodríguez, N., & Favi, C. (2022). Design for manufacturing and assembly methods in the product development process of mechanical products: a systematic literature review. *Int J Adv Manuf Technol*, 120, 4307-4334 <https://doi.org/10.1007/s00170-022-08837-6>
- Gao, S., Low, S.P., & Nair, K. (2018). Design for manufacturing and assembly (DfMA): a preliminary study of factors influencing its adoption in Singapore. *Architectural engineering and design management*, 14(6), 440-456. <https://doi.org/10.1080/17452007.2018.1502653>
- Hatcher, G.D., Ijomah, W.L., & Windmill, J.F.C. (2021). Design for remanufacture: a literature review and future research needs. *Journal of Cleaner Production*, 19(17-18), 2004-2014, <https://doi.org/10.1016/j.jclepro.2011.06.019>.
- Langston, C., Zhang, W. (2021). DfMA: Towards an Integrated Strategy for a More Productive and Sustainable Construction Industry in Australia. *Sustainability*, 13, 9219. <https://doi.org/10.3390/su13169219>
- Lu, W., Tan, T., Xu, J., Wang, J., Chen, K., Gao, S., & Xue, F. (2021). Design for manufacture and assembly (DfMA) in construction: The old and the new. *Architectural Engineering and Design Management*, 17(1-2), 77-91. <https://doi.org/10.1080/17452007.2020.1768505>
- McFarlane, A., & Stehle, J. (2014). DfMA: engineering the future, In *Proceedings of Council on Tall Buildings and Urban Habitat (CTBUH) 2014 Shanghai Conference*, 16, 508-516.
- Million Insights. (2020). Electric Hair Clipper & Trimmer Market Analysis Report By Product, By Distribution Channel, By Region And Segment Forecasts From 2019 To 2025. <https://www.millioninsights.com/industry-reports/global-electric-hair-clipper-trimmer-market>
- Nana, B., Yamgoue, S.B., Tchitnga, R., Wofo, P. (2018). On the modeling of the dynamics of electrical hair clippers, *Chaos, Solitons & Fractals*, 112, 14-23. <https://doi.org/10.1016/j.chaos.2018.04.016>
- Ni, W. (2019). Re-design on Vehicle Front Support Structure Using DFMA. Beijing Automotive Technology Center Co., Ltd. <https://www.dfma.com/pdf/wanpaper.pdf>
- Naiju, C.D. (2021). DFMA for product designers: a review. *Materials Today: Proceedings*, 46(17), 7473-7478. <https://doi.org/10.1016/j.matpr.2021.01.134>
- Salikan, N.S.M., Rosli, M.F., Mohammad, N.N., Rahim, I.A., & Fadzly, M.K. (2020). Design and analysis of grass cutting machine by using DFMA method. *IOP Conference Series: Materials Science and Engineering*, 864(1), 012213. <https://doi.org/10.1088/1757-899X/864/1/012213>
- Xin, T.J., Farizuan, R.M., Radhwan, H., Shayfull, Z., & Fathullah, M. (2019). Redesign of drone remote control using design for manufacturing and assembly (DFMA) method. *AIP Conference Proceedings*, 2129(1), 020159. <https://doi.org/10.1063/1.5118167>