

BAROQUE BANDED VAULTS: SURVEYING AND MODELING. THE CASE STUDY OF A NOBLE PALACE IN TURIN.

M. C. López González¹, R. Spallone^{2,*}, Marco Vitali², Fabrizio Natta²

¹ Dept. of Graphic Expression in Architecture, Universitat Politècnica de València, Camino de Vera, s/n Valencia, Spain – mlopezg@ega.upv.es

² Dept. of Architecture and Design, Politecnico di Torino, Viale Mattioli 39, Torino, Italy – (roberta.spallone, marco.vitali, fabrizio.natta)@polito.it

Commission II

KEY WORDS: Banded vaults, TLS survey, Architectural drawing, 3D modelling, Treatises, Baroque palaces

ABSTRACT:

This paper presents the methodological framework set up for the analysis, interpretation, and representation of the banded vaulted systems recognized in eleven Baroque atria in Turin. In these atria, the banded vaults, locally named “a fascie”, are featured by a series of arches orthogonal to the perimeter walls on which they rest. The arches divide the room’s ceiling into spaces that can accommodate small vaults of different shapes. The atria have been the subject of bibliographical, historical and documentary analyses, laser scanner metric survey, two-dimensional graphic representations, and interpretative hypotheses through three-dimensional modeling of the design’s geometries of the vaults.

The integration between terrestrial laser scanning (TLS) technique, architectural drawing and three-dimensional modeling methods led to the definition of new workflows, aimed at optimizing the use of data. From these procedures new opportunities for the research arise, such as the comparison (metric and geometric) through the superimposition of design ideal models and point clouds.

1. INTRODUCTION

The banded vaulted systems are one of the main covers for medium and large-sized rooms in Piedmontese Baroque palaces.

The research presented in this paper is the result of international collaboration for the project “Nuevas tecnologías para el análisis y conservación del patrimonio arquitectónico”, funded by the Ministry of Science, Innovation and the University of Spain. This has allowed Concepción López to join at the Politecnico di Torino the research group coordinated by Roberta Spallone and Marco Vitali, who have been conducting investigations into complex vaulted systems bricks-made in the Baroque buildings of Piedmont for several years (Spallone, Vitali, 2017a).

In the historical center of Turin, the research group has recognized eleven atria of noble palaces with banded vaulted systems. Deep knowledge of this Cultural Heritage, today not yet completely recognized for its value, is needed from different points of view. Firstly, the documentation of each atrium’s peculiarities and the recognizing as an element of a network of similar buildings can address to coordinated safeguard and restoration strategies as well as initiatives for the valorization (Jiménez Fernández-Palacios et al., 2013) through the creation of paths aimed at cultural tourism, as experimented in previous researches by our group (Spallone Vitali, 2017b).

For this reason, these atria have been the subject of bibliographical, historical and documentary analyses, laser scanner metric survey, two-dimensional graphic representations, and interpretative hypotheses through three-dimensional modeling of the design’s geometries of the vaults, these last also referring to coeval architectural literature.

The integration between terrestrial laser scanning (TLS) technique and two and three-dimensional modeling methods led to the definition of new workflows, aimed at optimizing the use of data. From these procedures new opportunities for the research arise, such as the comparison (metric and geometric) through the superimposition of design ideal models and point clouds. Finally, the analysis and comparison of the studied vaulted systems will allow highlighting shape patterns and variations on the theme.

This paper assumes as a case study on which to exemplify the developed methodology the vaulted atrium of a noble palace located in Via dei Mercanti 2, in the historic city center (fig. 1).



Figure 1. Banded vault in the atrium of the palace in Via dei Mercanti 2 in Turin. Photo: F. Natta

* Corresponding author

ADDRESS	PALACE'S NAME	ARCHITECT	DATE	WIDTH, DEPTH, HEIGHT	GRID
Alfieri 6	Galleani di Barbaresco	Luigi Michele Barberis	1709	9,42x6,80x7,17	3x3
Bogino 4				6,26x7,24x5,13	3x3
Bogino 31		Giovanni P. Baroni di Tavigliano	(1705-1762)	N.A.	3x3
Consolata 3	Martini di Cigala	Filippo Juvarra	1716	7,66x10,37x6,75	3x5
Des Ambrois 4	Roero di Guarene	Carlo G. Roero di Guarene	1710	8,51x13,37x5,36	3x5
Garibaldi 38				9,12x5,56x4,62	3x3
Garibaldi 53				9,45x6,20x6,16	3x3
Maria Vittoria 26	Coardi di Carpenetto	Amedeo di Castellamonte	(1613-1683)	10,05x14,80x5,77	3x3
Mercanti 2				7,05x5,28x3,87	3x3
Orfane 7	Barolo	Gian Francesco Baroncelli	(1640 – 1699)	8,32x10,42x6,78	3x4
S. Maria 1	Capris di Cigliè	Gian Giacomo Plantery	1730	9,33x5,97x6,24	3x3

Table 1. Baroque atria in Turin with banded vaults

2. BANDED VAULTS IN ARCHITECTURAL LITERATURE

The analysis of architectural literature, treatises, and manuals, reveals the theoretical and applicative relations aspects established in the past between geometry, architecture, and construction.

The “a fascie” (that means banded) vaults, locally defined also “a fascioni”, are introduced, in treatises, by Guarino Guarini who, in the *Architettura civile* (published posthumously in 1737) for the first time makes a rigorous and meticulous examination of the vaulted systems, which is interwoven with aspects related to the invention, construction and calculation of surfaces and volumes also illustrated in the *Modo di misurare le fabbriche* (1674). In the Trattato III of the *Architettura civile*, Capo Vigesimosesto, “Delle Volte, e varj modi di farle”, he dedicates the Osservazione Nona and the Osservazione Decima to the “a fascie” vaults and the “a fascie piane” vaults, claiming their authorship.

Regarding the spatial configuration, Guarini describes their genesis through a division of the room with bands that can be traced from wall to wall with perpendicular or oblique direction to produce some compartments. Those compartments can be filled with different vaults, according to the shape of them. In the plate XX of the Trattato III, an “a fascie” and “a fascie piane” patterns are described in orthographic projection. (fig. 2).

The systematic approach of Guarini opens the field to the experimentations in architecture and subsequent writings, which constitute a significant theoretical corpus both concerning the refinement of the geometric description of the surfaces, and about the description of the construction techniques and implementation of the brick-masonry vaults. In Italy, they will become the object of specific manuals only towards the end of the nineteenth century.

The studies on the vaults by Giovanni Curioni can also be used as a link between the theoretical and practical contributions. They are also favored by scientific advances in the field of descriptive geometry and mathematics.

In the *Geometria pratica* (1868) he deals with the measurement of the surfaces of the vaults, minutely describing their geometric genesis and mathematical description.

As regards the definition of the “a fascioni” vaults he recalls Guarini’s approach, even if he described a particular type of banded vault that can be geometrically described starting from a

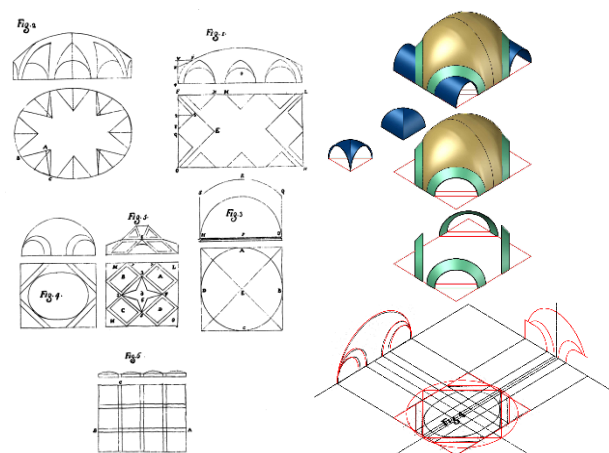

Figure 2. Banded vault in the *Architettura civile* by Guarini. Source: Guarini, 1737. Modeling: R. Spallone

main surface. He states that the main surface, depending on the shape of the room, can be a barrel vault, a cloister vault, a barrel vault with cloister heads, an “a schifo” vault (keel vault), a dome or a shell-like vault that he names “a conca”. As in Guarini’s description, working by cuts with vertical planes on this surface, it is possible to obtain interweaving arches that define some fields. From the spaces not covered by the arches, the corresponding parts of the primitive vault are removed to replace convenient vaults (fig. 3). A few years later, still in Turin’s culture, Giovanni Chevalley, in his *Elementi di tecnica dell’architettura: materiali da costruzione e grosse strutture* (1924) collects a sum of local constructive knowledge in the framework of vaulted structures construction and enriches it through numerous drawings in which he indicates the most usual brick equipment and the developments on the plane of the intrados surfaces.

In the description of the “a fascioni” vaults, he indicates some built examples and emphasizes their spatial qualities. In particular, he makes a distinction stating that is possible to recognize two different types of this kind of vault: a first one, is characterized by a main surface from which the bands protrude (as in the vault of Palazzo Madama monumental staircase), a second one recalls Curioni’s explanation, confirming its geometric genesis. From the infinite variety of combinations unimaginable and beautiful architectural effects can be produced.

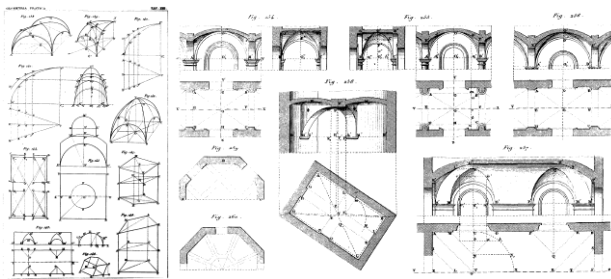

Figure 3. “A fascioni” vaults on a rectangular plan, geometric scheme (left) and architectural representation in orthographic projections (right). Sources: Curioni, 1868, Plate XIII; Curioni, 1865, Plate XXV

3. BANDED VAULTS IN TURIN BAROQUE ATRIA: GEOMETRICAL INTERPRETATION

As seen above, Guarini first, in the *Architettura civile*, defines this kind of vault as “a fascie” vault and states that they are featured by a series of arches orthogonal or oblique to the perimeter walls on which they rest. They divide the room’s ceiling into spaces that can accommodate small vaults of different shapes suitable for painted decorations. Guarini also affirms that they are an invention of his own, which he put in place not without much variety, and satisfaction of the people (Guarini, 1737). Not only Guarini designed and implemented such types of vaults, for example in Palazzo Carignano (1679) (Spallone, Vitali, Natta, 2019): they were widely used by Filippo Juvarra, who seemed to prefer them, in the second decade of the 1700s, and by other important figures in the Baroque panorama such as Amedeo di Castellamonte and Gian Giacomo Plantery, who were contemporaries of the same Guarini and Juvarra, respectively. In particular, we owe to Amedeo di Castellamonte one of the first examples (Piccoli, 2001) of banded vault made in Piedmont: the vault of the Sala di Diana in the Reggia di Venaria (1661-1662).

The eleven baroque atria, covered by masonry “a fascie” vaults, are located both in new palaces, built in 17th and 18th centuries during the three enlargements of the city, and in reshaping buildings in the ancient Roman tissue (Table 1). In the cases identified, the arches dividing the space to be covered with a vault generate in most cases a 3x3 grid, in a small number of cases 3x4 or 3x5 grids. The latter variants are due to both larger plan dimensions and a marked difference in size between the two sides of the plan. Another significant difference between the banded vaults analyzed, is the geometric characterization of the arches, compared to the overall geometric shape of the vaulted system. Indeed, while Guarini tells of arches that generate fields to be covered with independent vaults and Amedeo di Castellamonte in Venaria Reale applies the same criterion, in most of the surveyed cases the arches are part of the same surface that characterizes some of the vaulted fields (fig. 4).

Guarini’s styles arches have a cylindrical shape with circular, or elliptic, or oval directrix, the others take curved and continuously variable longitudinal and cross-sections.

In the first case, the geometrical analysis starts with the plan’s partition arches, followed by the completion with independent vaults. In the second case, the shape of the main vault, often recognized as an “a conca” vault, is first reconstructed.

The “a conca” vaults, as realized in Piedmont, are double curvature vaults with three directrices, the lateral ones straight and the central curved.

These shell-like vaults are cut with pairs of parallel planes, to generate the arches, while some portions of them are kept and the void fields, often at the corners, are completed by independent vaults.



Figure 4. Banded vault with independent arches in Palazzo Barolo (top) and with arches belonging to the main surface in the palace in via Garibaldi 53 (bottom). Photos: M. Vitali

As mentioned above, two graphic products of different nature characterize the interpretative representations of the survey data obtained through TLS.

The first elaboration consists of the plans and sections on a scale of 1:50 of the entire interior space, which is the result of the operations of a metric survey and interpretative analysis of architectural consistencies. It is obtained by means of thin pair of sections (distanced from 2 to 5 mm) of the point cloud, arranged according to the conventions of the technical-architectural drawing (height from the floor of 1.50 m, for the plans, intersection of the keystones, for the vertical sections).

The second elaboration is a three-dimensional digital model, which can be linked to the shape ideation phase of the vaulted system, inspired by the references to coeval architectural literature and archival sources.

The reconstructive digital modeling (De Luca, Buglio, 2014) of the design idea relating to the vaults makes it necessary to restore the symmetries in plan and bring the vertical sections back to elementary geometries (circle, ellipse, oval) also hypothesizing the constructive process by means of centerings. This phase of the work also provides for the decomposition of the interpretative model according to a hierarchy that simulates the sequence of the ideative process.

The method of decomposition differs according to whether the banded vault is characterized by arches with independent vaults, or by arches whose surface belongs to the main vault.

In the first case, the method is based on Guarini’s indications, about the “way of drawing the vaults”, which outlines a sequence, from the compartmentalization of the plans by means of bands, to the filling of the void fields with autonomous vaults.

In the second case, the arches can be thought as the result of cutting with pairs of parallel planes a shell-like vault, whose

surface is preserved, generally at least in the central field of the vault, while the void fields, often at the corners, are completed by independent vaults. In this case, it could be hypothesized that the bands are the reinforcement arches of the shell-like vault or, on the contrary, that they are only simulated by stucco for breaking the continuous surface of the vault. (fig. 5).

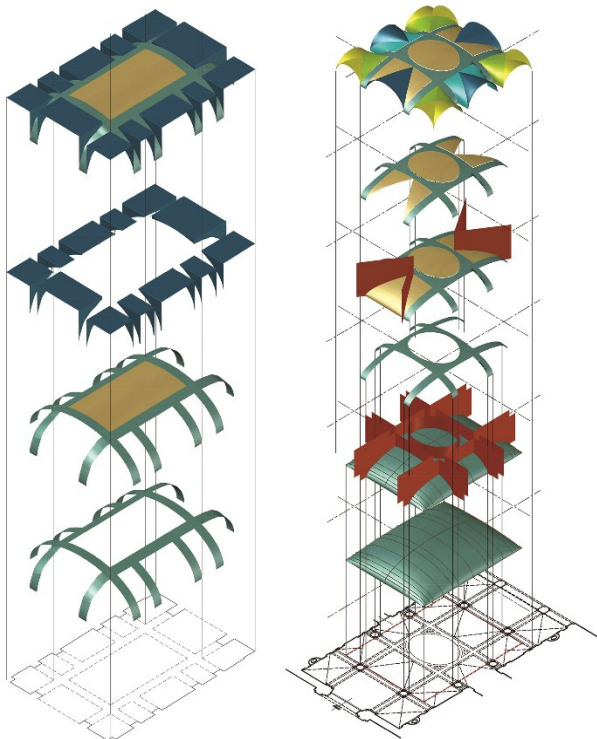

Figure 5. Decomposition method for banded vaults with independent arches (left) and with arches belonging to the main surface (right). Modelling: R. Spallone, M. Vitali

4. SURVEY METHODOLOGY AND TECHNICAL ASPECTS

The research carried out has had as main purpose the geometric and metrological analysis of the vaults of the atrium of the noble palace located in Via dei Mercanti 2 of Turin as a typological example of the vaults named “a fascie”. It is a composed vault which diaphragmatic arches divide the space into a 3x3 grid creating 9 vaults. The use of axial symmetry results in a delicate configuration of lines and surfaces with an apparent simplification of the design. However, this brilliant solution has all the complexity that the “a fascie” vaults have. This type of vaults, due to its morphology, implies a decomposition of spaces delimited by arcs of different curvatures on which they support curvilinear surfaces where the radius of curvature varies from one to another. This absence of edges and planes turns the study into a complex case of projective and geometric analysis that must be addressed through previously established methods and protocols. (fig. 6). These difficult characteristics of the space’s envelopes, requires the use of terrestrial laser scanner (TLS).

The data obtained with this new technology generates easy-to-use models for later comparison with the geometric prototypes established in the literature (Verdiani, 2019).

The TLS is a tool used for the collection of metric and geometric data that has been used since 2001. It is especially recommended for the reconstructive digital modeling of curvilinear surfaces since the cloud character is not only due to the large number of points obtained but also because these points form a nebula

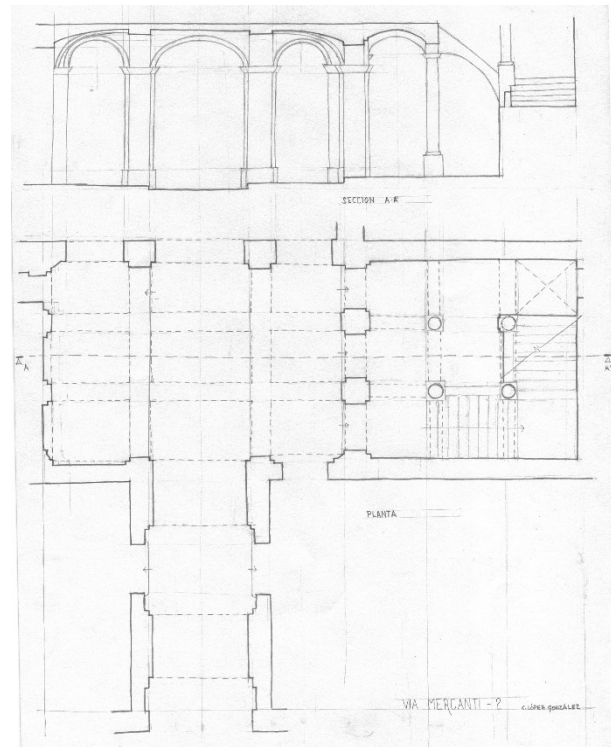

Figure 6. Previous preparation drawing. Section and plan of the atrium. Drawing: M. C. López González

that envelops the observed object (Ramos, Marchamalo, Rejas y Martínez, 2015).

The particular characteristics of the atrium of the noble palace of Via dei Mercanti 2 required a previous analysis to select the ideal device that would provide the best results.

The interior of the atrium has a poor illumination and excessively contrasted with the exterior lighting; the small dimension of the access door prevents the necessary overlapping of point clouds so that the final union is successful; the compartmentalization of the space by glazed screens with wooden carpentry difficults the positioning of the device and its later points clean up.

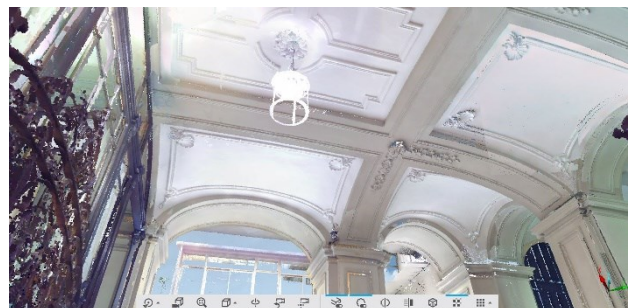

Figure 7. Image extracted from the point cloud. The resulting point clouds acquire a photographic realism. Scanning: M. C. López González. Processing: F. Natta

The Focus-130x3D scanner by Faro brand has been used. Its low weight (5.2 kg.) and small size (24 X 20 x 10 cm) facilitate its transportation and handling. The integrated long-lasting battery (4 hours) ensures its use with no need to connect it to electricity during the entire/whole scanning session. It has a systematic error scope of ± 2 mm of distance in 25 meters which was acceptable for the purpose of this study. It includes an integrated camera with 70 megapixel non-parallel color overlay so the resulting point clouds acquire a photographic realism very useful to understand it. Finally, and of great importance in this case, it has

an FLS output format that allows to read it in all processing programs (fig. 7).

From the beginning, the use of referential spheres was taken in mind due to the fear that the glazing of the reception and the profusion of bas-relief decoration would make automatic detection of references impossible, finally creating an erroneous set (fig. 8).



Figure 8. Location of spheres and scan points. Image extracted from the point cloud. Scanning: M. C. López González. Processing: F. Natta

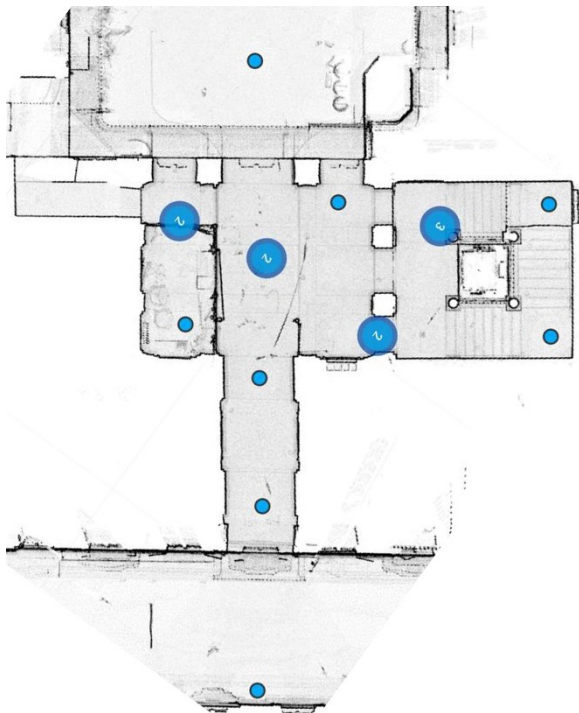

Figure 9. Location of scan points. Scanning: M. C. López González. Processing: F. Natta

Given the characteristics of the vaulted system, where the diaphragmatic arches produce shaded areas that prevent the total vision of all the vaults, the sequential scanner positions were previously rethought: the first station was located outside the atrium to, after the union of clouds, know the thickness of the facade wall. The following scans were sited successively by placing the device at the center of each of the grids that make up the vault thus ensuring the absence of blind spots and sufficient overlap.

The location of the reference spheres was subject to careful programming so that from two consecutive scans at least three spheres were displayed. The scans have been performed at a

speed of 488,000 points/sec. implied duration of each scan of approximately 8 minutes obtaining a good resolution of scanned. A total of 17 scans were performed to cover the area occupied by the atrium and the staircase in its first sections (fig. 9). To process the scans, the Scene 19 program was used. The cloud registration was done automatically, operating without errors. Three groups were registered (entrance, atrium, and staircase) and, in order to obtain a single file, the records were verified and a merge and clean up process was carried out. The cloud of points was imported to AutoCAD through .e57 files from which it is possible to execute the two-dimensional and three-dimensional modeling of the vaults (fig. 10).

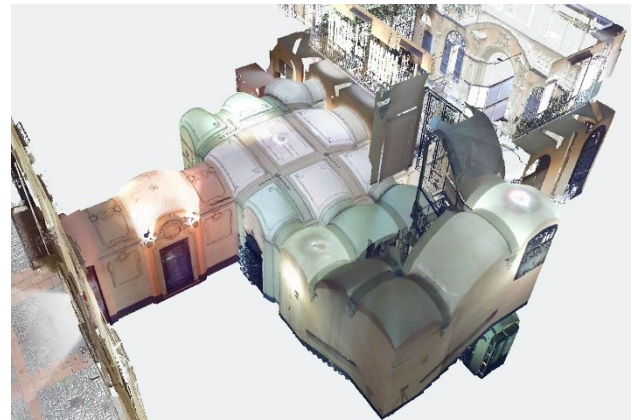

Figure 10. The result of the union of all clouds of point. Scanning: M. C. López González. Processing: F. Natta

5. COMPARISON BETWEEN DESIGN GEOMETRIC MODEL AND SURVEY DATA: THE CASE STUDY

The atrium of the palace in Via Mercanti 2 presents an articulated but easily interpretable distribution of spaces.

The entrance door leads to a vestibule which is 5.9 m deep and 2.38 m wide and covered by barrel vaults interspersed with a central sail vault: the whole space is richly decorated with stucco works.

The vestibule brings to the main space of the atrium object of study, which is organized on two levels preceded by a step and develops on a rectangular plan of 7.05 x 5.28 m with the long side orthogonal to the access axis. The banded vault is very low: it is set from a height of 3.12 m and reaches a key height of 3.87 m, with a slightly lower height even in the perimeter vaults. The atrium communicates longitudinally with the courtyard and transversally with the vertical connections, which are also covered with a system of bands alternating with sail vaults (fig. 11).

The plan of the atrium is developed with a 3x3 grid with the central bays equal to the width of the entrance. The most evident physical obstruction, which does not allow a complete view of the vaulted surface, is due to the presence of a reception room located in the south corner.

The step immediately following the acquisition of the point cloud and its elaboration, described in the previous paragraph, was the identification of the characteristic sections of the banded vault from which to extract the geometric information useful for the construction of a theoretical model comparable to the original design idea. This procedure is replicable also in other similar case studies.

Eighteen sections were therefore extracted from the point cloud (again maintaining a thickness varying from 2 to 5 mm), eight for the bands and ten for the axial and angular vaults (fig. 12).

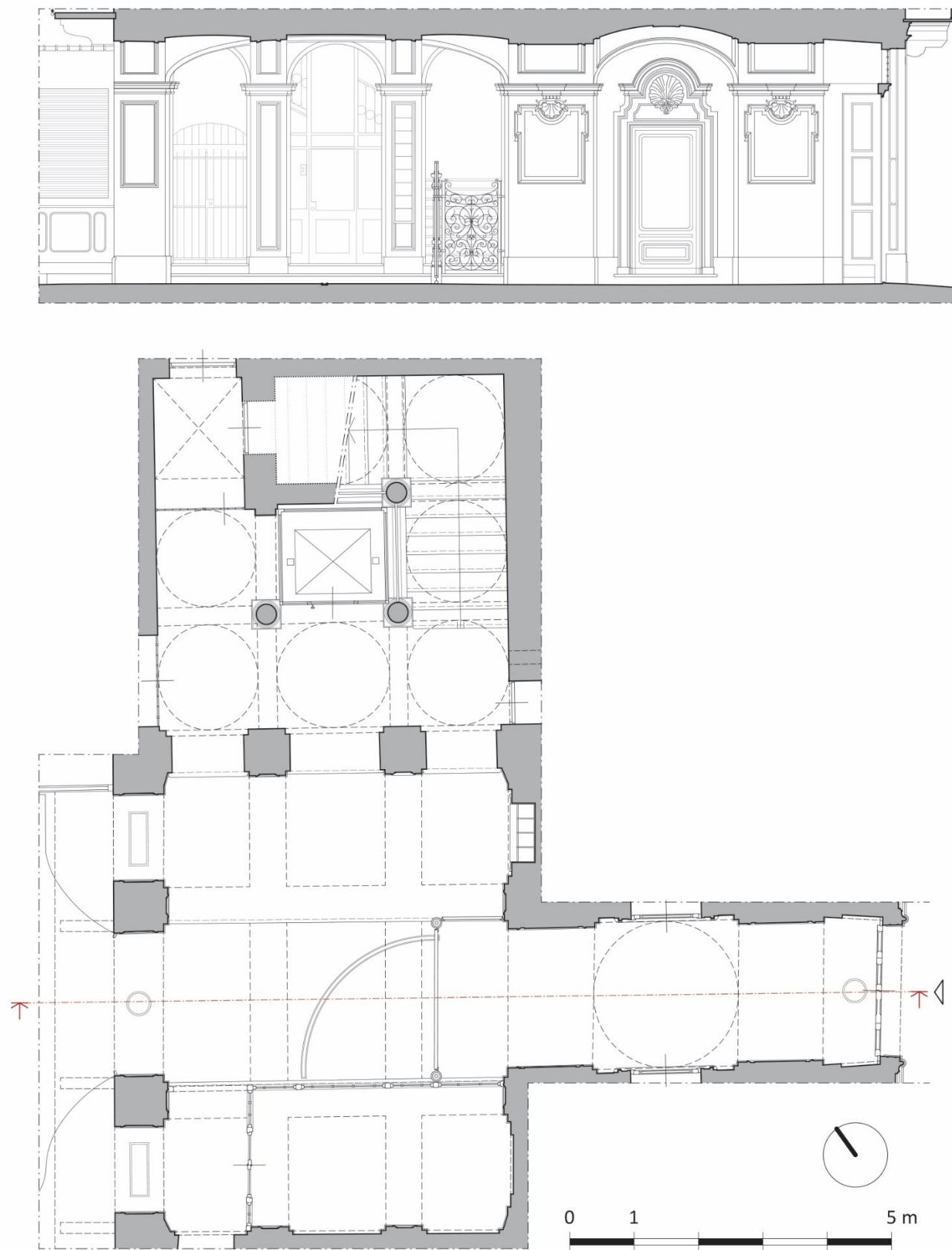

Figure 11. Survey drawings of the atrium in Via dei Mercanti 2. Drawing: F. Natta

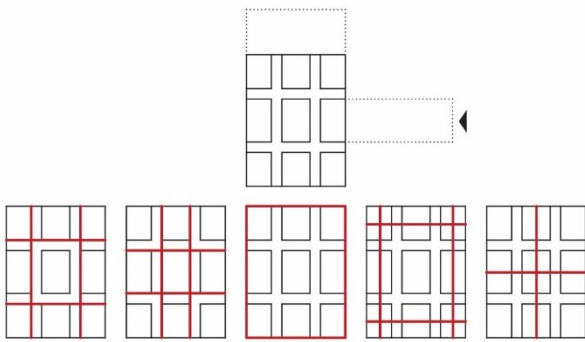

Figure 12. Position of the section planes. Drawing: F. Natta

These sections are positioned along the perimeter walls, along the main axes of symmetry, in the tangency of the bands and in the middle of each vault.

The position of the sections with respect to the characteristics of the vaulted system led to their cataloguing, aimed at recognizing those that, by virtue of the hypothetical symmetry of the ideal model, should have the same shape.

The directrices, aligned and overlapped with reference to the impost plan, have led to the recognition of axes, proportions, points of intersection, and above all curves.

Among these, element by element, the elliptical or polycentric curve (this last with the lowest possible number of centers) was digitally constructed with AutoCAD® 2020, consistently with the construction techniques of the centerings (fig. 13).

At the end of this phase of curve recognition we moved on to the reconstruction of the theoretical three-dimensional model (fig. 14).

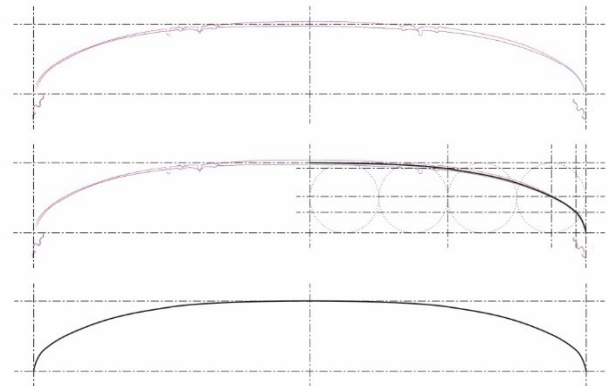

Figure 13. Tracing method for directrices and comparison with the section of point cloud (red). Drawing: F. Natta

The banded structure has therefore been identified starting from a main shell-like vault (I) sectioned with vertical planes (II) in order to regenerate the tripartition of each side (III). The bands considered have a width of about 57 cm, easily imaginable as consisting of two rows of bricks including mortar and plaster. By attributing a thickness of 6 cm to the bands (average value obtained from the point cloud) so as to identify the arcs on which the vaults are set, we move on to the axial vaults (IV), while the central portion is a part of the shell-like main vault.

The perimeter axial and angular vaults are constructed by means of a series of parallel sections, thicker in the impost areas of the vaults (V).

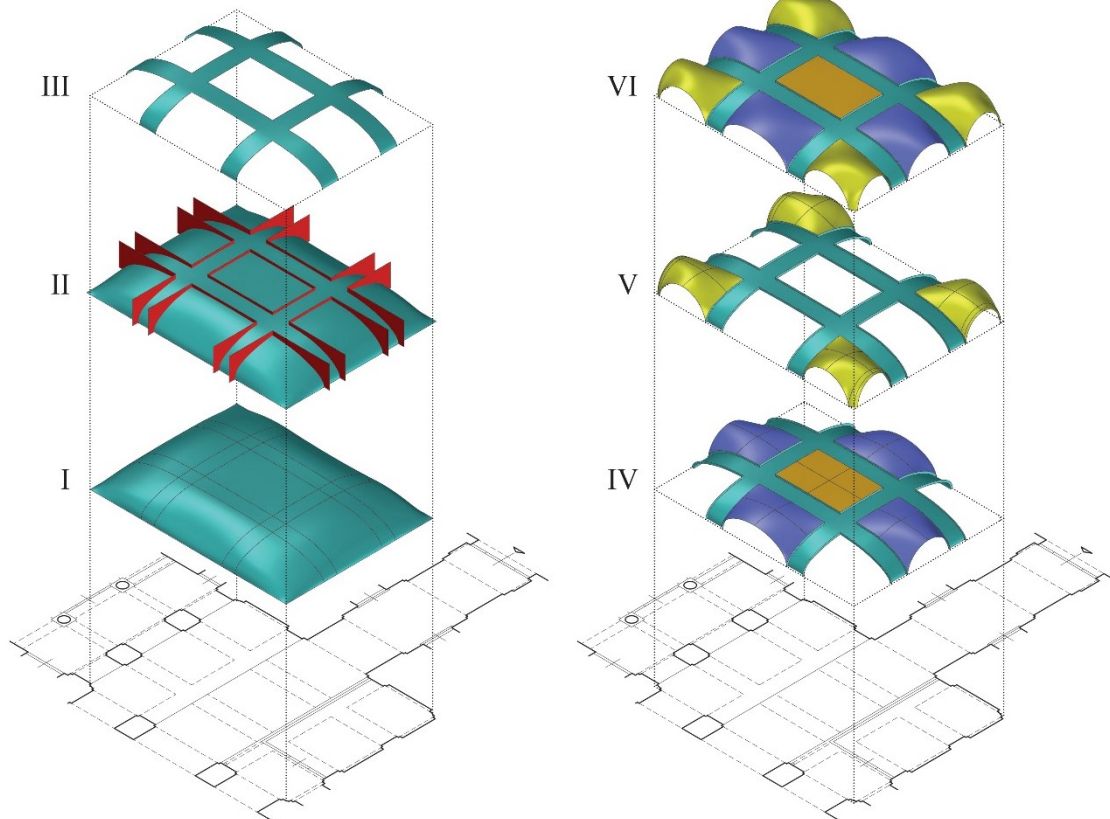

Figure 14. Decomposition of the 3D model of the vault design shape. Modelling: F. Natta

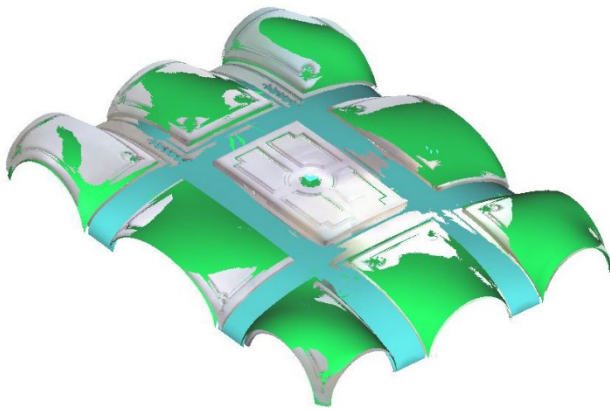

Figure 15. Superimposition of point cloud and ideal design model. Processing: F. Natta

At the end of this study, a comparison between the point cloud and the ideal digital model, geometrically constructed by Rhinoceros® 6, was made (fig. 15). The two digital products can never be perfectly overlapped: the point cloud brings with itself information about the consistencies in their current condition, the digital model, reconstructive of the design idea is generated through rigorously geometric references and restoration of the symmetries.

The graphical outputs realized through the open source program CloudCompare, show the standard distance between point cloud and ideal model is +0.015 m and the maximum distance of ± 0.045 m (fig. 16).

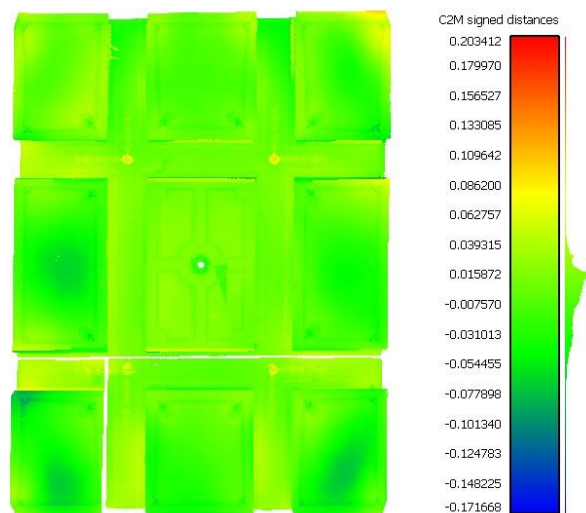

Figure 16. Distances between point cloud and ideal model. Processing: F. Natta

6. CONCLUSIONS

This paper outlines the methodological framework developed for the metric survey and the processing of knowledge data in the research on banded vaulted systems in Turin Baroque atria.

The integration between the technique of metric survey by laser scanning with digital drawing and modeling involves, as we have seen, the definition of new work-flows, aimed at optimizing the use of data.

Indeed, adhering to the objectives of the research, two-dimensional drawings must represent the atria in their current state, while three-dimensional modeling of the vaults is linked to the geometric reference models and aimed at the philological reconstruction of the design idea. These procedures have given

rise to new opportunities for research, such as the comparison (metric, but even more interesting, geometric) through the superimposition of ideal design models and point clouds. The deviations between the two digital products will not only reveal the deformations, structural failures, transformations that are part of the real-life of the building, but, above all, will provide new insights for the hypotheses on the necessary construction adaptations, and the centerings and laying techniques applied on building-site, i.e. they will contribute to the understanding of the relationship between design and construction.

This paper is the result of the research on banded vaulted systems carried out together by the authors. The authors wrote together paragraphs 1 and 6, M. C. López González wrote paragraph 5, R. Spallone paragraph 3, M. Vitali paragraph 2, F. Natta paragraph 5.

REFERENCES

- Chevalley, G., 1924. *Elementi di tecnica dell'architettura: materiali da costruzione e grosse strutture*, Pasta, Torino.
- Curioni, G., 1865. *Lavori generali di architettura civile, stradale ed idraulica e analisi dei loro prezzi*, Negro, Torino.
- Curioni, G., 1868. *Geometria pratica applicata all'arte del costruttore*, Negro, Torino.
- De Luca, L., Buglio, D.L., 2014. Geometry vs. Semantics: Open issues on 3D reconstruction of architectural elements. In *3D Research Challenges in Cultural Heritage*. Springer, Berlin/Heidelberg, 36–49.
- Guarini, G., 1737. *Architettura civile*. Mairesse, Torino.
- Jiménez Fernández-Palacios, B., Rizzi, A., Remondino, F., 2013. Etruscans in 3D-Surveying and 3D modeling for a better access and understanding of heritage. *Virtual Archaeol. Rev.*, 4 (8), 85–89.
- Piccoli, E., 2001. Le strutture voltate nell'architettura civile a Torino (1660-1720). In Dardanella, G. (ed.), *Sperimentare l'architettura: Guarini, Juvarra, Alfieri, Borra e Vittone*. Fondazione CRT, Torino, 38-96.
- Ramos, L., Marchamalo, M., Rejas, J.G., Martínez, R., 2015: Aplicación del láser escáner terrestre (TSL) a la modelización de las estructuras: precisión, exactitud y diseño de la adquisición de datos en casos reales. *Informes de la construcción* 67 (538): e074, doi: dx.doi.org/10.3989/ic.13.103
- Spallone, R., Vitali, M., 2017a. *Star-shaped and Planterian Vaults in the Baroque Atria of Turin*. Aracne, Ariccia.
- Spallone, R., Vitali, M., 2017b. Baroque Turin, Between Geometry and Architecture. *The Mathematical Intelligencer* 39 (2), 76-84. Doi: 10.1007/s00283-017-9725-y.
- Spallone, R., Vitali, M., Natta, F., 2019. *3D modelling between ideation, geometry, and surveyed architecture: the case of the vaulted system of 'Appartamento di Mezzanotte' in Palazzo Carignano*. Int. Arch. of the Photogrammetry, Remote Sensing and Spatial Information Sciences, XLII-2/W15, 1119-1126. doi.org/10.5194/isprs-archives-XLII-2-W15-1119-2019.
- Verdiani, G., 2019. Digital survey: from new technology to everyday use, a knowledge path and challenge for scholars. *EGE Revista de expresion gráfica en la edificación* 11. doi: https://doi.org/10.4995/ege.2019.12873