

Document downloaded from:

<http://hdl.handle.net/10251/193725>

This paper must be cited as:

García Martínez, A.; Monsalve-Serrano, J.; Lago Sari, R.; Tripathi, S. (2022). Pathways to achieve future CO₂ emission reduction targets for bus transit networks. *Energy*. 244:1-16. <https://doi.org/10.1016/j.energy.2022.123177>



The final publication is available at

<https://doi.org/10.1016/j.energy.2022.123177>

Copyright Elsevier

Additional Information

Pathways to achieve future CO₂ emission reduction targets for Bus Transit Networks

Antonio García*, Javier Monsalve-Serrano, Rafael Lago Sari, Shashwat Tripathi

CMT - Motores Térmicos, Universitat Politècnica de València, Camino de Vera s/n, 46022 Valencia, Spain

Energy

Volume 244, Part B, 1 April 2022, 123177

<https://doi.org/10.1016/j.energy.2022.123177>

Corresponding author (*):

Dr. Antonio García (angarma8@mot.upv.es)

Phone: +34 963876574

Fax: +34 963876574

Abstract

Apart from electric vehicles, emissions targets for 2025 and 2030 in the heavy-duty transportation sector could be achieved with hybrid powertrains. Moreover, alternatives such as the use of synthetic or e-fuels may also offer a feasible path for transport decarbonization. This work explores different pathways to reduce CO₂ emissions considering the city of Valencia as a case study. The 10 most used bus lines operating in the city are evaluated using their GPS based vehicle speed information with OD GT Suite simulations. First, the hybridization level for the share of buses was varied from 0-100% and the number of different bus types operating in each line was optimized for minimum CO₂. Next, the battery and E-motor sizing is optimized for each bus line. Further, an assessment was done assuming 100% electrified fleet, with the 2030 and 2050 electricity generation CO₂ footprint projections. Moreover, the potential of e-fuels in the current fleet is also evaluated. The results show that to meet the 2050 target, 100% electrified fleet (with 2050 electricity mix) as well as using e-fuels (generated from renewable sources) in the current fleet are feasible options. However, the e-fuel pathway is more economical than 100 % electric fleet.



Keywords



Transport decarbonization, Diesel engines, Hybrid vehicles, Electrification, E-fuels, Carbon dioxide Emissions.

1. Introduction

The increasing global warming has led to an enhanced monitoring of air pollution, especially the greenhouse gas emissions[1][2]. Due to which the transport sector has been under the radar of the policymakers for the high tailpipe emission reductions from the vehicles[3][4]. It is to be noted that there is about more than 25% contribution from the heavy-duty vehicles towards the total EU GHG emissions from the road transportation sector[5]. So, to regulate these emissions, different targets are set around the globe (Table 1) for emission reductions in the future years to reach the ultimate target of 2050 and to abide by the Paris agreement. As the targets are the strictest in Europe (as seen in Table 1), this study is done for meeting the EU's CO₂ emission reduction target for the Bus Transit Network fleet of Valencia in Spain. In this sense, several investigations were performed over the years aiming at increased efficiency and lower emissions in heavy duty vehicles[6][7]. This includes the development of advanced combustion concepts such as Dual mode dual fuel (DMDF) combustion, Reactivity controlled compression ignition (RCCI), Premixed charge compression ignition (PCCI)[8][9][10]. These combustion concepts have characteristic ultra-low engine-out soot and NO_x emissions as well as higher efficiencies than conventional diesel combustion[11][12]. However, the improvements by the combustion itself are not enough to achieve the future 2030 and the 2050 CO₂ emission targets.

Table 1: Summary of pledges and targets of different countries around the world[13].

Country	Paris Agreement	Copenhagen Accord	Kyoto Protocol	Long term goals
China 	Peak CO ₂ emissions latest by 2030 Non-fossil share: 20% in 2030 Forest stock: +4.5 billion m ³ by 2030 compared to 2005 Carbon intensity: -60% to -65% below 2005 levels by 2030	Carbon intensity: -40% to -45% below 2005 by 2020 Non-fossil share of energy supply: 15% by 2020 Forest cover: +40 million ha by 2020 compared to 2005 Forest stock: +1.3 billion m ³ by 2020 compared to 2005	-	Carbon neutrality before 2060
USA 	26-28% below 2005 by 2025 (10-17% below 1990 by 2025)	17% below 2005 by 2020 (0-5% below 1990 by 2020)	KP CP1 target: 7% below 1990	80% below 2005 levels by 2050 (68-76% below 1990 by 2050)
EU 	At least 40% below 1990 by 2030 (29% below 1990 by 2030)	20-30% below 1990 by 2020	KP CP1 target: 8% below 1990 KP CP2 target: 20% below 1990	91-94% emissions reduction below 1990

	<p>33 – 35% below 2005 emission intensity by GDP by 2030</p> <p>Non-fossil share of cumulative power generation capacity 40% by 2030</p>	20-25% below 2005 emissions intensity by GDP by 2020	-	Per capita emissions never to exceed those of the developed world
	<p>26% below 2013 by 2030 (15% below 1990 by 2030)</p> <p>(17% below 2010 by 2030)</p>	3.8% below 2005 by 2020	KP CP1 target: 6% below 1990	80% by 2050 (base year not specified)
	1.3 GtCO ₂ eq by 2025	36.1-38.9% below BAU by 2020	-	Strive for a transition towards energy systems based on renewable sources and decarbonization of the global economy by the end of the century

Hence, to meet the future emission targets the focus is directed towards the electrification of vehicles[14][15]. This electrification includes 100% electric vehicles (EVs) but also partially electric hybrids (HEVs). As a matter of fact, the EVs too gives out Well-to-Wheel (WTW) CO₂ emissions (Well-to-Tank electricity generation source), are more expensive than diesel and hybrids, have lower driving range, etc.[16][17]. But on the other hand, its reduced energy consumption, zero tailpipe (Tank-to-Wheel) emissions, and efficient energy conversion are great assets too[18][19][20]. Although hybrids are an intermediate option that have several advantages, between the conventional diesel one and an Electric one[21][22]. Some of the advantages of hybrid powertrains are not as high as compared to an electric vehicle, like, zero tailpipe (Tank-to-Wheel) emission[23][24]. Based on this ‘zero tailpipe emissions’ tagline, the electric vehicles are being pushed by the European Union’s ‘EU Green Deal’ as the solution to reach the EU 2050 target for emission reduction (Figure 1), which aims to reduce the emissions level by up to 95% (ambitious target) or by 80% (moderate target) with respect to the 1990 emission scenario[25]. However, the real emission output of a powertrain is heavily dependent on the driving conditions as the engine or the electric motor is always working in transient conditions, which leads to varied emission values[26][27]. In addition, the carbon intensity from the electricity mix should be also considered in

the calculations for electric vehicles. So, it is very important to evaluate each powertrain technology (hybrid or electric) with a life cycle perspective focussing on the specific driving conditions to have the correct assessment of its emissions and performance to check if it is the suitable solution or not[22][28].

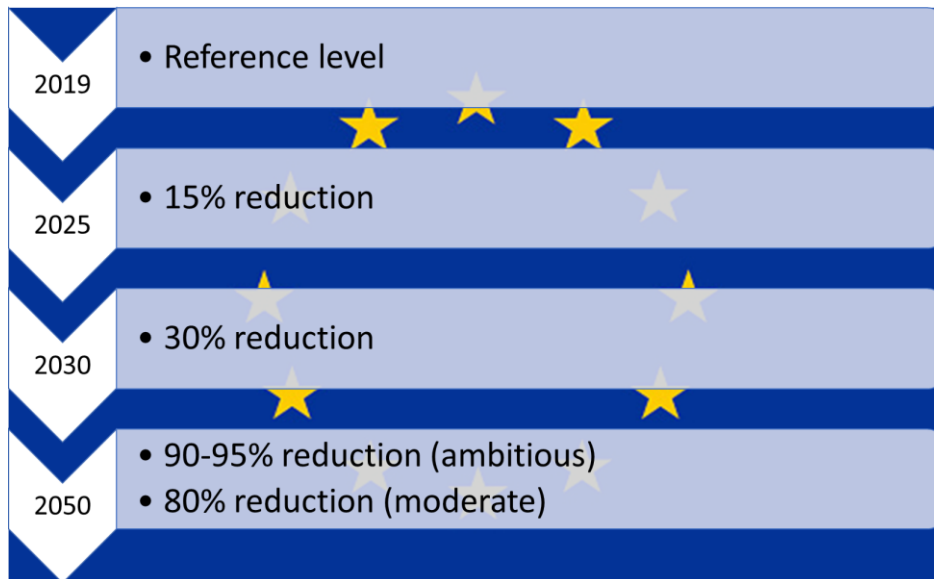

Figure 1: Timeline of EU emission reduction targets for the Heavy-Duty Transportation sector.

Further, to meet the 2050 target another potential solution can be the use of different renewable and synthetic fuels[29] [30]. As the global warming is a global issue, its solution too should involve global participation. This implies that for the synthetic e-fuel's production or even for the generation of renewable based electricity, the geographical locations best suited for the electricity yield from the renewable scenarios must be used. Considering this, the efficiency yield of e-fuel powered vehicles will be very similar to that obtained by using the electricity generation for charging the batteries of the EVs globally[31]. Therefore, a holistic evaluation must be done to compare the life cycle emission reductions using new electric vehicle fleet and with e-fuelled powered fleet of the conventional Internal Combustion Engine (ICE) vehicles. Due to the immense discussion of high-cost differences between the e-fuels and the conventional fuel, a cost evaluation must be performed to evaluate the economic efficiencies of the two pathways for the 2050 future, i.e., by powering the ICE buses with E-fuels and by changing the fleet to fully electric[32].

Hence, in this paper, different pathways for achieving the future emission targets of 2025, 2030 as well as 2050 (Figure 2) are evaluated considering Valencia's bus transit network as a case study. Firstly, an evaluation of the 2019 bus fleet in Valencia is done to have the reference values for evaluating the future reduction percentages. The 2019 emission value is used as the reference scenario for the evaluation, as the 2025 and the 2030 emission targets are to reduce the emission values by 15% and 30% compared to the emission values in 2019[33]. Optimisation of the bus fleet was done for the optimal number of buses operating in each of the bus lines for minimum CO₂ emissions. Further, a parametric study was done for the Hybrid and Articulated Hybrid buses to find the best sizing of battery and the electric motor capacity in each

of the bus lines to have the lowest possible life cycle CO₂ emissions. Finally, an evaluation is done to reach the 2050 CO₂ reduction target by considering electric bus fleet as well as with e-fuelled bus fleet.

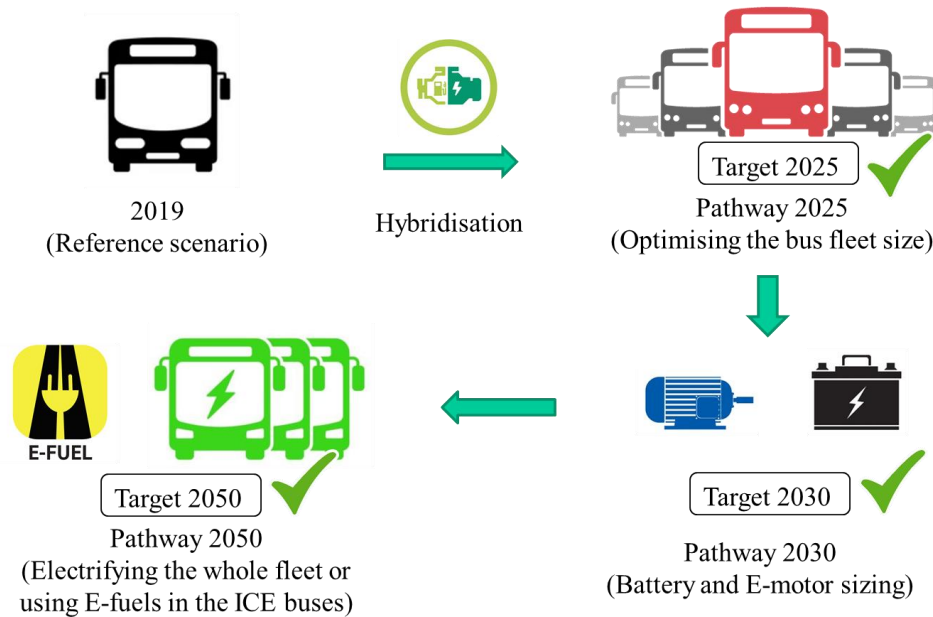

Figure 2: Pathways to meet the future targets for emission reduction (2025, 2030 and 2050).

Thus, this is a novel study significant for the future, as these emission reduction targets will be soon implemented in the EU[33] and hopefully worldwide too in the heavy-duty transport sector, to control the global warming. For a precise and accurate study, the use of GPS based drive cycles is done for the evaluation of life cycle emissions of the bus rapid transit network which is a real-like representation for each of the respective bus lines evaluated. This is an enhanced way of evaluating the performance of bus powertrains operating in a city, as it accounts the traffic congestion, considering the fixed route covered by each bus line in the city. Hence, we can say that this paper is a first-of-its-kind for evaluating bus transit networks to reach future emission reduction targets, considering the CO₂ emission reduction potential of hybridisation, electrification and of the use of e-fuels in the conventional ICE buses. Done by means of OD evaluations for a wide range of bus types: diesel, hybrid, electric, articulated diesel, articulated hybrid as well as articulated e-fuelled and articulated e-fuelled hybrid; for the 10 evaluated bus lines, using real-like drive cycles and with a methodology that can be used for any other city's bus transit network, worldwide. The idea behind considering such wide range of bus types was to cover all the possible types of buses being operated in the current era in any city worldwide. If an evaluation needs to be done for any other region, all that needs to be changed is the bus fleet specific to that region and obviously the electricity mix used to charge the electric buses. By addressing these two parameters, with the methodology discussed here, one can do the evaluation specific to different regions globally.

2. Methodology

The methodology section is divided into the following parts: (1) Selection of the bus routes and drive cycle designing, (2) Bus modelling and fleet evaluation, (3) Life cycle emissions analysis, (4) Optimisation of the fleet with a multi-constrained objective function to meet 2025 emission target, (5) Parametric study for the evaluation of optimum battery and e-motor sizing to meet 2030 targets (6) Evaluation of full electrification and e-fuels pathway to meet the 2050 targets.

2.1. Selection of the bus routes and drive cycle designing

To have an overall estimation in Valencia, 10 of the most used lines, out of the total 53 lines operating in the city were selected (passenger breakdown for 2019 presented in Figure 18). Further, as these bus lines are the most used ones it is more relevant to evaluate these for their emissions, as their operation in the city is most relevant to the citizens[34]. The types of buses operating in each of these lines are tabulated in Table 2.

Table 2: Selected Bus lines with the type of buses operated in each[34][35].

S. No.	Lines	Diesel	Hybrid	Diesel Articulated	Hybrid Articulated
1	9	x	x		
2	10	x	x		
3	19	x		x	x
4	70	x			
5	89	x		x	
6	90	x		x	
7	92			x	x
8	93	x	x		
9	95	x			
10	99	x		x	x

The stop schedules for all these lines were extracted to have the exact route in the drive cycles for the simulations[36]. Further, to design these drive cycles, the GT RealDrive feature (ProfileGPSRoute), of the GT-Suite commercial software (v2021, Gamma Technologies) was used for each of the bus lines[37]. The GPS based data for vehicle speed is extracted by providing the start and end point for each specific route, with the respective bus stops of each line. By using the schedule of the different bus lines; the start point, end point and intermediate bus stop details are found and entered as input. Taking n as the number of bus stops in each line, the respective drive cycles (n-1) were designed. As, a line with 3 stops (A, B, C) will have 2 GT RealDrive cycles, A to B and B to C. Similarly, the representative drive cycle for each of the bus lines are designed. These drive cycles are then used to run the OD GT model of the diesel bus to obtain the overall velocity-time profile of each bus line as shown in Figure 3.



(a)

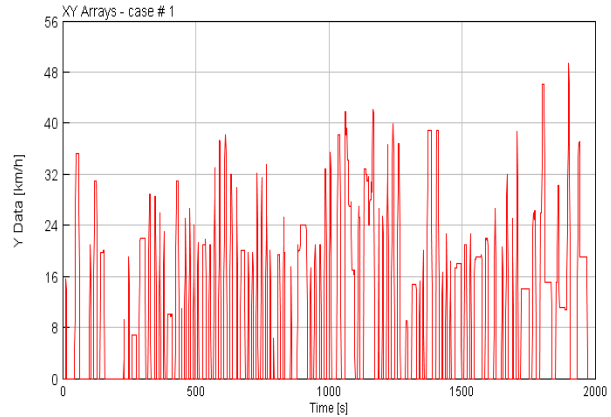

(b)

Figure 3: GT-RealDrive; (a) Scheduled route of line 90 in Valencia[36] (b) Velocity-Time Profile for the respective bus route for GT simulations.

2.2. Bus fleet evaluation and Modelling

As per the 2019 data, the total fleet of buses operating in Valencia was 491[38]. Recently, the bus fleet has been updated by 164 new hybrid buses. The hybridised fleet of 2021 is tabulated below in Table 3, simply by adding 164 hybrid buses in the hybrid fleet and removing 164 diesel buses (as procurement of 164 hybrid buses was done). The evaluation in this paper is done considering the same number of buses for the future years. The exact number of buses used in operation and the distribution of buses in the 4 bus categories (as mentioned in the section 2.1) is presented below in Table 3:





Table 3: Number of different types of buses used in the fleet.

Bus type	Fleet 2019 [39]	Fleet 2021 (50% hybridised) [40]	Normalised fleet 2019
Diesel	369	205	75
Hybrid	54	218	11
Diesel Articulated	31	31	7
Hybrid Articulated	36	36	7
Total	491	491	100

Five different bus models were modelled on GT Drive for a 0D evaluation: (1) MAN Lion's City Diesel (DB), (2) Volvo 7900 Hybrid (HB), (3) BYD 12m eBus (EB), (4) MAN Lion City's G Articulated Diesel (AD) and (5) Volvo 7900 Articulated Hybrid (AH). Each model corresponds to a specific powertrain architecture. The main features are tabulated below in Table 4.

Table 4: Specifications for the different Bus types.

Parameter	Diesel (DB)	Hybrid (HB)	Electric (EB)	Articulated Diesel (AD)	Articulated Hybrid (AH)

Bus					
Model Name	MAN Lion's City [41]	Volvo 7900 Hybrid [42]	BYD 12m eBus [43]	MAN Lion's City 18 G [44]	Volvo 7900 Articulated Hybrid [45]
Engine Type	D1556 LOH, Euro6	Volvo D5K 240, Euro6	Jing Jin E-Motor	D2066 LUH Euro6	Volvo D5K 240, Euro6
Number of Passengers [46]	110	120	100	136	150
Gross Weight (kg)	19000	19500	19500	28000	29000
Rated Power - Engine/Motor (kW)	265/0	180/150	0/150x2	265	180/150
Maximum Torque – Engine/Motor (Nm)	1600/0	918/1200	0/550x2	1250/0	918/1200
Battery Capacity (kWh)	-	8.9	348	-	8.9
Length (mm)	12185	12000	12200	17980	18134
Width (mm)	2550	2550	2550	2500	2550
Height (mm)	3060	3280	3370	2880	3280

A 0-D longitudinal vehicle model was built in GT-Drive for each powertrain. Figure 4 depicts the GT-Drive model for an articulated hybrid bus, where the objects used to model battery, internal combustion engine, transmission, etc., can be observed. The model combines the use of maps to describe the behaviour of fuel consumption and emissions during the driving cycle. Additionally, resistance-capacitance branches are used for the battery modelling whereas the electric motor is modelled by power-speed maps. For each time-step the torque demand from the driving cycle is calculated as well as the speed of the wheels. Both values are used to determine the operating condition of the electric motor and ICE, resulting in the energy consumption and emission production. This approach has shown accurate results in different investigations[47][48]. More details about the GT based OD modelling can be found here[49]. Further, by means of similar modelling approach a life cycle emission assessment has already been done and validated for diesel, hybrid and electric buses and has been recently published[50]. A slight difference can be found in the g/km.passenger value as in this paper we have taken the passenger capacity for each bus type as claimed by the transport company of Valencia on their website. But in the previous paper we used the passenger capacity claimed by the OEMs, which were found lesser compared to ones reported on the website of Valencia's public transport company.

different powertrain technologies. Further, its database is the source for other commercial softwares as well such as Gabi, Open LCA, etc. The datasets used in this study are presented in the Table 7, considering the parts in each powertrain type and its corresponding emission footprint. The dataset is used further to calculate the overall CO₂ footprint for each of the below mentioned phases, as mentioned below:

(i) Production

Using the weight breakdown (Table 8) the CO₂ footprint for the production phase can be calculated for all the five busses by:

$$CO_2 Production = \sum(\text{Footprint of part} * \text{Weight of the part})$$

(ii) Use

To calculate the footprint of the vehicles during their operation the following formulas are used.

$$CO_2 WTT Fuel = \text{Footprint of the Fuel Production} * \text{Fuel Consumption}$$

$$CO_2 WTT Electric = \frac{\text{Electricity consumption} * \text{Footprint of Electricity production}}{\text{Charger Efficiency}}$$

$$CO_2 TTW = \text{Footprint of Diesel Combustion} * \text{Fuel Consumption}$$

$$CO_2 WTW = CO_2 WTT + CO_2 TTW$$

(iii) Maintenance

Maintenance is also required during the life cycle of the buses. Which is calculated by:

$$CO_2 Maintenance = \sum(\text{Overall Footprint of the Part} * \text{No. of times Maintained})$$

$$\text{No. of times Maintained} = \frac{\text{Life Cycle Kilometeres}}{\text{Life span kilometeres of the Part}}$$

(iv) Assembly, Disposal and Recycling (ADR)

This phase includes the assembly of all the parts during the production phase, disposal and at the end of life and recycling of the recyclable materials after disposal. The CO₂ footprint is calculated as:

$$CO_2 ADR = (\text{Footprint of the Process} * \text{Total weight of the Vehicle})$$

The Life cycle assessment methodology can be found more in detail in our previous published article, dedicated to only life cycle emission calculation from a diesel, hybrid and an electric bus on different bus routes across Spain[50] .

2.4. Optimisation of the fleet with a multi-constrained objective function to meet 2025 emission target

Based on the total fleet of buses in 2019 (as shown in Table 3) an initial estimation of CO₂ emissions is done by an initial approximation of having 10 buses in each line. This is done by normalising the total bus fleet for the 10 evaluated lines in this study. As calculated below.

$$\text{No. of buses in the 53 lines} = 491$$

$$\text{No. of buses in 1 line} = \left(\frac{491}{53}\right) = 9.26 \sim 10 \text{ buses}$$

The total emission from the fleet is calculated by simply using the average emissions (Figure 19) from the 10 lines for each of the bus type and multiplying the total number of buses of each bus type for the normalised Valencia bus fleet (as shown in Table 3). This evaluation is then extended for increasing level of hybridisation from 0 to 100%. Through this the potential of reducing CO₂ emissions of the fleet by varying the level of hybridisation is assessed. Further, for a much accurate investigation, the optimised distribution of the fleet is done for each bus lines of the different bus types. This is done by using the objective function mentioned below, the distribution of the buses was calculated for the operation of each of the bus line with the different bus types to have the minimum overall emission values from each of the 10 lines.

$$f(x, y) = \min(\sum \text{Number of buses in the route}(x) * \text{Emission values in the route}(y))$$

Based on the distribution of buses obtained after the optimisation, the lowest emission values are evaluated, to meet the 2025 emission reduction target. The optimisation methodology can be understood better in Figure 5 below.

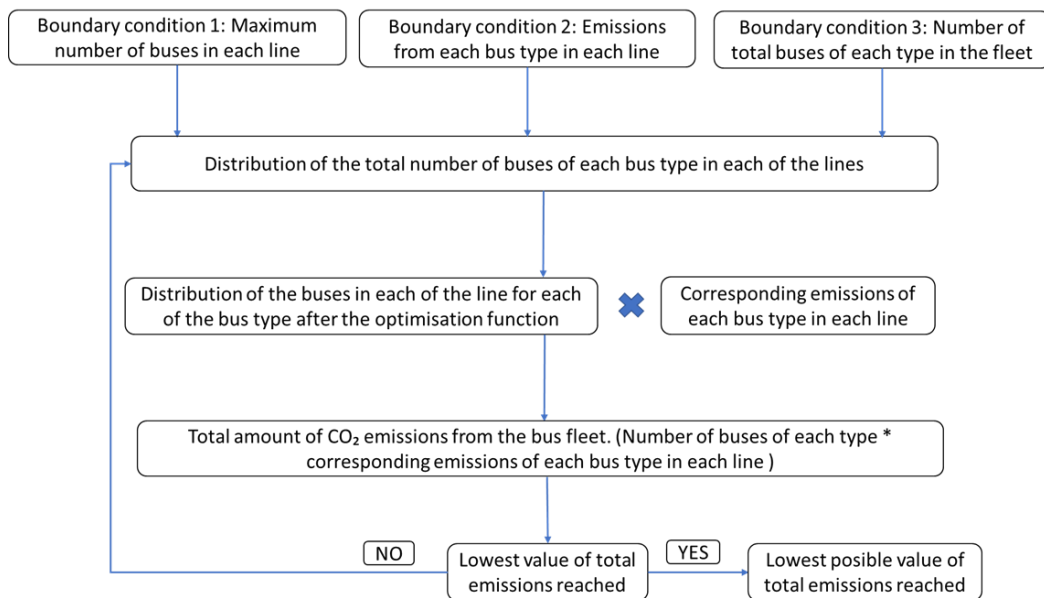

Figure 5: Optimisation methodology followed to find the best distribution of buses for lowest life cycle emissions.

2.5. Parametric study for the evaluation of optimum battery and e-motor sizing

For optimizing the battery and E-motor capacity that should be used for lowest LCA emissions in each of the line, a specific design framework was proposed. This was done by performing a design of experiments (DoE) in GT Drive by varying the E-motor capacity from 600 to 1800 Nm and the battery capacity from 7.5 kWh to 37 kWh for the hybrid and articulated hybrid buses. From this study, the values best suited for the battery pack and the electric motor capacity for each of the bus line were obtained. The optimization of the components was carried out with the objective to minimize the CO₂ tailpipe emissions. Once the best combination of battery and e-motor size were known for each bus type in each bus line, the new emission values were used for the distribution of optimal number of buses using the optimisation function discussed in the previous sub-section. Hence, the best possible reduction of CO₂ emissions of the total fleet was calculated for the different technology and scenarios and are discussed in the Results section later.

2.6. Evaluation for complete electrification and e-fuels pathway

For meeting the 2050 emission reduction target two different pathways, with fully electrified bus fleet as well as with e-fuelled ICE buses, are analysed. This is done by considering renewable source of electricity production for; (i) charging the batteries of the fully electrified vehicles and (ii) the generation of e-fuels, which are fuelled in the ICE buses (diesel as well as hybrids). Both these pathways are analysed individually for its: energy efficiency, emission reduction as well as cost efficiency. First, the energy efficiency yield of both the pathways is analysed considering different global scenarios of; (i) Photovoltaic (PV) energy source, (ii) Wind energy source as well as (iii) 50-50% mix of PV and WE. By referring to different studies in the literature it could be observed that there is not much big difference in the final efficiency yield from both the pathways (if the source of electricity is a renewable one)[52][53]. The scenarios are evaluated for EV battery recharging by the renewable electricity production in Germany and for e-fuels production using the renewable generation in the Middle east and North America (MENA) region. This could be considered valid as the global warming is a global issue so the best abilities of the countries must be used to have the best possible global solution.

This could be seen in the Figure 6 below, where all the losses considered during the entire chain of processes involved till the final vehicle efficiency is evaluated (in pink). It could be observed that the above scenarios have a similar value of final energy efficiency yield from the vehicle (numbers presented in the graph), ranging from 10-16% only. Thus, it can be said that both EV charging as well as renewably produced e-fuel will give similar results in terms of energy efficiency. So, as a solution to meet the 2050 emission target, both these pathways are evaluated in this paper. A cost evaluation is also done and discussed in the next section to have a view on the cost aspect of using e-fuels, while comparing it with the cost investment required for establishing the new electrified fleet considering the Capital investments as well as the Operating expenses.

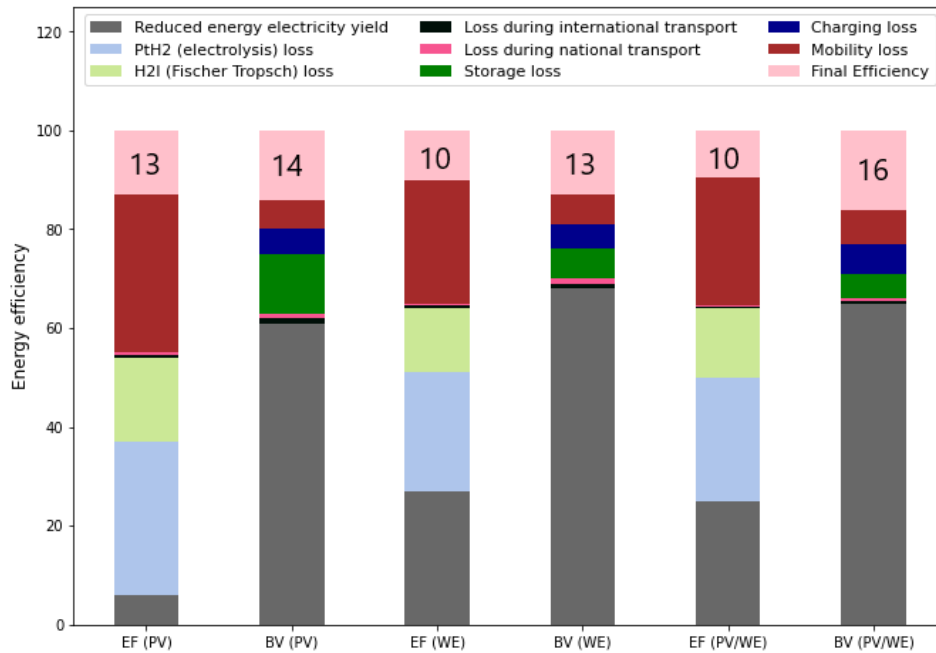

Figure 6: Energy efficiency losses and the final efficiency yield with different energy generation scenarios for BEVs and e-fuelled ICEs. (Adapted from [31])

Acronyms used in the figure above; EF: E-fuel production & BV: Battery vehicle charging.

3. Results

This section presents the results obtained from the different scenarios (2025, 2030 and 2050) considering the pathways to reduce carbon dioxide footprint.

3.1. Pathway 2025

In the pursuit of meeting the future emission targets, the emission from the bus fleet is evaluated and optimised by the help of the objective function. Firstly, the fleet emission calculation is done without using the objective function. This is done by using the average emissions for each of the bus type from the 10 lines and multiplying it by the overall distribution of buses of the different types in the bus fleet. The evaluation is done then with optimised distribution of buses for the lowest possible life cycle emissions value. The two different pathways to meet the 2025 target are presented below in Figure 7.

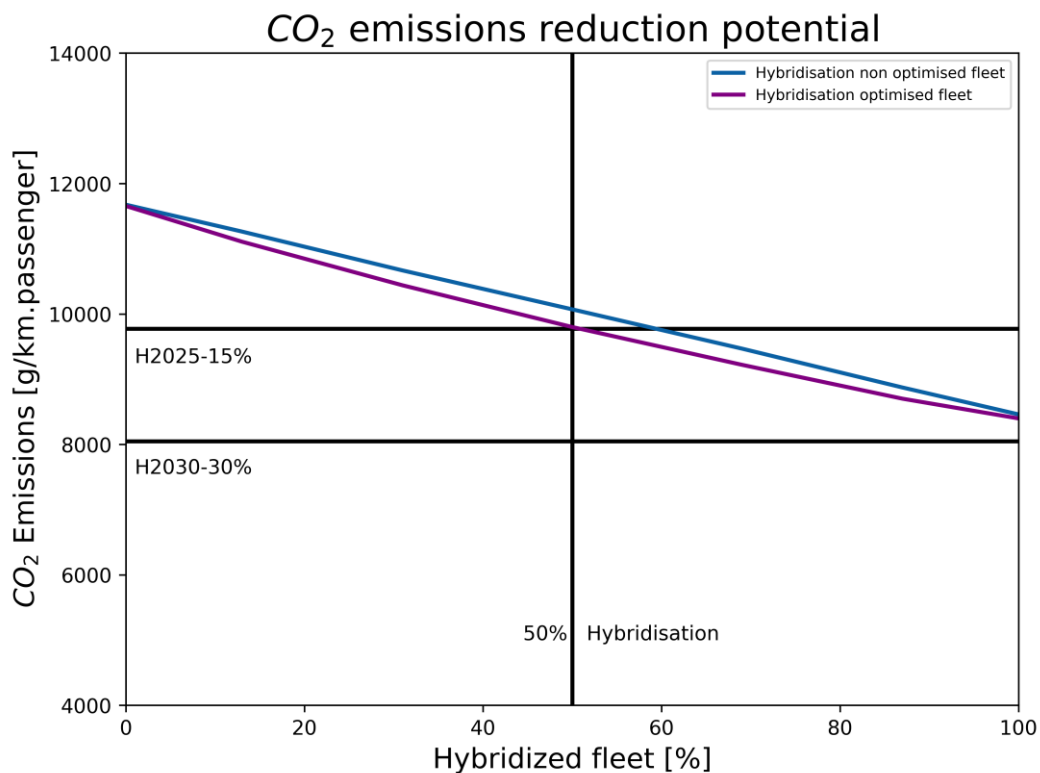

Figure 7: CO₂ emissions reduction potential with varied hybridisation levels to meet 2025 target.

It could be seen that the blue line, with no optimised bus distribution, the 2025 target could be achieved by about 60% hybridised fleet. However, with the optimised distribution of buses in the bus lines, the 2025 target can be met even with the 50% hybridisation (as currently in Valencia). This validates the use of the optimisation function for the optimised distribution of buses of different types for operation in the different bus lines to get the lowest CO₂ emission values. Thus, it could be said that with 50% hybridisation of the fleet, the 2025 target is already satisfied in Valencia. However, it can be also seen that even with the 100% hybridisation, the 2030 emission target can't be met. These results implies that the use of internal combustion engines based on fossil fuels are still an option for 2025 scenario, in the case of considering it in hybrids as a solution.

3.2. Battery and E-Motor sizing

As seen in the Figure 7, even with 100% hybridisation it won't be possible to meet the 2030 emission target. This can be related to the powertrain capacity of the different bus types and its inability to perform efficiently in some of the bus lines. This means that, in specific lines, the bus could benefit from having different batteries and electric motors than the original ones, assisting higher energy regeneration and better energy utilization. To validate this assumption, a dedicated study aimed at optimizing both battery and electric motors for the hybrid platform was performed, based on the methodology described in sections 2.4 and 2.5. For this, a range of e-motor and battery capacity were evaluated in each of the 10 lines to have the best combination of battery and e-motor capacity specific to each individual bus line.

The results of the optimization are presented in Table 5. As it can be seen that by increasing the battery capacity from 9 kWh to around 36 kWh for the respective lines we were able to minimise the life cycle emissions for each of them. This can be understood by the fact that higher battery capacity helps in reducing the number of times the battery is charged or discharged. As the charging of the battery is done by the electricity produced by the engine, in case of increased number of charging the engine is utilised more leading to more fuel consumption and in turn more CO₂ emissions. While the optimum motor torque (around 1200 Nm) capacity helps the vehicle to meet the speed target requested by the driver during the drive cycle. Hence, it can be concluded that higher battery capacity helps in reducing the life cycle CO₂ emissions, while high motor torque output capacity enables the vehicle to meet the speed targets during the journey.

Table 5: Battery and e-motor size for each of the bus lines obtained after the parametric study.

S. No.	Hybrid		Articulated Hybrid	
	Battery Capacity (kWh)	E-motor torque (Nm)	Battery Capacity (kWh)	E-motor torque (Nm)
Line 9	36.02	1237.63	36.98	1114.79
Line 10	36.02	1237.63	36.98	1114.79
Line 19	34.95	1373.02	36.98	1114.79
Line 70	36.02	1237.63	36.98	1114.79
Line 89	36.02	1237.63	34.67	900.05
Line 90	36.02	1237.63	36.15	1725.80
Line 92	35.16	742.06	29.69	672.05
Line 93	34.95	1373.02	33.15	1257.12
Line 95	34.18	1726.60	36.15	1725.80
Line 99	34.95	1373.02	34.40	839.37

Using the new emission values, the optimisation function was used once again to have the new distribution of buses for each of the bus type in each line with the new LCA emission values for the hybrid and articulated hybrid buses. From this the maximum potential of CO₂ reduction is evaluated using hybridisation of buses running in each of the 10 lines. The change in the fleet distribution can be seen below in the Figure 8 (a) and (b).

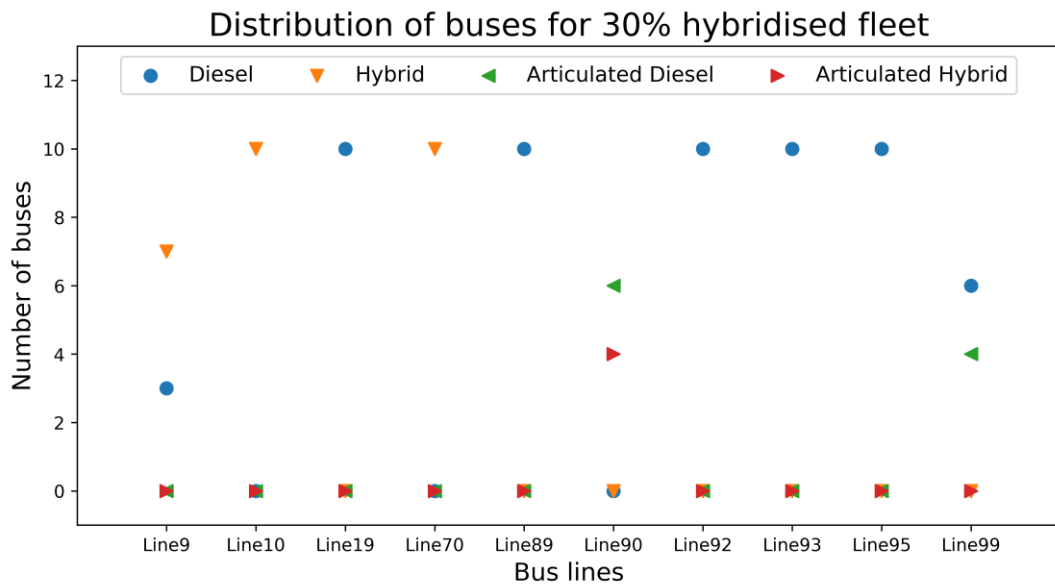

(a)

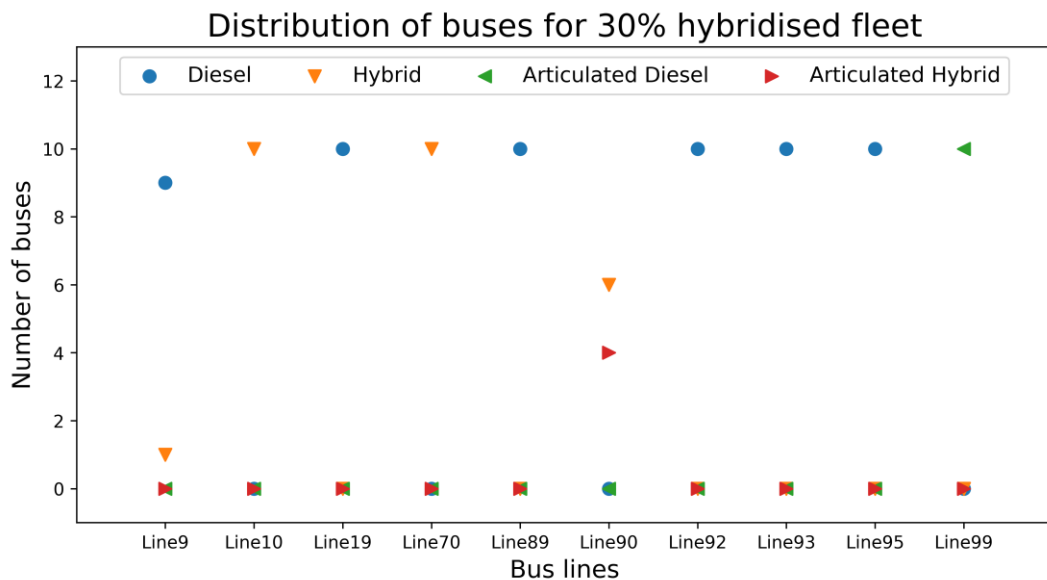

(b)

Figure 8: Change in the distribution of the buses at 30% hybridisation of the fleet (a) before (old fleet) and (b) after (new fleet) battery and e-motor sizing

As it can be seen, the split of the buses in each of the lines is modified when the new powertrain is considered. For example, line 9 that originally benefited the use of hybrid buses, now has 8 diesel buses as the optimum solution. It can be argued that such difference in the distribution can modify the optimum results in terms of CO₂ savings. In this sense, both original and new bus distribution is used to quantify the CO₂ reduction to understand the need of further iterations for searching the best split. The results of this investigation are described in the following subsection.

3.3. Pathway 2030

With the new optimised battery and e-motor capacity the bus fleet is evaluated further for the CO₂ reduction potential. This was done by using the optimisation function again with the new LCA CO₂ emission values, to have a new distribution of buses for a further reduction in the emission values of the fleet (Figure 8(b)). The evaluation is also done to have the emission values from the old distribution of buses in the fleet and by using the new emission values from each line post optimisation of the battery and e-motor power as well. However, there is not big difference between both the emission values with the old distribution of buses as well as with the new distribution. This could be well seen in the Figure 9, where the dotted lines in yellow are the emission values obtained using the old distribution and with the new distribution in solid yellow line.

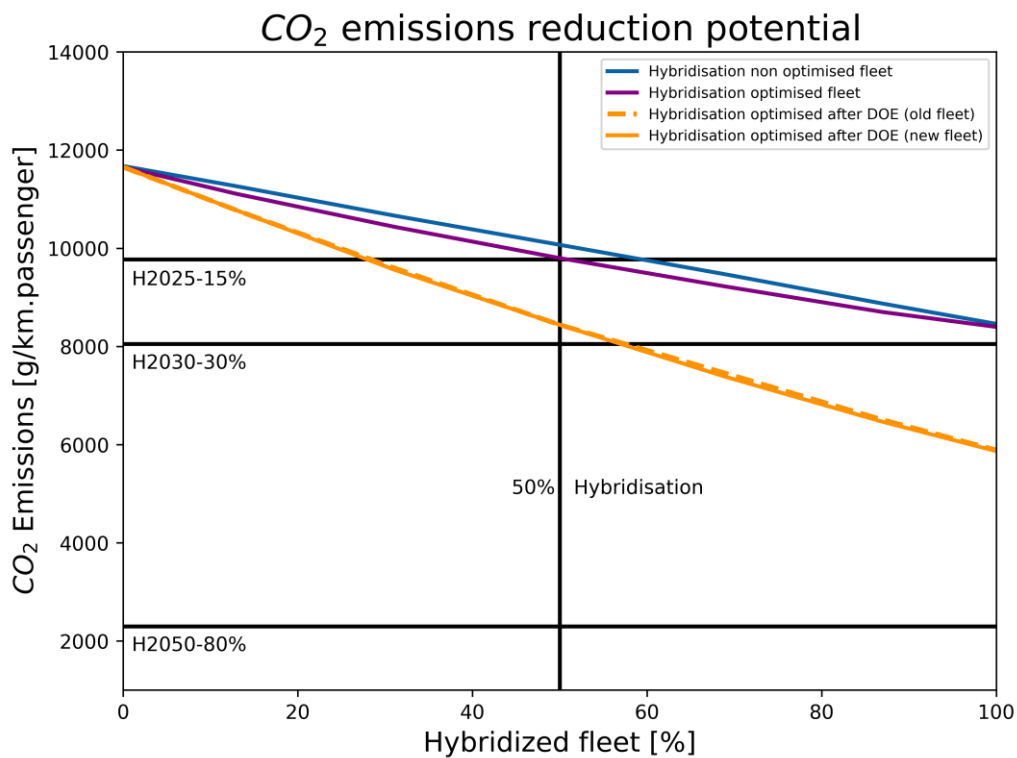

Figure 9: CO₂ emissions reduction potential with varied hybridisation levels as well as by using the most efficient combination of battery pack and e-motor for each bus line to meet 2030 target.

Results in the figure above shows that with the new optimised powertrain of the buses (with respect to each bus line) there is a heavy reduction in the overall life cycle CO₂ emission. With about 55% hybridised fleet the 2030 target of 30% reduction in the overall emissions value can be achieved. This is made possible by the e-motor and battery sizing for each of the bus line. As, the speed and acceleration requirement vary in each of the bus lines, the powertrain configuration too must vary to match the speed target in each of the line with the new and improved powertrain configuration.

It is important to be noted that up to this point, significant benefits can be achieved regarding CO₂ savings with no inclusion of fully electric vehicles. Clearly, the addition of the last could promote further savings in CO₂. Nonetheless, it is

worth to remark that the hybrids can fulfil their role in providing a medium to take advantage of the current energy mix (fossil fuels, coal based, nuclear, etc) while cleaner alternatives are developed for the future. As later for 2050 emission target even with 100% hybridisation the maximum possible reduction in the overall life cycle emissions can only be around 50%. Thus, to meet the 2050 target of 80% (moderate) or 90-95% (ambitious) CO₂ reduction, hybridisation of the conventional powertrains is not the right pathway. Hence, to meet the 2050 targets a separate evaluation needs to be done considering other cleaner powertrain technologies.

3.4. CO₂ emission reduction potential of electrification

For the 2050 emission targets the evaluation is first done by 100% electrification of the fleet. This could be seen in the Figure 10 below, where the whole fleet is evaluated with electric buses in each of the bus lines. The evaluation for the life cycle emissions is done by considering the 2030 as well as 2050 electricity mix. This is done by considering the projection for the electricity generation mix for the year 2030 and 2050[54].

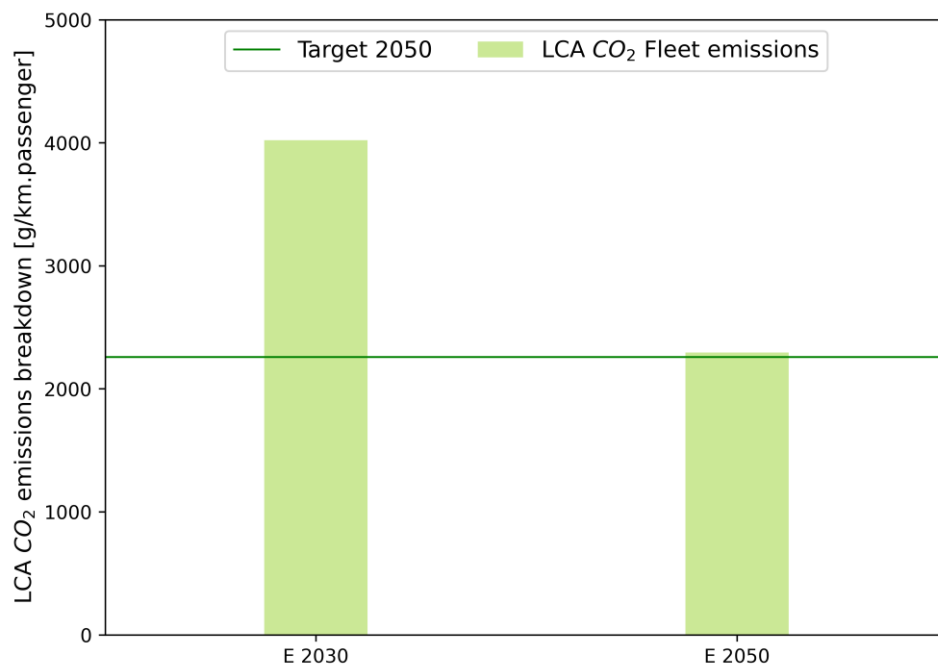

Figure 10: Potential of CO₂ emission reduction by operating 100% electrified fleet in the year 2030 and in 2050.

In the above figure it could be seen that in 2030, even with an all-electric bus fleet the maximum emission reduction will only be by about 65% (around 800 g/km.passenger). Which is too less compared to the 2050 target of emission reduction. Only by 2050 the moderate target of 80% reduction of the CO₂ emissions can be achieved. Thus, only after the 2050 electricity production mix becomes as per the projections, the electric vehicle option becomes as a valid solution to meet the 2050 target.

3.5. CO₂ emission reduction potential of e-fuels

As discussed in the section 2.6, the overall vehicle efficiency yield is almost similar (Figure 6) for both e-fuels pathway as well as the electrification pathway. Hence, they have been evaluated for meeting the 2050 emission targets. The main assumption here are that the electricity generation is only with renewable technologies and the location of the electricity production and e-fuels is where the electricity generation yield efficiency is maximum (ex. MENA region). Figure 11 below shows the results and the potential for emission reduction using e-fuels in the conventional ICE powertrains of the diesel as well as the hybrid buses (articulated as well).

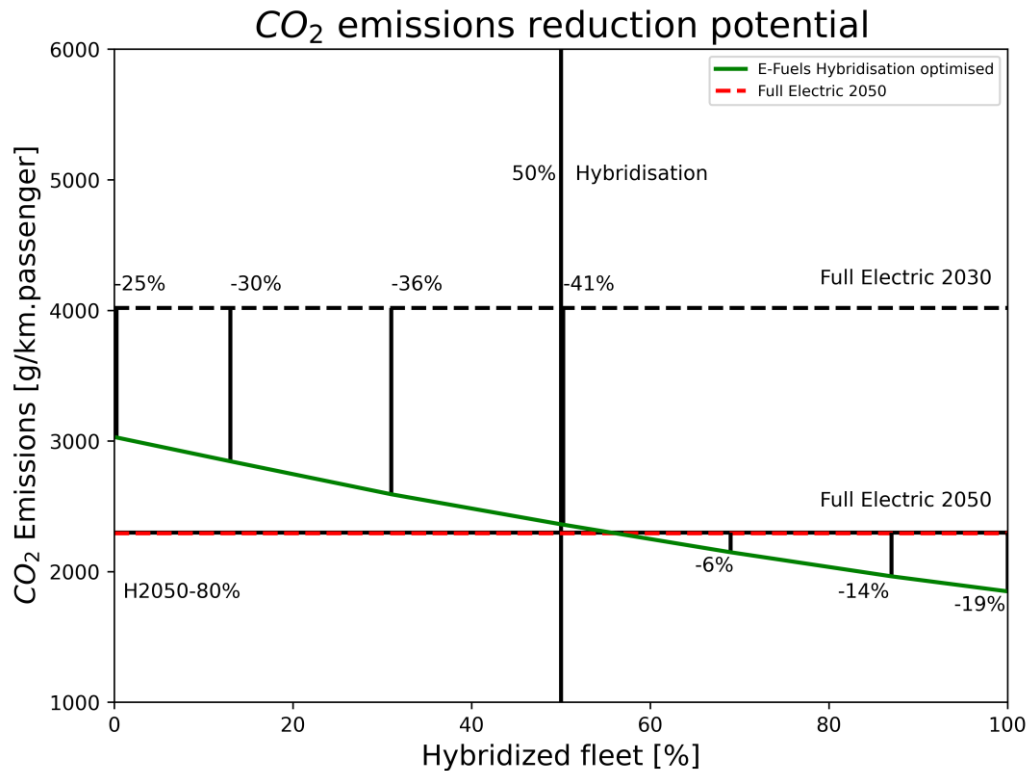

Figure 11: Potential for emission reduction using e-fuels in the conventional ICE bus fleet with different hybridisation levels.

The evaluation is done considering an emission reduction of 74% and 79% from the diesel and hybrid buses respectively using 100% e-fuels (like OMEx, e-Fischer Tropsch Diesel, etc.)[55]. By using e-fuels and varying the hybridisation level from 0-100%, different reduction levels for the CO₂ emissions from the overall fleet are achieved, as tabulated below in Table 6.

Table 6: Different levels of CO₂ reduction with e-fuels with increasing level of hybridisation compared to fully electrified fleet in 2030 and 2050.

% Hybridisation	% Reduction	Reference
0	-25	Full Electric 2030
13	-30	Full Electric 2030
31	-36	Full Electric 2030
50	-41	Full Electric 2030

55	2050 target compliant	
69	-6	Full Electric 2050
87	-14	Full Electric 2050
100	-19	Full Electric 2050

The results here match with the study from Yugo et al. [56] i.e. E-fuels, generated from renewable electricity, has more capacity to reduce the emissions than that from the BEVs in the year 2030. From the Figure 11 it can be observed that even by using 0% hybridised fleet, using e-fuels can still reach emission values lesser than that with a 100% Electric fleet in 2030. Further, the 2050 target could be met by about 55% hybridisation of the fleet, exactly as much needed to hybridise the fleet to meet the 2030 fleet (after battery and e-motor sizing). Thus, by simply powering the 2030 fleet with e-fuels (generated from renewable sources), we can meet the moderate 2050 emission target level.

3.6. Summary of the pathway to 2050

The overall summary of the different pathways to meet the future emission targets with the different powertrain technologies is presented below in the Figure 12.

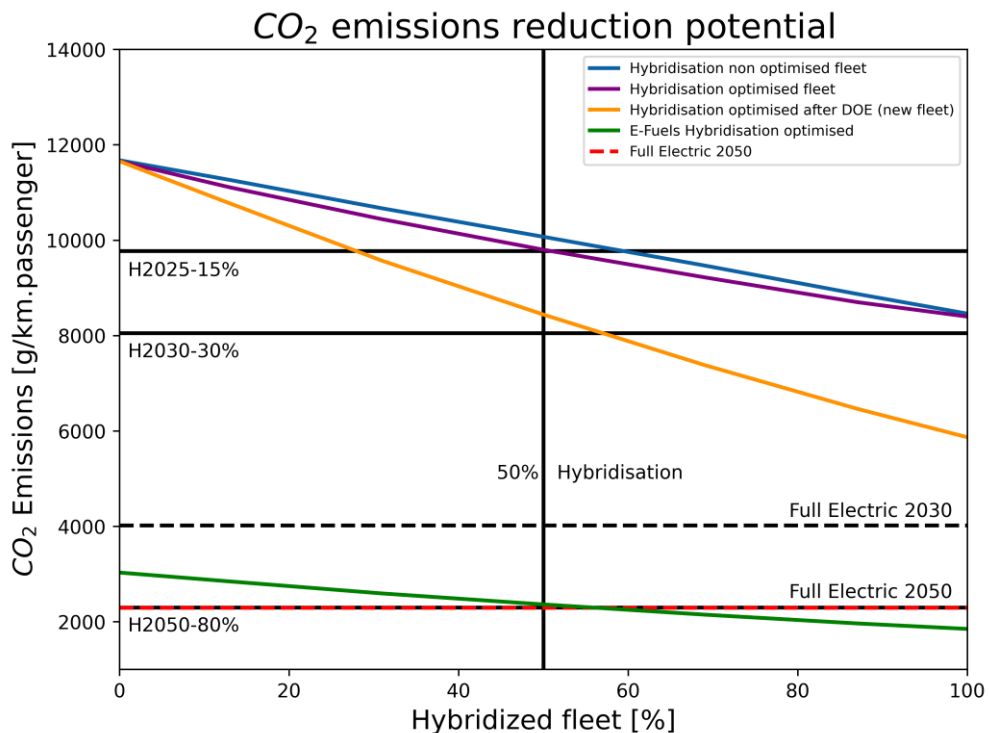

Figure 12: Summary of different pathways for emission reduction to meet the 2025, 2030 and the 2050 emission targets.

It is to be understood that for electric fleet there must be a complete change in the fleet by the purchase of the full electric fleet. While for the e-fuels scenario the cost will be associated only with the fuel as the bus could be the same as before and

only the cost of fuel consumed will be a new addition. However, currently the cost of e-fuels are almost 2-3 times than the conventional fuel price as well as the fuel consumption (in l/km) is also very high of the e-fuels. Thus, it is important to have a cost evaluation too for a better comparison of the two pathways to meet the 2050 emission reduction target.

3.7. Cost Analysis

The cost analysis is done for the two different powertrains: electric as well as current hybrid and diesel buses powered by e-fuels. For the Electric bus two different charging scenarios are kept in mind, one with the fast-charging infrastructure (Electric(F)) and the other with the conventional chargers (Electric(C)), which have different prices in Spain based on the technology advancement[57]. As the e-fuels can be used in the same old diesel (E-Fuel(D)) and hybrid buses (E-Fuel(H)) the procurement cost is considered for the new electric buses only. This cost is calculated to be around 700,000 euros based on average cost of the recent procurement of BYD e-buses in Madrid and Barcelona [58][59]. The fuel price is calculated considering the projected cost of e-fuels by the end of 2030 [60]. Electricity consumption is obtained from the OD simulations and the e-fuel consumption is calculated considering the results from the literature[61]. The maintenance price for the vehicles is considered based on the different powertrain technologies and the specific parts involved in each of them (Table 7). The life cycle cost (Figure 13) is calculated by simply adding the procurement cost, fuel cost and the cost for maintenance. Where procurement cost is considered as CAPEX (Capital expenditure) while the fuel cost and maintenance are considered as OPEX (Operating expenses)[62]. The OPEX is calculated for the overall life cycle kilometres of a typical bus in Europe i.e. of 800,000 km [63]. Full distribution of the cost breakup is mentioned in the Table 9.

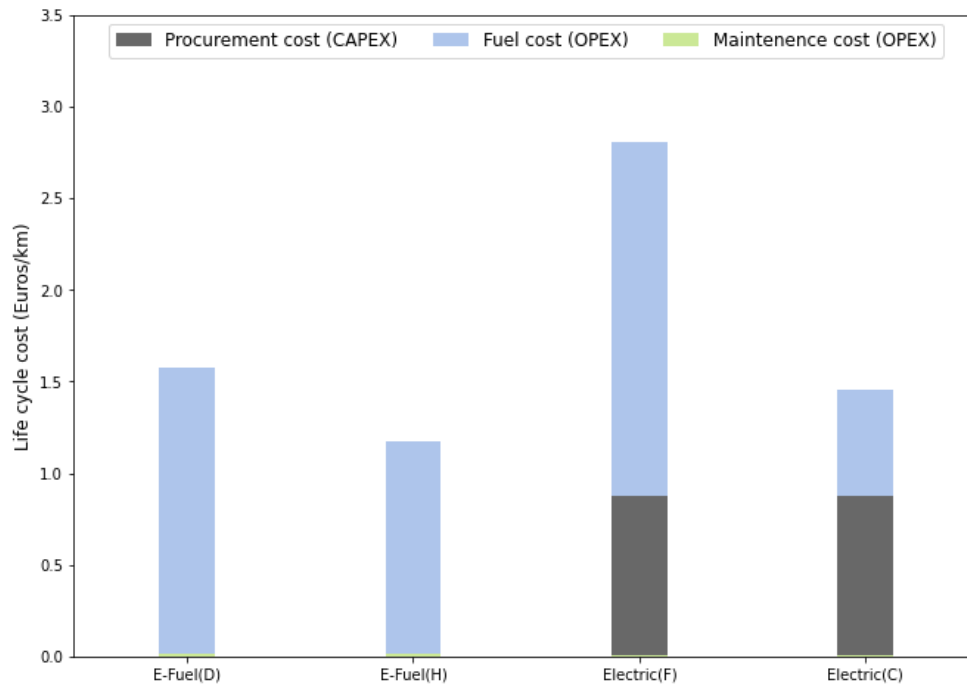

Figure 13: Cost comparison involved with different powertrain technologies.

The above figure reflects that the cost associated with Electric Buses with fast charging infrastructure is the highest and almost double of an e-fuelled diesel bus and 2.5 times of an e-fuelled hybrid bus. While the electric bus with conventional charging infrastructure is cheaper than that compared with a diesel bus operating on e-fuel. So, using a conventional diesel bus with e-fuel will be a little costly compared to an electric bus with conventional charging. However, a conventional hybrid bus will be cheaper in its life cycle cost compared to a new electric bus charged with the conventional charging infrastructure due to the high savings of fuel with hybrid powertrain. Thus, to sum up we can say that the 2050 emission target can be achieved by both the pathways of e-fuels as well as with electrification of the fleet. But the e-fuels option will be relatively cheaper as there isn't any procurement cost associated for the procurement of any new buses.

4. Conclusions

An evaluation of the CO₂ emissions' reduction was done by considering different pathways to meet the future emission targets for the year 2025, 2030 and 2050. Different powertrain technologies were assessed for reaching the future emission targets: hybridisation, electrification as well as use of e-fuels in the conventional IC engines of diesel and hybrid buses. The main inferences of the study are given below:

- Evaluation of the 2019 bus fleet is done by using the average emissions of the 10 evaluated lines and the distribution of buses of the different types in the overall fleet. The emission values don't meet the 2025 reduction target.
- To find the best optimal distribution of the buses in each of the lines an optimising function is used. With the new distribution of buses, the 2025 target

was met with a 50% hybridised fleet. However even with 100% hybridisation the next target for 2030 couldn't be achieved.

- Further, the optimisation of the hybrid powertrain was done by a parametric study, varying the battery and the e-motor capacity. This was done for each of the bus line to find the most optimal battery and e-motor size for the maximum reduction of CO₂ emissions possible with hybrid powertrains.
- With the new emission values for the hybrid buses, the distribution of buses was done again, and it was found to be meeting the 2030 target with a hybridisation level of about 55%. However, even with 100% hybridisation the 2050 target could not be met, which shows the inability of hybridisation to be compliant with the 2050 emission target.
- To meet the 2050 target an assessment is done by considering 100% electric fleet of buses operating in the city. Which was done by considering the electricity mix projection for 2030 as well as of 2050. With 2030 electricity mix a reduction of about 65% was possible, only with the electricity mix projection of 2050 the moderate target of 80% reduction in 2050 was reached.
- Also, the potential of emission's reduction by using e-fuels in the bus fleet is evaluated which shows emission values way below the 2030 fully electric fleet emissions and with about 55% hybridisation it could match the emissions values of the 2050 fully electrified fleet i.e. the moderate 2050 emission target. And with a 100% hybridised fleet powered by e-fuels an emission reduction close to the ambitious 2050 emission target of about 90% is possible.
- Other than the CO₂ reduction potential, the cost effectiveness of both the pathways are also evaluated. Considering that 100% e-fuels can be used in the same old bus fleet, it was found that hybrid buses with e-fuels are the cheapest option to reach the 2050 emission target.

From the above points it can be suggested that it is crucial to evaluate all the bus lines individually for their emissions together with the different bus types. Which helps to assess which bus type, with which configuration (battery and e-motor size) can be in accordance with the future emission targets. It could be realized that for the 2050 target both the evaluated pathways (BEV and e-fuelled fleet) are capable to reduce the fleet emissions in accordance with the moderate 2050 emission target. However, the e-fuelled hybridised fleet is found to be more cost effective as well as more capable to reach the ambitious emission target for 2050. This approach can be used not just in Valencia but in any other countries or cities to have a future emission target compliant fleet of buses. Only the information specific to that region's bus fleet needs to be used, such as: Electricity mix, Bus route, Number of buses, passenger strength, etc.).

Acknowledgements

Operación financiada por la Unión Europea a través del Programa Operativo del Fondo Europeo de Desarrollo Regional (FEDER) de la Comunitat Valenciana 2014-2020 con el objetivo de promover el desarrollo tecnológico, la innovación y una investigación de calidad. Proyecto IDIFEDER/2020/34, Equipamiento para el desarrollo de plantas propulsivas híbridas limpias y eficientes a través del uso de e-fuels, entidad beneficiaria Universitat Politècnica de València.

References

- [1] Kalghatgi G. Is it really the end of internal combustion engines and petroleum in transport? *Applied Energy* 2018;225:965–74. <https://doi.org/10.1016/j.apenergy.2018.05.076>.
- [2] MacLean HL, Lave LB. Evaluating automobile fuel/propulsion system technologies. *Progress in Energy and Combustion Science* 2003;29:1–69. [https://doi.org/10.1016/S0360-1285\(02\)00032-1](https://doi.org/10.1016/S0360-1285(02)00032-1).
- [3] Hooftman N, Messagie M, Van Mierlo J, Coosemans T. A review of the European passenger car regulations – Real driving emissions vs local air quality. *Renewable and Sustainable Energy Reviews* 2018;86:1–21. <https://doi.org/10.1016/j.rser.2018.01.012>.
- [4] Olabi AG, Maizak D, Wilberforce T. Review of the regulations and techniques to eliminate toxic emissions from diesel engine cars. *Science of the Total Environment* 2020;748:141249. <https://doi.org/10.1016/j.scitotenv.2020.141249>.
- [5] Share of transport greenhouse gas emissions n.d. <https://www.eea.europa.eu/data-and-maps/indicators/transport-emissions-of-greenhouse-gases/transport-emissions-of-greenhouse-gases-12>.
- [6] Benajes J, García A, Monsalve-Serrano J, Lago Sari R. Fuel consumption and engine-out emissions estimations of a light-duty engine running in dual-mode RCCI/CDC with different fuels and driving cycles. *Energy* 2018;157:19–30. <https://doi.org/10.1016/j.energy.2018.05.144>.
- [7] Pedrozo VB, May I, Lanzaova TDM, Zhao H. Potential of internal EGR and throttled operation for low load extension of ethanol-diesel dual-fuel reactivity controlled compression ignition combustion on a heavy-duty engine. *Fuel* 2016;179:391–405. <https://doi.org/10.1016/j.fuel.2016.03.090>.
- [8] Paykani A, Garcia A, Shahbakhti M, Rahnama P, Reitz RD. Reactivity controlled compression ignition engine: Pathways towards commercial viability. *Applied Energy* 2021;282:116174. <https://doi.org/10.1016/j.apenergy.2020.116174>.
- [9] Molina S, García A, Monsalve-Serrano J, Villalta D. Effects of fuel injection parameters on premixed charge compression ignition combustion and emission characteristics in a medium-duty compression ignition diesel engine. *International Journal of Engine Research* 2021;22:443–55. <https://doi.org/10.1177/1468087419867014>.
- [10] Benajes J, García A, Monsalve-Serrano J, Balloul I, Pradel G. An assessment of the dual-mode reactivity controlled compression ignition/conventional diesel combustion capabilities in a EURO VI medium-duty diesel engine fueled with an intermediate

- ethanol-gasoline blend and biodiesel. *Energy Conversion and Management* 2016;123:381–91. <https://doi.org/10.1016/j.enconman.2016.06.059>.
- [11] Benajes J, García A, Monsalve-Serrano J, Sari R. Clean and efficient dual-fuel combustion using OME_x as high reactivity fuel: Comparison to diesel-gasoline calibration. *Energy Conversion and Management* 2020;216:112953. <https://doi.org/10.1016/j.enconman.2020.112953>.
- [12] Zhang Y, Sellnau M. A Computational Investigation of PPCI-Diffusion Combustion Strategy at Full Load in a Light-Duty GCI Engine. *SAE Technical Paper Series* 2021;1:1–19. <https://doi.org/10.4271/2021-01-0514>.
- [13] Climate tracker n.d. <https://climateactiontracker.org/>.
- [14] Andersson Ö, Börjesson P. The greenhouse gas emissions of an electrified vehicle combined with renewable fuels: Life cycle assessment and policy implications. *Applied Energy* 2021;289. <https://doi.org/10.1016/j.apenergy.2021.116621>.
- [15] Abd Alla S, Bianco V, Tagliafico LA, Scarpa F. Pathways to electric mobility integration in the Italian automotive sector. *Energy* 2021;221. <https://doi.org/10.1016/j.energy.2021.119882>.
- [16] Song Q, Wang Z, Wu Y, Li J, Yu D, Duan H, et al. Could urban electric public bus really reduce the GHG emissions: A case study in Macau? *Journal of Cleaner Production* 2018;172:2133–42. <https://doi.org/10.1016/j.jclepro.2017.11.206>.
- [17] Navas-Anguita Z, García-Gusano D, Iribarren D. Prospective life cycle assessment of the increased electricity demand associated with the penetration of electric vehicles in Spain. *Energies* 2018;11:1–14. <https://doi.org/10.3390/en11051185>.
- [18] Ayetor GK, Mbonigaba I, Sunnu AK, Nyantekyi-Kwakye B. Impact of replacing ICE bus fleet with electric bus fleet in Africa: A lifetime assessment. *Energy* 2021;221. <https://doi.org/10.1016/j.energy.2021.119852>.
- [19] García Sánchez JA, López Martínez JM, Lumbreras Martín J, Flores Holgado MN, Aguilar Morales H. Impact of Spanish electricity mix, over the period 2008-2030, on the Life Cycle energy consumption and GHG emissions of Electric, Hybrid Diesel-Electric, Fuel Cell Hybrid and Diesel Bus of the Madrid Transportation System. *Energy Conversion and Management* 2013;74:332–43. <https://doi.org/10.1016/j.enconman.2013.05.023>.
- [20] Peng B Bin, Fan Y, Xu JH. Integrated assessment of energy efficiency technologies and CO₂ abatement cost curves in China's road passenger car sector. *Energy Conversion and Management* 2016;109:195–212. <https://doi.org/10.1016/j.enconman.2015.11.064>.
- [21] Shangguan J, Guo H, Yue M. Robust energy management of plug-in hybrid electric bus considering the uncertainties of driving cycles and vehicle mass. *Energy* 2020;203:117836. <https://doi.org/10.1016/j.energy.2020.117836>.
- [22] García A, Monsalve-Serrano J, Martínez-Boggio S, Wittek K. Potential of hybrid powertrains in a variable compression ratio downsized turbocharged VVA Spark Ignition engine. *Energy* 2020;195:117039. <https://doi.org/10.1016/j.energy.2020.117039>.

- [23] Chester M V., Horvath A, Madanat S. Comparison of life-cycle energy and emissions footprints of passenger transportation in metropolitan regions. *Atmospheric Environment* 2010;44:1071–9. <https://doi.org/10.1016/j.atmosenv.2009.12.012>.
- [24] Orbaiz P, Van Dijk N, Cosentino S, Oxenford N, Carignano M, Nigro NM. A Technical, Environmental and Financial Analysis of Hybrid Buses Used for Public Transport. *SAE Technical Papers* 2018;2018-April:1–19. <https://doi.org/10.4271/2018-01-0424>.
- [25] target 2050 n.d. <https://www.roadmap2050.eu/project/roadmap-2050>.
- [26] Demirgok B, Thiruvengadam A, Pradhan S, Besch M, Thiruvengadam P, Posada F, et al. Real-world emissions from modern heavy-duty vehicles: Sensitivity analysis of in-use emissions analysis methods. *Atmospheric Environment* 2021;252:118294. <https://doi.org/10.1016/j.atmosenv.2021.118294>.
- [27] Wei T, Frey HC. Factors affecting variability in fossil-fueled transit bus emission rates. *Atmospheric Environment* 2020;233:117613. <https://doi.org/10.1016/j.atmosenv.2020.117613>.
- [28] García A, Monsalve-Serrano J, Martinez-Boggio S, Gaillard P, Poussin O, Amer AA. Dual fuel combustion and hybrid electric powertrains as potential solution to achieve 2025 emissions targets in medium duty trucks sector. *Energy Conversion and Management* 2020;224:113320. <https://doi.org/10.1016/j.enconman.2020.113320>.
- [29] García A, Monsalve-Serrano J, Villalta D, Lago Sari R, Gordillo Zavaleta V, Gaillard P. Potential of e-Fischer Tropsch diesel and oxymethyl-ether (OMEx) as fuels for the dual-mode dual-fuel concept. *Applied Energy* 2019;253. <https://doi.org/10.1016/j.apenergy.2019.113622>.
- [30] García A, Monsalve-Serrano J, José Sanchís E, Fogué-Robles Á. Exploration of suitable injector configuration for dual-mode dual-fuel engine with diesel and OMEx as high reactivity fuels. *Fuel* 2020;280:118670. <https://doi.org/10.1016/j.fuel.2020.118670>.
- [31] Translation from German original THE CONCEPT OF EFFICIENCY IN THE GERMAN CLIMATE POLICY DEBATE ON ROAD TRANSPORT A comprehensive approach to assessing the efficiency of technologies (translation from the German original version). 2020.
- [32] Environment T&. E-fools : why e-fuels in cars make no economic or environmental sense. 2021.
- [33] Reducing CO2 emissions from Heavy-Duty vehicles n.d. https://ec.europa.eu/clima/policies/transport/vehicles/heavy_en.
- [34] Bus Lines Valencia n.d. <https://www.20minutos.es/noticia/4128185/0/la-linea-99-se-convierte-en-solo-tres-anos-en-la-mas-utilizada-de-la-emt-de-valencia/>.
- [35] Bus Photo Valencia n.d. <http://busphoto.eu/list.php?did=8765&sort=snum>.
- [36] Moovit Company. Moovit App. Moovit App 2019. <https://www.company.moovit.com/features>.
- [37] GT real drive n.d. <https://www.gtisoft.com/gt-suite-applications/integrated-systems/gt-realdrive/>.

- [38] PLAZA JIM. Anexo V: 2020. <https://doi.org/10.2307/j.ctv10rrbk5.16>.
- [39] PLAZA JIM. Anexo V: 2020. <https://doi.org/10.2307/j.ctv10rrbk5.16>.
- [40] Hybrid bus fleet n.d. <https://emtvalencia.info/es/2020/07/la-emt-estrena-el-primero-de-los-164-autobuses-hibridos-con-mampara-integrada-que-incorporaran-para-renovar-la-flota/>.
- [41] MAN Lion's City. V+T Verkehr Und Technik 2005. <https://doi.org/10.37307/j.1868-7911.2005.06.03>.
- [42] Volvo AB. Volvo 7900 Hybrid 2012:1–8. <https://www.volvobuses.es/es-es/our-offering/buses/volvo-7900-electric/specifications.html>.
- [43] B.V BE. BYD ebus specifications n.d. <https://bydeurope.com/pdp-bus-model-12>.
- [44] Lion MAN, Efficienthybrid SCG. Engine n.d.:775. https://www.man.eu/ntg_media/media/en/content_medien/doc/bw_master/bus_1/datenblaetter/man_datenblatt_lionscity_18g.pdf.
- [45] Overall M, Permitted W, Gvw P, Emission E. Volvo 7900 S-Charge Articulated Volvo 7900 S-Charge Articulated n.d.;1:1–4.
- [46] Bus Passenger numbers n.d. https://www.emtvalencia.es/ciudadano/index.php?option=com_content&view=article&id=142:parque-movil&catid=59&Itemid=151.
- [47] Benajes J, García A, Monsalve-Serrano J, Martínez-Boggio S. Optimization of the parallel and mild hybrid vehicle platforms operating under conventional and advanced combustion modes. *Energy Conversion and Management* 2019;190:73–90. <https://doi.org/10.1016/j.enconman.2019.04.010>.
- [48] Luján JM, García A, Monsalve-Serrano J, Martínez-Boggio S. Effectiveness of hybrid powertrains to reduce the fuel consumption and NOx emissions of a Euro 6d-temp diesel engine under real-life driving conditions. *Energy Conversion and Management* 2019;199:111987. <https://doi.org/10.1016/j.enconman.2019.111987>.
- [49] GT real drive n.d. <https://www.gtisoft.com/gt-suite-applications/integrated-systems/gt-realdrive/>.
- [50] García A, Monsalve-Serrano J, Lago Sari R, Tripathi S. Life cycle CO₂ footprint reduction comparison of hybrid and electric buses for bus transit networks. *Applied Energy* 2022;308:118354. <https://doi.org/10.1016/j.apenergy.2021.118354>.
- [51] Burnham A. Updated Vehicle Specifications in the GREET Vehicle-Cycle Model 2012:1–40.
- [52] Translation from German original THE CONCEPT OF EFFICIENCY IN THE GERMAN CLIMATE POLICY DEBATE ON ROAD TRANSPORT A comprehensive approach to assessing the efficiency of technologies (translation from the German original version). 2020.
- [53] Yugo M, Gordillo V, Shafiei E, Megaritis A. A look into the life cycle assessment of passenger cars running on advanced fuels n.d.:2–9.

- [54] Monitor Deloitte. A sustainable energy model for Spain in 2050. Policy recommendations for the energy transition 2016:1–70.
- [55] Yugo M, Gordillo V, Shafiei E, Megaritis A. A look into the life cycle assessment of passenger cars running on advanced fuels n.d.:2–9.
- [56] Yugo M, Gordillo V, Shafiei E, Megaritis A. A look into the life cycle assessment of passenger cars running on advanced fuels n.d.:2–9.
- [57] Electric Charging Prices n.d. https://www.ocu.org/coches/coches/noticias/coche-electrico-precios-recarga?utm_source=facebook&utm_medium=ig-sponsored-post&utm_campaign=ROI_UP&utm_content=consumidores-ocu&fbclid=PAAabbC9DWxrT1V-pLZbV66ijgVYfbFSiIl_f1UgEZnMTkxQ7rY8QXrJ8SwOw.
- [58] Barcelona Electric buses order n.d. <https://www.interregeurope.eu/policylearning/good-practices/item/1727/barcelona-electric-bus-opportunity-charging/>.
- [59] Madrid Electric buses order n.d. <https://www.electrive.com/2021/04/28/emt-madrid-orders-more-e-buses-with-byd-and-irizar/>.
- [60] Soler A. A look into the role of e-fuels in the transport system in Europe (2030-2050) (literature review): Concawe Low Carbon Pathways Joint Group (LCP JG). vol. 28. 2019.
- [61] García A, Monsalve-Serrano J, Villalta D, Fogué-Robles Á. Evaluating OME_x combustion towards stoichiometric conditions in a compression ignition engine. *Fuel* 2021;303. <https://doi.org/10.1016/j.fuel.2021.121273>.
- [62] Runge P, Sölch C, Albert J, Wasserscheid P, Zöttl G, Grimm V. Economic comparison of different electric fuels for energy scenarios in 2035. *Applied Energy* 2019;233–234:1078–93. <https://doi.org/10.1016/j.apenergy.2018.10.023>.
- [63] Sinha R, Olsson LE, Frostell B. Sustainable personal transport modes in a life cycle perspective-public or private? *Sustainability (Switzerland)* 2019;11:1–13. <https://doi.org/10.3390/su11247092>.

Abbreviations

EV	Electric Vehicle
HEV	Hybrid Electric Vehicle
DB	Diesel Bus
HB	Hybrid Bus
EB	Electric Bus
AD	Articulated Diesel
AH	Articulated Hybrid
BEV	Battery Electric Vehicle
ICE	Internal Combustion Engine

MENA	Middle East and North America
LCA	Life Cycle Analysis
GPS	Global Positioning System
DOE	Design of Experiments
EU	European Union
PV	Photovoltaic
WE	Wind Energy
WTW	Well to Wheel
WTT	Well to Tank
TTW	Tank to Wheel
OME	Oxy-Methylene dimethyl Ethers
REET	The Greenhouse Gases, Regulated Emissions, and Energy Use in Technologies
ADR	Assembly, Disposal and Recycling
GHG	Greenhouse Gases
CAPEX	Capital Expenditures
OPEX	Operating Expenses

Appendix

Data used in carrying out this study is presented in this section for reference. This will enable to have a deeper insight into the values and datasets used as well as obtained, to have the evaluation presented in the paper.

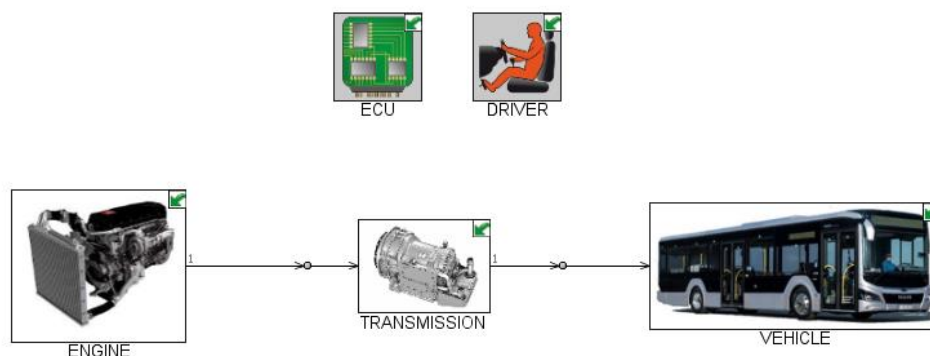

Figure 14: Diesel bus model

The diesel bus model was made by defining the engine specifications and connecting it to the vehicle via its transmission. The driver performance is modelled too and controlled by means of the electronic control unit.

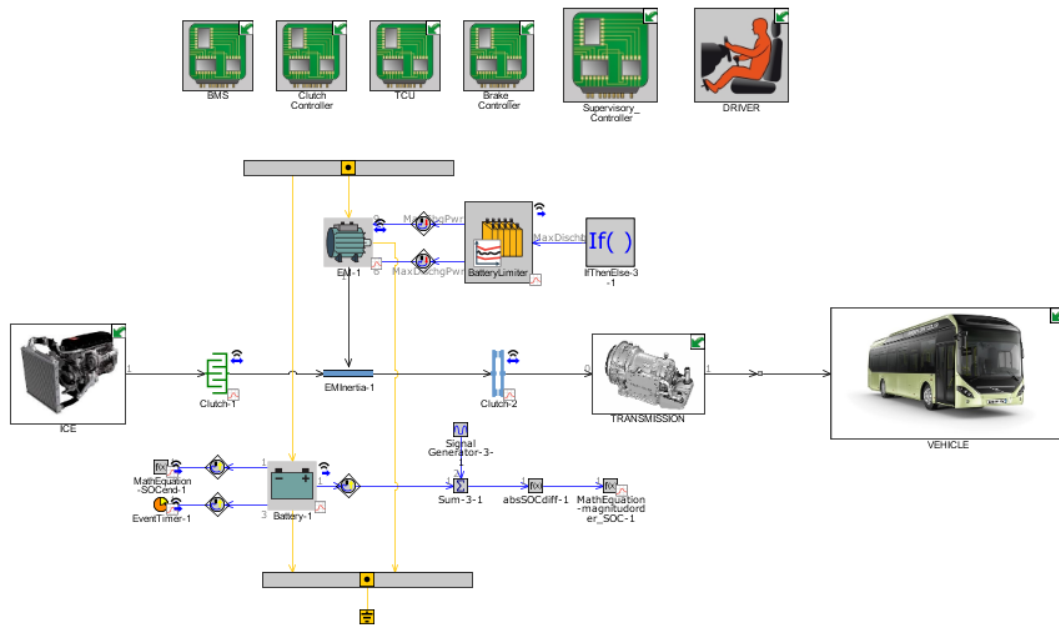

Figure 15: Hybrid bus model

The hybrid bus model was made by defining the engine, motor as well as the battery specifications and connecting it to the vehicle via its transmission. As the hybrid powertrain contains both engine and electric propulsion system the control systems are defined for battery control as well as the control for power input from the engine or the electric unit. This is done by the supervisory control, battery management system (BMS), brake control, clutch controller and transmission control unit (TCU). Also, the driver performance is evaluated.

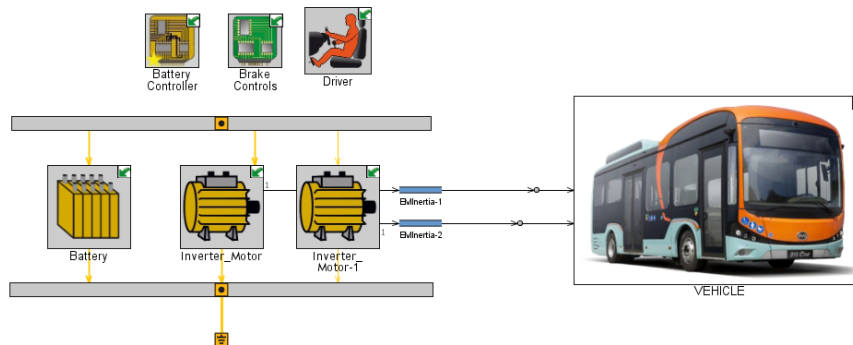

Figure 16: Electric bus model

The electric bus model was made by defining the motor, inverter as well as the battery specifications and connecting it to the vehicle directly via the drive shaft. The control systems are defined for battery control. This is done by defining the battery controller and brake control. The driver performance is evaluated as well.

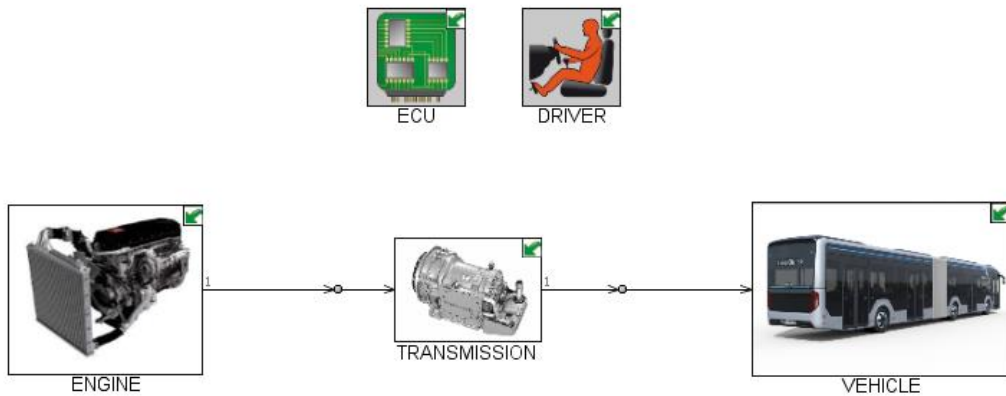

Figure 17: Diesel articulated bus model

The diesel articulated bus model was made by defining the engine specifications and connecting it to the vehicle via its transmission as in case of the conventional diesel bus model. The driver performance is modelled too and controlled by means of the electronic control unit.

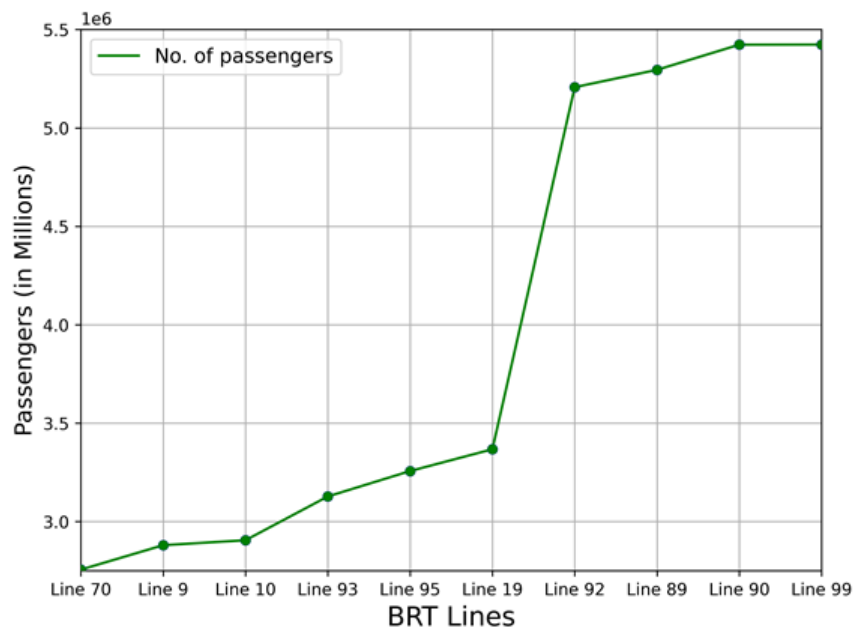

Figure 18: Number of Passengers that used the 10 Bus routes in Valencia (2019).[39]

The figure above shows the number of passengers that used the 10 most used bus lines in the city of Valencia. Line 92, 89, 90 and 99 are the most used ones and are almost used twice than the lines 70, 9 and 10.

Table 7: Dataset for the life cycle analysis of the different Bus models.

Phase	Part (Kg per Kg)	Bill-of-Materials			CO ₂ Footprint (kg/kg)		
		Diesel	Hybrid	Electric	Diesel	Hybrid	Electric
Production	Chassis	×	×	×	2.63	2.61	2.6
	Powertrain	×	×	×	2.51	2.52	3.96

	Transmission	x	x	x	3.75	3.26	3.26
	Body	x	x	x	8.63	8.97	9.48
	Power Electronics	-	x	x	-	2.41	2.41
	Generator	-	x	-	-	2.57	-
	Motor	-	x	x	-	2.57	2.57
	Battery	-	x	x	-	58.84	42.13
Maintenance	Engine Oil	x	x	-	3.12	3.12	-
	Tyres	x	x	x	3.59	3.59	3.59
	Coolant	x	x	x	1.66	1.66	1.66
Assembly, Disposal & Recycling		x	x	x	0.99	0.99	0.99
Use	Well-to-Tank (gm/MJ)	x	x	x	18.6	18.6	89.53
	Tank-to-Wheel	x	x	-	3.17	3.17	-

Here in the above figure, we have the different values used for the life cycle evaluation of the different bus types in the 10 evaluated lines. These values are considered for each of the bus type by considering the different parts involved in them, based on the powertrain configuration involved.

Table 8: Weight distribution in % among the different components in a typical Diesel, Hybrid and Electric powertrain Vehicle.

Component	DB & AD	HB & AH	Electric
Chassis	26.26	29.1	36.1
Powertrain	30.9	20.8	1.8
Transmission	5.7	7.6	3.5
Body	36.8	36.5	44
Power Electronics	-	1.8	6.8
Generator	-	2.1	-
Motor	-	2.1	7.8
Battery	-	0.6	17.8

The weight distribution for the different powertrain configurations is tabulated above. This is done to have the weight of each of the part involved in the manufacturing of the different bus types. As the unit in the dataset in Table 7 is kg eq. of CO₂ emissions/Kg of the part considered.

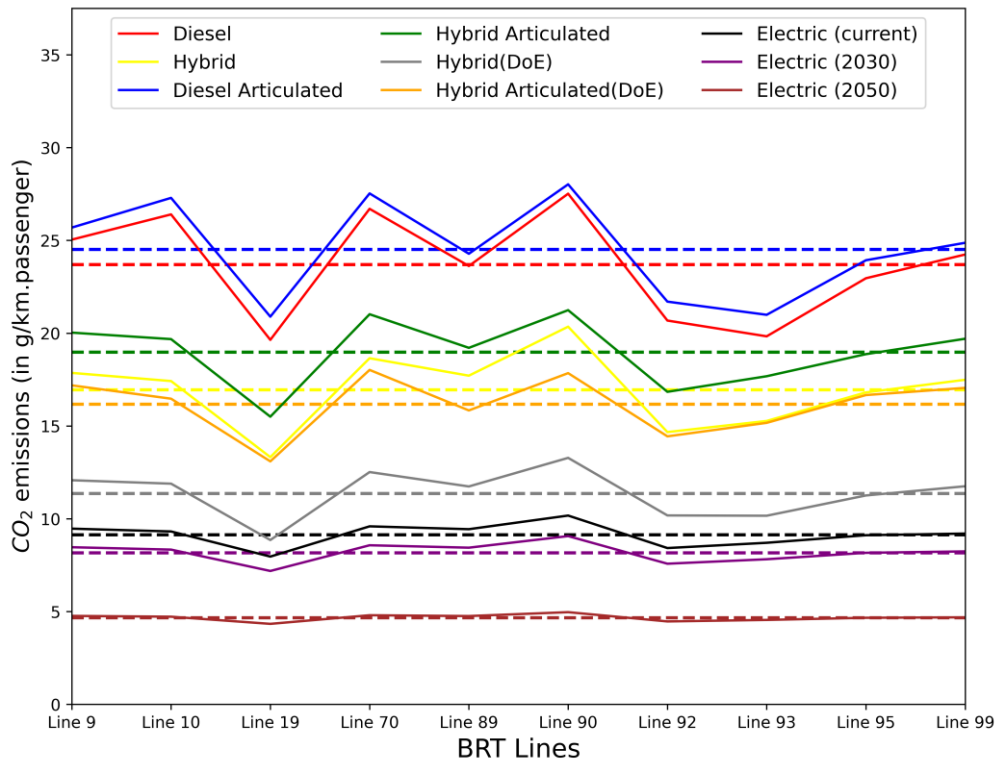

Figure 19: Life cycle emissions of the evaluated 10 lines for each of the different bus type with the average in dotted lines for each bus type.

The above figure is a representation of the variation in the emissions from the different bus lines for each of the bus type evaluated using GT Power simulations. The dotted lines represent the average emissions from each bus type in the city of Valencia (considering the 10 evaluated lines).

Table 9: Cost breakup (in Euros) for the evaluation of life cycle cost of different bus types evaluated.

Bus Type	Cost Procurement (CAPEX)	Fuel Cost (OPEX)	Maintenance (OPEX)	Total (CAPEX + OPEX)
E-Fuel(D)	0	1263669	9520	1228333.22
E-Fuel(H)	0	938221.5462	9520	969271.089
Electric(F)	700000	1544128.21	2965	2247093.21
Electric(C)	700000	463238	2965	1166203

The table above shows the cost break up of the different bus types considering the life cycle of 800,000 kms. The costs involved are: Maintenance and Fuel cost for E-fuelled buses. While for the electric buses the fuel cost, maintenance cost as well as the procurement cost of the new electric bus is considered.