



Steel structures

Worked examples according to the Spanish Code CTE

Arianna Guardiola-Víllora
Agustín Pérez-García



EDITORIAL
UNIVERSITAT POLITÈCNICA DE VALÈNCIA

Arianna Guardiola-Víllora
Agustín Pérez-García

STEEL STRUCTURES

Worked examples according to the Spanish code CTE

EDITORIAL
UNIVERSITAT POLITÈCNICA DE VALÈNCIA

The publication of this book has been approved by the Department of continuum mechanics and theory of structures of the Universitat Politècnica de València (Spain)

Academic book collection

To cite this publication please use the following reference: GUARDIOLA-VÍLLORA, A., PÉREZ-GARCÍA, A. (2017) *Steel structures. Worked examples according to the Spanish code CTE*. Valencia: Editorial Universitat Politècnica de València

© Arianna Guardiola-Víllora
Agustín Pérez-García

© 2017, of this edition: Editorial Universitat Politècnica de València
Distribution: www.lalibreria.upv.es / Ref.: 0637_02_01_01

Printed: Byprint Percom, sl

ISBN: 978-84-9048-634-4
Print on demand

Any unauthorized copying, distribution, marketing, editing, and in general any other exploitation, for whatever reason, of this piece of work or any part thereof, is strictly prohibited without the authors' expressed and written permission.

Print inSpain

STEEL STRUCTURES.

Worked examples according to the Spanish Code CTE

PREFACE

The main objective of the structural design is to ensure that the structure is designed and executed in such a way that it will perform satisfactorily during the building process and the intended lifespan, taking into account appropriate degrees of reliability and economical optimisation.

Specifically, the designer must check that the structure is able to bear the applied loads being rigid enough and safe.

This book introduces the design of steel structures in accordance to the Spanish Technical Code (CTE) which describes the basis for structural design and steel structures verification.

The following worked examples introduce the principles and requirements for the safety and serviceability of steel structures established in the mentioned CTE, specifically, the Basic Documents DB SE and DB SE-A.

All tables and mathematical expressions needed to follow every step of each worked example have been included in this manual. However, it is advisable that readers become familiar with the contents of the Basic Documents of the Spanish code. All these documents can be downloaded from the web page: <https://www.codigotecnico.org/>

This book includes teaching resources and practical examples developed over many years of training undergraduate students of architecture.

Chapters follow a logical design order from modelling (geometry, loads and material) structural analysis, member sizing (submitted to tension, compression, bending moments and combined actions) and design of joints (bolted and welded connections and column bases)

A final chapter containing some past papers has been included in order to prove useful as a textbook in schools of architecture or structural engineering.

The authors would like to acknowledge the support of their sons and professor L. Basset for their comments and contributions

INDEX

CHAPTER 1. STEEL AS A STRUCTURAL MATERIAL	5
Structural Steel	7
Material properties for hot rolled steel	7
Design values of structural steel coefficients	8
Classification of cross sections	10
Geometrical properties of hot rolled cross sections	21
Resistances of hot rolled cross sections	37
 WORKED EXAMPLES	 41
1.1. MECHANICAL PROPERTIES OF A BUILT-UP [] CROSS-SECTION	43
1.2. MECHANICAL PROPERTIES OF A BUILT-UP T CROSS-SECTION	45
1.3. MECHANICAL PROPERTIES OF A BUILT-UP I CROSS-SECTION AND CLASSIFICATION	51
1.4. CLASSIFICATION OF HOT ROLLED CROSS-SECTION	55
 CHAPTER 2. BASIS OF STRUCTURAL DESIGN	 57
Design requirements	59
Limit states	60
Actions and load cases	61
Combination of actions	66
Effects of imperfections	67
 WORKED EXAMPLES	 69
2.1. COMBINATIONS OF ACTIONS	71
2.2. IMPERFECTIONS FOR GLOBAL ANALYSIS OF FRAMES	73
2.3. STABILISING FORCES FOR ANALYSIS OF BRACING SYSTEMS	75

CHAPTER 3. GLOBAL ANALYSIS	77
Single storey industrial buildings	79
Classification of steel frames	79
Statically determinate structures	83
Continuous beams	90
Horizontal stiffness	92
WORKED EXAMPLES	99
3.1. CLASSIFICATION OF A FRAME AS SWAY OR NON-SWAY	101
3.2. CLASSIFICATION OF A FRAME AS BRACED OR UNBRACED	107
CHAPTER 4. TENSION, COMPRESSION AND BUCKLING	115
Single members class 1, 2 or 3, subjected to tension or compression	117
Single members class 1 or 2 subjected to compression and bending	122
Practical procedures: class 1 and 2 OPEN CROSS-SECTIONS subjected to compression plus bending about the y axis ($N_{Ed} + M_{y,Ed}$)	131
Practical procedures: class 1 and 2 HOLLOW CROSS-SECTIONS subjected to compression plus bending about the y axis ($N_{Ed} + M_{y,Ed}$)	137
Practical procedures: class 1 and 2 OPEN and CLOSED CROSS- SECTIONS subjected to compression plus bending about the z axis ($N_{Ed} + M_{z,Ed}$)	143
Single members class 3 subjected to compression and bending	144
Single members subjected to tension forces and bending moments	146
WORKED EXAMPLES	149
4.1. SIMPLE COLUMN SUBJECTED TO TENSION FORCES	151
4.2. SIMPLE COLUMN SUBJECTED TO COMPRESSION FORCES	153
4.3. SIMPLE COLUMN SUBJECTED TO COMPRESSION AND BENDING MOMENT ABOUT Y AXIS ($M_{y,ED}$)	159
4.4. SIMPLE COLUMN SUBJECTED TO COMPRESSION AND BENDING MOMENT ABOUT Z AXIS ($M_{z,ED}$)	173
4.5 MEMBERS DESIGN OF A PITCHED TRUSS	185

CHAPTER 5. BEAMS IN BENDING	195
Initial sizing of beams in bending	197
Ultimate Limit States (ULS)	198
Resistance	198
Bending moments condition	198
Shear forces condition	199
Bending and shear interaction	200
Bending and axial force interaction	201
Lateral-torsional buckling	201
Shear buckling of the web	205
Local effects: web local yielding	206
Serviceability Limit States (SLS)	209
Deformations	209
Vibrations	212
Built-up beams initial sizing	213
WORKED EXAMPLES	215
5.1. HOT ROLLED BEAM	217
5.2. BUILT-UP BEAM	227
CHAPTER 6. DESIGN OF JOINTS	245
GENERAL DESIGN CRITERIA	247
INTERNAL FORCES IN CONNECTIONS	254
BOLTED CONNECTIONS	254
Practical procedures: bolted connections with bearing type bolts	269
Practical procedures: bolted connections with preloaded bolts	271
WELDED CONNECTIONS	274
Practical procedures: welded connections	275
WORKED EXAMPLES	279
6.1. WELDED AND BOLTED GUSSET PLATE CONNECTION	281
6.2. PINNED CONNECTIONS: BEAM TO COLUMN AND BEAM SPLICE	291
6.3. PRELOADED BOLTS CONNECTION AND RIGID BEAM SPLICE	305
6.4. BOLTED CONNECTION IN SHEAR AND TENSION	321
6.5. WELDED BEAM TO COLUMN RIGID JOINT	355
6.6. BOLTED BEAM TO COLUMN RIGID JOINT	367

CHAPTER 7. COLUMN BASE PLATES	381
Introduction	383
Design bearing strength of confined concrete	383
Effective bearing area	384
Base plate stiffness	385
Anchorage	386
Design process	388
Centred compression (pinned or fixed joints)	389
Eccentric compression (fixed joints)	390
Compression + bending (fixed joints)	391
 WORKED EXAMPLES	 393
7.1. COLUMN BASE PLATE IN COMPRESSION	395
7.2. COLUMN BASE PLATE ECCENTRIC COMPRESSION	401
7.3. COLUMN BASE PLATE IN COMPRESSION + BENDING	409
7.4. STIFFENED COLUMN BASE PLATE	417
 CHAPTER 8. PAST EXAM PAPERS	 429
8.1. TRUSS CHORD IN COMPRESSION, TRUSS JOINT DESIGN AND COLUMN IN COMPRESSION AND BENDING ABOUT THE Y AXIS	431
8.2. DOUBLE SIDED BEAM TO COLUMN BOLTED JOINT, COLUMN BASE PLATE DESIGN AND COLUMN IN COMPRESSION	449
8.3. BEAM TO COLUMN BOLTED JOINT, COLUMN IN COMPRESSION AND BEAM IN BENDING	461
8.4. BEAM TO COLUMN WELDED JOINT, BEAM IN BENDING AND COLUMN IN COMPRESSION AND BENDING	471
8.5. COLUMN IN COMPRESSION AND BENDING, COLUMN BASE PLATE IN COMPRESSION AND BEAM TO COLUMN AND BRACING SYSTEM WELDED JOINT	487

CHAPTER 1

STEEL AS STRUCTURAL MATERIAL

Structural Steel	7
Material properties for hot rolled steel	7
Design values of structural steel coefficients	8
Classification of cross sections	10
Geometrical properties of hot rolled cross sections	21
Resistances of hot rolled cross sections	37
WORKED EXAMPLES	41
1.1. MECHANICAL PROPERTIES OF A BUILT-UP [] CROSS-SECTION	43
1.2. MECHANICAL PROPERTIES OF A BUILT-UP T CROSS-SECTION	45
1.3. MECHANICAL PROPERTIES OF A BUILT-UP I CROSS-SECTION AND CLASSIFICATION	51
1.4. CLASSIFICATION OF HOT ROLLED CROSS-SECTIONS	55

STRUCTURAL STEEL

Steel is an alloy made by combining iron and other elements (carbon, manganese, chromium, vanadium and tungsten) being carbon the most common of these. Steel properties depend dramatically on the carbon contents (usually around 2⁰/₀₀ or 3⁰/₀₀ for structural steel).

MATERIAL PROPERTIES FOR HOT ROLLED STEEL

Nominal values of the yield strength f_y and the ultimate tensile strength f_u for hot rolled steel have been defined in the code UNE EN 10025. The nominal values referred in this code can be adopted as characteristic values when calculating any part of the structure.

Table 1.1 – Nominal values of the yield strength f_y and the ultimate tensile strength f_u for structural steel according to UNE EN 10025

DESIGNATION	Nominal thickness t (mm)				Charpy test temperature (°C)
	Yield stress f_y (N/mm ²)			Ultimate tensile stress f_u (N/mm ²)	
	$t \leq 16$	$16 < t \leq 40$	$40 < t \leq 63$	$3 \leq t \leq 100$	
S 235 JR S 235 J0 S 235 J2	235	225	215	360	20 0 -20
S 275 JR S 275 J0 S 275 J2	275	265	255	410	20 9 -20
S 355 JR S 355 J0 S 355 J2 S 355 K2	355	345	335	470	20 0 -20 -20(1)
S 450 J0	450	430	410	550	0

⁽¹⁾ minimum energy at least 40 J

Table 1.2 – Maximum thickness for statically loaded structural elements (mm)

grade → type ↓	Minimum temperature								
	0°C			-10°C			-20°C		
	JR	J0	J2	JR	J0	J2	JR	J0	J2
S 235	50	75	105	40	60	90	35	50	75
S 275	45	65	95	35	55	75	30	45	65
S 355	35	50	75	25	40	60	20	35	50

Properties of materials or products should be represented by their characteristic value:

- f_y structural steel yield strength
- f_u structural steel ultimate strength

Where the design value of the yield strength is $f_{yd} = \frac{f_y}{\gamma_M}$ [1.1]

and the design ultimate tensile strength is $f_{ud} = \frac{f_u}{\gamma_M}$ [1.2]

where

$\gamma_{M0} = 1,05$ partial factor for resistance

$\gamma_{M1} = 1,05$ partial factor for instability phenomena

$\gamma_{M2} = 1,25$ partial factor for resistance of cross-sections in tension to fracture

$\gamma_{M2} = 1,25$ partial factor for resistance of bolts and welds

$\gamma_{M3} = 1,40$ partial factor for slip-resistance of preloaded bolts and slotted holes

DESIGN VALUES OF STRUCTURAL STEEL COEFFICIENTS

The material coefficients to be adopted in calculations shall be taken as follows

- Young's modulus or modulus of elasticity $E = 210.000 \text{ N/mm}^2$
- Shear modulus $G = 81.000 \text{ N/mm}^2$
- Poisson ratio $\nu = 0,3$
- Coefficient of linear thermal expansion $\alpha = 1,2 \times 10^{-5} \text{ (}^\circ\text{C)}^{-1}$
- Unit mass $\rho = 7.850 \text{ kg/m}^3$

GEOMETRICAL PROPERTIES

Thicknesses of steel plates: 4, 5, 6, 7, 8, 9, 10, 11, 12, 14, 15, 18, 20, 22, 25, 30, 35, 40, 45 y 50 mm (It is advisable not to use plates thinner than 6 mm)

Rolled cross sections

- I-beam (I-shaped cross-section - in Britain these include Universal Beams (UB) and Universal Columns (UC); in Europe it includes the IPE, HE, HL, HD and other sections; in USA it includes Wide Flange (WF) and H sections)
- Z-Shape (half a flange in opposite directions)
- HSS-Shape. Hollow structural section also known as SHS (structural hollow section) and including square, rectangular, circular (pipe) and elliptical cross sections.

- Angle (L-shaped cross-section)
- Channel, or C section, ([-shaped cross-section)
- Tee (T-shaped cross-section)

It is advisable not to use hollow structural sections having thickness thinner (t) than 5 mm.

Cold formed cross sections: L, LD, U, C, Ω , Z

Table 1.3 Symbols

x-x	axis along the member	$A_{v,y}$	Shear area y axis (shear parallel to axis y)
y-y	cross-section axis parallel to the flanges	$A_{v,z}$	Shear area z axis (shear parallel to axis z)
z-z	cross-section axis perpendicular to flanges	I_y	Second moment of area (moment of inertia) about y axis
b	width of a cross-section	I_z	Second moment of area (moment of inertia) about z axis
h	depth of a cross section	I_t	St. venant torsional constant
t_w	web thickness	i_y	radius of gyration about y axis
t_f	flange thickness	i_z	radius of gyration about z axis
r	and r_1 radius of root fillet	$W_{el,y}$	elastic section modulus about y axis
r_2	toe radius	$W_{el,z}$	elastic section modulus about z axis
A	Area of a cross section	$W_{pl,y}$	plastic section modulus about y axis
		$W_{pl,z}$	plastic section modulus about z axis

Table 1.4 Design resistances

$N_{pl,Rd}$	Design plastic resistance for axial forces
$V_{pl,y,Rd}$	Design plastic resistance for shear forces parallel to y axis
$V_{pl,z,Rd}$	Design plastic resistance for shear forces parallel to z axis
$M_{el,y,Rd}$	Design elastic resistance for bending moments about y axis
$M_{el,z,Rd}$	Design elastic resistance for bending moments about z axis
$M_{pl,y,Rd}$	Design plastic resistance for bending moments about y axis
$M_{pl,z,Rd}$	Design plastic resistance for bending moments about z axis

CLASSIFICATION OF CROSS-SECTIONS

- Class 1 cross-sections are those which can form a plastic hinge with the rotation capacity required for plastic analysis
- Class 2 cross-sections are those which can develop a plastic moment resistance but have limited rotation capacity
- Class 3 cross-sections are those in which the calculated stress in the extreme compression fibre of the steel member can reach its yield strength, but local buckling is liable to prevent development of the plastic moment resistance
- Class 4 cross-sections are those in which it is necessary to make explicit allowances for the effects of local buckling when determining their moment resistance or compression resistance.

The classification of cross-sections depends on the proportions of each of its compression components. A cross-section is classified by quoting the highest (least favourable) class of its compression elements.

The limiting proportions for class 1, 2 and 3 compression elements should be obtained from Tables 1.5; 1.6 and 1.7. An element which fails to satisfy the limits for class 3 should be taken as class 4.

Table 1.5 Maximum width-thickness ratios for compression parts

Internal compression parts				
Internal compression parts	Stress distribution in parts (compression positive)	Width-thickness ratio c/t maximum		
		Class 1	Class 2	Class 3
GEOMETRY				
Part subject to compression		33ε	38ε	42ε
Part subject to bending		72ε	83ε	--
		--	--	124ε
Part subject to compression and bending $\psi \geq -1$ $\alpha \geq 0,5$		$\frac{396\varepsilon}{13\alpha - 1}$	$\frac{456\varepsilon}{13\alpha - 1}$	--
		--	--	$\frac{42\varepsilon}{0,67 + 0,33\psi}$
Part subject to tension and bending ⁽¹⁾ $\psi \leq -1$ $\alpha \leq 0,5$		$\frac{36\varepsilon}{\alpha}$	$\frac{41,5\varepsilon}{\alpha}$	--
		--	--	$62\varepsilon(1 - \psi)\sqrt{-\psi}$
⁽¹⁾ $\psi \leq -1$ applies where either the compression stress $\sigma \leq f_y$ for the tensile strain $e_y > f_y/E$			$\varepsilon = \sqrt{235/f_y}$	

Table 1.6 – Maximum width-thickness ratios for compression parts



GEOMETRY		Outstand flanges		
		Rolled sections		Built-up sections
Internal compression parts	Stress distribution in parts (compression positive)	Width-thickness ratio c / t maximum		
		Class 1	Class 2	Class 3
Part subject to Compression		9ε	10ε	14ε
Part subject to bending and compression tip in compression		$\frac{9\varepsilon}{\alpha}$	$\frac{10\varepsilon}{\alpha}$	--
		--	--	$21\varepsilon\sqrt{k_{\sigma 1}}$
Part subject to bending and compression tip in tension $\psi \geq -1$ $\alpha \geq 0,5$		$\frac{9\varepsilon}{\alpha^{1,5}}$	$\frac{10\varepsilon}{\alpha^{1,5}}$	--
		--	--	$21\varepsilon\sqrt{k_{\sigma 2}}$
$k_{\sigma 1}$ y $k_{\sigma 2}$ coefficients depend on ψ = tensions in extremes ratio $k_{\sigma 1} = 0,57 - 0,21\psi + 0,07\psi^2$ for $1 \geq \psi \geq -3$ $k_{\sigma 2} = 0,578 / (0,34 + \psi)$ for $1 \geq \psi \geq 0$ $k_{\sigma 2} = 1,7 - 5\psi + 17,1\psi^2$ for $0 \geq \psi \geq -1$				$\varepsilon = \sqrt{235/f_y}$

Table 1.7 - Maximum width-thickness ratios for compression parts

Geometry tubular sections	Internal forces	Width-thickness ratio d/t maximum		
		Class 1	Class 2	Class 3
	Compression	$\frac{d}{t} \leq 50\epsilon^2$	$\frac{d}{t} \leq 70\epsilon^2$	$\frac{d}{t} \leq 90\epsilon^2$
	Bending Bending and compression			
$\epsilon = \sqrt{235/f_y}$				

IPE, HEA, HEB and HEM cross sections are classified into classes in Tables 1.8, 1.9 and 1.10

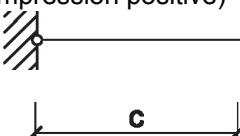
Table 1.8 - Steel S 235

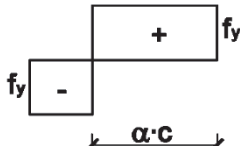
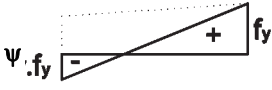
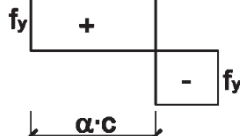
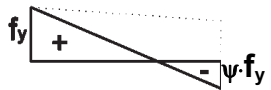
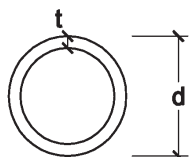
Type		Class of cross-section			Maximum axial force (kN)		
		Compression	Bending		Bending (M_y) and compression		
			M_y	M_z	Class 1	Class 2	Class 3
IPE	80 to 240	1	1	1	(1)	(2)	(2)
	270	2	1	1	335	(1)	(2)
	300	2	1	1	371	(1)	(2)
	330	2	1	1	401	(1)	(2)
	360	2	1	1	441	(1)	(2)
	400	3	1	1	493	653	(1)
	450	3	1	1	557	749	(1)
	500	3	1	1	626	851	(1)
	550	4	1	1	732	999	3144
	600	4	1	1	835	1148	3558
HEA	100 to 240	1	1	1	(1)	(2)	(2)
	260	2	2	2	(2)	(1)	(2)
	280	2	2	2	(2)	(1)	(2)
	300	2	2	2	(2)	(1)	(2)
	320 to 500	1	1	1	(1)	(2)	(2)
	550	2	1	1	1148	(1)	(2)
	600	2	1	1	1163	(1)	(2)
HEB	100 to 600	1	1	1	(1)	(2)	(2)
HEM	100 to 600	1	1	1	(1)	(2)	(2)
		(1) No top limit for the axial force					
		(2) This cross-section class cannot be reached					

Table 1.9 –STEEL S 275

Type		Class of cross-section			Maximum axial force (kN)		
		Compression	Bending		Bending (M_y) and compression		
			M_y	M_z	Class 1	Class 2	Class 3
IPE	80 to 220	1	1	1	(1)	(2)	(2)
	240	2	1	1	321	(1)	(2)
	270	2	1	1	337	(1)	(2)
	300	2	1	1	370	(1)	(2)
	330	3	1	1	398	530	(1)
	360	3	1	1	435	586	(1)
	400	3	1	1	483	657	(1)
	450	4	1	1	540	747	2567
	500	4	1	1	600	844	2838
	550	4	1	1	700	990	3258
	600	4	1	1	795	1133	3681
HEA	100	1	1	1	(1)	(2)	(2)
	120	1	1	1	(1)	(2)	(2)
	140	1	1	1	(1)	(2)	(2)
	160	1	1	1	(1)	(2)	(2)
	180	2	2	2	(2)	(1)	(2)
	200	2	2	2	(2)	(1)	(2)
	220	2	2	2	(2)	(1)	(2)
	240	2	2	2	(2)	(1)	(2)
	260	3	3	3	(2)	(2)	(1)
	280	3	3	3	(2)	(2)	(1)
	300	3	3	3	(2)	(2)	(1)
	320	2	2	2	(2)	(1)	(2)
	340	1	1	1	(1)	(2)	(2)
	360	1	1	1	(1)	(2)	(2)
	400	1	1	1	(1)	(2)	(2)
	450	1	1	1	(1)	(2)	(2)
	500	2	1	1	1141	(1)	(2)
550	2	1	1	1146	(1)	(2)	
600	3	1	1	1147	1544	(1)	
HEB	100 to 550	1	1	1	(1)	(2)	(2)
	600	2	1	1	1968	(1)	(2)
HEM	100 to 600	1	1	1	(1)	(2)	(2)

(1) No top limit for the axial force
(2) This cross-section class cannot be reached

Table 1.10 – STEEL S 355

Type		Class of cross-section			Maximum axial force (kN)		
		Compression	Bending		Bending (M_y) and compression		
			M_y	M_z	Class 1	Class 2	Class 3
IPE	80 to 160	1	1	1	(1)	(2)	(2)
	180	2	1	1	262	(1)	(2)
	200	2	1	1	284	(1)	(2)
	220	2	1	1	298	(1)	(2)
	240	2	1	1	322	(1)	(2)
	270	3	1	1	331	447	(1)
	300	4	1	1	357	491	1841
	330	4	1	1	379	529	2040
	360	4	1	1	409	579	2251
	400	4	1	1	446	644	2489
	450	4	1	1	485	721	2700
	500	4	1	1	526	803	2971
	550	4	1	1	609	937	3407
	600	4	1	1	681	1065	3841
HEA	100	1	1	1	(1)	(2)	(2)
	120	1	1	1	(1)	(2)	(2)
	140	2	2	2	(2)	(1)	(2)
	160	2	2	2	(2)	(1)	(2)
	180 to 340	3	3	3	(2)	(2)	(1)
	360	2	2	2	(2)	(1)	(2)
	400	2	1	1	1145	(1)	(2)
	450	2	1	1	1139	(1)	(2)
	500	3	1	1	1128	1512	(1)
	550	4	1	1	1105	1521	7235
	600	4	1	1	1076	1527	6992
HEB	100 to 450	1	1	1	(1)	(2)	(2)
	500	2	1	1	2001	(1)	(2)
	550	2	1	1	1986	(1)	(2)
	600	3	1	1	1965	2605	(1)
HEM	100 a 600	1	1	1	(1)	(2)	(2)

(1) No top limit for axial force
(2) This cross-section class cannot be reached

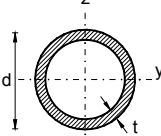

Table 1.11: CLASSIFICATION of S 275 CIRCULAR HOLLOW cross-sections in simple COMPRESSION, in BENDING with M_y and in BENDING with M_z

Cross-section	dimensions		class
	d(mm)	t(mm)	
50·4	50	4	1
60·2	60	2	1
60·3	60	3	1
60·4	60	4	1
75·2	75	2	1
75·3	75	3	1
75·4	75	4	1
75·5	75	5	1
90·2	90	2	2
90·3	90	3	1
90·4	90	4	1
90·5	90	5	1
90·6	90	6	1
94·2	94	2	2
94·3	94	3	1
94·4	94	4	1
94·5	94	5	1
94·6	94	6	1
100·2	100	2	2
100·3	100	3	1
100·4	100	4	1
100·5	100	5	1
100·6	100	6	1
115·2	115	2	2
115·3	115	3	1
115·4	115	4	1
115·5	115	5	1
115·6	115	6	1
115·7	115	7	1
125·3	125	3	1
125·4	125	4	1
125·5	125	5	1
125·6	125	6	1
125·7	125	7	1

Cross-section	dimensions		class
	d(mm)	t(mm)	
135·4	135	4	1
135·5	135	5	1
135·6	135	6	1
135·7	135	7	1
135·8	135	8	1
150·4	150	4	1
150·5	150	5	1
150·6	150	6	1
150·7	150	7	1
150·8	150	8	1
150·9	150	9	1
155·4	155	4	1
155·5	155	5	1
155·6	155	6	1
155·7	155	7	1
155·8	155	8	1
155·9	155	9	1
165·4	165	4	1
165·5	165	5	1
165·6	165	6	1
165·7	165	7	1
165·8	165	8	1
165·9	165	9	1
175·4	175	4	2
175·5	175	5	1
175·6	175	6	1
175·7	175	7	1
175·8	175	8	1
175·9	175	9	1
200·5	200	5	1
200·6	200	6	1
200·7	200	7	1
200·8	200	8	1
200·9	200	9	1

Cross-section	dimensions		class
	d(mm)	t(mm)	
219·5	219	5	2
219·6	219	6	1
219·7	219	7	1
219·8	219	8	1
219·9	219	9	1
244,5·6	244.5	6	1
244,5·8	244.5	8	1
244,5·10	244.5	10	1
244,5·12	244.5	12	1
244,5·14	244.5	14	1
273·6	273	6	2
273·8	273	8	1
273·10	273	10	1
273·12	273	12	1
273·14	273	14	1
323,9·8	323.9	8	1
323,9·10	323.9	10	1
323,9·12	323.9	12	1
323,9·14	323.9	14	1
355,6·8	355.6	8	2
355,6·10	355.6	10	1
355,6·12	355.6	12	1
355,6·14	355.6	14	1
406,4·8	406.4	8	2
406,4·10	406.4	10	1
406,4·12	406.4	12	1
406,4·14	406.4	14	1

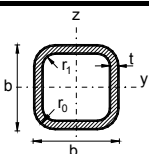
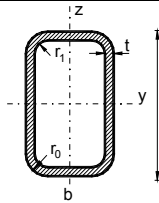

Table 1.12: CLASSIFICATION of S 275 SQUARE HOLLOW cross-sections in simple COMPRESSION, in BENDING with M_y and in BENDING with M_z

Cross-section	dimensions		class
	d(mm)	t(mm)	
40-2	40	2	1
40-3	40	3	1
40-4	40	4	1
50-2	50	2	1
50-3	50	3	1
50-4	50	4	1
60-2	60	2	1
60-3	60	3	1
60-4	60	4	1
60-5	60	5	1
70-2	70	2	2
70-3	70	3	1
70-4	70	4	1
70-5	70	5	1
70-6	70	6	1
75-2	75	2	2
75-3	75	3	1
75-4	75	4	1
75-5	75	5	1
75-6	75	6	1
80-2	80	2	3
80-3	80	3	1
80-4	80	4	1
80-5	80	5	1
80-6	80	6	1
90-2	90	2	4
90-3	90	3	1
90-4	90	4	1
90-5	90	5	1
90-6	90	6	1
90-7	90	7	1

Cross-section	dimensions		class
	d(mm)	t(mm)	
100-3	100	3	1
100-4	100	4	1
100-5	100	5	1
100-6	100	6	1
100-7	100	7	1
110-4	110	4	1
110-5	110	5	1
110-6	110	6	1
110-7	110	7	1
110-8	110	8	1
120-4	120	4	1
120-5	120	5	1
120-6	120	6	1
120-7	120	7	1
120-8	120	8	1
120-9	120	9	1
125-4	125	4	1
125-5	125	5	1
125-6	125	6	1
125-7	125	7	1
125-8	125	8	1
125-9	125	9	1
135-4	135	4	2
135-5	135	5	1
135-6	135	6	1
135-7	135	7	1
135-8	135	8	1
135-9	135	9	1
140-4	140	4	2
140-5	140	5	1
140-6	140	6	1
140-7	140	7	1
140-8	140	8	1
140-9	140	9	1

Cross-section	dimensions		class
	d(mm)	t(mm)	
160-5	160	5	1
160-6	160	6	1
160-7	160	7	1
160-8	160	8	1
160-9	160	9	1
175-5	175	5	2
175-6	175	6	1
175-7	175	7	1
175-8	175	8	1
175-9	175	9	1
180-5	180	5	2
180-6	180	6	1
180-8	180	8	1
180-10	180	10	1
180-12	180	12	1
200-5	200	5	3
200-6	200	6	1
200-8	200	8	1
200-10	200	10	1
200-12	200	12	1
250-5	250	5	4
250-6	250	6	3
250-8	250	8	1
250-10	250	10	1
250-12	250	12	1
260-6	260	6	4
260-10	260	10	1
300-6	300	6	4
300-8	300	8	2
300-10	300	10	1
300-12	300	12	1
350-8	350	8	4
350-10	350	10	2
350-12	350	12	1

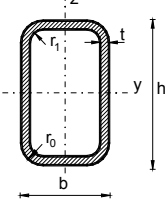

**Table 1.13: CLASSIFICATION of S 275
RECTANGULAR HOLLOW cross-sections
in simple COMPRESSION and in BENDING with My**

Cross-section	dimensions			Class in bending My	Class in compression
	b (mm)	h (mm)	t (mm)		
30·50·2	30	50	2	1	1
30·50·3	30	50	3	1	1
30·50·4	30	50	4	1	1
20·60·2	20	60	2	1	1
20·60·3	20	60	3	1	1
20·60·4	20	60	4	1	1
40·60·2	40	40	2	1	1
40·60·3	40	40	3	1	1
40·60·4	40	40	4	1	1
30·70·2	30	70	2	1	2
30·70·3	30	70	3	1	1
30·70·4	30	70	4	1	1
50·70·2	50	70	2	1	2
50·70·3	50	70	3	1	1
50·70·4	50	70	4	1	1
50·70·5	50	70	5	1	1
40·80·2	40	80	2	1	3
40·80·3	40	80	3	1	1
40·80·4	40	80	4	1	1
40·80·5	40	80	5	1	1
60·80·2	60	80	2	1	3
60·80·3	60	80	3	1	1
60·80·4	60	80	4	1	1
60·80·5	60	80	5	1	1
60·80·6	60	80	6	1	1
50·90·2	50	90	2	1	4
50·90·3	50	90	3	1	1
50·90·4	50	90	4	1	1
50·90·5	50	90	5	1	1
50·90·6	50	90	6	1	1
40·100·2	40	100	2	1	4
40·100·3	40	100	3	1	1
40·100·4	40	100	4	1	1
40·100·5	40	100	5	1	1
40·100·6	40	100	6	1	1
50·90·2	50	90	2	1	4
50·90·3	50	90	3	1	1
50·90·4	50	90	4	1	1
60·90·2	60	90	2	1	4
60·90·3	60	90	3	1	1
60·90·4	60	90	4	1	1
60·90·5	60	90	5	1	1
60·90·6	60	90	6	1	1

Cross-section	dimensions			Class in bending My	Class in compression
	b (mm)	h (mm)	t (mm)		
50·100·2	50	100	2	1	4
50·100·3	50	100	3	1	1
50·100·4	50	100	4	1	1
50·100·5	50	100	5	1	1
50·100·6	50	100	6	1	1
40·110·2	40	110	2	1	4
40·110·3	40	110	3	1	2
40·110·4	40	110	4	1	1
40·110·5	40	110	5	1	1
40·110·6	40	110	6	1	1
60·100·2	60	100	2	1	4
60·100·3	60	100	3	1	1
60·100·4	60	100	4	1	1
60·100·5	60	100	5	1	1
60·100·6	60	100	6	1	1
80·100·2	80	100	2	3	4
80·100·3	80	100	3	1	1
80·100·4	80	100	4	1	1
80·100·5	80	100	5	1	1
80·100·6	80	100	6	1	1
80·100·7	80	100	7	1	1
60·120·2	60	120	2	1	4
60·120·3	60	120	3	1	3
60·120·4	60	120	4	1	1
60·120·5	60	120	5	1	1
60·120·6	60	120	6	1	1
60·120·7	60	120	7	1	1
80·120·3	80	120	3	1	3
80·120·4	80	120	4	1	1
80·120·5	80	120	5	1	1
80·120·6	80	120	6	1	1
80·120·7	80	120	7	1	1
60·140·3	60	140	3	1	4
60·140·4	60	140	4	1	2
60·140·5	60	140	5	1	1
60·140·6	60	140	6	1	1
60·140·7	60	140	7	1	1
50·150·3	50	150	3	1	4
50·150·4	50	150	4	1	2
50·150·5	50	150	5	1	1
50·150·6	50	150	6	1	1
50·150·7	50	150	7	1	1

continued

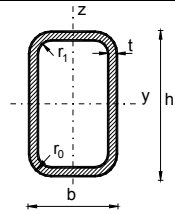

**Table 1.13: CLASSIFICATION of S 275
RECTANGULAR HOLLOW cross-sections
in simple COMPRESSION and in BENDING with My
(continued)**

Cross-section	dimensions			Class in bending My	Class in compression
	b (mm)	h (mm)	t (mm)		
100-120-4	100	120	4	1	1
100-120-5	100	120	5	1	1
100-120-6	100	120	6	1	1
100-120-7	100	120	7	1	1
100-120-8	100	120	8	1	1
80-140-4	80	140	4	1	2
80-140-5	80	140	5	1	1
80-140-6	80	140	6	1	1
80-140-7	80	140	7	1	1
80-140-8	80	140	8	1	1
70-150-4	70	150	4	1	2
70-150-5	70	150	5	1	1
70-150-6	70	150	6	1	1
70-150-7	70	150	7	1	1
70-150-8	70	150	8	1	1
60-160-4	60	160	4	1	3
60-160-5	60	160	5	1	1
60-160-6	60	160	6	1	1
60-160-7	60	160	7	1	1
60-160-8	60	160	8	1	1
100-140-4	100	140	4	1	2
100-140-5	100	140	5	1	1
100-140-6	100	140	6	1	1
100-140-7	100	140	7	1	1
100-140-8	100	140	8	1	1
100-140-9	100	140	9	1	1
90-150-4	90	150	4	1	2
90-150-5	90	150	5	1	1
90-150-6	90	150	6	1	1
90-150-7	90	150	7	1	1
90-150-8	90	150	8	1	1
90-150-9	90	150	9	1	1
80-160-4	80	160	4	1	3
80-160-5	80	160	5	1	1
80-160-6	80	160	6	1	1
80-160-7	80	160	7	1	1
80-160-8	80	160	8	1	1
80-160-9	80	160	9	1	1

Cross-section	dimensions			Class in bending My	Class in compression
	b (mm)	h (mm)	t (mm)		
70-170-4	70	170	4	1	4
70-170-5	70	170	5	1	2
70-170-6	70	170	6	1	1
70-170-7	70	170	7	1	1
70-170-8	70	170	8	1	1
70-170-9	70	170	9	1	1
100-150-4	100	150	4	1	2
100-150-5	100	150	5	1	1
100-150-6	100	150	6	1	1
100-150-7	100	150	7	1	1
100-150-8	100	150	8	1	1
100-150-9	100	150	9	1	1
90-160-4	90	160	4	1	3
90-160-5	90	160	5	1	1
90-160-6	90	160	6	1	1
90-160-7	90	160	7	1	1
90-160-8	90	160	8	1	1
90-160-9	90	160	9	1	1
80-170-4	80	170	4	1	4
80-170-5	80	170	5	1	2
80-170-6	80	170	6	1	1
80-170-7	80	170	7	1	1
80-170-8	80	170	8	1	1
80-170-9	80	170	9	1	1
70-180-4	70	180	4	1	4
70-180-5	70	180	5	1	2
70-180-6	70	180	6	1	1
70-180-7	70	180	7	1	1
70-180-8	70	180	8	1	1
70-180-9	70	180	9	1	1
120-150-4	120	150	4	1	2
120-150-5	120	150	5	1	1
120-150-6	120	150	6	1	1
120-150-7	120	150	7	1	1
120-150-8	120	150	8	1	1
120-150-9	120	150	9	1	1
100-170-4	100	170	4	1	4
100-170-5	100	170	5	1	2
100-170-6	100	170	6	1	1
100-170-7	100	170	7	1	1
100-170-8	100	170	8	1	1
100-170-9	100	170	9	1	1

continued



**TABLE 1.13: CLASSIFICATION of S 275
RECTANGULAR HOLLOW cross-sections
in simple COMPRESSION and in BENDING with My
(continued)**

Cross-section	dimensions			Class in bending My	Class in compression
	b (mm)	h (mm)	t (mm)		
90-180-4	90	180	4	1	4
90-180-5	90	180	5	1	2
90-180-6	90	180	6	1	1
90-180-7	90	180	7	1	1
90-180-8	90	180	8	1	1
90-180-9	90	180	9	1	1
70-200-4	70	200	4	1	4
70-200-5	70	200	5	1	3
70-200-6	70	200	6	1	1
70-200-7	70	200	7	1	1
70-200-8	70	200	8	1	1
70-200-9	70	200	9	1	1
120-160-4	120	160	4	1	3
120-160-5	120	160	5	1	1
120-160-6	120	160	6	1	1
120-160-7	120	160	7	1	1
120-160-8	120	160	8	1	1
120-160-9	120	160	9	1	1
100-180-4	100	180	4	1	4
100-180-5	100	180	5	1	2
100-180-6	100	180	6	1	1
100-180-7	100	180	7	1	1
100-180-8	100	180	8	1	1
100-180-9	100	180	9	1	1
80-200-4	80	200	4	1	4
80-200-5	80	200	5	1	3
80-200-6	80	200	6	1	1
80-200-7	80	200	7	1	1
80-200-8	80	200	8	1	1
80-200-9	80	200	9	1	1
140-180-5	140	180	5	1	2
140-180-6	140	180	6	1	1
140-180-7	140	180	7	1	1
140-180-8	140	180	8	1	1
140-180-9	140	180	9	1	1
120-200-5	120	200	5	1	3
120-200-6	120	200	6	1	1
120-200-7	120	200	7	1	1
120-200-8	120	200	8	1	1
120-200-9	120	200	9	1	1

Cross-section	dimensions			Class in bending My	Class in compression
	b (mm)	h (mm)	t (mm)		
150-200-5	150	200	5	1	3
150-200-6	150	200	6	1	1
150-200-7	150	200	7	1	1
150-200-8	150	200	8	1	1
150-200-9	150	200	9	1	1
100-250-5	100	250	5	1	4
100-250-6	100	250	6	1	3
100-250-7	100	250	7	1	2
100-250-8	100	250	8	1	1
100-250-9	100	250	9	1	1
150-250-5	150	250	5	1	4
150-250-6	150	250	6	1	3
150-250-8	150	250	8	1	1
150-250-10	150	250	10	1	1
150-250-12	150	250	12	1	1
100-300-5	100	300	5	1	4
100-300-6	100	300	6	1	4
100-300-8	100	300	8	1	2
100-300-10	100	300	10	1	1
200-300-6	200	300	6	1	4
200-300-8	200	300	8	1	2
200-300-10	200	300	10	1	1
200-300-12	200	300	12	1	1
200-400-8	200	400	8	1	4
200-400-10	200	400	10	1	3
200-400-12	200	400	12	1	1
200-400-14	200	400	14	1	1
300-400-8	300	400	8	2	4
300-400-10	300	400	10	1	3
300-400-12	300	400	12	1	1
300-400-14	300	400	14	1	1
300-500-8	300	500	8	2	4
300-500-10	300	500	10	1	4
300-500-12	300	500	12	1	3
300-500-14	300	500	14	1	2

GEOMETRICAL PROPERTIES OF HOT ROLLED CROSS SECTIONS

IPE
CROSS SECTIONS

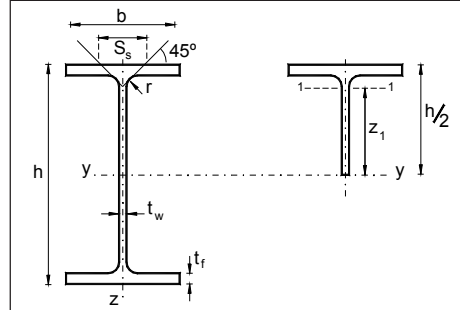

IPE	Dimensions						M Kg/m	painting surface per unit length and unit mass		Half cross-section	
	h mm	b mm	t _w mm	t _f mm	r mm	s _s mm		m ² /m	m ² /T	z ₁ mm	I _{y1} mm ⁴ (x10 ⁶)
80	80	46	3,8	5,2	5	20,1	6,0	0,328	54,8	30,4	0,048
100	100	55	4,1	5,7	7	23,7	8,1	0,400	49,5	38,2	0,101
120	120	64	4,4	6,3	7	25,2	10,4	0,475	45,6	46,1	0,189
140	140	73	4,7	6,9	7	26,7	12,9	0,551	42,6	53,9	0,322
160	160	82	5,0	7,4	9	30,3	15,8	0,623	39,4	69,6	0,532
180	180	91	5,3	8,0	9	31,8	18,8	0,698	37,1	69,6	0,807
200	200	100	5,6	8,5	12	36,7	22,4	0,768	34,3	77,1	1,20
220	220	110	5,9	9,2	12	38,4	26,2	0,848	32,4	85,6	1,60
240	240	120	6,2	9,8	15	43,4	30,7	0,922	30,0	93,6	2,32
270	270	135	6,6	10,2	15	44,6	36,1	1,04	28,8	105	2,43
300	300	150	7,1	10,7	15	46,1	42,2	1,16	27,5	116	5,14
330	330	160	7,5	11,5	18	51,6	49,1	1,25	25,5	128	7,21
360	360	170	8,0	12,7	18	50,5	57,1	1,35	23,6	140	9,79
400	400	180	8,6	13,5	21	60,4	66,3	1,47	22,2	154	14,4
450	450	190	9,4	14,6	21	63,2	77,6	1,61	20,7	172	22,2
500	500	200	10,2	16,0	21	66,8	90,7	1,74	19,2	189	32,4
550	550	210	11,1	17,2	24	73,6	106	1,88	17,7	207	47,2
600	600	220	12,0	19,0	24	78,1	122	2,02	16,6	225	65,5

continued

continued	Geometric properties												IPE
	A mm ²	I _r mm ⁴ (x10 ⁴)	I _y mm ⁴ (x10 ⁶)	W _{el,y} mm ³ (x10 ³)	W _{pl,y} mm ³ (x10 ³)	i _y mm	A _{v,y} mm ²	I _z mm ⁴ (x10 ⁶)	W _{el,z} mm ³ (x10 ³)	W _{pl,z} mm ³ (x10 ³)	i _z mm	A _{v,z} mm ²	
764	0,70	0,80	20,0	23,2	32,4	357	0,085	3,69	5,80	10,5	478	80	
1030	1,20	1,71	34,2	39,4	40,7	506	0,159	5,79	9,20	12,4	627	100	
1320	1,74	3,18	53,0	60,8	49,0	630	0,277	8,65	13,6	14,5	806	120	
1640	2,45	5,41	77,3	88,4	57,4	762	0,449	12,3	19,2	16,5	1010	140	
2010	3,60	8,69	109	124	65,8	967	0,683	16,7	26,1	18,4	1210	160	
2390	4,79	13,2	146	166	74,2	1120	1,01	22,2	34,6	20,5	1460	180	
2850	6,98	19,4	194	220	82,6	1400	1,42	28,5	44,7	22,4	1700	200	
3340	9,07	27,7	252	286	91,1	1590	2,05	37,3	58,0	24,8	2020	220	
3910	12,88	38,9	324	366	99,7	1910	2,84	47,3	74,0	26,9	2350	240	
4590	15,94	57,9	429	484	112	2210	4,20	62,2	97,0	30,2	2750	270	
5380	20,12	83,6	557	628	125	2570	6,04	80,5	125	33,5	3210	300	
6260	28,15	118	713	804	137	3080	7,88	98,5	154	35,5	3680	330	
7270	37,32	163	904	1020	150	3510	10,4	123	191	37,9	4320	360	
8450	51,08	231	1160	1310	165	4270	13,2	146	229	39,5	4860	400	
9880	66,87	337	1500	1700	185	5080	16,8	176	275	41,2	5550	450	
11600	89,29	482	1930	2200	204	6040	21,4	214	336	43,1	6400	500	
13400	123,2	671	2440	2780	223	7190	26,7	254	401	44,5	7224	550	
15600	165,4	921	3070	3520	243	8380	33,9	308	486	46,6	8360	600	

IPN

CROSS SECTIONS

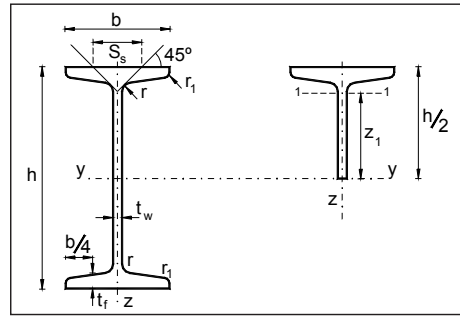

IPN	Dimensions						M Kg/m	painting surface per unit length and unit mass		Half cross section	
	h mm	b mm	t _w =r mm	t _f mm	r ₁ mm	s _s mm		m ² /m	m ² /T	z ₁ mm	I _{y1} mm ⁴ (x10 ⁶)
80	80	42	3,9	5,9	2,3	21,7	5,94	0,304	51,2	30,1	0,045
100	100	50	4,5	6,8	2,7	25,1	8,34	0,370	44,4	37,5	0,107
120	120	58	5,1	7,7	3,1	28,5	11,1	0,439	39,5	44,8	0,215
140	140	66	5,7	8,6	3,4	31,9	14,3	0,502	35,1	52,4	0,361
160	160	74	6,3	9,5	3,8	35,3	17,9	0,575	32,1	59,6	0,618
180	180	82	6,9	10,4	4,1	38,8	21,9	0,640	29,2	67,0	0,996
200	200	90	7,5	11,3	4,5	42,2	26,2	0,709	27,0	74,9	1,34
220	220	98	8,1	12,2	4,9	45,6	31,1	0,775	24,9	82,0	2,01
240	240	106	8,7	13,1	5,2	49,0	36,2	0,844	23,3	89,3	2,83
260	260	113	9,4	14,1	5,6	52,8	41,9	0,906	21,6	96,4	3,91
280	280	119	10,1	15,2	6,1	56,6	47,9	0,966	20,1	103	3,21
300	300	125	10,8	16,2	6,5	60,3	54,2	1,03	19,0	110	6,92
320	320	131	11,5	17,3	6,9	64,1	61,0	1,09	17,9	117	8,79
340	340	137	12,2	18,3	7,3	67,8	68,0	1,15	16,9	124	11,2
360	360	143	13,0	19,5	7,8	72,0	76,1	1,21	15,9	131	14,1
380	380	149	13,7	20,5	8,2	75,7	84,0	1,27	15,1	138	17,4
400	400	155	14,4	21,6	8,6	80,0	92,4	1,33	14,4	145	21,6
450	450	170	16,2	24,3	9,7	89,2	115	1,48	12,9	163	33,3
500	500	185	18,0	27,0	10,8	98,8	141	1,63	11,5	181	50,5
550	550	200	19,0	30,0	11,9	108	166	1,79	10,8	200	71,9
600	600	215	21,6	32,4	13,0	118	199	1,93	9,7	215	108

continued

Geometric properties													IPN
A mm ²	I _T mm ⁴ (x10 ⁴)	I _y mm ⁴ (x10 ⁶)	W _{el,y} mm ³ (x10 ³)	W _{pl,y} mm ³ (x10 ³)	i _y mm	A _{v,y} mm ²	I _z mm ⁴ (x10 ⁶)	W _{el,z} mm ³ (x10 ³)	W _{pl,z} mm ³ (x10 ³)	i _z mm	A _{v,z} mm ²		
757	0,87	0,78	19,5	22,8	32,0	330	0,063	3,0	5,0	9,1	496	80	
1060	1,60	1,71	34,2	39,8	40,1	472	0,122	4,9	8,1	10,7	680	100	
1420	2,71	3,28	54,7	63,6	48,1	645	0,215	7,4	12,4	12,3	893	120	
1820	4,32	5,73	81,9	95,4	56,1	832	0,352	10,7	17,9	14,0	1140	140	
2280	6,57	9,35	117	136	64,0	1050	0,547	14,8	24,8	15,5	1410	160	
2790	9,58	14,5	161	187	72,0	1300	0,813	19,8	33,3	17,1	1710	180	
3340	13,5	21,4	214	250	80,0	1560	1,17	26,0	43,6	18,7	2030	200	
3950	18,6	30,6	278	324	88,0	1860	1,62	33,1	55,7	20,2	2390	220	
4610	25,0	42,5	354	412	95,9	2170	2,21	41,7	70,0	22,0	2780	240	
5330	33,5	57,4	442	514	104	2540	2,88	51,0	85,9	23,2	3190	260	
6100	44,2	75,9	542	632	111	2940	3,64	61,2	103	24,5	3620	280	
6900	56,8	98,0	653	762	119	3370	4,51	72,2	122	25,6	4050	300	
7770	72,5	125	782	914	127	3830	5,55	84,7	143	26,7	4530	320	
8670	90,4	157	923	1080	135	4330	6,74	98,4	166	28,0	5010	340	
9700	115	196	1090	1280	142	4930	8,18	114	194	29,0	5580	360	
10700	141	240	1260	1480	150	5600	9,75	131	222	30,2	6110	380	
11800	170	292	1460	1710	157	6040	11,6	149	254	31,3	6700	400	
14700	267	458	2040	2400	177	7620	17,3	203	345	34,3	8260	450	
17900	402	687	2750	3240	196	9370	24,8	268	456	37,2	9990	500	
21200	544	992	3610	4240	216	10900	34,9	349	560	40,2	12000	550	
25400	787	1390	4630	5600	234	13600	46,7	434	670	43,0	13900	600	

continued

HEA

CROSS SECTIONS

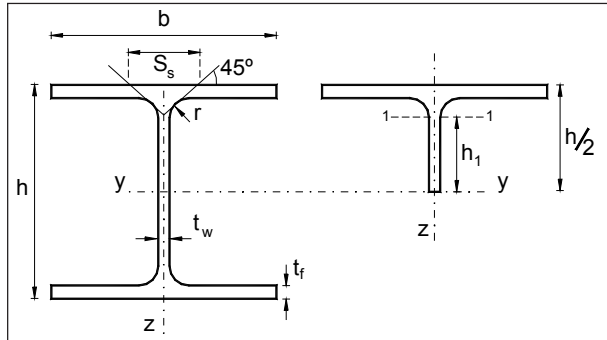

HEA	Dimensions						M Kg/m	painting surface per unit length and unit mass		Half cross section	
	h mm	b mm	tw mm	tf mm	r mm	ss mm		m ² /m	m ² /T	z ₁ mm	I _{y1} ⁴ mm ⁴ (x10 ⁶)
100	96	100	5,0	8,0	12	35,1	16,7	0,561	33,6	39,2	0,116
120	114	120	5,0	8,0	12	35,1	19,9	0,677	34,0	47,2	0,212
140	133	140	5,5	8,5	12	36,6	24,7	0,794	32,1	55,2	0,381
160	152	160	6,0	9,0	15	41,6	30,4	0,906	29,8	63,4	0,567
180	171	180	6,0	9,5	15	42,6	35,5	1,02	28,7	71,5	0,971
200	190	200	6,5	10,0	18	47,6	42,3	1,14	26,9	79,9	1,29
220	210	220	7,0	11,0	18	50,5	50,5	1,26	24,9	88,3	1,98
240	230	240	7,5	12,0	21	56,1	60,3	1,37	22,7	96,9	2,76
260	250	260	7,5	12,5	24	60,6	68,2	1,48	21,7	106	3,51
280	270	280	8,0	13,0	24	62,1	76,4	1,60	21,0	114	5,14
300	290	300	8,5	14,0	27	68,1	88,3	1,72	19,5	123	6,21
320	310	300	9,0	15,5	27	71,6	97,6	1,76	18,0	131	7,90
340	330	300	9,5	16,5	27	74,1	105	1,79	17,1	139	9,50
360	350	300	10,0	17,5	27	76,6	112	1,83	16,4	146	13,3
400	390	300	11,0	19,0	27	79,6	125	1,91	15,3	161	19,3
450	440	300	11,5	21,0	27	85,1	140	2,01	14,4	181	27,0
500	490	300	12,0	23,0	27	89,6	155	2,11	13,6	200	39,9
550	540	300	12,5	24,0	27	92,1	166	2,21	13,3	218	56,4
600	590	300	13,0	25,0	27	94,6	178	2,31	13,0	237	71,3

continued

Geometric properties													HEA
A mm ²	I _T mm ⁴ (x10 ⁴)	I _y mm ⁴ (x10 ⁶)	W _{el,y} mm ³ (x10 ³)	W _{pl,y} mm ³ (x10 ³)	i _y mm	A _{v,y} mm ²	I _z mm ⁴ (x10 ⁶)	W _{el,z} mm ³ (x10 ³)	W _{pl,z} mm ³ (x10 ³)	i _z mm	A _{v,z} mm ²		
2120	4,83	3,49	73	83	40,6	752	1,34	26,8	41,2	25,1	1600	100	
2530	5,81	6,06	106	119	48,9	842	2,31	38,5	58,9	30,2	1920	120	
3140	8,22	10,3	155	173	57,3	1010	3,89	55,6	84,7	35,2	2380	140	
3880	11,30	16,7	220	246	65,7	1320	6,16	76,9	118	39,8	2880	160	
4530	14,70	25,1	294	324	74,5	1450	9,25	103	157	45,2	3420	180	
5380	19,20	36,9	389	430	82,8	1810	13,4	134	204	49,8	4000	200	
6430	28,00	54,1	515	568	91,7	2060	19,5	178	271	55,1	4840	220	
7680	39,40	77,6	675	744	101	2510	27,7	231	352	60,0	5760	240	
8680	47,80	104,5	836	920	110	2870	36,7	282	430	65,0	6500	260	
9730	58,30	136,7	1010	1110	119	3180	47,6	340	518	70,0	7280	280	
11300	77,70	182,6	1260	1380	127	3780	63,1	421	642	74,9	8400	300	
12400	105	229,3	1480	1630	136	4080	69,9	466	710	74,9	9300	320	
13300	127	276,9	1680	1850	144	4450	74,4	496	756	74,6	9900	340	
14300	152	330,9	1890	2080	152	4920	78,9	526	803	74,3	10500	360	
15900	197	450,7	2310	2560	168	5740	85,6	571	873	73,4	11400	400	
17800	265	637,2	2900	3220	189	6580	94,7	631	966	72,9	12600	450	
19800	347	869,7	3550	3940	210	7520	104	691	1060	72,4	13800	500	
21200	398	1119	4150	4620	230	8400	108	721	1110	71,5	14400	550	
22600	454	1412	4790	5360	250	9280	113	751	1160	70,5	15000	600	

continued

HEB

CROSS SECTIONS

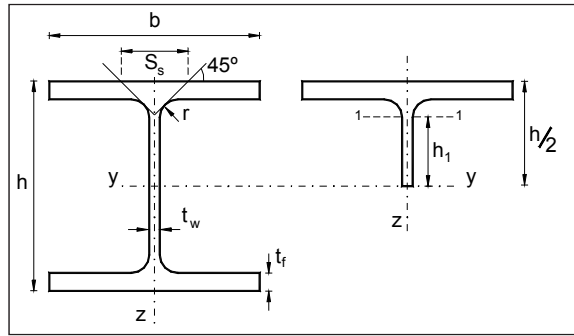

HEB	Dimensions						M Kg/m	painting surface per unit length and unit mass		Half cross section	
	h	b	t _w	t _f	r	s _s		m ² /m	m ² /T	z ₁ mm	I _{y1} mm ⁴ (10 ⁶)
	mm	mm	mm	mm	mm	mm					
100	100	100	6	10	12	40,1	20,4	0,567	27,8	40,1	0,162
120	120	120	6,5	11	12	42,6	26,7	0,686	25,7	48,6	0,307
140	140	140	7	12	12	45,1	33,7	0,805	23,9	57,2	0,508
160	160	160	8	13	15	51,6	42,6	0,918	21,5	65,2	0,921
180	180	180	8,5	14	15	54,1	51,2	1,04	20,3	73,8	1,36
200	200	200	9	15	18	60,1	61,3	1,15	18,8	82,2	2,09
220	220	220	9,5	16	18	62,6	71,5	1,27	17,8	91,0	2,79
240	240	240	10	17	21	68,6	83,2	1,38	16,6	99,4	3,89
260	260	260	10	17,5	24	73,1	93,0	1,50	16,1	108	5,19
280	280	280	10,5	18	24	74,6	103	1,62	15,7	117	6,81
300	300	300	11	19	27	80,6	117	1,73	14,8	125	8,81
320	320	300	11,5	20,5	27	84,1	127	1,77	13,9	133	11,1
340	340	300	12	21,5	27	86,6	134	1,81	13,5	140	13,7
360	360	300	12,5	22,5	27	89,1	142	1,85	13,0	148	16,8
400	400	300	13,5	24	27	93,1	155	1,93	12,4	164	24,2
450	450	300	14	26	27	98,0	171	2,03	11,9	183	35,8
500	500	300	14,5	28	27	102	187	2,12	11,3	202	49,9
550	550	300	15	29	27	105	199	2,22	11,2	220	68,1
600	600	300	15,5	30	27	107	212	2,32	11,0	238	90,9

continued

Geometric properties												HEB
A mm ²	I _T mm ⁴ (x10 ⁴)	I _y mm ⁴ (x10 ⁶)	W _{el,y} mm ³ (x10 ³)	W _{pl,y} mm ³ (x10 ³)	i _y mm	A _{v,y} mm ²	I _z mm ⁴ (x10 ⁶)	W _{el,z} mm ³ (x10 ³)	W _{pl,z} mm ³ (x10 ³)	i _z mm	A _{v,z} mm ²	
2600	9,34	4,52	90	104	41,6	900	1,67	33	51	25,3	2000	100
3400	14,90	8,64	144	165	50,4	1100	3,18	53	81	30,6	2640	120
4300	22,50	15,1	216	246	59,3	1310	5,50	79	120	35,8	3360	140
5430	33,20	24,9	311	354	67,8	1760	8,89	111	170	40,5	4160	160
6530	46,50	38,3	426	482	76,6	2030	13,6	151	231	45,7	5040	180
7810	63,40	57,0	570	642	85,4	2490	20,0	200	306	50,7	6000	200
9100	84,40	80,9	736	828	94,3	2790	28,4	258	394	55,9	7040	220
10600	110	113	938	1050	103	3320	39,2	327	499	60,8	8160	240
11800	130	149	1150	1280	112	3720	51,3	395	603	65,8	9100	260
13100	153	193	1380	1530	121	4070	65,9	471	718	70,9	10100	280
14900	192	252	1680	1870	130	4740	85,6	571	871	75,8	11400	300
16100	241	308	1930	2140	138	5140	92,4	616	940	75,7	12300	320
17100	278	367	2160	2400	146	5620	96,9	646	986	75,3	12900	340
18100	320	432	2400	2680	155	6100	101	676	1030	74,9	13500	360
19800	394	577	2880	3240	171	7020	108	721	1100	74,0	14400	400
21800	500	799	3550	3980	191	7970	117	781	1200	73,3	15600	450
23900	625	1072	4290	4820	212	9020	126	842	1290	72,7	16800	500
25400	701	1367	4970	5600	232	10000	131	872	1340	71,7	17400	550
27000	783	1710	5700	6420	252	11100	135	902	1390	70,8	18000	600

continued

HEM

CROSS SECTIONS

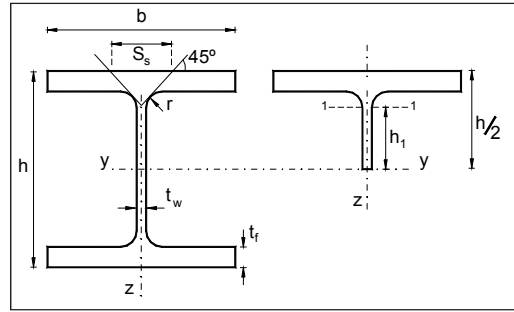

HEM	Dimensions						M Kg/m	painting surface per unit length and unit mass		Half cross section	
	h	b	t _w	t _f	r	s _s		m ² /m	m ² /T	z ₁ mm	I _{y1} mm ⁴ (x10 ⁶)
	mm	mm	mm	mm	mm	mm					
100	120	106	12	20	12	66,1	41,8	0,610	14,8	44,4	0,456
120	140	126	12,5	21	12	68,6	52,1	0,738	14,2	52,7	0,879
140	160	146	13	22	12	73,1	63,2	0,857	13,6	61,3	1,31
160	180	166	14	23	15	77,6	76,2	0,970	12,7	69,4	2,12
180	200	186	14,5	24	15	80,1	88,9	1,09	12,3	78,2	2,85
200	220	206	15	25	18	86,1	103	1,20	11,7	86,7	3,96
220	240	226	15,5	26	18	88,6	117	1,32	11,3	95,3	5,34
240	270	248	18	32	21	107	157	1,46	9,30	106	9,09
260	290	268	18	32,5	24	111	172	1,57	9,13	115	11,1
280	310	288	18,5	33	24	113	189	1,69	8,94	123	16,2
300	340	310	21	39	27	131	238	1,83	7,70	135	19,9
320	359	309	21	40	27	133	245	1,87	7,63	142	26,1
340	377	309	21	40	27	133	248	1,90	7,67	149	31,1
360	395	308	21	40	27	133	250	1,93	7,77	156	36,2
400	432	307	21	40	27	133	256	2,00	7,81	171	43,9
450	478	307	21	40	27	133	263	2,10	7,97	189	59,2
500	524	306	21	40	27	133	270	2,18	8,07	206	79,6
550	572	306	21	40	27	133	278	2,28	8,20	224	102
600	620	305	21	40	27	133	285	2,37	8,32	241	130

continued

Geometric properties													HEM
A mm ²	I _T mm ⁴ (x10 ⁴)	I _y mm ⁴ (x10 ⁶)	W _{el,y} mm ³ (x10 ³)	W _{pl,y} mm ³ (x10 ³)	i _y mm	A _{v,y} mm ²	I _z mm ⁴ (x10 ⁶)	W _{el,z} mm ³ (x10 ³)	W _{pl,z} mm ³ (x10 ³)	i _z mm	A _{v,z} mm ²		
5320	78,9	11,4	190	236	46,3	1800	4,0	75	116	27,4	4240	100	
6640	109	20,2	288	350	55,1	2110	7,0	112	171	32,5	5292	120	
8060	145	32,9	411	494	63,9	2450	11,4	157	240	37,7	6720	140	
9710	190	51,0	566	674	72,5	3090	17,6	212	324	42,6	7640	160	
11300	241	74,8	748	884	81,3	3440	25,8	277	424	47,7	8930	180	
13100	301	106	967	1136	90,0	4080	36,5	354	541	52,7	10300	200	
14900	372	146	1220	1420	98,9	4490	50,1	444	677	57,9	11800	220	
20000	751	243	1800	2120	110	6050	81,5	657	1000	63,9	15400	240	
22000	848	313	2160	2520	119	6730	105	780	1190	69,0	17420	260	
24000	957	396	2550	2960	128	7190	132	914	1390	74,0	19010	280	
30300	1690	592	3480	4080	140	9050	194	1250	1910	80,0	24200	300	
31200	1810	681	3800	4440	148	9480	197	1280	1940	79,5	24700	320	
31600	1820	764	4050	4720	156	9880	197	1280	1950	79,0	24700	340	
31900	1820	849	4300	4980	163	10300	195	1270	1940	78,3	24600	360	
32600	1830	1040	4820	5580	179	11000	193	1260	1930	77,0	24600	400	
33500	1850	1320	5500	6340	198	11900	193	1260	1930	75,9	24600	450	
34400	1860	1620	6180	7100	217	12900	192	1250	1930	74,6	24500	500	
35400	1880	1980	6920	7940	236	13900	192	1250	1930	73,5	24500	550	
36400	1890	2370	7660	8780	256	15000	190	1240	1930	72,2	24400	600	

continued

UPN

CROSS SECTIONS

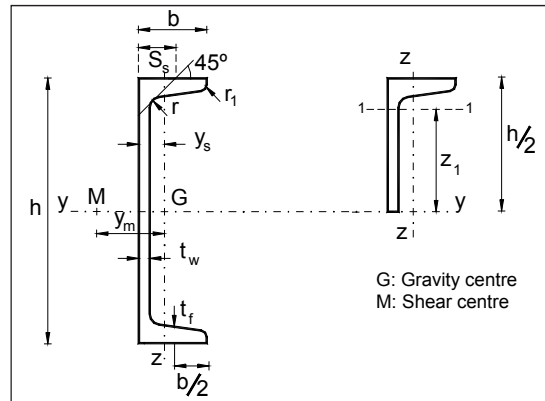

UPN	Dimensions						M Kg/m	painting surface per unit length and unit mass		Half section	
	h	b	t _w	t _f =r	r ₁	s _p		m ² /m	m ² /T	z ₁ mm	I _{y1} mm ⁴ (10 ⁶)
	mm	mm	mm	mm	mm	mm					
80	80	45	6	8	4	19,4	8,64	0,312	36,1	28,9	0,071
100	100	50	6	8,5	4,5	20,4	10,6	0,372	35,1	36,3	0,141
120	120	55	7	9	4,5	22,2	13,4	0,434	32,4	42,7	0,270
140	140	60	7	10	5	23,9	16,0	0,489	30,6	50,4	0,434
160	160	65	7,5	10,5	5,5	25,3	18,8	0,546	29,0	57,3	0,685
180	180	70	8	11	5,5	26,8	22,0	0,611	27,8	64,0	1,02
200	200	75	8,5	11,5	6	28,2	25,3	0,661	26,1	70,8	1,48
220	220	80	9	12,5	6,5	30,3	29,4	0,718	24,4	78,1	2,04
240	240	85	9,5	13	6,5	31,8	33,2	0,775	23,3	84,6	2,86
260	260	90	10	14	7	33,9	37,9	0,834	22,0	91,5	3,88
280	280	95	10	15	7,5	35,6	41,8	0,890	21,3	99,8	4,86
300	300	100	10	16	8	37,3	46,2	0,950	20,6	107	6,49
320	320	100	14	17,5	17,5	42,7	59,2	0,982	16,5	109	9,32
350	350	100	14	16	8	40,4	60,6	1,05	17,3	119	9,47
380	380	102	13,5	16	8	40,0	63,1	1,11	17,7	126	15,0
400	400	110	14	18	9	43,7	71,8	1,18	16,5	136	17,1

continued

continued	Geometric properties													UPN
	A mm ²	y _s mm	y _m mm	I _y mm ⁴ (x10 ⁶)	W _{el,y} mm ³ (x10 ³)	W _{pl,y} mm ³ (x10 ³)	i _y mm	A _{v,y} mm ²	I _z mm ⁴ (x10 ⁶)	W _{el,z} mm ³ (x10 ³)	W _{pl,z} mm ³ (x10 ³)	i _z mm	A _{v,z} mm ²	
1100	14,2	26,5	1,06	26,5	31,8	31,0	492	0,194	6,36	16,6	13,3	720	80	
1350	15,5	29,3	2,06	41,2	49,0	39,1	623	0,293	8,49	22,3	14,7	850	100	
1700	16,0	30,3	3,64	60,7	72,6	46,2	854	0,432	11,1	30,2	15,9	990	120	
2040	17,5	33,7	6,05	86,4	103	54,5	1010	0,627	14,8	40,0	17,5	1200	140	
2400	18,4	35,6	9,25	116	138	62,1	1220	0,853	18,3	50,2	18,9	1370	160	
2800	19,2	37,5	13,5	150	179	69,5	1470	1,14	22,4	62,4	20,2	1540	180	
3220	20,1	39,4	19,1	191	228	77,0	1720	1,48	27,0	72,6	21,4	1730	200	
3740	21,4	42,0	26,9	245	292	84,8	2010	1,97	33,6	94,2	23,0	2000	220	
4230	22,3	43,9	36,0	300	358	92,2	2310	2,48	39,6	112	24,2	2210	240	
4830	23,6	46,6	48,2	371	442	99,9	2650	3,17	47,7	136	25,6	2520	260	
5330	25,3	50,2	62,8	448	532	109	2860	3,99	57,2	160	27,4	2850	280	
5880	27,0	54,1	80,3	535	632	117	3100	4,95	67,8	188	29,0	3200	300	
7580	26,0	48,2	109	679	826	121	4630	5,97	86,6	215	28,1	3500	320	
7730	24,0	44,5	128	734	918	129	5010	5,70	75,0	205	27,2	3200	350	
8040	23,8	45,8	158	826	1010	140	5250	6,13	78,7	214	27,7	3260	380	
9150	26,5	51,1	203	1020	1240	149	5770	8,46	102	279	30,4	3960	400	

L

EQUAL LEG ANGLES

CROSS SECTIONS

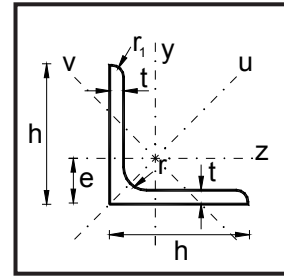

L	Dimensions				M Kg/ m	painting surface per unit length and unit mass		Geometric properties									
	h mm	t mm	r mm	r ₁ mm		m ² /m	m ² /T	A mm ²	I _y mm ⁴ (x10 ⁶)	W _{el,y} mm ³ (x10 ³)	i _y mm	e mm	I _u mm ⁴ (x10 ⁶)	i _u mm	I _v mm ⁴ (x10 ⁶)	i _v mm	
40-4	40	4	6	3	2,42	0,155	64,2	308	0,0448	1,56	12,1	11,2	0,0709	15,2	0,0186	7,8	
40-6	40	6	6	3	3,52	0,155	44,0	438	0,0631	2,26	11,9	12,0	0,0998	14,9	0,0265	7,7	
45-5	45	5	7	3,5	3,38	0,174	51,5	430	0,0783	2,43	13,5	12,8	0,124	17,0	0,0325	8,7	
50-5	50	5	7	3,5	3,77	0,194	51,5	480	0,110	3,05	15,1	14,0	0,174	19,0	0,0454	9,7	
50-7	50	7	7	3,5	5,15	0,194	37,7	656	0,146	4,15	14,9	14,9	0,231	18,8	0,0610	9,6	
55-6	55	6	8	4	4,95	0,213	43,0	631	0,173	4,40	16,6	15,6	0,274	20,8	0,0724	10,7	
60-6	60	6	8	4	5,42	0,233	43,0	691	0,228	5,29	18,2	16,9	0,362	22,9	0,0943	11,7	
60-8	60	8	8	4	7,09	0,233	32,9	903	0,291	6,88	18,0	17,7	0,462	22,6	0,121	11,6	
65-7	65	7	9	4,5	6,83	0,252	36,9	870	0,334	7,18	19,6	18,5	0,530	24,7	0,138	12,6	
70-7	70	7	9	4,5	7,38	0,272	36,9	940	0,424	8,43	21,2	19,7	0,671	26,7	0,175	13,6	
70-9	70	9	9	4,5	9,34	0,272	29,1	1190	0,526	10,6	21,0	20,5	0,831	26,4	0,220	13,6	
75-8	75	8	10	5	9,03	0,291	32,2	1150	0,589	11,0	22,6	21,3	0,933	28,5	0,244	14,6	
80-8	80	8	10	5	9,66	0,311	32,2	1230	0,723	12,6	24,2	22,6	1,15	30,6	0,298	15,5	
80-10	80	10	10	5	11,9	0,311	26,1	1510	0,875	15,5	24,1	23,4	1,39	30,3	0,363	15,5	
80-12	80	12	10	5	14,0	0,311	22,1	1790	1,02	18,2	23,9	24,1	1,61	30,0	0,427	15,5	
90-9	90	9	11	5,5	12,2	0,351	28,8	1550	1,16	18,0	27,4	25,4	1,84	34,5	0,478	17,6	
90-11	90	11	11	5,5	14,7	0,351	23,9	1870	1,38	21,6	27,2	26,2	2,18	34,0	0,571	17,5	
100-8	100	8	12	6	12,2	0,390	32,0	1550	1,45	19,9	30,6	27,4	2,30	38,5	0,598	19,6	
100-10	100	10	12	6	15,1	0,390	25,8	1920	1,77	24,7	30,4	28,2	2,80	38,3	0,729	19,5	
100-12	100	12	12	6	17,8	0,390	21,9	2270	2,07	29,2	30,2	29,0	3,28	38,0	0,857	19,4	
110-10	110	10	12	6	16,6	0,430	25,9	2120	2,39	30,1	33,6	30,7	3,79	42,3	0,986	21,6	
120-11	120	11	13	6,5	19,9	0,469	23,6	2540	3,41	39,5	36,6	33,6	5,41	46,2	1,40	23,5	
120-13	120	13	13	6,5	23,3	0,469	20,1	2970	3,94	46,0	36,4	34,4	6,25	45,9	1,62	23,4	
120-15	120	15	13	6,5	26,6	0,469	17,6	3390	4,46	52,5	36,3	35,1	7,05	45,6	1,85	23,3	
130-12	130	12	14	7	23,6	0,508	21,5	3000	4,72	50,4	39,7	36,4	7,50	50,0	1,94	25,4	
130-14	130	14	14	7	27,2	0,508	18,7	3470	5,40	58,2	39,4	37,2	8,57	49,7	2,23	25,3	
140-13	140	13	15	7,5	27,5	0,547	19,9	3500	6,38	63,3	42,7	39,2	10,1	53,8	2,62	27,4	
140-15	140	15	15	7,5	31,4	0,547	17,4	4000	7,23	72,3	42,5	40,0	11,5	53,6	2,98	27,3	
150-12	150	12	16	8	27,3	0,586	21,5	3480	7,37	67,7	46,0	41,2	11,7	58,0	3,03	29,5	
150-14	150	14	16	8	31,6	0,586	18,5	4030	8,45	78,2	45,8	42,1	13,4	57,7	3,47	29,4	
150-16	150	16	16	8	35,9	0,586	16,3	4570	9,49	88,7	45,6	42,9	15,1	57,4	3,91	29,3	
160-15	160	15	17	8,5	36,2	0,625	17,3	4610	11,0	95,6	48,8	44,9	17,5	61,5	4,53	31,4	
160-17	160	17	17	8,5	40,7	0,625	15,4	5180	12,3	108	48,6	45,7	19,5	61,3	5,06	31,3	
180-16	180	16	18	9	43,5	0,705	16,2	5540	16,8	130	55,1	50,2	26,9	69,6	6,79	35,0	
180-18	180	18	18	9	48,6	0,705	14,5	6190	18,7	145	54,9	51,0	29,6	69,2	7,57	34,9	
200-16	200	16	18	9	48,5	0,785	16,2	6180	23,4	162	61,5	55,2	37,2	77,6	9,59	39,4	
200-18	200	18	18	9	54,3	0,785	14,5	6910	26,0	181	61,3	56,0	41,3	77,3	10,7	39,3	
200-20	200	20	18	9	59,9	0,785	13,1	7640	28,5	199	61,1	56,8	45,4	77,0	11,7	39,2	

CIRCULAR HOLLOW CROSS SECTIONS

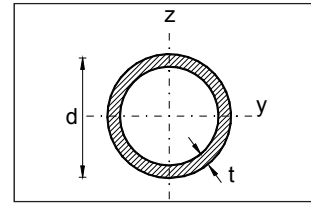

Cross section	Dimensions		M Kg/m	painting surface per unit length and unit mass		Geometric Properties					
	d mm	t mm		S_m m ² /m	S_t m ² /T	A mm ²	A_v mm ²	I mm ⁴ ($\times 10^6$)	W_{el} mm ³ ($\times 10^3$)	W_{pl} mm ³ ($\times 10^3$)	i mm
50-2	50	2	2,36	0,156	66,3	301	192	0,087	3,48	4,60	16,9
50-3	50	3	3,47	0,156	45,1	442	281	0,122	4,91	6,62	16,6
50-4	50	4	4,53	0,156	34,6	578	368	0,154	6,16	8,46	16,3
60-2	60	2	2,86	0,188	65,8	364	232	0,153	5,11	6,72	20,5
60-3	60	3	4,21	0,188	44,6	537	342	0,218	7,29	9,74	20,1
60-4	60	4	5,52	0,188	34,1	703	448	0,277	9,24	12,5	19,8
75-2	75	2	3,60	0,235	65,4	458	292	0,305	8,15	10,6	25,8
75-3	75	3	5,32	0,235	44,2	678	432	0,440	11,7	15,5	25,4
75-4	75	4	7,00	0,235	33,6	892	568	0,563	15,0	20,1	25,1
75-5	75	5	8,63	0,235	27,2	1100	700	0,676	18,0	24,5	24,8
90-2	90	2	4,34	0,283	65,1	552	351	0,535	11,9	15,4	31,1
90-3	90	3	6,43	0,283	43,9	819	521	0,77	17,2	22,7	30,7
90-4	90	4	8,48	0,283	33,3	1080	688	1,0	22,2	29,5	30,4
90-5	90	5	10,4	0,283	26,9	1340	853	1,21	26,8	36,1	30,1
90-6	90	6	12,4	0,283	22,7	1580	1010	1,40	31,1	42,3	29,7
94-2	94	2	4,53	0,293	65,0	578	368	0,61	13,0	16,9	32,5
94-3	94	3	6,73	0,293	43,8	857	546	0,89	18,9	24,8	32,1
94-4	94	4	8,87	0,293	33,2	1130	719	1,14	24,4	32,3	31,8
94-5	94	5	11,0	0,293	26,9	1400	891	1,38	29,5	39,6	31,5
94-6	94	6	13,0	0,293	22,6	1660	1060	1,61	34,3	46,4	31,1
100-2	100	2	4,83	0,312	64,9	615	392	0,73	14,7	19,2	34,6
100-3	100	3	7,17	0,312	43,7	914	582	1,07	21,5	28,2	34,3
100-4	100	4	9,47	0,312	33,1	1210	770	1,39	27,8	36,8	33,9
100-5	100	5	11,7	0,312	26,8	1490	949	1,68	33,7	45,1	33,6
100-6	100	6	13,9	0,312	22,5	1770	1130	1,96	39,2	53,0	33,3
115-2	115	2	5,57	0,361	64,8	710	452	1,13	19,7	25,5	39,9
115-3	115	3	8,28	0,361	43,6	1060	675	1,65	28,8	37,6	39,6
115-4	115	4	10,9	0,361	32,9	1390	885	2,15	37,4	49,2	39,2
115-5	115	5	13,6	0,361	26,6	1730	1100	2,61	45,5	60,5	38,9
115-6	115	6	16,1	0,361	22,4	2050	1310	3,06	53,2	71,2	38,5
115-7	115	7	18,6	0,361	19,3	2380	1520	3,47	60,4	81,6	38,2
125-3	125	3	9,02	0,392	43,5	1150	730	2,14	34,2	44,6	43,1
125-4	125	4	11,9	0,392	32,8	1520	970	2,78	44,5	58,5	42,8
125-5	125	5	14,8	0,392	26,5	1880	1200	3,39	54,3	72,0	42,4
125-6	125	6	17,6	0,392	22,3	2240	1430	3,98	63,6	84,9	42,1
125-7	125	7	20,4	0,392	19,2	2590	1660	4,53	72,5	97,4	41,7
135-4	135	4	12,9	0,423	32,8	1650	1050	3,53	52,3	68,6	46,3
135-5	135	5	16,0	0,423	26,4	2040	1290	4,32	64,0	84,5	45,9
135-6	135	6	19,1	0,423	22,2	2430	1550	5,06	75,0	99,8	45,6
135-7	135	7	22,1	0,423	19,1	2810	1790	5,78	85,6	114	45,3
135-8	135	8	25,1	0,423	16,9	3190	2030	6,46	95,7	129	44,9
150-4	150	4	14,4	0,471	32,7	1830	1170	4,89	65,2	85,0	51,6
150-5	150	5	17,9	0,471	26,3	2280	1470	5,99	79,9	105	51,2
150-6	150	6	21,3	0,471	22,1	2710	1730	7,04	93,9	124	50,9
150-7	150	7	24,7	0,471	19,0	3140	2000	8,05	107	143	50,6
150-8	150	8	28,0	0,471	16,8	3570	2270	9,02	120	161	50,2
150-9	150	9	31,3	0,471	15,0	3990	2540	9,94	132	178	49,9

continued

CIRCULAR HOLLOW CROSS SECTIONS

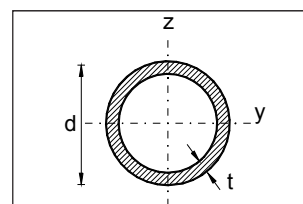

continued											
Cross section	Dimensions		M Kg/m	painting surface per unit length and unit mass		Geometric properties					
	d mm	t mm		S _m m ² /m	S _t m ² /T	A mm ²	A _v mm ²	I mm ⁴ (x10 ⁶)	W _{el} mm ³ (x10 ³)	W _{pl} mm ³ (x10 ³)	i mm
155-4	155	4	14,9	0,485	32,6	1900	1210	5,41	70	91	53,4
155-5	155	5	18,5	0,485	26,3	2360	1500	6,63	86	112	53,0
155-6	155	6	22,0	0,485	22,0	2810	1790	7,80	100	133	52,7
155-7	155	7	25,5	0,485	19,0	3250	2070	8,93	115	153	52,3
155-8	155	8	29,0	0,485	16,7	3690	2350	10,0	129	172	52,0
155-9	155	9	32,4	0,485	15,0	4130	2630	11,0	142	191	51,7
165-4	165	4	15,9	0,518	32,6	2020	1290	6,55	79	103	56,9
165-5	165	5	19,7	0,518	26,2	2510	1600	8,05	97	128	56,5
165-6	165	6	23,5	0,518	22,0	3000	1910	9,48	114	151	56,2
165-7	165	7	27,3	0,518	19,0	3470	2210	10,9	131	174	55,9
165-8	165	8	31,0	0,518	16,7	3950	2510	12,1	147	197	55,5
165-9	165	9	34,6	0,518	14,9	4410	2810	13,5	163	219	55,2
175-4	175	4	16,9	0,548	32,5	2150	1370	7,85	90	116	60,4
175-5	175	5	21,0	0,548	26,2	2670	1700	9,65	110	144	60,1
175-6	175	6	25,0	0,548	21,9	3190	2030	11,0	130	171	59,7
175-7	175	7	29,0	0,548	18,9	3690	2350	13,0	149	197	59,4
175-8	175	8	32,9	0,548	16,6	4200	2670	14,7	167	223	59,1
175-9	175	9	36,8	0,548	14,9	4690	2990	16,2	185	248	58,7
200-5	200	5	24,0	0,626	26,1	3060	1900	14,6	145	190	68,9
200-6	200	6	28,7	0,626	21,8	3660	2330	17,2	172	225	68,6
200-7	200	7	33,3	0,626	18,8	4240	2700	19,8	197	260	68,2
200-8	200	8	37,9	0,626	16,5	4830	3080	22,3	222	294	67,9
200-9	200	9	42,4	0,626	14,8	5400	3440	24,7	246	328	67,6
219-5	219	5	26,4	0,686	26,0	3360	2140	19,3	175	228	75,6
219-6	219	6	31,5	0,686	21,8	4010	2550	22,8	208	272	75,3
219-7	219	7	36,5	0,686	18,7	4660	2970	26,2	239	314	74,9
219-8	219	8	41,6	0,686	16,5	5300	3370	29,6	269	356	74,6
219-9	219	9	46,6	0,686	14,7	5940	3780	32,2	299	396	74,3
244,5-6	244,5	6	35,3	0,244	21,8	4500	2860	32,0	262	341	84,3
244,5-8	244,5	8	46,7	0,244	16,5	5940	3780	41,6	340	448	83,7
244,5-10	244,5	10	57,8	0,244	13,3	7370	4690	50,7	415	550	83,0
244,5-12	244,5	12	68,8	0,244	11,2	8760	5580	59,4	486	649	82,3
244,5-14	244,5	14	79,6	0,244	9,65	10100	6430	67,6	553	745	81,6
273-6	273	6	39,5	0,858	21,7	5030	3200	44,9	329	428	94,4
273-8	273	8	52,3	0,858	16,4	6660	4240	58,5	429	562	93,7
273-10	273	10	64,9	0,858	13,2	8260	5260	71,5	524	692	93,0
273-12	273	12	77,2	0,858	11,1	9840	6260	84,0	615	818	92,4
273-14	273	14	89,4	0,858	9,59	11400	7260	95,8	702	940	91,7
323,9-8	323,9	8	62,3	1,02	16,3	7940	5050	99,1	612	798	112
323,9-10	323,9	10	77,4	1,02	13,1	9860	6280	122	751	986	111
323,9-12	323,9	12	92,3	1,02	11,0	11800	7510	143	884	1170	110
323,9-14	323,9	14	107	1,02	9,51	13600	8660	164	1010	1340	110
355,6-8	355,6	8	68,6	1,12	16,3	8740	5560	132	742	967	123
355,6-10	355,6	10	85,2	1,12	13,1	10900	6940	162	912	1190	122
355,6-12	355,6	12	102	1,12	11,0	12900	8210	191	1080	1420	122
355,6-14	355,6	14	118	1,12	9,47	15000	9550	219	1230	1630	121
406,4-8	406,4	8	78,6	1,28	16,2	10000	6370	199	978	1270	141
406,4-10	406,4	10	97,8	1,28	13,1	12400	7890	245	1200	1570	140
406,4-12	406,4	12	117	1,28	10,9	14900	9480	299	1420	1870	139
406,4-14	406,4	14	135	1,28	9,42	17300	11000	333	1640	2160	139

SQUARED HOLLOW CROSS SECTIONS

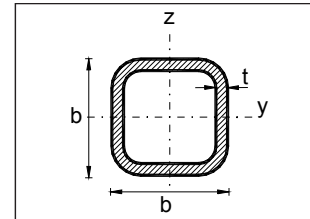

Cross section	Dimensions		M Kg/m	painting surface per unit length and unit mass		Geometric Properties					
	b mm	t mm		S_m m ² /m	s_t m ² /T	A mm ²	A_v mm ²	I mm ⁴ (x10 ⁶)	W_{el} mm ³ (x10 ³)	W_{pl} mm ³ (x10 ³)	i mm
40-2	40	2	2,36	0,156	66,3	301	151	0,073	3,66	4,33	15,5
40-3	40	3	3,47	0,156	45,1	442	221	0,101	5,09	6,17	15,1
40-4	40	4	4,53	0,156	34,6	578	289	0,125	6,29	7,80	14,7
50-2	50	2	2,86	0,188	65,8	364	182	0,147	5,90	6,91	20,1
50-3	50	3	4,21	0,188	44,6	537	269	0,208	8,33	9,95	19,7
50-4	50	4	5,52	0,188	34,1	703	352	0,261	10,5	12,7	19,2
60-2	60	2	3,60	0,235	65,4	458	229	0,260	8,68	10,0	23,8
60-3	60	3	5,32	0,235	44,2	678	339	0,371	12,3	14,6	23,3
60-4	60	4	7,0	0,235	33,6	892	446	0,470	15,6	18,8	22,9
60-5	60	5	8,63	0,235	27,2	1100	550	0,559	18,6	22,7	22,5
70-2	70	2	4,34	0,283	65,1	552	276	0,419	11,9	13,8	27,5
70-3	70	3	6,43	0,283	43,9	819	410	0,602	17,2	20,2	27,1
70-4	70	4	8,48	0,283	33,3	1080	540	0,769	21,9	26,1	26,6
70-5	70	5	10,4	0,283	26,9	1340	670	0,920	26,3	31,7	26,2
70-6	70	6	12,4	0,283	22,7	1580	790	1,05	30,2	36,9	25,8
75-2	75	2	4,53	0,293	65,0	578	289	0,52	13,8	15,9	29,9
75-3	75	3	6,73	0,293	43,8	857	429	0,75	19,9	23,3	29,5
75-4	75	4	8,87	0,293	33,2	1130	565	0,96	25,5	30,2	29,0
75-5	75	5	11,0	0,293	26,9	1400	700	1,14	30,6	36,8	28,6
75-6	75	6	13,0	0,293	22,5	1660	830	1,32	35,3	42,9	28,2
80-2	80	2	4,83	0,312	64,9	615	308	0,63	15,8	18,2	32,0
80-3	80	3	7,17	0,312	43,7	914	457	0,91	22,8	26,6	31,6
80-4	80	4	9,47	0,312	33,1	1210	605	1,17	29,3	34,6	31,1
80-5	80	5	11,7	0,312	26,8	1490	745	1,41	35,3	42,2	30,7
80-6	80	6	13,9	0,312	22,5	1770	885	1,63	40,7	49,3	30,3
90-2	90	2	5,57	0,361	64,8	710	355	0,91	20,2	23,2	35,7
90-3	90	3	8,28	0,361	43,6	1060	530	1,31	29,3	34,0	35,3
90-4	90	4	10,9	0,361	32,9	1390	695	1,69	37,7	44,4	34,9
90-5	90	5	13,5	0,361	26,6	1730	865	2,05	45,6	54,2	34,4
90-6	90	6	16,1	0,361	22,4	2050	1030	2,38	52,9	63,6	34,0
90-7	90	7	18,6	0,361	19,3	2380	1190	2,68	59,7	72,5	33,6
100-3	100	3	9,02	0,392	43,5	1150	575	1,82	36,5	42,3	39,8
100-4	100	4	11,9	0,392	32,8	1520	760	2,36	47,2	55,3	39,4
100-5	100	5	14,8	0,392	26,5	1880	940	2,85	57,3	67,7	38,9
100-6	100	6	17,6	0,392	22,3	2240	1120	3,33	66,7	79,6	38,5
100-7	100	7	20,4	0,392	19,3	2590	1300	3,77	75,4	90,9	38,1
110-4	110	4	12,9	0,423	32,8	1650	833	3,18	57,8	67,4	43,9
110-5	110	5	16,0	0,423	26,4	2040	1020	3,86	70,3	82,7	43,5
110-6	110	6	19,1	0,423	22,2	2430	1220	4,51	82,0	97,4	43,0
110-7	110	7	22,1	0,423	19,1	2810	1410	5,12	93,1	111	42,6
110-8	110	8	25,1	0,423	16,9	3190	1600	5,69	104	125	42,2
120-4	120	4	14,4	0,471	32,7	1830	915	4,16	69,4	80,7	47,6
120-5	120	5	17,9	0,471	26,3	2280	1140	5,07	84,6	99,2	47,2
120-6	120	6	21,3	0,471	22,1	2710	1360	5,94	99,0	117	46,7
120-7	120	7	24,7	0,471	19,0	3140	1570	6,75	113	134	46,3
120-8	120	8	28,0	0,471	16,8	3570	1790	7,53	126	151	45,9
120-9	120	9	31,3	0,471	15,0	3990	1700	8,25	138	167	45,5

continued

SQUARED HOLLOW CROSS SECTIONS

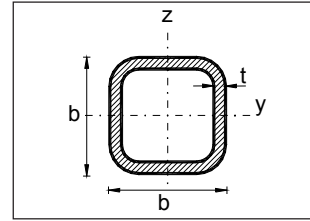

continued											
Cross section	Dimensions		M Kg/m	painting surface per unit length and unit mass		Geometric properties					
	b mm	t mm		S_m m^2/m	S_t m^2/T	A mm^2	A_v mm^2	I mm^4 ($\times 10^6$)	W_{el} mm^3 ($\times 10^3$)	W_{pl} mm^3 ($\times 10^3$)	i mm
125-4	125	4	14,9	0,485	32,6	1900	950	4,72	75,6	87,8	49,9
125-5	125	5	18,5	0,485	26,3	2360	1180	5,77	92,3	108	49,4
125-6	125	6	22,0	0,485	22,0	2810	1410	6,75	108	128	49,0
125-7	125	7	25,5	0,485	19,0	3250	1630	7,69	123	146	48,6
125-8	125	8	29,0	0,485	16,7	3690	1850	8,58	137	165	48,1
125-9	125	9	32,4	0,485	15,0	4130	2070	9,42	151	182	47,7
135-4	135	4	15,9	0,518	32,6	2020	1010	6,0	88,8	103	54,4
135-5	135	5	19,7	0,518	26,2	2510	1260	7,33	109	127	54,0
135-6	135	6	23,5	0,518	22,0	3000	1500	8,60	127	150	53,5
135-7	135	7	27,3	0,518	19,0	3470	1740	9,81	145	172	53,1
135-8	135	8	31,0	0,518	16,7	3950	1980	11,0	145	194	52,7
135-9	135	9	34,6	0,518	14,9	4410	2210	12,1	179	214	52,2
140-4	140	4	16,9	0,548	32,5	2150	1080	6,71	95,9	111	55,8
140-5	140	5	21,0	0,548	26,2	2670	1340	8,21	117	137	55,4
140-6	140	6	25,0	0,548	21,9	3190	1600	9,64	138	162	55,0
140-7	140	7	29,0	0,548	18,9	3690	1800	11,0	157	186	54,5
140-8	140	8	32,9	0,548	16,6	4200	2100	12,3	176	209	54,1
140-9	140	9	36,8	0,548	14,9	4690	2350	13,6	194	232	53,7
160-5	160	5	24,0	0,626	26,1	3060	1530	12,4	155	180	63,6
160-6	160	6	28,7	0,626	21,8	3660	1830	14,6	183	214	63,2
160-7	160	7	33,3	0,626	18,8	4240	2120	16,7	209	246	62,8
160-8	160	8	37,9	0,626	16,5	4830	2420	18,8	235	278	62,3
160-9	160	9	42,3	0,626	14,8	5400	2700	20,7	259	308	61,9
175-5	175	5	26,4	0,686	26,0	3360	1680	16,4	187	217	69,8
175-6	175	6	31,5	0,686	21,8	4010	2010	19,3	221	257	69,3
175-7	175	7	36,5	0,686	18,7	4660	2330	22,2	253	297	68,9
175-8	175	8	41,6	0,686	16,5	5300	2650	24,9	285	335	68,5
175-9	175	9	46,6	0,686	14,7	5940	2970	27,5	315	372	68,0
180-5	180	5	26,8	0,699	26,1	3420	1710	17,3	192	223	71,0
180-6	180	6	31,9	0,695	21,8	4080	2090	20,2	225	263	70,5
180-8	180	8	41,6	0,686	16,5	5310	2660	25,6	285	338	69,5
180-10	180	10	51,0	0,683	13,4	6490	3250	30,5	338	407	68,5
180-12	180	12	62,6	0,707	11,3	7620	3810	34,7	305	470	67,4
200-5	200	5	30,0	0,780	26,0	3020	1510	24,0	240	278	79,2
200-6	200	6	35,7	0,778	21,8	4550	2080	28,1	281	328	78,7
200-8	200	8	46,7	0,771	16,5	5950	2980	35,9	359	473	77,7
200-10	200	10	57,2	0,761	13,3	7290	3650	42,9	429	512	76,7
200-12	200	12	67,4	0,755	11,2	8580	4290	49,1	491	593	75,7
250-5	250	5	45,1	1,17	25,9	4820	2410	47,9	388	441	99,6
250-6	250	6	59,3	1,29	21,7	5750	2880	56,4	451	522	99,1
250-8	250	8	68,7	1,13	16,4	7550	3780	72,6	581	679	98,1
250-10	250	10	72,9	0,962	13,2	9290	4650	87,6	701	826	97,1
250-12	250	12	86,2	0,957	11,1	11000	5500	101	811	966	96,1
260-6	260	6	48,1	1,04	21,6	5990	3000	63,7	490	566	103
260-10	260	10	67,8	0,895	13,2	9690	4850	99,2	763	898	101
300-6	300	6	54,5	1,18	21,6	6950	3480	99,2	662	761	120
300-8	300	8	71,8	1,17	16,3	9150	4580	129	857	994	119
300-10	300	10	88,6	1,16	13,1	11300	5650	156	1040	1220	118
300-12	300	12	105	1,16	11,0	13400	6700	182	1210	1430	117
350-8	350	8	86,3	1,40	16,2	10800	5400	208	1190	1370	139
350-10	350	10	107	1,40	13,0	13300	6650	253	1450	1680	138
350-12	350	12	128	1,40	10,9	15800	7900	296	1690	1980	137

RECTANGLE HOLLOW CROSS SECTIONS

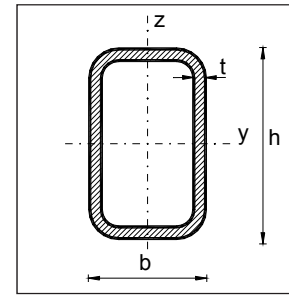

Cross section				M Kg/m	painting surface per unit length and unit mass		Geometric properties										
	b mm	h mm	t mm		m ² /m	m ² /T	A mm ²	I _y mm ⁴ (x10 ⁶)	W _{el,y} mm ³ (x10 ³)	W _{pl,y} mm ³ (x10 ³)	i _y mm	A _{v,y} mm ²	I _z mm ⁴ (x10 ⁶)	W _{el,z} mm ³ (x10 ³)	W _{pl,z} mm ³ (x10 ³)	i _z mm	A _{v,z} mm ²
30-50-2	30	50	2	2,36	0,156	66,3	301	0,101	4,06	4,99	18,3	188	0,045	3,0	3,467	12,2	113
30-50-3	30	50	3	3,47	0,156	45,1	442	0,142	5,68	7,13	17,9	276	0,061	4,12	4,91	11,8	166
30-50-4	30	50	4	4,53	0,156	34,5	578	0,176	7,06	9,04	17,4	361	0,075	5,01	6,16	11,4	217
20-60-2	20	60	2	2,36	0,156	66,3	301	0,125	4,19	5,45	20,4	226	0,020	0,08	2,41	8,3	75
20-60-3	20	60	3	3,47	0,156	45,1	442	0,176	5,87	7,79	19,9	332	0,027	2,76	3,35	7,9	111
20-60-4	20	60	4	4,53	0,156	34,6	578	0,219	7,31	9,88	19,4	434	0,032	3,25	4,12	7,4	145
40-60-2	40	40	2	2,86	0,188	65,8	364	0,193	6,43	7,77	23,0	218	0,102	5,11	5,85	16,7	218
40-60-3	40	40	3	4,21	0,188	44,6	537	0,273	9,12	11,2	22,5	322	0,143	7,15	8,39	16,3	322
40-60-4	40	40	4	5,52	0,188	34,1	703	0,345	11,5	14,4	22,1	422	0,178	8,90	10,7	15,9	422
30-70-2	30	70	2	2,86	0,188	65,8	364	0,234	6,70	8,43	25,3	255	0,060	4,05	4,59	12,9	109
30-70-3	30	70	3	4,21	0,188	44,6	537	0,333	9,52	12,2	24,9	376	0,083	5,58	6,53	12,4	161
30-70-4	30	70	4	5,52	0,188	34,1	703	0,420	12,0	15,6	24,4	492	0,102	6,83	8,24	12,0	211
50-70-2	50	70	2	3,60	0,235	65,4	458	0,330	9,34	11,2	26,7	267	0,193	7,75	8,83	20,5	191
50-70-3	50	70	3	5,32	0,235	44,2	678	0,470	13,4	16,2	26,2	395	0,274	11,0	12,8	20,1	283
50-70-4	50	70	4	7,0	0,235	33,6	892	0,600	17,0	20,9	25,8	520	0,346	13,9	16,4	19,7	372
50-70-5	50	70	5	8,63	0,235	27,2	1100	0,700	20,3	25,3	25,3	641	0,409	16,4	19,8	19,2	459
40-80-2	40	80	2	3,60	0,235	65,4	458	0,390	9,74	12,0	29,1	306	0,131	6,55	7,37	16,9	153
40-80-3	40	80	3	5,32	0,235	44,2	678	0,560	14,0	17,5	28,6	452	0,184	9,21	10,6	16,4	226
40-80-4	40	80	4	7,0	0,235	33,6	892	0,710	17,8	22,5	28,2	595	0,230	11,5	13,6	16,0	297
40-80-5	40	80	5	8,63	0,235	27,2	1100	0,850	21,2	27,3	27,7	734	0,269	13,5	16,3	15,6	366
60-80-2	60	80	2	4,34	0,283	65,1	552	0,510	12,8	15,1	30,4	315	0,327	10,9	12,4	24,3	237
60-80-3	60	80	3	6,43	0,283	43,9	819	0,740	18,4	22,1	29,9	468	0,468	15,6	18,1	23,9	351
60-80-4	60	80	4	8,48	0,283	33,3	1080	0,940	23,6	28,6	29,5	617	0,596	19,9	23,3	23,4	463
60-80-5	60	80	5	10,5	0,283	26,9	1340	1,13	28,3	34,8	29,1	765	0,710	23,7	28,3	23,0	575
60-80-6	60	80	6	12,4	0,283	22,7	1580	1,30	32,6	40,5	28,6	902	0,813	27,1	32,8	22,6	678
50-90-2	50	90	2	4,34	0,283	65,1	552	0,600	13,3	16,2	32,9	355	0,239	9,59	10,8	20,8	197
50-90-3	50	90	3	6,40	0,283	43,9	819	0,860	19,2	23,6	32,4	527	0,341	13,6	15,6	20,3	292
50-90-4	50	90	4	8,48	0,283	33,3	1080	1,10	24,6	30,6	32,0	694	0,431	17,2	20,1	19,9	386
50-90-5	50	90	5	10,5	0,283	26,9	1340	1,33	29,6	37,3	31,5	862	0,510	20,4	24,3	19,5	478
50-90-6	50	90	6	12,4	0,283	22,7	1580	1,53	34,1	43,5	31,1	1020	0,580	23,2	28,1	19,1	564
40-100-2	40	100	2	4,34	0,283	65,1	552	0,680	13,6	17,1	35,0	393	0,160	8,0	8,89	17,0	159
40-100-3	40	100	3	6,43	0,283	43,9	819	0,980	19,6	24,9	34,5	583	0,225	11,3	12,8	16,5	236
40-100-4	40	100	4	8,48	0,283	33,3	1080	1,26	25,1	32,3	34,1	769	0,282	14,1	16,4	16,1	311
40-100-5	40	100	5	10,5	0,283	26,9	1340	1,51	30,2	39,3	33,6	954	0,330	16,5	19,8	15,7	386
40-100-6	40	100	6	12,4	0,283	22,7	1580	1,74	34,9	45,8	33,1	1130	0,372	18,6	22,8	15,3	455
60-90-2	60	90	2	4,53	0,293	65,0	578	0,676	15,0	18,0	34,2	347	0,361	12,0	13,6	25,0	231
60-90-3	60	90	3	6,73	0,293	43,8	857	0,977	21,7	26,2	33,7	514	0,517	17,3	19,8	24,5	343
60-90-4	60	90	4	8,87	0,293	33,2	1130	1,26	27,9	34,1	33,3	678	0,659	22,0	25,6	24,1	457
60-90-5	60	90	5	11,0	0,293	26,9	1400	1,51	33,6	41,5	32,8	839	0,786	26,2	31,0	23,7	559
60-90-6	60	90	6	13,0	0,293	22,6	1660	1,76	38,8	48,5	32,4	995	0,901	30,0	36,1	23,3	663

continued

**RECTANGLE
HOLLOW
CROSS SECTIONS**

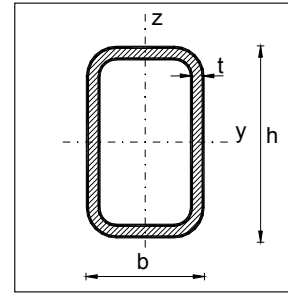

Cross section	Dimensions			M Kg/m	painting surface per unit length and unit mass		Geometric properties										
	b mm	h mm	t mm		m ² /m	m ² /T	A mm ²	I _y mm ⁴ (x10 ⁶)	W _{el,y} mm ³ (x10 ³)	W _{pl,y} mm ³ (x10 ³)	i _y mm	A _{v,y} mm ²	I _z mm ⁴ (x10 ⁶)	W _{el,z} mm ³ (x10 ³)	W _{pl,z} mm ³ (x10 ³)	i _z mm	A _{v,z} mm ²
50-100-2	50	100	2	4,53	0,293	65,0	578	0,780	15,5	19,1	36,6	386	0,262	10,5	11,7	21,3	221
50-100-3	50	100	3	6,73	0,293	43,8	857	1,12	22,4	27,8	36,1	572	0,374	15,0	17,0	20,8	328
50-100-4	50	100	4	8,87	0,293	33,2	1130	1,44	28,8	36,1	35,6	754	0,473	15,0	21,9	20,4	433
50-100-5	50	100	5	11,0	0,293	26,9	1400	1,74	34,7	44,0	35,2	933	0,561	22,5	26,5	20,0	535
50-100-6	50	100	6	13,0	0,293	22,6	1660	2,091	40,2	51,4	34,7	1110	0,639	25,6	30,7	19,6	635
40-110-2	40	110	2	4,53	0,293	65,0	578	0,860	15,7	19,9	38,6	426	0,174	8,72	9,65	17,3	154
40-110-3	40	110	3	6,73	0,293	43,8	857	1,25	22,7	29,1	38,1	632	0,246	12,3	13,9	16,9	229
40-110-4	40	110	4	8,87	0,293	33,2	1130	1,61	29,2	37,8	37,6	833	0,308	15,4	17,9	16,5	433
40-110-5	40	110	5	11,0	0,293	26,9	1400	1,97	35,2	46,0	37,2	1030	0,361	18,1	21,5	16,0	513
40-110-6	40	110	6	13,0	0,293	22,6	1660	2,24	40,7	53,8	36,7	1220	0,407	20,4	24,8	15,6	443
60-100-2	60	100	2	4,83	0,312	64,9	615	0,871	17,4	21,0	37,6	384	0,395	13,2	14,7	25,3	231
60-100-3	60	100	3	7,17	0,312	43,7	914	1,26	25,2	30,7	37,1	571	0,566	18,9	21,5	24,8	343
60-100-4	60	100	4	9,47	0,312	33,1	1210	1,63	32,5	40,0	36,7	754	0,722	24,1	27,8	24,4	452
60-100-5	60	100	5	11,7	0,312	26,8	1490	1,96	39,2	48,6	36,2	933	0,862	28,7	33,8	24,0	560
60-100-6	60	100	6	13,9	0,312	22,5	1770	2,27	45,5	57,1	35,8	1110	0,988	33,0	39,3	23,6	664
80-100-2	80	100	2	5,57	0,361	64,8	710	1,06	21,3	24,9	38,6	395	0,754	18,9	21,4	32,6	315
80-100-3	80	100	3	8,28	0,361	43,6	1060	1,54	30,9	36,5	38,2	587	1,090	27,3	31,3	32,1	468
80-100-4	80	100	4	10,9	0,361	32,9	1390	1,99	39,9	47,6	37,8	775	1,410	35,1	40,8	31,7	619
80-100-5	80	100	5	13,6	0,361	26,6	1730	2,41	48,3	58,3	37,3	960	1,690	42,4	49,8	31,3	767
80-100-6	80	100	6	16,1	0,361	22,4	2050	2,80	56,1	60,4	36,9	1140	1,960	49,0	58,3	30,8	912
80-100-7	80	100	7	18,6	0,361	19,3	2380	3,17	63,4	78,0	36,5	1320	2,210	55,2	66,3	30,4	1060
60-120-2	60	120	2	5,57	0,361	64,8	710	1,36	22,6	27,6	43,6	474	0,462	15,4	17,1	25,5	236
60-120-3	60	120	3	8,28	0,361	43,6	1060	1,97	32,9	40,6	43,2	704	0,664	22,1	24,9	25,0	351
60-120-4	60	120	4	10,0	0,361	32,9	1390	2,55	42,5	52,9	42,7	930	0,850	28,3	32,3	24,6	464
60-120-5	60	120	5	13,0	0,361	26,6	1730	3,09	51,6	64,8	42,3	1150	1,010	33,8	39,3	24,2	575
60-120-6	60	120	6	16,1	0,361	22,4	2050	3,60	60,0	76,0	41,8	1370	1,160	38,8	45,8	23,8	684
60-120-7	60	120	7	18,6	0,361	19,3	2380	4,07	67,9	86,8	41,4	1580	1,300	43,3	51,9	23,3	791
80-120-3	80	120	3	9,02	0,392	43,5	1150	2,38	39,7	47,6	45,5	689	1,270	31,8	35,9	33,2	460
80-120-4	80	120	4	11,9	0,392	32,8	1520	3,09	51,5	62,2	45,0	912	1,640	40,9	46,8	32,8	608
80-120-5	80	120	5	14,8	0,392	26,5	1880	3,76	62,6	76,3	44,6	1130	1,980	49,4	57,3	32,3	754
80-120-6	80	120	6	17,6	0,392	22,3	2240	4,38	73,0	89,7	44,1	1350	2,290	57,3	67,2	34,9	897
80-120-7	80	120	7	20,4	0,392	19,2	2590	4,97	82,8	103	43,7	1560	2,580	64,5	76,6	31,5	1040
60-140-3	60	140	3	9,02	0,392	43,5	1150	2,89	41,3	51,6	50,1	805	0,761	25,4	28,3	25,7	345
60-140-4	60	140	4	11,9	0,392	32,8	1520	3,75	53,6	67,5	49,6	1060	0,973	32,4	36,8	25,3	456
60-140-5	60	140	5	14,8	0,392	26,5	1880	4,57	65,2	82,8	49,2	1320	1,17	38,9	44,8	24,8	564
60-140-6	60	140	6	17,6	0,392	22,3	2240	5,33	76,2	97,4	48,7	1570	1,34	44,7	52,3	24,4	672
60-140-7	60	140	7	20,4	0,392	25,9	2590	6,05	86,5	111	48,2	1810	1,50	49,9	59,3	24,0	777
50-150-3	50	150	3	9,02	0,392	43,5	1150	3,11	41,5	53,2	52,0	863	0,540	21,6	24,1	21,6	288
50-150-4	50	150	4	11,9	0,392	32,8	1520	4,04	53,9	69,2	51,5	1140	0,685	27,4	31,1	21,2	380
50-150-5	50	150	5	14,8	0,392	26,5	1880	4,92	65,5	85,3	51,0	1410	0,815	32,6	37,8	20,8	470
50-150-6	50	150	6	17,6	0,392	22,3	2240	5,74	76,5	100	50,5	1680	0,931	37,3	43,9	20,3	560
50-150-7	50	150	7	20,4	0,392	19,2	2590	6,52	86,9	114	50,1	1940	1,03	41,3	49,7	19,9	648
100-120-4	100	120	4	12,9	0,423	32,8	1650	3,63	60,5	71,5	46,9	899	2,73	54,6	63,0	40,7	751
100-120-5	100	120	5	16,0	0,423	26,4	2040	4,42	73,6	87,8	46,5	1110	3,32	66,3	77,3	40,3	928
100-120-6	100	120	6	19,1	0,423	22,2	2430	5,16	86,0	103	46,0	1320	3,87	77,3	90,9	39,8	1110
100-120-7	100	120	7	22,1	0,423	19,1	2810	5,86	97,7	118	45,6	1530	4,38	87,6	104	39,4	1280
100-120-8	100	120	8	25,1	0,423	16,9	3190	6,53	109	132	45,2	1740	4,86	97,3	116	39,0	1450

continued

RECTANGLE HOLLOW CROSS SECTIONS

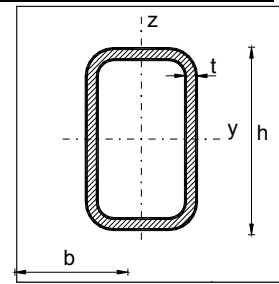

continued

Cross section	Dimensions			M Kg/m	painting surface per unit length and unit mass		Geometric properties										
	b mm	h mm	t mm		m ² /m	m ² /T	A mm ²	I _y mm ⁴ (x10 ⁶)	W _{el,y} mm ³ (x10 ³)	W _{pl,y} mm ³ (x10 ³)	i _y mm	A _{v,y} mm ²	I _z mm ⁴ (x10 ⁶)	W _{el,z} mm ³ (x10 ³)	W _{pl,z} mm ³ (x10 ³)	i _z mm	A _{v,z} mm ²
80-140-4	80	140	4	12,9	0,423	32,8	1650	4,49	64,2	78,4	52,2	1050	1,87	46,7	52,9	33,6	601
80-140-5	80	140	5	16,0	0,423	26,4	2040	5,48	78,2	95,3	51,7	1300	2,26	56,4	64,8	33,2	743
80-140-6	80	140	6	19,1	0,423	22,2	2430	6,41	91,6	113	51,3	1550	2,62	65,5	76,0	32,8	885
80-140-7	80	140	7	22,1	0,423	19,1	2810	7,29	104	130	50,8	1790	2,95	73,9	86,8	32,3	1020
80-140-8	80	140	8	25,1	0,423	16,9	3190	8,12	116	145	50,4	2030	3,26	81,6	97,0	31,9	1160
70-150-4	70	150	4	12,9	0,423	32,8	1650	4,89	62,3	81,2	54,5	1130	1,47	41,9	47,3	29,8	525
70-150-5	70	150	5	16,0	0,423	26,4	2040	5,97	79,6	99,8	54,0	1390	1,77	50,5	57,8	29,4	649
70-150-6	70	150	6	19,1	0,423	22,2	2430	6,97	93,1	117	53,5	1640	2,04	58,4	67,7	28,9	773
70-150-7	70	150	7	22,1	0,423	19,1	2810	7,95	106	134	53,1	1920	2,30	65,6	77,1	28,5	894
70-150-8	70	150	8	25,1	0,423	16,9	3190	8,86	118	151	52,6	2180	2,53	72,3	86,1	28,1	1010
60-160-4	60	160	4	12,9	0,423	32,8	1650	5,26	65,8	83,6	56,5	1200	1,10	36,6	41,2	25,8	450
60-160-5	60	160	5	16,0	0,423	26,4	2040	6,42	80,2	102	56,0	1480	1,32	43,9	50,3	25,4	557
60-160-6	60	160	6	19,1	0,423	22,2	2430	7,51	93,9	121	55,5	1770	1,52	50,5	58,8	24,9	663
60-160-7	60	160	7	22,1	0,423	19,1	2810	8,55	107	138	55,1	2040	1,70	56,5	66,8	24,5	767
60-160-8	60	160	8	25,1	0,423	16,9	3190	9,53	119	155	54,6	2320	1,86	61,9	74,3	24,1	871
100-140-4	100	140	4	14,4	0,471	32,7	1830	5,23	74,8	89,2	53,4	1070	3,10	62,0	70,7	41,1	763
100-140-5	100	140	5	17,9	0,471	26,3	2277	6,39	91,3	109	52,9	1330	3,77	75,4	86,8	40,6	950
100-140-6	100	140	6	21,3	0,471	22,1	2710	7,49	107	129	52,5	1580	4,40	87,9	102,0	40,2	1130
100-140-7	100	140	7	24,7	0,471	19,0	3140	8,53	122	148	52,0	1830	4,99	99,8	117	39,8	1310
100-140-8	100	140	8	28,0	0,471	16,8	3540	9,52	136	167	51,6	2060	5,54	111	131	39,4	1490
100-140-9	100	140	9	31,3	0,471	15,0	3990	10,4	149	184	51,2	2330	6,06	121	145	38,9	1660
90-150-4	90	150	4	14,4	0,471	32,7	1830	5,75	76,6	92,8	55,9	1140	2,59	57,5	65,0	37,5	686
90-150-5	90	150	5	17,9	0,471	26,3	2277	7,02	93,6	114	56,5	1430	3,14	69,8	79,8	37,1	855
90-150-6	90	150	6	21,3	0,471	22,1	2710	8,23	110	135	55,0	1690	3,66	81,2	93,9	36,6	1016
90-150-7	90	150	7	24,7	0,471	19,0	3140	9,38	125	155	54,6	1960	4,14	91,9	107	36,2	1180
90-150-8	90	150	8	28,0	0,471	16,8	3540	10,5	140	174	54,1	2230	4,59	102	120	35,8	1340
90-150-9	90	150	9	31,3	0,471	15,0	3990	11,5	154	193	53,7	2490	5,01	111	133	35,4	1500
80-160-4	80	160	4	14,4	0,471	32,7	1830	6,24	77,9	96,1	58,2	1220	2,10	52,5	59,0	33,8	609
80-160-5	80	160	5	17,9	0,471	26,3	2277	7,62	95,2	118	57,8	1520	2,54	63,5	72,3	33,3	759
80-160-6	80	160	6	21,3	0,471	22,1	2710	8,94	112	140	57,3	1810	2,95	73,7	84,9	32,9	902
80-160-7	80	160	7	24,7	0,471	19,0	3140	10,2	127	160	56,9	2090	3,33	83,2	97,0	32,5	1050
80-160-8	80	160	8	28,0	0,471	16,8	3540	11,4	142	180	56,4	2380	3,68	92,0	109	32,1	1190
80-160-9	80	160	9	31,3	0,471	15,0	3990	12,5	156	199	56,0	2650	4,01	100	120	31,7	1320
70-170-4	70	170	4	14,4	0,471	32,7	1830	6,69	78,7	99,0	60,3	1300	1,64	46,9	52,6	29,9	534
70-170-5	70	170	5	17,9	0,471	26,3	2277	8,18	96,2	122	58,9	1610	1,98	56,5	74,3	29,4	665
70-170-6	70	170	6	21,3	0,471	22,1	2710	9,59	113	144	59,4	1920	2,29	65,4	75,4	29,0	791
70-170-7	70	170	7	24,7	0,471	19,0	3140	10,9	129	165	58,9	2220	2,58	73,0	85,9	28,6	916
70-170-8	70	170	8	28,0	0,471	16,8	3540	12,2	144	186	58,5	2530	2,83	81,1	95,0	28,2	1040
70-170-9	70	170	9	31,3	0,471	15,0	3990	13,4	158	205	58,0	2830	3,08	87,9	105	27,7	1170
100-150-4	100	150	4	14,9	0,485	32,6	1900	6,17	82,3	98,7	57,0	1140	3,29	65,7	74,5	41,6	760
100-150-5	100	150	5	18,5	0,485	26,3	2360	7,54	101	122	56,5	1420	3,99	79,9	91,5	41,1	944
100-150-6	100	150	6	22,0	0,485	22,0	2810	8,85	118	144	56,1	1690	4,66	93,3	108	40,7	1120
100-150-7	100	150	7	25,5	0,485	19,0	3250	10,1	135	165	55,6	1950	5,29	106	124	40,3	1300
100-150-8	100	150	8	29,0	0,485	16,7	3690	11,3	150	185	55,2	2210	5,88	118	139	39,8	1480
100-150-9	100	150	9	32,4	0,485	15,0	4130	12,4	165	205	54,8	2480	6,43	129	153	39,4	1650
90-160-4	90	160	4	14,9	0,485	32,6	1900	6,72	84,0	102	59,5	1220	2,74	60,8	68,5	37,9	684
90-160-5	90	160	5	18,5	0,485	26,3	2360	8,22	103	126	59,0	1510	3,32	73,8	84,0	37,5	849
90-160-6	90	160	6	22,0	0,485	22,0	2810	9,65	121	149	58,6	1800	3,87	85,9	98,9	37,1	1010
90-160-7	90	160	7	25,5	0,485	19,0	3250	11,0	138	171	58,1	2080	4,38	97,3	113	36,6	1170
90-160-8	90	160	8	29,0	0,485	16,7	3690	12,3	154	192	57,7	2360	4,86	108	127	36,2	1330
90-160-9	90	160	9	32,4	0,485	15,0	4130	13,5	169	213	57,2	2640	5,30	118	140	25,8	1490

continued

**RECTANGLE
HOLLOW
CROSS SECTIONS** (continued)

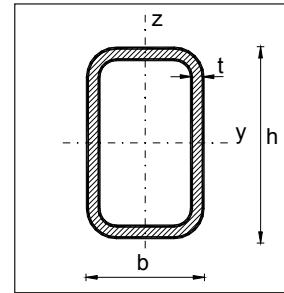

Cross section	Dimensions			M Kg/m	painting surface per unit length and unit mass		Geometric dimensions										
	b mm	h mm	t mm		m ² /m	m ² /T	A mm ²	I _y mm ⁴ (x10 ⁶)	W _{el,y} mm ³ (x10 ³)	W _{pl,y} mm ³ (x10 ³)	i _y mm	A _{v,y} mm ²	I _z mm ⁴ (x10 ⁶)	W _{el,z} mm ³ (x10 ³)	W _{pl,z} mm ³ (x10 ³)	i _z mm	A _{v,z} mm ²
80-170-4	80	170	4	14,9	0,485	32,6	1900	7,24	85,2	106	61,7	1290	2,21	55,4	62,0	34,1	608
80-170-5	80	170	5	18,5	0,485	26,3	2360	8,86	104	130	61,3	1600	2,68	67,0	76,0	33,7	755
80-170-6	80	170	6	22,0	0,485	19,0	2810	10,4	122	154	60,8	1910	3,11	77,8	89,4	33,2	899
80-170-7	80	170	7	25,5	0,485	16,7	3250	11,9	140	176	60,3	2210	3,52	87,9	102	32,8	1040
80-170-8	80	170	8	29,0	0,485	16,7	3690	13,3	156	199	59,9	2510	3,09	97,2	114	32,4	1180
80-170-9	80	170	9	32,4	0,485	15,0	4130	14,6	172	220	59,4	2810	4,23	106	126	32,0	1320
70-180-4	70	180	4	14,9	0,485	32,6	1900	7,72	85,8	109	63,8	1410	1,72	49,3	55,2	30,1	550
70-180-5	70	180	5	18,5	0,485	26,3	2360	9,45	105	134	63,3	1700	2,08	59,5	67,5	29,7	661
70-180-6	70	180	6	22,0	0,485	22,0	2810	11,1	123	158	62,8	2020	2,41	68,9	79,2	29,3	787
70-180-7	70	180	7	25,5	0,485	19,0	3250	12,7	141	181	62,4	2340	2,71	77,5	90,3	28,8	910
70-180-8	70	180	8	29,0	0,485	16,7	3690	14,2	157	204	61,9	2660	2,99	85,5	101	28,4	1030
70-180-9	70	180	9	32,4	0,485	14,9	4130	15,6	173	226	61,4	2970	3,24	92,7	111	28,0	1160
120-150-4	120	150	4	15,9	0,518	32,6	2020	7,02	93,6	110	58,9	1120	4,97	82,9	94,6	49,5	897
120-150-5	120	150	5	19,7	0,518	26,2	2510	8,59	115	136	58,4	1400	6,07	101	117	49,1	1120
120-150-6	120	150	6	23,5	0,518	22,0	3000	10,1	135	161	58,0	1110	7,11	119	138	48,7	1330
120-150-7	120	150	7	27,3	0,518	19,0	3470	11,5	154	185	57,6	1930	8,10	135	158	48,2	1540
120-150-8	120	150	8	31,0	0,518	16,7	3950	12,9	172	208	57,1	2200	9,03	151	178	47,8	1750
120-150-9	120	150	9	34,6	0,518	15,0	4410	14,2	189	231	56,7	2450	9,92	165	197	47,4	1960
100-170-4	100	170	4	15,9	0,518	32,6	2020	8,34	98,1	119	64,2	1270	3,65	73,0	82,2	42,4	747
100-170-5	100	170	5	19,7	0,518	26,2	2510	10,2	120	147	63,7	1580	4,44	88,9	101	42,0	929
100-170-6	100	170	6	23,5	0,518	22,0	3000	12,0	141	173	63,3	1890	5,19	104	119	41,6	1110
100-170-7	100	170	7	27,3	0,518	19,0	3470	13,7	162	199	62,8	2190	5,89	118	137	41,1	1280
100-170-8	100	170	8	31,0	0,518	16,7	3950	15,4	181	224	62,4	2490	6,56	131	153	40,7	1460
100-170-9	100	170	9	34,6	0,518	14,9	4410	16,9	199	249	61,9	2780	7,18	144	169	40,3	1630
90-180-4	90	180	4	15,9	0,518	32,6	2020	8,96	99,6	123	66,5	1350	3,03	67,3	75,3	38,7	673
90-180-5	90	180	5	19,7	0,518	26,2	2510	11,0	122	151	66,1	1670	3,68	81,8	92,5	38,2	836
90-180-6	90	180	6	23,5	0,518	22,0	3000	12,9	144	179	65,6	2000	4,29	95,3	109	37,8	999
90-180-7	90	180	7	27,3	0,518	19,0	3470	14,8	164	205	65,1	2310	4,86	108	125	37,4	1160
90-180-8	90	180	8	31,0	0,518	16,7	3950	16,5	184	231	64,7	2640	5,39	120	140	36,9	1320
90-180-9	90	180	9	34,6	0,518	14,9	4410	20,5	205	269	68,2	3270	5,89	131	155	36,5	1470
70-200-4	70	200	4	15,9	0,518	32,6	2020	10,1	101	129	70,6	1500	1,90	54,3	60,4	30,6	523
70-200-5	70	200	5	19,7	0,518	26,2	2510	12,4	124	159	70,1	1860	2,29	65,6	74,0	30,2	650
70-200-6	70	200	6	23,5	0,518	22,0	3000	14,6	146	188	69,1	2220	2,65	75,9	86,8	29,7	777
70-200-7	70	200	7	27,3	0,518	19,0	3470	16,6	166	216	69,1	2470	2,99	85,5	99,1	29,3	894
70-200-8	70	200	8	31,0	0,518	16,7	3950	18,6	186	243	68,7	2930	3,30	94,3	111	28,9	1020
70-200-9	70	200	9	34,6	0,518	14,9	4410	20,5	205	269	68,2	3270	3,58	102	122	28,5	1140
120-160-4	120	160	4	16,9	0,548	32,5	2150	8,18	102	121	61,7	1230	5,24	87,4	99,3	49,4	922
120-160-5	120	160	5	21,0	0,548	26,2	2670	10,0	125	149	61,2	1520	6,40	107	122	48,9	1150
120-160-6	120	160	6	25,0	0,548	21,9	3190	11,8	147	177	60,8	1820	7,50	125	144	48,5	1370
120-160-7	120	160	7	29,0	0,548	18,9	3600	13,5	168	203	60,3	2070	8,54	142	166	48,1	1560
120-160-8	120	160	8	32,9	0,548	16,6	4200	15,1	189	229	59,9	2400	9,54	159	187	47,6	1800
120-160-9	120	160	9	36,8	0,548	14,9	4690	16,6	208	254	59,5	2700	10,5	176	207	47,2	2010
100-180-4	100	180	4	16,9	0,548	32,5	2150	9,58	107	130	66,7	1380	3,83	76,7	86	42,2	768
100-180-5	100	180	5	21,0	0,548	26,2	2670	11,8	131	160	66,3	1720	4,67	93,4	106	41,8	953
100-180-6	100	180	6	25,0	0,548	21,9	3190	13,8	154	189	65,8	2050	5,45	109,1	125	41,3	1140
100-180-7	100	180	7	29,0	0,548	18,9	3600	15,8	176	218	65,4	2370	6,20	124	143	40,9	1320
100-180-8	100	180	8	32,9	0,548	16,6	4200	17,7	197	245	64,9	2700	6,89	137	161	40,5	1500
100-180-9	100	180	9	36,8	0,548	14,9	4690	19,5	217	272	64,5	3020	7,55	151	178	40,1	1670

continued

**RECTANGLE
HOLLOW
CROSS SECTIONS** (continued)

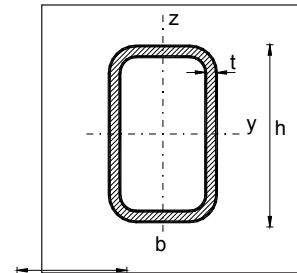

continued

Cross section	Dimensions			M Kg/m	painting surface per unit length and unit mass		Geometric properties										
	b mm	h mm	t mm		m ² /m	m ² /T	A mm ²	I _y mm ⁴ (x10 ⁶)	W _{el,y} mm ³ (x10 ³)	W _{pl,y} mm ³ (x10 ³)	i _y mm	A _{v,y} mm ²	I _z mm ⁴ (x10 ⁶)	W _{el,z} mm ³ (x10 ³)	W _{pl,z} mm ³ (x10 ³)	i _z mm	A _{v,z} mm ²
80-200-4	80	200	4	16,9	0,548	32,5	2150	10,9	109	136	71,1	1540	2,56	64,0	71,1	34,5	615
80-200-5	80	200	5	21,0	0,548	26,2	2670	13,3	133	168	70,6	1910	3,10	77,5	87,2	34,0	764
80-200-6	80	200	6	25,0	0,548	21,9	3190	15,7	157	199	70,1	2280	3,60	90,1	103	33,6	912
80-200-7	80	200	7	29,0	0,548	18,9	3690	17,9	179	229	69,6	2630	4,07	102	117	33,2	1060
80-200-8	80	200	8	32,9	0,548	16,6	4200	20,1	201	258	69,2	3000	4,51	113	131	32,7	1200
80-200-9	80	200	9	36,8	0,548	14,9	4690	22,2	222	287	68,7	3350	4,91	123	145	32,3	1340
140-180-5	140	180	5	24,0	0,626	26,1	3060	14,8	165	195	69,5	1720	10,0	143	164	57,2	1340
140-180-6	140	180	6	28,7	0,626	21,8	3660	17,5	194	231	69,1	2060	11,8	169	194	56,8	1600
140-180-7	140	180	7	33,3	0,626	18,8	4240	20,0	222	266	68,6	2390	13,5	193	223	56,3	1850
140-180-8	140	180	8	37,9	0,626	16,5	4830	22,5	250	300	68,2	2720	15,1	216	252	55,9	2110
140-180-9	140	180	9	42,4	0,626	14,8	5400	24,8	276	334	67,7	3040	16,6	238	279	55,5	2360
120-200-5	120	200	5	24,0	0,626	26,1	3060	17,1	171	207	74,7	1910	7,72	129	145	50,2	1150
120-200-6	120	200	6	28,7	0,626	21,8	3660	20,2	202	246	74,3	2290	9,06	151	172	49,7	1370
120-200-7	120	200	7	33,3	0,626	18,8	4240	23,2	232	283	73,8	2650	10,3	172	198	49,3	1590
120-200-8	120	200	8	37,9	0,626	16,5	4830	26,0	260	320	73,4	3020	11,6	193	198	48,9	1810
120-200-9	120	200	9	42,4	0,626	14,7	5400	28,8	288	355	72,9	3380	12,7	212	247	48,5	2030
150-200-5	150	200	5	26,4	0,686	26,0	3360	20,0	200	237	77,0	1920	12,8	171	194	61,7	1440
150-200-6	150	200	6	31,5	0,686	21,8	4010	23,6	236	281	76,6	2290	15,1	201	230	61,2	1720
150-200-7	150	200	7	36,6	0,686	18,7	4660	27,1	271	324	76,2	2660	17,3	230	265	60,8	2000
150-200-8	150	200	8	41,6	0,686	16,5	5300	30,4	304	366	76,2	3030	19,4	258	299	60,4	2270
150-200-9	150	200	9	46,6	0,686	14,7	5940	33,7	337	407	75,3	3390	21,4	249	332	59,9	2550
100-250-5	100	250	5	26,4	0,686	26,0	3360	26,5	212	267	88,8	2400	6,25	125	139	43,1	961
100-250-6	100	250	6	31,5	0,686	21,8	4010	31,3	251	316	88,3	2860	7,31	146	164	42,6	1150
100-250-7	100	250	7	36,6	0,686	18,7	4660	36,0	288	365	87,8	3330	8,32	166	189	42,2	1330
100-250-8	100	250	8	41,6	0,686	16,5	5300	40,5	324	413	87,4	3780	9,27	186	212	41,8	1520
100-250-9	100	250	9	46,6	0,686	14,7	5940	44,9	359	459	86,9	4240	10,2	203	235	41,3	1700
150-250-5	150	250	5	30,0	0,780	26,0	3870	32,8	263	319	92,7	2420	15,0	200	225	62,6	1450
150-250-6	150	250	6	35,7	0,780	21,8	4550	38,6	309	376	92,1	2840	17,6	234	265	62,1	1710
150-250-8	150	250	8	46,7	0,780	16,5	5950	49,2	394	485	91,0	3720	22,3	298	342	61,2	2230
150-250-10	150	250	10	57,2	0,780	13,3	7290	58,8	470	586	89,8	4560	26,5	354	412	60,3	2730
150-250-12	150	250	12	67,4	0,780	11,1	8580	67,4	539	680	88,6	5360	30,3	404	477	59,4	3220
100-300-5	100	300	5	30,0	0,780	26,0	3370	40,4	269	347	103	2900	7,20	144	159	43,4	968
100-300-6	100	300	6	35,7	0,780	21,8	4550	47,4	316	407	102	3410	8,37	168	187	42,9	1140
100-300-8	100	300	8	46,7	0,780	16,5	5950	60,3	402	527	100	4460	10,5	210	239	42,0	1490
100-300-10	100	300	10	57,2	0,780	13,3	7290	71,8	479	636	99,2	5470	12,3	247	287	41,1	1820
200-300-6	200	300	6	45,1	0,979	21,7	5750	73,3	489	585	113	3450	39,4	394	444	82,8	2300
200-300-8	200	300	8	59,2	0,979	16,4	7550	94,4	629	760	112	4530	50,6	506	577	81,9	3020
200-300-10	200	300	10	72,9	0,979	13,2	9290	114	759	926	111	5570	60,9	609	702	81,0	3720
200-300-12	200	300	12	86,2	0,979	11,1	11000	132	879	1080	110	7200	70,3	703	819	80,0	4800
200-400-8	200	400	8	71,8	1,17	16,3	9150	191	953	1180	144	6100	65,4	654	730	84,6	3050
200-400-10	200	400	10	88,6	1,17	13,1	11300	231	1160	1440	143	7530	79,0	790	892	83,6	3770
200-400-12	200	400	12	105	1,17	11,0	13400	270	1350	1690	142	8930	91,6	920	1040	82,7	4470
200-400-14	200	400	14	121	1,17	9,46	15400	305	1530	1930	141	10300	103	1030	1190	81,8	5130
300-400-8	300	400	8	84,4	1,37	16,2	10700	252	1260	1490	153	6110	163	1080	1230	123	4580
300-400-10	300	400	10	104	1,37	13,0	13300	307	1540	1830	152	7600	198	1320	1510	122	5700
300-400-12	300	400	12	124	1,37	10,9	15800	360	1800	2160	151	9030	231	1540	1770	121	6770
300-400-14	300	400	14	143	1,37	9,4	18200	409	2050	2470	150	10400	263	1750	2030	120	7800
300-500-8	300	500	8	96,9	1,57	16,2	12300	429	1720	2070	187	7690	197	1310	1460	126	4610
300-500-10	300	500	10	120	1,57	13,0	15300	525	2100	2540	185	9560	240	1600	1800	125	5740
300-500-12	300	500	12	143	1,57	10,9	18200	617	2470	3010	184	11400	281	1870	2120	124	6830
300-500-14	300	500	14	165	1,57	9,37	21000	704	2820	3450	183	13100	320	2130	2430	123	7870

RESISTANCES OF HOT ROLLED CROSS SECTIONS

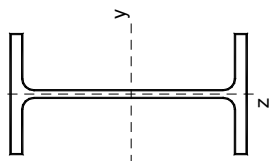

RESISTANCES

IPE cross-section

S 275 STEEL

$N_{pl,Rd}$ Design plastic resistance for axial forces; $N_{pl,Rd} = A \cdot f_{yd}$
 $V_{pl,y,Rd}$ Design plastic resistance for shear forces orthogonal to y axis;
 $V_{pl,y,Rd} = A_{v,y} \cdot f_{yd} / \sqrt{3}$
 $V_{pl,z,Rd}$ Design plastic resistance for shear forces orthogonal to z axis;
 $V_{pl,z,Rd} = A_{v,z} \cdot f_{yd} / \sqrt{3}$
 $M_{pl,y,Rd}$ Design plastic resistance for bending moments about y axis;
 $M_{pl,y,Rd} = W_{pl,y} \cdot f_{yd}$
 $M_{pl,z,Rd}$ Design plastic resistance for bending moments about z axis;
 $M_{pl,z,Rd} = W_{pl,z} \cdot f_{yd}$
 $f_{yd} = 275 / 1,05 \text{ N/mm}^2$

CROSS-SECTION	axial		Bending moment about y		Bending moment about z		
	$N_{pl,Rd}$ N	$V_{pl,y,Rd}$ N	$M_{el,y,Rd}$ N·mm	$M_{pl,y,Rd}$ N·mm	$V_{pl,z,Rd}$ N	$M_{el,z,Rd}$ N·mm	$M_{pl,z,Rd}$ N·mm
IPE 80	200 095	53 982	5 238 095	6 076 190	72 278	966 428	1 519 047
IPE 100	269 761	76 512	8 957 142	10 319 047	94 809	1 516 428	2 383 333
IPE 120	345 714	95 262	13 880 952	15 923 809	121 875	2 265 476	3 535 714
IPE 140	429 523	115 222	20 245 238	23 152 380	152 722	3 221 428	5 028 571
IPE 160	526 428	146 220	28 547 619	32 476 190	182 965	4 373 809	6 835 714
IPE 180	625 952	169 356	38 238 095	43 476 190	220 767	5 814 285	9 061 904
IPE 200	746 428	211 695	50 809 523	57 619 047	257 058	7 464 285	11 680 952
IPE 220	874 761	240 425	66 000 000	74 904 761	305 445	9 769 047	15 216 666
IPE 240	1 024 047	288 812	84 857 142	95 857 142	355 345	12 388 095	19 354 761
IPE 270	1 202 142	334 175	112 357 142	126 761 904	415 829	16 290 476	25 378 571
IPE 300	1 409 047	388 611	145 880 952	164 476 190	485 386	21 083 333	32 790 476
IPE 330	1 639 523	465 729	186 738 095	210 571 428	556 455	25 797 619	40 228 571
IPE 360	1 904 047	530 749	236 761 904	267 142 857	653 230	32 214 285	50 050 000
IPE 400	2 213 095	645 670	303 809 523	343 095 238	734 884	38 238 095	59 976 190
IPE 450	2 587 619	768 150	392 857 142	445 238 095	839 219	46 095 238	72 364 285
IPE 500	3 038 095	913 313	505 476 190	576 190 476	967 749	56 047 619	87 947 619
IPE 550	3 509 523	1 087 205	639 047 619	728 095 238	1 092 346	66 523 809	104 892 857
IPE 600	4 085 714	1 267 146	804 047 619	921 904 761	1 264 122	80 666 666	127 180 952

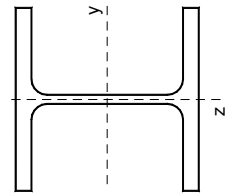

RESISTANCES

HEB cross-section

S 275 STEEL

- $N_{pl,Rd}$ Design plastic resistance for axial forces; $N_{pl,Rd} = A \cdot f_{yd}$
- $V_{pl,y,Rd}$ Design plastic resistance for shear forces orthogonal to y axis;
- $V_{pl,y,Rd} = A_{v,y} \cdot f_{yd} / \sqrt{3}$
- $V_{pl,z,Rd}$ Design plastic resistance for shear forces orthogonal to z axis;
- $V_{pl,z,Rd} = A_{v,z} \cdot f_{yd} / \sqrt{3}$
- $M_{pl,y,Rd}$ Design plastic resistance for bending moments about y axis;
- $M_{pl,y,Rd} = W_{pl,y} \cdot f_{yd}$
- $M_{pl,z,Rd}$ Design plastic resistance for bending moments about z axis;
- $M_{pl,z,Rd} = W_{pl,z} \cdot f_{yd}$
- $f_{yd} = 275 / 1,05 \text{ N/mm}^2$

CROSS-SECTION	axial		Bending moment about y		Bending moment about z	
	$N_{pl,Rd}$ N	$V_{pl,y,Rd}$ N	$M_{el,y,Rd}$ N·mm	$N_{pl,Rd}$ N	$V_{pl,y,Rd}$ N	$M_{el,y,Rd}$ N·mm
HEB 100	680 952	136 089	23 571 428	27 238 095	8 642 857	13 357 142
HEB 120	890 476	166 331	37 714 285	43 214 285	13 880 952	21 214 285
HEB 140	1 126 190	198 086	56 571 428	64 428 571	20 690 476	31 428 571
HEB 160	1 422 142	266 130	81 452 380	92 714 285	29 071 428	44 523 809
HEB 180	1 710 238	306 957	111 571 428	126 238 095	39 547 619	60 500 000
HEB 200	2 045 476	376 514	149 285 714	168 142 857	52 380 952	80 142 857
HEB 220	2 383 333	421 878	192 761 904	216 857 142	67 571 428	103 190 476
HEB 240	2 776 190	502 019	245 666 666	275 000 000	85 642 857	130 690 476
HEB 260	3 090 476	562 504	301 190 476	335 238 095	103 452 380	157 928 571
HEB 280	3 430 952	615 427	361 428 571	400 714 285	123 357 142	188 047 619
HEB 300	3 902 380	716 739	440 000 000	489 761 904	149 547 619	228 119 047
HEB 320	4 216 666	777 223	505 476 190	560 476 190	161 333 333	246 190 476
HEB 340	4 478 571	849 804	565 714 285	628 571 428	169 190 476	258 238 095
HEB 360	4 740 476	922 385	628 571 428	701 904 761	177 047 619	269 761 904
HEB 400	5 185 714	1 061 499	754 285 714	848 571 428	188 833 333	288 095 238
HEB 450	5 709 523	1 205 149	929 761 904	1 042 380 952	204 547 619	314 285 714
HEB 500	6 259 523	1 363 921	1 123 571 428	1 262 380 952	220 523 809	337 857 142
HEB 550	6 652 380	1 512 107	1 301 666 666	1 466 666 666	228 380 952	350 952 380
HEB 600	7 071 428	1 678 439	1 492 857 142	1 681 428 571	236 238 095	364 047 619

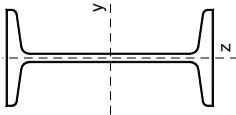

RESISTANCES

IPN cross-section

S 275 STEEL

$N_{pl,Rd}$ Design plastic resistance for axial forces; $N_{pl,Rd} = A \cdot f_{yd}$
 $V_{pl,y,Rd}$ Design plastic resistance for shear forces orthogonal to y axis;
 $V_{pl,y,Rd} = A_{v,y} \cdot f_{yd} / \sqrt{3}$
 $V_{pl,z,Rd}$ Design plastic resistance for shear forces orthogonal to z axis;
 $V_{pl,z,Rd} = A_{v,z} \cdot f_{yd} / \sqrt{3}$
 $M_{pl,y,Rd}$ Design plastic resistance for bending moments about y axis;
 $M_{pl,y,Rd} = W_{pl,y} \cdot f_{yd}$
 $M_{pl,z,Rd}$ Design plastic resistance for bending moments about z axis;
 $M_{pl,z,Rd} = W_{pl,z} \cdot f_{yd}$
 $f_{yd} = 275 / 1,05 \text{ N/mm}^2$

CROSS-SECTION	axial		Bending moment about y			Bending moment about z		
	$N_{pl,Rd}$ N	$V_{pl,y,Rd}$ N	$M_{el,y,Rd}$ N·mm	$M_{pl,y,Rd}$ N·mm	$V_{pl,z,Rd}$ N	$M_{el,z,Rd}$ N·mm	$M_{pl,z,Rd}$ N·mm	
IPN 80	198 261	49 899	5 107 142	5 971 428	75 000	785 714	1 309 523	
IPN 100	277 619	71 371	8 957 142	10 423 809	102 823	1 283 333	2 121 428	
IPN 120	371 904	97 530	14 326 190	16 657 142	135 031	1 938 095	3 247 619	
IPN 140	476 666	125 807	21 450 000	24 985 714	172 380	2 802 381	4 688 095	
IPN 160	597 142	158 771	30 642 857	35 619 047	213 207	3 876 190	6 495 238	
IPN 180	730 714	196 574	42 166 666	48 976 190	258 570	5 185 714	8 721 428	
IPN 200	874 761	235 888	56 047 619	65 476 190	306 957	6 809 524	11 419 047	
IPN 220	1 034 523	281 252	72 809 523	84 857 142	361 393	8 669 048	14 588 095	
IPN 240	1 207 380	328 127	92 714 285	107 904 761	420 365	10 921 429	18 333 333	
IPN 260	1 395 952	384 075	115 761 904	134 619 047	482 362	13 357 143	22 497 619	
IPN 280	1 597 619	444 559	141 952 380	165 523 809	547 383	16 028 571	26 976 190	
IPN 300	1 807 142	509 580	171 023 809	199 571 428	612 403	18 909 524	31 952 380	
IPN 320	2 035 000	579 137	204 809 523	239 380 952	684 984	22 183 333	37 452 380	
IPN 340	2 270 714	654 742	241 738 095	282 857 142	757 566	25 771 429	43 476 190	
IPN 360	2 540 476	821 074	285 476 190	335 238 095	843 756	29 857 143	50 809 523	
IPN 380	2 802 380	914 825	330 000 000	387 619 047	923 897	34 309 524	58 142 857	
IPN 400	3 090 476	913 313	382 380 952	447 857 142	1 013 112	39 023 810	66 523 809	
IPN 450	3 850 000	1 152 226	534 285 714	628 571 428	1 249 001	53 166 667	90 357 142	
IPN 500	4 688 095	1 416 845	720 238 095	848 571 428	1 510 595	70 190 476	119 428 571	
IPN 550	5 552 380	1 648 197	945 476 190	1 110 476 190	1 814 529	91 404 762	146 666 666	
IPN 600	6 652 380	2 056 466	1 212 619 047	1 466 666 666	2 101 829	113 666 667	175 476 190	

WORKED EXAMPLES

1.1. MECHANICAL PROPERTIES OF A BUILT-UP [] CROSS-SECTION	43
1.2. MECHANICAL PROPERTIES OF A BUILT-UP T CROSS-SECTION	45
1.3. MECHANICAL PROPERTIES OF A BUILT-UP I CROSS-SECTION AND CLASSIFICATION	51
1.4. CLASSIFICATION OF HOT ROLLED CROSS-SECTIONS	55

1.1. MECHANICAL PROPERTIES OF A BUILT-UP CROSS-SECTION []

Given the geometrical properties of the UPN 200 cross-section, it is requested to determine the following mechanical properties of the built-up cross section shown in the Figure:

- a) Second moments of area about y and z axes (I_y and I_z)
- b) Radii of gyration about y and z axis (i_y and i_z)
- b) Elastic section moduli about y and z axes ($W_{el,y}$ y $W_{el,z}$)
- c) Plastic section moduli about y and z axes ($W_{pl,y}$ y $W_{pl,z}$)

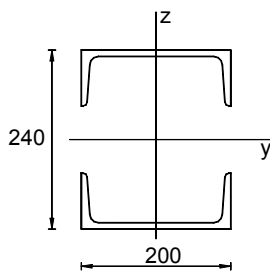

UPN 200

$$A = 3.220 \text{ mm}^2$$

$$I_y = 19,1 \cdot 10^6 \text{ mm}^4$$

$$I_z = 1,48 \cdot 10^6 \text{ mm}^4$$

$$y_s = 20,1 \text{ mm}$$

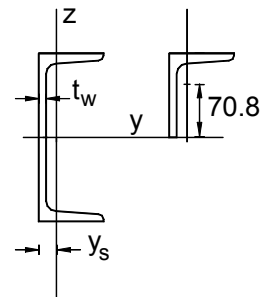

- a) Second moments of area (or moments of inertia)

Considering the parallel axis theorem also named Steiner's theorem:

$$I_y = 2 \cdot (1,48 \cdot 10^6 + 3.220 \cdot 99,9^2) = 67.231.264,4 \text{ mm}^4 \approx 67,23 \cdot 10^6 \text{ mm}^4$$

$$I_z = 2 \cdot 19,1 \cdot 10^6 = 38.200.000 \text{ mm}^4 \approx 38,2 \cdot 10^6 \text{ mm}^4$$

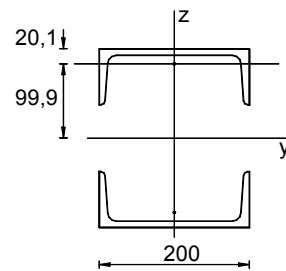

- b) Radii of gyration

$$i_y = \sqrt{\frac{I_y}{A}} = \sqrt{\frac{67,23 \cdot 10^6}{3.220 \cdot 2}} = 102,17 \text{ mm}$$

$$i_z = \sqrt{\frac{I_z}{A}} = \sqrt{\frac{38,2 \cdot 10^6}{3.220 \cdot 2}} = 77,01 \text{ mm}$$

c) Elastic section moduli

$$W_{el,y} = \frac{I_y}{z_{max}} = \frac{67,23 \cdot 10^6}{120} = 560.250 \text{ mm}^3 \approx 560 \cdot 10^3 \text{ mm}^3$$

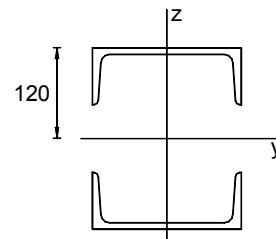

$$W_{el,z} = \frac{I_z}{y_{max}} = \frac{38,2 \cdot 10^6}{100} = 382.000 \text{ mm}^3 \approx 382 \cdot 10^3 \text{ mm}^3$$

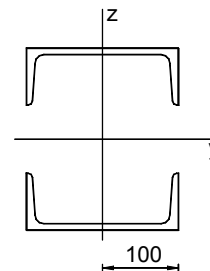

d) Plastic section moduli

Plastic section modulus about y axis is two times the first moment of area of one half of the section about that axis (S_y)

The same procedure can be applied for the plastic section modulus about z axis.

Axis y

$$W_{pl,y} = 2 \cdot S_y$$

$$S_y = 3.220 \cdot 99,9 = 321.678 \text{ mm}^3$$

$$W_{pl,y} = 2 \cdot 321.678 = 643356 \text{ mm}^3 \approx 643 \cdot 10^3 \text{ mm}^3$$

Axis z

$$W_{pl,z} = 2 \cdot S_z$$

$$S_z = 2 \cdot \frac{3.220}{2} \cdot 70,8 = 227.976 \text{ mm}^3$$

$$W_{pl,y} = 2 \cdot 227.976 = 455952 \text{ mm}^3 \approx 455 \cdot 10^3 \text{ mm}^3$$

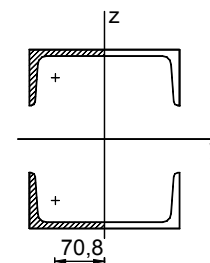
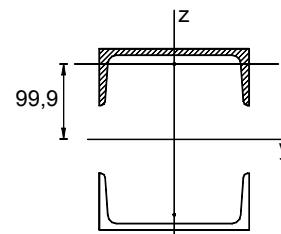

1.2. BUILT-UP CROSS-SECTION MECHANICAL PROPERTIES T

Given the **IPN 300** and the **UPN 180** cross-section geometrical properties,

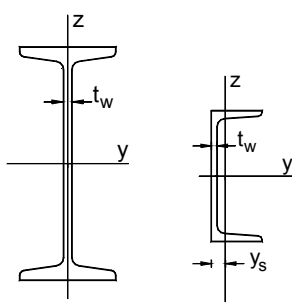

IPN 300
 $A = 6.900 \text{ mm}^2$
 $I_y = 98 \cdot 10^6 \text{ mm}^4$
 $I_z = 4,51 \cdot 10^6 \text{ mm}^4$
 $W_{pl,z} = 122 \cdot 10^3 \text{ mm}^3$
 $t_w = 10,8 \text{ mm}$

UPN 180
 $A = 2.800 \text{ mm}^2$
 $I_y = 13,5 \cdot 10^6 \text{ mm}^4$
 $I_z = 1,14 \cdot 10^6 \text{ mm}^4$
 $W_{pl,y} = 179 \cdot 10^3 \text{ mm}^3$
 $y_s = 19,2 \text{ mm}$
 $t_w = 8 \text{ mm}$

Determine, for the built-up cross section in the Figure, the following mechanical properties of the built-up cross-section shown in the Figure:

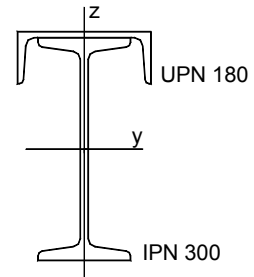

- a) Position of the centre of mass
- b) Second moments of area about y and z axes (I_y and I_z)
- c) Radii of gyration about y and z axis (i_y and i_z)
- d) Elastic moduli of the cross-section about y and z axis $W_{el,y}$ y $W_{el,z}$
- e) Plastic moduli of the cross-section about y and z $W_{pl,y}$ y $W_{pl,z}$

a) Position of the centre of gravity

The sum of the first moment of area of both sections must be equal to the moment of area of the built-up section.
 For the sake of simplicity, it is advisable to refer this equilibrium condition to the top edge of the built-up cross-section.

Considering the distances to the centre of gravity of each cross-section (158 mm for the IPN and 19.2 mm for the UPN) the above mentioned equilibrium condition is:

$$\underbrace{(150+8)}_{\text{IPN}} \cdot 6.900 + \underbrace{19,2}_{\text{UPN}} \cdot 2.800 = (6.900 + 2.800) \cdot z_g$$

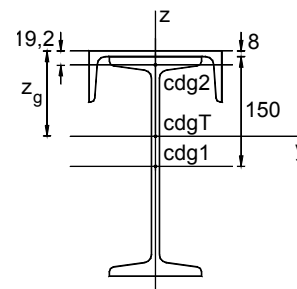

Para seguir leyendo haga click aquí